GOLDILOCKS 3.2 User Manual (en)

SUNJESOFT Inc.

Copyright [2019-2024] SUNJESoft Inc. Licensed under the Apache License, Version 2.0 (the "License");
you may not use this file except in compliance with the License.

You may obtain a copy of the License at <http://www.apache.org/licenses/LICENSE-2.0>

Unless required by applicable law or agreed to in writing,

software distributed under the License is distributed on an "AS IS" BASIS, WITHOUT WARRANTIES OR CONDITIONS OF ANY KIND,
either express or implied. See the License for the specific language governing permissions and limitations under the License.

Table of Contents

Table of Contents	iii
Part I. Getting Started	1
1. Preface	5
1.1 Overview	6
1.2 Summary	7
1.3 Characteristics of GOLDDILOCKS Cluster	10
2. Tutorial	15
2.1 Managing GOLDDILOCKS Instance	16
2.2 Installing GOLDDILOCKS and Creating Database	22
2.3 Managing Database Memory Structure	40
2.4 Managing Schema Object	48
2.5 Managing User	51
2.6 GOLDDILOCKS Property	55
2.7 GOLDDILOCKS Utility	57
3. Cluster Tutorial	61
3.1 Managing GOLDDILOCKS Cluster System	62
3.2 Installing GOLDDILOCKS and Creating Database	70
3.3 Managing Schema Object	74
3.4 GOLDDILOCKS Property	85
4. What's New	89
4.1 Feature Matrix	90
4.2 What's New in GOLDDILOCKS 3.2	151
4.3 Patch Notes	160
Part II. Administration Manual	195
5. Basic Management of GOLDDILOCKS Database	217

5.1	Creating and Configuring GOLDILOCKS Database	218
5.2	Starting up and Shutting down GOLDILOCKS Instance	221
5.3	Managing Process	229
5.4	Managing Memory	235
5.5	Monitoring	237
6.	Structure and Storage Structure of GOLDILOCKS Database	251
6.1	Managing Control File	252
6.2	Managing Redo Log File	256
6.3	Managing Archive Redo Log File	260
6.4	Managing Tablespace	262
6.5	Managing Data File	268
7.	Backup and Recovery of GOLDILOCKS Database	271
7.1	ARCHIVELOG Mode	272
7.2	Backup and Recovery	274
8.	GOLDILOCKS Database Replication	293
8.1	Overview	294
8.2	Operating Method	295
8.3	Trace Log	302
9.	Database Information	305
9.1	DICTIONARY_SCHEMA	306
9.2	INFORMATION_SCHEMA	502
9.3	PERFORMANCE_VIEW_SCHEMA	539
10.	Server Property	601
10.1	Server Property Information	602
10.2	AGING_INTERVAL	603
10.3	AGING_PLAN_INTERVAL	604
10.4	ARCHIVELOG_DIR_1 ~ ARCHIVELOG_DIR_10	605
10.5	ARCHIVELOG_FILE	606
10.6	ARCHIVELOG_MODE	607
10.7	BACKUP_DIR_1 ~ BACKUP_DIR_10	608
10.8	BLOCK_READ_COUNT	609
10.9	BULK_IO_PAGE_COUNT	610
10.10	CDISPATCHER_HOT_POLICY_INTERVAL	611
10.11	CDISPATCHER_SOCKET_BUFFER_SIZE	612
10.12	CDISPATCHER_SYNC_THREADS	613
10.13	CDISPATCHER_THREADS	614
10.14	CHARACTER_SET	615
10.15	CHAR_LENGTH_UNITS	616

10.16	CHECK_DEDICATE_CONNECTION_INTERVAL	618
10.17	CLIENT_MAX_COUNT	619
10.18	CLIENT_NUMA_POLICY	620
10.19	CLOSE_PSM_CHILD_STMTS	621
10.20	CLUSTER_ASYNC_COMMIT	622
10.21	CLUSTER_ASYNC_REPLICATION	623
10.22	CLUSTER_CM_BUFFER_COUNT	624
10.23	CLUSTER_CM_BUFFER_SIZE	625
10.24	CLUSTER_CM_READ_BUFFER_SIZE	626
10.25	CLUSTER_COMMIT_SLAVES	627
10.26	CLUSTER_COMMIT_STREAM_ISOLATION	628
10.27	CLUSTER_CONNECTION	629
10.28	CLUSTER_CONNECTION_TIMEOUT_SEC	630
10.29	CLUSTER_DATA_SYNC_SERVERS	631
10.30	CLUSTER_DISPATCHER_IN_QUEUE_SIZE	632
10.31	CLUSTER_DISPATCHER_NUMA_STREAM_MAP	633
10.32	CLUSTER_DISPATCHER_OUT_QUEUE_SIZE	634
10.33	CLUSTER_HEARTBEAT_INTERVAL	635
10.34	CLUSTER_HEARTBEAT_RETRY_COUNT	636
10.35	CLUSTER_IGNORE_INACTIVE_MEMBER	637
10.36	CLUSTER_MAX_PACKET_SIZE	638
10.37	CLUSTER_MAX_PAYLOAD_SIZE	639
10.38	CLUSTER_PACKET_ALLOCATION_TIMEOUT	640
10.39	CLUSTER_PROTOCOL_SESSION_FATAL_POLICY_TIMEOUT	641
10.40	CLUSTER_PROTOCOL_FAILOVER_POLICY_TIMEOUT	642
10.41	CLUSTER_SERVER_RESPONSE_QUEUE_SIZE	643
10.42	CLUSTER_SPLIT_BRAIN_RESOLUTION_POLICY	644
10.43	CLUSTER_SPLIT_BRAIN_RETRY_COUNT	645
10.44	COMMITTER_HOT_POLICY_INTERVAL	646
10.45	CONTROL_FILE_0 ~ CONTROL_FILE_7	647
10.46	CONTROL_FILE_COUNT	648
10.47	CONTROL_FILE_TEMP_NAME	649
10.48	COORDINATOR_COMMIT_WRITE_MODE	650
10.49	CSERVERS	651
10.50	DATABASE_ACCESS_MODE	652
10.51	DATABASE_INSTANCE_NAME	653
10.52	DATA_STORE_MODE	654
10.53	DA_CLIENT_NUMA_NODE	655
10.54	DDL_AUTOCOMMIT	656

10.55	DDL_LOCK_TIMEOUT	657
10.56	DEFAULT_GLOBAL_SECONDARY_INDEX_CREATION	658
10.57	DEFAULT_INDEX_LOGGING	659
10.58	DEFAULT_INDEX_PCTFREE	660
10.59	DEFAULT_INITRANS	661
10.60	DEFAULT_MAXTRANS	662
10.61	DEFAULT_PCTFREE	663
10.62	DEFAULT_PCTUSED	664
10.63	DEFAULT_REMOVAL_BACKUP_FILE	665
10.64	DEFAULT_REMOVAL_OBSOLETE_BACKUP_LIST	666
10.65	DEFAULT_SHARDING	667
10.66	DISABLE_DDL_CDC_GIVEUP	670
10.67	DISABLE_UPDATE_PK_CDC_GIVEUP	671
10.68	DISALLOWED_PROTOCOL_TARGETTYPE	672
10.69	DISALLOWED_PROTOCOL_TARGETTYPE_WITH_ALL	673
10.70	DISALLOWED_PROTOCOL_TARGETTYPE_WITH_NAME	674
10.71	DISPATCHER_CM_BUFFER_SIZE	675
10.72	DISPATCHER_CM_UNIT_SIZE	676
10.73	DISPATCHER_CONNECTIONS	677
10.74	DISPATCHER_HOT_POLICY_INTERVAL	678
10.75	DISPATCHER_LOAD_BALANCING	679
10.76	DISPATCHER_NUMA_STREAM_MAP	680
10.77	DISPATCHER_QUEUE_SIZE	681
10.78	DISPATCHER_REQUEST_MINI_QUEUE_COUNT	682
10.79	DISPATCHER_RESPONSE_MINI_QUEUE_COUNT	683
10.80	DISPATCHERS	684
10.81	FETCH_FAILOVER	685
10.82	GLOBAL_CONNECTION_ALLOW_SESSION_DEPENDENCY	686
10.83	GLOBAL_JOURNAL_BUFFER_SIZE	687
10.84	GLOBAL_JOURNAL_BUFFER_TOTAL_MAX_SIZE	688
10.85	GLOBAL_PROPERTY_LOCK_TIMEOUT	689
10.86	GLOBAL_TRANSACTION_COMMIT_WRITE_MODE	690
10.87	GLOBAL_TRANSACTION_ISOLATION_SCOPE	691
10.88	GLOBAL_TRANSACTION_LOG_DIR	692
10.89	GLOBAL_TRANSACTION_LOG_FILE_SIZE	693
10.90	GMASTER_NUMA_NODE	694
10.91	GMON_AUTOSTART	695
10.92	HINT_ERROR	696
10.93	IDLE_TIMEOUT	697

10.94	INDEX_BUILD_PARALLEL_FACTOR	698
10.95	INDEX_TREE_MERGE_PARALLEL_FACTOR	699
10.96	INST_ALLOCATOR_COUNT	700
10.97	INST_TABLE_BLOCK_SIZE	701
10.98	IN_DOUBT_DECISION	702
10.99	JOURNAL_TEMP_DIR	703
10.100	KEEPALIVE_IDLE_TIME	704
10.101	LOCAL_CLUSTER_MEMBER	705
10.102	LOCAL_CLUSTER_MEMBER_HOST	706
10.103	LOCAL_CLUSTER_MEMBER_PORT	707
10.104	LOCAL_JOURNAL_BUFFER_SIZE	708
10.105	LOCATION_FILE	709
10.106	LOCATOR_QUERY_TIMEOUT	710
10.107	LOCK_HASH_TABLE_SIZE	711
10.108	LOG_BLOCK_SIZE	712
10.109	LOG_BUFFER_SIZE	713
10.110	LOG_DIR	714
10.111	LOG_FILE_SIZE	715
10.112	LOG_GROUP_COUNT	716
10.113	LOG_MIRROR_MODE	717
10.114	LOG_MIRROR_SHARED_MEMORY_STATIC_SIZE	718
10.115	LOG_MIRROR_TIMEOUT	719
10.116	LOG_SYNC_INTERVAL	720
10.117	LOG_SYNC_INTERVAL_MSEC	721
10.118	MAX_GROUP_COUNT	722
10.119	MAX_JOURNAL_FILE_SIZE	723
10.120	MAX_NODE_COUNT	724
10.121	MAXIMUM_CONCURRENT_ACTIVITIES	725
10.122	MAXIMUM_FLANGE_COUNT	726
10.123	MAXIMUM_FLUSH_LOG_BLOCK_COUNT	727
10.124	MAXIMUM_FLUSH_PAGE_COUNT	728
10.125	MAXIMUM_JOURNAL_REPLAY_COUNT	729
10.126	MAXIMUM_NAMED_CURSOR_COUNT	730
10.127	MAXIMUM_SESSION_CM_BUFFER_SIZE	732
10.128	MEASURE_CLUSTER_LATENCY	733
10.129	MEMORY_MERGE_RUN_COUNT	734
10.130	MEMORY_SORT_RUN_SIZE	735
10.131	MINIMUM_UNDO_PAGE_COUNT	736
10.132	MIN_SAMPLE_ROW_COUNT	737

10.133	NET_BUFFER_SIZE	738
10.134	NLS_DATE_FORMAT	739
10.135	NLS_TIME_FORMAT	740
10.136	NLS_TIME_WITH_TIME_ZONE_FORMAT	741
10.137	NLS_TIMESTAMP_FORMAT	742
10.138	NLS_TIMESTAMP_WITH_TIME_ZONE_FORMAT	743
10.139	NUMA	744
10.140	NUMA_MAP	745
10.141	OFFLINE_MEMBER_AFTER_FAILOVER	746
10.142	ONLINE_JOURNAL_REPLAY_THRESHOLD	747
10.143	OS_GROUP_ACCESS	748
10.144	PACKET_COMPRESSION_THRESHOLD	749
10.145	PAGE_CHECKSUM_TYPE	750
10.146	PARALLEL_IO_FACTOR	751
10.147	PARALLEL_IO_GROUP_1 ~ PARALLEL_IO_GROUP_16	752
10.148	PARALLEL_LOAD_FACTOR	753
10.149	PENDING_LOG_BUFFER_COUNT	754
10.150	PLAN_CACHE	755
10.151	PLAN_CACHE_SIZE	756
10.152	PRIVATE_STATIC_AREA_SIZE	757
10.153	PROCESS_MAX_COUNT	758
10.154	QUERY_TIMEOUT	759
10.155	READABLE_ARCHIVELOG_DIR_COUNT	760
10.156	READABLE_BACKUP_DIR_COUNT	761
10.157	REBALANCE_BLOCK_READ_COUNT	762
10.158	RECOMPILE_CHECK_MINIMUM_PAGE_COUNT	763
10.159	RECOMPILE_PAGE_PERCENT	764
10.160	RECOVERY_LOG_BUFFER_SIZE	765
10.161	REDO_LOG_COMPRESSION_THRESHOLD	766
10.162	REFINE_RELATION	767
10.163	SESSION_FATAL_BEHAVIOR	768
10.164	SESSION_MEMORY_INIT_SIZE	769
10.165	SESSION_MEMORY_SHRINK_THRESHOLD	770
10.166	SHARED_MEMORY_ADDRESS	771
10.167	SHARED_MEMORY_STATIC_KEY	772
10.168	SHARED_MEMORY_STATIC_NAME	773
10.169	SHARED_MEMORY_STATIC_SIZE	774
10.170	SHARED_REQUEST_QUEUE_COUNT	775
10.171	SHARED_SERVERS	776

10.172	SHARED_SESSION	777
10.173	SNAPSHOT_STATEMENT_TIMEOUT	778
10.174	SQL_HISTORY_SIZE	779
10.175	SQL_HISTORY_TYPE	780
10.176	SUPPLEMENTAL_LOG_DATA_PRIMARY_KEY	781
10.177	SYSTEM_LOGGER_DIR	782
10.178	SYSTEM_MEMORY_AUX_TABLESPACE_SIZE	783
10.179	SYSTEM_MEMORY_DATA_TABLESPACE_SIZE	784
10.180	SYSTEM_MEMORY_DICT_TABLESPACE_SIZE	785
10.181	SYSTEM_MEMORY_TEMP_TABLESPACE_SIZE	786
10.182	SYSTEM_MEMORY_UNDO_TABLESPACE_SIZE	787
10.183	SYSTEM_TABLESPACE_DIR	788
10.184	SYSTEM_UDS_DIR	789
10.185	TCP_CLIENT_NUMA_NODE	790
10.186	TCP_NODELAY	791
10.187	TEMP_SEGMENT_CACHE_SIZE	792
10.188	TEMP_UNDO_ENABLED	793
10.189	TIMED_STATISTICS	794
10.190	TIMEZONE	795
10.191	TRACE_ALTER_SYSTEM	796
10.192	TRACE_DDL	797
10.193	TRACE_LOG_ID	798
10.194	TRACE_LOG_MSGBUF_SIZE	799
10.195	TRACE_LOG_TIME_DETAIL	800
10.196	TRACE_LOGGER	801
10.197	TRACE_LOGGER_REMOTE_HOST	802
10.198	TRACE_LOGGER_REMOTE_PORT	803
10.199	TRACE_LOGIN	804
10.200	TRACE_LONG_RUN_CURSOR	805
10.201	TRACE_LONG_RUN_SQL	807
10.202	TRACE_XA	808
10.203	TRANSACTION_ALLOCATION_TIMEOUT	809
10.204	TRANSACTION_COMMIT_WRITE_MODE	810
10.205	TRANSACTION_MAXIMUM_UNDO_PAGE_COUNT	811
10.206	TRANSACTION_TABLE_SIZE	812
10.207	TRANSACTION_TIMEOUT	814
10.208	UNDO_RELATION_ALLOCATION_TIMEOUT	815
10.209	UNDO_RELATION_COUNT	816
10.210	UNDO_SHRINK_THRESHOLD	818

10.211 USE_LARGE_PAGES 819

Part III. SQL Manual 821

11. SQL Elements 863

- 11.1 Syntax Elements 864
- 11.2 Data Type 885
- 11.3 Format String 911
- 11.4 Expressions 925
- 11.5 Pseudo Columns 932
- 11.6 Operators 937
- 11.7 Functions 940
- 11.8 Conditions 948
- 11.9 Built-in Data Type References 960
- 11.10 Built-in Function References 987

12. SQL Languages 1,199

- 12.1 Data Definition Language 1,200
- 12.2 Data Manipulation Language 1,210
- 12.3 Data Query Language 1,218
- 12.4 Control Language 1,232
- 12.5 Processing SQL in Cluster 1,237

13. SQL Objects 1,285

- 13.1 Database 1,286
- 13.2 Profile 1,293
- 13.3 Audit Policy 1,299
- 13.4 Authorization 1,327
- 13.5 Schema 1,338
- 13.6 Tablespace 1,349
- 13.7 Table 1,352
- 13.8 Index 1,358
- 13.9 View 1,362
- 13.10 Sequence 1,365
- 13.11 Synonym 1,369
- 13.12 Stored Procedure 1,372
- 13.13 Stored Function 1,374

14. Cluster Objects 1,377

- 14.1 Cluster System 1,378
- 14.2 Cluster Group 1,385
- 14.3 Cluster Member 1,387

14.4	Cluster Location	1,389
14.5	Cluster Table and Shard	1,390
14.6	Global Secondary Index	1,406
15.	SQL Tuning	1,409
15.1	Overview	1,410
15.2	SQL Processing	1,411
15.3	Query Optimizer	1,417
15.4	SQL Execution Plan	1,451
15.5	SQL Trace Log	1,490
16.	SQL References	1,497
16.1	ALTER AUDIT POLICY	1,498
16.2	ALTER CLUSTER GROUP name ADD MEMBER	1,501
16.3	ALTER CLUSTER GROUP name OFFLINE MEMBER	1,504
16.4	ALTER CLUSTER LOCATION	1,507
16.5	ALTER DATABASE ADD LOGFILE	1,509
16.6	ALTER DATABASE ARCHIVELOG	1,512
16.7	ALTER DATABASE BACKUP	1,514
16.8	ALTER DATABASE CLEAR AUDIT TRAIL	1,518
16.9	ALTER DATABASE CLEAR PASSWORD HISTORY	1,520
16.10	ALTER DATABASE DELETE BACKUP	1,522
16.11	ALTER DATABASE DROP INACTIVE CLUSTER MEMBERS	1,525
16.12	ALTER DATABASE DROP LOGFILE	1,527
16.13	ALTER DATABASE MOVE SHARD	1,530
16.14	ALTER DATABASE OFFLINE INACTIVE CLUSTER MEMBERS	1,533
16.15	ALTER DATABASE REBALANCE	1,535
16.16	ALTER DATABASE REBALANCE EXCLUDE CLUSTER GROUP	1,538
16.17	ALTER DATABASE RENAME LOGFILE	1,541
16.18	ALTER DATABASE RECOVER	1,543
16.19	ALTER DATABASE REGISTER	1,548
16.20	ALTER DATABASE RESET LOCAL CLUSTER MEMBER	1,550
16.21	ALTER DATABASE RESTORE	1,552
16.22	ALTER INDEX	1,555
16.23	ALTER INDEX name AGING	1,557
16.24	ALTER INDEX name STORAGE	1,559
16.25	ALTER INDEX name RENAME TO	1,563
16.26	ALTER PROFILE	1,565
16.27	ALTER SEQUENCE	1,569
16.28	ALTER SESSION CLEANUP GLOBAL TEMPORARY SEGMENT POOL;	1,575
16.29	ALTER SESSION SET property_name	1,577

16.30	ALTER SYSTEM CHECKPOINT	1,579
16.31	ALTER SYSTEM CLEANUP PLAN	1,581
16.32	ALTER SYSTEM IRRECOVERABLE CLUSTER MEMBER	1,583
16.33	ALTER SYSTEM JOIN DATABASE	1,585
16.34	ALTER SYSTEM {MOUNT OPEN} DATABASE	1,588
16.35	ALTER SYSTEM [KILL DISCONNECT] SESSION	1,591
16.36	ALTER SYSTEM RECONNECT GLOBAL CONNECTION	1,594
16.37	ALTER SYSTEM RESET property_name	1,596
16.38	ALTER SYSTEM SET property_name	1,599
16.39	ALTER SYSTEM SWITCH LOGFILE	1,603
16.40	ALTER TABLE	1,605
16.41	ALTER TABLE name ADD COLUMN	1,610
16.42	ALTER TABLE name SET UNUSED COLUMN	1,614
16.43	ALTER TABLE name ALTER COLUMN	1,617
16.44	ALTER TABLE name RENAME COLUMN	1,629
16.45	ALTER TABLE name ADD CONSTRAINT	1,631
16.46	ALTER TABLE name DROP CONSTRAINT	1,634
16.47	ALTER TABLE name ALTER CONSTRAINT	1,637
16.48	ALTER TABLE name RENAME CONSTRAINT	1,640
16.49	ALTER TABLE name ADD GLOBAL SECONDARY INDEX	1,643
16.50	ALTER TABLE name DROP GLOBAL SECONDARY INDEX	1,649
16.51	ALTER TABLE name ALTER GLOBAL SECONDARY INDEX	1,651
16.52	ALTER TABLE name MOVE SHARD	1,656
16.53	ALTER TABLE name REBALANCE	1,659
16.54	ALTER TABLE name REBALANCE EXCLUDE CLUSTER GROUP cluster_group_list	1,661
16.55	ALTER TABLE name SPLIT SHARD	1,664
16.56	ALTER TABLE name RENAME SHARD	1,668
16.57	ALTER TABLE name READ { ONLY WRITE }	1,671
16.58	ALTER TABLE name RENAME TO	1,674
16.59	ALTER TABLE name STORAGE	1,676
16.60	ALTER TABLE name ADD SUPPLEMENTAL LOG	1,679
16.61	ALTER TABLE name DROP SUPPLEMENTAL LOG	1,681
16.62	ALTER TABLESPACE	1,683
16.63	ALTER TABLESPACE name RENAME TO	1,686
16.64	ALTER TABLESPACE name BACKUP	1,688
16.65	ALTER TABLESPACE name [ONLINE OFFLINE]	1,691
16.66	ALTER TABLESPACE name ADD [DATAFILE MEMORY]	1,694
16.67	ALTER TABLESPACE name DROP [DATAFILE MEMORY]	1,697
16.68	ALTER TABLESPACE name RENAME DATAFILE	1,699

16.69	ALTER USER	1,701
16.70	ALTER VIEW	1,708
16.71	ANALYZE SYSTEM	1,711
16.72	ANALYZE TABLE	1,714
16.73	AUDIT POLICY	1,721
16.74	CLOSE cursor_name	1,727
16.75	COMMENT ON name IS	1,729
16.76	COMMIT	1,735
16.77	CREATE AUDIT POLICY	1,738
16.78	CREATE CLUSTER GROUP	1,745
16.79	CREATE CLUSTER LOCATION	1,748
16.80	CREATE INDEX	1,750
16.81	CREATE PROFILE	1,758
16.82	CREATE SCHEMA	1,769
16.83	CREATE SEQUENCE	1,774
16.84	CREATE SYNONYM	1,780
16.85	CREATE TABLE	1,784
16.86	CREATE TABLE AS SELECT	1,819
16.87	CREATE GLOBAL TEMPORARY TABLE	1,826
16.88	CREATE TABLESPACE	1,831
16.89	CREATE MEMORY DATA TABLESPACE	1,833
16.90	CREATE MEMORY TEMPORARY TABLESPACE	1,837
16.91	CREATE USER	1,841
16.92	CREATE VIEW	1,848
16.93	DECLARE cursor_name	1,853
16.94	DELETE FROM	1,866
16.95	DELETE FROM name RETURNING	1,870
16.96	DELETE FROM name RETURNING .. INTO	1,874
16.97	DELETE FROM name WHERE CURRENT OF cursor_name	1,878
16.98	DROP AUDIT POLICY	1,882
16.99	DROP CLUSTER GROUP	1,884
16.100	DROP CLUSTER LOCATION	1,886
16.101	DROP INDEX	1,888
16.102	DROP PROFILE	1,890
16.103	DROP SCHEMA	1,892
16.104	DROP SEQUENCE	1,895
16.105	DROP SYNONYM	1,898
16.106	DROP TABLE	1,901
16.107	DROP TABLESPACE	1,905

16.108	DROP USER	1,908
16.109	DROP VIEW	1,912
16.110	EXECUTE statement_name	1,914
16.111	EXECUTE IMMEDIATE 'sql_string'	1,919
16.112	FETCH cursor_name	1,922
16.113	GRANT privileges TO	1,928
16.114	INSERT INTO	1,940
16.115	INSERT INTO name RETURNING	1,945
16.116	INSERT INTO name RETURNING .. INTO	1,949
16.117	LOCK TABLE	1,953
16.118	NOAUDIT POLICY	1,957
16.119	OPEN cursor_name	1,963
16.120	PREPARE statement_name	1,967
16.121	RELEASE SAVEPOINT savepoint_specifier	1,972
16.122	REVOKE privileges FROM	1,974
16.123	ROLLBACK	1,978
16.124	SAVEPOINT savepoint_specifier	1,982
16.125	SELECT	1,985
16.126	SELECT .. FOR UPDATE	2,068
16.127	SELECT .. INTO	2,073
16.128	SELECT .. INTO .. FOR UPDATE	2,076
16.129	SET CONSTRAINTS	2,082
16.130	SET SESSION AUTHORIZATION user_identifier	2,091
16.131	SET SESSION CHARACTERISTICS AS transaction_mode	2,093
16.132	SET TIME ZONE	2,095
16.133	SET TRANSACTION transaction_mode	2,097
16.134	TRUNCATE TABLE	2,099
16.135	UPDATE	2,102
16.136	UPDATE name RETURNING	2,107
16.137	UPDATE name RETURNING .. INTO	2,111
16.138	UPDATE name WHERE CURRENT OF cursor_name	2,115

Part IV. PSM Manual **2,119**

17.	Overview of PSM	2,135
17.1	Features of PSM	2,136
17.2	Language Elements	2,138
17.3	Processing Transaction in PSM	2,139
18.	PSM DataTypes	2,141

18.1	Built-in Data Types	2,142
18.2	Attribute Data Types	2,145
18.3	User-defined Record Type	2,147
18.4	User-defined Collection Type	2,149
18.5	SYS_REFCURSOR	2,157
19.	PSM Control Statements	2,159
19.1	Assignment	2,160
19.2	PL Block	2,164
19.3	NULL Statement	2,167
19.4	Testing Conditions	2,168
19.5	Iterative Control	2,171
19.6	Sequential Control	2,174
19.7	Error Handling	2,180
20.	PSM Cursor Statements	2,195
20.1	Declaration	2,196
20.2	OPEN	2,200
20.3	FETCH	2,201
20.4	CLOSE	2,203
20.5	EXPLICIT CURSOR ATTRIBUTES	2,204
20.6	IMPLICIT_CURSOR_ATTRIBUTES	2,206
20.7	CURSOR VARIABLES	2,208
21.	Using PSM Subprograms	2,215
21.1	Anonymous PL Block	2,216
21.2	Nested Procedure	2,217
21.3	Nested Function	2,219
21.4	Schema-level Procedure	2,220
21.5	Schema-level Function	2,225
21.6	Built-in Procedures	2,228
22.	Using SQLs in PSM	2,231
22.1	Static SQLs	2,232
22.2	Dynamic SQL	2,249
23.	PSM Language Element References	2,255
23.1	Assignment Statement	2,256
23.2	Basic LOOP Statement	2,260
23.3	Block (BEGIN .. END)	2,262
23.4	CASE Statement	2,265
23.5	CLOSE Statement	2,268
23.6	Collection Method Invocation	2,270

23.7	COLLECTION Variable Declaration	2,274
23.8	CONTINUE Statement	2,278
23.9	Cursor FOR LOOP Statement	2,281
23.10	Cursor Variable Declaration	2,285
23.11	DELETE Statement Extension	2,287
23.12	EXCEPTION_INIT Pragma	2,290
23.13	Exception Declaration	2,292
23.14	Exception Handler	2,294
23.15	EXECUTE IMMEDIATE Statement	2,297
23.16	EXIT Statement	2,301
23.17	Explicit Cursor Attribute	2,303
23.18	Explicit Cursor Declaration and Definition	2,306
23.19	FETCH Statement	2,310
23.20	FOR LOOP Statement	2,313
23.21	Function Declaration and Definition	2,316
23.22	GOTO Statement	2,319
23.23	IF Statement	2,321
23.24	Implicit Cursor Attribute	2,323
23.25	INSERT Statement Extension	2,325
23.26	NULL Statement	2,328
23.27	OPEN Statement	2,330
23.28	OPEN FOR Statement	2,333
23.29	Procedure Call	2,336
23.30	Procedure Declaration and Definition	2,339
23.31	RAISE Statement	2,341
23.32	Record Variable Declaration	2,344
23.33	RETURN Statement	2,346
23.34	RETURNING INTO clause	2,348
23.35	%ROWTYPE Attribute	2,350
23.36	Scalar Variable Declaration	2,352
23.37	SELECT INTO Statement	2,355
23.38	SQLCODE Function	2,357
23.39	SQLERRM Function	2,359
23.40	%TYPE Attribute	2,361
23.41	UPDATE Statement Extension	2,363
23.42	WHILE LOOP Statement	2,366
24.	PSM SQL References	2,369
24.1	ALTER FUNCTION	2,370
24.2	ALTER PROCEDURE	2,372

24.3	CALL Statement	2,375
24.4	CREATE FUNCTION	2,378
24.5	CREATE PROCEDURE	2,383
24.6	DROP FUNCTION	2,388
24.7	DROP PROCEDURE	2,391

Part V. Developer Manual **2,395**

25.	ODBC	2,403
25.1	Overview of GOLDILOCKS ODBC Driver	2,404
25.2	Data Source Configuration	2,407
25.3	GLOBAL CONNECTION	2,416
25.4	Catalog Function	2,422
25.5	ODBC API References	2,427
25.6	XA API References	2,770
26.	JDBC	2,787
26.1	Overview of GOLDILOCKS JDBC Driver	2,788
26.2	Feature Specification	2,793
26.3	JDBC API References	2,816
27.	Embedded SQL	3,005
27.1	Precompiler	3,006
27.2	Embedded SQL	3,016
27.3	Advanced Topic	3,130
27.4	Embedded SQL Reference	3,170
28.	PDO	3,199
28.1	Overview of PDO	3,200
28.2	Installation /Configuration	3,200
28.3	Usage	3,202
28.4	Examples	3,203
29.	PyDBC	3,213
29.1	GOLDILOCKS PyDBC	3,214
29.2	API Reference	3,217
29.3	Exception	3,232
29.4	Data Type	3,233
30.	Ruby	3,237
30.1	Overview	3,238
30.2	Installation	3,238
30.3	Examples	3,239
30.4	Examples of ActiveRecord	3,242

31. Hibernate	3,247
31.1 Overview	3,248
31.2 Interworking with Hibernate	3,248
31.3 Examples	3,249
Part VI. Utility Manual	3,257
32. gcreatedb	3,265
32.1 Overview of gcreatedb	3,266
32.2 Command Option	3,268
33. glsnr	3,273
33.1 Overview of glsnr	3,274
33.2 Command Options	3,275
33.3 Listener Configuration	3,278
34. gsql/gsqlnet (Interactive SQL Tool)	3,283
34.1 Overview of gsql	3,284
34.2 Executing gsql	3,288
34.3 Using Interactive Command	3,294
34.4 Command Option Reference	3,332
34.5 Interactive Command References	3,340
35. gloder/gloadernet (Upload/download Tool)	3,419
35.1 Overview of gloder and gloadernet	3,420
35.2 Using gloder	3,424
35.3 Control File Syntax	3,447
35.4 gloder Argument References	3,454
36. gdump	3,469
36.1 Overview of gdump	3,470
36.2 Examples of Using gdump	3,473
37. tablediff	3,487
37.1 Overview of tablediff	3,488
37.2 Usage	3,490
38. gsyncher	3,497
38.1 Overview of gsyncher	3,498
38.2 Examples	3,499
39. gmon	3,503
39.1 Overview of gmon	3,504
39.2 Examples	3,505
40. gtrclogger	3,507

40.1	Overview of gtrclogger	3,508
40.2	Examples	3,510
41.	glocator	3,511
41.1	Overview of glocator	3,512
41.2	Using glocator	3,516
41.3	Features of glocator	3,519
41.4	glocator Configuration	3,521
42.	gagent	3,527
42.1	Overview of gagent	3,528
42.2	gagent Configuration	3,532
43.	gloctl	3,537
43.1	Overview of gloctl	3,538
43.2	Interactive Command References	3,542
43.3	Location File	3,548
43.4	Configuration	3,550
Part VII.	Replication	3,553
44.	Overview	3,557
44.1	Overview of GOLDILOCKS Replication	3,558
44.2	Characteristics	3,559
45.	CYCLONE	3,561
45.1	CYCLONE	3,562
45.2	Requirements	3,568
45.3	Configuration	3,573
45.4	Operating	3,591
45.5	Operating Examples	3,597
45.6	Operating CYCLONE in Cluster	3,603
45.7	Monitoring (CYMON)	3,608
46.	LOGMIRROR	3,613
46.1	LOGMIRROR	3,614
46.2	Requirements	3,616
46.3	Configuration	3,618
46.4	Operating	3,622
46.5	Examples of Interworking with CYCLONE	3,624
Appendix A.	Error Codes	3,631
A.1	OS Related Error	3,632
A.2	Datatype and Operation Related Error	3,636

A.3	Resource Management Related Error	3,642
A.4	Storage Management Related Error	3,644
A.5	Dictionary Cash Related Error	3,648
A.6	SQL Handling Related Error	3,649
A.7	PSM Related Error	3,663
A.8	Session Related Error	3,666
A.9	ODBC Related Error	3,667
A.10	JDBC Related Error	3,669
A.11	Embedded SQL Related Error	3,671
A.12	Communication Related Error	3,673
A.13	ServerLibrary Related Error	3,674
A.14	gsq/ gsqlnet Related Error	3,675
A.15	gloader/ gloadernet Related Error	3,677
A.16	gmaster Related Error	3,678
A.17	glsnr Related Error	3,679
A.18	cyclone Related Error	3,680
A.19	LogMirror Related Error	3,682
A.20	cymon Related Error	3,683
A.21	gdispatcher Related Error	3,684
A.22	gbalancer Related Error	3,685
A.23	gsyncher Related Error	3,686
A.24	Cluster Related Error	3,687
A.25	cserver Related Error	3,688
A.26	cdispatcher Related Error	3,689
A.27	gtrclogger Related Error	3,690
A.28	glocator Related Error	3,691
A.29	gloctl Related Error	3,692
A.30	gmon Related Error	3,693
A.31	gagent Related Error	3,694
Appendix B. Wait Event		3,695
B.1	Wait Event	3,696
B.2	Class of Wait Event	3,696
B.3	Item of Wait Event	3,697
Appendix C. Open Source License		3,715

Part I.

Getting Started

2 | Getting Started

1. Preface	5
1.1 Overview	6
Target Reader	6
1.2 Summary	7
GOLDILOCKS Database Management System	7
GOLDILOCKS Architecture	7
GOLDILOCKS Cluster System Architecture	9
1.3 Characteristics of GOLDILOCKS Cluster	10
Features of Cluster	10
Constraint of Cluster	11
2. Tutorial	15
2.1 Managing GOLDILOCKS Instance	16
Overview	16
Property Setting	16
Background Process	17
Client Process	18
Memory Architecture of Instance	19
Startup and Shutdown Instance	19
Start and End of Listener	21
2.2 Installing GOLDILOCKS and Creating Database	22
Overview	22
Release Platform	22
System Requirements	23
GOLDILOCKS Package Configuration	23
Installing GOLDILOCKS Software	29
Creating Database	35
Building Dictionary Schema Information	38
2.3 Managing Database Memory Structure	40
Database Memory Structure	40
Checking Information of Database Storage Structure	42
General Operation of Data Storage	43
Store Mode	46
2.4 Managing Schema Object	48
Schema Object	48
Schema Object Management Privileges	48
Managing Table	48
Managing Index	49
Sequence	50
2.5 Managing User	51

Creating User	51
Dropping User	52
Altering User	52
2.6 GOLDILOCKS Property	55
Properties When Creating Database	55
Properties When Driving Database	55
2.7 GOLDILOCKS Utility	57
gcreatedb	57
gsql (GOLDILOCKS Interactive SQL Tool)	58
gloader (GOLDILOCKS Data Upload/download Tool)	59
3. Cluster Tutorial	61
3.1 Managing GOLDILOCKS Cluster System	62
Overview	62
Property Setting	62
Background Process	63
Client Process	64
Memory Structure of Instance	64
Start and End of Cluster System	65
3.2 Installing GOLDILOCKS and Creating Database	70
Configuring GOLDILOCKS Package	70
Installing GOLDILOCKS Software	70
Creating Database	71
Building Dictionary Schema Information	72
3.3 Managing Schema Object	74
Managing Table	74
Managing Index	80
Global Sequence	81
3.4 GOLDILOCKS Property	85
4. What's New	89
4.1 Feature Matrix	90
Architecture	90
SQL	108
API	123
Utility	132
Replication	147
4.2 What's New in GOLDILOCKS 3.2	151
Architecture	151
SQL	153
API	155

4 | Getting Started

Utility	156
Replication	158
4.3 Patch Notes	160
3.2.14 Patch Note	160
3.2.13 Patch Note	160
3.2.12 Patch Note	160
3.2.11 Patch Note	161
3.2.10 Patch Note	166
3.2.9 Patch Note	175
3.2.8 Patch Note	175
3.2.7 Patch Note	176
3.2.6 Patch Note	177
3.2.5 Patch Note	179
3.2.4 Patch Note	183
3.2.3 Patch Note	186
3.2.2 Patch Note	187
3.2.1 Patch Note	193

1.

Preface

1.1 Overview

This user manual is intended for the user who is configuring, managing and operating GOLDILOCKS. The purpose of this manual is to convey the basic concepts required for installation and management of GOLDILOCKS. This manual also describes cautions when using GOLDILOCKS system.

- The description which is presented in this document can be changed according to the installation environment and specific usage.
- This document is based on GOLDILOCKS 3.2 version.
- This document is based on RedHat linux - based platform.

Target Reader

The target readers are as follows.

- Programmers who need basic knowledge about how to manage GOLDILOCKS database
- Administrators and performance managers of GOLDILOCKS database
- Administrators and performance managers of GOLDILOCKS cluster system

1.2 Summary

This chapter describes the basic structure and characteristics of GOLDILOCKS for the novice user. A user can select either a standalone or a cluster system architecture to use GOLDILOCKS. Differences of each architecture and their usages are described.

GOLDILOCKS Database Management System

GOLDILOCKS is an in-memory relational DBMS. GOLDILOCKS stores all user data in in-memory as a table form so that it performs search and update operations of all such data effectively.

GOLDILOCKS database system consists of the following parts.

- User-installed GOLDILOCKS software binaries
- Database which is a set of tablespaces, implemented with one or more shared memory on in-memory
- Various files for persistence support of database
 - The data files created with the same size as shared memory per shared memory
 - Redo log files which support the recovery of the database in the event of a failure
 - Configuration files for database settings
 - Trace log files which record information such as events during database operations
- gmater processes which manage in-memory database, and many system threads within it

GOLDILOCKS Architecture

To prevent spreading the application process failure over the entire database system, GOLDILOCKS database is a multi-process architecture based on shared memory, instead of a multi-thread architecture. The overall architecture of GOLDILOCKS database is as shown in figure 1. Data are loaded onto a shared memory and gmater process is a management daemon which manages database such as boot-up, log flush, aging. Also, it stores redo log files and data files on a disk file to ensure the permanence of data. Applications using GOLDILOCKS database will use one of the following two accessing models.

Figure 1 GOLDILOCKS architecture

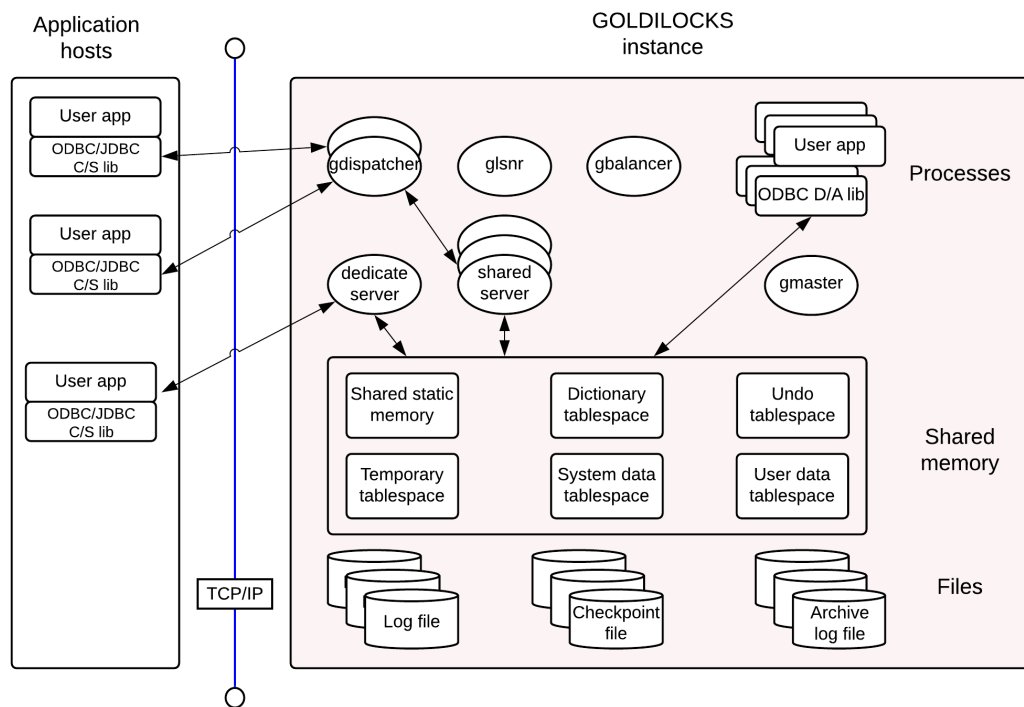

- Direct Access (D/A) model
 - A user may use D/A model when user application is operated on the same equipment as GOLDILOCKS database.
 - User applications should be used by linking with GOLDILOCKS ODBC/JDBC libraries for D/A.
 - GOLDILOCKS ODBC/JDBC libraries for D/A include query processing module and storage management module inside and they process user request by directly attaching shared memory configuring that database.
 - It is suitable to implement a few works which require low-latency because the communication load between application process and database process module is removed.
- Client/ Server (C/S) model
 - A user may use C/S model when user application is operated on the same equipment as GOLDILOCKS database or on a different equipment.
 - User applications should be used by linking with GOLDILOCKS ODBC/JDBC libraries for C/S.
 - The GOLDILOCKS development library for C/S processes user's requests through TCP communication with the server (gserver) which serves the database specified in the connect string.
 - The response speed of single application of C/S is inferior to that of D/A. However, C/S does not depend on the location of the application, and the relatively stable operation is possible even when an error occurs in the application.
 - C/S model may be operated in shared mode or dedicated mode. In dedicated mode, a single server (gserver) process is performed on a single client. In shared mode, it responds to multiple clients because dispatcher (gdispatcher) and shared-server (gserver) are always running.
 - Dedicated mode is suitable for large amount of data, and shared mode is suitable for many clients, small amount of data.
 - For more information about setting dedicated mode or shared mode, refer to **odbc.ini File** and **Lis**

tener Configuration.



In D/A model, an application directly accesses to database and manipulates it, and thus the data base instance becomes unstable because many errors occur at an early development stages. The refore, it would be efficient to develop it in C/S model at an early development stage, and then, to switch it to D/A model at the final development stage.

GOLDILOCKS Cluster System Architecture

GOLDILOCKS can be used by configuring a standalone database, or binding multiple databases into a single cluster and managing the database in cluster unit. In other words, a user can distribute and store table data into multiple nodes according to the desired sharding strategy. This guarantees high availability and improves the throughput due to the parallel processing.

GOLDILOCKS cluster system guarantees ACID of transaction which is cluster-widely performed. Therefore, it provides the data reliability as same as that of the transaction performed on a standalone server when any node belonging to the cluster system is connected to perform the transaction.

Each database belonging to GOLDILOCKS cluster system has a structure for multi-process structure and data loading method, which is as same as the structure of the standalone database. However, cdispatcher process and cluster server (cserver) process are added. cdispatcher is a process for efficient communication between member nodes in a cluster, and cluster server (cserver) process is for the data storage and management on the cluster member node. Also, tablespaces and management areas for transaction management of cluster system are added to the shared memory.

Figure 2 GOLDILOCKS cluster system architecture

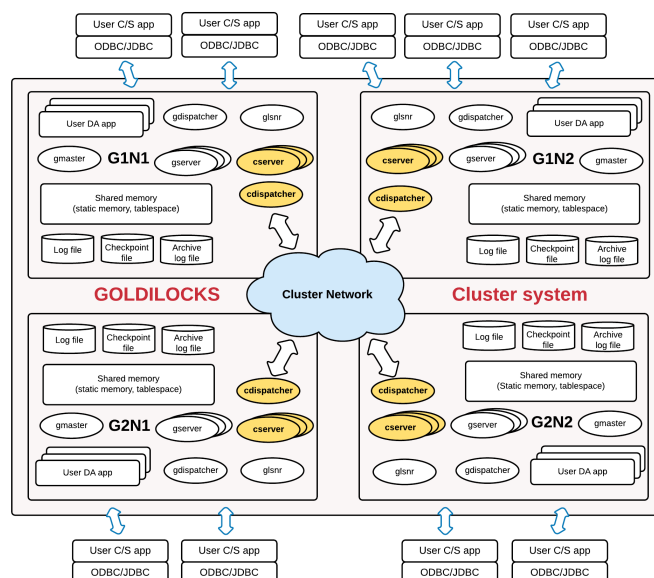

1.3 Characteristics of GOLDILOCKS Cluster

Features of Cluster

GOLDILOCKS cluster is a cluster system of shared nothing structure and it overcomes limitations for transaction performance and storage of an existing standalone system.

- High throughput
 - GOLDILOCKS cluster does not limit creating groups, and the linear performance can be improved by creating groups.
 - It overcomes the limitation for the storage space of the existing memory-based standalone system.
- High availability
 - If a group consists of multiple members and at least one member is running in a group, it does not affect the availability.
 - Even when not every member in a group is available, other groups except for that group normally provides service.
- Online expansion and online recovery
 - creating groups or members are possible even when the service is in progress, and it does not affect the service in progress.
 - Even the member of the suspended service due to an error can participate in a cluster online.
- Providing the perfect transaction
 - It perfectly provides the following properties of which a transaction should comply with.
 - Atomicity
 - Consistency
 - Isolation
 - Durability
- Providing the perfect MVCC (multi-version concurrency control)
 - GOLDILOCKS cluster provides a global statement level consistency as standalone system does.
 - The SQL starting at a specific point can access a desired version among the various versions when accessing to any node.
- Providing the standard SQL and the standard DBC
 - It provides SQL which is equivalent to SQL 92.
 - It provides standard DBCs such as JDBC, ODBC.
- Application compatibility
 - The application source or SQL developed in the existing standalone system can be used in GOLDILOCKS cluster without modifying it.

Constraint of Cluster

All SQL statements in GOLDDILOCKS cluster can be used same as those in standalone system except for the following constraints.



PRIMARY KEY for the sharded table, UNIQUE constraint and the UNIQUE INDEX should include a sharding key.

The following is an example of a failure because the constraint of UNIQUE (name) does not include an id column which is a sharding key.

```
gSQL>
CREATE TABLE t1
(
  id    INTEGER PRIMARY KEY,
  name  VARCHAR(128),
  UNIQUE (name)
)
SHARDING BY HASH(id);
ERR-HYC00(16380): UNIQUE or PRIMARY KEY must include all sharding key columns for cluster
system
```

The constraint should be generated including sharding key like as UNIQUE (id, name) or UNIQUE (name, id) in the following example.

```
gSQL>
CREATE TABLE t1
(
  id    INTEGER PRIMARY KEY,
  name  VARCHAR(128),
  UNIQUE( id, name )
)
SHARDING BY HASH (id);
Table created.
```



Non-deterministic statements should have the global secondary index to distinguish the same rows among the cluster members.

The following is an example of error which occurs when creating a table omitting the global secondary in

dex by force.

```
gSQL> CREATE TABLE t1 ( c1 INTEGER ) WITHOUT GLOBAL SECONDARY INDEX;
Table created.
gSQL> INSERT INTO t1 VALUES (1), (2), (3), (4), (5);
5 rows created.
gSQL> COMMIT;
Commit complete.
```

The following is an example of deleting three rows and it does not guarantee that the cluster members delete the same rows.

```
gSQL> DELETE FROM t1 FETCH 3;
ERR-42000(16423): does not support non-deterministic DML in the cluster system : global
secondary index expected
```

The following example does not guarantee that the cluster members update the same rows to the same value by using RANDOM(1, 100).

```
gSQL> UPDATE t1 SET c1 = RANDOM(1, 100);
ERR-42000(16423): does not support non-deterministic DML in the cluster system : global
secondary index expected
```

The following is an example of updating the row at the current position by using updatable cursor, and it requires the global secondary index to distinguish the same rows among cluster members.

```
gSQL> \var v1 INTEGER
gSQL> DECLARE cur1 CURSOR FOR SELECT c1 FROM t1 FOR UPDATE;
Cursor declared.
gSQL> OPEN cur1;
Cursor is open.
gSQL> FETCH cur1 INTO :v1;
V1
--
1
1 row fetched.
gSQL> UPDATE t1 SET c1 = 1 WHERE CURRENT OF cur1;
ERR-42000(16423): does not support non-deterministic DML in the cluster system : global
secondary index expected
```



It does not support the deferrable constraint.

```
gSQL> ALTER TABLE t1 ADD CONSTRAINT t1_uk UNIQUE(id) DEFERRABLE;
ERR-HYC00(16388): does not support deferrable constraints in the cluster system :
ALTER TABLE t1 ADD CONSTRAINT t1_uk UNIQUE(id) DEFERRABLE
                                *
```

ERROR at line 1:



It does not guarantee the sequence when using the same sequence in different servers.

- It is executed in g1n1 server.

```
gSQL> SELECT seq1.NEXTVAL FROM dual;
NEXTVAL
-----
      1
1 row selected.
gSQL> SELECT seq1.NEXTVAL FROM dual;
NEXTVAL
-----
      2
1 row selected.
```

- It is executed in g2n1 server.

```
gSQL> SELECT seq1.NEXTVAL FROM dual;
NEXTVAL
-----
     21
1 row selected.
```

- It is executed again in g1n1 server.

```
gSQL> SELECT seq1.NEXTVAL FROM dual;
NEXTVAL
-----
      3
1 row selected.
```

2.

Tutorial

2.1 Managing GOLDBLOCKS Instance

This chapter describes the basic knowledge of managing the GOLDBLOCKS instance.

Overview

GOLDBLOCKS database system consists of database and instance. Database is a collection of various files which are necessary for driving database such as dictionary data on memory, user data, data file for dictionary data and user data, online redo files.

Database instance consists of two parts. One is the memory portions containing the run-time information for operating GOLDBLOCKS database, and the other is the background process which is used to operate and manage it. Each database instance is identified as shared memory key value and "GOLDBLOCKS _DATA" environment variable value, both are used to configure shared memory.

Property Setting

GOLDBLOCKS properties are listed in `$GOLDBLOCKS _DATA/conf/goldilocks.properties.conf` file. A user may install GOLDBLOCKS using the basic properties. This chapter describes the main properties such as TBS (Tablespace), LOG, CONTROL FILE.

The followings describe main property items of when installing GOLDBLOCKS.

Table 2-1 Main property items

Property	Description	Default value
SYSTEM_TABLESPACE_DIR	It is the directory path of installing the following system TBS. <ul style="list-style-type: none"> • DICTIONARY_TBS • MEM_DATA_TBS • MEM_UNDO_TBS • MEM_TEMP_TBS • MEM_TRANS_TBS 	'<GOLDBLOCKS_DATA>/db'
SYSTEM_MEMORY_DICT_TABLESPACE_SIZE	It is the dictionary tablespace size.	128M
SYSTEM_MEMORY_DATA_TABLESPACE_SIZE	It is the data tablespace size.	200M
SYSTEM_MEMORY_UNDO_TABLESPACE_SIZE	It is the undo tablespace size.	32M

Property	Description	Default value
LOG_DIR	It is the default log directory path.	'<GOLDDILOCKS_DATA>/wal'
SYSTEM_LOGGER_DIR	It is the system log directory path.	'<GOLDDILOCKS_DATA>/trc'
CONTROL_FILE_COUNT	It is the number of control files.	2
CONTROL_FILE_0	It is the first control file path.	'<GOLDDILOCKS_DATA>/wal/control_0.ctl'
CONTROL_FILE_1	It is the second control file path.	'<GOLDDILOCKS_DATA>/wal/control_1.ctl'



- **DICTIONARY_TBS:** It is the tablespace which stores dictionary tables of GOLDDILOCKS.
- **MEM_DATA_TBS:** It is the tablespace in which the user table/index is generated.
- **MEM_UNDO_TBS:** It is the tablespace which contains the undo (rollback) information of the transaction.
- **MEM_TRANS_TBS (Cluster only):** It is the tablespace used for the global transaction recovery in cluster system. The size is automatically calculated based on the transaction table size and the number of cluster node.

A user can change the text property file (\$GOLDDILOCKS_DATA/conf/golddilocks.properties.conf), or define a new variable in the form of GOLDDILOCKS_<property_name> to change the database settings or instance settings. In the priority, the property file takes precedence over the environment variable.

Background Process

GOLDDILOCKS has a background process (gmaster) for managing instance. gmaster consists of multiple system thread internally, and the contents are as follows.

Table 2-2 System threads

Thread	Description
Main thread	It starts or ends gmaster process.
Log archiving thread	It copies the previous redo log file to a specified location when switching online redo file, and stores it.
Ager thread	It cleans up the resources being used by dropped schema objects.
	It distributes the task to the IO slave and controls them in order to store the dirty pages of

Thread	Description
Page flusher thread	in-memory into the disk at checkpoint.
Log flusher thread	It periodically collects the log records accumulated in the redo log buffer, and then stores them into online redo log file at run-time.
Checkpoint thread	It downloads the in-memory's changes to the data file on the disk and the online redo log file when switching redo log file.
Cleanup thread	It cleans up resources used by abnormally terminated clients, and then rolls back the transactions.
IO slave thread	It performs all disk IO related to data file such as checkpoint and data file loading.
Process monitor thread	It monitors after executing the processes such as balancer (gbalancer), dispatcher (gdispatcher), shared-server (gserver), then reexecutes when abnormal termination is detected.
Cluster Recover Thread (Cluster only)	It recovers a global transaction in cluster system.
Failover Thread (Cluster only)	It deals with the failover through reselecting offline and coordinator for the members when an error occurs on a specific node or in a network in cluster system.

Client Process

Client/ Server Model

The Client/ Server (C/S) model application is connected to listener (glsnr) which is waiting for access request. Then it creates a new database service process (gserver), in dedicated mode, and it handles user's request by using TCP communication. All these operations are carried out through inter process communication, so any signal generated in the application process does not affect on the state of the database. Moreover, cleanup thread regularly checks and returns all the resources used by abnormally terminated application.

Direct Access Model

GOLDILOCKS supports a direct access (D/A) model as well as Client/ Server (C/S) model. All applications using D/A model are linked to the server library supported by GOLDILOCKS, and then directly access database and instance. Therefore, no other special service process exists but only the application processes exist.

When D/A model application process is interrupted abnormally by the signal generated during operation, all resources in use will be cleaned up by the signal handler function which the library set during connection. The function cleans up the resources according to the two following steps.

1. The signal handler marks an abnormal termination on the session object and terminates the process.
2. The cleanup thread of gmaster return resources to the database in the same way as C/S model after

a certain period of time.

Application processes directly access the database area in D/A model. Therefore, comply with the following precautions.

- When the D/A model application process is terminated by a fatal signal such as SEGV, the signal handler which was registered by the library at connection to the database should stop using shared resources. If a specific signal handler should be installed in the application it should be declared before connecting to the database.
- When forcibly shut down the application process, do not use SIGKILL (kill-9) because the process cannot detect the generation of the signal. A user should use SIGTERM, SIGQUIT or SIGUSR2.

Memory Architecture of Instance

The memory size used by the database instance is determined by the relevant properties in the property file. Shared memory used by instance can be divided into static area and tablespace area. Static area includes basic information about public instance, each session, statement, transaction, redo log buffer, dictionary cache and several other operation. Tablespace area includes page frame of each tablespace and Page Control Header (PCH) for controlling them.

The application process memory includes instance memory attached at connection. Additionally, it includes process basis sharing ODBC environment, several ODBC handles, heap memory area with bind information.

Startup and Shutdown Instance

To startup the GOLDILOCKS instance, set the SHARED_MEMORY_STATIC_KEY property differently from other instances. After that, a user can startup the GOLDILOCKS instance by using gsql. Execute it to take sysdba role as follows.

A user should run **listener** before startup or shutdown the GOLDILOCKS instance in dedicated mode of C/S model.

A user can not startup or shutdown the GOLDILOCKS instance in shared mode of C/S model.

```
% gsql sys gliese --as sysdba
Connected to GOLDILOCKS Database.
gSQL>
```

Startup phrase in the SUNDB instance has several phases as follows.

- NOMOUNT
 - It starts up gmater process which is a managing daemon of the GOLDILOCKS instance.
- MOUNT
 - It loads properties and recovery control file by using \$GOLDILOCKS_DATA environment variable.
- OPEN
 - After loading the tablespace contents from data file, it recovers by using redo log, rebuilds no-logging indexes, creates dictionary cache, and then waits for the user's service connection.

A user can start up the GOLDILOCKS instance by using gsql as follows.

```
gSQL> \startup nomount
Startup success
gSQL> alter system mount database;
System altered.
gSQL> alter system open database;
System altered.
```

To directly enter into OPEN phase, do as follows.

```
gSQL> \startup open
Startup success
```

If GOLDILOCKS instance is shut down, gmater (the daemon process for management) would be terminated. Then, connection and database operation is no longer possible.

There are four ways to shutdown the GOLDILOCKS instance as follows.

- NORMAL
 - After blocking the access of a new session and waiting until the end of all connected sessions, a user perform a checkpoint and shuts down the instance.
- TRANSACTIONAL
 - After blocking the start of a new transaction and waiting until the end of all running transactions, a user performs a checkpoint and shuts down the instance.
- IMMEDIATE
 - After blocking the execution of a new unit operation (Connection unit with GOLDILOCKS database. e.g. FETCH or EXECUTE, etc.) and waiting until the end of all unit operations, a user rolls back all transactions, performs a checkpoint and shuts down the instance.
- ABORT
 - Regardless of any connected session's status, a user terminates gmater and shuts down the instance.

To shutdown an instance, use gsql with sysdba role and perform \shutdown, as follows.

```
% gsql sys gliese --as sysdba
Connected to GOLDILOCKS Database.
gSQL> \shutdown normal
Shutdown success
gSQL>
```

Start and End of Listener

A user should run the listener to provide the service in the client/ server environment.

A user can start the listener as follows.

```
% glsnr --start

Listener is started successfully.
%
```

A user can end the listener as follows.

```
% glsnr --stop

Listener is stopped.
%
```

For more information about listener control, refer to **glsnr**.

For more information about how to start or end cluster system refer to **Start and End of Cluster System**.

2.2 Installing GOLDBLOCKS and Creating Database

This chapter describes how to install the GOLDBLOCKS software and create a database.

Overview

GOLDBLOCKS software is a compressed file with the name such as *goldilocks-⟨version_no⟩-⟨os_type⟩-⟨cpu_type⟩.tar.gz*. After decompressing the file, software binaries, various samples, fundamental database directory structures are created at the corresponding location, and then installation is completed. After the installation, the directory is created, and the directory is named after the package. Then directories whose names are *goldilocks_home* and *goldilocks_data* are created under it.

- *goldilocks_home* directory
 - Binary home of GOLDBLOCKS product
 - Defined as GOLDBLOCKS_HOME environment variable
 - Operation binaries, libraries for the client, header files, licenses, etc. are located.
- *goldilocks_data* directory
 - Home of the user database (instance) which GOLDBLOCKS creates.
 - Defined as GOLDBLOCKS_DATA environment variable
 - A default location which has data files, log files, property files

After that, use a utility called *gcreatedb* in *\$GOLDBLOCKS_HOME/bin* directory to create a database in *\$GOLDBLOCKS_DATA* directory.

Release Platform

GOLDBLOCKS is available in the following release platform.

Table 2-3 Release platform

Platform	Platform name	OS	CPU	Remarks
Server platform	linux-x86_64	linux	x86_64	>= linux kernel 2.6 >= glibc 2.1 >= gcc 4.1.2 >= java 1.4 <= java 1.6
	hpux11.31-itanium-64	HP-UX 11.31	itanium	>= java 1.4 <= java 1.6

Platform	Platform name	OS	CPU	Remarks
	aix6-powerpc-64	AIX 6.1	powerpc	>= java 1.4 <= java 1.6
Client platform	linux-x86_64	linux	x86_64	>= linux kernel 2.6 >= glibc 2.1 >= gcc 4.1.2 >= java 1.4 <= java 1.6
	linux-x86_32	linux	x86_32	>= Linux kernel 2.6 >= glibc 2.1 >= gcc 4.1.2 >= java 1.4 <= java 1.6
	hpux11.31-itanium-64	HP-UX 11.31	itanium	>= java 1.4 <= java 1.6
	hpux11.31-itanium-32	HP-UX 11.31	itanium	>= java 1.4 <= java 1.6
	aix6-powerpc-64	AIX 6.1	powerpc	>= java 1.4 <= java 1.6
	windows-x86-64	Windows	PENTINUM x86	java 1.6
	windows-x86-32	Windows	PENTINUM x86	java 1.6

System Requirements

Check the following requirements before installing GOLDILOCKS.

- At least 2 G should be secured at the physical memory and disk space.
- A sufficient amount of paging (swap) area is required.
- The correct package version which fits into the platform to be installed is required.

GOLDILOCKS Package Configuration

This chapter describes the directory configuration when installing GOLDILOCKS.

Package Directory Configuration

Table 2-4 Parent directory configuration

Directory	Server	Client	Description
GOLDILOCKS_HOME	O	O	Binaries and libraries are installed, overwriting-enabled group when updating
GOLDILOCKS_DATA	O	X	The data storing path, overwriting-unabled group

Table 2-5 Package directory configuration

Parent directory	Package directory	Description
GOLDILOCKS_HOME	admin	Required schema script to create database
	bin	Execution files
	lib	Library files
	include	Header files such as ODBC, XA, Embedded SQL, etc.
	license	License files
	sample	Sample files
	msg	Error message files
	script	Script file for ease of use (It will be supported in future)
	app_dev	Application development
GOLDILOCKS_DATA	conf	Configuration files
	db	Database files
	wal	Log files, control files
	archive_log	Archive log files
	backup	Back up files
	trc	Trace log files, warning message files
	journal	Journal file used at cluster rebalance

Package File List

The followings are description of files in a directory, and whether it is included in server package or client package.

Table 2-6 admin directory

File name	Server	Client	Description
README	O	X	Read me
DictionarySchema.sql	O	X	Dictionary schema creating script
InformationSchema.sql	O	X	Information schema creating script
PerformanceViewSchema.sql	O	X	Performanceview schema creating script

Table 2-7 admin/ cluster directory

File name	Server	Client	Description
README	O	X	read me
DictionarySchema.sql	O	X	Dictionary schema creating script
InformationSchema.sql	O	X	Information schema creating script
PerformanceViewSchema.sql	O	X	Performanceview schema creating script

The script created in admin/standalone directory is used when using GOLDILOCKS in standalone. On the other hand, the script created in admin/cluster directory is used when using GOLDILOCKS by configuring cluster system.

Table 2-8 bin directory (Unix)

File name	Server	Client	Description
README	O	O	Read me
gmaster	O	X	GOLDILOCKS master
gcreatedb	O	X	Database creating tool
glsnr	O	X	Listener control tool
gbalancer	O	X	Loads balancer for C/S shared
gdispatcher	O	X	Manages multiple connections for C/S shared
gserver	O	X	Instance manager for C/S
gsql	O	X	Interactive SQL tool
gsqlnet	O	O	Interactive SQL tool for C/S
gpec	O	O	Embedded SQL precompiler
logmirror	O	X	Redo log replication tool
cyclone	O	X	CDC replication tool
gloader	O	X	Import/ export tool
gloadernet	O	O	Import/ export tool for C/S
cymon	O	O	CDC monitoring Tool
gdump	O	X	Control/ log/ data/ binary property file viewer
gsyncher	O	X	Synchronization utility for shared memory log and disk log files
tablediff.jar	O	X	Table comparison tool
cdispatcher	O	X	Manages cluster connections and distributes protocols in cluster system
cserver	O	X	Instance manager for cluster system
gtrclogger	O	X	Trace log manager for cluster system
gmon	O	X	Process monitoring tool
galocator	O	X	Location management tool
gagent	O	X	Location provider tool
gloctl	O	O	Interactive location editing tool

Table 2-9 bin directory (Windows client)

File name	Server	Client	Description
README	X	O	read me
gloadernet.exe	X	O	Import/export tool for C/S
gpec.exe	X	O	Embedded SQL precompiler
gsqlnet.exe	X	O	Interactive SQL tool for C/S
gloctl.exe	X	O	-

Table 2-10 lib directory (Unix)

File name	Server	Client (64 bit)	Client (32 bit)	Description
README	O	O	O	Read me
libstib.so	O	X	X	Shared library for infiniband
libgoldilocks.a	O	X	X	D/A and C/S-inclusive static library for ODBC
libgoldilocks.a	O	X	X	D/A-only static library for ODBC
libgoldilocksas.so	O	X	X	D/A-only shared library for ODBC
libgoldilocksc.a	O	O	O	C/S-only static library for ODBC
libgoldilockscs-ul32.so	O	O	X	64 bit-C/S-only shared library for ODBC (SQLLEN = 4 byte)
libgoldilockscs-ul64.so	O	O	X	64 bit-C/S-only shared library for ODBC (SQLLEN = 8 byte)
libgoldilockscs.so	X	X	O	32 bit-C/S-only shared library for ODBC
libgoldilockscvtGB18030_32.so	X	X	O	32 bit GB18030 character set conversion library
libgoldilockscvtGB18030_64.so	O	O	X	64 bit GB18030 character set conversion library
libgoldilockscvtUHC_32.so	X	X	O	32 bit UHC character set conversion library
libgoldilockscvtUHC_64.so	O	O	X	64 bit UHC character set conversion library
libgoldilocksesql.a	O	O	O	Static library for embedded SQL
libgoldilocksesqls.so	O	O	O	Shared library for embedded SQL
libgoldilockss.so	O	X	X	D/A and C/S-inclusive shared library for ODBC
goldilocks4.jar	O	O	O	C/S-only JDBC library (java 1.4)
goldilocks5.jar	O	O	O	C/S-only JDBC library (java 1.5)
goldilocks6.jar	O	O	O	C/S-only JDBC library (java 1.6)
libgoldilocksjni.so	O	X	X	D/A-only JDBC shared library

Table 2-11 lib directory (Windows client)

File name	Server	Client (64 bit)	Client (32 bit)	Description
goldilocksc.lib	X	O	O	C/S-only static library for ODBC
goldilockscs.dll	X	X	O	32 bit-C/S-only shared library for ODBC
goldilockscs-ul64.dll	X	O	X	64 bit-C/S-only shared library for ODBC (SQLLEN = 8 byte)
goldilockssetup32.dll	X	X	O	32 bit setup library for ODBC
goldilockssetup64.dll	X	O	X	64 bit setup library for ODBC
goldilocksesql.lib	X	O	O	Static library for embedded SQL
goldilocksesqls.dll	X	O	O	Shared library for embedded SQL
goldilockscvtGB18030_32.dll	X	X	O	32 bit GB18030 character set conversion library
goldilockscvtGB18030_64.dll	X	O	X	64 bit GB18030 character set conversion library
goldilockscvtUHC_32.dll	X	X	O	32 bit UHC character set conversion library
goldilockscvtUHC_64.dll	X	O	X	64 bit UHC18030 character set conversion library
goldilocks6.jar	X	O	O	C/S-only JDBC library (for java 1.6)
gdlc.lib	X	O	O	C/S-only static library for ODBC
gdics.lib	X	O	O	C/S-only shared library for ODBC
gdics.dll	X	O	O	C/S-only shared library for ODBC

Table 2-12 include directory (Unix)

File name	Server	Client	Description
README	O	O	Read me
sql.h	O	O	ODBC header file
sqlca.h	O	O	ODBC header file
sqlext.h	O	O	ODBC header file
sqltypes.h	O	O	ODBC header file
sqlucode.h	O	O	ODBC header file
goldilocks.h	O	O	Header file for GOLDILOCKS ODBC application development
goldilockstypes.h	O	O	GOLDILOCKS ODBC data type specification file
xa.h	O	O	Standard XA header file
goldilocksxa.h	O	O	GOLDILOCKS XA header file
goldilocksesql.h	O	O	Embedded SQL header file

Table 2-13 include directory (Windows client)

File name	Server	Client	Description
README	X	O	Read me
goldilocks.h	X	O	Header file for GOLDILOCKS ODBC application development
goldilockstypes.h	X	O	GOLDILOCKS ODBC data type specification file
goldilocksxa.h	X	O	GOLDILOCKS XA header file

File name	Server	Client	Description
goldilocksesql.h	X	O	Embedded SQL header file
sqlca.h	X	O	ODBC header file

Table 2-14 license directory

File name	Server	Client	Description
README	O	X	Read me

Table 2-15 msg directory

File name	Server	Client	Description
README	O	O	Read me
goldilocks_error.msg	O	O	Error message file

Table 2-16 conf directory

File name	Description
README	Read me
goldilocks.property.conf	Database operation property text file
goldilocks.listener.conf	Listener property file
goldilocks.invited.conf	Client management file for database connection invited
goldilocks.excluded.conf	Client management file for database connection excluded
goldilocks.gagent.conf	gagent-only configuration file
tablediff.conf	Tablediff configuration file
cyclone.master.conf	Cyclone master only file
cyclone.slave.conf	Cyclone slave only file
logmirror.master.conf	LogMirror master only file
logmirror.slave.conf	LogMirror slave only File
odbc.ini	Template for ODBC configuration
gsql.ini	Template for gsql configuration
glogin.sql	Execution statement list when driving gsql

Table 2-17 db directory

File name	Description
README	Read me

Table 2-18 wal directory

File name	Description
README	Read me

Table 2-19 archive_log directory

File name	Description
README	Read me

Table 2-20 backup directory

File name	Description
README	Read me

Table 2-21 trc directory

File name	Description
README	Read me

Installing GOLDILOCKS Software

This chapter describes the operating system and the environment setting before installing GOLDILOCKS.

Kernel Parameters

Shared Memory

Shared memory is a type of Inter Process Communication (IPC). It is a memory which is used for sharing data in multiple programs. GOLDILOCKS uses shared memory with user programs using gsql, gloder, ODBC for Client/ Server (C/S) environment. Because all tablespaces for operation are created in shared memory, the precise parameter setting is required.

The followings are parameters and the recommended values required for the shared memory which is used to install GOLDILOCKS.

Table 2-22 Kernal properties for shared memory

Parameter name	Description	Recommended value	Remarks
shmmax	The maximum size of single shared memory segment	The value should be bigger than the size of the biggest datafile.	The value should be set bigger than the size of the biggest datafile belonging to the desired tablespace.
shmmni	The maximum number of shared memory segment available in system	The value should be bigger than the value of which the number of all datafile + 1.	The value should be set bigger than the value of which the number of all datafile + 1 (shared memory segment for SSA).
	The total sum of all shared	The value should be bigger	It is the total sum of pages in shared memory available in system. Generally, it is used for

Parameter name	Description	Recommended value	Remarks
shmall	memory segment (The number of pages)	greater than the total sum of tablespace configuration.	8 GB or bigger shared memory. If the total sum of tablespaces in GOLDILOCKS is 32 GB, shmall should be set bigger than it.

The following is an example to set shmall when the total size of tablespaces is 32 GB.

```
kernel.shmmax = 34359738368
kernel.shmmni=4096
kernel.shmall = 8388609
```

- It is assumed that the shmmax is 32 GB and PAGE_SIZE is 4096 bytes.

```
8388609 = (34359738368 / 4096) + 1
```

- In this case, the value of shmall should be bigger than 8388609.

Semaphore

Semaphore is a kind of IPC, like as shared memory, and it is a technology to control multiple processes' behavior using the resources from the operating system. Depending on semaphore setting, multiple processes can simultaneously refer to a relevant resource, and when any process is in use, the other process may wait until it stops using the resource.

GOLDILOCKS uses semaphore to control the access sequence to the shared memory. For example, if multiple GOLDILOCKS client programs request a change to the same data, it should be controlled properly. The semaphore parameter value should be set to an appropriate value according to semaphore operation of GOLDILOCKS. A general Linux value is recommended.

The followings are recommended semaphore values to install GOLDILOCKS.

Table 2-23 Recommended kernel parameter value for semaphore

Kernel parameter	Description	Recommended value
semmsl	The number of semaphores per single semaphore set	250
semmni	The number of semaphore sets	128
semmns	The total sum of semaphore sets (semmni * semmsl)	32000
semopm	The maximum number of semaphores per system call	100

In Linux based system such as Redhat, Ubuntu, if a user creating IPC resource logs out the session list managed by systemd, then the corresponding IPC resource is automatically deleted. Therefore, the system sh

ould be set as follows to prevent deleting the semaphore. (kernel 3.0.0 and higher)

```
# cp -i /etc/systemd/logind.conf /etc/systemd/logind.conf_prev
# cat /etc/systemd/logind.conf
[Login]
#NAutoVTs=6
#ReserveVT=6
...
RemoveIPC=no
```

- Modify it, then execute it.

```
# systemctl restart systemd-logind
```

Network

The backlog means the sockets' queue length waiting to be accepted during the TCP socket listen. Set `glsnr`'s backlog in GOLDBLOCKS as `glsnr` config file's `BACKLOG`. If the backlog's maximum value in system is bigger than `somaxconn`, then it sets to `somaxconn`. In this case, `somaxconn` should be extended.

GOLDBLOCKS uses Unix Domain Socket (UDS) queue when it operates in C/S shared mode. The queue length is set to `max_dgram_qlen`. If the value is small when clients access the network simultaneously, then it leads to bottleneck state of communication among `glsnr`, `gbalancer` and `gdispatcher`.

The followings are recommended network values to install GOLDBLOCKS.

Table 2-24 Recommended kernel parameter value for network

Kernel parameter	Description	Recommended value
<code>somaxconn</code>	The maximum value of listen backlog	1024
<code>max_dgram_qlen</code>	Unix domain socket queue size	256

Applying Parameters

For a one-time execution, a user can do as follows. (It is required to reapply when the user restarts the system).

```
[SHELL]> echo 34359738368 > /proc/sys/kernel/shmmax
[SHELL]> echo 8388608 > /proc/sys/kernel/shmall
[SHELL]> echo 4096 > /proc/sys/kernel/shmmni
[SHELL]> echo 250 32000 100 128 /proc/sys/kernel/sem
[SHELL]> echo 1024 > /proc/sys/net/core/somaxconn
[SHELL]> echo 256 > /proc/sys/net/unix/max_dgram_qlen
```

If a user wants to apply it automatically even when the user restarts the system, the user can do as follows in `/etc/sysctl.conf`.

```
# shared memory
kernel.shmmax = 34359738368
kernel.shmall = 8388608
kernel.shmmni = 4096
# semaphore
kernel.sem = 250 32000 100 128
# network
net.core.somaxconn = 1024
net.unix.max_dgram_qlen = 256
```

Use the following command to apply the changes given above.

```
[SHELL]> sysctl -p
```

Checking Parameters

The described parameters can be checked by using the following commands.

```
[SHELL]> ipcs -l
----- Shared Memory Limits -----
max number of segments = 4096
max seg size (kbytes) = 33554432
max total shared memory (kbytes) = 33554432
min seg size (bytes) = 1
----- Semaphore Limits -----
max number of arrays = 128
max semaphores per array = 250
max semaphores system wide = 32000
max ops per semop call = 100
semaphore max value = 32767
```

Decompressing GOLDILOCKS

GOLDILOCKS package is supplied in a compressed form. The basic installation completes by decompressing it.

The followings are simple examples of how to install the GOLDILOCKS package.

```
## $GOLDBLOCKS_HOME=/home/GOLDBLOCKS/goldlocks-mercury.2.1.0-linux-x86_64/
[HELL]> gzip -d goldlocks-mercury.2.1.0-linux-x86_64.tar.gz
[HELL]> tar -xvf goldlocks-server-mercury.2.1.0-linux-x86_64.tar
goldlocks-server-mercury.2.1.0-linux-x86_64/goldlocks_home/include/sqlx.h
goldlocks-server-mercury.2.1.0-linux-x86_64/goldlocks_home/include/goldlocks.h
goldlocks-server-mercury.2.1.0-linux-x86_64/goldlocks_home/include/sqlca.h
...
```

When the decompression completes, a user can change the directory name <package_file_name> on the user's taste, and accordingly the user should change the environment variables of \$GOLDBLOCKS_HOME and \$GOLDBLOCKS_DATA.

For more information about directory created by decompression, refer to **GOLDBLOCKS Package Configuration**

Setting Environment Variables

After decompression of GOLDBLOCKS package, bin and lib path will be created under \$GOLDBLOCKS_HOME directory. Then as given below, a user should add bin and lib path under PATH and LD_LIBRARY_PATH to execute GOLDBLOCKS software and develop applications. (When developing GOLDBLOCKS client application, a user should always insert \$GOLDBLOCKS_HOME/include to include file directory of compile option.)

```
export PATH=$GOLDBLOCKS_HOME/bin:$PATH
export LD_LIBRARY_PATH=$GOLDBLOCKS_HOME/lib:$LD_LIBRARY_PATH
```

Environment variables are required to use GOLDBLOCKS. A user should set them prior to installation because some variables are referenced to even during installation.

Table 2-25 OS environment variables for GOLDBLOCKS installation

Environment variables	Description	Remarks
GOLDBLOCKS_HOME	Directory path to install GOLDBLOCKS binaries	This variable is referenced during GOLDBLOCKS operation, and the directory to install GOLDBLOCKS should be set as an environment variable in advance.
GOLDBLOCKS_DATA	The location to create GOLDBLOCKS database instance	This variable is referenced during GOLDBLOCKS database creation and operation.
PATH	Directory path of GOLDBLOCKS executable file	This variable should be set to execute various GOLDBLOCKS binaries without an absolute path.
		<ul style="list-style-type: none"> If the character set is different from the original character set which is created during GOLDBLOCKS database creation, characters (Except alphabets, numbers and special characters) may not be displayed properly. Or the string rela

Environment variables	Description	Remarks
LANG	Character set of terminal	<p>ted functions may not be executed correctly.</p> <ul style="list-style-type: none"> • A user should set locale corresponding to GB18030, SQL_ASCII, UHC, UTF8. • e.g. export LANG=ko_KR.utf8

```
## $GOLDILOCKS_HOME=/home/GOLDILOCKS/goldilocks-mercury.2.1.0-linux-x86_64/
[HELL]> gzip -d goldilocks-mercury.2.1.0-linux-x86_64.tar.gz
[HELL]> tar -xvf goldilocks-server-mercury.2.1.0-linux-x86_64.tar
goldilocks-server-mercury.2.1.0-linux-x86_64/goldilocks_home/include/sqlext.h
goldilocks-server-mercury.2.1.0-linux-x86_64/goldilocks_home/include/goldilocks.h
goldilocks-server-mercury.2.1.0-linux-x86_64/goldilocks_home/include/sqlca.h
...
```

Deleting Database

Delete datafile, control file, redo log file and archive log file (when using the archive log file) should be deleted when deleting the existing database to recreate the GOLDILOCKS DATABASE.

The following is an example of deleting GOLDILOCKS DATABASE.

```
## $GOLDILOCKS_BASE=/home/GOLDILOCKS/goldilocks-mercury.2.1.0-linux-x86_64/
## $GOLDILOCKS_DATA=/home/GOLDILOCKS/goldilocks-mercury.2.1.0-linux-x86_64/
    goldilocks_data/
## $GOLDILOCKS_HOME=/home/GOLDILOCKS/goldilocks-mercury.2.1.0-linux-x86_64/
    goldilocks_home/
[HELL]> rm -rf $GOLDILOCKS_DATA/db/*.dbf
[HELL]> rm -rf $GOLDILOCKS_DATA/wal/*.ctl
[HELL]> rm -rf $GOLDILOCKS_DATA/wal/*.log
[HELL]> rm -rf $GOLDILOCKS_DATA/archive_log/*.log
```

The location of the data file and archive file may vary depending on the settings by a user.

Deletion

GOLDILOCKS package is not provided in compressed file format, so a specific deletion rule is not required. Delete the installed directory after terminating DATABASE.

The following is an example of deleting GOLDILOCKS package.

```

## $GOLDBLOCKS_BASE=/home/GOLDBLOCKS/goldilocks-mercury.2.1.0-linux-x86_64/
## $GOLDBLOCKS_DATA=/home/GOLDBLOCKS/goldilocks-mercury.2.1.0-linux-x86_64/
    goldilocks_data/
## $GOLDBLOCKS_HOME=/home/GOLDBLOCKS/goldilocks-mercury.2.1.0-linux-x86_64/
    goldilocks_home/
[SHELL]> rm -rf $GOLDBLOCKS_DATA
[SHELL]> rm -rf $GOLDBLOCKS_HOME
[SHELL]> rm -rf $GOLDBLOCKS_BASE
## ~/.bash_profile
$GOLDBLOCKS_BASE=/home/GOLDBLOCKS/goldilocks-mercury.2.1.0-linux-x86_64/ ❶ Delete
$GOLDBLOCKS_DATA=/home/GOLDBLOCKS/goldilocks-mercury.2.1.0-linux-x86_64/
    goldilocks_data/ ❷ Delete
$GOLDBLOCKS_HOME=/home/GOLDBLOCKS/goldilocks-mercury.2.1.0-linux-x86_64/
    goldilocks_home/ ❸ Delete

```

Creating Database

Create database after the completion of property creation. A user can create database by using \$GOLDBLOCKS_HOME/bin/gcreatedb. The followings are how to use the gcreatedb commands.

```

[SHELL]> gcreatedb --help
Usage
    gcreatedb [options]
Options:
    --cluster          cluster system (if not specified, stand-alone system)
    --db_name          database name
    --db_comment       database comment
    --timezone         timezone ( {+/-}{TZH:TZM} )
    --character_set    character set
                        SQL_ASCII
                        UTF8
                        UHC
                        GB18030
    --char_length_units char length units
                        OCTETS
                        CHARACTERS
    --home             home directory
    --member           local member name
    --host             host address

```

```

--port          host port
--silent        suppresses the display of the result message
--help         print help message

```

examples:

```

gcreatedb --db_name="goldilocks" --db_comment="goldilocks database" --timezone="+09:00"
--character_set="UTF8" --char_length_units="OCTETS" --silent

```

`$GOLDILOCKS_HOME/conf/goldilocks.properties.conf` is referenced when creating database. Then, table space files are created in `SYSTEM_TABLESPACE_DIR` path in `goldilocks.properties.conf` with the value of `***_TABLESPACE_SIZE`.

--cluster option should be specified when creating the database which is to participate in cluster system.

The followings are execution arguments of gcreatedb.

Table 2-26 Execution arguments of gcreatedb

Argument	Description
--cluster	It is the database to be used in cluster system If it is omitted, standalone database is created.
--db_name	It is the database name If it is omitted, it is set as goldilocks.
--db_comment	It is the database description If it is omitted, it is set as goldilocks database.
--timezone	It is the timezone. If it is omitted, it is set as TIMEZONE property.
--character_set	It is the database character set. GOLDILOCKS supports four types of character sets. <ul style="list-style-type: none"> • GB18030: Simplified Chinese • SQL_ASCII: Character set supporting ASCII • UHC: Unified Hangul Code • UTF8: Unicode Transformation Format - 8 If it is omitted, it is set as CHARACTER_SET property.
--char_length_units	It is the unit of character length. <ul style="list-style-type: none"> • OCTETS: It identifies 1 byte as 1 character • CHARACTERS: It identifies 1 character (n byte) as 1 character. If it is omitted, it is set as CHAR_LENGTH_UNITS property.
--home	It is the database home directory. It searches for a property file, and is referenced to as a location of creating and storing various DB files. If it is omitted, it uses the value set in GOLDILOCKS_DATA environment variable.
--member	It is the member name of local database to be used in cluster system. If it is omitted, it uses the value set in LOCAL_CLUSTER_MEMBER property.
--host	It is the IP address of local member to be used for communication between cluster system members

Argument	Description
	If it is omitted, it uses the value set in LOCAL_CLUSTER_MEMBER_HOST property.
--port	It is the TCP listen port of local member to be used for communication between cluster system members If it is omitted, it uses the value set in LOCAL_CLUSTER_MEMBER_PORT property.
--silent	It hides display messages.
--help	It displays help messages.

A user should consider the followings when creating database.

- Setting kernel parameter shared memory
 - If the size specified in shared memory setting is smaller than the size described in \$GOLDBLOCKS_HOME/conf/goldlocks.properties.conf, a user can not create the database.
- Tablespace size
 - Tablespace files are created when the database is created, and the tablespace is used after being allocated to the memory as big as the tablespace size when driving GOLDBLOCKS. Therefore, it uses memory even when the actual user data does not exist in the data tablespace. Therefore, a user should create database with the sufficient memory considering the actually available memory as well as shared memory on GOLDBLOCKS startup machine when writing goldlocks.properties.conf.
- Whether to use cluster system
 - It should be specified that whether the database will participate as a member of cluster system when creating the database. In other words, --cluster option should be omitted when executing gcreatedb using the database as standalone, but --cluster option should be specified when using the database as cluster system.

When database is created successfully, a user can check the following tablespace file in the path described in SYSTEM_TABLESPACE_DIR of goldlocks.properties.conf.

```
[SHELL]> gcreatedb
Database created
[SHELL]> gcreatedb --db_name="TEST_DB" \
                 --db_comment="test database comment" \
                 --timezone="+09:00" \
                 --character_set="UHC" \
                 --char_length_units="OCTETS"
Database created
[SHELL]> ls $GOLDBLOCKS_DATA/db
system_data.dbf system_dict.dbf system_undo.dbf
```

The following is an example of creating database to be used in cluster system.

```
[SHELL]> gcreatedb --cluster
Database created
[SHELL]> gcreatedb --cluster --member=G1N1
Database created
[SHELL]> gcreatedb --cluster --member=G1N1 --host=127.0.0.1 --port 10101
Database created
[SHELL]> gcreatedb --cluster \
                    --db_name="TEST_DB" \
                    --home=$GOLDILOCKS_DATA \
                    --host=127.0.0.1 \
                    --port=10101 \
                    --db_comment="g1n1 db comment" \
                    --timezone="+09:00" \
                    --character_set="UHC" \
                    --char_length_units="OCTETS"
Database created
[SHELL]> ls $GOLDILOCKS_DATA/db
system_data.dbf system_dict.dbf system_trans.dbf system_undo.dbf
```

Building Dictionary Schema Information

Create the following schema to get the system and object information.



A user should build the following schema after database creation. Otherwise, there is a possibility of malfunction in Catalog API of ODBC, JDBC for obtaining the object's structure information (for example, SQLTables() function). If so, it will not interlock with third party tools.

- **DICTIONARY_SCHEMA**: It consists of views and tables to get object information such as DBA_*, ALL_*, USER_* .
- **INFORMATION_SCHEMA**: It consists of views and tables included in the SQL standard INFORMATION_SCHEMA.
- **PERFORMANCE_VIEW_SCHEMA**: It consists of views to get system information by combining the fixed tables' information.

Views and tables included in each schemas provides convenience to get system information.

After driving GOLDILOCKS instance on OPEN phase, a user should execute the sql files as follows. It should be done at least once after the first database creation.



The scripts to build dictionary schema information are divided into the script for standalone system and the script for cluster system. Therefore, a user should use the appropriate script for the purpose to build the information.

The following describes how to build the information by using the script for standalone database.

```
% gsql --as sysdba --import $GOLDILOCKS_HOME/admin/standalone/DictionarySchema.sql
% gsql --as sysdba --import $GOLDILOCKS_HOME/admin/standalone/InformationSchema.sql
% gsql --as sysdba --import $GOLDILOCKS_HOME/admin/standalone/PerformanceViewSchema.sql
```

The following describes how to build the information by using the script for cluster system.

```
% gsql --as sysdba --import $GOLDILOCKS_HOME/admin/cluster/DictionarySchema.sql
% gsql --as sysdba --import $GOLDILOCKS_HOME/admin/cluster/InformationSchema.sql
% gsql --as sysdba --import $GOLDILOCKS_HOME/admin/cluster/PerformanceViewSchema.sql
```

2.3 Managing Database Memory Structure

This chapter describes the database components which compose GOLDILOCKS instance.

Database Memory Structure

GOLDILOCKS database is divided into memory area and disk area. Memory area is a collection of tablespaces consisting of one or more shared memories. Owing to its in-memory database, GOLDILOCKS database never goes down to the disk by replace operation.

Disk area consists of data files, control file, property file, online redo log files. Data file exists one per shared memory of each tablespace, and control file contains instance configuration information. Property file stores instance environment settings, and online redo log file is used to recover database.

Control File

Control file records the physically stored information on the disk of database, and determines the status of database by firstly reading at the beginning of Instance startup. The control file records the following information.

- Instance state at the time of the previous checkpoint
- Transaction durability mode (CDS/TDS) at the time of the previous startup
- Online redo log file information
- Data file information of each tablespace

Online Redo Log File

Online redo log files store all changes made to the database by transactions in instances. It is used to recover unwritten changes on the data file when restarting instance after database's abnormal termination. Four online redo log files are generated by default in the size specified in LOG_FILE_SIZE property when creating database. A user can add more if the user need. The redo log files are reused in circulation manner.

Checkpoint are generated when online redo log file switches to the next file, and then some dirty pages move down to an appropriate data file. If the checkpoint operation is delayed and the updated page does not move down (ACTIVE state), all transactions will be suspended until checkpoint completion. Therefore, creating a suitable size online redo log file according to the application's characteristic is helpful to improve the database system performance.

Undo Segment

Undo segments records images in advance of changing operation to use when transactions partially or to tally rollback. A single undo segment is assigned to a single transaction during update operation. Undo segments are stored in MEM_UNDO_TBS tablespace. It is recommended to secure enough undo tablespace, in preparation for multiple update transactions or a single transaction with large amount of update operation (bulk delete).

Data File

Data file includes the contents of tables/indexes stored in tablespace.

Data file consists of the followings.

- Page
 - The minimum unit of database I/O. The current size is 8 Kbytes.
- Extent
 - A certain number of continuous pages' collection. The minimum unit of which the segment is allocated space from the tablespace.
 - Extent size of each tablespace could be different.
- Segment
 - A specific type of data structure's collection. A segment consists of extent sets.

Exceptionally, a temporary tablespace, such as MEM_TEMP_TBS tablespace, does not execute redo logging, nor does data file create.

Tablespace

Database is divided into multiple tablespaces with logical structure, which contain tables and indexes. Tablespace is implemented as a set of one or more shared memories, and it is a tool to manage the space of loading data. When a user enquires V\$TABLESPACE table, tablespace information on current database will be outputted.

GOLDILOCKS supports the following tablespaces by default.

Table 2-27 Tablespaces of GOLDILOCKS

Owner	Name	Description
SYSTEM	DICTIONARY_TBS	Default dictionary tables are stored in this tablespace to operate database.
	MEM_UNDO_TBS	Undo segments and transaction information are stored in this table space.
	MEM_DATA_TBS	If a user does not specify a tablespace when creating schema object, the data table is stored in this tablespace by default.
	MEM_TEMP_TBS	Indexes which does not specified tablespace name, and temporary tables which are used by queries are created in the tablespace. Indexes are rebuilt when resta

Owner	Name	Description
		rting instance because logging does not occur.
	MEM_TRANS_TBS	It is used to recover global transaction in cluster system. It is created only when it is configured as cluster system.
USER	User-defined	User defines this tablespace to collect specific tables to a specific tablespace and manage them.

Tablespace Types

There are five types of tablespace as follows.

- DICT
 - Tablespace type for storing dictionary tables and indexes.
- DATA
 - Tablespace type for storing general schema objects such as tables and indexes.
 - It becomes the subject of redo logging and page flushing.
- UNDO
 - Tablespace type for storing undo segments.
 - It becomes the subject of redo logging and page flushing.
- TEMPORARY
 - Tablespace type for storing the temporary tables and no-logging indexes which are created during SELECT query.
 - It is not the subject of redo logging and page flushing.
- TRANSACTION (Cluster only)
 - Tablespace type which is used to recover global transaction in cluster system

Checking Information of Database Storage Structure

This chapter describes a method to check the information about multiple database storage structure which are mentioned above.

Control File Information

Use `gdump` utility to check the contents because control file is stored in binary format.

```
[SHELL]> gdump CONTROL control_0.ctl
```

Online Redo Log File Information

Retrieve the control file by using gdump tool, then the name and current state of each online redo file will be displayed.

Data File Information

Retrieve the control file by using gdump tool, then the data files in each tablespaces and its states will be displayed. Also, viewing the V\$DATAFILE table, their current states will be displayed.

Tablespace Information

Retrieve the control file by using gdump tool, then the name and state of each tablespace in the current database will be displayed. Also, a user can enquire the V\$TABLESPACE table by using SQL.

Property Information

Open the text file \$GOLDILOCKS_Data/conf/goldilocks.properties.conf, then the property information will be displayed. When working online, retrieve V\$PROPERTY table, then the information about currently applied property values will be displayed.

General Operation of Data Storage

A tablespace stores data, and its operation is as follows.

Creating Tablespace

USER DATA tablespace is created as follows.

```
gSQL> CREATE TABLESPACE TEST_TBS DATAFILE 'TEST_TBS.dbf' SIZE 10M;  
Tablespace created.
```

TEMPORARY tablespace does not include data file, so it is created as follows.

```
gSQL> CREATE TEMPORARY TABLESPACE TEST_TEMP_TBS MEMORY 'TEST_TEMP_TBS' SIZE 10M;  
Tablespace created.
```

Retrieving Tablespace Usage State

A tablespace space is allocated or deallocated in the unit of one extent consisting of one or more consecutive pages. A user can retrieve the size of one extent (BYTE) in a specific tablespace as follows.

```
gSQL> SELECT EXTENT_SIZE FROM V$TABLESPACE WHERE TBS_NAME = 'TEST_TBS';
EXTENT_SIZE
-----
          262144
1 row selected.
```

A user can view the state of all extents in tablespaces by using D\$TABLESPACE_EXTENT table. When an extent is in use, the STATE column is 'U'. When an extent is in free state, the STATE column is 'F'. Therefore, the remaining size of space in the current tablespace (the number of extents) can be calculated as follows.

```
gSQL> SELECT COUNT(*) FROM D$TABLESPACE_EXTENT('TEST_TBS') WHERE STATE = 'F';
COUNT(*)
-----
          38
1 row selected.
```

Seeing the result above, the empty space in TEST_TBS is $38 * 262144 = 9437184$ Byte.

Altering Tablespace

A user can alter the tablespaces by using Add/Remove Data File (Memory in case of temporary tablespaces), and Online/Offline.

Add/ Drop Data File (or Memory)

If a user wants to add spaces to tablespaces while operating the database, the DATA tablespaces allocate the additional space by using the following syntax.

```
gSQL> ALTER TABLESPACE TEST_TBS ADD DATAFILE 'TEST_TBS2.dbf' SIZE 10M;
Tablespace altered.
```

TEMPORARY tablespace adds spaces as follows. Unlike DATA tablespace, a name should be given, and the name should be a unique memory name in database.

```
gSQL> ALTER TABLESPACE TEST_TEMP_TBS ADD MEMORY 'TEST_TEMP_TBS2' SIZE 10M;
Tablespace altered.
```

A user can drop the space in DATA tablespace by using the following syntax. However, if any part of the area is used, the user can not drop it.

```
gSQL> ALTER TABLESPACE TEST_TBS DROP DATAFILE 'TEST_TBS2.dbf';
Tablespace altered.
```

Similarly, a user can withdraw the space in TEMPORARY tablespace by using the following syntax.

```
gSQL> ALTER TABLESPACE TEST_TEMP_TBS DROP MEMORY 'TEST_TEMP_TBS2';
Tablespace altered.
```

Offline Tablespace

Switch the tablespace to offline mode if a user wants to move the location of data file in the tablespace. Use the following syntax.

```
gSQL> ALTER TABLESPACE TEST_TBS OFFLINE;
Tablespace altered.
```

A user can switch the tablespace to online mode again by using the following syntax.

```
gSQL> ALTER TABLESPACE TEST_TBS ONLINE;
Tablespace altered.
```

Rename

Rename the tablespace by using the following syntax.

```
gSQL> ALTER TABLESPACE TEST_TBS RENAME TO TEST_TBS2;
Tablespace altered.
```

Switch the tablespace to offline mode, if a user wants to change the location of data file in the tablespace. Then, move the data file by using OS command, rename it by using ALTER TABLESPACE statement, then switch the tablespace to online state.

```
gSQL> ALTER TABLESPACE TEST_TBS OFFLINE;
Tablespace altered.
gSQL> ALTER TABLESPACE TEST_TBS RENAME DATAFILE 'TEST_TBS.dbf' TO 'TEST_TBS_1.dbf';
ERR-42000(16164): file does not exist :
ALTER TABLESPACE TEST_TBS RENAME DATAFILE 'TEST_TBS.dbf' TO 'TEST_TBS_1.dbf'
*
ERROR at line 1:
```

- The following procedure describes how to rename the file by using OS command.

```
gSQL> ALTER TABLESPACE TEST_TBS RENAME DATAFILE 'TEST_TBS.dbf' TO 'TEST_TBS_1.dbf';
Tablespace altered.
gSQL> ALTER TABLESPACE TEST_TBS ONLINE;
Tablespace altered.
```

Dropping Tablespace

Drop an unnecessary tablespace by using the following syntax. The statement after INCLUDING is optional, but if the statement is given then it will delete all the content (schema object) and data file in the tablespaces.

```
gSQL> DROP TABLESPACE TEST_TBS INCLUDING CONTENTS AND DATAFILES;
Tablespace dropped.
```

Store Mode

GOLDILOCKS uses the store mode as an instance unit to maximize performance under certain circumstance. Store mode defines which part of ACID property to give up to improve the operation performance in the transaction.

GOLDILOCKS supports two types of store modes.

- Transactional Data Store (TDS) mode
 - TDS mode is default store mode of GOLDILOCKS database.
 - Transactional Data Store (TDS) mode is general DBMS store mode. In this mode, all transactions in the instance write both undo log and redo log. Therefore, a user can rollback the transactions and recover using data file and online redo log file even when an instance is terminated abnormally, because periodical checkpoint are performed.
- Concurrent Data Store (CDS) mode
 - All running transactions in the instance write undo logs, but do not write redo logs. Therefore, the transactions can deal with all run-time errors, and can rollback. But if an instance is terminated abnormally or terminated using shutdown abort statement, all updated data would be lost. (It does not provide recover facility). It is because checkpoint action does not occur. CDS Mode controls concurrency among transactions, so it ensures normal operations of transactions even when different transactions access the same object at the same time.
 - CDC Mode is mainly used in run-time information oriented database in which query/update operations are frequently performed but does not require durability such as cache server.

Store mode is set through the property setting when a user starts up the instance. Transactions can not be

e executed in different store modes. The user should carefully set the store mode when the user starts up the instance because the user can not change the instance in online mode.

2.4 Managing Schema Object

Schema Object

Schema object is a set of logical structure created by a user. GOLDILOCKS supports the following schema objects, which are table, index, synonym, view, sequence, constraint and stored procedure.

Schema Object Management Privileges

Currently, GOLDILOCKS supports user and his privilege. Therefore, not all the users share all the created objects, so the privilege should be given to a user.

Managing Table

This chapter describes table overview, methods of retrieving the table information, creating/ altering table and loading/ dropping data.

Table

A table is the most basic unit of storage containing user data. A table consists of columns and rows.

Table Type

Currently, GOLDILOCKS supports general heap table whose data saving order is irrelevant to sort order of a particular column. However, GOLDILOCKS does not support clustered table, partitioned table.

- It supports basic heap table only.
- It supports primary key/unique/not null constraint.
- It supports the datatypes as follows.
 - BOOLEAN
 - SMALLINT, INTEGER, BIGINT, REAL, DOUBLE, NUMERIC, FLOAT
 - CHAR (MAX 2000), VARCHAR (MAX 4000), BINARY, VARBINARY, LONG VARCHAR, LONG VARBINARY
 - DATE, TIME, TIMESTAMP, INTERVAL (It supports WITH/WITHOUT TIMEZONE of TIME/TIMESTAMP.)
 - It does not support BLOB type.

- The number of columns, indexes and constraints are not limited.
- A user can retrieve the entire table information using a query *SELECT * FROM TABLES;*

If a huge number of rows are stored in a particular table, and then the table size becomes big, even bulk delete operation does not return the table's empty space to the tablespace. But TRUNCATE operation can return all existing space to the tablespace.

Table data can be stored and retrieved being distributed to multiple nodes according to the user's desiring distribution policy when using GOLDILOCKS configuring it as cluster system. For more information, refer to **Managing Table**

Managing Index

This chapter describes index overview and creating/deleting index.

Overview

Index is a subsidiary schema object which is linked to tables. A user can easily find the location of specifically conditioned row using the index. A user can also retrieve the row's column value if the column is the key column of the index.

GOLDILOCKS can create as many indexes in need to tables. However, too many indexes burden the execution of inserting/ changing/ deleting operation of the table, then it may lower the performance.

Primary key or unique constraint automatically creates an index on that column.

Index Property

- It supports B-link tree form index.
 - GOLDILOCKS provides B-link tree form index by default.
- The size of a single index node is 8 Kbytes.
- The maximum number of key columns is 32, and the maximum key length is 2000 bytes.
- It supports unique index.
- It supports Ascending/Descending, NULLS FIRST and NULLS LAST.
 - A user can define whether to sort index key columns in ascending order (ASC) or in descending (DESC) order.
 - A user can define whether to list NULL value of the index key column at first (NULLS FIRST) or at last (NULLS LAST).
- A user can retrieve the whole index information by using the query *SELECT * FROM INDEXES;*
- A user can calculate the index size in the similar way of calculating table because index is implemented by segment in the same way of implementing table.

Sequence

Sequence is a schema object which generates a unique number.

A user can generate the sequence as follows.

```
gSQL> CREATE SEQUENCE customers_seq START WITH 1000 INCREMENT BY 1 NOCACHE NOCYCLE;  
Sequence created.
```

A user can use the sequence by using NEXTVAL.

```
gSQL> SELECT customers_seq.NEXTVAL FROM dual;
```

A user can drop the sequence as follows.

```
gSQL> DROP SEQUENCE customers_seq;
```

Global sequence object is automatically created when user creates sequence by using GOLDLOCKS configuring cluster system. This object manages the global pool of the sequence value which is used being shared by all member nodes in cluster system. Each member node is allocated the sequence value as many as specified from the global object when calling NEXTVAL and uses them.

For more information, refer to **Global Sequence**.

2.5 Managing User

Creating User

Only the SYS user and the user with the CREATE USER ON DATABASE privilege can create a user for GOL DILOCKS database. The CREATE SESSION ON DATABASE privilege is required to connect to the newly created user.

The followings are the syntax to create a user.

```
<user definition> ::=
    CREATE USER user_identifier IDENTIFIED BY password
    [ DEFAULT TABLESPACE tablespace_name ]
    [ TEMPORARY TABLESPACE tablespace_name ]
```

The followings are the syntax rules and parameters to create a user.

- user_identifier
 - It is a username to be created.
 - The username and the role name should be unique.
 - The length of a user_identifier should be smaller than 128 bytes.
- password
 - The password is stored encrypted.
 - The length of a password should be smaller than 128 bytes.
 - Password is case-sensitive.
- DEFAULT TABLESPACE tablespace_name
 - It specifies the default tablespace which stores the objects such as tables, indexes (LOGGING) created by a user which is to be created.
 - If DEFAULT TABLESPACE clause is omitted, it is specified as the default data tablespace (MEM_DATA_TBS) which is defined when creating DATABASE (<database definition>).
- TEMPORARY TABLESPACE tablespace_name
 - It specifies the TABLESPACE to store user-created temporary tables, index (NO LOGGING), and query processing-generated intermediate results.
 - If TEMPORARY TABLESPACE clause is omitted, it specifies as the default temporary tablespace (MEM_TEMP_TBS) which is defined when creating DATABASE (<database definition>).
- INDEX TABLESPACE tablespace_name
 - It specifies the default tablespaces to store an index object created by a user to be created.
 - If INDEX TABLESPACE clause is omitted, the default value is INDEX TABLESPACE NULL.

Dropping User

It drops the created user of GOLDILOCKS database. An access privilege and user range for dropping user are as same as those for creating user.

The following is the syntax to drop a user.

```

<drop user statement> ::=
    DROP USER [ IF EXISTS ] user_identifier [ <drop behavior> ]
    ;
<drop behavior> ::=
    RESTRICT
    | CASCADE
  
```

The followings are the syntax rules and parameters for dropping a user.

- IF EXISTS
 - Even when the user does not exist, an error does not occur.
- user_identifier
 - It is a database username to be dropped.
 - A user can not drop a user, such as SYS, which is automatically generated when the database is created.
 - It does not drop objects, such as tablespace, which is not the owner but created by user_identifier.
- drop behavior
 - If drop behavior is omitted, the default value is RESTRICT.

Altering User

It alters the definition of the GOLDILOCKS database user. ALTER USER privilege is required for an ordinary user. However, if a user is the user_identifier user, then the user can alter the definition without the privilege.

The followings are the syntax to alter the user definition.

```

<alter user statement> ::=
    ALTER USER user_identifier <alter user action>
    | ALTER USER PUBLIC <alter schema path>
    ;
<alter user action> ::=
  
```

```

    <alter password>
  | <alter profile>
  | <alter default tablespace>
  | <alter temporary tablespace>
  | <alter index tablespace>
  | <alter schema path>
<alter password> ::=
    IDENTIFIED BY new_password [ REPLACE old_password ]
<alter profile> ::=
    PROFILE { profile_name | DEFAULT | NULL }
<password expire> ::=
    PASSWORD EXPIRE
<account lock> ::=
    ACCOUNT { LOCK | UNLOCK }
<alter default tablespace> ::=
    DEFAULT TABLESPACE tablespace_name
<alter temporary tablespace> ::=
    TEMPORARY TABLESPACE tablespace_name
<alter index tablespace> ::=
    INDEX TABLESPACE { tablespace_name | NULL }
<alter schema path> ::=
    SCHEMA PATH ( { schema_name | CURRENT PATH } [, ...] )

```

The followings are the syntax rule and parameters for altering user.

- user_identifier
 - It is a username to be altered.
- <alter password>
 - It alters user password.
 - IDENTIFIED BY new_password
 - It changes the current password, and the new password is stored encrypted.
 - The length of a password should be smaller than 128 bytes.
 - Password is case-sensitive.
 - REPLACE old_password
 - If a user have ALTER USER ON DATABASE privilege, the user can omit it.
 - If a user do not have ALTER USER ON DATABASE privilege, the user can not omit it.
 - The user and user_identifier should be same.
- <alter profile>
 - It alters the profile for password management policies.
 - PROFILE profile_name
 - It allocates profile_name created by a user.

- PROFILE DEFAULT
 - It allocates "DEFAULT" which is the default profile.
- PROFILE NULL
 - It does not allocate the profile.
- <password expire>
 - It expires the user password.
- <account lock>
 - ACCOUNT LOCK
 - It locks the user account.
 - ACCOUNT UNLOCK
 - It unlocks the account lock.
- <alter default tablespace>
 - It alters user's default tablespace.
 - tablespace_name should be data tablespace.
- <alter temporary tablespace>
 - It alters user's temporary tablespace.
 - tablespace_name should be temporary tablespace.
- <alter index tablespace>
 - It alters the index tablespace of a user.
 - It assigns INDEX TABLESPACE tablespace_name
 - When assigning the data tablespace, it should be the LOGGING index.
 - When assigning the temporary tablespace, it should be the NOLOGGING index.
 - INDEX TABLESPACE NULL
 - It does not assign the index tablespace.

2.6 GOLDILOCKS Property

GOLDILOCKS property is classified as the property which is applied when creating database and the property which can be updated at online/offline. A user can change the tablespace path and the redo log file only at MOUNT phase of startup.

Properties When Creating Database

Table 2-28 Properties when creating database

Name	Description
SYSTEM_MEMORY_DICT_TABLESPACE_SIZE	Initial size of dictionary tablespace
SYSTEM_MEMORY_DATA_TABLESPACE_SIZE	Initial size of system data tablespace
SYSTEM_MEMORY_UNDO_TABLESPACE_SIZE	Initial size of system undo tablespace
SYSTEM_MEMORY_TEMP_TABLESPACE_SIZE	Initial size of system temporary tablespace
LOG_BLOCK_SIZE	Block size of redo log file
LOG_FILE_SIZE	Initial size of redo log file
LOG_GROUP_COUNT	The number of redo log files
CHARACTER_SET	Character set
TIMEZONE	Time zone
CHAR_LENGTH_UNITS	Character length unit

Properties When Driving Database

There are more than 100 properties in GOLDILOCKS database. The followings are frequently used properties among them.

Table 2-29 Frequently used properties when driving database

Name	Description
SHARED_MEMORY_STATIC_KEY	Key value to create the shared memory
SHARED_MEMORY_STATIC_SIZE	Size of the shared memory
DATA_STORE_MODE	Storage mode of GOLDILOCKS instance
LOG_BUFFER_SIZE	Log buffer size
LOG_DIR	Directory path of redo log
PRIVATE_STATIC_AREA_SIZE	Static area size per session
CLIENT_MAX_COUNT	The maximum number of accessible session
PROCESS_MAX_COUNT	The maximum number of process

Name	Description
NET_BUFFER_SIZE	Network buffer size per session

2.7 GOLDILOCKS Utility

gcreatedb

The gcreatedb utility initializes GOLDILOCKS database and gets ready for the service. The gcreatedb generates data files and log files in the GOLDILOCKS_DATA environment variable location according to given properties. The following is a syntax.

```
[SHELL]> gcreatedb --help
Usage
  gcreatedb [options]
Options:
  --cluster          cluster system (if not specified, stand-alone system)
  --db_name          database name
  --db_comment       database comment
  --timezone         timezone ( {+/-}{TZH:TZM} )
  --character_set    character set
                    SQL_ASCII
                    UTF8
                    UHC
                    GB18030
  --char_length_units char length units
                    OCTETS
                    CHARACTERS
  --home            home directory
  --member          local member name
  --host            host address
  --port           host port
  --silent         suppresses the display of the result message
  --help          print help message
examples:
  gcreatedb --db_name="goldilocks" --db_comment="goldilocks database" --timezone="+09:00"
  --character_set="UTF8" --char_length_units="OCTETS" --silent
```

Tablespace files are created in *SYSTEM_TABLESPACE_DIR* of goldilocks.properties.conf as each value of ***_TABLESPACE_SIZE* by referring to *\$GOLDILOCKS_HOME/conf/goldilocks.properties.conf* when creating the database.

The followings are execution arguments of gcreatedb command.

Table 2-30 Execution arguments of `gcreatedb`

Argument	Description
<code>--cluster</code>	It is the database to be used in cluster system. If it is omitted, standalone database is created.
<code>--db_name</code>	It is the database name. If it is omitted, it is set as <i>goldilocks</i> .
<code>--db_comment</code>	It is the database description. If it is omitted, it is set as <i>goldilocks database</i> .
<code>--timezone</code>	It is the timezone. If it is omitted, it is set as TIMEZONE property.
<code>--character_set</code>	It is the database character set. GOLDILOCKS supports four types of character sets. <ul style="list-style-type: none"> • GB18030: Simplified Chinese • SQL_ASCII: Character set supporting ASCII • UHC: Unified Hangul Code • UTF8: Unicode Transformation Format - 8 If it is omitted, it is set as CHARACTER_SET property.
<code>--char_length_units</code>	It is the unit of character length. <ul style="list-style-type: none"> • OCTETS: It identifies 1 byte as 1 character • CHARACTERS: It identifies 1 character (n byte) as 1 character. If it is omitted, it is set as CHAR_LENGTH_UNITS property.
<code>--home</code>	It is the database home directory. It searches for a property file, and is referenced to as a location of creating and storing various DB files. If it is omitted, it uses the value set in GOLDILOCKS_DATA environment variable.
<code>--member</code>	It is the member name of local database to be used in cluster system. If it is omitted, it uses the value set in LOCAL_CLUSTER_MEMBER property.
<code>--host</code>	It is the IP address of local member to be used for communication between cluster system members. If it is omitted, it uses the value set in LOCAL_CLUSTER_MEMBER_HOST property.
<code>--port</code>	It is the TCP listen port of local member to be used for communication between cluster system members. If it is omitted, it uses the value set in LOCAL_CLUSTER_MEMBER_PORT property.
<code>--silent</code>	It hides display messages.
<code>--help</code>	It displays help messages.

gsqL (GOLDILOCKS Interactive SQL Tool)

gsqL is an interactive command line utility to execute SQL statements for managing GOLDILOCKS database. DBA creates initial table schema by using gsqL, or checks the current database state.

The following is the gsql syntax.

```
[SHELL]> gsql <userid> <passwd>
gSQL> CREATE TABLE T1 ( COL1 INTEGER );
create success
gSQL> \q
[SHELL]>
```

gloader (GOLDILOCKS Data Upload/download Tool)

The gloader utility downloads existing data in database to a file in text format, or it uploads an existing data in text format to a new database. The text data file format of gloader is Comma-Separated Value (CSV).

The following is how to use gloader.

```
gloader [export|import] userid/passwd control='control_file_name' \
data='data_file_name' log='log_file_name' bad='bad_file_name'
```

Table 2-31 Arguments of gloader

Argument	Description
export import	It declares whether to download the contents of existing table to data_file_name, or to upload existing data in data_file_name to a specified table in control_file_name.
userid	It specifies user ID.
passwd	It specifies the password of the userid.
control	It specifies the file path in which detailed settings are written during export/import operation.
data	It specifies target data file to export, or data file to import.
log	It specifies log file path in which the progress and the elapsed time of import/export operation.
bad	It specifies bad file path which records data records failed in insertion at importing due to various errors.

The following is an example of a control file.

```
TABLE TEST_TBL
FIELDS TERMINATED BY ','
OPTIONALLY ENCLOSED BY ''''
```

3.

Cluster Tutorial

3.1 Managing GOLDBLOCKS Cluster System

This chapter describes the basic information for configuring and managing the cluster system by using multiple GOLDBLOCKS databases. Only the parts added to the cluster system or distinguishing the cluster system comparing to the standalone database are described in this chapter, so it is prerequisite to read the standalone database tutorial before read this chapter.

Overview

GOLDBLOCKS can be used by configuring a standalone database as described in the previous chapter. Or, a user can also bind multiple databases into a single cluster, then select an appropriate solution for data distribution. In other words, a user can customize how to distribute massive data to multiple servers when using GOLDBLOCKS cluster system. This guarantees high availability and improves the throughput due to the parallel processing.

GOLDBLOCKS cluster system consists of one or more cluster groups, and a cluster group consists of one or more cluster members. It does not require an extra application server or a meta server. Applications are operated accessing to cluster members corresponding to the data server. Cluster members belonging to the same cluster group keeps the same data replication.

A user should determine whether to use GOLDBLOCKS database as standalone system or as cluster system, when creating database of each node. To use it as cluster system, a user should add options related to cluster when creating database of each node.

Property Setting

Properties to build cluster system are described in `$GOLDBLOCKS_DATA/conf/goldlocks.property.conf` file of each server like as when using standalone database. Main properties for TBS (tablespace), LOG, CONTROL FILE can be set as same as setting in standalone system even when using cluster system. However, there should not be the same path or port of files among cluster members when creating multiple databases to configure cluster system in a single server.

The followings describe main property items of when configuring cluster system.

Table 3-1 Main property items

Property	Description	Default value
	It is the directory path of installing the following system TBS.	

Property	Description	Default value
SYSTEM_TABLESPACE_DIR	<ul style="list-style-type: none"> • DICTIONARY_TBS • MEM_DATA_TBS • MEM_UNDO_TBS • MEM_TEMP_TBS • MEM_TRANS_TBS 	'<GOLDDILOCKS_DATA>/db'
SYSTEM_MEMORY_DICT_TABLESPACE_SIZE	It is the dictionary tablespace size.	256M
SYSTEM_MEMORY_DATA_TABLESPACE_SIZE	It is the data tablespace size.	200M
SYSTEM_MEMORY_UNDO_TABLESPACE_SIZE	It is the undo tablespace size.	32M
LOG_DIR	It is the default log directory path.	'<GOLDDILOCKS_DATA>/wal'
SYSTEM_LOGGER_DIR	It is the system log directory path.	'<GOLDDILOCKS_DATA>/trc'
CONTROL_FILE_COUNT	It is the number of control files.	2
CONTROL_FILE_0	It is the first control file path.	'<GOLDDILOCKS_DATA>/wal/control_0.ctl'
CONTROL_FILE_1	It is the second control file path.	'<GOLDDILOCKS_DATA>/wal/control_1.ctl'
LOCAL_CLUSTER_MEMBER	It is the name of cluster member of which local server uses in cluster system.	'G1N1'
LOCAL_CLUSTER_MEMBER_HOST	It is the host name of local server.	'127.0.0.1'
LOCAL_CLUSTER_MEMBER_PORT	It is TCP listen port of which local server uses for the communication in cluster system.	10101

The name of cluster member and host-port combination should be unique in cluster system. To omit the property setting above, provide information by using `--member`, `--host`, `--port` options when creating data base using `gcreatedb`. The member information provided by property or `gcreatedb` option is stored and managed in `$GOLDDILOCKS_DATA/wal/location.ctl` file.

To modify the properties, update the text property file (`$GOLDDILOCKS_DATA/conf/golddilocks.properties.conf`), or define a new variable in a form of `GOLDDILOCKS_<property_name>` in an environment variable. The property file is prior to the environment variable.

Background Process

GOLDDILOCKS cluster system has the background process (`gmaster`) to manage instances per each member node. `gmaster` of each node consists of multiple system threads internally. Most of them are as same as those in standalone system, but the following system threads are added to manage cluster system.

The following threads are performed only when starting the database created as cluster mode.

- Cluster recover thread: It recovers global transaction in cluster system.
- Failover thread: It deals with the failover through reselecting offline and coordinator for the members when an error occurs on a specific node or in a network in cluster system.

Two following processes are additionally driven when using GOLDILOCKS as cluster system.

- cdispatcher: It transmit/receive cluster packet and manages sessions.
- cserver: It performs operation of modifying and querying for the database to which the member node belongs.

GOLDILOCKS cluster system requires complex cluster protocol communication among member nodes, and cluster dispatcher (cdispatcher) is a process to efficiently perform the management of network communication context and packet distribution mechanism. In addition, it performs monitoring continuously the validity of cluster session through heartbeat.

In cluster system, SQL performing in a specific node (driver node) needs to store data on the remote member node by referring to the sharding strategy of the target table or enquires the data stored in the corresponding node. In this case, a process is required to process this request and return the result in each member node, and that process is cserver.

Client Process

A user can use both client server (C/S) model and direct access (D/A) model in cluster system like as standalone system. However, each member node of cluster system has its own listener, so the client programs should know the listen port of the cluster member to access beforehand (in C/S mode). A user can process various transactions when accessing to any node of cluster system like as standalone database.

Signal handling, cleanup for connection, releasing shared resources in cluster system are processes as same as those in standalone system.

Memory Structure of Instance

GOLDILOCKS cluster system is used to bind multiple shared-nothing databases to a management unit which is a single cluster system. Therefore, a method of using memory of cluster member nodes is similar to that of standalone. The memory size of which each member node uses are determined by properties set in its own property. Static area contains instance basic information for database management, information for each session, statement, transaction, redo log buffer, dictionary cache, and other operational information like as standalone system. Additionally, information for management of cluster session such as inf

ormation for location and cluster session are also stored.

Tablespace area consists of page frames and page control header (PCH). The page frame contains the contents of each tablespace and PCH controls those page frames.

The application process memory contains instance memories attached when connecting, ODBC environment shared in process unit, various ODBC handles and heap memory area containing other information such as bind information.

Start and End of Cluster System

To start GOLDILOCKS system, create instance on each member node beforehand (gcreatedb), and then register cluster group and cluster member. Later, a user can start or end the system by using sysdba role through gsql and gsqlnet.

listeners should be in operation if a user wants to start or end GOLDILOCKS cluster system in dedicated mode of C/S model (to use gsqlnet).

GOLDILOCKS cluster system can not be started or ended in the shared mode of C/S model.

```
% gsql --as sysdba
Enter user-name: sys
Enter password:
Connected to an idle instance.
gSQL>
```

GOLDILOCKS cluster system has the following startup phases. OPEN phase is subdivided into LOCAL OPEN and GLOBAL OPEN unlike the standalone system.

- NOMOUNT
 - It launches gmaster which is a demon to manage GOLDILOCKS instance.
- MOUNT
 - It reads properties, and the control file for the recovery by using \$GOLDILOCKS_DATA environment variable.
- LOCAL OPEN
 - It loads tablespace content from data files, then performs recovery by using the redo log files, and recovers in-doubt global transaction, newly build no-logging indexes, and creates dictionary caches.
- OPEN (GLOBAL OPEN)
 - It connects cluster sessions of each cluster member, arranges shard map, selects a global manager (global coordinator) and a group manager (group coordinator), then waits for the user to access the service.

To start or end the GOLDDILOCKS cluster system the cluster system environment should be configured performing the following preliminary works. If the member name, host address, port number are uniquely given when creating each member database by using `gcreatedb`, the property setting process for each node can be omitted.

- Setting property: Update property files to be used on each member node.
- Creating database: Create the database through `gcreatedb` on each member node.
- Creating cluster group and adding a member: Create a group and a member configuring cluster system.
- Driving listener: The listener on each node should be driven beforehand to use `gsqnet`.

Use the following syntaxes to create a cluster group or a member.

- **ALTER CLUSTER GROUP name ADD MEMBER**
- **CREATE CLUSTER GROUP**

- Creating database: It is performed on each node.

```
% gcreatedb --cluster --db_name='goldilocks' --member='g1n1' \
  --host='192.168.0.11' --port 10110
% gcreatedb --cluster --db_name='goldilocks' --member='g1n2' \
  --host='192.168.0.12' --port 10120
```

- Creating a cluster group and a member: It is performed on a single node.

```
gSQL> create cluster group g1 cluster member g1n1
      host '192.168.0.11' port 10110;
gSQL> alter cluster group g1 add cluster member g1n2
      host '192.168.0.12' port 10120;
```

If the configuration of GOLDDILOCKS cluster system is completed as above, the entire cluster system can be started or ended by using the following two methods.

- Accessing to each member node to start or end nodes one by one
 - Use `\startup` and `\shutdown` commands.
- Start or end the entire member node at once in a single member node
 - Connect through `gsqnet`, and then use `\cstartup` and `\cshutdown` commands.

The following describes the first method above which is how to access each member node then drive cluster system. `\startup` command is used to directly enter into LOCAL OPEN phase without the intermediate phase. This can be operated being subdividing into three phases, which are `\startup nomount`, alter system mount database, and alter system open local database.

Drive up to LOCAL OPEN phase on each node through `\startup`, and then access a single node and drive

up to GLOBAL OPEN phase.

- Startup up to LOCAL OPEN: It is performed on each member node.

```
% gsql sys gliese --as sysdba
gSQL> \startup
Startup success.
```

- Startup up to OPEN: It is performed on a single node.

```
% gsql sys gliese --as sysdba
gSQL> alter system open global database;
System altered.
```

Starting up with the first method can be a burden to an operator if many nodes are included in cluster system. It is because the entire process from end of cluster system to LOCAL OPEN should be performed everytime on every member node. The following is a simple method to startup the entire member for the ease of operation.

- Startup to GLOBAL OPEN: It is performed on a single node.

```
% gsqlnet sys gliese --as sysdba
gSQL> \cstartup
Startup success.
```



- \cstartup and \cshutdown commands can be performed only in gsqlnet, and it is not supported in gsql. Also, listener should be driven beforehand on every member node to be driven.
- To build GOLDILOCKS cluster system containing multiple members on a single physical node, home directory name, member name and the cluster port information should not be duplicated when creating each database.

When GOLDILOCKS system ends, gmaster, the management daemon process, ends on each member node, so it does not allow any more connection or other database operations.

The followings are two ending modes of GOLDILOCKS cluster system.

- NORMAL: It blocks an access of a new session, waits for the termination of all sessions, performs checkpoint, then unloads the instance.
- ABORT: It immediately terminates gmaster regardless of the state of connected sessions, and unloads the instance.

If `\shutdown` command is performed by using `gsql` as follows, only the connected member node is terminated.

```
% gsql sys gliese --as sysdba
Connected to GOLDILOCKS Database.
gSQL> \shutdown normal
Shutdown success
gSQL>
```

To terminate the entire member belonging to cluster system at once, use `\cshutdown` command of `gsqlnet` as follows. The normal option can be omitted.

```
% gsqlnet sys gliese --as sysdba
Connected to GOLDILOCKS Database.
gSQL> \cshutdown normal
Shutdown success
gSQL>
```



Using abort option when performing `\cshutdown`, it terminates the entire member node by force. Therefore, some member nodes may fail to join cluster system when restarting it by using `\cstartup`. Although the failed nodes can join through the following join commands and rebalance process, it is recommended to terminate it by using `\cshutdown normal` which is a safe method.

To terminate and start a member node or some member nodes belonging to cluster system, follow the process below. The following describes how to restart only the G1N2 node among cluster member nodes then make it join cluster system.

```
% gsql sys gliese --as sysdba --dsn=g1n2
Connected to GOLDILOCKS Database.
gSQL> \shutdown normal
Shutdown success
gSQL> \startup
Startup success
gSQL> alter system join database;
System altered.
```

To restart a member node and make it rejoin cluster system, rebalancing operation for the altered table may be required if the corresponding node is terminated when a transaction occurs. If the rebalancing operation is not performed, the transaction performing on a driver node may fail to alter the table on which the rebalancing is not performed.

A rebalancing operation is a process which synchronizes data distribution policy and property information of table among member nodes, and dividedly stores table data again in each member nodes according to the data distribution policy.

```
% gsql sys gliese --as sysdba
Connected to GOLDILOCKS Database.
gSQL> \shutdown normal
Shutdown success
gSQL> \startup
Startup success
gSQL> alter system join database;
ERR-42000(16405): some tables in the database need to be rebalanced
System altered.
gSQL> alter database rebalance;
Database altered.
```

3.2 Installing GOLDBLOCKS and Creating Database

Installing and creating member database which is to be included in GOLDBLOCKS cluster system is almost as same as those in standalone system. This chapter describes only the unique feature and method used for installing and creating database of cluster system comparing to standalone system.

Configuring GOLDBLOCKS Package

The package used to configure GOLDBLOCKS cluster system is as same as those of standalone database. However, the scripts to build dictionary and performance view are divided into the script for standalone system and the script for cluster system. Therefore, a user should use the appropriate script for the purpose to build the information after creating the database.

The script for standalone database is located below the `$GOLDBLOCKS_HOME/admin/standalone` directory and the script for cluster system is located below the `$GOLDBLOCKS_HOME/admin/cluster` directory.

Table 3-2 admin/standalone directory

File name	Description
README	Read me
DictionarySchema.sql	It is the dictionary schema creation script.
InformationSchema.sql	It is the information schema creation script.
PerformanceViewSchema.sql	It is the PerformanceView schema creation script.

Table 3-3 admin/cluster directory

File name	Description
README	Read me
DictionarySchema.sql	It is the dictionary schema creation script.
InformationSchema.sql	It is the information schema creation script.
PerformanceViewSchema.sql	It is the PerformanceView schema creation script.

Installing GOLDBLOCKS Software

GOLDBLOCKS software should be installed on every member node belonging to cluster system, and the installing method is as same as that of standalone system. The method for setting and checking kernel parameter, setting environment variable are as same as those of standalone system, so refer to the corresponding tutorial.

In this case, be cautious that setting properties for each cluster member node, database name, database version, character set, time zone should be same for the normal operation of cluster system.

Creating Database

Use gcreatedb utility to create database on each member node configuring cluster system like as standalone system.

The following options of gcreatedb are used only when creating cluster database. Other options are same as standalone system.

Table 3-4 Execution arguments of gcreatedb

Argument	Description
--cluster	It represents that it is cluster database. When it is omitted, standalone database is created.
--member	The member name of local database to be used in cluster system. When it is omitted, it uses the value set in LOCAL_CLUSTER_MEMBER property.
--host	IP address of local member to be used for communication between cluster system members. If it is omitted, it uses the value set in LOCAL_CLUSTER_MEMBER_HOST property.
--port	TCP listen port of local member to be used for communication between cluster system members If it is omitted, it uses the value set in LOCAL_CLUSTER_MEMBER_PORT property.

The following is an example of creating database to be used in cluster system.

```
[SHELL]> gcreatedb --cluster
Database created
[SHELL]> gcreatedb --cluster --member=G1N1
Database created
[SHELL]> gcreatedb --cluster --member=G1N1 --host=127.0.0.1 --port 10101
Database created
[SHELL]> gcreatedb --cluster \
--db_name="TEST_DB" \
--home=$GOLDILOCKS_DATA \
--host=127.0.0.1 \
--port=10101 \
--db_comment="g1n1 db comment" \
--timezone="+09:00" \
--character_set="UHC" \
--char_length_units="OCTETS"
```

```
Database created
```

```
[SHELL]> ls $GOLDILOCKS_DATA/db
system_data.dbf  system_dict.dbf  system_trans.dbf  system_undo.dbf
```

Building Dictionary Schema Information

To normally use cluster system, the dictionary schema information should be built like as standalone system. If the following schema is not built, the catalog API (e.g. SQLTables() function) of ODBC, JDBC obtaining object's structure information malfunctions, then it can not interwork with the third party tools. In conclusion, it should be built after creating database.

It is recommended to build schema in cluster system after completing the operation of creating a cluster group and a member. It is because GOLDILOCKS automatically creates schema on every member node when performing creation script by connecting to a member node after completing cluster system configuration.

- **DICTIONARY_SCHEMA**: It consists of tables and views inquiring object information such as DBA_*, ALL_*, USER_*.
- **INFORMATION_SCHEMA**: It consists of tables and views included in the SQL standard INFORMATION_SCHEMA.
- **PERFORMANCE_VIEW_SCHEMA**: It consists of views inquiring system information combining information of fixed tables.

The followings describe how to build schema by using the script for cluster system. Perform the operation by accessing to a single member node in GLOBAL OPEN phase as described above.

```
% gsql sys gliese --as sysdba --import $GOLDILOCKS_HOME/admin/cluster/DictionarySchema.sql
% gsql sys gliese --as sysdba --import $GOLDILOCKS_HOME/admin/cluster/InformationSchema.sql
% gsql sys gliese --as sysdba --import
$GOLDILOCKS_HOME/admin/cluster/PerformanceViewSchema.sql
```

Various structure information can be viewed by using the schema information built above. What is different from standalone system is that a user can extract only the desired node information by giving group name and member node after the object when inquiring the information.

```
% gsql test test
Connected to GOLDILOCKS Database.
gSQL> select origin_member_name, stat_name, stat_value
2   from gv$system_mem_stat
3  where stat_name = 'PLAN_CACHE_TOTAL_SIZE';
ORIGIN_MEMBER_NAME  STAT_NAME          STAT_VALUE
```



```

-----
G1N1          PLAN_CACHE_TOTAL_SIZE  17844952
G2N2          PLAN_CACHE_TOTAL_SIZE  16796288
G2N1          PLAN_CACHE_TOTAL_SIZE  16796288
G1N2          PLAN_CACHE_TOTAL_SIZE  16796288
G3N1          PLAN_CACHE_TOTAL_SIZE  16796288
G3N2          PLAN_CACHE_TOTAL_SIZE  16796288

```

6 rows selected.

```

gSQL> select origin_member_name, stat_name, stat_value
      2   from gv$system_mem_stat@g1n2
      3   where stat_name = 'PLAN_CACHE_TOTAL_SIZE';

```

```

ORIGIN_MEMBER_NAME  STAT_NAME          STAT_VALUE
-----
G1N2                PLAN_CACHE_TOTAL_SIZE  16796288

```

1 row selected.

```

gSQL> select origin_member_name, stat_name, stat_value
      2   from gv$system_mem_stat@g1
      3   where stat_name = 'PLAN_CACHE_TOTAL_SIZE';

```

```

ORIGIN_MEMBER_NAME  STAT_NAME          STAT_VALUE
-----
G1N1                PLAN_CACHE_TOTAL_SIZE  17844952
G1N2                PLAN_CACHE_TOTAL_SIZE  16796288

```

2 row selected.

3.3 Managing Schema Object

The schema object is a logical structure created by a user. GOLDDILOCKS cluster system supports the schema objects such as table, index and global sequence. This chapter describes features of each schema object in cluster system comparing to standalone system. How to efficiently manage them is also described.

Managing Table

A user can specify one of four following sharding strategies as an option when creating a table in GOLDDILOCKS cluster system. Sharding strategy is how to distribute and store table data to each cluster group in cluster system. This option can be specified only in cluster system, and it can not be used when database is created as standalone.

- Cloned strategy
 - It equally copies entire table data.
- Hash sharding strategy
 - It distributes table data based on the hash value of sharding key.
- Range sharding strategy
 - It distributes table data based on the range value of sharding key.
- List sharding strategy
 - It distributes table data based on the list value of sharding key.

For more information about creating table, refer to **CREATE TABLE** and **Cluster Table and Shard**.

When omitting the sharding strategy option, it is defined by **DEFAULT_SHARDING** property. The default value of **DEFAULT_SHARDING** is 0, and it creates cloned table.

```
CREATE TABLE t1
(
  id    INTEGER,
  name  VARCHAR(128)
);
```

If a table is created without giving the sharding strategy by as user as above, then GOLDDILOCKS cluster system internally creates a table by using the following syntax.

```
CREATE TABLE t1
(
  id    INTEGER,
```

```

name VARCHAR(128)
)
CLONED
AT CLUSTER WIDE
;

```



Hash/Range/List sharded table should comply with the followings when creating constraints.
- PRIMARY KEY, UNIQUE constraint should include the sharding key.

Cloned Strategy

It does not distribute the table data based on a specific condition, but it copies all data. The target of copying data can be all nodes in cluster system, or it can be a specific cluster group. In other words, it arranges clones in cluster members of a defined cluster group.

- AT CLUSTER WIDE
 - It arranges clones in all cluster members of all cluster group in cluster system.
 - When adding a cluster group or cluster member, a user can rearranges clones by using **ALTER TABLE name REBALANCE** statement.
- AT CLUSTER GROUP group_list
 - It arranges clones in all cluster members of a defines cluster group.
 - When adding a cluster member to a defined cluster group, a user can rearranges clones by using **ALTER TABLE name REBALANCE** statement.
 - Adding cluster group does not affect the rearrangement of clones.

When the option is omitted, the default value is automatically set to *AT CLUSTER WIDE*.

```

CREATE TABLE t1
(
id INTEGER,
name VARCHAR(128)
)
CLONED
AT CLUSTER WIDE;

```

```

CREATE TABLE t1
(
id INTEGER,
name VARCHAR(128)
)
CLONED

```

```
AT CLUSTER GROUP G1, G2;
```

Hash Sharding Strategy

It distributes the table data based on the hash value of a column defined as a sharding key.

To use hash sharding strategy, sharding key should be defined complying with the following conditions.

- Up to 32 columns can be listed.
- The duplicated column can not be used.
- The column of LONG VARCHAR or LONG VARBINARY type can not be used.

```
CREATE TABLE t1 ( id INTEGER, name VARCHAR(128) )
    SHARDING BY HASH(id);
```

When hash sharding related options are omitted as above, GOLDDILOCKS system interprets it as follows.

```
CREATE TABLE t1 ( id INTEGER, name VARCHAR(128) )
    SHARDING BY HASH(id)
    SHARD COUNT 24
    AT CLUSTER WIDE;
```

Table rows are distributed to one of 24 shards based on hash value of id column, and 24 shards are equally arranged over the entire cluster system. For more information, refer to **Cluster Table and Shard**.

Range Sharding Strategy

It distributes the table data based on the range value of the column defined as a sharding key. The shards are classified based on each range value, and they can be arranged by defining a specific group, or arranged as CLUSTER WIDE.

The following is a syntax of defining six range shards based on the range value of the sharding key column, and creating a table to distribute them as CLUSTER WIDE. If a cluster group is created after creating a table, the rearrangement of shard containing the created group can be performed by using REBALANCE feature.

- Create a range sharded table.
- Arrange six shards in existing cluster groups (g1, g2, g3).

```
CREATE TABLE t1
(
    id    INTEGER,
    name  VARCHAR(32)
```

```

)
SHARDING BY RANGE (id)
  AT CLUSTER WIDE
  SHARD s1 VALUES LESS THAN ( 200000 ),
  SHARD s2 VALUES LESS THAN ( 400000 ),
  SHARD s3 VALUES LESS THAN ( 500000 ),
  SHARD s4 VALUES LESS THAN ( 600000 ),
  SHARD s5 VALUES LESS THAN ( 800000 ),
  SHARD s6 VALUES LESS THAN ( MAXVALUE )
;

```

- Add a cluster group.

```

CREATE CLUSTER GROUP g4
  CLUSTER MEMBER g4n1 HOST '192.168.0.41' PORT 10401
;

```

- Rearrange the range shard.
- Rearrange six shards in cluster groups (g1, g2, g3, g4) in which the added group is included.

```

ALTER TABLE t1 REBALANCE;

```

The following is a syntax of defining range shards, which are defined based on the range of sharding key column value, only to be arranged in a specific cluster group. In other words, the shard s1 whose range value is smaller than 200000 is allocated in cluster group g1, s2 is allocated in cluster group g2, and shard s3 is allocated in g3. Like as shards can not be rearranged by using REBALANCE feature even when a cluster group is added later in a table created by defining cluster group.

- Create a range sharded table.
- Allocate each range shards to defined cluster groups.

```

CREATE TABLE t1
(
  id INTEGER,
  name VARCHAR(32)
)
SHARDING BY RANGE (id)
  SHARD s1 VALUES LESS THAN ( 200000 ) AT CLUSTER GROUP g1,
  SHARD s2 VALUES LESS THAN ( 400000 ) AT CLUSTER GROUP g2,
  SHARD s3 VALUES LESS THAN ( 500000 ) AT CLUSTER GROUP g3,
  SHARD s4 VALUES LESS THAN ( 600000 ) AT CLUSTER GROUP g2,
  SHARD s5 VALUES LESS THAN ( 800000 ) AT CLUSTER GROUP g3,

```

```
SHARD s6 VALUES LESS THAN ( MAXVALUE ) AT CLUSTER GROUP g1
;
```

- Add a cluster group.

```
CREATE CLUSTER GROUP g4
    CLUSTER MEMBER g4n1 HOST '192.168.0.41' PORT 10401
;
```

- Rearrange the range shard.
- A shard is not allocated to the newly created cluster group (g4).

```
ALTER TABLE t1 REBALANCE;
```

The following conditions should be considered to specify the range sharding key.

- Up to 32 columns can be listed.
- The duplicated column can not be used.
- The column of LONG VARCHAR or LONG VARBINARY type can not be used.

List Sharding Strategy

It distributes the table data based on the list value of the column defined as a sharding key. Like as the range sharding strategy, each shard can be arranged by defining a specific group, or arranged as CLUSTER WIDE.

The followings are conditions to define the shard key in list sharding strategy.

- Only a single column can be used.
- The column of LONG VARCHAR or LONG VARBINARY type can not be used.

The following is a syntax of creating a table of which created list shards are arranged as CLUSTER WIDE. Use REBALANCE feature to rearrange shards including a cluster group created after creating a table.

- Create a list sharded table.
- Arrange five shards in existing cluster groups (g1, g2, g3).

```
CREATE TABLE city
(
    id INTEGER,
    name VARCHAR(32)
)
SHARDING BY LIST (name)
```

```

AT CLUSTER WIDE
SHARD s1 VALUES IN ( 'SEOUL' ),
SHARD s2 VALUES IN ( 'PUSAN', 'ULSAN', 'DAEGU' ),
SHARD s3 VALUES IN ( 'DAEJEON', 'GWANGJU' ),
SHARD s4 VALUES IN ( 'ANSAN', 'GOYANG' ),
SHARD s5 VALUES IN ( DEFAULT )
;

```

- Add a cluster group.

```

CREATE CLUSTER GROUP g4
    CLUSTER MEMBER g4n1 HOST '192.168.0.41' PORT 10401
;

```

- Rearrange the list shard.
- Rearrange five shards in cluster groups (g1, g2, g3, g4) in which the created group is included.

```
ALTER TABLE city REBALANCE;
```

The following is a syntax of defining list shards, which are defined based on the list value of sharding key column value, only to be arranged in a specific cluster group. Shards can not be rearranged by using REBALANCE feature even when a cluster group is created.

- Create a list sharded table.
- Allocate each range shards to defined cluster groups.

```

CREATE TABLE city
(
    id INTEGER,
    name VARCHAR(32)
)
SHARDING BY LIST (name)
    SHARD s1 VALUES IN ( 'SEOUL' ) AT CLUSTER GROUP g1,
    SHARD s2 VALUES IN ( 'PUSAN', 'ULSAN', 'DAEGU' ) AT CLUSTER GROUP g2,
    SHARD s3 VALUES IN ( 'DAEJEON', 'GWANGJU' ) AT CLUSTER GROUP g3,
    SHARD s4 VALUES IN ( 'ANSAN', 'GOYANG' ) AT CLUSTER GROUP g2,
    SHARD s5 VALUES IN ( DEFAULT ) AT CLUSTER GROUP g1
;

```

- Create a cluster group.

```
CREATE CLUSTER GROUP g4
    CLUSTER MEMBER g4n1 HOST '192.168.0.41' PORT 10401
;
```

- Rearrange the list shard.
- A shard is not allocated to the newly created cluster group (g4).

```
ALTER TABLE city REBALANCE;
```

Managing Index

Global Secondary Index

In cluster system, multiple member nodes exist, and table records are dividedly stored or duplicated based on the shard strategy. Standalone system guarantees the uniqueness of a record by storing unique value (Row Identifier: RID) in the database when the record is stored. However, in cluster system, each node can have the duplicated value, so the uniqueness can not be guaranteed.

Therefore, it is required to guarantee the uniqueness of a record in cluster system. This is a reason why global RID (GRID) is added. The GRID value of a record is not updated even when the record is updated, so it is not updated when shard key is updated then moved to another shard, then it guarantees the uniqueness of a specific record in cluster system.

Global secondary index is a B-tree index which consists of keys to search the GRID value of the records quickly in cluster system.

A user can select whether to create global secondary index through the following properties when creating a table. The user also can delete or recreate the global secondary index after table creation is completed. Only one global secondary index can be created per table.

For more information, refer to **DEFAULT_GLOBAL_SECONDARY_INDEX_CREATION**.

A global secondary index is necessary to perform the non-deterministic query for a table. If a global secondary index does not exist in a table, then a non-deterministic query fails as follows.

```
gSQL> DELETE FROM T1 LIMIT 1;
ERR-42000(16423): does not support non-deterministic DML in the cluster system : global
secondary index expected
```

Enquire **USER_GSI_PLACE** DICTIONARY, or use **ALL_GSI_PLACE** and **DBA_GSI_PLACE** dictionary to check if the global secondary index of a table is created.

```

gSQL> CREATE TABLE T1( I1 INTEGER );
Table created.
gSQL> COMMIT;
Commit complete.
gSQL> SELECT *
      2 FROM USER_GSI_PLACE@LOCAL
      3 WHERE TABLE_NAME = 'T1';
TABLE_SCHEMA TABLE_NAME GROUP_ID GROUP_NAME MEMBER_ID MEMBER_NAME MEMBER_OFFLINE
-----
BLOCKS
-----
PUBLIC      T1              1 G1              1 G1N1          FALSE
      64
PUBLIC      T1              1 G1              2 G1N2          FALSE
      null
2 rows selected.
gSQL> DROP TABLE T1;
Table dropped.
gSQL> COMMIT;
Commit complete.
gSQL> SELECT *
      2 FROM USER_GSI_PLACE@LOCAL
      3 WHERE TABLE_NAME = 'T1';
no rows selected.

```

Global Sequence

GOLDILOCKS cluster system provides global sequence object which are an expansion of the existing sequence for multiple member nodes to share and use the set of sequence value fitting into user defined conditions. In other words, the global sequence object is internally and automatically created when a user creates a sequence in cluster system, then the sequence values in a specific range are allocated and used when calling NEXTVAL on each member node. The following is a syntax of creating and using the global sequence, which are as same as those of sequence in standalone.

```

gSQL> CREATE SEQUENCE global_user_seq START WITH 1000 INCREMENT BY 1 NOCACHE NOCYCLE;
Sequence created.
gSQL> SELECT global_user_seq.NEXTVAL FROM dual;
NEXTVAL
-----

```

1

1 row selected.

gSQL> DROP SEQUENCE global_user_seq;

Sequence dropped.

Like as the sequence used in standalone, the global sequence object can define a cache size as a creating option, and this means acquiring several sequence value from the global sequence object and loading at local cache. The followings are local cache status of each member node and return values of when calling NEXTVAL, this is when creating the global sequence object by setting cache size to 5.

gSQL> CREATE SEQUENCE seq START WITH 1 CACHE 5;

Sequence created.

Member name	NEXTVAL result	The number of remaining local cache sequence		Description
		G1N1	G1N2	
G1N1	1	4	0	From Global Object (Alloc 1 ~ 5)
G1N1	2	3	0	From Local Cache
G1N1	3	2	0	From Local Cache
G1N2	6	3	4	From Global Object (Alloc 6 ~ 10)
G1N2	7	3	3	From Local Cache
G1N2	8	3	2	From Local Cache
G1N2	9	3	1	From Local Cache
G1N2	10	3	0	From Local Cache
G1N2	11	3	4	From Global Object (Alloc 11 ~ 15)
G1N2	12	3	3	From Local Cache
G1N1	4	1	3	From Local Cache
G1N1	5	0	3	From Local Cache
G1N1	16	4	3	From Global Object (Alloc 16 ~ 20)

In the table above, The sequence values are allocated to G1N1 and G1N2 two times each (four times in total) from the global sequence object. The cache option value is set to 5 when creating a sequence, so five sequence values are allocated each from the global object. Those five sequences allocated to a member node is stored in its own local cache, then it is returned one by one whenever calling NEXTVAL.

- G1N1
 - The values of five sequences (1~5) are allocated from the global sequence object when calling the first NEXTVAL.

- A single sequence is returned as a result of NEXTVAL and the values of other four sequences are loaded in its own local cache.
- NEXTVAL called later returns in turn the values of the sequences loaded in the local cache.
- G1N2
 - The values of sequences (6~10) which are after the sequences allocated on G1N1 are allocated when calling the first NEXTVAL.
 - 6 is returned as a result of NEXTVAL, and the values of other four sequences (7~10) are loaded in its own local cache.
 - NEXTVAL called later returns the sequence values loaded in the local cache.
 - Local cache is run out, so values of other five sequences (11~15) are allocated again from the global sequence object.
- G1N1
 - Local cache is run out, so the values of five sequences (16~20) after the sequences allocated last on G1N2 are allocated.

The sequence as big as the CACHE size are allocated to all member nodes when NEXTVAL has never been called on its own node or when all allocated nodes are run out. Therefore, if a system needs to acquire the sequence value quickly, it is required to set the appropriate cache size when creating a sequence to prevent too much frequent allocation. It is because, unlike standalone database, allocating sequence from the global sequence object is accompanied by the network communication cost.

The sequence values loaded in local cache can not be reused when database restarts due to a system error or operational work. The sequence values are allocated again from the global sequence object when calling NEXTVAL for the first time since the restart. Therefore, the CACHE size allocated when creating the sequence also means the range value of sequence which is possible to be lost when an error occurs, so the size should be set appropriately considering not only the corresponding feature but also loss range.

The result value of calling NEXTVAL from a specific node may not be sequential in cluster system. In the example above, the return value is not sequential when G1N1 node calls NEXTVAL. After the first allocated value(1~5) is run out, 16~20 is allocated second, so 16 is returned to a user as the next sequence value of 5. It is because a single global sequence pool is allocated competitively to multiple nodes.

The followings are features and constraints of global sequence object, comparing to the sequence for existing standalone database.

- The sign can not be modified by using INCREMENT BY option in ALTER SEQUENCE statement. (The size can be modified.)
- The duplicated value among member nodes can be returned depending on the pool size of entire sequence when using CYCLE option. Therefore, create the sequence pool big enough, considering INCREMENT BY, CACHE SIZE, and the number of cluster member nodes when CYCLE option is in need.
- The return value from a specific node may not be sequential even when an error does not occur. Of course, if only one member node calls NEXTVAL, then sequential sequence value is obtained.
- The CACHE SIZE is 1 for NOCACHE, so the additional sequence values are not loaded in local cache. In this case, only one sequence is allocated from the global sequence object whenever calling NEXTV

AL, and it increases the network cost and degrades the performance.

- Creating, updating and deleting sequences are operated as AUTO COMMIT.
- All sequence values loaded in local cache of all nodes are reset when the size of CACHE and INCREMENT are updated by ALTER statement. In other words, a new sequence set should be allocated from the global sequence object when calling NEXTVAL afterwards.

3.4 GOLDILOCKS Property

The followings are main properties used in GOLDILOCKS cluster system.

Table 3-5 Main properties of GOLDILOCKS

Name	Description
LOCAL_CLUSTER_MEMBER	Member name
LOCAL_CLUSTER_MEMBER_HOST	Host address for connecting to cluster session
LOCAL_CLUSTER_MEMBER_PORT	Port for connecting to cluster session
CDISPATCHER_THREADS	The number of cluster dispatcher threads
CSERVERS	The number of cluster server process
CLUSTER_DATA_SYNC_SERVERS	The number of cluster server process to synchronize replica data

Each property has the following two alterable scopes in GOLDILOCKS cluster system.

- LOCAL: It can alter property values not only for entire member but also for a specific member only.
- GLOBAL: It can not alter the property value only for a specific member, but it should alter the property value for all members.

For example, PRIVATE_STATIC_AREA_SIZE properties can be altered up to the LOCAL range (IS_GLOBAL column = FALSE) as follows, so the property value can be altered by using *alter system set* statement not only for entire member but also for a specific member only. If AT clause is not added to after *alter system set* statement, the altered properties are applied to all members of cluster system.

```
% gsql test test
Connected to GOLDILOCKS Database.
gSQL> select origin_member_name, property_name, property_value, is_global
  2   from gv$property
  3   where property_name = 'PRIVATE_STATIC_AREA_SIZE';
ORIGIN_MEMBER_NAME  PROPERTY_NAME                PROPERTY_VALUE  IS_GLOBAL
-----
G1N1                PRIVATE_STATIC_AREA_SIZE    104857600      FALSE
G1N2                PRIVATE_STATIC_AREA_SIZE    104857600      FALSE
2 rows selected.
gSQL> alter system set private_static_area_size = 2000000000 at g1n2;
System altered.
gSQL> select origin_member_name, property_name, property_value, is_global
  2   from gv$property
  3   where property_name = 'PRIVATE_STATIC_AREA_SIZE';
ORIGIN_MEMBER_NAME  PROPERTY_NAME                PROPERTY_VALUE  IS_GLOBAL
```

```

-----
G1N1          PRIVATE_STATIC_AREA_SIZE 104857600    FALSE
G1N2          PRIVATE_STATIC_AREA_SIZE 200000000    FALSE
2 rows selected.
gSQL> alter system set private_static_area_size = 300000000;
System altered.
gSQL> select origin_member_name, property_name, property_value, is_global
       2   from gv$property
       3  where property_name = 'PRIVATE_STATIC_AREA_SIZE';
ORIGIN_MEMBER_NAME  PROPERTY_NAME          PROPERTY_VALUE  IS_GLOBAL
-----
G1N1          PRIVATE_STATIC_AREA_SIZE 300000000    FALSE
G1N2          PRIVATE_STATIC_AREA_SIZE 300000000    FALSE
2 rows selected.

```

However, `DDL_AUTOCOMMIT` can be altered up to `GLOBAL` as follows. Therefore, an error occurs when specifying a member by using `AT` clause in `alter system set` statement.

```

% gsql test test
Connected to GOLDILOCKS Database.
gSQL> select origin_member_name, property_name, property_value, is_global
       2   from gv$property
       3  where property_name = 'DDL_AUTOCOMMIT';
ORIGIN_MEMBER_NAME  PROPERTY_NAME  PROPERTY_VALUE  IS_GLOBAL
-----
G1N1          DDL_AUTOCOMMIT NO          TRUE
G1N2          DDL_AUTOCOMMIT NO          TRUE
2 rows selected.
gSQL> alter system set ddl_autocommit = false at g1n2;
ERR-42000(16398): the domain of property does not match with domain 'G1N2' :
alter system set ddl_autocommit = false at g1n2
                                *
ERROR at line 1:
gSQL> alter system set ddl_autocommit = false;
System altered.
gSQL> select origin_member_name, property_name, property_value, is_global
       2   from gv$property
       3  where property_name = 'DDL_AUTOCOMMIT';
ORIGIN_MEMBER_NAME  PROPERTY_NAME  PROPERTY_VALUE  IS_GLOBAL
-----
G1N1          DDL_AUTOCOMMIT NO          TRUE

```

G1N2	DDL_AUTOCOMMIT NO	TRUE
------	-------------------	------

2 rows selected.

4.

What's New

4.1 Feature Matrix

This chapter briefly describes the features added to each major version.

Architecture

System Architecture

The following is a feature matrix for system architecture.

Table 4-1 Feature matrix for system architecture

Feature	1.x	2.x	3.1	3.2
Shared Nothing Cluster	X	X	O	O
DA (Direct Attach)	O	O	O	O
JDBC DA (Direct Attach)	X	X	O	O
C/S (Client/Server) Dedicated	X	O	O	O
C/S (Client/Server) Shared	X	O	O	O
multi-process applications	O	O	O	O
multi-threaded applications	O	O	O	O
Linux platform	O	O	O	O
HP platform	X	O	O	O
AIX platform	X	O	O	O
Windows Client Platform	X	O	O	O
CDC(Change Data Capture) replication	X	O	O	O
CDC replication with log mirror	X	O	O	O
multi-level start up	X	O	O	O
parallel database loading	O	O	O	O
parallel index build	X	O	O	O
SQL plan cache	X	O	O	O

Storage Internal

The following is a feature matrix for storage internal.

Table 4-2 Feature matrix for storage internal

Feature	1.x	2.x	3.1	3.2
memory dictionary tablespace	O	O	O	O
memory data tablespace	O	O	O	O
memory undo tablespace	O	O	O	O
memory temporary tablespace	X	O	O	O
memory bitmap data segment	O	O	O	O
memory bitmap undo segment	O	O	O	O
memory bitmap instant segment	X	O	O	O
memory heap table	O	O	O	O
memory instant table	X	O	O	O
memory B-tree index	O	O	O	O
memory instant B-tree	X	O	O	O
memory instant hash	X	O	O	O
global secondary index	X	X	O	O

Transaction Control

The following is a feature matrix for transaction control.

Table 4-3 Feature matrix for transaction control

Feature	1.x	2.x	3.1	3.2
CDS(Concurrency Data Store) database mode	O	O	O	O
TDS(Transactional Data Store) database mode	O	O	O	O
read-only database	X	O	O	O
read/write database	O	O	O	O
flat transaction	O	O	O	O
distributed transaction	X	O	O	O
read-only transaction	X	O	O	O
read/write transaction	O	O	O	O
READ COMMITTED isolation level	O	O	O	O
SERIALIZABLE isolation level with SELECT FOR UPDATE	O	O	O	O
MVCC(Multi Version Concurrency Control)	O	O	O	O
multi-version read consistency	O	O	O	O
multi-statement consistent read	O	O	O	O
implicit lock for DML	O	O	O	O
writer don't blocks readers	O	O	O	O
row-level locking	O	O	O	O
deadlock detection	O	O	O	O
deadlock resolution	O	O	O	O
lock granularity	O	O	O	O
read lock	O	O	O	O
write lock	O	O	O	O
intention lock	O	O	O	O
WAL(Write Ahead Logging)	O	O	O	O
repeat history	O	O	O	O
restart recovery	O	O	O	O
circular logging	O	O	O	O
buffered logging	O	O	O	O
logging group	X	O	O	O
supplemental logging	X	O	O	O
mirrored logging	X	O	O	O
synchronous commit	O	O	O	O
asynchronous commit	O	O	O	O
grouped commit	O	O	O	O
total rollback	O	O	O	O
implicit statement rollback	O	O	O	O

Feature	1.x	2.x	3.1	3.2
savepoint management	X	O	O	O

Backup & Recovery

The following is a feature matrix for backup & recovery.

Table 4-4 Feature matrix for backup & recovery

Feature	1.x	2.x	3.1	3.2
off-line backup	O	O	O	O
on-line backup	X	O	O	O
full backup	X	O	O	O
incremental backup	X	O	O	O
complete recovery	O	O	O	O
incomplete recovery	X	O	O	O
auto instance recovery	O	O	O	O
tablespace recovery	X	O	O	O
file recovery	X	O	O	O

Database Information

DICTIONARY_SCHEMA Schema

The following is a feature matrix for DICTIONARY_SCHEMA schema.

Table 4-5 Feature matrix for DICTIONARY_SCHEMA schema

Family	Feature	1.x	2.x	3.1	3.2
Views of ALL_family	ALL_ALL_TABLES	X	O	O	O
	ALL_ARGUMENTS	X	X	O	O
	ALL_CATALOG	X	O	O	O
	ALL_CLUSTER_TABLES	X	X	O	O
	ALL_COL_COMMENTS	X	O	O	O
	ALL_COL_PLACE	X	X	O	X
	ALL_COL_PRIVS	X	O	O	O
	ALL_COL_PRIVS_MADE	X	O	O	O
	ALL_COL_PRIVS_RECD	X	O	O	O
	ALL_CONSTRAINTS	X	O	O	O
	ALL_CONS_COLUMNS	X	O	O	O
	ALL_DB_PRIVS	X	O	O	O
	ALL_DB_PRIVS_MADE	X	O	O	O
	ALL_DB_PRIVS_RECD	X	O	O	O
	ALL_DEPENDENCIES	X	X	O	O
	ALL_GLOBAL_SECONDARY_INDEXES	X	X	O	O
	ALL_GSI_PLACE	X	X	O	O
	ALL_INDEXES	X	O	O	O
	ALL_IND_COLUMNS	X	O	O	O
	ALL_IND_PLACE	X	X	O	O
	ALL_NONSCHEMA_COMMENTS	X	O	O	O
	ALL_OBJECTS	X	O	O	O
	ALL_PROCEDURES	X	X	O	O
	ALL_PROC_PRIVS	X	X	O	O
	ALL_PROC_PRIV_MADE	X	X	O	O
	ALL_PROC_PRIV_RECD	X	X	O	O
	ALL_SCHEMAS	X	O	O	O
	ALL_SCHEMA_PATH	X	O	O	O
	ALL_SCHEMA_PRIVS	X	O	O	O
	ALL_SCHEMA_PRIVS_MADE	X	O	O	O
ALL_SCHEMA_PRIVS_RECD	X	O	O	O	
ALL_SEQUENCES	X	O	O	O	
ALL_SEQ_PRIVS	X	O	O	O	

Family	Feature	1.x	2.x	3.1	3.2
	ALL_SEQ_PRIVS_MADE	X	O	O	O
	ALL_SEQ_PRIVS_REC'D	X	O	O	O
	ALL_SHARD_KEY_COLUMNS	X	X	O	O
	ALL_SOURCE	X	X	O	O
	ALL_SYNONYMS	X	O	O	O
	ALL_TABLES	X	O	O	O
	ALL_TAB_COLS	X	O	O	O
	ALL_TAB_COLUMNS	X	O	O	O
	ALL_TAB_COMMENTS	X	O	O	O
	ALL_TAB_IDENTITY_COLS	X	O	O	O
	ALL_TAB_PLACE	X	X	X	O
	ALL_TAB_SHARDS	X	X	O	O
	ALL_TAB_PRIVS	X	O	O	O
	ALL_TAB_PRIVS_MADE	X	O	O	O
	ALL_TAB_PRIVS_REC'D	X	O	O	O
	ALL_TBS_PRIVS	X	O	O	O
	ALL_TBS_PRIVS_MADE	X	O	O	O
	ALL_TBS_PRIVS_REC'D	X	O	O	O
	ALL_USERS	X	O	O	O
	ALL_VIEWS	X	O	O	O
	DBA_ALL_TABLES	X	O	O	O
	DBA_ARGUMENTS	X	X	O	O
	DBA_CATALOG	X	O	O	O
	DBA_CLUSTER	X	X	O	O
	DBA_CLUSTER_COMMENTS	X	X	O	O
	DBA_CLUSTER_TABLES	X	X	O	O
	DBA_COL_COMMENTS	X	O	O	O
	DBA_COL_PLACE	X	X	O	X
	DBA_COL_PRIVS	X	O	O	O
	DBA_CONSTRAINTS	X	O	O	O
	DBA_CONS_COLUMNS	X	O	O	O
	DBA_DB_PRIVS	X	O	O	O
	DBA_DEPENDENCIES	X	X	O	O
	DBA_EXTENTS	X	O	O	O
	DBA_GLOBAL_SECONDARY_INDEXES	X	X	O	O
	DBA_GSI_PLACE	X	X	O	O
	DBA_INDEXES	X	O	O	O
	DBA_IND_COLUMNS	X	O	O	O
	DBA_IND_PLACE	X	X	O	O
	DBA_NONSCHEMA_COMMENTS	X	O	O	O

Family	Feature	1.x	2.x	3.1	3.2
Views of DBA_family	DBA_OBJECTS	X	O	O	O
	DBA_PROCEDURES	X	X	O	O
	DBA_PROC_PRIVS	X	X	O	O
	DBA_PROFILES	X	O	O	O
	DBA_SCHEMAS	X	O	O	O
	DBA_SCHEMA_PATH	X	O	O	O
	DBA_SCHEMA_PRIVS	X	O	O	O
	DBA_SEQUENCES	X	O	O	O
	DBA_SEQ_PRIVS	X	O	O	O
	DBA_SHARD_KEY_COLUMNS	X	X	O	O
	DBA_SOURCE	X	X	O	O
	DBA_STAT_SYSTEM	X	X	O	O
	DBA_SYNONYMS	X	O	O	O
	DBA_SYS_PRIVS	X	O	O	O
	DBA_TABLES	X	O	O	O
	DBA_TABLESPACES	X	O	O	O
	DBA_TAB_COLS	X	O	O	O
	DBA_TAB_COLUMNS	X	O	O	O
	DBA_TAB_COMMENTS	X	O	O	O
	DBA_TAB_IDENTITY_COLS	X	O	O	O
	DBA_TAB_PLACE	X	X	O	O
	DBA_TAB_PRIVS	X	O	O	O
	DBA_TAB_SHARDS	X	X	O	O
	DBA_TBS_PRIVS	X	O	O	O
	DBA_USERS	X	O	O	O
	DBA_VIEWS	X	O	O	O
	USER_ALL_TABLES	X	O	O	O
	USER_ARGUMENTS	X	X	O	O
	USER_CATALOG	X	O	O	O
	USER_CLUSTER_TABLES	X	X	O	O
	USER_COL_COMMENTS	X	O	O	O
	USER_COL_PLACE	X	X	O	X
	USER_COL_PRIVS	X	O	O	O
	USER_COL_PRIVS_MADE	X	O	O	O
	USER_COL_PRIVS_RECD	X	O	O	O
	USER_CONSTRAINTS	X	O	O	O
	USER_CONS_COLUMNS	X	O	O	O
	USER_DEPENDENCIES	X	X	O	O
	USER_EXTENTS	X	O	O	O
	USER_GLOBAL_SECONDARY_INDEXES	X	X	O	O

Family	Feature	1.x	2.x	3.1	3.2
Views of USER_family	USER_GSI_PLACE	X	X	O	O
	USER_INDEXES	X	O	O	O
	USER_IND_COLUMNS	X	O	O	O
	USER_IND_PLACE	X	X	O	O
	USER_OBJECTS	X	O	O	O
	USER_PROCEDURES	X	X	O	O
	USER_PROC_PRIVS	X	X	O	O
	USER_PROC_PRIVS_MADE	X	X	O	O
	USER_PROC_PRIVS_RECD	X	X	O	O
	USER_SCHEMAS	X	O	O	O
	USER_SCHEMA_PATH	X	O	O	O
	USER_SCHEMA_PRIVS	X	O	O	O
	USER_SCHEMA_PRIVS_MADE	X	O	O	O
	USER_SCHEMA_PRIVS_RECD	X	O	O	O
	USER_SEQUENCES	X	O	O	O
	USER_SEQ_PRIVS	X	O	O	O
	USER_SEQ_PRIVS_MADE	X	O	O	O
	USER_SEQ_PRIVS_RECD	X	O	O	O
	USER_SHARD_KEY_COLUMNS	X	X	O	O
	USER_SOURCE	X	X	O	O
	USER_SYNONYMS	X	O	O	O
	USER_SYS_PRIVS	X	O	O	O
	USER_TABLES	X	O	O	O
	USER_TABLESPACES	X	O	O	O
	USER_TAB_COLS	X	O	O	O
	USER_TAB_COLUMNS	X	O	O	O
	USER_TAB_COMMENTS	X	O	O	O
	USER_TAB_IDENTITY_COLS	X	O	O	O
	USER_TAB_PLACE	X	X	O	O
	USER_TAB_PRIVS	X	O	O	O
	USER_TAB_PRIVS_MADE	X	O	O	O
USER_TAB_PRIVS_RECD	X	O	O	O	
USER_TAB_SHARDS	X	X	O	O	
USER_USERS	X	O	O	O	
USER_VIEWS	X	O	O	O	
	AUDIT_POLICIES	X	X	X	O
	AUDIT_POLICY_ENABLED	X	X	X	O
	AUDIT_POLICY_OPTIONS	X	X	X	O
	AUDIT_TRAIL	X	X	X	O
	DATABASE_PROPERTIES	X	O	O	O

Family	Feature	1.x	2.x	3.1	3.2
Other views	DBC_TABLE_TYPE_INFO	X	O	O	O
	DICTIONARY	X	O	O	O
	DICT_COLUMNS	X	O	O	O
	IMPLEMENTATION_INFO	X	O	O	O
	IMPLEMENTATION_INFO_BASE	X	O	O	O
	JDBC_CLIENT_PROPS	X	O	O	O
	PRODUCT	X	O	O	O
	SESSION_PRIVS	X	O	O	O
	SUPPLEMENTAL_LOG_TABLE_INFO	X	O	O	O
Aliased Synonym	COLS	X	O	O	O
	DICT	X	O	O	O
	IND	X	O	O	O
	OBJ	X	O	O	O
	SEQ	X	O	O	O
	TABS	X	O	O	O

INFORMATION_SCHEMA Schema

The following is a feature matrix for INFORMATION_SCHEMA schema.

Table 4-6 Feature matrix for INFORMATION_SCHEMA schema

Feature	1.x	2.x	3.1	3.2
COLUMNS	X	O	O	O
COLUMN_PRIVILEGES	X	O	O	O
CONSTRAINT_COLUMN_USAGE	X	O	O	O
CONSTRAINT_TABLE_USAGE	X	O	O	O
INFORMATION_SCHEMA_CATALOG_NAME	X	O	O	O
KEY_COLUMN_USAGE	X	O	O	O
PARAMETERS	X	X	O	O
REFERENTIAL_CONSTRAINTS	X	O	O	O
ROUTINES	X	X	O	O
ROUTINE_PRIVILEGES	X	X	O	O
ROUTINE_ROUTINE_USAGE	X	X	O	O
ROUTINE_SEQUENCE_USAGE	X	X	O	O
ROUTINE_TABLE_USAGE	X	X	O	O
SCHEMATA	X	O	O	O
SEQUENCES	X	O	O	O
SQL_FEATURES	X	O	O	O
SQL_IMPLEMENTATION_INFO	X	O	O	O
SQL_PACKAGES	X	O	O	O

Feature	1.x	2.x	3.1	3.2
SQL_PARTS	X	O	O	O
SQL_SIZING	X	O	O	O
STATISTICS	X	O	O	O
TABLES	X	O	O	O
TABLE_CONSTRAINTS	X	O	O	O
TABLE_PRIVILEGES	X	O	O	O
USAGE_PRIVILEGES	X	O	O	O
VIEWS	X	O	O	O
VIEW_ROUTINE_USAGE	X	X	O	O
VIEW_TABLE_USAGE	X	O	O	O

PERFORMANCE_VIEW_SCHEMA Schema

The following is a feature matrix for PERFORMANCE_VIEW_SCHEMA schema.

Table 4-7 Feature matrix for PERFORMANCE_VIEW_SCHEMA schema

Feature	1.x	2.x	3.1	3.2
GV\$_____	X	X	O	O
V\$AGABLE_INFO	X	X	O	O
V\$ARCHIVELOG	X	O	O	O
V\$AUDITABLE_DB_PRIVILEGES	X	X	X	O
V\$AUDITABLE_SYSTEM_ACTIONS	X	X	X	O
V\$BACKUP	X	O	O	O
V\$BALANCER	X	O	O	O
V\$CLUSTER_DISPATCHER	X	X	O	O
V\$CLUSTER_LOCATION	X	X	O	O
V\$CLUSTER_MEMBER	X	X	O	O
V\$COLUMNS	X	O	O	O
V\$CONTROLFILE	X	O	O	O
V\$DATAFILE	X	O	O	O
V\$DB_FILE	X	O	O	O
V\$DISPATCHER	X	O	O	O
V\$ERROR_CODE	X	O	O	O
V\$GLOBAL_TRANSACTION	X	O	O	O
V\$JOURNALING	X	X	O	O
V\$INCREMENTAL_BACKUP	X	O	O	O
V\$INSTANCE	X	O	O	O
V\$KEYWORDS	X	O	O	O
V\$LATCH	X	O	O	O
V\$LOCK_WAIT	X	O	O	O

Feature	1.x	2.x	3.1	3.2
V\$LOGFILE	X	O	O	O
V\$PROCESS_MEM_STAT	X	O	O	O
V\$PROCESS_SQL_STAT	X	O	O	O
V\$PROCESS_STAT	X	O	O	O
V\$PROPERTY	X	O	O	O
V\$PSM_RESERVED_WORDS	X	X	O	O
V\$QUEUE	X	O	O	O
V\$RESERVED_WORDS	X	O	O	O
V\$SESSION	X	O	O	O
V\$SESSION_AUDIT	X	X	X	O
V\$SESSION_CONNECT_INFO	X	O	O	O
V\$SESSION_EVENT	X	X	O	O
V\$SESSION_MEM_STAT	X	O	O	O
V\$SESSION_SQL_STAT	X	O	O	O
V\$SESSION_STAT	X	O	O	O
V\$SESSION_WAIT	X	X	O	O
V\$SHARED_MODE	X	O	O	O
V\$SHARED_SERVER	X	O	O	O
V\$SHM_SEGMENT	X	O	O	O
V\$SPROPERTY	X	O	O	O
V\$SQLFN_METADATA	X	O	O	O
V\$SQL_CACHE	X	O	O	O
V\$SQL_COMMAND	X	X	O	O
V\$SQL_HISTORY	X	X	O	O
V\$STATEMENT	X	O	O	O
V\$SYSTEM_EVENT	X	X	O	O
V\$SYSTEM_MEM_STAT	X	O	O	O
V\$SYSTEM_SQL_STAT	X	O	O	O
V\$SYSTEM_STAT	X	O	O	O
V\$TABLES	X	O	O	O
V\$TABLESPACE	X	O	O	O
V\$TABLESPACE_STAT	X	X	O	O
V\$TRANSACTION	X	O	O	O
V\$WAIT_EVENT_CLASS_NAME	X	X	O	O
V\$WAIT_EVENT_NAME	X	X	O	O
V\$XA_TRANSATION	X	X	O	O

Server Property

The following is a feature matrix for server property.

Table 4-8 Feature matrix for server property

Feature	1.x	2.x	3.1	3.2
AGING_INTERVAL	O	O	O	O
AGING_PLAN_INTERVAL	X	O	O	O
ARCHIVELOG_DIR	O	O	X	X
ARCHIVELOG_DIR_1 ~ DIR_10	X	O	O	O
ARCHIVELOG_FILE	X	O	O	O
ARCHIVELOG_MODE	X	O	O	O
BACKUP_DIR_1 ~ DIR_10	X	O	O	O
BLOCK_READ_COUNT	O	O	O	O
BULK_IO_PAGE_COUNT	X	O	O	O
CDISPATCHER_HOT_POLICY_INTERVAL	X	X	O	O
CDISPATCHER_SOCKET_BUFFER_SIZE	X	X	O	O
CDISPATCHER_THREADS	X	X	O	O
CHAR_LENGTH_UNITS	X	O	O	O
CHARACTER_SET	X	O	O	O
CHECK_DEDICATE_CONNECTION_INTERVAL	X	X	O	O
CHECK_DEDICATE_SOCKET	X	X	O	X
CLIENT_MAX_COUNT	O	O	O	O
CLIENT_NUMA_POLICY	X	X	O	O
CLOSE_PSM_CHILD_STMTS	X	X	O	O
CLUSTER_ASYNC_COMMIT	X	X	O	O
CLUSTER_ASYNC_REPLICATION	X	X	O	O
CLUSTER_CM_BUFFER_COUNT	X	X	O	O
CLUSTER_CM_BUFFER_SIZE	X	X	O	O
CLUSTER_CM_READ_BUFFER_SIZE	X	X	O	O
CLUSTER_COMMIT_SLAVES	X	X	O	O
CLUSTER_COMMIT_STREAM_ISOLATION	X	X	O	O
CLUSTER_CONNECTION	X	X	O	O
CLUSTER_CONNECTION_TIMEOUT_SEC	X	X	O	O
CLUSTER_DATA_SYNC_SERVERS	X	X	O	O
CLUSTER_DISPATCHER_IN_QUEUE_SIZE	X	X	O	O
CLUSTER_DISPATCHER_NUMA_STREAM_MAP	X	X	O	O
CLUSTER_DISPATCHER_OUT_QUEUE_SIZE	X	X	O	O
CLUSTER_HEARTBEAT_INTERVAL	X	X	O	O
CLUSTER_HEARTBEAT_RETRY_COUNT	X	X	O	O
CLUSTER_IGNORE_INACTIVE_MEMBER	X	X	O	O

Feature	1.x	2.x	3.1	3.2
CLUSTER_MAX_PACKET_SIZE	X	X	O	O
CLUSTER_MAX_PAYLOAD_SIZE	X	X	O	O
CLUSTER_PACKET_ALLOCATION_TIMEOUT	X	X	O	O
CLUSTER_SERVER_RESPONSE_QUEUE_SIZE	X	X	O	O
CLUSTER_SPLIT_BRAIN_RESOLUTION_POLICY	X	X	O	O
CLUSTER_SPLIT_BRAIN_RETRY_COUNT	X	X	O	O
COMMITTER_HOT_POLICY_INTERVAL	X	X	O	O
CONTROL_FILE_0 ~ FILE_7	X	O	O	O
CONTROL_FILE_COUNT	X	O	O	O
CONTROL_FILE_TEMP_NAME	X	O	O	O
COORDINATOR_COMMIT_WRITE_MODE	X	X	O	O
CSERVERS	X	X	O	O
DA_CLIENT_NUMA_MODE	X	X	O	O
DATA_STORE_MODE	O	O	O	O
DATABASE_ACCESS_MODE	X	O	O	O
DATABASE_INSTANCE_NAME	X	X	O	O
DDL_AUTOCOMMIT	X	O	O	O
DDL_LOCK_TIMEOUT	O	O	O	O
DEFAULT_GLOBAL_SECONDARY_INDEX_CREATION	X	X	O	O
DEFAULT_INDEX_LOGGING	X	O	O	O
DEFAULT_INDEX_PCTFREE	X	X	O	O
DEFAULT_INITRANS	O	O	O	O
DEFAULT_MAXTRANS	O	O	O	O
DEFAULT_PCTFREE	O	O	O	O
DEFAULT_PCTUSED	O	O	O	O
DEFAULT_REMOVAL_BACKUP_FILE	X	O	O	O
DEFAULT_REMOVAL_OBSOLETE_BACKUP_LIST	X	O	O	O
DEFAULT_SHARDING	X	X	O	O
DISABLE_DDL_CDC_GIVEUP	X	O	O	O
DISABLE_UPDATE_PK_CDC_GIVEUP	X	O	O	O
DISALLOWED_PROTOCOL_TARGETTYPE	X	X	O	O
DISALLOWED_PROTOCOL_TARGETTYPE_WITH_ALL	X	X	X	O
DISALLOWED_PROTOCOL_TARGETTYPE_WITH_NAME	X	X	O	O
DISPATCHERS	X	O	O	O
DISPATCHER_CM_BUFFER_SIZE	X	O	O	O
DISPATCHER_CM_UNIT_SIZE	X	O	O	O
DISPATCHER_CONNECTIONS	X	O	O	O
DISPATCHER_HOT_POLICY_INTERVAL	X	X	O	O
DISPATCHER_LOAD_BALANCING	X	X	O	O
DISPATCHER_NUMA_STREAM_MAP	X	X	O	O

Feature	1.x	2.x	3.1	3.2
DISPATCHER_QUEUE_SIZE	X	O	O	O
DISPATCHER_REQUEST_MINI_QUEUE_COUNT	X	X	O	O
DISPATCHER_RESPONSE_MINI_QUEUE_COUNT	X	X	O	O
FETCH_FAILOVER	X	X	O	O
GLOBAL_CONNECTION_ALLOW_SESSION_DEPENDENCY	X	X	X	O
GLOBAL_JOURNAL_BUFFER_SIZE	X	X	O	O
GLOBAL_JOURNAL_BUFFER_TOTAL_MAX_SIZE	X	X	O	O
GLOBAL_PROPERTY_LOCK_TIMEOUT	X	X	O	O
GLOBAL_TRANSACTION_COMMIT_WRITE_MODE	X	X	O	O
GLOBAL_TRANSACTION_ISOLATION_SCOPE	X	X	O	O
GLOBAL_TRANSACTION_LOG_DIR	X	X	O	O
GLOBAL_TRANSACTION_LOG_FILE_SIZE	X	X	O	O
GMASTER_NUMA_NODE	X	X	O	O
GMON_AUTOSTART	X	X	O	O
HINT_ERROR	X	O	O	O
IDLE_TIMEOUT	O	O	O	O
IN_DOUBT_DECISION	X	O	O	O
INDEX_BUILD_PARALLEL_FACTOR	X	O	O	O
INDEX_TREE_MERGE_PARALLEL_FACTOR	X	X	O	O
INST_ALLOCATOR_COUNT	X	X	O	O
INST_TABLE_BLOCK_SIZE	X	X	O	O
JOURNAL_TEMP_DIR	X	X	O	O
KEEPALIVE_IDLE_TIME	X	O	O	O
LOCAL_CLUSTER_MEMBER	X	X	O	O
LOCAL_CLUSTER_MEMBER_HOST	X	X	O	O
LOCAL_CLUSTER_MEMBER_PORT	X	X	O	O
LOCAL_JOURNAL_BUFFER_SIZE	X	X	O	O
LOCATION_FILE	X	X	O	O
LOCATOR_QUERY_TIMEOUT	X	X	O	O
LOCK_HASH_TABLE_SIZE	X	O	O	O
LOG_BLOCK_SIZE	O	O	O	O
LOG_BUFFER_SIZE	O	O	O	O
LOG_DIR	O	O	O	O
LOG_FILE_SIZE	O	O	O	O
LOG_GROUP_COUNT	O	O	O	O
LOG_MIRROR_MODE	X	O	O	O
LOG_MIRROR_SHARED_MEMORY_STATIC_SIZE	X	O	O	O
LOG_MIRROR_TIMEOUT	X	O	O	O
LOG_SYNC_INTERVAL	X	O	O	O
LOG_SYNC_INTERVAL_MSEC	X	X	O	O

Feature	1.x	2.x	3.1	3.2
MAX_GROUP_COUNT	X	X	O	O
MAX_JOURNAL_FILE_SIZE	X	X	O	O
MAX_NODE_COUNT	X	X	O	O
MAXIMUM_CONCURRENT_ACTIVITIES	X	O	O	O
MAXIMUM_FLANGE_COUNT	X	X	O	O
MAXIMUM_FLUSH_LOG_BLOCK_COUNT	O	O	O	O
MAXIMUM_FLUSH_PAGE_COUNT	O	O	O	O
MAXIMUM_JOURNAL_REPLAY_COUNT	X	X	X	O
MAXIMUM_NAMED_CURSOR_COUNT	X	O	O	O
MAXIMUM_SESSION_CM_BUFFER_SIZE	X	O	O	O
MEASURE_CLUSTER_LATENCY	X	X	O	O
MEDIA_RECOVERY_LOG_BUFFER_SIZE	X	O	X	X
MEMORY_MERGE_RUN_COUNT	X	O	O	O
MEMORY_SORT_RUN_SIZE	X	O	O	O
MIN_SAMPLE_ROW_COUNT	X	X	O	O
MINIMUM_UNDO_PAGE_COUNT	O	O	O	O
NET_BUFFER_SIZE	X	O	O	O
NLS_DATE_FORMAT	X	O	O	O
NLS_TIME_FORMAT	X	O	O	O
NLS_TIME_WITH_TIME_ZONE_FORMAT	X	O	O	O
NLS_TIMESTAMP_FORMAT	X	O	O	O
NLS_TIMESTAMP_WITH_TIME_ZONE_FORMAT	X	O	O	O
NUMA	X	X	O	O
NUMA_MAP	X	X	O	O
OFFLINE_MEMBER_AFTER_FAILOVER	X	X	O	O
ONLINE_JOURNAL_REPLAY_THRESHOLD	X	X	X	O
OS_GROUP_ACCESS	X	X	O	O
PACKET_COMPRESSION_THRESHOLD	X	X	X	O
PAGE_CHECKSUM_TYPE	X	O	O	O
PARALLEL_IO_FACTOR	O	O	O	O
PARALLEL_IO_GROUP_1 ~ GROUP_16	O	O	O	O
PARALLEL_LOAD_FACTOR	O	O	O	O
PENDING_LOG_BUFFER_COUNT	O	O	O	O
PLAN_CACHE	X	O	O	O
PLAN_CACHE_SIZE	X	O	O	O
PRIVATE_STATIC_AREA_SIZE	X	O	O	O
PROCESS_MAX_COUNT	O	O	O	O
QUERY_TIMEOUT	O	O	O	O
READABLE_ARCHIVELOG_DIR_COUNT	X	O	O	O
READABLE_BACKUP_DIR_COUNT	X	O	O	O

Feature	1.x	2.x	3.1	3.2
REBALANCE_BLOCK_READ_COUNT	X	X	O	O
RECOMPILE_CHECK_MINIMUM_PAGE_COUNT	X	O	O	X
RECOMPILE_PAGE_PERCENT	X	O	O	X
RECOVERY_LOG_BUFFER_SIZE	X	X	O	O
REDO_LOG_COMPRESSION_THRESHOLD	X	X	X	O
REFINE_RELATION	X	O	O	O
SESSION_FATAL_BEHAVIOR	X	O	O	O
SESSION_MEMORY_INIT_SIZE	X	X	X	O
SESSION_MEMORY_SHRINK_THRESHOLD	X	X	X	O
SHARED_MEMORY_ADDRESS	O	O	O	O
SHARED_MEMORY_STATIC_KEY	O	O	O	O
SHARED_MEMORY_STATIC_NAME	O	O	O	O
SHARED_MEMORY_STATIC_SIZE	O	O	O	O
SHARED_REQUEST_QUEUE_COUNT	X	O	O	O
SHARED_SERVERS	X	O	O	O
SHARED_SESSION	X	O	O	O
SNAPSHOT_STATEMENT_TIMEOUT	X	O	O	O
SQL_HISTORY_SIZE	X	X	O	O
SUPPLEMENTAL_LOG_DATA_PRIMARY_KEY	X	O	O	O
SYSTEM_LOGGER_DIR	X	O	O	O
SYSTEM_MEMORY_AUX_TABLESPACE_SIZE	X	X	X	O
SYSTEM_MEMORY_DATA_TABLESPACE_SIZE	O	O	O	O
SYSTEM_MEMORY_DICT_TABLESPACE_SIZE	O	O	O	O
SYSTEM_MEMORY_TEMP_TABLESPACE_SIZE	O	O	O	O
SYSTEM_MEMORY_UNDO_TABLESPACE_SIZE	O	O	O	O
SYSTEM_TABLESPACE_DIR	O	O	O	O
SYSTEM_UDS_DIR	X	X	O	O
TCP_NODELAY	X	X	O	O
TEMP_SEGMENT_CACHE_SIZE	X	X	X	O
TEMP_UNDO_ENABLED	X	X	X	O
TIMED_STATISTICS	X	X	O	O
TIMER_INTERVAL	O	O	X	X
TIMEZONE	X	O	O	O
TRACE_ALTER_SYSTEM	X	O	O	O
TRACE_DDL	O	O	O	O
TRACE_LOG_ID	X	O	O	O
TRACE_LOG_MSGBUG_SIZE	X	X	O	O
TRACE_LOG_TIME_DETAIL	X	O	O	O
TRACE_LOGGER	X	X	O	O
TRACE_LOGGER_REMOTE_HOST	X	X	O	O

Feature	1.x	2.x	3.1	3.2
TRACE_LOGGER_REMOTE_PORT	X	X	O	O
TRACE_LOGIN	X	O	O	O
TRACE_LONG_RUN_CURSOR	X	O	O	O
TRACE_LONG_RUN_SQL	X	O	O	O
TRACE_XA	X	O	O	O
TRANSACTION_ALLOCATION_TIMEOUT	X	X	X	O
TRANSACTION_COMMIT_WRITE_MODE	O	O	O	O
TRANSACTION_MAXIMUM_UNDO_PAGE_COUNT	X	O	O	O
TRANSACTION_TABLE_SIZE	O	O	O	O
TRANSACTION_TIMEOUT	X	X	O	O
UNDO_RELATION_ALLOCATION_TIMEOUT	X	X	X	O
UNDO_RELATION_COUNT	O	O	O	O
UNDO_SHRINK_THRESHOLD	X	O	O	O
USE_LARGE_PAGES	X	X	X	O

SQL

SQL Element

Data Type

The following is a feature matrix for data type.

Table 4-9 Feature matrix for data type

Type	Feature	1.x	2.x	3.1	3.2
Character string type	CHAR	O	O	O	O
	VARCHAR	O	O	O	O
	LONG VARCHAR	X	O	O	O
Binary string type	BINARY	O	O	O	O
	VARBINARY	O	O	O	O
	LONG VARBINARY	X	O	O	O
Decimal number type	SMALLINT	X	O	O	O
	INTEGER	X	O	O	O
	BIGINT	X	O	O	O
	NUMERIC	O	O	O	O
	DECIMAL	X	X	O	O
	NUMBER	X	O	O	O
	REAL	X	O	O	O
	DOUBLE PRECISION	X	O	O	O
Binary number type	FLOAT	X	O	O	O
	NATIVE_SMALLINT	X	O	O	O
	NATIVE_INTEGER	X	O	O	O
	NATIVE_BIGINT	X	O	O	O
	NATIVE_REAL	X	O	O	O
BOOLEAN type	NATIVE_DOUBLE	X	O	O	O
BOOLEAN	O	O	O	O	
Date/ time type	DATE	O	O	O	O
	TIME	O	O	O	O
	TIME WITH TIME ZONE	O	O	O	O
	TIMESTAMP	O	O	O	O
	TIMESTAMP WITH TIME ZONE	O	O	O	O
	INTERVAL YEAR TO MONTH	O	O	O	O
	INTERVAL YEAR	O	O	O	O
	INTERVAL MONTH	O	O	O	O
	INTERVAL DAY TO SECOND	O	O	O	O

Type	Feature	1.x	2.x	3.1	3.2
INTERVAL type	INTERVAL DAY	O	O	O	O
	INTERVAL HOUR	O	O	O	O
	INTERVAL MINUTE	O	O	O	O
	INTERVAL SECOND	O	O	O	O
	INTERVAL DAY TO HOUR	O	O	O	O
	INTERVAL DAY TO MINUTE	O	O	O	O
	INTERVAL HOUR TO MINUTE	O	O	O	O
	INTERVAL HOUR TO SECOND	O	O	O	O
	INTERVAL MINUTE TO SECOND	O	O	O	O
ROWID type	ROWID	X	O	O	O

Function

The following is a feature matrix for function.

Table 4-10 Feature matrix for function

Feature	1.x	2.x	3.1	3.2
expr1 * expr2	O	O	O	O
expr1 + expr2	O	O	O	O
datetime + interval	X	O	O	O
+ expr	O	O	O	O
expr1 - expr2	O	O	O	O
datetime - interval	X	O	O	O
- expr	O	O	O	O
expr1 / expr2	O	O	O	O
str1 str2	O	O	O	O
expr <comp> expr	O	O	O	O
expr <comp> (subquery)	X	O	O	O
(subquery) <comp> expr	X	O	O	O
(subquery) <comp> (subquery)	X	O	O	O
(expr, ...) <comp> (expr, ...)	X	O	O	O
(expr, ...) <comp> (subquery)	X	O	O	O
(subquery) <comp> (expr, ...)	X	O	O	O
expr <comp> {ALL ANY SOME} (expr, ...)	X	O	O	O
expr <comp> {ALL ANY SOME} (subquery)	X	O	O	O
(subquery) <comp> {ALL ANY SOME} (expr, ...)	X	O	O	O
(subquery) <comp> {ALL ANY SOME} (subquery)	X	O	O	O
(expr, ...) <comp> {ALL ANY SOME} (expr_list, ...)	X	O	O	O
(expr, ...) <comp> {ALL ANY SOME} (subquery)	X	O	O	O
(subquery) <comp> {ALL ANY SOME} (expr_list, ...)	X	O	O	O

Feature	1.x	2.x	3.1	3.2
ABS(num)	O	O	O	O
ACOS(num)	O	O	O	O
ADDDATE(date, interval)	X	O	O	O
ADDDATE(expr, days)	X	O	O	O
ADDTIME(expr1, expr2)	X	O	O	O
ADD_MONTHS(date, number)	X	O	O	O
AND	O	O	O	O
ASCII(char)	X	X	O	O
ASIN(num)	O	O	O	O
ATAN(num)	O	O	O	O
ATAN2(num1, num2)	O	O	O	O
AVG(num)	X	O	O	O
expr1 [NOT] BETWEEN [ASYMMETRIC SYMMETRIC] expr2 AND expr3	X	O	O	O
BITAND(num1, num2)	O	O	O	O
BITNOT(num)	O	O	O	O
BITOR(num1, num2)	O	O	O	O
BITXOR(num1, num2)	O	O	O	O
BIT_LENGTH(str)	O	O	O	O
BYTE_LENGTH(str)	O	O	O	O
CASE .. WHEN .. THEN .. ELSE .. END	X	O	O	O
CASE2(condition, result, ...)	X	O	O	O
CAST(expr AS datatype)	O	O	O	O
CBRT(num)	O	O	O	O
CEIL(num)	O	O	O	O
CEILING(num)	O	O	O	O
CHAR_LENGTH(str)	O	O	O	O
CHARACTER_LENGTH(str)	O	O	O	O
CHR(num)	X	X	O	O
CLOCK_DATE()	O	O	O	O
CLOCK_LOCALTIME()	O	O	O	O
CLOCK_LOCALTIMESTAMP()	O	O	O	O
CLOCK_TIME()	O	O	O	O
CLOCK_TIMESTAMP()	O	O	O	O
COALESCE(expr1, ..., exprN)	X	O	O	O
CONCAT(str1, str2)	O	O	O	O
CONCATENATE(str1, str2)	O	O	O	O
COS(num)	O	O	O	O
COT(num)	O	O	O	O
COUNT(expr)	X	O	O	O

Feature	1.x	2.x	3.1	3.2
COUNT(*)	X	O	O	O
CURRENT_CATALOG	O	O	O	O
CURRENT_DATE	O	O	O	O
CURRENT_SCHEMA	O	O	O	O
CURRENT_TIME	O	O	O	O
CURRENT_TIMESTAMP	O	O	O	O
CURRENT_USER	O	O	O	O
seq.CURRVAL	O	O	O	O
CURRVAL(seq)	O	O	O	O
DATEADD(datepart, number, date)	O	O	O	O
DATEDIFF(datepart, startdate, enddate)	X	O	O	O
DATE_ADD(date, interval)	X	O	O	O
DATE_PART(field, datetime)	X	O	O	O
DECODE(expr, comparison, result, ...)	X	O	O	O
DEGREES(radians)	O	O	O	O
DIGEST (data, type)	X	X	O	O
DUMP(expr)	X	O	O	O
EXISTS(subquery)	X	O	O	O
EXP(num)	O	O	O	O
EXTRACT(field FROM datetime)	X	O	O	O
FACTORIAL(num)	O	O	O	O
FLOOR(num)	O	O	O	O
FROM_BASE64(str)	X	X	O	O
GREATEST(expr, ...)	X	O	O	O
HEX(str)	X	X	O	O
expr1 [NOT] IN (expr, ...)	X	O	O	O
expr1 [NOT] IN (subquery)	X	O	O	O
subquery [NOT] IN (<expr_list>)	X	O	O	O
subquery [NOT] IN (subquery)	X	O	O	O
<expr_list> [NOT] IN (<expr_list>, ...)	X	O	O	O
<expr_list> [NOT] IN (subquery)	X	O	O	O
subquery [NOT] IN (<expr_list>, ...)	X	O	O	O
INITCAP(str)	X	O	O	O
INSTR(str, substr, ...)	X	O	O	O
IS NOT NULL	O	O	O	O
IS NULL	O	O	O	O
LAST_DAY(date)	X	O	O	O
LAST_IDENTITY_VALUE()	X	X	O	O
LEAST(expr, ...)	X	O	O	O
LENGTH(str)	O	O	O	O

Feature	1.x	2.x	3.1	3.2
LENGTHB(str)	O	O	O	O
string [NOT] LIKE pattern ESCAPE escape_char	X	O	O	O
LN(num)	O	O	O	O
LOCALTIME	O	O	O	O
LOCALTIMESTAMP	O	O	O	O
LOCAL_GROUP_ID()	X	X	O	O
LOCAL_GROUP_NAME()	X	X	O	O
LOCAL_MEMBER_ID()	X	X	O	O
LOCAL_MEMBER_NAME()	X	X	O	O
LOG(num2)	O	O	O	O
LOG(num1, num2)	O	O	O	O
LOGON_USER()	X	O	O	O
LOWER(str)	O	O	O	O
LPAD(str, length, fill)	X	O	O	O
LTRIM(str, [str])	X	O	O	O
MAX(expr)	X	O	O	O
MIN(expr)	X	O	O	O
MOD(num1, num2)	O	O	O	O
MONTHS_BETWEEN(date1, date2)	X	X	X	O
NEXT_DAY(date, day)	X	X	O	O
seq.NEXTVAL	O	O	O	O
NEXTVAL(seq)	O	O	O	O
NEXT VALUE FOR seq	O	O	O	O
NOT	X	O	O	O
NULLIF(expr1, expr2)	X	O	O	O
NVL(expr1, expr2)	X	O	O	O
NVL2(expr1, expr2, expr3)	X	O	O	O
OCTET_LENGTH(str)	O	O	O	O
OVERLAY(str1 PLACING str2 FROM start FOR length)	X	O	O	O
OR	X	O	O	O
PI()	O	O	O	O
POSITION(str1 IN str2)	O	O	O	O
POWER(num1, num2)	O	O	O	O
RADIANS(degrees)	O	O	O	O
RANDOM(min, max)	O	O	O	O
REPEAT(str, num)	X	O	O	O
REPLACE(str, from, to)	X	O	O	O
REVERSE(str)	X	X	X	O
ROUND(num)	X	O	O	O
ROUND(date, fmt)	X	O	O	O

Feature	1.x	2.x	3.1	3.2
ROWID_GRID_BLOCK_ID(rowid)	X	X	O	O
ROWID_GRID_BLOCK_SEQ(rowid)	X	X	O	O
ROWID_MEMBER_ID(rowid)	X	X	O	O
ROWID_OBJECT_ID(rowid)	X	O	O	O
ROWID_PAGE_ID(rowid)	X	O	O	O
ROWID_ROW_NUMBER(rowid)	X	O	O	O
ROWID_SHARD_ID(rowid)	X	X	O	O
ROWID_TABLESPACE_ID(rowid)	X	O	O	O
ROWNUM	X	X	O	O
RPAD(str, length, fill)	X	O	O	O
RTRIM(str, [str])	X	O	O	O
SESSION_ID()	X	O	O	O
SESSION_SERIAL()	X	O	O	O
SESSION_USER	X	O	O	O
SHARD_GROUP_ID(table, expr)	X	X	O	O
SHARD_GROUP_NAME(table_name, shard_key_value [, ...])	X	X	O	O
SHARD_ID(table, expr)	X	X	O	O
SHARD_NAME(table_name, shard_key_value [, ...])	X	X	O	O
SHIFT_LEFT(num, cnt)	O	O	O	O
SHIFT_RIGHT(num, cnt)	O	O	O	O
SIGN(num)	O	O	O	O
SIN(num)	O	O	O	O
SPLIT_PART(str, delimiter, field)	X	O	O	O
SQRT(num)	O	O	O	O
STATEMENT_DATE()	O	O	O	O
STATEMENT_LOCALTIME()	O	O	O	O
STATEMENT_LOCALTIMESTAMP()	O	O	O	O
STATEMENT_TIME()	O	O	O	O
STATEMENT_TIMESTAMP()	O	O	O	O
STATEMENT_VIEW_SCN()	X	O	O	O
STATEMENT_VIEW_SCN_DCN()	X	X	O	O
STATEMENT_VIEW_SCN_GCN()	X	X	O	O
STATEMENT_VIEW_SCN_LCN()	X	X	O	O
STDDEV([ALL DISTINCT] expr)	X	X	X	O
STDDEV_POP(expr)	X	X	X	O
STDDEV_SAMP(expr)	X	X	X	O
SUBSTR(str FROM start FOR length)	X	O	O	O
SUBSTR(str, start, length)	X	O	O	O
SUBSTRB(str, start, length)	X	O	O	O
SUBSTRING(str FROM start FOR length)	X	O	O	O

Feature	1.x	2.x	3.1	3.2
SUBSTRING(str, start, length)	X	O	O	O
SUM(expr)	X	O	O	O
SYSDATE	O	O	O	O
SYS_EXTRACT_UTC(datetime_with_timezone)	X	X	O	O
SYSTIME	O	O	O	O
SYSTIMESTAMP	O	O	O	O
TAN(num)	O	O	O	O
TO_CHAR(datetime, fmt)	X	O	O	O
TO_CHAR(number, fmt)	X	O	O	O
TO_BASE64(str)	X	X	O	O
TO_DATE(str, fmt)	X	O	O	O
TO_NATIVE_DOUBLE(str, fmt)	X	O	O	O
TO_NATIVE_REAL(str, fmt)	X	O	O	O
TO_NUMBER(num, fmt)	X	O	O	O
TO_TIME(str, fmt)	X	O	O	O
TO_TIME_TZ(str, fmt)	X	O	O	O
TO_TIME_WITH_TIME_ZONE(str, fmt)	X	O	O	O
TO_TIMESTAMP(str, fmt)	X	O	O	O
TO_TIMESTAMP_TZ(str, fmt)	X	O	O	O
TO_TIMESTAMP_WITH_TIME_ZONE(str, fmt)	X	O	O	O
TRANSACTION_DATE()	O	O	O	O
TRANSACTION_LOCALTIME()	O	O	O	O
TRANSACTION_LOCALTIMESTAMP()	O	O	O	O
TRANSACTION_TIME()	O	O	O	O
TRANSACTION_TIMESTAMP()	O	O	O	O
TRANSLATE(str, from, to)	X	O	O	O
TRIM(LEADING TRAILING BOTH trim_char FROM source)	O	O	O	O
TRUNC(num, scale)	X	O	O	O
TRUNC(date, fmt)	X	O	O	O
UPPER(str)	O	O	O	O
UNHEX(str)	X	X	O	O
UNHEX_TO_CHARSTR(str)	X	X	O	O
USER_ID()	O	O	O	O
UUID()	X	X	O	O
VAR_POP(expr)	X	X	X	O
VAR_SAMP(expr)	X	X	X	O
VARIANCE([ALL DISTINCT] expr)	X	X	X	O
VERSION()	O	O	O	O
WIDTH_BUCKET(num, min, max, cnt)	O	O	O	O

Object

SQL Object

The following is a feature matrix for DDL which creates/ drops/ alters an SQL object.

Table 4-11 Feature matrix for SQL object DDL

Object	Feature	1.x	2.x	3.1	3.2
Database object	ALTER DATABASE ARCHIVELOG	X	O	O	O
	ALTER DATABASE ADD LOGFILE	X	O	O	O
	ALTER DATABASE DROP LOGFILE	X	O	O	O
	ALTER DATABASE RENAME LOGFILE	X	O	O	O
	ALTER DATABASE BEGIN/END BACKUP	X	O	O	O
	ALTER DATABASE RECOVER	X	O	O	O
	ALTER DATABASE RECOVER TABLESPACE	X	O	O	O
	ALTER DATABASE REGISTER	X	O	O	O
	ALTER DATABASE RESTORE	X	O	O	O
	ANALYZE SYSTEM	X	X	O	O
COMMENT ON object IS ..	X	O	O	O	
Profile object	CREATE PROFILE	X	O	O	O
	DROP PROFILE	X	O	O	O
	ALTER PROFILE	X	O	O	O
Audit policy object	CREATE AUDIT POLICY	X	X	X	O
	DROP AUDIT POLICY	X	X	X	O
	ALTER AUDIT POLICY	X	X	X	O
	AUDIT POLICY	X	X	X	O
	NOAUDIT POLICY	X	X	X	O
Authorization object	CREATE USER	X	O	O	O
	DROP USER	X	O	O	O
	ALTER USER	X	O	O	O
	GRANT privileges TO	X	O	O	O
	REVOKE privileges FROM	X	O	O	O
Schema object	CREATE SCHEMA	X	O	O	O
	DROP SCHEMA	X	O	O	O
Tablespace object	CREATE MEMORY DATA TABLESPACE	X	O	O	O
	CREATE MEMORY TEMPORARY TABLESPACE	X	O	O	O
	DROP TABLESPACE	X	O	O	O
	ALTER TABLESPACE .. RENAME TO	X	O	O	O
	ALTER TABLESPACE .. BEGIN/END BACKUP	X	O	O	O
	ALTER TABLESPACE .. ADD [DATAFILE MEMORY]	O	O	O	O
	ALTER TABLESPACE .. DROP [DATAFILE MEMORY]	X	O	O	O

Object	Feature	1.x	2.x	3.1	3.2
	ALTER TABLESPACE .. RENAME DATAFILE	X	O	O	O
	ALTER TABLESPACE .. { ONLINE OFFLINE }	X	O	O	O
Table object	CREATE TABLE	O	O	O	O
	CREATE TABLE AS SELECT	X	O	O	O
	CREATE GLOBAL TEMPORARY TABLE	X	X	X	O
	CREATE GLOBAL TEMPORARY TABLE AS SELECT	X	X	X	O
	DROP TABLE	O	O	O	O
	TRUNCATE TABLE	X	O	O	O
	ALTER TABLE .. STORAGE	X	O	O	O
	ALTER TABLE .. RENAME TO	X	O	O	O
	ALTER TABLE .. ADD COLUMN	X	O	O	O
	ALTER TABLE .. SET UNUSED COLUMN	X	O	O	O
	ALTER TABLE .. ALTER COLUMN	X	O	O	O
	ALTER TABLE .. RENAME COLUMN	X	O	O	O
	ALTER TABLE .. RENAME CONSTRAINT	X	X	X	O
	ALTER TABLE .. ADD CONSTRAINT	X	O	O	O
	ALTER TABLE .. DROP CONSTRAINT	X	O	O	O
	ALTER TABLE .. ALTER CONSTRAINT	X	O	O	O
	ALTER TABLE .. ADD SUPPLEMENTAL LOG	X	O	O	O
	ALTER TABLE .. DROP SUPPLEMENTAL LOG	X	O	O	O
	ALTER TABLE .. READ { ONLY WRITE }	X	X	X	O
	ANALYZE TABLE	X	X	O	O
View object	CREATE VIEW	X	O	O	O
	DROP VIEW	X	O	O	O
	ALTER VIEW	X	O	O	O
Index object	CREATE INDEX	O	O	O	O
	DROP INDEX	O	O	O	O
	ALTER INDEX .. AGING	X	X	O	O
	ALTER INDEX .. STORAGE	X	O	O	O
	ALTER INDEX .. RENAME	X	X	X	O
Sequence object	CREATE SEQUENCE	O	O	O	O
	DROP SEQUENCE	O	O	O	O
	ALTER SEQUENCE	X	O	O	O
Synonym object	CREATE SYNONYM	X	O	O	O
	DROP SYNONYM	X	O	O	O
	CREATE PUBLIC SYNONYM	X	O	O	O
	DROP PUBLIC SYNONYM	X	O	O	O
Stored procedure object	CREATE PROCEDURE	X	X	O	O
	DROP PROCEDURE	X	X	O	O
	ALTER PROCEDURE	X	X	O	O

Object	Feature	1.x	2.x	3.1	3.2
Stored function object	CREATE FUNCTION	X	X	O	O
	DROP FUNCTION	X	X	O	O
	ALTER FUNCTION	X	X	O	O

Cluster Object

The following is a feature matrix for DDL which creates/ drops/ alters a cluster object.

Table 4-12 Feature matrix for cluster object DDL

Object	Feature	1.x	2.x	3.1	3.2
Cluster system object	ALTER DATABASE REBALANCE	X	X	O	O
	ALTER DATABASE DROP INACTIVE CLUSTER MEMBERS	X	X	O	O
Cluster group object	CREATE CLUSTER GROUP	X	X	O	O
	DROP CLUSTER GROUP	X	X	O	O
Cluster member object	ALTER CLUSTER GROUP name ADD MEMBER	X	X	O	O
	ALTER CLUSTER GROUP name OFFLINE MEMBER	X	X	O	O
	ALTER DATABASE RESET LOCAL CLUSTER MEMBER	X	X	O	O
	ALTER SYSTEM IRRECOVERABLE CLUSTER MEMBER	X	X	X	O
	ALTER SYSTEM JOIN DATABASE	X	X	O	O
Cluster location object	CREATE CLUSTER LOCATION	X	X	O	O
	DROP CLUSTER LOCATION	X	X	O	O
	ALTER CLUSTER LOCATION	X	X	O	O
Cluster table and shard object	ALTER TABLE name REBALANCE	X	X	O	O
	ALTER TABLE name MOVE SHARD	X	X	O	O
	ALTER TABLE name SPLIT SHARD	X	X	O	O
	ALTER TABLE name RENAME SHARD	X	X	X	O
Global secondary index object	ALTER TABLE name ADD GLOBAL SECONDARY INDEX	X	X	O	O
	ALTER TABLE name DROP GLOBAL SECONDARY INDEX	X	X	O	O
	ALTER TABLE name ALTER GLOBAL SECONDARY INDEX	X	X	O	O

SQL Language

DML

The following is a feature matrix for DML which manipulates data.

Table 4-13 Feature matrix for DML

Feature	1.x	2.x	3.1	3.2
INSERT INTO ..	O	O	O	O
INSERT INTO .. RETURNING query	X	O	O	O
INSERT INTO .. RETURNING .. INTO ..	X	O	O	O
DELETE FROM ..	O	O	O	O
DELETE FROM .. RETURNING query	X	O	O	O
DELETE FROM .. RETURNING .. INTO ..	X	O	O	O
DELETE FROM .. WHERE CURRENT OF cursor	X	O	O	O
UPDATE ..	O	O	O	O
UPDATE .. RETURNING query	X	O	O	O
UPDATE .. RETURNING .. INTO ..	X	O	O	O
UPDATE .. WHERE CURRENT OF cursor	X	O	O	O
CALL proc_name	X	X	O	O

Query

The following is a feature matrix for SELECT statement which enquires data.

Table 4-14 Feature matrix for SELECT

Feature	1.x	2.x	3.1	3.2
<query expression>	O	O	O	O
<query specification>	O	O	O	O
<select list>	O	O	O	O
<from clause>	O	O	O	O
<joined table>	X	O	O	O
<where clause>	O	O	O	O
<group by clause>	X	O	O	O
<order by clause>	X	O	O	O
<offset limit clause>	O	O	O	O
<set operator>	X	O	O	O
<subquery>	X	O	O	O
<hint clause>	X	O	O	O

Control Language

The following is a feature matrix for control statement.

Table 4-15 Feature matrix for control statement

Control statement	Feature	1.x	2.x	3.1	3.2
Transaction	COMMIT	O	O	O	O
	ROLLBACK	O	O	O	O
	SAVEPOINT	X	O	O	O
	RELEASE SAVEPOINT	X	O	O	O
	LOCK TABLE	X	O	O	O
	SET CONSTRAINTS	X	O	O	O
	SET TRANSACTION	X	O	O	O
Session	SET SESSION CHARACTERISTICS AS	X	O	O	O
	SET SESSION AUTHORIZATION	X	O	O	O
	SET TIME ZONE	X	O	O	O
	ALTER SESSION SET property	O	O	O	O
System	ALTER SYSTEM {OPEN MOUNT} DATABASE	X	O	O	O
	ALTER SYSTEM CHECKPOINT	O	O	O	O
	ALTER SYSTEM KILL SESSION	X	O	O	O
	ALTER SYSTEM RECONNECT GLOBAL CONNECTION	X	X	X	O
	ALTER SYSTEM SWITCH LOGFILE	X	O	O	O
	ALTER SYSTEM SET property	X	O	O	O
	ALTER SYSTEM RESET property	X	O	O	O

PSM Language

The following is a feature matrix for persistent stored module (PSM) language element.

Table 4-16 Feature matrix for persistent stored module (PSM) language element

Feature	1.x	2.x	3.1	3.2
Assignment Statement	X	X	O	O
Basic LOOP Statement	X	X	O	O
Block (BEGIN .. END)	X	X	O	O
CASE Statement	X	X	O	O
CLOSE Statement	X	X	O	O
Collection Method Invocation	X	X	O	O
Collection Variable Declaration	X	X	O	O
CONTINUE Statement	X	X	O	O
Cursor FOR LOOP Statement	X	X	O	O
Cursor Variable Declaration	X	X	O	O
DELETE Statement Extension	X	X	O	O
EXCEPTION_INIT Pragma	X	X	O	O
Exception Declaration	X	X	O	O
Exception Handler	X	X	O	O
EXECUTE IMMEDIATE Statement	X	X	O	O
EXIT Statement	X	X	O	O
Explicit Cursor Declaration and Definition	X	X	O	O
FETCH Statement	X	X	O	O
FOR LOOP Statement	X	X	O	O
GOTO Statement	X	X	O	O
IF Statement	X	X	O	O
Implicit Cursor Attribute	X	X	O	O
INSERT Statement Extension	X	X	O	O
Named Cursor Attribute	X	X	O	O
NULL Statement	X	X	O	O
OPEN Statement	X	X	O	O
OPEN FOR Statement	X	X	O	O
Procedure Call	X	X	O	O
Procedure Declaration and Definition	X	X	O	O
RAISE Statement	X	X	O	O
Record Variable Declaration	X	X	O	O
RETURN Statement	X	X	O	O
RETURNING INTO clause	X	X	O	O
%ROWTYPE Attribute	X	X	O	O
Scalar Variable Declaration	X	X	O	O

Feature	1.x	2.x	3.1	3.2
SELECT INTO Statement	X	X	O	O
SQLCODE Function	X	X	O	O
SQLERRM Function	X	X	O	O
%TYPE Attribute	X	X	O	O
UPDATE Statement Extension	X	X	O	O
WHILE LOOP Statement	X	X	O	O

API

ODBC

The following is a feature matrix for the ODBC standard API.

Table 4-17 Feature matrix for the ODBC standard API

Feature	1.x	2.x	3.1	3.2
SQLAllocHandle()	O	O	O	O
SQLBindCol()	O	O	O	O
SQLBindParameter()	O	O	O	O
SQLCloseCursor()	O	O	O	O
SQLColAttribute()	X	O	O	O
SQLColumnPrivileges()	X	O	O	O
SQLColumns()	X	O	O	O
SQLConnect()	O	O	O	O
SQLDescribeCol()	O	O	O	O
SQLDescribeParam()	O	O	O	O
SQLDisconnect()	O	O	O	O
SQLDriverConnect()	X	O	O	O
SQLEndTran()	O	O	O	O
SQLExecDirect()	O	O	O	O
SQLExecute()	O	O	O	O
SQLExtendedFetch()	X	O	O	O
SQLFetch()	O	O	O	O
SQLFetchScroll()	X	O	O	O
SQLForeignKeys()	X	O	O	O
SQLFreeHandle()	O	O	O	O
SQLFreeStmt()	O	O	O	O
SQLGetConnectAttr()	O	O	O	O
SQLGetCursorName()	X	O	O	O
SQLGetData()	X	O	O	O
SQLGetDescField()	O	O	O	O
SQLGetDescRec()	O	O	O	O
SQLGetDiagField()	O	O	O	O
SQLGetDiagRec()	O	O	O	O
SQLGetEnvAttr()	O	O	O	O
SQLGetFunctions()	O	O	O	O
SQLGetInfo()	X	O	O	O
SQLGetStmtAttr()	O	O	O	O

Feature	1.x	2.x	3.1	3.2
SQLGetTypeInfo()	X	O	O	O
SQLMoreResults()	X	O	O	O
SQLNumParams()	O	O	O	O
SQLNumResultCols()	O	O	O	O
SQLParamData()	X	O	O	O
SQLPrepare()	O	O	O	O
SQLPrimaryKeys()	X	O	O	O
SQLProcedureColumns()	X	O	O	O
SQLProcedures()	X	O	O	O
SQLPutData()	X	O	O	O
SQLRowCount()	O	O	O	O
SQLSetConnectAttr()	O	O	O	O
SQLSetCursorName()	X	O	O	O
SQLSetDescField()	O	O	O	O
SQLSetDescRec()	O	O	O	O
SQLSetEnvAttr()	O	O	O	O
SQLSetPos()	X	O	O	O
SQLSetStmtAttr()	O	O	O	O
SQLSpecialColumns()	X	O	O	O
SQLStatistics()	X	O	O	O
SQLTablePrivileges()	X	O	O	O
SQLTables()	X	O	O	O

The following is a feature matrix for API other than the ODBC standard API.

Table 4-18 Feature matrix for API other than the ODBC standard

Feature	1.x	2.x	3.1	3.2
xa_open	X	O	O	O
xa_close	X	O	O	O
xa_start	X	O	O	O
xa_end	X	O	O	O
xa_rollback	X	O	O	O
xa_prepare	X	O	O	O
xa_commit	X	O	O	O
xa_recover	X	O	O	O
xa_forget	X	O	O	O
SQLGetXaSwitch	X	O	O	O
SQLGetXaConnectionHandle	X	O	O	O
SQLGetGroupCount	X	X	X	O
SQLGetGroupIDs	X	X	X	O

Feature	1.x	2.x	3.1	3.2
SQLGetGroupName	X	X	X	O
SQLGetSuitableGroupID	X	X	X	O

JDBC

The following is a class feature matrix for JDBC.

Table 4-19 Class feature matrix for JDBC

Feature	1.x	2.x	3.1	3.2
CallableStatement	X	X	O	O
CommonDataSource	X	O	O	O
Connection	X	O	O	O
ConnectionPoolDataSource	X	O	O	O
DatabaseMetaData	X	O	O	O
DataSource	X	O	O	O
Driver	X	O	O	O
ParameterMetaData	X	O	O	O
PooledConnection	X	O	O	O
PreparedStatement	X	O	O	O
ResultSet	X	O	O	O
ResultSetMetaData	X	O	O	O
RowId	X	O	O	O
Savepoint	X	O	O	O
Statement	X	O	O	O
XAConnection	X	O	O	O
XADataSource	X	O	O	O
XAResource	X	O	O	O
GoldilocksInterval	X	O	O	O
GoldilocksTypes	X	O	O	O

Embedded SQL

Precompiler Option

The following is a feature matrix for precompiler option.

Table 4-20 Feature matrix for precompiler option

Feature	1.x	2.x	3.1	3.2
--help	X	O	O	O
--include-path	X	O	O	O
--no-prompt	X	O	O	O
--output	X	O	O	O
--unsafe-null	X	O	O	O
--version	X	O	O	O

Embedded SQL-only Syntax

The following is a feature matrix of embedded SQL-only syntax.

Table 4-21 Feature matrix for embedded SQL-only syntax

Feature	1.x	2.x	3.1	3.2
EXEC SQL AT	X	O	O	O
EXEC SQL ATOMIC INSERT	X	O	O	O
EXEC SQL AUTOCOMMIT	X	O	O	O
EXEC SQL BEGIN DECLARE SECTION	X	O	O	O
EXEC SQL COMMIT RELEASE	X	O	O	O
EXEC SQL CONNECT	X	O	O	O
EXEC SQL CONTEXT ALLOCATE	X	O	O	O
EXEC SQL CONTEXT FREE	X	O	O	O
EXEC SQL CONTEXT USE	X	O	O	O
EXEC SQL DISCONNECT	X	O	O	O
EXEC SQL END DECLARE SECTION	X	O	O	O
EXEC SQL FOR	X	O	O	O
EXEC SQL GET GROUPID	X	X	X	O
EXEC SQL INCLUDE	X	O	O	O
EXEC SQL INCLUDE SQLCA	X	O	O	O
EXEC SQL OPTION	X	O	O	O
EXEC SQL ROLLBACK RELEASE	X	O	O	O
EXEC SQL WHENEVER	X	O	O	O

Host Variable Data Type

The following is a feature matrix for embedded SQL data type which can be used for HOST variables.

Table 4-22 Feature matrix for host variable data type

Feature	1.x	2.x	3.1	3.2
C native type	X	O	O	O
struct, union	X	O	O	O
typedef	X	O	O	O
VARCHAR	X	O	O	O
LONG VARCHAR	X	O	O	O
BINARY	X	O	O	O
LONG VARBINARY	X	O	O	O
BOOLEAN	X	O	O	O
NUMBER	X	O	O	O
DATE	X	O	O	O
TIME	X	O	O	O
TIME WITH TIMEZONE	X	O	O	O
TIMESTAMP	X	O	O	O
TIMESTAMP WITH TIMEZONE	X	O	O	O
INTERVAL YEAR	X	O	O	O
INTERVAL MONTH	X	O	O	O
INTERVAL DAY	X	O	O	O
INTERVAL HOUR	X	O	O	O
INTERVAL MINUTE	X	O	O	O
INTERVAL SECOND	X	O	O	O
INTERVAL YEAR TO MONTH	X	O	O	O
INTERVAL DAY TO HOUR	X	O	O	O
INTERVAL DAY TO MINUTE	X	O	O	O
INTERVAL DAY TO SECOND	X	O	O	O
INTERVAL HOUR TO MINUTE	X	O	O	O
INTERVAL HOUR TO SECOND	X	O	O	O
INTERVAL MINUTE TO SECOND	X	O	O	O

Dynamic SQL

The following is a feature matrix for dynamic SQL.

Table 4-23 Feature matrix for dynamic SQL

Feature	1.x	2.x	3.1	3.2
SELECT .. INTO	X	O	O	O
EXECUTE IMMEDIATE sql	X	O	O	O

Feature	1.x	2.x	3.1	3.2
PREPARE stmt	X	O	O	O
EXECUTE stmt	X	O	O	O
DECLARE cursor FOR sql	X	O	O	O
DECLARE cursor FOR stmt	X	O	O	O
OPEN cursor	X	O	O	O
OPEN cursor USING	X	O	O	O
FETCH cursor INTO	X	O	O	O
CLOSE cursor	X	O	O	O
DELETE .. WHERE CURRENT OF cursor	X	O	O	O
UPDATE .. WHERE CURRENT OF cursor	X	O	O	O

PyDBC

Module

The following is a method feature matrix for pygoldilocks provided by PyDBC.

Table 4-24 Feature matrix for pygoldilock method

Feature	1.x	2.x	3.1	3.2
connect	X	X	X	O
Date	X	X	X	O
Time	X	X	X	O
Timestamp	X	X	X	O
DateFromTicks	X	X	X	O
TimeFromTicks	X	X	X	O
TimestampFromTicks	X	X	X	O
Binary	X	X	X	O
STRING	X	X	X	O
BINARY	X	X	X	O
NUMBER	X	X	X	O
DATETIME	X	X	X	O
ROWID	X	X	X	O
getDecimalSeparator	X	X	X	O
setDecimalSeparator	X	X	X	O

The following is an attribute feature matrix for pygoldilocks module.

Table 4-25 Feature matrix for pygoldilock attribute

Feature	1.x	2.x	3.1	3.2
apilevel	X	X	X	O
threadsafety	X	X	X	O
paramstyle	X	X	X	O
version	X	X	X	O
lowercase	X	X	X	O

Connection

The following is a method feature matrix for connection object.

Table 4-26 Feature matrix for connection method

Feature	1.x	2.x	3.1	3.2
cursor	X	X	X	O
commit	X	X	X	O

Feature	1.x	2.x	3.1	3.2
rollback	X	X	X	O
close	X	X	X	O
getinfo	X	X	X	O
execute	X	X	X	O
set_attr	X	X	X	O

The following is an attribute feature matrix for connection object.

Table 4-27 Feature matrix for connection attribute

Feature	1.x	2.x	3.1	3.2
autocommit	X	X	X	O
searchescape	X	X	X	O
timeout	X	X	X	O

Cursor

The following is a method feature matrix for cursor object.

Table 4-28 Feature matrix for cursor method

Feature	1.x	2.x	3.1	3.2
excute	X	X	X	O
executemany	X	X	X	O
fetchone	X	X	X	O
fetchall	X	X	X	O
fetchmany	X	X	X	O
commit	X	X	X	O
rollback	X	X	X	O
skip	X	X	X	O
nextset	X	X	X	O
close	X	X	X	O
setinputsizes	X	X	X	O
setoutputsize	X	X	X	O
callproc	X	X	X	O
callfunc	X	X	X	O
tables	X	X	X	O
columns	X	X	X	O
statistics	X	X	X	O
rowIdColumns	X	X	X	O
rowVerColumns	X	X	X	O
primaryKeys	X	X	X	O

Feature	1.x	2.x	3.1	3.2
foreignKeys	X	X	X	O
procedures	X	X	X	O
getTypeInfo	X	X	X	O

The following is an attribute feature matrix for cursor object.

Table 4-29 Feature matrix for cursor attribute

Feature	1.x	2.x	3.1	3.2
Description	X	X	X	O
rowCount	X	X	X	O
arraysize	X	X	X	O
connection	X	X	X	O
fast_executemany	X	X	X	O

Row

The following is an attribute feature matrix for row object.

Table 4-30 Feature matrix for row attribute

Feature	1.x	2.x	3.1	3.2
cursor_description	X	X	X	O

Utility

gcreatedb

Command Usage

The following is a feature matrix for command usage of gcreatedb.

Table 4-31 Feature matrix for command usage of gcreatedb

Feature	1.x	2.x	3.1	3.2
--character_set	O	O	O	O
--char_length_units	X	O	O	O
--cluster	X	X	O	O
--db_comment	O	O	O	O
--help	O	O	O	O
--host	X	X	O	O

Feature	1.x	2.x	3.1	3.2
--member	X	X	O	O
--port	X	X	O	O
--silent	O	O	O	O
--timezone	X	O	O	O

glsnr

Command Usage

The following is a feature matrix for command usage of glsnr.

Table 4-32 Feature matrix for command usage of glsnr

Feature	1.x	2.x	3.1	3.2
--help	X	O	O	O
--home	X	X	O	O
--silent	X	O	O	O
--start	X	O	O	O
--status	X	O	O	O
--stop	X	O	O	O

Configuration File

The following is a feature matrix for configuration of glsnr.

Table 4-33 Feature matrix for configuration of glsnr

Feature	1.x	2.x	3.1	3.2
BACKLOG	X	O	O	O
DEFAULT_CS_MODE	X	O	O	O
LISTENER_LOG_DIR	X	X	O	O
LISTEN_PORT	X	O	O	O
TCP_EXCLUDED	X	O	O	O
TCP_INVITED	X	O	O	O
TCP_HOST	X	O	O	O
TCP_VALIDNODE_CHECKING	X	O	O	O
TIMEOUT	X	O	O	O
USR_DIR	X	X	O	O

gsql/gsqlnet

Command Usage

The following is a feature matrix for command usage of gsql.

Table 4-34 Feature matrix for command usage of gsql

Feature	1.x	2.x	3.1	3.2
username password	O	O	O	O
--as {SYSDBA ADMIN}	X	O	O	O
--conn-string	X	O	O	O
--dsn	X	O	O	O
--enable-color	O	O	O	O
--help	O	O	O	O
--import	O	O	O	O
--no-prompt	O	O	O	O
--prompt	O	O	O	O
--silent	O	O	O	O
--version	O	O	O	O

Interactive gsql Command

The following is a feature matrix for interactive gsql command.

Table 4-35 Feature matrix for interactive gsql command

Feature	1.x	2.x	3.1	3.2
\\	O	O	O	O
\connect userid password [as sysdba]	X	O	O	O
\shutdown	X	X	O	O
\startup	X	X	O	O
\ddl_cluster	X	X	O	O
\ddl_db	X	O	O	O
\ddl_tablespace	X	O	O	O
\ddl_profile	X	O	O	O
\ddl_audit_policy	X	X	X	O
\ddl_auth	X	O	O	O
\ddl_schema	X	O	O	O
\ddl_publicsynonym	X	O	O	O
\ddl_table	X	O	O	O
\ddl_constraint	X	O	O	O
\ddl_index	X	O	O	O
\ddl_view	X	O	O	O

Feature	1.x	2.x	3.1	3.2
\ddl_sequence	X	O	O	O
\ddl_synonym	X	O	O	O
\ddl_procedure	X	X	O	O
\desc	O	O	O	O
\dynamic sql :var	X	O	O	O
\exec	O	O	O	O
\exec :var := :value	O	O	O	O
\exec sql	O	O	O	O
\explain plan [on only]	O	O	O	O
\help	O	O	O	O
\history	O	O	O	O
\host {os_command}	X	X	O	O
\import	O	O	O	O
\idesc	O	O	O	O
\{n}	O	O	O	O
\prepare sql	O	O	O	O
\print	O	O	O	O
\quit	O	O	O	O
\set autocommit	O	O	O	O
\set color	O	O	O	O
\set colsize	X	O	O	O
\set ddlsize	X	O	O	O
\set error	O	O	O	O
\set history	O	O	O	O
\set linesize	O	O	O	O
\set numsize	X	O	O	O
\set pagesize	O	O	O	O
\set timing	O	O	O	O
\set vertical	O	O	O	O
\shutdown {abort immediate transactional normal}	X	O	O	O
\startup {nomount mount open}	X	O	O	O
\var	O	O	O	O

gloader/gloadernet

Command Usage

The following is a feature matrix for command usage of gloader.

Table 4-36 Feature matrix for command usage of gloader

Feature	1.x	2.x	3.1	3.2
username password	O	O	O	O
--array	O	O	O	O
--atomic	O	O	O	O
--bad	O	O	O	O
--buffered	X	O	O	O
--commit	O	O	O	O
--control	O	O	O	O
--data	O	O	O	O
--dsn	X	O	O	O
--errors	X	O	O	O
--export	O	O	O	O
--fieldterm	X	X	O	O
--filesize	X	O	O	O
--format	X	O	O	O
--help	O	O	O	O
--import	O	O	O	O
--lineterm	X	X	O	O
--log	O	O	O	O
--no-prompt	O	O	O	O
--parallel	O	O	O	O
--propagation	X	O	O	O
--qualifier	X	X	O	O
--silent	O	O	O	O
--AsTIMESTAMP	X	O	O	O
--where	X	X	X	O

Control File Syntax

The following is a feature matrix for control file syntax of gloader.

Table 4-37 Feature matrix for control file syntax of gloader

Feature	1.x	2.x	3.1	3.2
CHARACTERSET	X	O	O	O
FIELDS TERMINATED BY	O	O	O	O

Feature	1.x	2.x	3.1	3.2
OPTIONALLY ENCLOSED BY	O	O	O	O
TABLE table_name	O	O	O	O
TABLE schema_name.table_name	X	O	O	O
LTRIM	X	X	O	O
RTRIM	X	X	O	O
LINES TERMINATED BY	X	X	O	O
WHERE	X	X	X	O

gdump

Command Usage

The following is a feature matrix for command usage of gdump.

Table 4-38 Feature matrix for command usage of gdump

Item	Feature	1.x	2.x	3.1	3.2	
Common arguments	--silent	X	O	O	O	
File type	BACKUP	X	O	O	O	
	COMMIT_LOG	X	X	O	O	
	CONTROL	X	O	O	O	
	DATA	X	O	O	O	
	LOG	X	O	O	O	
	LOG_BUFFER	X	X	O	O	
	PEND_BUFFER	X	X	O	O	
BACKUP file arguments	PROPERTY	X	O	O	O	
	--body	X	O	O	O	
	--tbs	X	O	O	O	
	--number	X	O	O	O	
CONTROL file arguments	--fetch	X	O	O	O	
	--section	X	O	O	O	
	DATA file arguments	--header	X	O	O	O
		--number	X	O	O	O
--fetch		X	O	O	O	
LOG file arguments	--all	X	X	O	O	
	--fetch	X	O	O	O	
	--header	X	X	O	O	
	--number	X	O	O	O	
	--offset	X	O	O	O	

tablediff

Configuration File

The following is a feature matrix for configuration file of tablediff.

Table 4-39 Feature matrix for configuration file of tablediff

Item	Feature	1.x	2.x	3.1	3.2
Source table	SOURCE_PASSWORD	X	O	O	O
	SOURCE_SCHEMA	X	O	O	O
	SOURCE_TABLE	X	O	O	O
	SOURCE_URL	X	O	O	O
	SOURCE_USER	X	O	O	O
Target table	TARGET_PASSWORD	X	O	O	O
	TARGET_SCHEMA	X	O	O	O
	TARGET_TABLE	X	O	O	O
	TARGET_URL	X	O	O	O
	TARGET_USER	X	O	O	O
Sync operation	TARGET_INSERT	X	O	O	O
	TARGET_UPDATE	X	O	O	O
	TARGET_DELETE	X	O	O	O
	SOURCE_INSERT	X	O	O	O
Operation options	DIFF_BIN_FILE	X	O	O	O
	DIFF_OUT_FILE	X	O	O	O
	DISPLAY_CALL_STACK	X	O	O	O
	DISPLAY_ROW_UNIT	X	O	O	O
	EXCLUDE_COLUMNS	X	O	O	O
	LOGGING_ON_DIFF	X	O	O	O
	LOGGING_ON_SUCCESS	X	O	O	O
	JOB_QUEUE_SIZE	X	O	O	O
	JOB_THREAD	X	O	O	O
	JOB_UNIT_SIZE	X	O	O	O
	PARTITION_RANGE	X	O	O	O
	SYNC_OUT_FILE	X	O	O	O
WHERE_CLAUSE	X	O	O	O	

gsyncher

Command Usage

The following is a feature matrix for command usage of gsyncher.

Table 4-40 Feature matrix for command usage of gsyncher

Feature	1.x	2.x	3.1	3.2
--log	X	O	O	O
--silent	X	O	O	O
--home	X	X	O	O
--copy-right	X	O	O	O
--backup-path	X	O	O	O
--help	X	O	O	O

gmon

Command Usage

The following is a feature matrix for command usage of gmon.

Table 4-41 Feature matrix for command usage of gmon

Feature	1.x	2.x	3.1	3.2
--start	X	X	O	O
--stop	X	X	O	O
--status	X	X	O	O
--home	X	X	O	O
--silent	X	X	O	O
--no-copyright	X	X	O	O
--help	X	X	O	O

gtrclogger

Command Usage

The following is a feature matrix for command usage of gtrclogger.

Table 4-42 Feature matrix for command usage of gtrclogger

Feature	1.x	2.x	3.1	3.2
--dir	X	X	O	O
--help	X	X	O	O
--port	X	X	O	O
--start	X	X	O	O
--stop	X	X	O	O

glocator

Command Usage

The following is a feature matrix for command usage of glocator.

Table 4-43 Feature matrix for command usage of glocator

Feature	1.x	2.x	3.1	3.2
--create	X	X	O	O
--start	X	X	O	O
--stop	X	X	O	O
--conf	X	X	O	O
--status	X	X	O	O
--sync	X	X	X	O
--silent	X	X	O	O
--no-copyright	X	X	O	O
--help	X	X	O	O

Configuration File

The following is a feature matrix for configuration file of glocator.

Table 4-44 Feature matrix for configuration file of glocator

Feature	1.x	2.x	3.1	3.2
PORT	X	X	O	O
WORKER_COUNT	X	X	O	O
SESSION_QUEUE_SIZE	X	X	O	O
SESSION_ALLOCATOR_SIZE	X	X	O	O
PACKET_ALLOCATOR_SIZE	X	X	O	O
SYSTEM_LOGGER_DIR	X	X	O	O
SYSTEM_UDS_DIR	X	X	O	O
LOCATION_FILE_DIR	X	X	O	O
LOCATION_FILE_SIZE	X	X	O	O
LOCATION_FILE_MAX_SIZE	X	X	O	O
SESSION_TIMEOUT	X	X	O	O
FAILOVER_TIMEOUT	X	X	O	O
ALTERNATE_LOCATORS	X	X	X	O
SYNC_RETRY_COUNT	X	X	X	O
SYNC_RESPONSE_TIMEOUT	X	X	X	O

gagent

Command Usage

The following is a feature matrix for command usage of gagent.

Table 4-45 Feature matrix for command usage of gagent

Feature	1.x	2.x	3.1	3.2
--start	X	X	O	O
--stop	X	X	O	O
--conf	X	X	O	O
--status	X	X	O	O
--home	X	X	O	O
--silent	X	X	O	O
--no-copyright	X	X	O	O
--help	X	X	O	O

Configuration File

The following is a feature matrix for configuration file of gagent.

Table 4-46 Feature matrix for configuration file of gagent

Feature	1.x	2.x	3.1	3.2
PORT	X	X	O	O
LOCATOR_HOST	X	X	O	O
LOCATOR_PORT	X	X	O	O
COMMAND_QUEUE_SIZE	X	X	O	O
COMMAND_ALLOCATOR_SIZE	X	X	O	O
PACKET_ALLOCATOR_SIZE	X	X	O	O
SYSTEM_LOGGER_DIR	X	X	O	O
SESSION_TIMEOUT	X	X	O	O
UPDATE_LOCATION_TIME	X	X	O	O
ALTERNATE_LOCATORS	X	X	X	O

gloctl

Command Usage

The following is a feature matrix for command usage of gloctl.

Table 4-47 Feature matrix for command usage of gloctl

Feature	1.x	2.x	3.1	3.2
--dsn	X	X	O	X
--conf	X	X	X	O
--ip	X	X	O	O
--port	X	X	O	O
--import	X	X	O	O
--silent	X	X	O	O
--no-copyright	X	X	O	O
--help	X	X	O	O

Configuration File

The following is a feature matrix for configuration file of gloctl.

Table 4-48 Feature matrix for configuration file of gloctl

Feature	1.x	2.x	3.1	3.2
PORT	X	X	X	O
LOCATOR_HOST	X	X	X	O
LOCATOR_PORT	X	X	X	O

Replication

cyclone

Command Usage

The following is a feature matrix for command usage of cyclone.

Table 4-49 Feature matrix for command usage of cyclone

Feature	1.x	2.x	3.1	3.2
--conf	X	O	O	O
--encrypt	X	X	O	O
--group	X	O	O	O
--help	X	O	O	O
--key	X	X	O	O
--master	X	O	O	O
--reset	X	O	O	O
--silent	X	O	O	O
--slave	X	O	O	O
--start	X	O	O	O
--status	X	O	O	O
--stop	X	O	O	O
--sync	X	O	O	O
--stand-alone	X	X	X	O
--recovery	X	X	X	O
--local	X	X	X	O

Configuration File

The following is a feature matrix for configuration file of cyclone.

Table 4-50 Feature matrix for configuration file of cyclone

Configuration	Feature	1.x	2.x	3.1	3.2
Common configuration	COMM_CHUNK_COUNT	X	O	O	O
	DSN	X	O	O	O
	USER_ENCRYPT_PW	X	X	O	O
	GROUP_NAME	X	O	O	O
	HOST_IP	X	O	O	O
	HOST_EXTERNAL_IP	X	X	O	O
	HOST_PORT	X	O	O	O
	PORT	X	O	O	O

Configuration	Feature	1.x	2.x	3.1	3.2
	PROTOCOL	X	X	O	O
	USER_ID	X	O	O	O
	USER_PW	X	O	O	O
MASTER configuration	CAPTURE_TABLE	X	O	O	O
	LOG_PATH	X	O	O	O
	READ_LOG_BLOCK_COUNT	X	O	O	O
	TRANS_SORT_AREA_SIZE	X	O	O	O
	TRANS_FILE_PATH	X	O	O	O
	SYNCHER_COUNT	X	O	O	O
	SYNC_ARRAY_SIZE	X	O	O	O
	GIVEUP_INTERVAL	X	O	O	O
	LOG_CAPTURE_INTERVAL_1	X	X	O	O
LOG_CAPTURE_INTERVAL_2	X	X	O	O	
SLAVE configuration	APPLIER_COUNT	X	O	O	O
	APPLY_ARRAY_SIZE	X	O	X	X
	APPLY_COMMIT_SIZE	X	O	O	O
	APPLY_TABLE	X	O	O	O
	MASTER_IP	X	O	O	O
	PROPAGATE_MODE	X	O	O	O
	CLUSTER	X	X	X	O
	ORACLE_DRIVER	X	X	X	O

logmirror

Command Usage

The following is a feature matrix for command usage of logmirror.

Table 4-51 Feature matrix for command usage of logmirror

Feature	1.x	2.x	3.1	3.2
--conf	X	O	O	O
--help	X	O	O	O
--infiniband	X	O	O	O
--master	X	O	O	O
--silent	X	O	O	O
--slave	X	O	O	O
--start	X	O	O	O
--stop	X	O	O	O

Configuration File

The following is a feature matrix for configuration file of logmirror.

Table 4-52 Feature matrix for configuration file of logmirror

Configuration	Feature	1.x	2.x	3.1	3.2
Common configuration	PORT	X	O	O	O
MASTER configuration	DSN	X	O	O	O
	HOST_IP	X	O	O	O
	HOST_PORT	X	O	O	O
	PROTOCOL	X	X	O	O
	USER_ID	X	O	O	O
SLAVE configuration	USER_PW	X	O	O	O
	LOG_PATH	X	O	O	O
	MASTER_IP	X	O	O	O

cymon

Command Usage

The following is a feature matrix for command usage of cymon.

Table 4-53 Feature matrix for command usage of cymon

Feature	1.x	2.x	3.1	3.2
--conf	X	O	O	O
--help	X	O	O	O
--cycle	X	O	O	O
--key	X	X	O	O
--start	X	O	O	O
--stop	X	O	O	O
--status	X	O	O	O

4.2 What's New in GOLDILOCKS 3.2

This chapter briefly describes the features added to GOLDILOCKS 3.2.

Architecture

System Architecture

It has not been changed.

Storage Internal

It has not been changed.

Transaction Control

It has not been changed.

Backup & Recovery

It has not been changed.

Database Information

DICTIONARY_SCHEMA

The following views have been added to enquire the information about audit policy object.

- AUDIT_POLICIES
- AUDIT_POLICY_OPTIONS
- AUDIT_POLICY_ENABLED

AUDIT_TRAIL has been added to enquire the audit record.

The following views are deleted.

- ALL_COL_PLACE
- DBA_COL_PLACE
- USER_COL_PLACE

INFORMATION_SCHEMA

It has not been changed.

PERFORMANCE_VIEW_SCHEMA

The following views have been added to enquire the information which can be listed in a system action and in a privilege action when defining audit policy options.

- **V\$AUDITABLE_DB_PRIVILEGES**
- **V\$AUDITABLE_SYSTEM_ACTIONS**

Server Property

Property for Global Temporary Table Has Been Added

TEMP_UNDO_ENABLED property has been added to assign the undo logging tablespace for the global temporary table.

TEMP_SEGMENT_CACHE_SIZE has been added to assign the segment cache size of the global temporary table or the global temporary index.

Recompile Feature Based on the Change of Pages Are Deleted

The recompile feature based on the change of pages, which is supported until 3.1, are deleted. Therefore, the following properties are not supported any more.

- **RECOMPILE_CHECK_MINIMUM_PAGE_COUNT**
- **RECOMPILE_PAGE_PERCENT**

Property for Auxiliary Tablespace Has Been Added

SYSTEM_MEMORY_AUX_TABLESPACE_SIZE property has been added to determine the size of the auxiliary tablespace

Property for Communication Data Compression Has Been Added

PACKET_COMPRESSION_THRESHOLD property has been added to determine whether to compress the communication data.

Property for Redo Log Compression Has Been Added

REDO_LOG_COMPRESSION_THRESHOLD property has been added to determine whether to compress the redo log.

USE_LARGE_PAGES Property Has Been Added

USE_LARGE_PAGES property has been added to use HugePage.

SQL

SQL Element

Data Type

It has not been changed.

Function

The following aggregation functions related to variation have been added.

STDDEV

STDDEV_POP

STDDEV_SAMP

VARIANCE

VAR_POP

VAR_SAMP

The string function **REVERSE** has been added.

The date function **MONTHS_BETWEEN** has been added.

Object

Audit Policy

Audit policy object which can audit SQL performance has been added.

Global Temporary Table

Global temporary table which is a temporary table depending on the session has been added.

SQL Language

Parallel Processing of ANALYZE TABLE Statement

Parallel processing option has been added to **ANALYZE TABLE** statement.

Audit Policy DDL

The following DDLs which can control audit policy objects have been added.

- Creating audit policy
 - **CREATE AUDIT POLICY**
- Dropping audit policy
 - **DROP AUDIT POLICY**
- Altering audit policy
 - **ALTER AUDIT POLICY**
- Activating audit policy
 - **AUDIT POLICY**
- Deactivating audit policy
 - **NOAUDIT POLICY**
- Dropping audit trail
 - **ALTER DATABASE CLEAR AUDIT TRAIL**

User DDL

User's default index tablespace has been added.

- Creating a user
 - **CREATE USER**
- Altering a user
 - **ALTER USER**

Table DDL

The following DDLs which alters the table object have been added.

- Altering the name of the table constraints
 - **ALTER TABLE name RENAME CONSTRAINT**
- Altering the table properties
 - **ALTER TABLE name READ { ONLY | WRITE }**
- Altering the specific shard name of a table in a cluster environment
 - **ALTER TABLE name RENAME SHARD**

DDL creating **global temporary table** has been added.

Index DDL

The following DDL altering an index object has been added.

- Altering the index name

- ALTER INDEX name RENAME TO

Cluster System DDL

The following DDL altering a cluster system object has been added.

- Assigning an irrecoverable cluster member
 - ALTER SYSTEM IRRECOVERABLE CLUSTER MEMBER

System DCL

The following DCL controlling a system object has been added.

- Setting the reconnection of a session using GLOBAL CONNECTION
 - ALTER SYSTEM RECONNECT GLOBAL CONNECTION

API

ODBC

odbc.ini

LOCATOR_SERVICE and PACKET_COMPRESSION_THRESHOLD have been added to **odbc.ini file** as a data source name keyword.

ALTERNATE_LOCATORS and CONNECTION_TIMEOUT have been added as a location keyword.

GLOBAL CONNECTION

It supports **global connection**.

Statement Attributes

SQL_ATTR_FETCH_FAILOVER has been added to the statement property values.

JDBC

Connection Property

packet_compression_threshold has been added to **connection property**.

Embedded SQL

EXEC SQL GET GROUPID INTO statement has been added.

PDO

PDO driver which can access GOLDILOCKS from PDO has been added from Venus 3.2 version.

PyDBC

PyDBC which is API for python language is provided from Venus 3.2 version.

Ruby

Ruby driver which is API for ruby language is provided from Venus 3.2 version.

Hibernate

The source which can interwork with **hibernate**, Java ORM framework, is provided from Venus 3.2 version.

Utility

gcreatedb

It has not been changed.

glsnr

It has not been changed.

gsql/gsqlnet

DDL Output of an Audit Policy Object

`\ddl_audit_policy`, an interactive command, has been added to output DDL of an audit object.

SET HEADING {ON | OFF}

`\set heading` has been added to set whether to output the header in the query result.

gloader/gloadernet

WHERE Clause

The following conditional clauses can be set in an export (data download).

- `WHERE`
- `--where`

`--group-id`

gloader command argument `--group-id` has been added.

`--directio-size`

gloader command argument `--directio-size` has been added.

gdump

It has not been changed.

tablediff

It has not been changed.

gsyncher

It has not been changed.

gmon

It has not been changed.

gtrclogger

It has not been changed.

glocator

Configuration

ALTERNATE_LOCATORS has been added as a configuration keyword which is related to the replication.

Argument

--sync option has been added to an argument.

gagent

Configuration

ALTERNATE_LOCATORS has been added as a configuration keyword.

gloctl

Configuration

Configuration file which sets the driving environment of gloctl has been added.

conf option which assigns the configuration file has been added.

--dsn

dsn option of when driving gloctl is deleted.

Replication

cyclone

Recovery function has been added.

Operating CYCLONE in Cluster function has been added.

Database supporting the slave supports ORACLE_DRIVER as well as GOLDLOCKS.

Executing options of the standalone have been added.

Local **executing options** have been added.

logmirror

It has not been changed.

cymon

It has not been changed.

4.3 Patch Notes

3.2.14 Patch Note

ISSUE-6253 It supports the property to use the normal page when it fails to allocate the shared memory using the large page.

Description

It supports `USE_LARGE_PAGES` property. This property allows to use the normal page and the large page when allocating the shared memory. This property also allows to allocate the shared memory using the normal page when it fails to allocate the shared memory using the large page.

Workaround

The patch is required.

3.2.13 Patch Note

ISSUE-5862 If the connection object is shared in the multi-thread program of JDBC, the deadlock occurs.

Description

If the connection object is shared and used in the multi-thread program, the deadlock occurs.

Workaround

Create each different connection object per the thread, and use them.

3.2.12 Patch Note

```

        1,
        SQL_C_LONG,
        sI1,
        sizeof(SQLINTEGER),
        sI1Ind );
sRet = SQLSetStmtAttr( sStmt,
                      SQL_ATTR_ROW_BIND_TYPE,
                      (SQLPOINTER)SQL_BIND_BY_COLUMN,
                      0 );
sRet = SQLSetStmtAttr( sStmt,
                      SQL_ATTR_ROW_STATUS_PTR,
                      sRowStatus,
                      0 );
sRet = SQLExecute( sStmt );
sRet = SQLFetch( sStmt );
switch( sRet )
{
    case SQL_SUCCESS_WITH_INFO:
        for( i = 0; i < sFetched; i++ )
            printf( "row status: %d\n", sRowStatus[i]);
        break;
    default
        break;
}

```

The data can not be converted to number is included, but all row statuses are SQL_ROW_SUCCESS.

```

row status: 0
row status: 0
row status: 0
row status: 0

```

Workaround

The patch is required.

ISSUE-3534 gagent does not shutdown the server, but the server is terminated by itself during the cluster failover process.

Description

If gagent receives the non-viability result during the cluster failover process, then gagent used to shutdown the server by executing SHUTDOWN ABORT. However it has been changed so the server is terminated by itself.

ISSUE-3534 glocator is changed to transfer the result only to gagent which enquired while processing the cluster failover.

Description

glocator transfers the failover result not only to gagent which enquired but also to another gagent which is a failover target, during the cluster failover process. However, in this case, gagent which is a failover target also transfers a query to glocator to process the cluster failover. Therefore, glocator is changed to transfer the result only to gagent which enquired.

ISSUE-3314 When registerOutParameter() and set..() which are the method of CallableStatement in JDBC are used in the same parameter, then the normal value can not be get.

Description

A bind type is set to INPUT OUTPUT by using registerOutParameter() method and set...() method to get the out parameter value by calling the procedure whose bind type is not clear by using CallableStatement. Then, it does not return the normal value when calling get...() method to get the result value of the out parameter.

Symptom

Create a table and a procedure as follows.

```
CREATE TABLE PROC_TABLE ( I1 INTEGER );
INSERT INTO PROC_TABLE VALUES ( 1 );
INSERT INTO PROC_TABLE VALUES ( 2 );
INSERT INTO PROC_TABLE VALUES ( 3 );
INSERT INTO PROC_TABLE VALUES ( 4 );
INSERT INTO PROC_TABLE VALUES ( 5 );
```

```

INSERT INTO PROC_TABLE VALUES ( 6 );
COMMIT;
CREATE OR REPLACE PROCEDURE PROC_TEST_1( A1 INTEGER, A2 OUT INTEGER )
  IS
  BEGIN
    SELECT COUNT(*)
      INTO A2
    FROM PROC_TABLE
    WHERE I1 >= A1;
  END;
/

```

The following is a result of calling the procedure PROC_TEST_1 in gsql. The result value is stored in the out value of the second parameter.

```

gSQL> var v1 integer
gSQL> var v2 integer
gSQL> exec :v1 := 1
gSQL> call proc_test_1 (:v1,:v2);
Procedure Call complete.
gSQL> print
NAME                VALUE
-----
VAR_ELAPSED_TIME__  null
V1                   1
V2                   6
gSQL>

```

The following is a part of the program code, calling procedure PROC_TEST_1.

```

CallableStatement sCstmt = aCon.prepareStatement( "CALL PROC_TEST_1( ?, ? )" );
sCstmt.setInt( 1, 1 );
sCstmt.setInt( 2, 1 );
sCstmt.registerOutParameter( 1, Types.INTEGER );
sCstmt.registerOutParameter( 2, Types.INTEGER );
sCstmt.execute();
System.out.println("OUTPUT: " + sCstmt.getInt(1) + ", " + sCstmt.getInt(2) );
sCstmt.close();

```

When executing the program, then the out parameter value is stored in the first parameter as follows instead of the second parameter.

OUTPUT: 6, 0

Workaround

Make sure the input, output types as follows, and avoid using set method neither registerOutParameter method above, then the normal result is output.

```
CallableStatement sCstmt = aCon.prepareCall( "CALL PROC_TEST_1( ?, ? )" );
sCstmt.setInt( 1, 1 );
sCstmt.registerOutParameter( 2, Types.INTEGER );
sCstmt.execute();
System.out.println("OUTPUT: " + sCstmt.getInt(1) + ", " + sCstmt.getInt(2) );
sCstmt.close();
```

OUTPUT: 1, 6

ISSUE-3302 An error occurs when executing `getBytes()` method which is the method of `CallableStatement` in JDBC.

Description

When the out parameter type in `CallableStatement` is either `BINARY`, `VARBINARY` or `LONG VARBINARY`, then using `getBytes()` method causes an error.

Symptom

The following is an example of registering the out parameter as `Types.BINARY` in `CallableStatement`.

```
CallableStatement sCstmt = aCon.prepareCall( "BEGIN ? := x'aaff'; END; " );
sCstmt.registerOutParameter(1, java.sql.Types.BINARY);
sCstmt.executeUpdate();
byte[] sValue = sCstmt.getBytes(1);
```

When executing the program containing the codes above, then an error occurs.

```
Exception in thread "main" java.lang.ArrayIndexOutOfBoundsException: -1
    at indep.jdbc.dt.RowCache.readBytes(RowCache.java:637)
    at indep.jdbc.dt.Column.getBytes(Column.java:589)
    at indep.jdbc.core.JdbcCallableStatement.getBytes(JdbcCallableStatement.java:316)
```

Workaround

The patch is required.

gloader command argument *--group-id* has been added.

Description

--group-id argument uploads the data in the sharded table by group in the cluster environment.

gloader command argument *--directio-size* has been added.

Description

--directio-size argument is used to modify the direct IO size.

3.2.10 Patch Note

ISSUE-3253 When recovering the offline tablespace during the service, then it does not recover the log written on the log buffer.

Description

When switching the offline tablespace in GOLDILOCKS to online, it may requires the recovery or may not. The recovery is required when *IMMEDIATE* option is used in the offline statement, or when that tablespace was shifted to offline due to an error occurred in the data file during the operation. In this case, the log about that tablespace may remain in the buffer, but the recovery is performed only with the logs written on the log file, so the system can be abnormally terminated or the database becomes inconsistent.

Symptom

It creates the table T1 in the tablespace created by a user, then deletes the datafile and creates the checkpoint while the transaction TX1 updates T1. If the datafile does not exists while performing the checkpoint, then it shifts that tablespace to offline, then rolls back the transaction TX1. Moreover, if recovering the offline tablespace and shifting to online when the log in the log buffer is not written on the disk yet, then the it is abnormally terminated.

Workaround

The patch is required.

ISSUE-3222 When GOLDILOCKS system process in the cluster environment hangs up, then the entire system stops.

Description

If the GOLDILOCKS system process of the remote cluster member hangs up, so it can not transfer the respond when waiting for the response after transferring the protocol to the remote cluster member in the cluster environment, then not only the session waiting for the response but also the entire system stops. It happens because the query timeout or the session status is not checked for the protocol which should receive the respond within GOLDILOCKS. This error has been fixed by terminating the session which does not responds within the specified time or by making the remote cluster member which does not responds to be failover then proceeding the service.

When using the policy terminating the session, it waits for the time (seconds) specified in `CLUSTER_PROTOCOL_SESSION_FATAL_POLICY_TIMEOUT`, then terminates the session. However, when using the failover policy, it waits for the time (seconds) specified in `CLUSTER_PROTOCOL_FAILOVER_POLICY_TIMEOUT`, then it makes the remote cluster member which does not responds to be failover.

Symptom

When committing in the session connected to G1N1 after making the commit server of G1N2 member in an 1 by 2 cluster which consists of G1N1, G1N2 to hang up, then the session can not receive the response so stops.

When performing `ALTER SYSTEM SWITCH LOGFILE` in the session connected to G1N1 after making the gmaster of G1N2 member to hangup, then the session can not receive the response and stops.

Workaround

The patch is required.

ISSUE-3175 gpec can not process the annotation in #define statement.

Description

If an annotation exists in #define statements, then gpec can not process it.

Symptom

The macro AA in the following gc file should be same, which is 1. However, gpec can not process the annotation in the macro, so it is processed wrong. If gpec processes the following gc file, then the warning message is output.

```
#define AA 1 /* comment */  
#define AA 1
```

```
ERR-42000(41028): 'AA' macro is already defined at line 3, in file test.gc
```

Workaround

The patch is required.

ISSUE-3175 gpec can not process define statement normally in #if, #else.

Description

If #define is used between #if and #endif or between #else and #endif, the gpec can not normally process it.

Symptom

If #define which belongs to the false condition exists between #if and #endif or between #else and #endif, the gpec should not process it, but it actually processes it.

gpec should not process *#define AA 2* which is the false condition in the following gc file, but actually gpec does not ignore it instead processes it so that an error occurs.

```
#if 1  
#define AA 1  
#else  
#define AA 2  
#endif
```

```
ERR-42000(41028): 'AA' macro is already defined at line 4, in file test.gc
```

Workaround

The patch is required.

ISSUE-3175 The number #define statements which are processed by gpec is fixed.

Description

The number of #define statements managed by gpec is fixed into 256, and if it exceeds 256, then an error occurs.

Symptom

If the number of each different #define statements in the gc file exceed 256, then the following error occurs.

```
ERR-42000(41000): syntax error at line 258, in file test.gc  
ERR-42000(41027): too many 'define' macro (256)
```

Workaround

The patch is required.

ISSUE-3175 gpec can not process the empty bracket annotation normally.

Description

If the bracket annotation containing any contents comes next to the empty bracket annotation such as /* */, then gpec can not parsing it normally.

Symptom

An empty bracket annotation and an ordinary bracket annotation are used together in the following gc file.

```
/**/  
EXEC SQL BEGIN DECLARE SECTION;  
int value;  
EXEC SQL END DECLARE SECTION;  
/* comment */  
EXEC SQL SELECT 1 INTO :value FROM DUAL;
```

If gpec parses this gc file, then the following error occurs during the progress.

```
ERR-42000(41000): syntax error at line 8, in file a.gc:
```

```
SELECT 1 INTO :value FROM DUAL;
                ^  ^
```

```
Error at line 1
```

```
ERR-42000(41002): Host variable "value" not declared
```

```
ERR-42000(41006): Fatal error while doing embedded SQL precompiling
```

Workaround

Do not use an empty bracket annotation.

ISSUE-3243 When glsnr receives the wrong protocol it is terminated.

Description

When glsnr receives the wrong protocol, then it is terminated, and this error has been fixed. After the modification glsnr is not terminated though the following log message is output.

```
2020-01-15 17:57:51.835036 THREAD(27742,139777341413120) ]
[LISTENER] Invalid communication protocol : 192.168.0.123
```

Symptom

When glsnr receives the wrong protocol, glsnr outputs the following log message then is terminated.

```
[2020-01-15 11:14:28.738666 THREAD(5706,140285308184384) ]
[LISTENER] abnormally terminated
ERR-08S01(24001): Invalid communication protocol
```

Workaround

The patch is required.

ISSUE-3174 LOCALITY_GROUP_POLICY, LOCALITY_GROUP_PATH, LOCALITY_MEMBER_POLICY, LOCALITY_MEMBER_PATH have been added to ODBC properties.

Description

The followings have been added to ODBC properties.

- LOCALITY_GROUP_POLICY

- LOCALITY_GROUP_PATH
- LOCALITY_MEMBER_POLICY
- LOCALITY_MEMBER_PATH

ISSUE-3220 When multiple subquery conditions exists for more than three joins, some subquery conditions are omitted

Description

If two or more subquery conditions exist when joining three more more tables, then the location in which the subquery conditions are processes is determined. (push-down subquery filter)

In this case, if the first subquery condition is placed at the lowest table, and the second subquery condition is placed at the upper join, then the first subquery condition is omitted.

Symptom

Create the table and the data as follows.

```
CREATE TABLE r ( r_c1 INTEGER,
                 r_c2 INTEGER );
COMMIT;
CREATE TABLE s ( s_c1 INTEGER,
                 s_c2 INTEGER );
COMMIT;
CREATE TABLE t ( t_c1 INTEGER,
                 t_c2 INTEGER );
COMMIT;
CREATE TABLE u ( u_c1 INTEGER,
                 u_c2 INTEGER );
COMMIT;
CREATE TABLE v ( v_c1 INTEGER,
                 v_c2 INTEGER );
COMMIT;
INSERT INTO r VALUES ( 1, 1 );
INSERT INTO s VALUES ( 1, 1 );
INSERT INTO t VALUES ( 1, 1 );
INSERT INTO u VALUES ( 1, 1 );
INSERT INTO v VALUES ( 1, 1 );
COMMIT;
```

If *EXISTS* condition exists like as the following query, then the result satisfying the condition does not exist

t.

```

SELECT
    *
FROM r,
    s,
    t
WHERE r_c1 = s_c1
    AND s_c1 = t_c1
    AND EXISTS (
        SELECT u_c1
        FROM u
        GROUP BY u_c1
        HAVING u_c1 < 0
    )
;
no rows selected.

```

However, if *AND NOT EXISTS* subquery condition is inserted to the query above as follows, then the wrong query result is created.

```

--# wrong result
SELECT
    *
FROM r,
    s,
    t
WHERE r_c1 = s_c1
    AND s_c1 = t_c1
    AND EXISTS (
        SELECT u_c1
        FROM u
        GROUP BY u_c1
        HAVING u_c1 < 0
    )
    AND NOT EXISTS ( SELECT *
                    FROM v
                    WHERE v_c1 = r_c1 + s_c1 )
;
R_C1 R_C2 S_C1 S_C2 T_C1 T_C2
-----

```

```

1 1 1 1 1 1
1 row selected.

```

Workaround

Insert `NO_PUSH_SUBQ` hint to `NOT EXISTS` subquery as follows, then the correct result is obtained.

```

SELECT
    *
FROM r,
    s,
    t
WHERE r_c1 = s_c1
    AND s_c1 = t_c1
    AND EXISTS (
        SELECT u_c1
        FROM u
        GROUP BY u_c1
        HAVING u_c1 < 0
    )
    AND NOT EXISTS ( SELECT /*+ NO_PUSH_SUBQ */ *
        FROM v
        WHERE v_c1 = r_c1 + s_c1 )
;
no rows selected.

```

ISSUE-3199 It can not be processed normally when obtaining GroupId in array in EmbeddedSQL.

Description

The program is abnormally terminated when obtaining GroupId in array then executing the cached SQL statement again.

Symptom

```

EXEC SQL BEGIN DECLARE SECTION;
int sGroupId[5];
int sValue[5];
EXEC SQL END DECLARE SECTION;
int i;

```

```

for( i = 0; i < 5; i++ ) {
    sValue[i] = i;
}
EXEC SQL GET GROUPID INTO: sGroupId
        INSERT INTO TEST_T1 VALUES( :sValue );
EXEC SQL
        INSERT INTO TEST_T1 VALUES( :sValue );

```

The program is abnormally terminated if performing the cached `INSERT INTO TEST_T1 VALUES(:sValue)` statement again.

Workaround

Do not use an array, otherwise alter the host variable not to use the cached SQL statement.

ISSUE-3197 gpec can not process `< ... >` string normally.

Description

If `< >` exists on the same line, then gpec can not parsing it normally.

Symptom

```

for( i = 0; i < 5; i++ ) { // > COMMENT
    sValue[i] = i;
}

```

It can not process `< 5; i++) { // >` string normally, so an error occurs when performing gpec.

Workaround

Write the gc file by relocating the bracket or the comment as follows.

```

for( i = 0; i < 5; i++ ) // > COMMENT
{
    sValue[i] = i;
}

```

```

for( i = 0; i < 5; i++ ) {
// > COMMENT
sValue[i] = i;
}

```

3.2.9 Patch Note

ISSUE-3188 set heading has been added in gsql.

Description

It can be set whether to output the header in the query result by using *set heading {on/off}*.

3.2.8 Patch Note

ISSUE-3175 gpec can not process a non-ascii character.

Description

When gpec processes the preprocessor whose `#if`, `#ifdef`, `#elif` and `#else` are false groups, the contents in the group are converted into whitespaces. However, a non-ascii character in the false group is not converted into a whitespace.

Symptom

```
#if 0
EXEC SQL INSERT INTO TEST_T1 VALUES( :sC1, :sC2 ); -- 주석
#endif
```

When gpec processes the example above, then all contents should be converted into whitespaces, but a non-ascii character remains the same.

```
주석
```

Workaround

Process a non-ascii character in a form of c annotation.

ISSUE-2958 The group ID of the SQL statement can be obtained in the embedded SQL.

Description

It obtains the the group ID of the delete/ insert/ select/ update statement in the table in which the shard key is set, in the cluster environment which uses the global connection. For more information, refer to EXEC SQL GET GROUPID INTO.

ISSUE-3186 When two nodes are abnormally terminated at a time, then a hang may occur during the failover.

Description

When a domain coordinator node and a global coordinator node are abnormally terminated at a time, then a hang may occur during the failover, and this error has been fixed.

Symptom

A hang may occur during the failover, then the online transaction service of the groups to which the abnormally terminated nodes belong may stop operating.

Workaround

The patch is required.

3.2.7 Patch Note

ISSUE-3093 An error occurs while gpec parses the preprocessor #define.

Description

An error occurs when C reserved word comes to the alternative string of the preprocessor #define.

Symptom

```
#define SQLCA_STORAGE_CLASS extern
```

A parsing error occurs when executing gpec.

```
$ gpec test.gc
FileName: test.gc
Pre-compile test.gc -> test.c
```



```
ERR-42000(41000): syntax error at line 1, in file test.gc:
#define SQLCA_STORAGE_CLASS extern
.....^
Error at line 1, in file test.gc
```

Workaround

Define the keyword in an ordinary header file which does not execute gpec.

3.2.6 Patch Note

ISSUE-3149 gpec can not parse the file normally which uses a structure array in SELECT INTO statement.

Description

gpec can not process the gc file normally which uses a structure array as a host variable in SELECT INTO statement.

Symptom

```
EXEC SQL BEGIN DECLARE SECTION;
typedef struct AA
{
    char c1[10+1];
    char c2[10+1];
    char c3[10+1];
    char c4[10+1];
} AA;
AA sArr[10];
EXEC SQL END DECLARE SECTION;
EXEC SQL SELECT c1,c2,c3, c4
        INTO :sArr FROM EMP;
STL_TRY(sqlca.sqlcode == 0);
```

SELECT INTO statement in the example above is altered to the following incorrect statement.

```
sqlargs.sqlstmt = (char *)"SELECT c1,c2,c3,c4\n"
"    INTO :sArr ?, ?FROM EMP\n"
```

Workaround

The patch is required.

ISSUE-3145 SSA is increasing due to allocating the new memory even though the available memory exists in the session.

Description

The memories used after the session is started can be reused, and it is managed into multiple levels according to its size for an efficient memory allocation for the memory fragment. However, the new memory chunk is allocated when reallocating the released memory instead of the memory which is available to be reallocated to minimize the fragment, then it continuously increases SSA, and this error has been fixed.

Symptom

When viewing V\$SYSTEM_MEM_STAT while retrieving the table which includes LONG VARBINARY type, it can be viewed that VARIABLE_STATIC_ALLOC_SIZE is continuously increasing.

```
gSQL> SELECT STAT_NAME, ROUND(STAT_VALUE/1024/1024) FROM V$SYSTEM_MEM_STAT WHERE STAT_NAME =
'VARIABLE_STATIC_ALLOC_SIZE';
```

STAT_NAME	ROUND(STAT_VALUE/1024/1024)
VARIABLE_STATIC_ALLOC_SIZE	1800.25

1 row selected.

```
gSQL> SELECT STAT_NAME, ROUND(STAT_VALUE/1024/1024) FROM V$SYSTEM_MEM_STAT WHERE STAT_NAME =
'VARIABLE_STATIC_ALLOC_SIZE';
```

STAT_NAME	ROUND(STAT_VALUE/1024/1024)
VARIABLE_STATIC_ALLOC_SIZE	3663.41

1 row selected.

Workaround

The patch is required.

ISSUE-3144 gloder can not import the data normally when the first character of the field delimiter and that of the line terminator are the same.

Description

If the first character of the field delimiter and that of the line terminator are the same, then the data may be missing or gloder process may be abnormally terminated.

Symptom

```
>$ cat test.dat
1234^C2^C3456^S
>$ gloder test test -i --tablename TEST --fieldterm ^C --lineterm ^R\n --data test.dat
gSQL> SELECT * FROM TEST
I1   I2 I3
-----
1234 C2 3456S
1 row selected.
```

The first character of the field delimiter and that of the line terminator are the same, which is ^. The correct result value of the column I3 when gloder imported the data is supposed to be 3456^S, but the actual value is an incorrect value in which ^ is missing.

Workaround

Use different characters for the first character of the field delimiter and that of the line terminator each other.

3.2.5 Patch Note

ISSUE-3093 gpec can process #define and #undef only when they were declared in the declare section. Also, it does not alter the statement about the false value of *if group* such as #ifdef into a white space.

Description

gpec processed #define and #undef which were declared in the declare section, so it can not process the macro in the if group such as #if, #ifdef. Also it does not alter the c code of the *if group* which correspond

ds to the false value into a white space, so preprocessor is not available in the middle of the c code or the SQL statement.

Symptom

If preprocessors `#define` and `#undef` are not declared in the declare section, then gpec can not recognize the corresponding macro because it could not process `#define` and `#undef`. A user should repeatedly write the same contents because it can not use SQL the preprocessor corresponding to the *if group* in the middle of SQL.

```
#define _DEV_
EXEC SQL BEGIN DECLARE SECTION;
char
#ifdef _DEV_           ❶
sTrue[10];           ❷
#else
sFalse[10];
#endif
EXEC SQL END DECLARE SECTION;
EXEC SQL SELECT      ❸
#ifdef _DEV_
    "true" INTO :sTrue
#else
    "false" INTO :sFalse
#endif
FROM DUAL;
```



- ❶ It is false because `_DEV_` is declared outside of the declare section.
- ❷ The preprocessor is not processed as a white space, so gpec processes it as a parsing error.
- ❸ An error occurs during parsing the SQL statement.

Workaround

Declare the preprocessors `#define` and `#undef` in the declare section, and do not use preprocessors in the middle of the c code and the SQL statement.

ISSUE-3075 An error occurs because the data type is changed when repeatedly executing `PreparedStatement.setCharacterStream(int, Reader, int)` method and `PreparedStatement.addBatch()` method in JDBC

Description

The data type was determined by using the parameter length when executing `PreparedStatement` class method of JDBC such as `setAsciiStream()`, `setBinaryStream()`, `setCharacterStream()` methods, and it has been changed to use only the long data type.

Symptom

When calling `addBatch()` method after setting the data of the length which was allowed for the `VARCHAR` type by `setCharacterStream()` method, and trying to set the data which exceeds the length which was allowed for the `VARCHAR` by `setCharacterStream()` method, then the data type is changed from `VARCHAR` to `LONG VARCHAR`, which is an error.

```
gSQL> create table t1 ( i1 long varchar );
Table created.
```

```
sPstmt.setCharacterStream( 1, new StringReader( DATA ), DATA.length() );
sPstmt.addBatch();
sPstmt.setCharacterStream( 2, new StringReader(BIG_DATA), BIG_DATA.length() );
sPstmt.addBatch();
```

Caused by: `java.sql.SQLException: Parameter type[LONG VARCHAR] is mismatch with previous type[VARCHAR] during batch`

Workaround

`setAscii/ Binary/ Character Stream()` methods of `PreparedStatement` class have two methods, which are the method with the parameter length and the method without the parameter length. Use the method without the parameter length among them.

ISSUE-3056 Characters which returns `TRUE/ FALSE` when performing `ResultSet.getBoolean()` in JDBC have been diversified.

Description

Previously, only "true", "false" character strings could be converted into boolean type when `ResultSet.getBoolean()` in JDBC, but "t", "f", "y", "n", "yes", "no", "on", "off", "1" and "0" characters can also be converted

ed into boolean type now.

Symptom

When reading "0" and "1" with `ResultSet.getBoolean()`, then an error occurs.

```
gSQL> create table t1 ( i1 varchar(10) );
Table created.
gSQL> insert into t1 values ( '1' );
1 row created.
gSQL> commit;
Commit complete.
```

```
ResultSet rs = stmt.executeQuery("select * from t1");

while(rs.next())
{
    System.out.println( rs.getBoolean(1) );
}
```

```
Exception in thread "main" java.sql.SQLException: The value[1] is out of range of [boolean]
type
```

Workaround

The patch is required.

ISSUE-3055 Transferring an invalid character when connecting server and client whose character sets are different each other

Description

It transfers an invalid character when connecting server and client whose character sets are different each other, and this error has been fixed.

Symptom

The user "가" is created in Linux server.

```
gSQL> create user "가" identified by test;
User created.
gSQL> grant create session to "가";
```

```
Grant succeeded.  
gSQL> commit;  
Commit complete.
```

An error occurs when connecting from Windows client to Linux server.

```
D:\goldilocks_home\bin>gsqlnet.exe "가" test  
ERR-28000(16004): invalid username/password; logon denied
```

It is operated normally when connecting from Linux client to Linux server.

```
% gsqlnet "가" test  
gSQL>
```

Workaround

Either set character sets in the server and that in the client same, or include only ASCII in a string which is used for the connection.

ISSUE-2359 cluster peer without a parent session

Description

A cluster peer without a parent session exists in a remote node, and this error has been fixed.

Symptom

When an error occurs while altering password when a parent session tries to login, then a cluster peer without a parent session may exist in a remote node

A cluster peer session may be created in a remote node while altering password, and if it fails to alter the password then the parent session is terminated without terminating the cluster peer session.

Workaround

The patch is required.

3.2.4 Patch Note

ISSUE-3026 Altering the location of AT statement when performing \ddl_tablespace in gsql

Description

AT statement is located in a wrong position when performing \ddl_tablespace in gsql, and this error has been fixed.

Symptom

An error occurs when performing SQL statement which is created with \ddl_tablespace.

```
gSQL> create tablespace test_tbs datafile 'test.dbf' size 10m;
Tablespace created.
gSQL> \ddl_tablespace test_tbs
SET SESSION AUTHORIZATION "SYS";
CREATE MEMORY DATA TABLESPACE "TEST_TBS"
    DATAFILE
        '/home/sunje/goldilocks_data/db/test.dbf'
        AT "G2N1"
        SIZE 10485760 REUSE
    ,
        '/home/sunje/goldilocks_data/db/test.dbf'
        AT "G2N2"
        SIZE 10485760 REUSE
    ONLINE
    LOGGING
    EXTSIZE 262144
;
COMMIT;
```

```
gSQL> CREATE MEMORY DATA TABLESPACE "TEST_TBS"
    DATAFILE
        '/home/sunje/goldilocks_data/db/test.dbf'
        AT "G2N1"
        SIZE 10485760 REUSE
    ,
        '/home/sunje/goldilocks_data/db/test.dbf'
        AT "G2N2"
        SIZE 10485760 REUSE
    ONLINE
```



```

LOGGING
EXTSIZE 262144;
ERR-42000(40000): syntax error:
      AT "G2N1"
      ^^
Error at line 4

```

Workaround

Alter the location of AT statement in SQL which is created with \ddl_tablespace.

```

gSQL> CREATE MEMORY DATA TABLESPACE "TEST_TBS"
DATAFILE
  '/home/sunje/goldilocks_data/db/test.dbf'
SIZE 10485760 REUSE
AT "G2N1"
,
  '/home/sunje/goldilocks_data/db/test.dbf'
SIZE 10485760 REUSE
AT "G2N2"
ONLINE LOGGING
EXTSIZE 262144;
Tablespace created.

```

ISSUE-3023 BEGIN BACKUP AT DOMAIN error

Description

It is not normally operated when using AT DOMAIN clause to backup only within a specific group or a member, and this error has been fixed.

Symptom

BEGIN BACKUP fails even when the member G1N2 is being operated with ARCHIVELOG as follows.

```

gSQL> SELECT ARCHIVELOG_MODE FROM V$ARCHIVELOG;
ARCHIVELOG_MODE
-----
ARCHIVELOG
1 row selected.
gSQL> ALTER DATABASE BEGIN BACKUP AT G1N2;
ERR-HY000(16247): MEMBER(G1N1): cannot BACKUP; noarchive log mode

```

Workaround

Perform BACKUP BEGIN/ END without using AT DOMAIN.

3.2.3 Patch Note

ISSUE-3006 A transaction is created when performing EXPLAIN PLAN ONLY

Description

A transaction is created when performing EXPLAIN PLAN ONLY, and this error has been fixed.

Symptom

```

gSQL> select * from x$transaction;
no rows selected.
gSQL> \explain plan only update t2 set c2 = 1 where c1 = 10;
>>> start print plan
< Execution Plan >
=====
====
|  IDX  |  NODE DESCRIPTION          |
ROWS |
-----
|    0  |  UPDATE STATEMENT          |
|      |
|    1  |  UPDATE ("T2")             |
0 |
|    2  |  INDEX ACCESS ("T2", "T2_PRIMARY_KEY_INDEX") [CLONED] |
0 |
=====
====
0 - SQL : UPDATE "PUBLIC"."T2"@LOCAL "_A1" SET("C2")=(:_V0) WHERE "_A1"."C1" = :_V1
2 - READ INDEX COLUMNS : C1
    MIN RANGE : C1 = 10
    MAX RANGE : C1 = 10
<<< end print plan
gSQL> select * from x$transaction;

```



```

gSQL> ALTER TABLE T1 ADD PRIMARY KEY ( C1 );
Table altered.
gSQL> INSERT INTO T1 VALUES ( 1 );
1 row created.
gSQL> COMMIT;
Commit complete.

```

Delete a record (transaction T1) of group G1 in a session (session 1) connected to a member of group G2, then execute a global transaction (transaction T2) in another session (session 2) and commit. When committing T1 and retrieving the record of G1, while T2 is completed in group G1 and is not completed in G2, then the deleted record is retrieved.

```

gSQL> DELETE FROM T1 WHERE C1 = 1;    // T1 -- session 1
1 row deleted.
gSQL> CREATE TABLE T2 ( I1 INTEGER ); // T2 -- session 2
Table created.
gSQL> COMMIT;                          // -- session 2
Commit complete.
gSQL> COMMIT;                          // -- session 1
Commit complete.
gSQL> SELECT * FROM T1 WHERE C1 = 1;    // -- session 1
C1
--
1
1 row selected.

```

Workaround

When selecting after executing a domain transaction in the same session, execute it by replacing the SELECT statement with SELECT FOR UPDATE.

ISSUE-2965 Data is missing when BigDecimal types is used as a parameter in JDBC

Description

If the value exceeding the double type precision is used as a parameter in BigDecimal type, then the data is missing, and this error has been fixed.

Symptom

The data is missing without the user's intention.

```
gSQL> CREATE TABLE T1 ( C1 NUMBER );
Table created.
```

```
PreparedStatement pstmt = con.prepareStatement("INSERT INTO T1 VALUES (?)");
pstmt.setBigDecimal(1, new BigDecimal("12345678901234567890.123456789"));
pstmt.executeUpdate();
```

```
gSQL> select * from t1;
                C1
-----
12345678901234600000
1 row selected.
```

Workaround

Process it with a string instead of the BigDecimal type.

```
pstmt.setString(1, "12345678901234567890.123456789");
```

```
gSQL> \set numsize 40
gSQL> select * from t1;
                C1
-----
12345678901234567890.123456789
1 row selected.
```

ISSUE-2955 gsqlnet can not consecutively execute cstartup or cshutdo wn in cluster environment.

Description

gsqlnet builds the connecting information of a location file and glocator through ODBC.

This information is built when executing cstartup or cshutdown for the first time.

When executing cstartup or cshutdown for the second time, then it ignores the information construction process. However, the flag configuration is wrong, so an error occurs.

Symptom

An error occurs when gsqlnet process executes cstartup or cshutdown, then executes it again.

Workaround

Restart gsqlnet session and execute cstartup or cshutdown.

ISSUE-2943 agable scn does not increase when a query timeout occurs in cluster environment.

Description

When processing DML in async in a cluster environment, it sets the view scn information of remote members in a session. In this case, if an exception such as query timeout occurs when there is not any remote member to whom DML is successfully transferred, then the view scn information of remote members set in the session can not be initialized, and which is a bug. Therefore, the agable scn of the system does not increase while the session is connected even though the statement in progress does not exist in a system.

Therefore, it is fixed to initialize the view scn information of remote members when an exception occurs while processing an async to prevent an error.

Symptom

agable scn stops after a query timeout occurs in cluster environment, so the undo, data segments become insufficient.

Workaround

Terminate the session in which a query timeout occurred.

ISSUE-2927 Deadlock Due to the Lack of Transaction Slot

Description

A hang may occur due to the lack of transaction slots when all server processes allocate transaction slots and the transactions do not release slots. It is fixed to make an error on the corresponding patch when the specified time passed.

Symptom

A hang may occur due to the lack of transaction slots when multiple transactions simultaneously occur in multiple sessions.

Workaround

The patch is required.

ISSUE-2922 Adding SQL_ATTR_FETCH_FAILOVER to statement attribute in ODBC

Description

SQL_ATTR_FETCH_FAILOVER has been added to statement attribute in ODBC, and the following values can be set.

- SQL_FETCH_FAILOVER_OFF
- SQL_FETCH_FAILOVER_ON

```
SQLSetStmtAttr( stmt,
                SQL_ATTR_FETCH_FAILOVER,
                (SQLPOINTER)SQL_FETCH_FAILOVER_ON,
                0 )
```

Symptom

There is not any symptom.

Workaround

The patch is required.

ISSUE-2513 EXEC SQL AT :sConn DISCONNECT can not detect VARCHAR type

Description

gpec detects VARCHAR type as char type in EXEC SQL AT clause.

Symptom

When using VARCHAR type variable in EXEC SQL AT clause, gpec does not process it as VARCHAR type but processes it as char type.

- Example gc file

```
EXEC SQL BEGIN DECLARE SECTION;
VARCHAR sAT[20];
EXEC SQL END DECLARE SECTION;
EXEC SQL AT :sAT DISCONNECT;
```

- Example c file generated by gpec

```
sqlargs.conn = (char *)sAT;
sqlargs.sql_ca = &sqlca;
sqlargs.sql_state = SQLSTATE;
sqlargs.sqltype = 35;
sqlargs.sqlfn = (char *)__FILE__;
sqlargs.sqlln = __LINE__;
sqlargs.sqlstmt = NULL;
sqlargs.atomic = 0;
sqlargs.unsafenull = 0;
sqlargs.iters = 0;
DBESQL_Disconnect(NULL, &sqlargs, NULL, 0);
```

It processes VARCHAR type as char * type, so an error occurs when compiling a c file created by gpec.

Workaround

Use char type instead of VARCHAR type.

ISSUE-2349 When gpec processes a preprocessor, `__LINE__` macro indicates the wrong line.

Description

When gpec processes a preprocessor such as `#if`, `__LINE__` macro indicates the wrong line.

Symptom

When gpec processes a preprocessor such as `#if`, `#ifdef`, `#ifndef`, `#else`, `#elif`, a comment has been added so it leads to a wrong value unlike the intended `__LINE__` macro value.

- Example gc file

```
#if 0
    printf("[%s:%d] if\n", __FILE__, __LINE__);
#else
```



```

    printf("[%s:%d] else\n", __FILE__, __LINE__);
#endif
    printf("[%s:%d] endif\n", __FILE__, __LINE__);

```

The following is a result of which gpec processes the code.

- Example c file generated by gpec

```

#if 0
/*Macro condition FALSE*/
    printf("[%s:%d] if\n", __FILE__, __LINE__);
#else
/*Macro condition TRUE*/
    printf("[%s:%d] else\n", __FILE__, __LINE__);
#endif
    printf("[%s:%d] endif\n", __FILE__, __LINE__);

```

If gpec executes the created c file, then unexpected line is output.

```

$ ./pp_bug
[pp_bug.gc:9] else
[pp_bug.gc:11] endif

```

The following is a normal `__LINE__` macro value.

```

$ ./pp_bug
[pp_bug.gc:7] else
[pp_bug.gc:9] endif

```

Workaround

The patch is required.

3.2.1 Patch Note

ISSUE-2902 Deadlock When Referring to the Global Sequence Value in Cluster Environment

Description

A deadlock occurs while acquiring the global sequence latch for the entire cluster member to get the next value because the cached value in local members were run out when referring to the global sequence value in cluster environment.

Symptom

A hang occurs due to a deadlock when repeatedly performing a statement of which multiple sessions simultaneously refers to the global sequence.

Workaround

The patch is required.

Part II.

Administration Manual

5. Basic Management of GOLDILOCKS Database	217
5.1 Creating and Configuring GOLDILOCKS Database	218
Creating Database	218
Specifying Initial Property	219
Managing Initial Property Using GOLDILOCKS Configuration File	219
5.2 Starting up and Shutting down GOLDILOCKS Instance	221
Starting up Instance	221
Shutting down Instance	226
5.3 Managing Process	229
Master Process	229
Listener Process	234
5.4 Managing Memory	235
GOLDILOCKS Memory Architecture	235
Managing SSA	235
Managing PSA	236
5.5 Monitoring	237
Monitoring with Trace File	237
Monitoring Performance Using View	249
6. Structure and Storage Structure of GOLDILOCKS Database	251
6.1 Managing Control File	252
Control File Contents	252
Multiplexing Control File	254
Restoring Corrupted Control File	254
Control File Information	255
6.2 Managing Redo Log File	256
Redo Log File Structure	256
Redo Log Group and Its Member	257
Restoring Corrupted Redo Log File	258
Redo Log File Information	259
6.3 Managing Archive Redo Log File	260
Creating Archive Redo Log File	260
Maintaining and Dropping Archive Redo Log File	260
Multiplexing Archive Redo Log File Directory	261
6.4 Managing Tablespace	262
Tablespace Type	262
Managing Tablespace and Data File	262
6.5 Managing Data File	268
Data File Matching	268
Data File Information	269

7. Backup and Recovery of GOLDILOCKS Database	271
7.1 ARCHIVELOG Mode	272
ARCHIVELOG Mode	272
NOARCHIVELOG Mode	272
7.2 Backup and Recovery	274
Backup	274
Recovery	278
8. GOLDILOCKS Database Replication	293
8.1 Overview	294
8.2 Operating Method	295
CYCLONE	295
LOGMIRROR	300
8.3 Trace Log	302
Troubleshooting of CYCLONE	302
Troubleshooting of LOGMIRROR	303
9. Database Information	305
9.1 DICTIONARY_SCHEMA	306
Views of ALL_family	307
Views of DBA_family	370
Views of USER_family	427
Other Views	486
Aliased Synonym	501
9.2 INFORMATION_SCHEMA	502
COLUMNS	503
COLUMN_PRIVILEGES	506
CONSTRAINT_COLUMN_USAGE	507
CONSTRAINT_TABLE_USAGE	508
INFORMATION_SCHEMA_CATALOG_NAME	509
KEY_COLUMN_USAGE	510
PARAMETERS	511
REFERENTIAL_CONSTRAINTS	514
ROUTINES	516
ROUTINE_PRIVILEGES	520
ROUTINE_ROUTINE_USAGE	521
ROUTINE_SEQUENCE_USAGE	522
ROUTINE_TABLE_USAGE	523
SCHEMATA	524
SEQUENCES	525

SQL_FEATURES	526
SQL_IMPLEMENTATION_INFO	527
SQL_PACKAGES	528
SQL_PARTS	529
SQL_SIZING	530
STATISTICS	531
TABLES	532
TABLE_CONSTRAINTS	533
TABLE_PRIVILEGES	534
USAGE_PRIVILEGES	535
VIEWS	536
VIEW_ROUTINE_USAGE	537
VIEW_TABLE_USAGE	538
9.3 PERFORMANCE_VIEW_SCHEMA	539
GV\$ Global View	541
V\$AGABLE_INFO	543
V\$ARCHIVELOG	544
V\$AUDITABLE_DB_PRIVILEGES	545
V\$AUDITABLE_SYSTEM_ACTIONS	546
V\$BACKUP	547
V\$BALANCER	548
V\$CLUSTER_DISPATCHER	549
V\$CLUSTER_LOCATION	550
V\$CLUSTER_MEMBER	551
V\$COLUMNS	552
V\$CONTROLFILE	553
V\$DATAFILE	554
V\$DB_FILE	555
V\$DISPATCHER	556
V\$ERROR_CODE	557
V\$GLOBAL_TRANSACTION	558
V\$INCREMENTAL_BACKUP	559
V\$INSTANCE	560
V\$JOURNALING	561
V\$KEYWORDS	562
V\$LATCH	563
V\$LOGFILE	564
V\$LOCK_WAIT	565
V\$PROCESS_STAT	566

V\$PROCESS_MEM_STAT	567
V\$PROCESS_SQL_STAT	568
V\$PROPERTY	569
V\$PSM_RESERVED_WORDS	570
V\$QUEUE	571
V\$RESERVED_WORDS	572
V\$SESSION	573
V\$SESSION_AUDIT	574
V\$SESSION_CONNECT_INFO	575
V\$SESSION_EVENT	576
V\$SESSION_STAT	577
V\$SESSION_MEM_STAT	578
V\$SESSION_SQL_STAT	579
V\$SESSION_WAIT	580
V\$SHARED_MODE	581
V\$SHARED_SERVER	582
V\$SHM_SEGMENT	583
V\$SPROPERTY	584
V\$SQLFN_METADATA	585
V\$SQL_CACHE	586
V\$SQL_COMMAND	587
V\$SQL_HISTORY	588
V\$STATEMENT	589
V\$SYSTEM_EVENT	590
V\$SYSTEM_STAT	591
V\$SYSTEM_MEM_STAT	592
V\$SYSTEM_SQL_STAT	593
V\$TABLES	594
V\$TABLESPACE	595
V\$TABLESPACE_STAT	596
V\$TRANSACTION	597
V\$WAIT_EVENT_CLASS_NAME	598
V\$WAIT_EVENT_NAME	599
V\$XA_TRANSACTION	600
10. Server Property	601
10.1 Server Property Information	602
10.2 AGING_INTERVAL	603
Basic Information	603
Description	603

10.3	AGING_PLAN_INTERVAL	604
	Basic Information	604
	Description	604
10.4	ARCHIVELOG_DIR_1 ~ ARCHIVELOG_DIR_10	605
	Basic Information	605
	Description	605
10.5	ARCHIVELOG_FILE	606
	Basic Information	606
	Description	606
10.6	ARCHIVELOG_MODE	607
	Basic Information	607
	Description	607
10.7	BACKUP_DIR_1 ~ BACKUP_DIR_10	608
	Basic Information	608
	Description	608
10.8	BLOCK_READ_COUNT	609
	Basic Information	609
	Description	609
10.9	BULK_IO_PAGE_COUNT	610
	Basic Information	610
	Description	610
10.10	CDISPATCHER_HOT_POLICY_INTERVAL	611
	Basic Information	611
	Description	611
10.11	CDISPATCHER_SOCKET_BUFFER_SIZE	612
	Basic Information	612
	Description	612
10.12	CDISPATCHER_SYNC_THREADS	613
	Basic Information	613
	Description	613
10.13	CDISPATCHER_THREADS	614
	Basic Information	614
	Description	614
10.14	CHARACTER_SET	615
	Basic Information	615
	Description	615
10.15	CHAR_LENGTH_UNITS	616
	Basic Information	616
	Description	616

10.16	CHECK_DEDICATE_CONNECTION_INTERVAL	618
	Basic Information	618
	Description	618
10.17	CLIENT_MAX_COUNT	619
	Basic Information	619
	Description	619
10.18	CLIENT_NUMA_POLICY	620
	Basic Information	620
	Description	620
10.19	CLOSE_PSM_CHILD_STMTS	621
	Basic Information	621
	Description	621
10.20	CLUSTER_ASYNC_COMMIT	622
	Basic Information	622
	Description	622
10.21	CLUSTER_ASYNC_REPLICATION	623
	Basic Information	623
	Description	623
10.22	CLUSTER_CM_BUFFER_COUNT	624
	Basic Information	624
	Description	624
10.23	CLUSTER_CM_BUFFER_SIZE	625
	Basic Information	625
	Description	625
10.24	CLUSTER_CM_READ_BUFFER_SIZE	626
	Basic Information	626
	Description	626
10.25	CLUSTER_COMMIT_SLAVES	627
	Basic Information	627
	Description	627
10.26	CLUSTER_COMMIT_STREAM_ISOLATION	628
	Basic Information	628
	Description	628
10.27	CLUSTER_CONNECTION	629
	Basic Information	629
	Description	629
10.28	CLUSTER_CONNECTION_TIMEOUT_SEC	630
	Basic Information	630
	Description	630

10.29	CLUSTER_DATA_SYNC_SERVERS	631
	Basic Information	631
	Description	631
10.30	CLUSTER_DISPATCHER_IN_QUEUE_SIZE	632
	Basic Information	632
	Description	632
10.31	CLUSTER_DISPATCHER_NUMA_STREAM_MAP	633
	Basic Information	633
	Description	633
10.32	CLUSTER_DISPATCHER_OUT_QUEUE_SIZE	634
	Basic Information	634
	Description	634
10.33	CLUSTER_HEARTBEAT_INTERVAL	635
	Basic Information	635
	Description	635
10.34	CLUSTER_HEARTBEAT_RETRY_COUNT	636
	Basic Information	636
	Description	636
10.35	CLUSTER_IGNORE_INACTIVE_MEMBER	637
	Basic Information	637
	Description	637
10.36	CLUSTER_MAX_PACKET_SIZE	638
	Basic Information	638
	Description	638
10.37	CLUSTER_MAX_PAYLOAD_SIZE	639
	Basic Information	639
	Description	639
10.38	CLUSTER_PACKET_ALLOCATION_TIMEOUT	640
	Basic Information	640
	Description	640
10.39	CLUSTER_PROTOCOL_SESSION_FATAL_POLICY_TIMEOUT	641
	Basic Information	641
	Description	641
10.40	CLUSTER_PROTOCOL_FAILOVER_POLICY_TIMEOUT	642
	Basic Information	642
	Description	642
10.41	CLUSTER_SERVER_RESPONSE_QUEUE_SIZE	643
	Basic Information	643
	Description	643

10.42	CLUSTER_SPLIT_BRAIN_RESOLUTION_POLICY	644
	Basic Information	644
	Description	644
10.43	CLUSTER_SPLIT_BRAIN_RETRY_COUNT	645
	Basic Information	645
	Description	645
10.44	COMMITTER_HOT_POLICY_INTERVAL	646
	Basic Information	646
	Description	646
10.45	CONTROL_FILE_0 ~ CONTROL_FILE_7	647
	Basic Information	647
	Description	647
10.46	CONTROL_FILE_COUNT	648
	Basic Information	648
	Description	648
10.47	CONTROL_FILE_TEMP_NAME	649
	Basic Information	649
	Description	649
10.48	COORDINATOR_COMMIT_WRITE_MODE	650
	Basic Information	650
	Description	650
10.49	CSERVERS	651
	Basic Information	651
	Description	651
10.50	DATABASE_ACCESS_MODE	652
	Basic Information	652
	Description	652
10.51	DATABASE_INSTANCE_NAME	653
	Basic Information	653
	Description	653
10.52	DATA_STORE_MODE	654
	Basic Information	654
	Description	654
10.53	DA_CLIENT_NUMA_NODE	655
	Basic Information	655
	Description	655
10.54	DDL_AUTOCOMMIT	656
	Basic Information	656
	Description	656

10.55	DDL_LOCK_TIMEOUT	657
	Basic Information	657
	Description	657
10.56	DEFAULT_GLOBAL_SECONDARY_INDEX_CREATION	658
	Basic Information	658
	Description	658
10.57	DEFAULT_INDEX_LOGGING	659
	Basic Information	659
	Description	659
10.58	DEFAULT_INDEX_PCTFREE	660
	Basic Information	660
	Description	660
10.59	DEFAULT_INITRANS	661
	Basic Information	661
	Description	661
10.60	DEFAULT_MAXTRANS	662
	Basic Information	662
	Description	662
10.61	DEFAULT_PCTFREE	663
	Basic Information	663
	Description	663
10.62	DEFAULT_PCTUSED	664
	Basic Information	664
	Description	664
10.63	DEFAULT_REMOVAL_BACKUP_FILE	665
	Basic Information	665
	Description	665
10.64	DEFAULT_REMOVAL_OBSOLETE_BACKUP_LIST	666
	Basic Information	666
	Description	666
10.65	DEFAULT_SHARDING	667
	Basic Information	667
	Description	667
10.66	DISABLE_DDL_CDC_GIVEUP	670
	Basic Information	670
	Description	670
10.67	DISABLE_UPDATE_PK_CDC_GIVEUP	671
	Basic Information	671
	Description	671

10.68	DISALLOWED_PROTOCOL_TARGETTYPE	672
	Basic Information	672
	Description	672
10.69	DISALLOWED_PROTOCOL_TARGETTYPE_WITH_ALL	673
	Basic Information	673
	Description	673
10.70	DISALLOWED_PROTOCOL_TARGETTYPE_WITH_NAME	674
	Basic Information	674
	Description	674
10.71	DISPATCHER_CM_BUFFER_SIZE	675
	Basic Information	675
	Description	675
10.72	DISPATCHER_CM_UNIT_SIZE	676
	Basic Information	676
	Description	676
10.73	DISPATCHER_CONNECTIONS	677
	Basic Information	677
	Description	677
10.74	DISPATCHER_HOT_POLICY_INTERVAL	678
	Basic Information	678
	Description	678
10.75	DISPATCHER_LOAD_BALANCING	679
	Basic Information	679
	Description	679
10.76	DISPATCHER_NUMA_STREAM_MAP	680
	Basic Information	680
	Description	680
10.77	DISPATCHER_QUEUE_SIZE	681
	Basic Information	681
	Description	681
10.78	DISPATCHER_REQUEST_MINI_QUEUE_COUNT	682
	Basic Information	682
	Description	682
10.79	DISPATCHER_RESPONSE_MINI_QUEUE_COUNT	683
	Basic Information	683
	Description	683
10.80	DISPATCHERS	684
	Basic Information	684
	Description	684

10.81	FETCH_FAILOVER	685
	Basic Information	685
	Description	685
10.82	GLOBAL_CONNECTION_ALLOW_SESSION_DEPENDENCY	686
	Basic Information	686
	Description	686
10.83	GLOBAL_JOURNAL_BUFFER_SIZE	687
	Basic Information	687
	Description	687
10.84	GLOBAL_JOURNAL_BUFFER_TOTAL_MAX_SIZE	688
	Basic Information	688
	Description	688
10.85	GLOBAL_PROPERTY_LOCK_TIMEOUT	689
	Basic Information	689
	Description	689
10.86	GLOBAL_TRANSACTION_COMMIT_WRITE_MODE	690
	Basic Information	690
	Description	690
10.87	GLOBAL_TRANSACTION_ISOLATION_SCOPE	691
	Basic Information	691
	Description	691
10.88	GLOBAL_TRANSACTION_LOG_DIR	692
	Basic Information	692
	Description	692
10.89	GLOBAL_TRANSACTION_LOG_FILE_SIZE	693
	Basic Information	693
	Description	693
10.90	GMASTER_NUMA_NODE	694
	Basic Information	694
	Description	694
10.91	GMON_AUTOSTART	695
	Basic Information	695
	Description	695
10.92	HINT_ERROR	696
	Basic Information	696
	Description	696
10.93	IDLE_TIMEOUT	697
	Basic Information	697
	Description	697

10.94	INDEX_BUILD_PARALLEL_FACTOR	698
	Basic Information	698
	Description	698
10.95	INDEX_TREE_MERGE_PARALLEL_FACTOR	699
	Basic Information	699
	Description	699
10.96	INST_ALLOCATOR_COUNT	700
	Basic Information	700
	Description	700
10.97	INST_TABLE_BLOCK_SIZE	701
	Basic Information	701
	Description	701
10.98	IN_DOUBT_DECISION	702
	Basic Information	702
	Description	702
10.99	JOURNAL_TEMP_DIR	703
	Basic Information	703
	Description	703
10.100	KEEPALIVE_IDLE_TIME	704
	Basic Information	704
	Description	704
10.101	LOCAL_CLUSTER_MEMBER	705
	Basic Information	705
	Description	705
10.102	LOCAL_CLUSTER_MEMBER_HOST	706
	Basic Information	706
	Description	706
10.103	LOCAL_CLUSTER_MEMBER_PORT	707
	Basic Information	707
	Description	707
10.104	LOCAL_JOURNAL_BUFFER_SIZE	708
	Basic Information	708
	Description	708
10.105	LOCATION_FILE	709
	Basic Information	709
	Description	709
10.106	LOCATOR_QUERY_TIMEOUT	710
	Basic Information	710
	Description	710

10.107	LOCK_HASH_TABLE_SIZE	711
	Basic Information	711
	Description	711
10.108	LOG_BLOCK_SIZE	712
	Basic Information	712
	Description	712
10.109	LOG_BUFFER_SIZE	713
	Basic Information	713
	Description	713
10.110	LOG_DIR	714
	Basic Information	714
	Description	714
10.111	LOG_FILE_SIZE	715
	Basic Information	715
	Description	715
10.112	LOG_GROUP_COUNT	716
	Basic Information	716
	Description	716
10.113	LOG_MIRROR_MODE	717
	Basic Information	717
	Description	717
10.114	LOG_MIRROR_SHARED_MEMORY_STATIC_SIZE	718
	Basic Information	718
	Description	718
10.115	LOG_MIRROR_TIMEOUT	719
	Basic Information	719
	Description	719
10.116	LOG_SYNC_INTERVAL	720
	Basic Information	720
	Description	720
10.117	LOG_SYNC_INTERVAL_MSEC	721
	Basic Information	721
	Description	721
10.118	MAX_GROUP_COUNT	722
	Basic Information	722
	Description	722
10.119	MAX_JOURNAL_FILE_SIZE	723
	Basic Information	723
	Description	723

10.120	MAX_NODE_COUNT	724
	Basic Information	724
	Description	724
10.121	MAXIMUM_CONCURRENT_ACTIVITIES	725
	Basic Information	725
	Description	725
10.122	MAXIMUM_FLANGE_COUNT	726
	Basic Information	726
	Description	726
10.123	MAXIMUM_FLUSH_LOG_BLOCK_COUNT	727
	Basic Information	727
	Description	727
10.124	MAXIMUM_FLUSH_PAGE_COUNT	728
	Basic Information	728
	Description	728
10.125	MAXIMUM_JOURNAL_REPLAY_COUNT	729
	Basic Information	729
	Description	729
10.126	MAXIMUM_NAMED_CURSOR_COUNT	730
	Basic Information	730
	Description	730
10.127	MAXIMUM_SESSION_CM_BUFFER_SIZE	732
	Basic Information	732
	Description	732
10.128	MEASURE_CLUSTER_LATENCY	733
	Basic Information	733
	Description	733
10.129	MEMORY_MERGE_RUN_COUNT	734
	Basic Information	734
	Description	734
10.130	MEMORY_SORT_RUN_SIZE	735
	Basic Information	735
	Description	735
10.131	MINIMUM_UNDO_PAGE_COUNT	736
	Basic Information	736
	Description	736
10.132	MIN_SAMPLE_ROW_COUNT	737
	Basic Information	737
	Description	737

10.133	NET_BUFFER_SIZE	738
	Basic Information	738
	Description	738
10.134	NLS_DATE_FORMAT	739
	Basic Information	739
	Description	739
10.135	NLS_TIME_FORMAT	740
	Basic Information	740
	Description	740
10.136	NLS_TIME_WITH_TIME_ZONE_FORMAT	741
	Basic Information	741
	Description	741
10.137	NLS_TIMESTAMP_FORMAT	742
	Basic Information	742
	Description	742
10.138	NLS_TIMESTAMP_WITH_TIME_ZONE_FORMAT	743
	Basic Information	743
	Description	743
10.139	NUMA	744
	Basic Information	744
	Description	744
10.140	NUMA_MAP	745
	Basic Information	745
	Description	745
10.141	OFFLINE_MEMBER_AFTER_FAILOVER	746
	Basic Information	746
	Description	746
10.142	ONLINE_JOURNAL_REPLAY_THRESHOLD	747
	Basic Information	747
	Description	747
10.143	OS_GROUP_ACCESS	748
	Basic Information	748
	Description	748
10.144	PACKET_COMPRESSION_THRESHOLD	749
	Basic Information	749
	Description	749
10.145	PAGE_CHECKSUM_TYPE	750
	Basic Information	750
	Description	750

10.146	PARALLEL_IO_FACTOR	751
	Basic Information	751
	Description	751
10.147	PARALLEL_IO_GROUP_1 ~ PARALLEL_IO_GROUP_16	752
	Basic Information	752
	Description	752
10.148	PARALLEL_LOAD_FACTOR	753
	Basic Information	753
	Description	753
10.149	PENDING_LOG_BUFFER_COUNT	754
	Basic Information	754
	Description	754
10.150	PLAN_CACHE	755
	Basic Information	755
	Description	755
10.151	PLAN_CACHE_SIZE	756
	Basic Information	756
	Description	756
10.152	PRIVATE_STATIC_AREA_SIZE	757
	Basic Information	757
	Description	757
10.153	PROCESS_MAX_COUNT	758
	Basic Information	758
	Description	758
10.154	QUERY_TIMEOUT	759
	Basic Information	759
	Description	759
10.155	READABLE_ARCHIVELOG_DIR_COUNT	760
	Basic Information	760
	Description	760
10.156	READABLE_BACKUP_DIR_COUNT	761
	Basic Information	761
	Description	761
10.157	REBALANCE_BLOCK_READ_COUNT	762
	Basic Information	762
	Description	762
10.158	RECOMPILE_CHECK_MINIMUM_PAGE_COUNT	763
	Basic Information	763
	Description	763

10.159	RECOMPILE_PAGE_PERCENT	764
	Basic Information	764
	Description	764
10.160	RECOVERY_LOG_BUFFER_SIZE	765
	Basic Information	765
	Description	765
10.161	REDO_LOG_COMPRESSION_THRESHOLD	766
	Basic Information	766
	Description	766
10.162	REFINE_RELATION	767
	Basic Information	767
	Description	767
10.163	SESSION_FATAL_BEHAVIOR	768
	Basic Information	768
	Description	768
10.164	SESSION_MEMORY_INIT_SIZE	769
	Basic Information	769
	Description	769
10.165	SESSION_MEMORY_SHRINK_THRESHOLD	770
	Basic Information	770
	Description	770
10.166	SHARED_MEMORY_ADDRESS	771
	Basic Information	771
	Description	771
10.167	SHARED_MEMORY_STATIC_KEY	772
	Basic Information	772
	Description	772
10.168	SHARED_MEMORY_STATIC_NAME	773
	Basic Information	773
	Description	773
10.169	SHARED_MEMORY_STATIC_SIZE	774
	Basic Information	774
	Description	774
10.170	SHARED_REQUEST_QUEUE_COUNT	775
	Basic Information	775
	Description	775
10.171	SHARED_SERVERS	776
	Basic Information	776
	Description	776

10.172	SHARED_SESSION	777
	Basic Information	777
	Description	777
10.173	SNAPSHOT_STATEMENT_TIMEOUT	778
	Basic Information	778
	Description	778
10.174	SQL_HISTORY_SIZE	779
	Basic Information	779
	Description	779
10.175	SQL_HISTORY_TYPE	780
	Basic Information	780
	Description	780
10.176	SUPPLEMENTAL_LOG_DATA_PRIMARY_KEY	781
	Basic Information	781
	Description	781
10.177	SYSTEM_LOGGER_DIR	782
	Basic Information	782
	Description	782
10.178	SYSTEM_MEMORY_AUX_TABLESPACE_SIZE	783
	Basic Information	783
	Description	783
10.179	SYSTEM_MEMORY_DATA_TABLESPACE_SIZE	784
	Basic Information	784
	Description	784
10.180	SYSTEM_MEMORY_DICT_TABLESPACE_SIZE	785
	Basic Information	785
	Description	785
10.181	SYSTEM_MEMORY_TEMP_TABLESPACE_SIZE	786
	Basic Information	786
	Description	786
10.182	SYSTEM_MEMORY_UNDO_TABLESPACE_SIZE	787
	Basic Information	787
	Description	787
10.183	SYSTEM_TABLESPACE_DIR	788
	Basic Information	788
	Description	788
10.184	SYSTEM_UDS_DIR	789
	Basic Information	789
	Description	789

10.185	TCP_CLIENT_NUMA_NODE	790
	Basic Information	790
	Description	790
10.186	TCP_NODELAY	791
	Basic Information	791
	Description	791
10.187	TEMP_SEGMENT_CACHE_SIZE	792
	Basic Information	792
	Description	792
10.188	TEMP_UNDO_ENABLED	793
	Basic Information	793
	Description	793
10.189	TIMED_STATISTICS	794
	Basic Information	794
	Description	794
10.190	TIMEZONE	795
	Basic Information	795
	Description	795
10.191	TRACE_ALTER_SYSTEM	796
	Basic Information	796
	Description	796
10.192	TRACE_DDL	797
	Basic Information	797
	Description	797
10.193	TRACE_LOG_ID	798
	Basic Information	798
	Description	798
10.194	TRACE_LOG_MSGBUF_SIZE	799
	Basic Information	799
	Description	799
10.195	TRACE_LOG_TIME_DETAIL	800
	Basic Information	800
	Description	800
10.196	TRACE_LOGGER	801
	Basic Information	801
	Description	801
10.197	TRACE_LOGGER_REMOTE_HOST	802
	Basic Information	802
	Description	802

10.198	TRACE_LOGGER_REMOTE_PORT	803
	Basic Information	803
	Description	803
10.199	TRACE_LOGIN	804
	Basic Information	804
	Description	804
10.200	TRACE_LONG_RUN_CURSOR	805
	Basic Information	805
	Description	805
10.201	TRACE_LONG_RUN_SQL	807
	Basic Information	807
	Description	807
10.202	TRACE_XA	808
	Basic Information	808
	Description	808
10.203	TRANSACTION_ALLOCATION_TIMEOUT	809
	Basic Information	809
	Description	809
10.204	TRANSACTION_COMMIT_WRITE_MODE	810
	Basic Information	810
	Description	810
10.205	TRANSACTION_MAXIMUM_UNDO_PAGE_COUNT	811
	Basic Information	811
	Description	811
10.206	TRANSACTION_TABLE_SIZE	812
	Basic Information	812
	Description	812
10.207	TRANSACTION_TIMEOUT	814
	Basic Information	814
	Description	814
10.208	UNDO_RELATION_ALLOCATION_TIMEOUT	815
	Basic Information	815
	Description	815
10.209	UNDO_RELATION_COUNT	816
	Basic Information	816
	Description	816
10.210	UNDO_SHRINK_THRESHOLD	818
	Basic Information	818
	Description	818

10.211 USE_LARGE_PAGES	819
Basic Information	819
Description	819

5.

Basic Management of GOLDILOCKS Database

5.1 Creating and Configuring GOLDILOCKS Database

Creating Database

Create database using `gcreatedb` which is included in GOLDILOCKS package. Before creating database, the followings should be considered.

Table 5-1 Considerations when creating database

Considerations	For more information, refer to
Consider the space size of tables and indexes to be used in database.	<ul style="list-style-type: none"> • Structure and Storage Structure of GOLDILOCKS Database
Consider the location to create database files. It is because the database performance will be improved by properly distributing the files and dispersing the disk IO. For example, a user can allocate redo log file to a separate disk or stripe it, and then disperse data file into a number of disks, to execute a parallel disk IO operation.	<ul style="list-style-type: none"> • Managing Redo Log File
Be aware of each property's concepts and its operation which are set in server property file, then constantly manage them.	<ul style="list-style-type: none"> • Specifying Initial Property • Managing Initial Property Using GOLDILOCKS Configuration File • Server Property

In addition to the above considerations, refer to **Creating Database** in **Getting Started** for more options to be considered when creating database.

A user should set environment variables to use GOLDILOCKS, and the variables are `$GOLDILOCKS_HOME` and `$GOLDILOCKS_DATA`. The property file, `goldilock.properties.conf`, for creating and managing GOLDILOCKS database is in `$GOLDILOCKS_DATA/conf`.

- `GOLDILOCKS_HOME`: Binaries which are included in GOLDILOCKS package are installed here, and it can be overwritten during software version upgrading (The license backup is required.)
- `GOLDILOCKS_DATA`: Log file, data file, control file which are used by GOLDILOCKS database are installed here, and it can not be overwritten.

Specifying Initial Property

A user can use properties to control the information for operation and management in GOLDILOCKS.

Initial Property

Set the properties of when creating or starting the database as follows.

1. Setting system environment variable
 - I. Change it by typing in the command window in which GOLDILOCKS is installed and database is created or operated.
 - II. It is necessary to add the prefix before the property name, and the prefix is *GOLDILOCKS_*.
 - The following is an example of changing SHARED_MEMORY_STATIC_SIZE to 100M.

```
export GOLDILOCKS_SHARED_MEMORY_STATIC_SIZE=100M
```

2. Property file: The prefix is not required, so change it directly in the property file.

- The following is an example of changing SHARED_MEMORY_STATIC_SIZE to 200M.
- Shared memory static size (100M ~ 32G)

```
SHARED_MEMORY_STATIC_SIZE = 200M
```



If the same property is set to system environment variable and property file, then the value of the property file will be applied. For example, if SHARED_MEMORY_STATIC_SIZE is set to 100M as the system environment variable, and SHARED_MEMORY_STATIC_SIZE is set to 200M as the property file, then SHARED_MEMORY_STATIC_SIZE will be applied to 200M when operating database.

Managing Initial Property Using GOLDILOCKS Configuration File

Property file is in *\$GOLDILOCKS_DATA/conf*, and is divided into two according to the file format.

- Text property file
 - File name: goldilocks.properties.conf
 - It is "property name = value" format file, and a user can directly edit it.

- If a binary property file exists, it does not read text property file.
- Binary property file
 - It is created by the system, and a user can not edit it directly.
 - File name: goldilocks.properties.binary
 - Use gdump tool to retrieve the binary file's contents.



If a text property file and a binary property file exist together, it reads the binary property file only. The text property file is not processed. This binary property file is managed by user SQL (`ALTER SYSTEM SET`), and can be edited using SQL only.

For information, refer to `ALTER SYSTEM SET property_name`, `ALTER SYSTEM RESET property_name`.

- Editing text property file
 - Use "PROPERTY_NAME = VALUE" format.
 - Use '#' for annotation.
 - Property has one of the following three data types.
 - Character data type: Use a single quote (') to set the character value. Use `<GOLDILOCKS_DATA TA>` if the character value includes `$GOLDILOCKS_DATA` link.
 - Numeric data type: Do not use calculation for numeric data. For example, `LOG_BUFFER_SIZE = 1024 * 1024` is not allowed to use. Its size is selectable accordingly such as K (kilobyte), M (megabyte), G (gigabyte), T (terabyte), and P (petabyte)
 - Boolean data type: Allowed to use ON/OFF, ENABLE/DISABLE, 1/0 and TRUE/FALSE, YES/NO.

5.2 Starting up and Shutting down GOLDILOCKS Instance

This chapter describes starting up and shutting down of GOLDILOCKS instance.

Starting up Instance

GOLDILOCKS instance can be started only by a user with SYSDBA privilege.

GOLDILOCKS instance can be started by using DA(Direct Attach) method and dedicated method of C/S(Client/Server). However, it can not be started by using shared method of C/S.

Multi-level Startup

GOLDILOCKS has multi-level startup procedure. Multi-level startup procedure enables to change the data base's state by the intervention of administrator in each phase.

The phases are idle, nomount, mount, open, and each phase has the following features.

Idle Phase

The idle phase is a state in which an instance is not started up.

If connecting to gsql when an instance is not started, then it will be connected to idle instance as follows. In this phase, any sever command can not be executed except for \startup.

```
% gsql sys gliese --as sysdba
Connected to an idle instance.
gSQL> select * from dual;
ERR-08003(40044): connection does not exist
gSQL>
```

- Administrator operations in idle phase
 - Adjusting the property required to start up the instance
 - Transition to nomount using \startup in gsql
- Operation in an instance at the nomount transition
 - Starting up gmaster which is a daemon managing GOLDILOCKS instance
 - Starting up timer thread and cleanup thread in gmaster
 - Allocating and initializing Shared memory Static Area (SSA).

Table 5-2 Applied properties at the transition to nomount

Property name	Description
CLIENT_MAX_COUNT	Maximum number of connectable sessions
CONTROL_FILE_0 ~ 7	Path of control file
CONTROL_FILE_COUNT	The number of valid path among the path of control file
DATA_STORE_MODE	Store mode of GOLDILOCKS instance
PLAN_CACHE_SIZE	Maximum size of shared memory for plan cache
PROCESS_MAX_COUNT	Maximum number of connectable process
SHARED_MEMORY_ADDRESS	Address of shared memory
SHARED_MEMORY_STATIC_NAME	Name of shared memory
SHARED_MEMORY_STATIC_KEY	Key value for creating shared memory
SHARED_MEMORY_STATIC_SIZE	Size of shared memory to be created
SYSTEM_LOGGER_DIR	Path of system logger

Properties can not be changed in idle phase. An administrator changes the properties as follows.

To use an environment variable, then set GOLDILOCKS_[property_name] to a desired value and transit it to nomount. Then, the properties will be applied.

```
% export GOLDILOCKS_CLIENT_MAX_COUNT=1000
```

To use 'SCOPE = FILE', record the property value to be changed in the file. The recorded property will be applied at nomount transition.

```
gSQL> alter system set client_max_count = 1000 scope = file;
System altered.
gSQL> \shutdown
Shutdown success
gSQL> \startup
Startup success
gSQL>
```

Nomount Phase

The nomount phase is a state in which it is not mounted to database, and only the gmaster process has been started. A gmaster is a daemon which manages GOLDILOCKS instance.

The following describes how to transit idle phase to nomount phase.

```
% gsql sys gliese --as sysdba
Connected to an idle instance.
gSQL> \startup nomount
Startup success
```

gSQL>

- Administrator operations in nomount phase
 - Adjusting nomount property
 - For more information, refer to **16.34 ALTER SYSTEM {MOUNT | OPEN} DATABASE**, **16.21 ALTER DATABASE RESTORE**.
- Operation in an instance at the mount transition
 - Loading the control file to database
 - Preparing for database recovery
 - Starting up threads in gmaster such as checkpoint, log flusher, page flusher, IO slave, archive log

Table 5-3 Updatable properties in nomount phase

Property name	Description
DATABASE_ACCESS_MODE	Database access mode (READ ONLY, READ WRITE)
LOG_BUFFER_SIZE	Redo log buffer size
PARALLEL_LOAD_FACTOR	The number of threads for parallel operations after loading database
PARALLEL_IO_FACTOR	The number of parallel threads for loading database
PARALLEL_IO_GROUP_1 ~ 16	Datafile group at parallel loading
PENDING_LOG_BUFFER_COUNT	The number of delayed log buffers
TRANSACTION_TABLE_SIZE	Transaction table size
UNDO_RELATION_COUNT	The number of undo relations

Mount Phase

The mount phase is a state in which it is mounted to database, and the database recognizes the control file. All sections in the control file is controllable in this phase.

The following describes how to transit nomount phase to mount phase.

```
% gsql sys gliese --as sysdba
Connected to an idle instance.
gSQL> \startup nomount
Startup success
gSQL> alter system mount database;
System altered.
gSQL>
```

- Administrator operations in mount phase
 - Adjusting mount properties
 - **ALTER SYSTEM {MOUNT | OPEN} DATABASE**
 - **ALTER DATABASE ADD LOGFILE**
 - **ALTER DATABASE DROP LOGFILE**

- ALTER DATABASE RENAME LOGFILE
 - ALTER DATABASE { ARCHIVELOG | NOARCHIVELOG }
 - ALTER DATABASE DELETE BACKUP
 - ALTER DATABASE REGISTER
 - ALTER DATABASE RECOVER
 - ALTER DATABASE RESTORE
 - ALTER SESSION SET property_name
 - ALTER SYSTEM RESET property_name
 - ALTER SYSTEM SWITCH LOGFILE
 - ALTER SYSTEM [KILL | DISCONNECT] SESSION
 - ALTER TABLESPACE name ADD [DATAFILE|MEMORY]
 - ALTER TABLESPACE name RENAME DATAFILE
 - ALTER TABLESPACE name [ONLINE|OFFLINE]
- Operation in an instance at the open transition
 - Loading all data file used in an instance to shared memory
 - Performing instance recovery
 - Creating NOLOGGING index
 - Deleting objects or files which are not deleted by ager thread
 - Creating cache for dictionary objects
 - If "SHARED_SESSION" property is set to YES, process monitor thread in gmaster will be started up.
 - Process monitor thread executes balancer process, dispatcher process, shared-server process.

Table 5-4 Updatable property in mount

Property name	Description
ARCHIVELOG_FILE	Prefix name of archive file
IN_DOUBT_DECISION	Decision about in-doubt transaction
LOCK_HASH_TABLE_SIZE	Hash table size of lock administrator
LOG_MIRROR_MODE	Log mirroring mode
LOG_MIRROR_SHARED_MEMORY_STATIC_SIZE	Shared memory size for log mirroring
SUPPLEMENTAL_LOG_DATA_PRIMARY_KEY	Whether to perform supplemental logging at the database-level

Open Phase

The open phase is a state in which all the data file is loaded to memory, and it is ready for service. All operations are allowed in this phase.

```
% gsql sys gliese --as sysdba
Connected to an idle instance.
gSQL> \startup mount
```



```
Startup success
gSQL> alter system open database;
System altered.
gSQL>
```

The database access mode is selectable at the transition to open phase. The database access modes are divided into READ_ONLY mode and READ_WRITE mode. The READ_ONLY mode can only read data in database, but READ_WRITE mode can both read and write the data.

To open database in READ_ONLY mode, the previous database should be normally shut down. If the access mode is omitted, it refers to the DATABASE_ACCESS_MODE property value when opening database.

```
gSQL> \shutdown abort
Shutdown success
gSQL> \startup mount
Startup success
gSQL> alter system open database read only;
ERR-42000(14038): unable to recover database in READ ONLY mode
gSQL> alter system open database read write;
System altered.
...
gSQL> \shutdown normal
Shutdown success
gSQL> \startup mount
Startup success
gSQL> alter system open database read only;
System altered.
```

Diagnosis

It is possible to execute several phases at a same time using a single command(\startup) when starting up instance. If a certain phase fails, the administrator should figure out in which phase the failure occurs. Check using to which phase the instance has come using V\$INSTANCE. Then the administrator can continue operations of startup instance from the subsequent phase.

The following is an example of starting up instance to open phase after \startup failure.

```
% gsql sys gliese --as sysdba
Connected to an idle instance.
gSQL> \startup
ERR-42000(14051): media recovery required - 'TEST_TBS'
gSQL> select INSTANCE_STATUS from v$instance;
```

```

INSTANCE_STATUS
-----
MOUNTED
1 row selected.
...
gSQL> alter system open database;
System altered.

```

Shutting down Instance

GOLDILOCKS instance can be terminated only by a user with SYSDBA privilege. It is not allowed to create new session during shutdown.

GOLDILOCKS instance can be shut down by Direct Attach (D/A) method and dedicated method of Client/Server (C/S), but it can not be shut down by shared method of C/S.

```

% gsql sys gliese --as sysdba
ERR-RD000(13034): Service is not available

```

There are four types of instance shutdown mode, and they are shutdown normal, shutdown transactional, shutdown immediate and shutdown abort.

Shutdown Normal

The shutdown normal is set by default if a particular mode is not specified when shutting down. Use this type if a user wants to shut down an instance normally.

```

gSQL> \shutdown normal
Shutdown success
gSQL>

```

The followings describe the characteristics of shutdown normal.

- New session is not allowed.
- New transactions and statements are allowed in session which already have been connected.
- Waiting for all the sessions which are connected to the instance to be shut down.
- It does not execute instance recovery process when starting up the instance.

Shutdown Transactional

Use this type to shut down the currently proceeding transactions normally even when the session is forcibly shut down.

```
gSQL> \shutdown transactional
Shutdown success
gSQL>
```

The followings describe the characteristics of shutdown transactional.

- Neither new session nor is new transaction allowed.
- New statements are allowed in ongoing transaction.
- Waiting for the ongoing transactions to be shut down.
- The session will be automatically terminated after the ongoing transactions is terminated.
- It does not execute instance recovery process when starting up the instance.

Shutdown Immediate

Use this type to terminate the instance when a user can not terminate current transactions.

```
gSQL> \shutdown immediate
Shutdown success
gSQL>
```

The followings describe the characteristics of shutdown immediate.

- Neither new session nor is new transaction allowed.
- Forcibly shut down ongoing sessions and transactions.
- Waiting until the background thread of the system to be completed.
- It does not execute instance recovery process when starting up the instance.

Shutdown Abort

Use this type when a user judged the instance is in an abnormal state.

```
gSQL> \shutdown abort
Shutdown success
gSQL>
```

The followings describe the characteristics of shutdown abort.

- Neither new session nor is new transaction allowed.

- Forcibly shut down ongoing sessions and transactions.
- Instantly shut down the background thread of the system.
- It executes instance recovery process when starting up the instance.

5.3 Managing Process

This chapter describes the background processes of GOLDILOCKS instance.

Master Process

Master process performs the asynchronous operation for database performance and monitoring. It consists of many threads.

The master process' executable file name is gmaster.

Checkpoint Thread

Checkpoint thread executes asynchronous checkpoint events which occur in the log flushing thread. The checkpoint event occurs whenever redo log file is switched.

Checkpoint event is executed asynchronously regardless of a user, and its log is recorded in system.trc as follows.

```
[2014-09-11 14:04:34.704465 THREAD(14497,140178383427328)] [INFORMATION]
[CHECKPOINT] begin
...
[2014-09-11 14:04:34.743933 THREAD(14497,140178383427328)] [INFORMATION]
[CHECKPOINT] save control file
[2014-09-11 14:04:34.759521 THREAD(14497,140178383427328)] [INFORMATION]
[CHECKPOINT] end
```

Log Flushing Thread

User transactions record redo log in log buffer, and it is periodically recorded in log file by log flushing thread.

Log switching occurs when redo log is recorded to the end of the log file, then it will be recorded in the next redo log file. When the log switching occurs, checkpoint event is transferred to a checkpoint thread.

If reusable log file does not exist when the log file is switched, all queries except for the read-only queries will wait until the reusable log file is created.

The message remains as follows in system.trc when logging is blocked.

```
...
[2014-09-11 14:31:44.315871 THREAD(19102,139674683647744)] [INFORMATION]
[LOG FLUSHER] disable logging - blocked lfsn(1)
...
```

Log Archiving Thread

The log archiving thread asynchronously archives redo log file. This thread is executed only when database is operated in ARCHIVELOG mode.

Log archiving is a part of checkpoint process, and it is executed by log archiving event in which the checkpoint thread occurred.

The message remains as follows in system.trc when redo_0_0.log is archived to archive_0.log.

```
[2014-09-11 14:13:32.515996 THREAD(16913,140631135463168)] [INFORMATION]
[ARCHIVELOG BEGIN] LOG(/home/test/work/product/Gliese/home/wal/redo_0_0.log(0)) =>
ARCHIVE(/home/test/work/product/Gliese/home/archive_log/archive_0.log)
[2014-09-11 14:13:33.145850 THREAD(16913,140631135463168)] [INFORMATION]
[ARCHIVELOG END] (/home/test/work/product/Gliese/home/archive_log/archive_0.log) : SUCCESS
...
```

Ager Thread

Ager thread physically drops the logically dropped database objects.

DROP TABLE statement executes only logical drop operation to maintain statement level consistency in GOLDILOCKS. Therefore, the statement which was invoked before DROP TABLE can explore the records of dropped table even when DROP TABLE is executed.

The message remains as follows in system.trc when table and tablespaces are physically dropped.

```
[2014-09-11 14:13:37.966788 THREAD(16925,139892990408448)] [INFORMATION]
[AGER] aging table - object scn(4561), object view scn(4562), type(0), physical
id(25043954302976)
...
[2014-09-11 14:13:37.966917 THREAD(16925,139892990408448)] [INFORMATION]
[AGER] aging tablespace - object scn(4561), object view scn(4564), tablespace id(61)
```

Timer Thread

Timer thread asynchronously sets time to the system to reduce the time measuring cost of user transactions, and the user transactions read the time set in the system.

The set time precision is 10 ms.

The followings describe the case of using the time set in the timer thread. The time error is 10 ms.

- Time out : QUERY_TIMEOUT, IDLE_TIMEOUT, DDL_LOCK_TIMEOUT, ...
- Message record time written in trace log
- Startup time of login statement or transaction.
- Time recorded in transaction commit redo log

Page Flusher & IO Slave Threads

It applies the updated data pages to the disk when a checkpoint occurs. The updated information is stored in multiple data files in a tablespace. For that, the page flusher thread distributes operations to IO slave threads per each tablespace and data files and manages them. Then the IO slave threads record the updated pages in the data file in parallel.

Storing the updated pages as many as possible at a time improves performance. The number of written pages at each time follow the properties in **MAXIMUM_FLUSH_PAGE_COUNT**.

After the updated pages are written to the data file, the message remains in system.trc is as follows.

```
[2014-09-11 14:13:38.329162 THREAD(16925,139893221086976)] [INFORMATION]
[IO SLAVE] flush datafile ( tablespace : 0, datafile : 0 )
[2014-09-11 14:13:38.552161 THREAD(16925,139893221086976)] [INFORMATION]
[IO SLAVE] flush datafile ( tablespace : 1, datafile : 0 )
[2014-09-11 14:13:38.587510 THREAD(16925,139893221086976)] [INFORMATION]
[IO SLAVE] flush datafile ( tablespace : 2, datafile : 0 )
[2014-09-11 14:13:38.587831 THREAD(16925,139893221086976)] [INFORMATION]
[IO SLAVE] flush datafile ( tablespace : 62, datafile : 0 )
[2014-09-11 14:13:38.620239 THREAD(16925,139893221086976)] [INFORMATION]
[IO SLAVE] flush datafile ( tablespace : 63, datafile : 0 )
```

Cleanup Thread

Cleanup thread cleans up the system resource asynchronously, and performs the following operations.

- It cleans up normally terminated session. GOLDILOCKS processes termination of a user session logically, and uses cleanup thread for physical termination of a session.
- It cleans up abnormally terminated session. If the session is using transactions, then they will be rolled

back.

- It checks the time-out of snapshot statements. If a session exceeds the time-out, it is forced to be terminated.

When cleaning up the abnormally terminated session, a message remains in system.trc as follows.

```
[2014-09-12 10:34:38.387349 THREAD(23003,140722556352256)] [WARNING]
[CLEANUP] cleaning session - env(19), session(20), transaction(FFFFFFFFFFFFFFF),
program(gsql), pid(23209), thread(140080441665280)
[2014-09-12 10:34:38.387515 THREAD(23003,140722556352256)] [WARNING]
[CLEANUP] cleaning up 1 sessions
```

If a snapshot statement exceeds the time-out, a message remains in system.trc as follows.

```
[2014-09-12 10:49:21.842179 THREAD(3972,139706316711680)] [WARNING]
[CLEANUP] long statement timeout - pid(8029), thread(140053960505088), program(gsql),
statement start time(2014-09-12 10:48:49.963471)
```

If abnormally terminated session is terminated by 'kill-9' signal during changing shared memory when exclusive latch is acquired, it is no longer possible to operate the database. In this situation, a message remains in system.trc as follows, and the instance should be terminated using *SHUTDOWN ABORT*.

```
[2014-09-12 11:12:58.809249 THREAD(15313,140671386121984)] [WARNING]
[CLEANUP] failed to cleaning session - server restart required
..... dead session in critical section - env(3), session(4), transaction(47001E0004),
pid(15296), thread(140178075756288)
```

Process Monitor Thread

The process monitor thread executes processes, and monitors them.

- It is executed only when "SHARED_SESSION" property is set to *YES*.
- It executes load-balancer (gbalancer), dispatcher(gdispatcher), shared-server(gserver), and re-executes them when they are abnormally terminated.
- It does not monitor listener (glsnr) process.

Cluster Recover Thread

When starting up a node on a cluster system environment, if the node phases up to the mount phase, then the cluster recover thread is created. If there is an in-doubt transaction, the cluster recover thread communicates with the cluster recover thread on the remote node, and recovers the in-doubt transaction.

If there is an in-doubt transaction, the cluster recover thread communicates with the cluster recover thread

d on the remote node, and figures out the status of the in-doubt transaction. If the remote node is restarted and it is not recovered yet, then it transfers a message requesting the preferential completion of recovery and recovers the in-doubt transaction status after the recovery is completed.

The in-doubt transaction statuses figured out through the remote node are NONE, PREPARE, COMMIT, and ROLLBACK. If the cluster recover thread received the response such as COMMIT, ROLLBACK from at least one remote node, then it performs COMMIT or ROLLBACK. If the cluster recover thread received the response such as NONE, PREPARE from all remote nodes, then it performs ROLLBACK because COMMIT or ROLLBACK never has been performed on any cluster node.

The in-doubt transaction recovery using the cluster recover thread leaves the following messages in system.trc.

```
[2018-11-22 16:52:00.466805 INSTANCE(G3N2) THREAD(7828,140557371479808)] [WARNING]
[CLUSTER RECOVER] begin recovery
[2018-11-22 16:52:00.467221 INSTANCE(G3N2) THREAD(7828,140557371479808)] [WARNING]
[CLUSTER RECOVER] commit in-doubt transaction - commit scn(999.0.439), global transaction
id(1.29294650), local transaction id(4)
[2018-11-22 16:52:00.468253 INSTANCE(G3N2) THREAD(7828,140557371479808)] [WARNING]
[CLUSTER RECOVER] rollback in-doubt transaction - commit scn(1000.439), global transaction
id(4.34406459), local transaction id(59)
[2018-11-22 16:52:00.469198 INSTANCE(G3N2) THREAD(7828,140557371479808)] [WARNING]
[CLUSTER RECOVER] commit in-doubt transaction - commit scn(1001.0.439), global transaction
id(5.35127356), local transaction id(60)
```

Failover Thread

When starting up a node on a cluster system environment, if the node phases up to the LOCAL OPEN phase, then the cluster failover thread is created. Cluster failover thread performs the failover for the error node by reselecting a coordinator or offlining when an error occurs on a specific node or the network in the cluster system.

In a situation requiring the failover, a normal node which acquired a failover lock among other normal nodes communicates with failover threads of other nodes, then performs the failover.

The failover performed by the failover thread leaves the following messages in system.trc.

```
[2018-11-22 15:27:34.619208 INSTANCE(G1N1) THREAD(20140,140219957368576)] [INFORMATION]
[FAILOVER] begin - failover member(5)
[2018-11-22 15:27:34.619418 INSTANCE(G1N1) THREAD(20140,140219957368576)] [INFORMATION]
[FAILOVER] acquire failover lock - driver(0), target(5), driver seq(1)
[2018-11-22 15:27:34.619692 INSTANCE(G1N1) THREAD(20183,140317097449216)] [INFORMATION]
[CDISPATCHER-S2] disconnect member - target member(5)
```

```
[2018-11-22 15:27:34.619893 INSTANCE(G1N1) THREAD(20183,140317097449216)] [INFORMATION]
[CDISPATCHER-S2] finalize sender socket - member(5)
[2018-11-22 15:27:34.621860 INSTANCE(G1N1) THREAD(20140,140219957368576)] [INFORMATION]
[FAILOVER] acquire failover lock
...
[2018-11-22 15:27:38.726436 INSTANCE(G1N1) THREAD(20140,140219957368576)]
[INFORMATION][FAILOVER] member(5) has failedover
[2018-11-22 15:27:38.728624 INSTANCE(G1N1) THREAD(20140,140219957368576)] [INFORMATION]
[FAILOVER] release failover lock - driver(-1), target(5), driver seq(1)
[2018-11-22 15:27:38.728786 INSTANCE(G1N1) THREAD(20140,140219957368576)] [WARNING]
reset remote session map - member(5)
[2018-11-22 15:27:38.729679 INSTANCE(G1N1) THREAD(20140,140219957368576)] [INFORMATION]
[FAILOVER] finished
```

Listener Process

Listener process enables remote access through the network in a client/server environment. Listener process waits for a client connection using `LISTEN_PORT`. If connected in dedicated mode, new gserver starts, and connects a client. If connected in shared mode, it selects underloaded dispatcher (gdispatcher) using load-balancer (gbalancer), and connects a client.

gserver is a kind of operation server, and it executes a client request.

If `LISTEN_PORT` is already in use, the following error occurs.

```
% glsnr --start
ERR-HY000(11077): given address is already in use
```

Listener process operates independently from the instance. In other words, listener process can start up and shut down regardless of instance start up anytime.

5.4 Managing Memory

GOLDILOCKS Memory Architecture

GOLDILOCKS uses SSA which is a memory shared by all sessions in the system, a shared memory for data base pages, and PSA (heap memory) which each session uses independently.

Figure 1 Shared memory

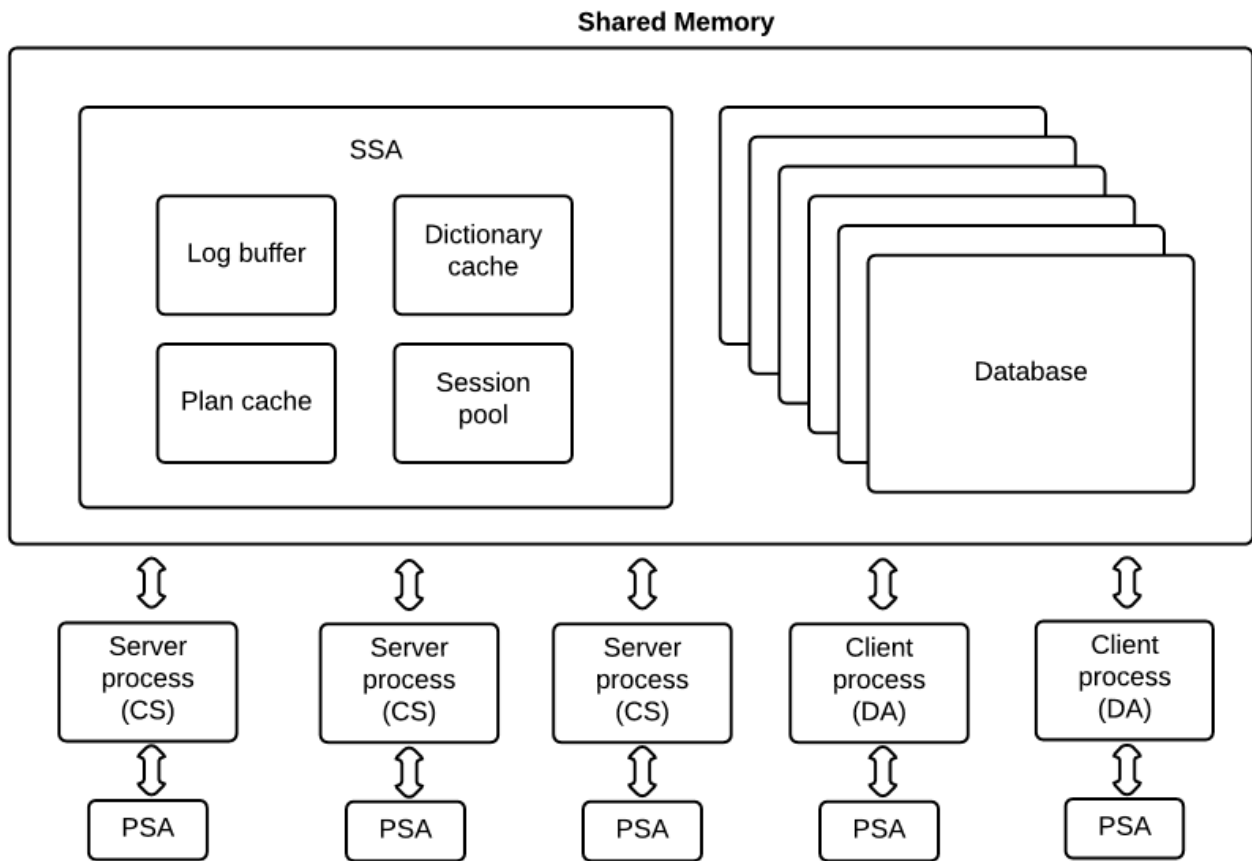

Managing SSA

Shared Static Area (SSA) is a memory area to store information which is shared by the system's all sessions.

A new process should use the same physical address for using SSA. It is because the position of all information referenced by SSA uses the physical address.

The physical starting address of SSA is determined by **SHARED_MEMORY_STATIC_KEY** and **SESSION_FATAL_BEHAVIOR**. The following error occurs when another program is already using shared memory key assigned by the same **SHARED_MEMORY_STATIC_KEY**, and the memory assigned by **SHARED_MEMORY_ADDRESS**.

```
% gsql sys gliese --as sysdba
Connected to an idle instance.
gSQL> \startup
ERR-HY000(11029): shared memory segment exists
gSQL>
```

SSA stores main information, and they are log buffer, dictionary cache, plan cache, session pool, lock pool, and transaction pool.

SSA size is determined by **SHARED_MEMORY_STATIC_SIZE**. The system automatically manages memories used in session/lock/transaction pool and dictionary cache, and a user can not arbitrarily manage them. However, a user can arbitrarily manage the usage of log buffer and plan cache.

If the default value of log buffer and plan cache are increased, **SHARED_MEMORY_STATIC_SIZE** should be increased accordingly. Otherwise, the following error occurs.

```
% gsql sys gliese --as sysdba
Connected to an idle instance.
gSQL> \startup
ERR-HY000(13010): Insufficient static area
gSQL>
```

Managing PSA

Private Static Area (PSA) is a heap memory area, and it is used independently by each session. **PRIVATE_STATIC_AREA_SIZE** determines the maximum size of PSA.

An initial size is allocated to PSA when a session is created. If additional memory is required in the session, PSA can be allocated up to its maximum size. The following error occurs when it exceeds the maximum size.

```
ERR-HY000(13011): Unable to extend memory: [MAX: 104857600, TOTAL: 102764408, ALLOC: 2097240]
DESC: private static area
```

5.5 Monitoring

Database monitoring is needed not only to detect and prevent the problem which can be an issue in the future, but also to find a way to improve database management. For monitoring, GOLDILOCKS database provides text file type trace log and several performance views.

Monitoring with Trace File

From when the instance starts up until it terminates, GOLDILOCKS database provides the system log which records the overall system error, warning, information. In addition, it provides XA transaction log, trace log such as DDL log, and SQL Trace Log. For more information, refer to **15.5 SQL Trace Log**.

Managing Trace Log File

GOLDILOCKS database's trace log file consists of system.trc file and xa.trc file. The system.trc file records system log and DDL log, and xa.trc file records XA transaction log. Trace log file is created in directory set in SYSTEM_LOGGER_DIR property. Therefore, it is generally created in trc directory below the directory specified in GOLDILOCKS_DATA environment variable. The trace log file's size is 10 Mbytes. If its space is insufficient, the existing trace log file with unique file extension is preserved, and the new trace log file is created.

Listener trace log file is created as *listener.trc* in trc directory below the directory specified by GOLDILOCKS_DATA environment variable. The log file size is 10 Mbytes. If the space is insufficient, the existing log file with unique file extension is preserved, and the new trace log file is created.

Except for system log, XA transaction log and DDL log can ON/OFF the monitoring. Set the TRACE_DDL property value to 0 to turn off the DDL log, or set it to 1 to turn on the DDL log. XA log is set in the same way using the TRACE_XA property.

System Log

The errors, warnings, and information which occurred in database instance from when master process starts up until it terminates are recorded in the system log.

System Log Format

System log is recorded in the following format.

```
['log record data and time' THREAD('process Id', 'thread handle')] ['log level']
['log prefix'] 'log body'
```

- 'log record date and time' is the date and time of the recorded log.
- THREAD('process Id', 'thread handle') is the information of log process id and thread handle.
- 'log prefix' is the entity or feature which created the log, and 'log body' is the detailed information.
- 'Log level' is the level of log recorded in system log, and its value is FATAL, ABORT, WARNING, INFO. 'log level' has the properties as follows.

Table 5-5 Log level properties

Log level	Description	Processing
FATAL	The state which master or client process is shut down abnormally.	The client should be reconnected in case of client process FATAL, and the database instance should be shut down and restarted in case of system FATAL. Backup the data file, control file, redo log file, system log file and contact the manufacturer.
ABORT	The state to continue service after rollback.	It is the normal state for system operation. Execute it again after eliminating the rollback cause.
WARNING	Operational warnings	The abnormal state of database instance. there is no operational problem but cause analysis is needed.
INFO	Operational information	-

For example, the following system log recorded the operational information at 17:30:55 on September 11 in 2014 by process id 21395 (The thread handle is 139982731163392). Log prefix is 'STARTUP-SM' and was executing the storage manager when the master process of GOLDILOCKS database started up. It means that the transition to NO-MOUNT phase had been done during multilevel startup.

```
[2014-09-11 17:30:55.758164 THREAD(21395,139982731163392)] [INFORMATION]
[STARTUP-SM] NO-MOUNT PHASE
```

Operational Information of GOLDILOCKS Database

It is the log for creating database instance, multilevel startup and shutdown, loading data file, recovering restart and media. It records the necessary information for the operation of the master process from when master process starts up until it terminates.

- GOLDILOCKS instance creation log

The system log records the following information when database instance is created. It creates the control file after the transition to NO-MOUNT phase to create database.

```
=====
Startup GOLDILOCKS
```

```
TIME      : 2014-09-03 14:43:17.321020
=====
```

```
[2014-09-03 14:43:17.321134 THREAD(14979,140542517491456)] [INFORMATION]
[STARTUP-SM] NO-MOUNT PHASE
[2014-09-03 14:43:17.321658 THREAD(14979,140542517491456)] [INFORMATION]
[STARTUP-SM] DATA_STORE_MODE(2)
[2014-09-03 14:43:17.335809 THREAD(14979,140542517491456)] [INFORMATION]
... copy control file from '/goldilocks_data/wal/control_0.ctl' to
'/goldilocks_data/wal/control_1.ctl'
```

Then, it moves to transition to OPEN phase, and creates the system tablespace.

```
[2014-09-03 14:43:17.401356 THREAD(14979,140542517491456)] [INFORMATION]
[STARTUP-SM] MOUNT PHASE
[2014-09-03 14:43:19.319769 THREAD(14979,140542517491456)] [INFORMATION]
[STARTUP-SM] PRE-OPEN PHASE
[2014-09-03 14:43:19.320494 THREAD(14979,140542517491456)] [INFORMATION]
[STARTUP-SM] RECOVER TABLESPACE AND DATAFILE STATE
[2014-09-03 14:43:19.326269 THREAD(14979,140542517491456)] [INFORMATION]
[STARTUP-SM] OPEN PHASE
[2014-09-03 14:43:21.005536 THREAD(14979,140542517491456)] [INFORMATION]
[TABLESPACE] Create Tablespace(0)
[2014-09-03 14:43:21.005593 THREAD(14979,140542517491456)] [INFORMATION]
[TABLESPACE] Create Tablespace(1)
...
```

After creating the system tablespace, it executes checkpoint, and terminates the database instance.

```
[2014-09-03 14:43:21.788129 THREAD(14979,140542517491456)] [INFORMATION]
[CHECKPOINT] begin - checkpoint lid(0,10128,13), checkpoint lsn(10512), oldest lsn(10512)
[2014-09-03 14:43:21.788188 THREAD(14979,140542517491456)] [INFORMATION]
[CHECKPOINT] body - checkpoint lid(-1,0,0), checkpoint lsn(-1), active transaction count(0)
[2014-09-03 14:43:21.788203 THREAD(14979,140542517491456)] [INFORMATION]
[CHECKPOINT] end - checkpoint lid(0,10128,77), checkpoint lsn(10513)
[2014-09-03 14:43:21.788214 THREAD(14979,140542517491456)] [INFORMATION]
[CHECKPOINT] flush redo log
[2014-09-03 14:43:21.949589 THREAD(14979,140542517491456)] [INFORMATION]
[CHECKPOINT] save control file
[2014-09-03 14:43:21.957563 THREAD(14979,140542517491456)] [INFORMATION]
```

```
[SHUTDOWN-SM] CLOSE
[2014-09-03 14:43:21.957595 THREAD(14979,140542517491456)] [INFORMATION]
[SHUTDOWN-SM] POST CLOSE
[2014-09-03 14:43:21.992521 THREAD(14979,140542517491456)] [INFORMATION]
[SHUTDOWN-SM] DISMOUNT
[2014-09-03 14:43:21.992557 THREAD(14979,140542517491456)] [INFORMATION]
[SHUTDOWN-SM] INIT
```

- GOLDILOCKS instance startup log

Master process records logs such as multilevel startup of database instance, loading data file, restart recovery, media recovery. After the transition to MOUNT phase, the data file is loaded.

```
=====
Startup GOLDILOCKS
TIME      : 2014-09-03 14:43:22.162601
=====
[2014-09-03 14:43:22.162765 THREAD(14982,140025756808960)] [INFORMATION]
[STARTUP-SM] NO-MOUNT PHASE
[2014-09-03 14:43:22.163389 THREAD(14982,140025756808960)] [INFORMATION]
[STARTUP-SM] DATA_STORE_MODE(2)
[2014-09-03 14:43:22.429311 THREAD(14983,140025756808960)] [INFORMATION]
[STARTUP-SM] MOUNT PHASE
[2014-09-03 14:43:22.559395 THREAD(14983,140025756808960)] [INFORMATION]
[EVENT] system startup : SUCCESS
[2014-09-03 14:43:22.568526 THREAD(14981,139649517561600)] [INFORMATION]
[STARTUP] MOUNT PHASE
[2014-09-03 14:43:22.571200 THREAD(14983,140025756808960)] [INFORMATION]
[STARTUP-SM] LOAD DATAFILES
[2014-09-03 14:43:22.571241 THREAD(14983,140025756808960)] [INFORMATION]
.... datafile '/goldilocks_data/db/system_dict.dbf' assigned to PARALLEL_IO_GROUP_1
...
[2014-09-03 14:43:22.571562 THREAD(14983,140025280841472)] [INFORMATION]
.... LOAD DATAFILE(/goldilocks_data/db/system_dict.dbf)
....
```

After loading data file to the memory, it executes the recovery.

```
[2014-09-03 14:43:23.537256 THREAD(14983,140025756808960)] [INFORMATION]
[STARTUP-SM] REFINE TABLESPACE AND DATAFILE
[2014-09-03 14:43:23.631974 THREAD(14983,140025756808960)] [INFORMATION]
[RESTART REDO] begin
```



```
[2014-09-03 14:43:23.634374 THREAD(14983,140025756808960)] [INFORMATION]
[RESTART REOD] read checkpoint log - checkpoint log id(0,10128,13), oldest lsn(10512), system
scn(7)
[2014-09-03 14:43:23.756293 THREAD(14983,140025756808960)] [INFORMATION]
[RESTART REDO] ready to redo - start lid(0,10128,13), lsn(10512)
...
[2014-09-03 14:43:24.090755 THREAD(14983,140025756808960)] [INFORMATION]
[RESTART REDO] end - restart lsn(10514), restart scn(7)
[2014-09-03 14:43:24.091551 THREAD(14983,140025756808960)] [INFORMATION]
[RESTART UNDO] begin
[2014-09-03 14:43:24.091598 THREAD(14983,140025756808960)] [INFORMATION]
[RESTART UNDO] end
```

After recovery, it executes checkpoint, reflects the recovery result to disk data file. Then, it creates index, moves to the transition to OPEN phase.

```
[2014-09-03 14:43:24.111878 THREAD(14983,140025633163008)] [INFORMATION]
[CHECKPOINT] begin
...
[2014-09-03 14:43:24.129995 THREAD(14983,140025633163008)] [INFORMATION]
[CHECKPOINT] save control file
[2014-09-03 14:43:24.135864 THREAD(14983,140025633163008)] [INFORMATION]
[CHECKPOINT] end
[2014-09-03 14:43:24.144525 THREAD(14983,140025756808960)] [INFORMATION]
[STARTUP-SM] PRE-OPEN PHASE
[2014-09-03 14:43:24.202782 THREAD(14983,140025756808960)] [INFORMATION]
[STARTUP-SM] RECOVER TABLESPACE AND DATAFILE STATE
[2014-09-03 14:43:24.210158 THREAD(14983,140025756808960)] [INFORMATION]
[STARTUP-SM] REFINE RELATIONS
[2014-09-03 14:43:24.210304 THREAD(14983,140025756808960)] [INFORMATION]
[STARTUP-SM] REBUILD INDEXES
[2014-09-03 14:43:24.210375 THREAD(14983,140025756808960)] [INFORMATION]
[STARTUP-SM] OPEN PHASE
[2014-09-03 14:43:24.332064 THREAD(14983,140025756808960)] [INFORMATION]
[EVENT] system startup : SUCCESS
[2014-09-03 14:43:24.340843 THREAD(14981,139649517561600)] [INFORMATION]
[STARTUP] OPEN PHASE
```

- GOLDILOCKS instance termination log

When it shuts down database instance, it reflects all data file to the disk, executes checkpoint, then terminates the master process.

```

[2014-09-03 14:48:03.467293 THREAD(15416,139855812097792)] [INFORMATION]
[IO SLAVE] flush datafile ( tablespace : 0, datafile : 0 )
...
[2014-09-03 14:48:03.748958 THREAD(15416,139855908558592)] [INFORMATION]
[PAGE FLUSHER] flushed lsn(137496), flushed page count(9216)
[2014-09-03 14:48:03.761055 THREAD(15416,139856376227584)] [INFORMATION]
[CHECKPOINT] begin
...
[2014-09-03 14:48:03.780011 THREAD(15416,139856376227584)] [INFORMATION]
[CHECKPOINT] save control file
[2014-09-03 14:48:03.786387 THREAD(15416,139856376227584)] [INFORMATION]
[CHECKPOINT] end
[2014-09-03 14:48:03.791251 THREAD(15416,139856430274304)] [INFORMATION]
[SHUTDOWN-SM] CLOSE
[2014-09-03 14:48:03.791383 THREAD(15416,139856430274304)] [INFORMATION]
[SHUTDOWN-SM] POST CLOSE
[2014-09-03 14:48:03.824445 THREAD(15416,139856430274304)] [INFORMATION]
[SHUTDOWN-SM] DISMOUNT
[2014-09-03 14:48:03.824518 THREAD(15416,139856430274304)] [INFORMATION]
[EVENT] system shutdown : SUCCESS
[2014-09-03 14:48:04.267130 THREAD(15416,139856430274304)] [INFORMATION]
[SHUTDOWN-SM] INIT

```

If \shutdown abort forcibly stopped the server, neither checkpoint, nor is normal server shutdown executed.

```

[2014-09-03 14:51:45.353154 THREAD(8989,139949509089024)] [INFORMATION]
[SHUTDOWN] skip CLOSE phase
[2014-09-03 14:51:45.678461 THREAD(8989,139949509089024)] [INFORMATION]
[SHUTDOWN] skip DISMOUNT phase
[2014-09-03 14:51:45.678696 THREAD(8989,139949509089024)] [INFORMATION]
[EVENT] system shutdown : SUCCESS
[2014-09-03 14:51:45.678928 THREAD(8989,139949509089024)] [INFORMATION]
[SHUTDOWN-SM] INIT

```

- The logs of master process checkpoint, log flusher, log archiving, ager, parallel IO, cleanup thread during database operation

A checkpoint reflects to disk all data files which are updated only in memory and not written to the disk yet at checkpoint time. If it uses the parallel IO, it executes parallel IO in data file units. One unit of checkpoint log is from '[CHECKPOINT] begin' to '[CHECKPOINT] end'.

[IO SLAVE] is a log which is recorded by IO thread dedicated to parallel IO. '[IO SLAVE] flush data file (tablespace: 0, datafile: 0)' log is recorded after the data file (whose datafile id is '0' and whose tablespace id is 0) is reflected to the disk. These data file flush logs are repeatedly recorded as many as the number of data file at checkpoint time.

'[PAGE FLUSHER] flushed lsn(139039), flushed page count(9216)]' means that the reflected minimum Lsn in the disk is 139039, and reflected pages are 9216. The last log Lsn archives redo log files which are smaller than 139039. They record checkpoint log and control file, then stores them in the disk.

If a database is large its checkpoint time will be longer. Check if the datafile is continuously being recorded by tracking [IO SLAVE] logs. And if disk IO does not operate and stops, then check if log archiving is in progress. If the space is insufficient, then spare the space and ensure the log archiving proceed normally.

If checkpoint fails '[CHECKPOINT] CHECKPOINT was failed' log will be recorded. The checkpoint can be specially omitted at checkpoint time due to the log file switch, where '[CHECKPOINT] CHECKPOINT was skipped' log might be recorded.

```
[2014-09-12 15:54:59.654427 THREAD(13780,140493515450112)] [INFORMATION]
[CHECKPOINT] begin
[2014-09-12 15:54:59.654798 THREAD(13780,140493029623552)] [INFORMATION]
[IO SLAVE] flush datafile ( tablespace : 0, datafile : 0 )
[2014-09-12 15:54:59.835173 THREAD(13780,140493029623552)] [INFORMATION]
[IO SLAVE] flush datafile ( tablespace : 1, datafile : 0 )
[2014-09-12 15:54:59.893991 THREAD(13780,140493029623552)] [INFORMATION]
[IO SLAVE] flush datafile ( tablespace : 2, datafile : 0 )
[2014-09-12 15:54:59.926753 THREAD(13780,140493050603264)] [INFORMATION]
[PAGE FLUSHER] flushed lsn(138895), flushed page count(9216)]
[2014-09-12 15:54:59.926989 THREAD(13780,140492777965312)] [INFORMATION]
[ARCHIVING] stable lsn(139039)
[2014-09-12 15:54:59.933780 THREAD(13780,140493515450112)] [INFORMATION]
[CHECKPOINT] begin - checkpoint lid(0,55527,13), checkpoint lsn(139040), oldest lsn(139040)
[2014-09-12 15:54:59.933825 THREAD(13780,140493515450112)] [INFORMATION]
[CHECKPOINT] body - checkpoint lid(0,55527,77), checkpoint lsn(139041), active transaction
count(1)
[2014-09-12 15:54:59.933844 THREAD(13780,140493515450112)] [INFORMATION]
[CHECKPOINT] end - checkpoint lid(0,55527,155), checkpoint lsn(139042)
[2014-09-12 15:54:59.933859 THREAD(13780,140493515450112)] [INFORMATION]
[CHECKPOINT] flush redo log
[2014-09-12 15:54:59.936154 THREAD(13780,140493515450112)] [INFORMATION]
[CHECKPOINT] save control file
[2014-09-12 15:54:59.942850 THREAD(13780,140493515450112)] [INFORMATION]
[CHECKPOINT] end
```

Log flusher records the system log when the log buffer stops flushing to disk, and when it restarts the stopped flusher. If the next log group is not reusable log file, the logging stops until it becomes reusable. The following describes an example when the logging is stopped because the redo log file of which sequence number is 34 has not been archived.

```
[2014-09-12 16:01:57.514303 THREAD(13780,14057333325568)] [INFORMATION]
[LOG FLUSHER] disable logging - blocked lfsn(34)
```

If the logging stops, then the transaction stops, so an immediate action is needed. When checkpoint is executed and archiving is done, the logging will restarts.

```
[2014-09-12 16:01:58.079236 THREAD(13780,140380267869952)] [INFORMATION]
[ARCHIVING] enable logging - blocked lfsn(34), inactivated lfsn(34)
```

Log archiving thread archives the redo log file of ACTIVE state, and it records the system log. One unit is from '[ARCHIVING] stable lsn(...)' to '[ARCHIVING] inactivate group ...'. If database is operated in archive log mode, the redo file archiving log(from '[ARCHIVELOG BEGIN] ...' to '[ARCHIVELOG END] ...') is recorded.

```
[2014-09-02 17:41:56.762950 THREAD(20800,140129584793344)] [INFORMATION]
[ARCHIVING] stable lsn(144143)
[2014-09-02 17:41:56.763549 THREAD(20800,140129584793344)] [INFORMATION]
[ARCHIVELOG BEGIN] LOG(/goldilocks_data/wal/redo_0_0.log(8)) =>
ARCHIVE(/goldilocks_data/archive_log/archive_8.log)
[2014-09-02 17:41:57.385936 THREAD(20800,140129584793344)] [INFORMATION]
[ARCHIVELOG END] (/goldilocks_data/archive_log/archive_8.log) : SUCCESS
[2014-09-02 17:41:57.385987 THREAD(20800,140129584793344)] [INFORMATION]
[ARCHIVING] inactivate group #0(8)
```

If the log '*Archiving was failed - ...*' outputs after the log '[ARCHIVELOG BEGIN] ...', then log archiving is failed. This failure should be immediately resolved in order that the service will be enabled by reusing the redo log file in active state.

The table whose age is dropped and the aging information for the tablespace will be recorded as follows. When dropping the table, the table lock is also deleted, and the table scn information, scn which is able to aging at aging time and the aging information of table lock will be recorded. If a table has an index, it will be deleted when dropping the table.

```
[2014-09-03 12:13:56.539971 THREAD(5225,139821699815168)] [INFORMATION]
[AGER] aging index - object scn(224), type(0), physical id(22634477649920)
[2014-09-03 12:13:56.540388 THREAD(5225,139821699815168)] [INFORMATION]
[AGER] aging table - object scn(224), object view scn(225), type(0), physical
```

```
id(22630182682624)
[2014-09-03 12:13:56.540491 THREAD(5225,139821699815168)] [INFORMATION]
[AGER] aging lock item - object scn(226), agable stmt scn(228), physical id(22630182682624)
```

When deleting a tablespace, tablespace scn, aging available scn at aging time and dropped tablespace id are recorded.

```
[2014-09-03 12:13:56.540553 THREAD(5225,139821699815168)] [INFORMATION]
[AGER] aging tablespace - object scn(224), object view scn(227), tablespace id(5)
```

The cleanup thread records the information about abnormally terminated session as follows. Even when a user session is abnormally terminated, the resources of the session is cleaned up, so the database instance or other users continue to operate.

```
[2014-09-03 13:43:02.220139 THREAD(7768,140298504156928)] [WARNING]
[CLEANUP] snipe at zombie session - pid(7766), thread(139967223228160), program(gsql)
[2014-09-03 13:43:02.220211 THREAD(7768,140298504156928)] [WARNING]
[CLEANUP] cleaning session - env(3), session(4), transaction(FFFFFFFFFFFFFFFF), program(gsql),
pid(7766), thread(139967223228160)
[2014-09-03 13:43:02.220270 THREAD(7768,140298504156928)] [WARNING]
[CLEANUP] cleaning up 1 sessions
```

- Log of creating, dropping, altering tablespace by a user

The system log records the operations of creating, deleting, updating of a user tablespace. Tablespace related to DDL is recorded by default, regardless of TRACE_DDL ON/OFF. DDL failure will not be recorded in the system log. Therefore, a user should operate the system by setting TRACE_DDL to *ON* in order to figure out more details about DDL log and the causes of its failure.

```
[2014-09-15 10:26:41.649909 THREAD(24881,140468897289984)] [INFORMATION]
[TABLESPACE] Create Tablespace(7)
[2014-09-15 10:26:55.966385 THREAD(24881,140468897289984)] [INFORMATION]
[DATAFILE] add datafile(/home/zkyungoh/work/product/Gliese/home/db/TEST1.dbf)
[2014-09-15 10:27:11.325897 THREAD(24881,140468897289984)] [INFORMATION]
[DATAFILE] Drop Datafile(/home/zkyungoh/work/product/Gliese/home/db/TEST1.dbf)
...
[2014-09-15 10:32:00.669550 THREAD(24881,140468897289984)] [INFORMATION]
[TABLESPACE] drop tablespace ( 7 )
```

- System internal error and index creation failure log

An internal error occurs when GOLDILOCKS database system error occurs but the exact cause of the failure

re can not be defined. If an internal error occurs, the SQL statement which raised the error is rolled back. The service is continuously available because the error does not affect the system nor does other sessions.

By the way, if the error raising SQL statement is executed again, it could be failed for the same reason, or the cause of failure could disappear and the operation could succeed. Therefore, a user should not change the database at the point of failure, but should request cause analysis to find the cause.

The index creation fails if the same key index on a table exists when creating UNIQUE index. Even though the index creation fails, it does not affect the index tables which are already created. Therefore, it does not affect the service.

```
[2014-09-15 11:26:59.640345 THREAD(7819,140737354012416)] [INFORMATION]
Index creation failed ( physical id : 22638772617216, error code : 14016 )
```

XA Log

It records the success or failure log of start, close, end, rollback, prepare, commit, recover, forget operations of XA transaction interface for processing distributed transactions. GOLDILOCKS database does not record XA trace log by default. TRACE_XA should be set to *ON* to record the XA trace log as follows. For more information, refer to **XA API References**.

```
gSQL> alter system set trace_xa = yes;
System altered.
```

XA trace log is recorded in 'xa.trc' as follows. At first, executed XA interface is recorded, and then the status (*complete* or *failed*) is recorded. The information such as session id and transaction id is also recorded. If it fails, the error code defined in **XA API References** is recorded.

```
[2014-09-15 11:45:19.599018 THREAD(7966,139931504572160)] [INFORMATION]
xa_start() complete - session(4), xid(0.3231.00), flags(0)
[2014-09-15 11:45:19.599360 THREAD(7966,139931504572160)] [INFORMATION]
xa_end() complete - session(4), xid(0.3231.00), flags(4000000)
[2014-09-15 11:45:19.599418 THREAD(7966,139931504572160)] [INFORMATION]
xa_prepare() complete - session(4), xid(0.3231.00), flags(0)
[2014-09-15 11:45:22.864563 THREAD(7966,139931504572160)] [INFORMATION]
xa_recover() complete - session(4), xid(), flags(1000000)
[2014-09-15 11:45:22.864829 THREAD(7966,139931504572160)] [INFORMATION]
xa_commit() complete - session(4), xid(0.3231.00), flags(0)
[2014-09-15 11:45:22.864887 THREAD(7966,139931504572160)] [INFORMATION]
xa_rollback() complete - session(4), xid(0.3232.00), flags(0)
[2014-09-15 11:45:22.885951 THREAD(7966,139931504572160)] [INFORMATION]
xa_forget() complete - session(4), xid(0.3230.00), flags(0)
```

```
[2014-09-15 11:45:22.886017 THREAD(7966,139931504572160)] [INFORMATION]
xa_forget() failed - session(4), xid(0.3231.00), flags(0), xa_error(-4)
```

DDL Log

For all DDL (creating, dropping, altering) generated in GOLDILOCKS database, the DDL generating sessions, overall SQL statements, status of success or failure are added in system log. In GOLDILOCKS database, DDL log is not recorded by default. TRACE_DDL should be set to *ON* as follows to record DDL trace log.

```
gSQL> alter system set trace_ddl = yes;
System altered.
```

The followings describe an example of which DDL log is recorded when a tablespace is created using the DDL.

```
gSQL> CREATE TABLESPACE TEST_TBS1
DATAFILE 'TEST_TBS1_01.dbf' SIZE 10M,
          'TEST_TBS1_02.dbf' SIZE 10M,
          'TEST_TBS1_03.dbf' SIZE 10M;
Tablespace created.
```

```
[2014-09-15 12:26:29.209210 THREAD(8149,140267442067200)] [INFORMATION]
[SESSION:11][DDL success] CREATE TABLESPACE TEST_TBS1
DATAFILE 'TEST_TBS1_01.dbf' SIZE 10M,
          'TEST_TBS1_02.dbf' SIZE 10M,
          'TEST_TBS1_03.dbf' SIZE 10M
[2014-09-15 12:26:29.209277 THREAD(8149,140267442067200)] [INFORMATION]
[SESSION:11][COMMIT with DDL]
```

If DDL statement fails, 'DDL failure' is recorded as follows.

```
gSQL> ALTER TABLESPACE TEST_TBS1 ADD DATAFILE 'TEST_TBS1_04.dbf' SIZE 10M;
ERR-42000(16130): file is already exist -
'/home/zkyungoh/work/product/Gliese/home/db/TEST_TBS1_04.dbf' :
ALTER TABLESPACE TEST_TBS1 ADD DATAFILE 'TEST_TBS1_04.dbf' SIZE 10M
*
ERROR at line 1:
```

```
[2014-09-15 12:45:08.598789 THREAD(8115,140191085913856)] [INFORMATION]
[SESSION:4][DDL failure] ALTER TABLESPACE TEST_TBS1 ADD DATAFILE 'TEST_TBS1_01.dbf' SIZE 10M
```

DDL log for table or index DDL statement is recorded in the same way. After creating a table or an index,

the committed DDL log is as follows.

```
gSQL> CREATE TABLE T1 ( I1 NATIVE_INTEGER ) TABLESPACE TEST_TBS1;
Table created.
gSQL> CREATE INDEX T1X ON T1 ( I1 );
Index created.
gSQL> COMMIT;
Commit complete.
```

```
[2014-09-15 12:40:37.887952 THREAD(8115,140191085913856)] [INFORMATION]
[SESSION:4][DDL success] CREATE TABLE T1 ( I1 NATIVE_INTEGER ) TABLESPACE TEST_TBS1
[2014-09-15 12:40:47.451806 THREAD(8115,140191085913856)] [INFORMATION]
[SESSION:4][DDL success] CREATE INDEX T1X ON T1 ( I1 )
[2014-09-15 12:40:51.017975 THREAD(8115,140191085913856)] [INFORMATION]
[SESSION:4][COMMIT with DDL]
```

The following is a rollback DDL log after creating a table or an index.

```
[2014-09-15 12:42:27.367722 THREAD(8115,140191085913856)] [INFORMATION]
[SESSION:4][DDL success] CREATE TABLE T1 ( I1 NATIVE_INTEGER ) TABLESPACE TEST_TBS1
[2014-09-15 12:42:31.317436 THREAD(8115,140191085913856)] [INFORMATION]
[SESSION:4][DDL success] CREATE INDEX T1X ON T1 ( I1 )
[2014-09-15 12:42:34.601738 THREAD(8115,140191085913856)] [INFORMATION]
[SESSION:4][ROLLBACK with DDL]
```

Trace Log Replication

Replication trace log is recorded in a separate file when using GOLDILOCKS' replication tool such as CYCLONE and LOGMIRROR. For more information about replication trace log, refer to **operating CYCLONE** in CYCLONE chapter and **operating** in LOGMIRROR chapter.

Listener Log

The errors and information which occurs from the startup of listener process until the end of the process are recorded in the listener log.

Listener Log Format

The listener log is recorded in the following format.

```
['log recorded date and time' THREAD('process id', 'thread handle')]
['log prefix'] 'log body'
```

- 'log record date and time' is the date and time of the recorded log.
- THREAD ('process Id', 'thread handle') is the information of log process id and thread handle.
- 'log prefix' is the entity or feature which created the log, and 'log body' is the detailed information.

Monitoring Performance Using View

Concurrency control for multi-user is needed because database is accessed or updated by multiple users at the same time. The concurrency should be provided for system data and shared resources as well as explicit data by SQL statements. GOLDILOCKS controls the concurrency using latch.

The concurrency control using lock can cause a deadlock when same data is updated by multiple different transactions. The concurrency control using latch (supported by GOLDILOCKS) can cause a deadlock, too. It is because the deadlock affects the performance, so a view is provided to handle the latch when a deadlock occurs.

The transactions generating the deadlock will be found when using V\$LOCK_WAIT. Then, the administrator should monitor them, and unlock the deadlock. For more information about V\$LOCK_WAIT, refer to V\$LOCK_WAIT. For more information for monitoring latch item causing the deadlock, refer to V\$LATCH.

6.

Structure and Storage Structure of GOLDILOCKS Database

6.1 Managing Control File

A database instance should be created to use GOLDILOCKS database, and the control file is created when creating a database instance. The information is written on the control file when GOLDILOCKS multilevel startup moves from nomount level to mount level. The absolute path and the size of the file to be used in database are recognized by using the recorded information on the control file. The control file is a binary file and database information is stored as follows.

Control File Contents

Table 6-1 GOLDILOCKS database system information

Item	Description
Data store mode	It stores mode which is set when database starts up. (TDS, CDS)
Server state	It is the database instance state. (NONE, RECOVERED, RECOVERING, SERVICE, SHUTDOWN)
Last checkpoint lsn	It is the LSN of the checkpoint which was executed last in the database.

Table 6-2 Log information

Item	Description
Checkpoint lid, lsn	It is the log information (LSN, log position) of the checkpoint which was executed last in the database.
Last inactivated log file sequence	It is the log file sequence which was changed to inactive last.
Archivelog mode	It is the archivelog mode of the database in operation.
Creation time	It is the database created time.

Database information stores information about database operating, all tablespace in use, and data. The database operating information stored in the control file is as follows.

Table 6-3 Database information

Item	Description
Transaction table size	It is the maximum number of using transaction table in database.
Undo relation count	It is the number of using undo relations in database.
Tablespace count	It is the number of tablespaces in use created in database.
New tablespace id	It is the tablespace ID to be created later.

Tablespace information is stored in the control file as follows.

Table 6-4 Tablespace information

Item	Description
Tablespace id	It is a unique tablespace ID.
Attributes	It is the attribute of a tablespace such as storage device (memory, disk), persistence attribute (temporary, persistent), tablespace usage (dictionary, undo, data, temporary).
Page count in extent	It is the number of extent pages.
State	It is the tablespace status. (CREATING, CREATED, DROPPING, DROPPED, AGING)
Relation id	It is the relation ID to store pending operation of tablespace.
New data file id	It is the data file ID which is set when new data file is inserted to tablespace.
Is logging	It is the logging mode of a tablespace. (LOGGING, NOLOGGING)
Is online	It is the online or offline status of a tablespace. (ONLINE, OFFLINE)
Data file count	It is the number of data files used by a tablespace.
Offline lsn	It is the last LSN which executes recovery if needed, in order to shift offline tablespace to online.
Offline state	It is the status of offline tablespace. (CONSISTENT, INCONSISTENT) CONSISTENT offline tablespace does not have to be recovered when shifting the status to online. It is because the tablespace status is shifted to offline after the most recent data in memory is stored to disk. On the other hand, INCONSISTENT offline tablespace executes recovery using the log when shifting to online.

Data file information is stored in the control file as follows.

Table 6-5 Data file information

Item	Description
Name	It is the data file name including the absolute path which stores data.
State	It is the data file status. (CREATING, CREATED, DROPPING, DROPPED, AGING)
Data file id	It is the unique data file ID in a tablespace.
Auto extend	It is whether to extend automatically or not when a data file is full.
Size	It is the data file size.
Next size	It is the size to be extend when a data file is full.
Max size	It is the maximum size of extendable data file.
Timestamp	It is the time when data file was created.
Checkpoint lsn, lid	It is the checkpoint log information when the last checkpoint is executed in the data file. (LSN, log position)
Creation lsn, lid	It is the checkpoint log information of when a data file is created. (LSN, log position)

It stores each incremental backup information operated in the database. GOLDILOCKS database supports the incremental backup for database and tablespaces, and the incremental backup information is stored in the control file as follows.

Table 6-6 Incremental backup information

Item	Description
Backup lsn, lid	It is the checkpoint log information which was executed last at the beginning of backup. (LSN, log position)
Begin time	It is the incremental backup beginning time.
Completion time	It is the incremental backup completion time.
Tablespace id	It is the unique tablespace ID of which an incremental backup is executed. If incremental backup for a tablespace is executed, its tablespace ID is recorded. If the backup is not executed for a tablespace, then the maximum tablespace ID (65535) is recorded.
Level	It is the level of executed incremental backup.
Object type	It is the target of incremental backup. (database, control file, tablespace)
Backup file name	It is the name of the incremental backup file.
Backup option	It is the incremental backup option. (cumulative, differential)

Multiplexing Control File

The control file stores the physical structure of GOLDILOCKS database and the information about data consistency. If the control file is corrupted or deleted by mistake, it is not possible to operate database.

Therefore, GOLDILOCKS database recommends creating at least two or more control files and keep them in physically separated disks. GOLDILOCKS supports multiplexing up to 8. To add control files when creating a database, set the number of multiplexing control files in the property file, and set the path of each control file. To add control files when operating database, increase the property value for control file multiplexing, and add the control file paths.

Restoring Corrupted Control File

If a control file is corrupted due to database's abnormal termination, the corrupted control file is restored using a normal control file among multiplexed control files, and then it is restarted.

If all multiplexed control files are corrupted, the backup control file is restored, and the incomplete media recovery is executed for archive redo log files and redo log files, and then it is restarted. For more information about incomplete recovery using the backup control file, refer to **When all multiplexed control files are corrupted** in recovery examples.

Control File Information

A user can enquire the control file name by using V\$CONTROLFILE which is the performance view to retrieve the location and the name of the control file as follows.

```
gSQL> SELECT CONTROLFILE_NAME FROM V$CONTROLFILE;  
CONTROLFILE_NAME
```

```
-----  
/goldilocks_data/wal/control_0.ctl
```

```
/goldilocks_data/wal/control_1.ctl
```

```
2 rows selected.
```

A user can retrieve the correct information written in the control file using **gdump** the dump tool of GOLDILOCKS.

6.2 Managing Redo Log File

GOLDILOCKS uses the redo log files to ensure database persistency. In other words, the database can be restored to the state before shutdown database using the redo log files and data files when GOLDILOCKS database is abnormally terminated due to various reasons.

In order to do so, GOLDILOCKS database uses Write Ahead Logging (WAL) policy to store log of all update operations.

The updated data by the update operation is not recorded in the data file, but the log for the update operation is recorded in the redo log file. It is because it is much more efficient in the terms of database performance. Whenever each update operation is recorded in the data file, a random access occurs and the update operations for the same file causes the excessive disk IO. However, the update log is smaller than the updated data, and it performs the efficient disk IO in a way being appended at the end of log file.

GOLDILOCKS database uses log buffer in shared memory to record the updated logs to the log buffer, and then records log buffer to the log file all together, and it leads to more efficient disk IO.

Redo Log File Structure

The redo log buffer and log file in GOLDILOCKS have a circular structure. The log files are created as many as predefined number of log groups, and then they record logs. If a log file is full, the following log file is used. When all log files are used up, the previously used log file is reused. The log file is a circular structure consisting of a single log group of several members. GOLDILOCKS performs the logging using minimum four log groups.

Figure 1 GOLDILOCKS redo log file, log buffer structure

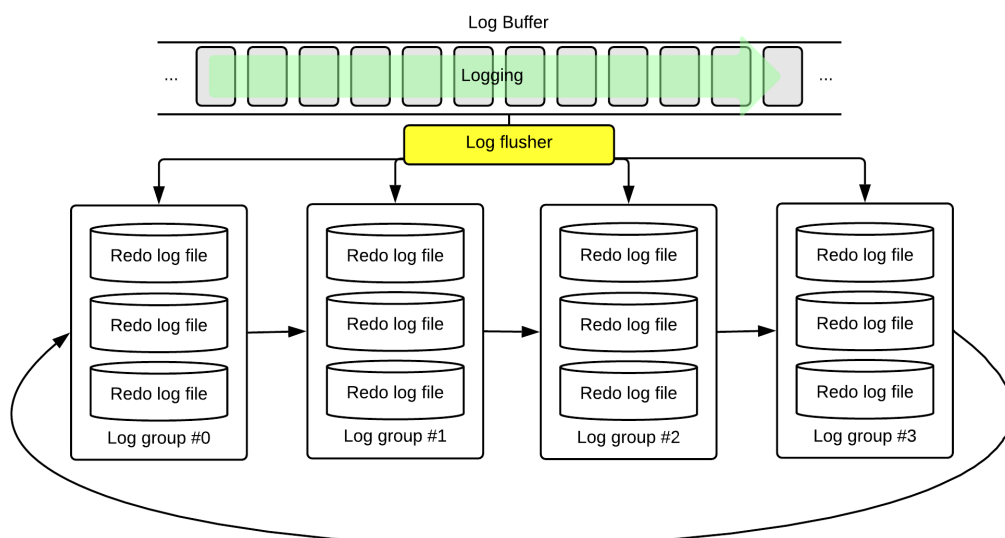

Redo Log Group and Its Member

GOLDILOCKS database uses a log group and members to record logs to the disk log file during database operation. A single redo log file is a member of a log group, and a log group consists of several log members. Log group which consists of many members ensures high availability because other log members can be used when a particular disk fails or a particular log member is corrupted.

The system records logs to a log group, and if the log group is full, the following group is used. This is a circular log group. The currently used log group shifts to the following log group one and this is called as log switching.

A log group, the number of members and each of its position are set by the property when creating database. They can be altered by adding or dropping syntax when operating database.

Log Group State

The state of log group is initialized to UNUSED when creating it. It is changed to CURRENT, ACTIVE, and INACTIVE state by the system during operation.

Table 6-7 GOLDILOCKS log group state

Log group state	Description
UNUSED	The log group has never been used after creation.
CURRENT	The log group is being used by the current system.
ACTIVE	It is not yet ready to be reused after CURRENT log group is switched.
INACTIVE	ACTIVE state log group is ready to be reused.

ACTIVE log group can not be reused in the system, but it can be reused after it is changed to INACTIVE by archive log thread. Archive log thread wakes up by an event before the checkpoint is completed, and it changes ACTIVE log groups to INACTIVE state. In order to do so, log archiving thread archives log file in ACTIVE log group, then change it to INACTIVE when the system is operated in ARCHIVELOG mode. If the system is operated in NOARCHIVELOG mode, then the ACTIVE log group is immediately reusable after changing the log group state to INACTIVE.

Adding Log Group and Log Member

Adding Log Group

Adding log group is allowed only in mount phase of GOLDILOCKS database multilevel startup. The new log group is added next to the CURRENT state of the log group which is currently being used.

The following is an example to add a new log group whose file name is 'abc.log', and file size is 20 Mbytes to group ID 10.

```
ALTER DATABASE ADD LOGFILE GROUP 10 ('abc.log') SIZE 20M;
```

Adding Log Member

A new log member can be added for the stability of log group in use. It can be added in mount phase of GOLDILOCKS database multilevel startup in the same way of adding log group. The following is an example to add the log file named as 'test log' to group ID 10. The log file size is not specified because the log member size in a log group is same.

```
ALTER DATABASE ADD LOGFILE MEMBER 'test.log' TO GROUP 10;
```

Altering Log Member Name

The position and the file name of the log member in use can be altered by executing RENAME in mount phase. RENAME is executed for log member when the log member's disk is physically failed or the log member should be transferred to another disk in terms of performance.

The following is an example to RENAME the log file '/disk1/goldilocks_data/wal/redo_0_0.log' to the log file '/disk2/goldilocks_data/wal/redo_0_0.log'.

```
ALTER DATABASE RENAME LOGFILE '/disk1/GOLDILOCKS_data/wal/redo_0_0.log' TO  
'/disk2/GOLDILOCKS_data/wal/redo_0_0.log';
```

Dropping Log Group or Log Member

A log member or log group in use can be dropped in mount phase when a user wants to reduce log groups, log members or when log file disk is failed.

The following is an example to drop all members of log group ID 10.

```
ALTER DATABASE DROP LOGFILE GROUP 10;
```

Dropping log member is allowed only when at least two members exist in the log group.

The following is an example to drop the '/disk1/goldilocks_data/wal/redo_0_0.log' log member.

```
ALTER DATABASE DROP LOGFILE MEMBER '/disk1/GOLDILOCKS_data/wal/redo_0_0.log';
```

Restoring Corrupted Redo Log File

If the system fails and the redo log files are corrupted, then the restart recovery fails and the system cannot be operated. If normal log members exist in the corrupted log group, the restart recovery and the system

m operation can be executed by copying the log file of the normal log member to the corrupted log files.

If all log files in a log group are corrupted or there is only one log member, it can be restarted by executing incomplete media recovery. The incomplete media recovery is restricted to the normal log file.

For more information about incomplete media recovery, refer to **Incomplete Recovery**.

Redo Log File Information

A user can enquire V\$LOGFILE which is a performance view to retrieve the location and the name of the redo log files. When inquiring V\$LOGFILE, the log file name, its log group ID, its state, the file size are retrieved as follows.

```
gSQL> SELECT FILE_NAME, GROUP_ID, GROUP_STATE, FILE_SIZE FROM V$LOGFILE;
FILE_NAME                                GROUP_ID GROUP_STATE FILE_SIZE
-----
/disk1/goldilocks_data/wal/redo_0_0.log   0  INACTIVE  104857600
/disk1/goldilocks_data/wal/redo_1_0.log   1  CURRENT   104857600
/disk1/goldilocks_data/wal/redo_2_0.log   2  UNUSED    104857600
/disk1/goldilocks_data/wal/redo_3_0.log   3  UNUSED    104857600
4 rows selected.
```

6.3 Managing Archive Redo Log File

The database should be operated in archive log mode for media recovery using backup, because GOLDILOCKS redo log file reuses log group which is used when *circular* structure log group is used. Then the written completed redo log files are copied to the archive redo log files.

For more information about GOLDILOCKS database's archive log mode, refer to **ARCHIVELOG Mode**.

Creating Archive Redo Log File

The redo log file is copied to archive redo log file directory by log archiving thread which is GOLDILOCKS database's system thread. Log archiving thread is activated by checkpoint thread during checkpoint, and it archives the proper object among redo log files.

Archive redo log file is created in the directory set by the ARCHIVELOG_DIR_1 property. The name of archive redo log file is composed of its prefix set by the ARCHIVELOG_FILE property and of the sequence number of each redo log file.

Maintaining and Dropping Archive Redo Log File

Media recovery using backup can fail if archive redo log files, similarly to the redo log files, are arbitrarily dropped. Therefore, archive redo log files should be saved with backup files, and the archive redo log files for media backup can be dropped when the backup file is not needed any more.

Backup is copying the data file which is downloaded to the disk by the most recent checkpoint. Therefore, the archive log files of the oldest LSN and later are needed to recover media using backup. Checkpoint is executed by the system when redo log file is switched, so one or more checkpoint logs exist in every log file except for the redo file in CURRENT state.

The followings describe how to get the archive redo log file required for media recovery using backup file.

1. Get the checkpoint LSN which is recorded in the file header of backup data files.
2. Dump the archive redo log file, and get the archive redo log file including checkpoint LSN.
3. The archive redo log file needed for the media recovery using backup begins just before the archive redo log file of No. 2.

Dump the control file and get the checkpoint LSN to get the archive redo log file needed for incremental backup. Subsequent process is as same as the entire backup process.

If backup files are not needed any more, the archive redo log file required for the media recovery using ba

ckup can be removed.

Multiplexing Archive Redo Log File Directory

If the archive redo log file is moved from the directory set in ARCHIVELOG_DIR_1 to the other directory or media to preserve the archive redo log file, the media recovery fails because it can not find the required archive redo log file.

Move the archive redo log file back to the directory set in ARCHIVELOG_DIR_1 to resolve this problem. Or set the archive log files existing directory to ARCHIVELOG_DIR_2 ~ ARCHIVELOG_DIR_10, and add archive redo file directory for media recovery. READABLE_ARCHIVELOG_DIR_COUNT should be set as many as the number of directory when using ARCHIVELOG_DIR_2 ~ ARCHIVELOG_DIR_10 for the media recovery.

6.4 Managing Tablespace

All the data used in database are stored in physical disk file, and use the database's logical structure for efficient data management and performance. GOLDILOCKS manages the disk space efficiently by using the logical structure such as tablespace, segment, extent, and page.

A tablespace can include multiple data files, and each tablespace is set to online/offline to support high data availability. Distributing data storing disks improves the IO performance, and reduces the contention of physical disk IO.

Tablespace Type

GOLDILOCKS tablespace is divided into SYSTEM tablespace and non-SYSTEM tablespace. SYSTEM tablespace is created when database is created, and it is used and controlled only by the GOLDILOCKS system. Non-SYSTEM tablespace is created and used by a user.

SYSTEM Tablespace

It is created when GOLDILOCKS database is created, and it is essential for database operation. There are dictionary tablespace, undo tablespace and system temporary tablespace.

Non-SYSTEM Tablespace

It is a tablespace in which tables and indexes are stored for data storing, and a user can arbitrarily creates or drops.

Managing Tablespace and Data File

Managing Tablespace

Managing Tablespace State

The GOLDILOCKS database tablespace state is divided into online and offline. The offline tablespace is not accessible. A user can arbitrarily set the tablespace state to offline. Or, an abnormal tablespace can be set to offline by the system. The system tablespace should not be set to offline.

- Offline tablespace

GOLDILOCKS database flushes all data files in the tablespace to disk before the tablespace is set to offline. All related logs should be flushed to disk to flush data file. Therefore, a recovery is not needed when switching to online later. However, it is applied when DDLs occurred in the offline tablespace state is changed to online state.

A tablespace can be immediately set to offline using IMMEDIATE mode, without flushing data file. In this case, the tablespace state is changed to online after media recovery when setting the tablespace to online.

Table 6-8 Tablespace offline option

Option	Description	Media recovery when setting the tablespace to online
NORMAL	Flushing all the data file related logs in tablespace to the disk, then set it to offline	Media recovery is not required.
IMMEDIATE	Immediately setting a tablespace to offline	Media recovery is required.

GOLDILOCKS can set tablespace to offline in mount phase. To do so, the service should be normally terminated, or the server should be operated in ARCHIVELOG mode. This method provides high availability by performing service excluding the unrecoverable tablespaces when starts up database.

```
gSQL> ALTER TABLESPACE TEST_TBS OFFLINE;
```

```
Tablespace altered.
```

```
gSQL> ALTER TABLESPACE TEST_TBS ONLINE;
```

```
Tablespace altered.
```

```
gSQL> ALTER TABLESPACE TEST_TBS OFFLINE IMMEDIATE;
```

```
Tablespace altered.
```

```
gSQL> ALTER TABLESPACE TEST_TBS ONLINE;
```

```
ERR-42000(14051): media recovery required - 'TEST_TBS'
```

```
gSQL> ALTER DATABASE RECOVER TABLESPACE TEST_TBS;
```

```
Database altered.
```

```
gSQL> ALTER TABLESPACE TEST_TBS ONLINE;
```

Tablespace altered.

Attributes of Tablespace

The followings are attributes of tablespace in GOLDILOCKS database. PERSISTENT or TEMPORARY indicates whether persistence is ensured or not. DATA or UNDO indicates the the type of tablespace and stored data.

Table 6-9 Tablespace attributes of GOLDILOCKS database

Attributes		Description
Persistence	PERSISTENT	It supports persistence of data stored in a tablespace. (A recovery is required.)
	TEMPORARY	It does not support persistence of data stored in a tablespace.
Type of stored data	DATA	It stores the user input data.
	UNDO	It stores data required for MVCC of database.
	DICTIONARY	It stores dictionary information for database operation.
	TEMPORARY	It stores data for SQL processing.

Managing Tablespace

- Creating user tablespace

It creates a new user tablespace. The name of tablespace being used in the database instance should be unique when creating tablespace. A tablespace can have up to 1024 data files, and the size of each data file can be up to 30 GBytes. The database can create tablespaces up to 65,535, including system tablespace.

The data file name including the absolute path in the data file should be unique. Use 'REUSE' option to reuse the existing data file which is not being used in database. An extent size of a tablespace is selectable among 64 Kbytes, 128 Kbytes, 256 Kbytes, 512 Kbytes and 1 Mbyte, and the default extent size is 256 Kbytes.

```
gSQL> CREATE TABLESPACE TEST_TBS DATAFILE
      '/goldilocks1/db/TEST_TBS1.dbf' SIZE 20M,
      '/goldilocks2/db/TEST_TBS2.dbf' SIZE 50M,
      '/goldilocks3/db/TEST_TBS3.dbf' SIZE 100M REUSE;
```

Tablespace created.

The state can be set to ONLINE/OFFLINE when creating tablespace, and the LOGGING/NOLOGGING property also can be set.

- Dropping tablespace

The tablespace and data file can be dropped when the tablespace is not needed any more. The unused tablespace should be dropped not to waste the resources. It is because once tablespace is created, the added disk data file and memory is created and remains.

```
gSQL> DROP TABLESPACE TEST_TBS;
Tablespace dropped.
```

Dropping the tablespace does not drop its table index in use by default. Therefore, *INCLUDING CONTENTS* option should be used together when dropping tablespace including tables or indexes in use.

```
gSQL> DROP TABLESPACE TEST_TBS;
ERR-42000(16148): tablespace not empty, use INCLUDING CONTENTS option :
drop tablespace TEST_TBS
          *
ERROR at line 1:
gSQL> DROP TABLESPACE TEST_TBS INCLUDING CONTENTS;
Tablespace dropped.
```

Use *AND DATAFILES* option to drop the data files added in the tablespace.

```
gSQL> DROP TABLESPACE TEST_TBS INCLUDING CONTENTS AND DATAFILES;
Tablespace dropped.
```

- Altering tablespace size

Add datafiles to the tablespace or drop datafiles from the tablespace to alter the tablespace size. Add new datafiles to tablespace to spare space when the storing space is not enough during database operation. Or, drop unused datafile from tablespace not to waste the space.

```
gSQL> ALTER TABLESPACE TEST_TBS ADD DATAFILE 'TEST_TBS2.dbf' SIZE 20M;
Tablespace altered.
gSQL> ALTER TABLESPACE TEST_TBS DROP DATAFILE 'TEST_TBS2.dbf';
Tablespace altered.
```

The data file could be dropped from tablespace only when it has never been used since its creation. The data file can not be dropped once it has been used even when all data was dropped.

```
ALTER TABLESPACE TEST_TBS DROP DATAFILE 'TEST_TBS2.dbf';
ERR-42000(14044): datafile not empty
```

- Managing temporary tablespace

Temporary tablespace does not store data file, but it allocates memory of specified size. Create the tempo

rary tablespace as follows.

```
gSQL> CREATE TEMPORARY TABLESPACE TEST_TBS MEMORY 'TEST_TEMP_TBS' SIZE 10M EXTSIZE 256K;
Tablespace created.
```

Add memory to the temporary tablespace as follows.

```
gSQL> ALTER TABLESPACE TEST_TBS ADD MEMORY 'TEST_TBS2' SIZE 10M;
Tablespace altered.
```

Drop the unused memory from the temporary tablespace as follows.

```
gSQL> ALTER TABLESPACE TEST_TBS DROP MEMORY 'TEST_TBS2';
Tablespace altered.
```

Drop the temporary tablespace as follows.

```
gSQL> DROP TABLESPACE TEST_TBS INCLUDING CONTENTS AND DATAFILES;
Tablespace dropped.
```

Transferring Data File

The data file storage path stored in the database should be modified when altering the datafile storage disk, or directory.

The following is an example to describe how to modify the path when transferring the datafile '/goldilocks1/db/TEST_TBS1.dbf' in tablespace TEST_TBS to '/goldilocks4/db/TEST_TBS1.dbf'.

```
gSQL> ALTER TABLESPACE TEST_TBS RENAME DATAFILE
    '/goldilocks1/db/TEST_TBS1.dbf' TO '/goldilocks4/db/TEST_TBS1.dbf';
Tablespace altered.
```

Tablespace Information

For more information about the tablespaces created in database, refer to **V\$TABLESPACE**.

```
gSQL> \DESC V$TABLESPACE
COLUMN_NAME      TYPE                IS_NULLABLE
-----
TBS_NAME         CHARACTER VARYING(128) FALSE
TBS_ID           NUMBER              FALSE
TBS_ATTR         CHARACTER VARYING(128) FALSE
IS_LOGGING       BOOLEAN             FALSE
```

IS_ONLINE	BOOLEAN	FALSE
OFFLINE_STATE	CHARACTER VARYING(32)	FALSE
EXTENT_SIZE	NUMBER	FALSE
PAGE_SIZE	NUMBER	FALSE

6.5 Managing Data File

Data File Matching

Data file can be corrupted due to disk failure, database defects or human error. If the corrupted data file is used in database, serious problems occur.

GOLDBLOCKS database ensures the matching of the data file using a checksum for each page of the data file. GOLDBLOCKS database's page checksum is generated using LSN and CRC value, and it is stored in each page. A user sets the page checksum type using the value in **PAGE_CHECKSUM_TYPE**, and uses LSN or the default value.

The page checksum is checked when loading the data file into the memory at database startup. If an error occurs concerning the checksum value, the database cannot start up the service.

The following is an example to describe the database startup failure when the datafile TEST_TBS.dbf in the tablespace TEST_TBS created by a user is not matching.

```
gSQL> \STARTUP MOUNT
Startup success
gSQL> ALTER SYSTEM OPEN DATABASE;
ERR-HY000(14094): datafile recovery required - datafile(/goldilocks/db/TEST_TBS.dbf) of
tablespace(TEST_TBS) corrupted
```

In case when the data file is not matching, set its tablespace having the data file to *OFFLINE*, or recover the data file to restart the database.

The following describe how to start up the database after setting the tablespace to *OFFLINE*.

```
gSQL> \STARTUP MOUNT
Startup success
gSQL> ALTER SYSTEM OPEN DATABASE;
ERR-HY000(14094): datafile recovery required - datafile(/goldilocks/db/TEST_TBS.dbf) of
tablespace(TEST_TBS) corrupted
gSQL> ALTER TABLESPACE TEST_TBS OFFLINE IMMEDIATE;
Tablespace altered.
gSQL> ALTER SYSTEM OPEN DATABASE;
System altered.
```

Data file full backup or incremental backup should exist when recovering the data file.

The following describes how to recover the data file when backup exists.

```
gSQL> \STARTUP MOUNT
Startup success
gSQL> ALTER SYSTEM OPEN DATABASE;
ERR-HY000(14094): datafile recovery required - datafile(/goldilocks/db/TEST_TBS.dbf) of
tablespace(TEST_TBS) corrupted
gSQL> ALTER DATABASE RECOVER DATAFILE 'TEST_TBS.dbf' CORRUPTION;
Database altered.
gSQL> ALTER SYSTEM OPEN DATABASE;
System altered.
```

Data File Information

For more information about data files being used in database, refer to **V\$DATAFILE**.

```
gSQL> \DESC V$DATAFILE
COLUMN_NAME      TYPE                                IS_NULLABLE
-----
TBS_NAME         CHARACTER VARYING(128)             FALSE
DATAFILE_NAME    CHARACTER VARYING(1024)           FALSE
CHECKPOINT_LSN   NUMBER                             FALSE
CREATION_TIME    TIMESTAMP(2) WITHOUT TIME ZONE    FALSE
FILE_SIZE        NUMBER                             FALSE
```

7.

Backup and Recovery of GOLDILOCKS Database

This chapter describes GOLDILOCKS database backup and recovery, database ARCHIVELOG mode for the backup and recovery.

7.1 ARCHIVELOG Mode

GOLDILOCKS database executes logging using circular log group. A circular log group consists of at least four log groups, and if all log allocated to a log group are run out, then following log group is used. If all created log groups are run out, the first log group is reused. In this case, the new log file is not created but the previously recorded log file is reused.

The previously written logs are lost if a log group is reused in NOARCHIVELOG mode. Therefore, if an administrator does not manage the completed logging group, the completed transactions logs disappears while operating in NOARCHIVELOG mode.

On the other hand, in ARCHIVELOG mode, the system archives log files prior to reusing it when using the following log groups after the completion of recording on log file in a log group. Then the completed logs are permanently preserved unless they are deliberately deleted.

ARCHIVELOG Mode

Log files should be archived before they are reused. It is because all log files after backup moment is required for the recovery using backup, and the backup could be needed anytime. Therefore, the backup is supported only in ARCHIVELOG mode.

The service can be interrupted in busy system due to archiving when operating in ARCHIVELOG mode. Also, an additional space is needed to store files.

NOARCHIVELOG Mode

Backup is not supported in NOARCHIVELOG mode, because it can not be determined if the log files of before reusing exist.

However, system does not archive log files. Therefore, the interruption due to an archiving at checkpoint when bulk logs are continuously being recorded does not occur. Also, it does not need a storage space for archive log files.

NOARCHIVELOG mode is set by the 'ARCHIVELOG_MODE' property value when creating database. Data

base is created in NOARCHIVELOG mode if the 'ARCHIVELOG_MODE' value is 0, and it is created in ARCHIVELOG mode when the 'ARCHIVELOG_MODE' value is 1. This property is valid only when creating database, and it is not referenced when operating database.

Execute the following syntax in mount phase of GOLDILOCKS database startup level to change ARCHIVELOG mode during database operation.

```
gSQL> ALTER DATABASE ARCHIVELOG;
```

```
Database altered.
```

```
gSQL> ALTER DATABASE NOARCHIVELOG;
```

```
Database altered.
```

Enquire *ARCHIVELOG_MODE* of *V\$ARCHIVELOG* which is the performance view to retrieve archive log mode set in database.

```
gSQL> SELECT ARCHIVELOG_MODE FROM V$ARCHIVELOG;
```

```
ARCHIVELOG_MODE
```

```
-----
```

```
NOARCHIVELOG
```

```
1 row selected.
```

7.2 Backup and Recovery

Backup

The Purpose of Backup and Recovery

Database can protect and recover data when various failures or data loss occurs. There are many reasons for failures. The duplicated copy is required especially when the database is physically corrupted or damaged by disaster, and this is called as backup.

When database service is not available due to various failures, it becomes available again by using current database or backup, and this is called as recovery. The restart recovery is to recover by using the current database. The media recovery is to recover by using the backup. GOLDILOCKS automatically or manually performs the media recovery to recover the backup data file, then recover and restarts by the restart recovery.

Backup

Database backup is divided into physical backup and logical backup. Generally, backup means making copy of data files online. This chapter describes the online physical backup.

Table 7-1 Database backup type

Backup type	Backup form	Database state	Description
Physical backup	Cold backup	Offline	Creating the copy of data file Stopping service to execute backup
	Hot backup	Online	Creating the copy of data file Executing backup during service operation Available only in ARCHIVELOG mode
Logical backup	Export backup	Online	Backup/recovery in table unit Exporting regardless of HW/OS

GOLDILOCKS uses data files and control files for executing service, and they should be recovered when they were corrupted from a failure. A control file is created when creating database, and stores necessary information to operate database. A data file stores actual data, and they are data files in system tablespace created when database is created and datafiles in user made tablespace. Use backup files for recovery when some of those control files or data files are corrupted.

In other words, control files and data files should be backed up for recovery. In order to do so, GOLDILOCKS supports control file backup, database backup, and tablespace backup.

Depending on the backup method, it is divided into full backups and incremental backups. Full backup co

copies data files in time of backup, and an incremental backup copies only modified parts since the previous backup. The full backup copies data files, so the copy is as big as the data file is created every time of backup. Therefore, it consumes the storage space as much as the size of database or tablespace.

On the other hand, the size of the incremental backup is relatively small because it copies only the modified part after the previous backup.

Table 7-2 Full backup vs. incremental backup

Item	Full backup	Incremental backup
Backup object	<ul style="list-style-type: none"> Database: Entire data file which is being used by database Tablespace: Data files in database's specific tablespace 	
Description	<ul style="list-style-type: none"> Backup entire data file which is being used by database or tablespace Creating a backup file per a data file Restoring the required data file after failure by using appropriate backup method, then recover it 	<ul style="list-style-type: none"> Backup the modified part of the data file being used by database or tablespace after the previous backup Creating an incremental backup file in which the modified part is recorded Recovery by using multiple incremental backups after failure

Full Backup

Use full backup to execute database backup and tablespace backup. Database backup is to backup control files and data files.

Control File Backup

Backup the control file as follows. Specify the backup control file name including the absolute path, or specify the backup control file name only. If only the backup control file name is specified, the backup file is created in the path set in the 'LOG_DIR' property.

```
gSQL> ALTER DATABASE BACKUP CONTROLFILE TO '/goldilocks_data/backup/backup.ct1';
Database altered.
```

Database Backup

Database backup can backup entire data file being used in database. When backup data file, recording on the file should be prevented while copying the data file. If the file is used during copying, the data file becomes inconsistent, and even worse it will be inconsistent within a page. Set the database to the state which enables backup to prevent those inconsistencies.

```
gSQL> ALTER DATABASE BEGIN BACKUP;
Database altered.
```

Use operating system's file copy feature to create the copy of data file on database backup enabled state. Then set it as follows, then the database backup is completed, and it is writable.

```
gSQL> ALTER DATABASE END BACKUP;  
Database altered.
```

Tablespace Backup

Tablespace backup can backup data files being used by a specified tablespace. Set it to backup enabled state by using the table space name(`tablespace_name`) as follows for the same reason of database backup.

```
gSQL> ALTER TABLESPACE TEST_TBS BEGIN BACKUP;  
Tablespace altered.
```

Use operating system's file copy feature to create the copy of tablespace's data file on tablespace backup enabled state. Then, complete the tablespace backup as follows.

```
gSQL> ALTER TABLESPACE TEST_TBS END BACKUP;  
Tablespace altered.
```

Incremental Backup

An incremental backup supports database unit backup and tablespace unit as same as full backup. An incremental backup does not backup control files separately, but the control file is backed up together when executing the database incremental backup.

GOLDILOCKS supports incremental level from 0 to 4 for an incremental backup. When an incremental backup is executed for the first time, the level should be set to 0, and backup the entire data file. Set the incremental backup level to 1 or higher to back up only the modified parts since the last backup when executing the incremental backup later.

The given level of incremental backup searches for the time when the same level or lower level was executed. Then, it backs up only the modified parts after the previous backup.

For example, after performing level 0 backup, level 2 backup(1) backs up only the modified parts after the level 0 backup, and level 2 backup(2) backs up the modified part after the level 2(1) backup. In the same way, level 2 backup(3), (4), (5), (6) backs up the modified part after the level 2 backup. The level 1 backup which was executed lastly backs up all modified parts after the level 0 backup.

Figure 1 Incremental backup

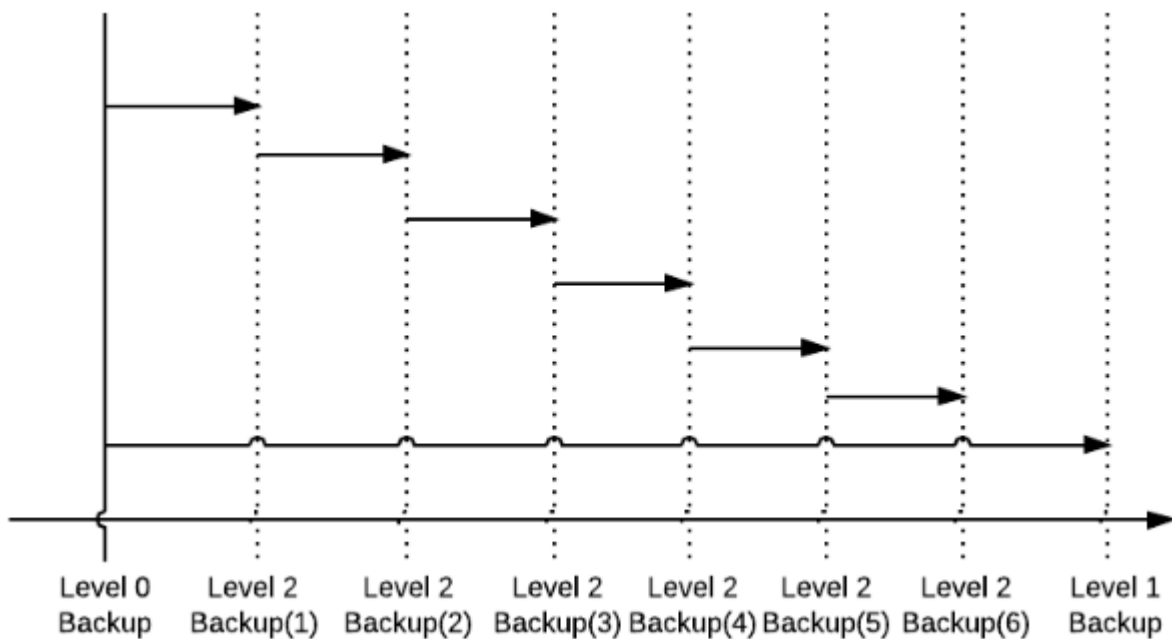

Database Incremental Backup

Execute an incremental backup on the entire data file of database as follows. At first, the entire data file of database is backed up at level 0.

```
gSQL> ALTER DATABASE BACKUP INCREMENTAL LEVEL 0;
Database altered.
```

And then, the modified part after level 0 is backed up at level 1.

```
gSQL> ALTER DATABASE BACKUP INCREMENTAL LEVEL 1;
Database altered.
```

Tablespace Incremental Backup

At first, the entire data file of tablespace is backed up at level 0 as follows in the same way as the database backup.

```
gSQL> ALTER TABLESPACE TEST_TBS BACKUP INCREMENTAL LEVEL 0;
Tablespace altered.
```

And then, the modified part after level 0 is backed up at level 1.

```
gSQL> ALTER TABLESPACE TEST_TBS BACKUP INCREMENTAL LEVEL 1;
Tablespace altered.
```

Recovery

Database guarantees data consistency by executing recovery when a failure occurs or database is corrupted.

The types of database failure are as follows.

Table 7-3 Database failure type

Failure type	Causes and symptoms	Solution
Transaction failure	Transaction failure and deadlock due to the logical error (bad input, overflow, data not found)	Abort transaction
System crash	Corruption of volatile storage device due to an abnormal termination (blackout) of DBMS or OS	Restart recovery
Media failure	Corruption of non-volatile storage device	Restore, restart recovery

Abort the executing transactions, rollback all database updates and release obtained lock items to solve transaction failure.

Database processes are abnormally terminated at system crash, so the recent information stored in volatile storage are not reflected in the non-volatile storage, and they are lost. Startup database, and recover the database to the state when it was consistent before abnormal termination. This process is called as restart recovery. To recover the database, the restart recovery uses control files, data files, and log files which were used by database before the failure.

The recovery using database file before failure is not possible if non-volatile storage device is corrupted. It is because control files, datafiles and log files are corrupted so that they can not be used for recovery. In this case, recover the database file by using previously archived backup files and log files, then execute the recovery.

GOLDILOCKS supports both the complete recovery and the incomplete recovery. The complete recovery recovers the datafile to the latest and consistent state by using the log file. The complete recovery targets database, tablespace and data file. For the tablespace and data file, the complete recovery is available for the offline tablespace even during the database service. The complete recovery is divided into the automatic recovery and the manual recovery. The automatic recovery is performed when restarting the database, and the manual recovery uses the recovery statement supported by GOLDILOCKS.

The incomplete recovery is available only for the database, and it recovers to the consistent state of a specific point. The incomplete recovery is performed only manually. It incompletely recovers at once up to the specific point, or it performs the user selective incomplete recovery. The user selective incomplete recovery is a method of which a user selects a log file available to recover and recovers up to that user selected log file.

If both the complete recovery and the incomplete recovery is required, then use redo log and archive log f

iles.

Table 7-4 Database recovery

Recovery	Target	Description
Complete recovery	Database, tablespace, datafile	<ul style="list-style-type: none"> • Automatic recovery (Recovers at the restart) • Manual recovery (Manually recovers the database, tablespace and data file.)
Incomplete recovery	Database	<ul style="list-style-type: none"> • Manual recovery only <ul style="list-style-type: none"> ◦ Incomplete recovery at once ◦ User selective incomplete recovery

Automatic Recovery

The automatic recovery is executed when restarting after a normal or abnormal termination of database. It uses the control files, data files and log files which were used just before the termination.

Especially when the latest database file is corrupted, the backed up database file is recovered and the automatic recovery is executed by using the archive log file.

The recovery is executed in three phases, and they are analysis, redo and undo.

Analysis

Two operations are executed in analysis phase.

First, it searches for the first log to perform the restart recovery. For that, it refers to the most recently executed checkpoint log, and looks for the most recent checkpoint log from the log information recorded in control file.

Second, it initialize the transaction table of the system. It uses transaction information which was executed at checkpoint written on checkpoint log to initialize system transaction table.

Restart Redo

All logs, from the first log obtained in the analysis phase for restart recovery to the last log recorded in the redo log files, execute restart redo. The transaction table is updated when a transaction is completed or a new transaction is started during this process.

Restart Undo

After restart redo is completed, it performs the transaction rollback by performing undo all incomplete transactions remained in the transaction table.

Recovery Using Backup

If control files, data files and log files are corrupted or does not exist, the recovery should be performed after it is recovered by using the backup file. It is complicated to find the log on which the recovery starts when performing the recovery by using the backed up control file or the data file.

Analysis for Recovery Using Backup

In analysis phase for the recovery using backup, like as the automatic recovery, it searches for the first log for recovery and initializes the transaction table. It searches for the oldest LSN among the checkpoint LSN recorded in all the data file's file header, then selects the minimum value by comparing it with checkpoint LSN recorded in control file to find the first log for recovery.

The checkpoint LSN recorded in data file header stores the checkpointed LSN of the corresponding data file. Therefore, when using the backup datafile, select the oldest checkpoint LSN, and then select the minimum value comparing to the checkpoint LSN in the control file, then the minimum checkpoint LSN for the recovery is determined.

Figure 2 Procedure to determine the minimum checkpoint LSN for the recovery

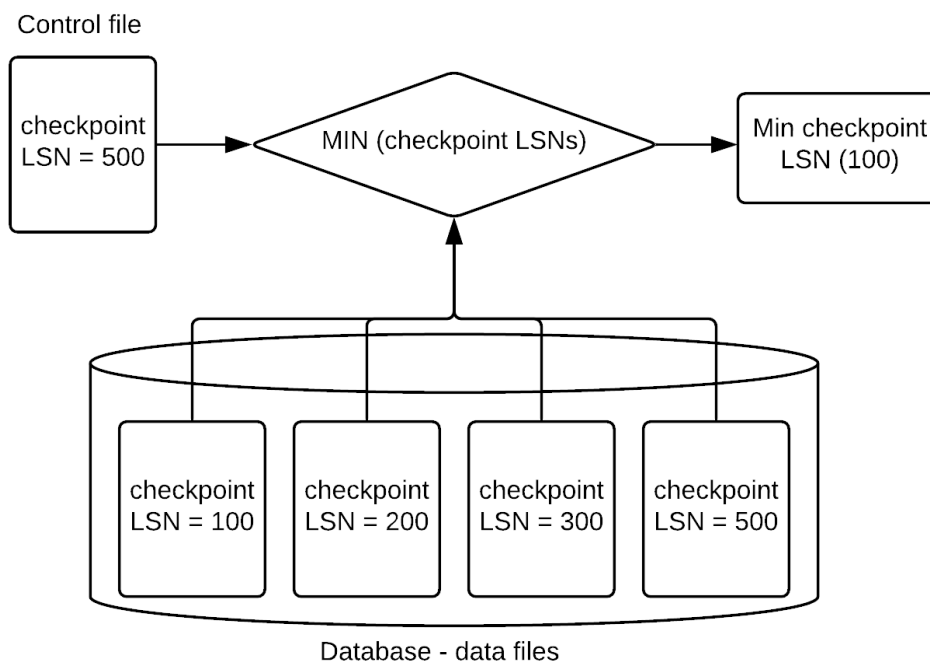

Recovery Using Archive Log Files

The recovery using archive log files uses not only redo log files but also archive log files, when the minimum checkpoint LSN defined for the recovery is in an archive log file. The recovery using the backup is executed in a unit of database, tablespace and data file. Database recovery is executed only on MOUNT phase, and the recovery in tablespace and data file unit is executed on MOUNT phase or OPEN phase.

- Restoring the backup data files

Restoring data files is executed by using the full backup or the incremental backup. A user directly executes the full backup by using operating system's file copy command to restore data. On the other hand, the incremental backup is executed by using restoring syntax of GOLDILOCKS. The tablespace should be OFFLINE to restore data files on OPEN phase.

The followings describe how to restore data files using incremental backup.

```
gSQL> ALTER DATABASE RESTORE;
```

```
Database altered.
```

```
gSQL> ALTER DATABASE RESTORE TABLESPACE TEST_TBS;
```

```
Database altered.
```

- Manual recovery after restoring data files

The followings describe how to execute recovery using the syntax of recovery after restoring data files.

```
gSQL> ALTER DATABASE RECOVER;
```

```
Database altered.
```

```
gSQL> ALTER DATABASE RECOVER TABLESPACE TEST_TBS;
```

```
Database altered.
```

Incomplete Recovery

If the restart recovery is not available due to a user mistake during operation, corrupted control files, or corrupted redo log files and archive log files nor can the recovery restore consistency of database, then execute the incomplete recovery. The incomplete recovery restores data only until the point-in-time.

The followings are when the incomplete recovery is required.

Corrupted Control Files

Control files are multiplexed, so they can be recovered using uncorrupted files if not all of the multiplexed files are corrupted.

However, if all control files are corrupted, recovery should be executed using the backup control files. In this case, the complete recovery is impossible because the log information of the control files can be changed. The recovery restores only until point-in-time.

Restoring Backup Control File

When control files are corrupted, copy other multiplexed control files to keep control files up-to-date. However, when all multiplexed control files are corrupted, restore the backup control files, then perform the recovery. The log information which is changed after the backup can not be recovered when executing recovery using the backup data files.

Corrupted Redo Log File

GOLDILOCKS consists redo log files with several log members in a log group to prevent log file corruption. However, if all log members in a log group are corrupted, it can not be recovered using redo log file. In this case, an incomplete recovery should be executed until uncorrupted log file.

Corrupted Archive Log File

In recovery, if archive log file is corrupted, then incomplete recovery should be executed until uncorrupted log file. The process is as same as when redo log file is corrupted.

User's Mistake

When a user dropped an important table by mistake, or inserted, updated, deleted wrong data, it should be recovered back to the point before the mistake.

Incomplete Recovery of GOLDILOCKS Database

GOLDILOCKS supports two types of incomplete recovery. One of the recovery is executed until the point which an operator specified. The other recovery is executed in log file unit interactively between an operator and system.

The incomplete recovery until a specified point can specify the point-in-time by using a specified log's LSN, specified time, or a specified SCN.

Incomplete recovery is executed for the entire database only on MOUNT phase. Incomplete recovery in the specific tablespace unit is not supported due to the database consistency problem.

- Incomplete recovery until specified LSN

It searches for log which will complete the incomplete recovery, then executes the recovery until the log's LSN.

The following is an example of executing the incomplete recovery until log LSN 1000.

```
gSQL> ALTER DATABASE RECOVER UNTIL CHANGE 1000;
Database altered;
gSQL> ALTER DATABASE RECOVER UNTIL CHANGE LSN 1000;
Database altered;
```

- Incomplete recovery until specified SCN

It searches for SCN which will complete the incomplete recovery, then executes the recovery until the log's SCN.

The following is an example of executing the incomplete recovery until SCN 300.

```
gSQL> ALTER DATABASE RECOVER UNTIL CHANGE SCN 300;
Database altered;
```



SCN is not sequentially recorded so even when the incomplete recovery is executed until SCN 300, it may be recovered beyond SCN 300. The following is an example of the recovery when SCN is reversed.

Log: --- LSN 90 (SCN 3) -- LSN 91 (SCN 5) -- LSN 92 (SCN 4)

```
gSQL> ALTER DATABASE RECOVER UNTIL CHANGE SCN 3;
→ It is recovered until LSN 90.
```

```
gSQL> ALTER DATABASE RECOVER UNTIL CHANGE SCN 4;
→ It is recovered until LSN 92. (It is recovered until LSN 92 in which SCN 4 is.)
```

```
gSQL> ALTER DATABASE RECOVER UNTIL CHANGE SCN 5;
→ It is recovered until LSN 92. (Both SCN 4, SCN 5 are arbitrarily recovered until SCN5)
```

- Incomplete recovery until specified time

It searches for the time which will complete the incomplete recovery, then executes the recovery until the specified time.

The following is an example of executing the incomplete recovery until '2017-05-18 16:10:10.000000'.

```
gSQL> ALTER DATABASE RECOVER UNTIL TIME '2017-05-18 16:10:10.000000';
Database altered;
```

- Interactive incomplete recovery

If the log file is corrupted, it executes the recovery until just before the corrupted log file. For that, GOLDILOCKS suggests an operator the required log files, and the operator executes the incomplete recovery by using the GOLDILOCKS' recommended log file or a new log file.

The following is an example of executing the interactive incomplete recovery of GOLDILOCKS. GOLDILOCKS suggests log files required for the recovery when executing BEGIN for the incomplete recovery. The operator executes the incomplete recovery by using the GOLDILOCKS' recommended log file, or may descri

be the log file for the recovery.

```
gSQL> ALTER DATABASE BEGIN INCOMPLETE RECOVERY;
ERR-01000(14104): Warning: suggestion '/goldilocks/archive_log/archive_0.log'
ERR-01000(14103): Warning: media recovery needs a logfile including log (Lsn 139992)
Database altered.
gSQL> ALTER DATABASE RECOVER AUTOMATICALLY;
ERR-01000(14104): Warning: suggestion '/goldilocks/archive_log/archive_1.log'
ERR-01000(14103): Warning: media recovery needs a logfile including log (Lsn 144143)
Database altered.
gSQL> ALTER DATABASE END INCOMPLETE RECOVERY;
Database altered.
```

Restarting Database after Incomplete Recovery

After the incomplete recovery is completed, a user can not restart database in a normal way. It is because the recovered GOLDILOCKS database by the incomplete recovery has nothing to do with the current redo log files. A user should reset the redo log file to restart database because database is at the previous point, and the current redo log file is about the log after then. Use *RESETLOGS* option when restarting GOLDILOCKS database after the incomplete recovery.

```
gSQL> ALTER SYSTEM OPEN DATABASE;
ERR-HY000(14083): must use RESETLOGS option for database open
gSQL> ALTER SYSTEM OPEN DATABASE RESETLOGS;
System altered.
```

Cautions for Incomplete Recovery

Incomplete recovery is executed until the specific point to create consistent database, but it is not easy to find the specific point. All redo log files are reset after the incomplete recovery. Therefore, all the control files, data files, redo log files in database should be backed up offline before the incomplete recovery. Then the incomplete recovery should be executed several times to find the correct point.

Archive log files are needed during the incomplete recovery. However, the newly recovered database is different from the previous database, so drop the archive redo log file created by the previous database.

Recovery Examples

Corrupted Control File

GOLDILOCKS database control files store the important information about the physical structure of database and the database consistency. If it is corrupted or dropped by mistake, the database can not be operated.

GOLDILOCKS database multiplexes at least 2 up to 8 control files. If there is at least one valid control file, the remaining control files are restored, then the database can be restarted.

When a valid multiplexed control file exists

If the multiplexed control file `'/goldilocks_data/wal/control_1.ctl'` is corrupted, restarting database fails as follows.

```
gSQL> \STARTUP
ERR-HY000(14097): control file is corrupted - '/goldilocks_data/wal/control_1.ctl'
```

Copy the valid control file `'/goldilocks_data/wal/control_0.ctl'` to `'/goldilocks_data/wal/control_1.ctl'`, and drop the shared memory which failed to restart. Then restart the database.

```
$ cp /goldilocks_data/wal/control_0.ctl /goldilocks_data/wal/control_1.ctl
gSQL> \SHUTDOWN
Shutdown success
gSQL> \STARTUP
Startup success
```

When all multiplexed control files are corrupted

If all multiplexed control files are corrupted, a user can restart the database using backup control files after incomplete recovery. The database's physical structure can be changed after backing up control files. Therefore, the incomplete recovery should be executed when restoring control files using backup control files. Archive log files and redo log files still exist even after incomplete recovery. Therefore, an administrator executes GOLDILOCKS interactive incomplete recovery to manually restore until 'CURRENT' state redo log file.

The backup control file can be copied to multiplexed control files by operating system's file copy feature, or they can be restored by GOLDILOCKS database's recovery feature as follows. The control file recovery can be executed only in NOMOUNT phase of GOLDILOCKS multilevel startup.

```
gSQL> \STARTUP NOMOUNT
Startup success
gSQL> ALTER DATABASE RESTORE CONTROLFILE FROM '/goldilocks_data/backup/backup.ctl';
Database altered.
```

After restoring the backup control files, execute the incomplete recovery in MOUNT phase as follows.

```
gSQL> ALTER SYSTEM MOUNT DATABASE;
System altered.
gSQL> ALTER DATABASE BEGIN INCOMPLETE RECOVERY;
ERR-01000(14104): Warning: suggestion '/goldilocks/archive_log/archive_0.log'
```

```

ERR-01000(14103): Warning: media recovery needs a logfile including log (Lsn 137499)
Database altered.
gSQL> ALTER DATABASE RECOVER AUTOMATICALLY;
ERR-01000(14104): Warning: suggestion '/goldilocks/archive_log/archive_1.log'
ERR-01000(14103): Warning: media recovery needs a logfile including log (Lsn 137667)
Database altered.
gSQL> ALTER DATABASE RECOVER '/goldilocks/wal/redo_1_0.log';
ERR-01000(14104): Warning: suggestion '/goldilocks/archive_log/archive_2.log'
ERR-01000(14103): Warning: media recovery needs a logfile including log (Lsn 137672)
Database altered.
gSQL> ALTER DATABASE END INCOMPLETE RECOVERY;
Database altered.
gSQL> ALTER SYSTEM OPEN DATABASE RESETLOGS;
System altered.

```

Corrupted Data File

If a data file is corrupted or dropped, the complete recovery is executed by using the backup data files. The full backup restores the data files by copying the backup files, and the incremental backup restores the data files by using the GOLDILOCKS' restoring syntax.

The restoration and recovery of data files are executed in database unit or in tablespace unit. It can also be executed in the tablespace unit of the corresponding data file. The recovery in tablespace unit can be executed in MOUNT phase or OPEN phase. The tablespace should be in OFFLINE state to restore and recover data files on OPEN phase.

- Recovering the corrupted data files using full backup in MOUNT phase

Execute the complete recovery after copying the backup data file */goldilocks/backup/test.dbf* to */goldilocks/db/test.dbf*.

```

$ cp /goldilocks/backup/test.dbf /goldilocks/db/test.dbf
gSQL> \STARTUP MOUNT
System altered.
gSQL> ALTER DATABASE RECOVER;
Database altered.
gSQL> ALTER SYSTEM OPEN DATABASE;
System altered.

```

- Recovering the corrupted data files using full backup in OPEN phase

```

gSQL> SELECT IS_ONLINE FROM V$TABLESPACE WHERE TBS_NAME = 'TEST_TBS';
IS_ONLINE

```

```

-----
FALSE
1 row selected.
$ cp /goldilocks/backup/test.dbf /goldilocks/db/test.dbf
gSQL> ALTER DATABASE RECOVER TABLESPACE TEST_TBS;
Database altered.
gSQL> ALTER TABLESPACE TEST_TBS ONLINE;
Tablespace altered.

```

- Recovering the corrupted data files using incremental backup in MOUNT phase

```

gSQL> \STARTUP MOUNT
System altered.
gSQL> ALTER DATABASE RESTORE;
Database altered.
gSQL> ALTER SYSTEM OPEN DATABASE;
System altered.

```

- Recovering the corrupted data files using incremental backup in OPEN phase

```

gSQL> SELECT IS_ONLINE FROM V$TABLESPACE WHERE TBS_NAME = 'TEST_TBS';
IS_ONLINE
-----
FALSE
1 row selected.
gSQL> ALTER DATABASE RESTORE TABLESPACE TEST_TBS;
Database altered.
gSQL> ALTER TABLESPACE TEST_TBS ONLINE;
Tablespace altered.

```

User's Mistake (Table Dropping or Wrong Insert/drop/update)

GOLDILOCKS database supports DDL rollback of table and index if the table *TEST* is dropped by mistake. Namely, a user can rollback to cancel the table dropping instead of committing as follows even if a user dropped the table.

```

gSQL> DROP TABLE TEST;
Table dropped.
gSQL> ROLLBACK;
Rollback complete.
gSQL> \DESC TEST
COLUMN_NAME TYPE          IS_NULLABLE

```

```

-----
I1          NUMBER(10,0)  TRUE
I2          CHARACTER(10) TRUE
gSQL> DROP TABLE TEST;
Table dropped.
gSQL> COMMIT;
Commit complete.
gSQL> \DESC TEST
ERR-42000(16040): table or view does not exist :
SELECT *    FROM TEST  WHERE 1 = 0
          *
ERROR at line 1:

```

If table dropping is committed it can not be rolled back. Therefore, execute GOLDBLOCKS incomplete recovery to recover until the specific point of the database using backup. Then, the data is recovered until the time before the table dropping. Restart the database after that.

The backup file at the point before the table dropping is used to restore the table in incomplete media recovery. The correct point can be found, as described above, by repeating the recovery several times to find the time of table dropped. At that time, the `gdump` tool is used to dump the log file and analyze it.

Assuming LSN is 1000 at the time after table dropping, the incomplete recovery is executed as follows.

```

gSQL> \STARTUP MOUNT
System altered.
gSQL> ALTER DATABASE RECOVER UNTIL CHANGE 1000;
Database altered.
gSQL> ALTER SYSTEM OPEN DATABASE RESETLOGS;
System altered
gSQL> \DESC TEST
COLUMN_NAME TYPE          IS_NULLABLE
-----
I1          NUMBER(10,0)  TRUE
I2          CHARACTER(10) TRUE

```

Corrupted Log Files (Archive File, Redo Log File)

- Corrupted archive log file during recovery

Assume that the data files are corrupted and a user are executing recovery using the backup data files. Also, assume that the specific archive log file is corrupted during the recovery so that the recovery can not be completed.

For example, there are archive log files such as 'archive_0.log', 'archive_1.log', 'archive_2.log', 'archive_3.log'. An 'archive_3.log' is corrupted, and the recovery can not be executed. In this case, incomplete recovery is executed until 'archive_2.log', and the database is restarted.

```
gSQL> \STARTUP MOUNT
System altered
gSQL> ALTER DATABASE BEGIN INCOMPLETE RECOVERY;
ERR-01000(14104): Warning: suggestion '/goldilocks/archive_log/archive_0.log'
ERR-01000(14103): Warning: media recovery needs a logfile including log (Lsn 139992)
Database altered.
gSQL> ALTER DATABASE RECOVER AUTOMATICALLY;
ERR-01000(14104): Warning: suggestion '/goldilocks/archive_log/archive_3.log'
ERR-01000(14103): Warning: media recovery needs a logfile including log (Lsn 194143)
Database altered.
gSQL> ALTER DATABASE END INCOMPLETE RECOVERY;
Database altered.
gSQL> ALTER SYSTEM OPEN DATABASE RESETLOGS;
System altered
```

- Corrupted redo log file

Assume that a failure occurs when operating database so the CURRENT log group in which logs are flushed is corrupted.

For example, when an abnormal termination occurs in the state of the following log groups, the manual recovery is executed and completes the incomplete recovery. It is because the log group 3, 0 is not archived yet.

Table 7-5 Log group state

Log group	Log group state	Log file sequence no.	Prev last LSN
Log group 0	ACTIVE	8	80000
Log group 1	CURRENT	9	90000
Log group 2	INACTIVE	6	60000
Log group 3	ACTIVE	7	70000

```
gSQL> \STARTUP MOUNT
System altered
gSQL> ALTER DATABASE BEGIN INCOMPLETE RECOVERY;
ERR-01000(14104): Warning: suggestion '/goldilocks/archive_log/archive_0.log'
ERR-01000(14103): Warning: media recovery needs a logfile including log (Lsn 1000)
Database altered.
gSQL> ALTER DATABASE RECOVER AUTOMATICALLY;
```

```

ERR-01000(14104): Warning: suggestion '/goldilocks/archive_log/archive_7.log'
ERR-01000(14103): Warning: media recovery needs a logfile including log (Lsn 70001)
Database altered.
gSQL> ALTER DATABASE RECOVER '/goldilocks/wal/redo_3_0.log';
ERR-01000(14104): Warning: suggestion '/goldilocks/archive_log/archive_8.log'
ERR-01000(14103): Warning: media recovery needs a logfile including log (Lsn 80001)
Database altered.
gSQL> ALTER DATABASE RECOVER '/goldilocks/wal/redo_0_0.log';
ERR-01000(14104): Warning: suggestion '/goldilocks/archive_log/archive_9.log'
ERR-01000(14103): Warning: media recovery needs a logfile including log (Lsn 90001)
Database altered.
gSQL> ALTER DATABASE END INCOMPLETE RECOVERY;
Database altered.
gSQL> ALTER SYSTEM OPEN DATABASE RESETLOGS;
System altered

```

More Recent Datafile Than Log

All tablespaces created in GOLDDLOCKS database consists of pages, and each page set the log LSN which was recorded by a transaction having updated that page last is set as the page LSN. Therefore, all page LSNs in the datafile have the same or smaller value than the LSN of the latest log recorded in the redo log file of the log group.

When restarting the database, if a specific page's LSN of the data file has a bigger value than the latest log's LSN, then it corrupts the database consistency and the normal service is not available. GOLDDLOCKS database checks the data file and log when restarting so that this abnormal situation does not happen.

If any page whose LSN has bigger value than the latest log's LSN is in the data file, then restarting the database fails as follows.

```

gSQL> \STARTUP
ERR-HY000(14114): exist inconsistent datafiles; need to restore more older backup datafiles or
more recent redo logfiles

```

To solve this problem, restore the backup data file consisting of LSNs smaller than the latest log LSN. Or, restart the database after restoring the log file on which the LSN log bigger than the data file is recorded. Check the trace file to find the data file to restore.

For example, if the following messages are output on the trace file when restarting fails, then the page whose LSN is '126787' in '/data/db/system_dic.dbf' data file, and this value is bigger than the latest log LSN of the log file '126652'. Therefore, for the restart, restore the previous backup data file, or restore the log file on which the log LSN same or bigger than '126787' is recorded. Also, if several pages of the data file has a LSN value bigger than the log file LSN, then restore the log file bigger than the maximum value a

mong them to restart and provide the service.

```
[2016-01-15 12:41:14.045679 THREAD(10581,139799401453312)] [INFORMATION]
[STARTUP_SM] the max page lsn '126787' of datafile '/data/db/system_dict.dbf' is more recent
than the latest redo log lsn '126652'.
[2016-01-15 12:41:14.045705 THREAD(10581,139799401453312)] [INFORMATION]
[STARTUP_SM] the max page lsn '126830' of datafile '/data/db/system_undo.dbf' is more recent
than the latest redo log lsn '126652'.
[2016-01-15 12:41:14.045729 THREAD(10581,139799401453312)] [INFORMATION]
[STARTUP_SM] the max page lsn '126829' of datafile '/data/db/test_log.dbf' is more recent than
the latest redo log lsn '126652'.
```

in doubt Transaction Recovery in Cluster Environment

The transactions in the cluster environment are divided into global transaction, domain transaction and local transaction. The global transaction is performed in two or more cluster groups, the domain transaction is performed in a single cluster group and the local transaction is performed in a single cluster member.

The local transaction uses only the local member's log when performing the recovery. The domain transaction uses the local member's log when performing the recovery, and performs the rollback when an abnormal termination occurs without completing the transaction, and performs the synchronization with a group member through the rebalance if needed.

The global transaction uses 2 phase commit protocol to commit. 2 phase commit is performed as follows for GOLDILOCKS global transaction.

- PREPARE phase
 - It transfers PREPARE messages from the driver member to all members, and waits for the responded message.
 - It moves on to COMMIT phase when it receives the respond message of PREPARE from all members, or it rolls back when at least one member fails or does not respond.
- COMMIT phase
 - It transfers COMMIT messages from the driver member to all members, and waits for the responded message.
 - It commits even when a member fails.

If a member is abnormally terminated without recording the commit log on COMMIT phase, it should obtain the state information from other members when restarting. It is because it is unable to know if the global transaction in 'PREPARE' state was committed or rolled back, when restarting.

For that, GOLDILOCKS records the committed global transaction information in transaction record form in MEM_TRANS_TBS. Also, when recording a new record in that record, the previous record is recorded in commit.log if needed. Later, the abnormally terminated member performs the restart recovery or the ma

nual recovery by using the log. It performs the recovery by obtaining the transaction COMMIT/ROLLBACK information from members in service when *in doubt* transaction in 'PREPARE' state is remained.

8.

GOLDILOCKS Database Replication

8.1 Overview

This chapter describes CYCLONE and LOGMIRROR.

GOLDBLOCKS supports two types of replication, and they are CYCLONE and LOGMIRROR. CYCLONE replicates transactions using CDC, and LOGMIRROR replicates redo log files in the source database.

Table 8-1 Replication tool

Tool	Replication target	Description
CYCLONE	Transaction	It uses CDC method, and replicates the transaction reflected in master, then reflect it to slave.
LOGMIRROR	Redo log file	It identically replicates redo file in master database to slave.

- CYCLONE
 - It uses Change Data Capture (CDC) method to analyze and treat redo log files of the source database, then applies them to a remote database.
 - It supports only asynchronous (async) method because it analyzes contents stored in database's redo log file.
- LOGMIRROR
 - It replicates redo log files stored in the source database to a remote database.
 - It is used to avoid the data loss of CYCLONE which is executed in async method.

8.2 Operating Method

CYCLONE

For more information about general operating method and option, refer to **CYCLONE**.

Adding and Deleting Nodes

CYCLONE is performed in a group unit, and it is as same as the replication nodes. Add a group when adding nodes, drop a group when deleting nodes.

Examples of Adding Nodes

- Record the group 2 to be added in master configuration file.
 - Set a unique port per each group.
 - The default master configuration file is `$GOLDILOCKS_DATA/conf/cyclone.master.conf`.
 - The following is an example of group 1 node in operation.

```
...
...
GROUP_NAME = Group1
{
    PORT = 21102
    CAPTURE_TABLE =
    (
        testTable1,
        testTable2
    )
}
```

- The following is an example of group 2 node to be added.

```
GROUP_NAME = Group2
{
    PORT = 21103
    CAPTURE_TABLE =
    (
        testTable5,
```

```

        testTable6
    )
}

```

- Record the group 2 to be added in slave configuration file.
 - The port of group 2 should be as same as the port added to the existing master.
 - The default slave configuration file is \$GOLDBLOCKS_DATA/conf/cyclone.slave.conf.
 - The following is an example of group 1 node in operation.

```

...
...
GROUP_NAME = Group1
{
    PORT = 21102
    APPLY_TABLE =
    (
        testTable1 To testTable3,
        testTable2 To testTable4
    )
}

```

- The following is an example of group 2 node to be added.

```

GROUP_NAME = Group2
{
    PORT = 21103
    APPLY_TABLE =
    (
        testTable5 To testTable7,
        testTable6 To testTable8
    )
}

```

- Execute and check the added group 2 node in the master device as follows.

```

prompt> cyclone --master --start --group Group2
[GROUP2] Startup done as Master.
prompt> cyclone --master --status
=====
|          CYCLONE STATUS - MASTER          |
=====

```



```
GROUP1 Running...
GROUP2 Running...
-----
```

- Execute and check the added group 2 node in the slave device as follows.

```
prompt> cyclone --slave --start --group Group2
[GROUP2] Startup done as Slave.
prompt> cyclone --slave --status
=====
                CYCLONE STATUS - SLAVE
=====
GROUP1 Running...
GROUP2 Running...
-----
```

Examples of Deleting Nodes

- Terminate the group 2 node to be deleted in the slave device as follows.

```
prompt> cyclone --slave --stop --group Group2
stop done.
prompt> cyclone --slave --status
=====
                CYCLONE STATUS - SLAVE
=====
GROUP1 Running...
-----
```

- Terminate the group 2 node to be deleted in the master device as follows.

```
prompt> cyclone --master --stop --group Group2
stop done.
prompt> cyclone --master --status
=====
                CYCLONE STATUS - MASTER
=====
GROUP1 Running...
-----
```

- Drop the group 2 node to be deleted from the master configuration file.
 - The default master configuration file is \$GOLDILOCKS_DATA/conf/cyclone.master.conf.

- The following is an example of group 1 node in operation.

```
...
...
GROUP_NAME = Group1
{
    PORT = 21102
    CAPTURE_TABLE =
    (
        testTable1,
        testTable2
    )
}
```

- The following is an example of deleting group 2 node.

```
GROUP_NAME = Group2
{
    PORT = 21103
    CAPTURE_TABLE =
    (
        testTable5,
        testTable6
    )
}
```

- Drop the group 2 node to be deleted from the slave configuration file as follows.
 - The default slave configuration file is `$GOLDBLOCKS_DATA/conf/cyclone.slave.conf`.
 - The following is an example of group 1 node in operation.

```
...
...
GROUP_NAME = Group1
{
    PORT = 21102
    APPLY_TABLE =
    (
        testTable1 To testTable3,
        testTable2 To testTable4
    )
}
```

- The following is an example of deleting group 2 node.

```
GROUP_NAME = Group2
{
  PORT = 21103
  APPLY_TABLE =
  (
    testTable5 To testTable7,
    testTable6 To testTable8
  )
}
```

Initializing Replication

Initializing replication is executed when existing replication nodes or a group's table gives up execution due to DDL operation. A specific node or entire node can be initialized.

The initializing replication is performed by restarting replication being operated in slave using `--reset` option.

On the other hand, master does not require any operation.

Examples of Initializing Replication on a Specific Node

- Terminate the group 2 node to be initialized in the slave device as follows.

```
prompt> cyclone --slave --stop --group Group2
stop done.
prompt> cyclone --slave --status
=====
                CYCLONE STATUS - SLAVE
=====
GROUP1 Running...
-----
```

- Restart group 2 node in slave device using `--reset` option.
 - Master device does not require any operation.
 - Replication restarts from the current point.

```
prompt> cyclone --slave --start --reset --group Group2
[GROUP2] Startup done as Slave.
prompt> cyclone --slave --status
=====
```

```
CYCLONE STATUS - SLAVE
```

```
=====
```

```
GROUP1 Running...
```

```
GROUP2 Running...
```

```
-----
```

Examples of Initializing Replication of All Nodes

- Terminate all CYCLONE in operation in the slave device as follows.

```
prompt> cyclone --stop --slave
```

- Restart CYCLONE in slave device using --reset option.
 - Master device does not require any operation.
 - Replication starts from the current point.

```
prompt> cyclone --slave --start --reset
```

```
[GROUP1] Startup done as Slave.
```

```
[GROUP2] Startup done as Slave.
```

```
prompt> cyclone --slave --status
```

```
=====
```

```
CYCLONE STATUS - SLAVE
```

```
=====
```

```
GROUP1 Running...
```

```
GROUP2 Running...
```

```
-----
```

LOGMIRROR

For more information about general operation method and options, refer to **LOGMIRROR**.

Retrieving LOGMIRROR State

GOLDBLOCKS includes the response waiting procedure of LOGMIRROR when GOLDBLOCKS interworks with LOGMIRROR. If LOGMIRROR is waiting for response, GOLDBLOCKS is also waiting in a blocked state. This state can be retrieved in v\$system_stat.

```
gSQL> SELECT * FROM V$SYSTEM_STAT WHERE STAT_NAME='LOG_MIRROR_SYNC_STATE';
```

```
STAT_NAME          STAT_VALUE COMMENTS
```

```
-----
```

```
LOG_MIRROR_SYNC_STATE      0 logmirror sync state( 0 : sync, 1 : blocked )
1 row selected.
```

If STAT_VALUE is 0, it is not a standby state but an ordinary state. If STAT_VALUE is 1, it is a blocked state waiting for a response. To restart GOLDILOCKS service while LOGMIRROR is waiting for a response, LOG MIRROR service can be stopped by modifying LOG_MIRROR_TIMEOUT as follows.

```
gSQL> ALTER SYSTEM SET LOG_MIRROR_TIMEOUT = 20;
System altered.
```

Initializing Replication

Initializing replication of LOGMIRROR should be done manually. This is to prevent data dropping or the unrecoverable situation driven by the user's incorrect option usage.



Control files and redo log files are stored in LOGMIRROR slave. The required information for the operation is stored and updated in the control files.

Examples of Initializing Replication

- Terminate LOGMIRROR in operation in the slave device as follows.

```
prompt> logmirror --slave --stop
stop done.
```

- Terminate LOGMIRROR in operation in the master device as follows.

```
prompt> logmirror --master --stop
stop done.
```

- Drop the replicated control files and redo log files from the slave device.
 - For more information about the path, refer to 'LOG_PATH' option described in the slave configuration file.
 - The default LOGMIRROR slave configuration file is \$GOLDILOCKS_DATA/conf/logmirror.slave.conf.

8.3 Trace Log

The followings are detailed information about the trace log.

Table 8-2 Trace log

Name	Category	File name
CYCLONE	Master	cyclone_master_GROUP_NAME.trc
	Slave	cyclone_slave_GROUP_NAME.trc
LOGMIRROR	Master	LogMirror_master.trc
	Slave	LogMirror_slave.trc

Troubleshooting of CYCLONE

The followings are error messages and troubleshooting of CYCLONE.

Table 8-3 Troubleshooting of CYCLONE

Error message	Solution
Service is not available	Ensure that GOLDDILOCKS is normally running.
table does not exist	Check the table name described in the configuration file.
schema does not exist	Check the schema name described in the configuration file.
previously added. Maybe duplicated	Check if a table is duplicated in the configuration file.
table must have a primary key	Ensure that a table in the configuration file has the primary key.
internal error occurred.	Check the error details.
table must set supplemental log	Ensure that supplemental logging is executed in GOLDDILOCKS.
group XXX is already running	Check if the corresponding group is already running.
GOLDDILOCKS_DATA system environment is invalid	Ensure that GOLDDILOCKS_DATA environment variable is set.
log file reused or invalid. restart cyclone with '--reset' option	This error occurs when the redo log file is reused or archived redo log file does not exist. In this case, initialize CYCLONE and restart it.
fail to analyze flow	This error occurs when analyzing an abnormal redo log file. Ensure that the release version between master and slave are same.
Communication link failure	Check the network state. Restart CYCLONE.
Master disconnect abnormally	Check the network state. Restart CYCLONE.
Protocol error occurred	Check the error details.
Already slave connected	Check if the slave is already running.
Invalid group name	Check the specified group name at the startup/termination. The group name should be same as described in the configuration file.

Error message	Solution
Invalid capture information	This error occurs when the existing operating information is abnormal. In this case, initialize CYCLONE and restart it.
Redo log file read timeout	Ensure that the archived redo log files normally exist.
Invalid archive log file	The archived redo log file is not normal. In this case, initialize CYCLONE and restart it.
Fail to write file	Check the available space in the disk, and restart CYCLONE.
Invalid Meta File	This error occurs when the meta files which are managed by CYCLONE are corrupted. In this case, initialize CYCLONE and restart it.
Redo log file does not exist	Ensure that GOLDILOCKS which is operated as master is normally running.
[APPLIER-INSERT] XXX	INSERT is failed due to XXX.
[APPLIER-DELETE] XXX	DELETE is failed due to XXX.
[APPLIER-UPDATE] XXX	UPDATE is failed due to XXX.

Troubleshooting of LOGMIRROR

The followings are error messages and troubleshooting of LOGMIRROR.

Table 8-4 Troubleshooting of LOGMIRROR

Error message	Solution
Service is not available	Ensure that GOLDILOCKS is normally running.
Invalid Protocol value	Check the error details.
file does not exist	Ensure that the corresponding file normally exists.
invalid Control file	The control file is corrupted. Initialize and restart LOGMIRROR.
Communication link failure	Check the network state. Restart LOGMIRROR.
GOLDILOCKS_DATA system environment is invalid	Ensure that GOLDILOCKS_DATA environment variable is set.
There is no Shared Memory Area for LogMirror	Ensure that LOG_MIRROR_MODE property is normally set to 'enabled' in properties of GOLDILOCKS which is operated as master.
Master disconnect abnormally	Check the network state. Restart LOGMIRROR.
Invalid Log File	Ensure that the corresponding file normally exists.
Connection Information does not exist	Ensure that GOLDILOCKS connecting information in configuration files is normal.
Archive Log File does not exist	Ensure that ARCHIVELOG_MODE in GOLDILOCKS which is operated as master is normally set.

9.

Database Information

9.1 DICTIONARY_SCHEMA

DICTIONARY_SCHEMA contains views or tables to get SQL objects and their information in the system.



Views and tables of DICTIONARY_SCHEMA can be retrieved only in open phase.

Execute *DictionarySchema.sql* as follows to use the views.

- For standalone

```
% gsql sys gliese --as sysdba --import $GOLDILOCKS_HOME/admin/standalone/DictionarySchema.sql
```

- For cluster

```
% gsql sys gliese --as sysdba --import $GOLDILOCKS_HOME/admin/cluster/DictionarySchema.sql
```

Information is retrieved as follows according to the names of views or tables.

- ALL-family view
 - The view name begins with ALL_
 - Information about accessible objects by a current user
- DBA-family view
 - The view name begins with DBA_
 - Information about all objects whose current user has DBA privileges (ACCESS CONTROL ON DATABASE).
- USER-family view
 - The view name begins with USER_
 - Information about objects which are owned by the current user

Views of ALL_family

It retrieves information about objects accessible by a current user.

ALL_ALL_TABLES

ALL_ALL_TABLES describes the object tables and relational tables accessible to the current user.

Table 9-1 Column information

Column name	Data type	Description
OWNER	VARCHAR(128)	Owner of the table
TABLE_SCHEMA	VARCHAR(128)	Schema of the table
TABLE_NAME	VARCHAR(128)	Name of the table
TABLESPACE_NAME	VARCHAR(128)	Name of the tablespace containing the table
CLUSTER_NAME	VARCHAR(128)	<ul style="list-style-type: none"> reserved Name of the cluster
IOT_NAME	VARCHAR(128)	<ul style="list-style-type: none"> reserved Name of the index-organized table
STATUS	VARCHAR(32)	If a previous DROP TABLE operation failed, indicates whether the table is unusable (UNUSABLE) or valid (VALID)
PCT_FREE	NUMBER	Minimum percentage of free space in a block
PCT_USED	NUMBER	Minimum percentage of used space in a block
INI_TRANS	NUMBER	Initial number of transactions
MAX_TRANS	NUMBER	Maximum number of transactions
INITIAL_EXTENT	NUMBER	Size of the initial extent (in bytes)
NEXT_EXTENT	NUMBER	Size of secondary extents (in bytes)
MIN_EXTENTS	NUMBER	Minimum number of extents allowed in the segment
MAX_EXTENTS	NUMBER	Maximum number of extents allowed in the segment
PCT_INCREASE	NUMBER	<ul style="list-style-type: none"> reserved Percentage increase in extent size
FREELISTS	NUMBER	<ul style="list-style-type: none"> reserved Number of process freelists allocated to the segment
FREELIST_GROUPS	NUMBER	<ul style="list-style-type: none"> reserved Number of freelist groups allocated to the segment
LOGGING	VARCHAR(3)	Indicates whether or not changes to the table are logged
BACKED_UP	VARCHAR(1)	<ul style="list-style-type: none"> reserved Indicates whether the table has been backed up since the last modification (Y) or not (N)
NUM_ROWS	NUMBER	Number of rows in the table

Column name	Data type	Description
BLOCKS	NUMBER	Number of used blocks in the table
EMPTY_BLOCKS	NUMBER	<ul style="list-style-type: none"> reserved Number of empty (never used) blocks in the table
AVG_SPACE	NUMBER	<ul style="list-style-type: none"> reserved Average available free space in the table
CHAIN_CNT	NUMBER	<ul style="list-style-type: none"> reserved Number of rows in the table that are chained from one data block to another or that have migrated to a new block, requiring a link to preserve the old rowid
AVG_ROW_LEN	NUMBER	<ul style="list-style-type: none"> reserved Average row length, including row overhead
AVG_SPACE_FREELIST_BLOCKS	NUMBER	<ul style="list-style-type: none"> reserved Average freespace of all blocks on a freelist
NUM_FREELIST_BLOCKS	NUMBER	<ul style="list-style-type: none"> reserved Number of blocks on the freelist
DEGREE	VARCHAR(32)	<ul style="list-style-type: none"> reserved Number of threads per instance for scanning the table, or DEFAULT
INSTANCES	VARCHAR(32)	<ul style="list-style-type: none"> reserved Number of instances across which the table is to be scanned, or DEFAULT
CACHE	VARCHAR(1)	<ul style="list-style-type: none"> reserved Indicates whether the table is to be cached in the buffer cache (Y) or not (N)
TABLE_LOCK	VARCHAR(32)	Indicates whether table locking is enabled (ENABLED) or disabled (DISABLED)
SAMPLE_SIZE	NUMBER	Sample size used in analyzing the table
LAST_ANALYZED	TIMESTAMP(6) WITHOUT TIME ZONE	Date on which the table was most recently analyzed
PARTITIONED	VARCHAR(3)	<ul style="list-style-type: none"> reserved Indicates whether the table is partitioned (YES) or not (NO)
IOT_TYPE	VARCHAR(32)	<ul style="list-style-type: none"> reserved If the table is an index-organized table, then IOT_TYPE is IOT, IOT_OVERFLOW, or IOT_MAPPING.
OBJECT_ID_TYPE	VARCHAR(32)	<ul style="list-style-type: none"> reserved Indicates whether the object ID (OID) is USER-DEFINED or SYSTEM GENERATED
TABLE_TYPE_OWNER	VARCHAR(128)	<ul style="list-style-type: none"> reserved If an object table, owner of the type from which the table is created
TABLE_TYPE	VARCHAR(128)	<ul style="list-style-type: none"> reserved If an object table, type of the table
		<ul style="list-style-type: none"> reserved

Column name	Data type	Description
TEMPORARY	VARCHAR(1)	Indicates whether the table is temporary (Y) or not (N)
SECONDARY	VARCHAR(1)	<ul style="list-style-type: none"> reserved Indicates whether the table is a secondary object created by cartridge
NESTED	VARCHAR(3)	<ul style="list-style-type: none"> reserved Indicates whether the table is a nested table (YES) or not (NO)
BUFFER_POOL	VARCHAR(32)	<ul style="list-style-type: none"> reserved Buffer pool to be used for table blocks
FLASH_CACHE	VARCHAR(32)	<ul style="list-style-type: none"> reserved Database Smart Flash Cache hint to be used for table blocks
CELL_FLASH_CACHE	VARCHAR(32)	Cell flash cache hint to be used for table blocks
ROW_MOVEMENT	VARCHAR(32)	<ul style="list-style-type: none"> reserved If a partitioned table, indicates whether row movement is enabled (ENABLED) or disabled (DISABLED)
GLOBAL_STATS	VARCHAR(3)	<ul style="list-style-type: none"> reserved For partitioned tables, indicates whether statistics for the table as a whole (global statistics) are accurate (YES)
USER_STATS	VARCHAR(3)	<ul style="list-style-type: none"> reserved Indicates whether statistics were entered directly by the user (YES) or not (NO)
DURATION	VARCHAR(32)	<ul style="list-style-type: none"> reserved Indicates the duration of a temporary table
SKIP_CORRUPT	VARCHAR(32)	<ul style="list-style-type: none"> reserved Indicates whether Database ignores blocks marked corrupt during table and index scans (ENABLED) or raises an error (DISABLED)
MONITORING	VARCHAR(3)	<ul style="list-style-type: none"> reserved Indicates whether the table has the MONITORING attribute set (YES) or not (NO)
CLUSTER_OWNER	VARCHAR(128)	<ul style="list-style-type: none"> reserved Owner of the cluster, if any
DEPENDENCIES	VARCHAR(32)	<ul style="list-style-type: none"> reserved Indicates whether row-level dependency tracking is enabled (ENABLED) or disabled (DISABLED)
COMPRESSION	VARCHAR(32)	<ul style="list-style-type: none"> reserved Indicates whether table compression is enabled (ENABLED) or not (DISABLED)
COMPRESS_FOR	VARCHAR(32)	<ul style="list-style-type: none"> reserved Default compression for what kind of operations
DROPPED	VARCHAR(3)	<ul style="list-style-type: none"> reserved Indicates whether the table has been dropped and is in the recycle bin (YES) or not (NO)

Column name	Data type	Description
READ_ONLY	VARCHAR(3)	Indicates whether the table IS READ-ONLY (YES) or not (NO)
SEGMENT_CREATED	VARCHAR(3)	Indicates whether the table segment has been created (YES) or not (NO)

ALL_ARGUMENTS

ALL_ARGUMENTS lists all arguments of functions, procedures.

Table 9-2 Column information

Column name	Data type	Description
OWNER	VARCHAR(128)	Owner of function, procedures or package
SCHEMA_NAME	VARCHAR(128)	Schema Name of function, procedures or package
OBJECT_NAME	VARCHAR(128)	Name of function, procedures
PACKAGE_NAME	VARCHAR(128)	Package Name of function, procedures
OBJECT_ID	NUMBER	ID of a function, procedures
SUBPROGRAM_ID	NUMBER	ID of procedures in package
ARGUMENT_NAME	VARCHAR(128)	Name of argument or attribute name of record type argument
POSITION	NUMBER	Position of argument or position of attribute in record type
SEQUENCE	NUMBER	Sequential order of argument and its attributes
DATA_LEVEL	NUMBER	Nesting depth of the argument for composite types
DATA_TYPE	VARCHAR(128)	Data type of the argument
DEFAULTED	VARCHAR(1)	Whether or not the argument is defaulted
DEFAULT_VALUE	VARCHAR(1)	Reserved for future use
DEFAULT_LENGTH	VARCHAR(1)	Reserved for future use
IN_OUT	VARCHAR(32)	Direction of the argument (IN, OUT, IN/OUT)
DATA_LENGTH	NUMBER	Length of the column(in bytes)
DATA_PRECISION	NUMBER	Length in decimal digits(NUMBER) or binary digits(FLOAT)
DATA_SCALE	NUMBER	Digits to the right of the decimal point in a number
RADIX	NUMBER	Argument radix for a number
CHARACTER_SET_NAME	VARCHAR(128)	Character set name for the argument
TYPE_OWNER	VARCHAR(128)	Owner of the type of the argument
TYPE_NAME	VARCHAR(128)	Name of the type of the argument
TYPE_SUBNAME	VARCHAR(128)	Name of the type of the argument declared in package
TYPE_LINK	VARCHAR(128)	Name of the type of the argument declared in a remote package
PLS_TYPE	VARCHAR(128)	Name of the type of the argument at PSM
CHAR_LENGTH	NUMBER	Character limit for string datatypes
CHAR_USED	VARCHAR(1)	Whether the byte limit(B) or char limit(C) is official for the string
ORIGIN_CON_ID	VARCHAR(256)	ID of the container where the data originates

ALL_CATALOG

ALL_CATALOG displays the tables, views, synonyms, and sequences accessible to the current user.

Table 9-3 Column information

Column name	Data type	Description
OWNER	VARCHAR(128)	Owner of the TABLE, VIEW, SYNONYM, SEQUENCE, or UNDEFINED
TABLE_SCHEMA	VARCHAR(128)	Schema of the TABLE, VIEW, SYNONYM, SEQUENCE, or UNDEFINED
TABLE_NAME	VARCHAR(128)	Name of the TABLE, VIEW, SYNONYM, SEQUENCE, or UNDEFINED
TABLE_TYPE	VARCHAR(32)	Type of the TABLE, VIEW, SYNONYM, SEQUENCE, or UNDEFINED

ALL_CLUSTER_TABLES

ALL_CLUSTER_TABLES describes all cluster tables accessible to the current user in the cluster system.



It is available only on a cluster.

Table 9-4 Column information

Column name	Data type	Description
OWNER	VARCHAR(128)	Owner of the table
TABLE_SCHEMA	VARCHAR(128)	Schema of the table
TABLE_NAME	VARCHAR(128)	Name of the table
SHARD_STRATEGY	VARCHAR(32)	Sharding strategy of the table: the value in (CLONED, HASH SHARDING, RANGE SHARDING, LIST S HARDING)
SHARD_PLACEMENT	VARCHAR(32)	Shard placement of the table: the value in (AT CLUSTER WIDE or AT CLUSTER GROUP)
SHARD_COUNT	NUMBER	Shard count of the table (if cloned table, the value is null)
SHARD_KEY_COUNT	NUMBER	Shard key column count of the table (if cloned table, the value is nul l)
HAS_GSI	VARCHAR(3)	Indicate whether the table has global secondary index: (YES) or (NO)
DROPPED	VARCHAR(3)	Indicates whether the table has been dropped and is in the recycle b in (YES) or not (NO)

ALL_COL_COMMENTS

ALL_COL_COMMENTS displays comments on the columns of the tables and views accessible to the current user.

Table 9-5 Column information

Column name	Data type	Description
OWNER	VARCHAR(128)	Owner of the object
TABLE_SCHEMA	VARCHAR(128)	Schema of the object
TABLE_NAME	VARCHAR(128)	Name of the object
COLUMN_NAME	VARCHAR(128)	Name of the column
COMMENTS	VARCHAR(1024)	Comment on the column

ALL_COL_PRIVS

ALL_COL_PRIVS describes the object grants, for which the current user is the object owner, grantor, or grantee, or for which an enabled role or PUBLIC is the grantee.

Table 9-6 Column information

Column name	Data type	Description
GRANTOR	VARCHAR(128)	Name of the user who performed the grant
GRANTEE	VARCHAR(128)	Name of the user or role to whom access was granted
OWNER	VARCHAR(128)	Owner of the object
TABLE_SCHEMA	VARCHAR(128)	Schema of the object
TABLE_NAME	VARCHAR(128)	Name of the object
COLUMN_NAME	VARCHAR(128)	Name of the column
PRIVILEGE	VARCHAR(32)	Privilege on the column
GRANTABLE	VARCHAR(3)	Indicates whether the privilege was granted with the GRANT OPTION (YES) or not (NO)

ALL_COL_PRIVS_MADE

ALL_COL_PRIVS_MADE describes the column object grants for which the current user is the object owner or grantor.

Table 9-7 Column information

Column name	Data type	Description
GRANTEE	VARCHAR(128)	Name of the user or role to whom access was granted
OWNER	VARCHAR(128)	Owner of the object
TABLE_SCHEMA	VARCHAR(128)	Schema of the object
TABLE_NAME	VARCHAR(128)	Name of the object
COLUMN_NAME	VARCHAR(128)	Name of the column
GRANTOR	VARCHAR(128)	Name of the user who performed the grant
PRIVILEGE	VARCHAR(32)	Privilege on the column
GRANTABLE	VARCHAR(3)	Indicates whether the privilege was granted with the GRANT OPTION (YES) or not (NO)

ALL_COL_PRIVS_RECD

ALL_COL_PRIVS_RECD describes the column object grants, for which the current user is the grantee, or for which an enabled role or PUBLIC is the grantee.

Table 9-8 Column information

Column name	Data type	Description
GRANTEE	VARCHAR(128)	Name of the user or role to whom access was granted
OWNER	VARCHAR(128)	Owner of the object
TABLE_SCHEMA	VARCHAR(128)	Schema of the object
TABLE_NAME	VARCHAR(128)	Name of the object
COLUMN_NAME	VARCHAR(128)	Name of the column
GRANTOR	VARCHAR(128)	Name of the user who performed the grant
PRIVILEGE	VARCHAR(32)	Privilege on the column
GRANTABLE	VARCHAR(3)	Indicates whether the privilege was granted with the GRANT OPTION (YES) or not (NO)

ALL_CONSTRAINTS

ALL_CONSTRAINTS describes constraint definitions on tables accessible to the current user.

Table 9-9 Column information

Column name	Data type	Description
OWNER	VARCHAR(128)	Owner of the constraint definition
CONSTRAINT_SCHEMA	VARCHAR(128)	Schema of the constraint definition
CONSTRAINT_NAME	VARCHAR(128)	Name of the constraint definition
CONSTRAINT_TYPE	VARCHAR(1)	Type of the constraint definition: the value in (C: check constraint, P: Primary key, U: Unique Key, R: Referential integrity)
TABLE_OWNER	VARCHAR(128)	Owner of the table (or view) associated with the constraint definition
TABLE_SCHEMA	VARCHAR(128)	Schema of the table (or view) associated with the constraint definition
TABLE_NAME	VARCHAR(128)	Name of the table (or view) associated with the constraint definition
SEARCH_CONDITION	LONG VARCHAR	Text of search condition for a check constraint
R_OWNER	VARCHAR(128)	Owner of the unique constraint definition for the referenced table
R_SCHEMA	VARCHAR(128)	Schema of the unique constraint definition for the referenced table
R_CONSTRAINT_NAME	VARCHAR(128)	Name of the unique constraint definition for the referenced table
DELETE_RULE	VARCHAR(32)	Delete rule for a referential constraint: the value in (NO ACTION, RESTRICT, CASCADE, SET NULL, SET DEFAULT)
UPDATE_RULE	VARCHAR(32)	Update rule for a referential constraint: the value in (NO ACTION, RESTRICT, CASCADE, SET NULL, SET DEFAULT)
STATUS	VARCHAR(32)	Enforcement status of the constraint: the value in (ENABLED, DISABLE)
DEFERRABLE	VARCHAR(32)	Indicates whether the constraint is deferrable (DEFERRABLE) or not (NOT DEFERRABLE)
DEFERRED	VARCHAR(32)	Indicates whether the constraint was initially deferred (DEFERRED) or not (IMMEDIATE)
VALIDATED	VARCHAR(32)	Indicates whether all data may obey the constraint or not: the value in (VALIDATED, NOT VALIDATED)
GENERATED	VARCHAR(32)	Indicates whether the name of the constraint is user-generated (USER NAME) or system-generated (GENERATED NAME)
BAD	VARCHAR(32)	<ul style="list-style-type: none"> reserved Indicates whether this constraint specifies a century in an ambiguous manner (BAD) or not (NULL)
RELY	VARCHAR(32)	<ul style="list-style-type: none"> reserved When NOT VALIDATED, indicates whether the constraint is to be taken into account for query rewrite (RELY) or not (NULL)
LAST_CHANGE	TIMESTAMP(2) WITH TIME ZONE	When the constraint was last enabled or disabled

Column name	Data type	Description
INDEX_OWNER	VARCHAR(128)	Owner of the index associated with the key constraint
INDEX_SCHEMA	VARCHAR(128)	Schema of the index associated with the key constraint
INDEX_NAME	VARCHAR(128)	Name of the index associated with the key constraint
INVALID	VARCHAR(32)	Indicates whether the constraint is invalid (INVALID) or not (NULL)
VIEW_RELATED	VARCHAR(32)	Indicates whether the constraint depends on a view (DEPEND ON VIEW) or not (NULL)
COMMENTS	VARCHAR(1024)	Comments of the constraint definition

ALL_CONS_COLUMNS

ALL_CONS_COLUMNS describes columns that are accessible to the current user and that are specified in constraints.

Table 9-10 Column information

Column name	Data type	Description
OWNER	VARCHAR(128)	Owner of the constraint definition
CONSTRAINT_SCHEMA	VARCHAR(128)	Schema of the constraint definition
CONSTRAINT_NAME	VARCHAR(128)	Name of the constraint definition
TABLE_OWNER	VARCHAR(128)	Owner of the table with the constraint definition
TABLE_SCHEMA	VARCHAR(128)	Schema of the table with the constraint definition
TABLE_NAME	VARCHAR(128)	Name of the table with the constraint definition
COLUMN_NAME	VARCHAR(128)	Name of the column or attribute of the object type column specified in the constraint definition
POSITION	NUMBER	Original position of the column or attribute in the definition of the object

ALL_DB_PRIVS

ALL_DB_PRIVS describes the database grants, for which the current user is the grantor, or grantee, or for which an enabled role or PUBLIC is the grantee.

Table 9-11 Column information

Column name	Data type	Description
GRANTOR	VARCHAR(128)	Name of the user who performed the grant
GRANTEE	VARCHAR(128)	Name of the user or role to whom access was granted
PRIVILEGE	VARCHAR(32)	Privilege on the database
GRANTABLE	VARCHAR(3)	Indicates whether the privilege was granted with the GRANT OPTION (YES) or not (NO)

ALL_DB_PRIVS_MADE

ALL_DB_PRIVS_MADE describes the database grants for which the current user is the grantor.

Table 9-12 Column information

Column name	Data type	Description
GRANTEE	VARCHAR(128)	Name of the user or role to whom access was granted
GRANTOR	VARCHAR(128)	Name of the user who performed the grant
PRIVILEGE	VARCHAR(32)	Privilege on the database
GRANTABLE	VARCHAR(3)	Indicates whether the privilege was granted with the GRANT OPTION (YES) or not (NO)

ALL_DB_PRIVS_RECD

ALL_DB_PRIVS_RECD describes the database grants, for which the current user is the grantee, or for which an enabled role or PUBLIC is the grantee.

Table 9-13 Column information

Column name	Data type	Description
GRANTEE	VARCHAR(128)	Name of the user or role to whom access was granted
GRANTOR	VARCHAR(128)	Name of the user who performed the grant
PRIVILEGE	VARCHAR(32)	Privilege on the database
GRANTABLE	VARCHAR(3)	Indicates whether the privilege was granted with the GRANT OPTION (YES) or not (NO)

ALL_DEPENDENCIES

ALL_DEPENDENCIES describes dependencies between objects accessible to the current user

Table 9-14 Column information

Column name	Data type	Description
OWNER	VARCHAR(128)	Owner of object
SCHEMA_NAME	VARCHAR(128)	Schema Name of object
NAME	VARCHAR(128)	Name of object
TYPE	VARCHAR(32)	Type of object: FUNCTION, PROCEDURE, VIEW, PACKAGE, PACKAGE BODY, TRIGGER
REFERENCED_OWNER	VARCHAR(128)	Owner of the referenced object
REFERENCED_SCHEMA_NAME	VARCHAR(128)	Schema Name of the referenced object
REFERENCED_TYPE	VARCHAR(32)	Type of the referenced object: FUNCTION, PROCEDURE, TABLE, VIEW, SEQUENCE, PACKAGE, PACKAGE BODY, TRIGGER
REFERENCED_LINK_NAME	VARCHAR(128)	Name of the link to the parent object
REFERENCED_NAME	VARCHAR(128)	Name of the referenced object
DEPENDENCY_TYPE	VARCHAR(32)	Indicates whether the dependency is a REF dependency (REF) or not (HARD)

ALL_GLOBAL_SECONDARY_INDEXES

ALL_GLOBAL_SECONDARY_INDEXES describes the global secondary indexes on the tables accessible to the current user.



It is available only on a cluster.

Table 9-15 Column information

Column name	Data type	Description
TABLE_OWNER	VARCHAR(128)	Owner of the global secondary indexed object
TABLE_SCHEMA	VARCHAR(128)	Schema of the global secondary indexed object
TABLE_NAME	VARCHAR(128)	Name of the global secondary indexed object
TABLESPACE_NAME	VARCHAR(128)	Name of the tablespace containing the global secondary index
INI_TRANS	NUMBER	Initial number of transactions
MAX_TRANS	NUMBER	Maximum number of transactions
INITIAL_EXTENT	NUMBER	Size of the initial extent
NEXT_EXTENT	NUMBER	Size of secondary extents
MIN_EXTENTS	NUMBER	Minimum number of extents allowed in the segment
MAX_EXTENTS	NUMBER	Maximum number of extents allowed in the segment
PCT_FREE	NUMBER	Minimum percentage of free space in a block
LOGGING	VARCHAR(3)	Indicates whether or not changes to the global secondary index are logged: (YES) or (NO)
BLOCKS	NUMBER	Number of used blocks in the global secondary index

ALL_GSI_PLACE

ALL_GSI_PLACE describes node placement of all global secondary indexes on the tables accessible to the current user in the cluster system.



It is available only on a cluster.

Table 9-16 Column information

Column name	Data type	Description
TABLE_OWNER	VARCHAR(128)	Owner of the global secondary indexed object
TABLE_SCHEMA	VARCHAR(128)	Schema of the global secondary indexed object
TABLE_NAME	VARCHAR(128)	Name of the global secondary indexed object
GROUP_ID	NUMBER	Group identifier of the node where the global secondary index placed
GROUP_NAME	VARCHAR(128)	Group name of the node where the global secondary index placed
MEMBER_ID	NUMBER	Member identifier of the node where the global secondary index placed
MEMBER_NAME	VARCHAR(128)	Member name of the node where the global secondary index placed
MEMBER_OFFLINE	BOOLEAN	data of the cluster member is offline or not
BLOCKS	NUMBER	Number of used blocks of the node where the global secondary index placed

ALL_INDEXES

ALL_INDEXES describes the indexes on the tables accessible to the current user.

Table 9-17 Column information

Column name	Data type	Description
OWNER	VARCHAR(128)	Owner of the index
INDEX_SCHEMA	VARCHAR(128)	Schema of the index
INDEX_NAME	VARCHAR(128)	Name of the index
INDEX_TYPE	VARCHAR(32)	Type of the index: the value in (NORMAL, NORMAL/REV, BITMAP, FUNCTION-BASED NORMAL, FUNCTION-BASED NORMAL/REV, FUNCTION-BASED BITMAP, IOT - TOP, DOMAIN)
TABLE_OWNER	VARCHAR(128)	Owner of the indexed object
TABLE_SCHEMA	VARCHAR(128)	Schema of the indexed object
TABLE_NAME	VARCHAR(128)	Name of the indexed object
TABLE_TYPE	VARCHAR(32)	Type of the indexed object: the value in (NEXT OBJECT, INDEX, TABLE, VIEW, SYNONYM, SEQUENCE)
UNIQUENESS	VARCHAR(32)	Indicates whether the index is unique (UNIQUE) or nonunique (NON UNIQUE)
COMPRESSION	VARCHAR(32)	<ul style="list-style-type: none"> reserved Indicates whether index compression is enabled (ENABLED) or not (DISABLED)
PREFIX_LENGTH	NUMBER	<ul style="list-style-type: none"> reserved Number of columns in the prefix of the compression key
TABLESPACE_NAME	VARCHAR(128)	Name of the tablespace containing the index
INI_TRANS	NUMBER	Initial number of transactions
MAX_TRANS	NUMBER	Maximum number of transactions
INITIAL_EXTENT	NUMBER	Size of the initial extent
NEXT_EXTENT	NUMBER	Size of secondary extents
MIN_EXTENTS	NUMBER	Minimum number of extents allowed in the segment
MAX_EXTENTS	NUMBER	Maximum number of extents allowed in the segment
PCT_INCREASE	NUMBER	<ul style="list-style-type: none"> reserved Percentage increase in extent size
PCT_THRESHOLD	NUMBER	<ul style="list-style-type: none"> reserved Threshold percentage of block space allowed per index entry
INCLUDE_COLUMN	NUMBER	<ul style="list-style-type: none"> reserved Column ID of the last column to be included in index-organized table primary key (non-overflow) index
FREELISTS	NUMBER	<ul style="list-style-type: none"> reserved Number of process freelists allocated to this segment
FREELIST_GROUPS	NUMBER	<ul style="list-style-type: none"> reserved Number of freelist groups allocated to this segment

Column name	Data type	Description
PCT_FREE	NUMBER	Minimum percentage of free space in a block
LOGGING	VARCHAR(3)	Indicates whether or not changes to the index are logged: (YES) or (NO)
BLOCKS	NUMBER	Number of used blocks in the index
BLEVEL	NUMBER	<ul style="list-style-type: none"> reserved B-Tree level (depth of the index from its root block to its leaf blocks)
LEAF_BLOCKS	NUMBER	<ul style="list-style-type: none"> reserved Number of leaf blocks in the index
DISTINCT_KEYS	NUMBER	Number of distinct indexed values.
AVG_LEAF_BLOCKS_PER_KEY	NUMBER	<ul style="list-style-type: none"> reserved Average number of leaf blocks in which each distinct value in the index appears, rounded to the nearest integer
AVG_DATA_BLOCKS_PER_KEY	NUMBER	<ul style="list-style-type: none"> reserved Average number of data blocks in the table that are pointed to by a distinct value in the index rounded to the nearest integer
CLUSTERING_FACTOR	NUMBER	<ul style="list-style-type: none"> reserved Indicates the amount of order of the rows in the table based on the values of the index
STATUS	VARCHAR(32)	Indicates whether a nonpartitioned index is VALID or UNUSABLE
NUM_ROWS	NUMBER	<ul style="list-style-type: none"> reserved Number of rows in the index
SAMPLE_SIZE	NUMBER	Size of the sample used to analyze the index
LAST_ANALYZED	TIMESTAMP(6) WITH OUT TIME ZONE	Date on which this index was most recently analyzed
DEGREE	VARCHAR(32)	<ul style="list-style-type: none"> reserved Number of threads per instance for scanning the index, or DEFAULT
INSTANCES	VARCHAR(32)	<ul style="list-style-type: none"> reserved Number of instances across which the indexes to be scanned, or DEFAULT
PARTITIONED	VARCHAR(3)	<ul style="list-style-type: none"> reserved Indicates whether the index is partitioned (YES) or not (NO)
TEMPORARY	VARCHAR(1)	Indicates whether the index is on a temporary table (Y) or not (N)
GENERATED	VARCHAR(1)	Indicates whether the name of the index is system-generated (Y) or not (N)
SECONDARY	VARCHAR(1)	Indicates whether the index is a secondary object created by the method of the Data Cartridge (Y) or not (N)
BUFFER_POOL	VARCHAR(32)	<ul style="list-style-type: none"> reserved Buffer pool to be used for index blocks
FLASH_CACHE	VARCHAR(32)	<ul style="list-style-type: none"> reserved Database Smart Flash Cache hint to be used for index blocks
		<ul style="list-style-type: none"> reserved

Column name	Data type	Description
CELL_FLASH_CACHE	VARCHAR(32)	Cell flash cache hint to be used for index blocks
USER_STATS	VARCHAR(3)	<ul style="list-style-type: none"> reserved Indicates whether statistics were entered directly by the user (YES) or not (NO)
DURATION	VARCHAR(32)	<ul style="list-style-type: none"> reserved Indicates the duration of a temporary table
PCT_DIRECT_ACCESS	NUMBER	<ul style="list-style-type: none"> reserved For a secondary index on an index-organized table, the percentage of rows with VALID guess
ITYP_OWNER	VARCHAR(128)	<ul style="list-style-type: none"> reserved For a domain index, the owner of the indextype
ITYP_NAME	VARCHAR(128)	<ul style="list-style-type: none"> reserved For a domain index, the name of the indextype
PARAMETERS	VARCHAR(1024)	<ul style="list-style-type: none"> reserved For a domain index, the parameter string
GLOBAL_STATS	VARCHAR(3)	<ul style="list-style-type: none"> reserved For partitioned indexes, indicates whether statistics were collected by analyzing the index as a whole (YES) or were estimated from statistics on underlying index partitions and subpartitions (NO)
DOMIDX_STATUS	VARCHAR(32)	<ul style="list-style-type: none"> reserved Status of a domain index
DOMIDX_OPSTATUS	VARCHAR(32)	<ul style="list-style-type: none"> reserved Status of the operation on a domain index
FUNCIDX_STATUS	VARCHAR(32)	<ul style="list-style-type: none"> reserved Status of a function-based index
JOIN_INDEX	VARCHAR(3)	<ul style="list-style-type: none"> reserved Indicates whether the index is a join index (YES) or not (NO)
IOT_REDUNDANT_PKEY_ELIM	VARCHAR(3)	<ul style="list-style-type: none"> reserved Indicates whether redundant primary key columns are eliminated from secondary indexes on index-organized tables (YES) or not (NO)
DROPPED	VARCHAR(3)	<ul style="list-style-type: none"> reserved Indicates whether the index has been dropped and is in the recycle bin (YES) or not (NO)
VISIBILITY	VARCHAR(3)	<ul style="list-style-type: none"> reserved Indicates whether the index is VISIBLE or INVISIBLE to the optimizer
DOMIDX_MANAGEMENT	VARCHAR(32)	<ul style="list-style-type: none"> reserved If this is a domain index, indicates whether the domain index is system-managed (SYSTEM_MANAGED) or user-managed (USER_MANAGED)
SEGMENT_CREATED	VARCHAR(3)	Indicates whether the index segment has been created (YES) or not (NO)

Column name	Data type	Description
COMMENTS	VARCHAR(1024)	Comments of the index
EMPTY_BLOCKS	NUMBER	Number of empty blocks in the index

ALL_IND_COLUMNS

ALL_IND_COLUMNS describes the columns of indexes on all tables accessible to the current user.

Table 9-18 Column information

Column name	Data type	Description
INDEX_OWNER	VARCHAR(128)	Owner of the index
INDEX_SCHEMA	VARCHAR(128)	Schema of the index
INDEX_NAME	VARCHAR(128)	Name of the index
TABLE_OWNER	VARCHAR(128)	Owner of the table or cluster
TABLE_SCHEMA	VARCHAR(128)	Schema of the table or cluster
TABLE_NAME	VARCHAR(128)	Name of the table or cluster
COLUMN_NAME	VARCHAR(128)	Column name or attribute of the object type column
COLUMN_POSITION	NUMBER	Position of the column or attribute within the index
COLUMN_LENGTH	NUMBER	Indexed length of the column
CHAR_LENGTH	NUMBER	Maximum codepoint length of the column
DESCEND	VARCHAR(32)	Indicates whether the column is sorted in descending order (DESC) or ascending order (ASC)
NULL_ORDER	VARCHAR(32)	Indicates whether the null value of the column is sorted in nulls first order (NULLS FIRST) or nulls last order (NULLS LAST)

ALL_IND_PLACE

ALL_IND_PLACE describes node placement of the indexes on the tables accessible to the current user in the cluster system.



It is available only on a cluster.

Table 9-19 Column information

Column name	Data type	Description
OWNER	VARCHAR(128)	Owner of the index
INDEX_SCHEMA	VARCHAR(128)	Schema of the index
INDEX_NAME	VARCHAR(128)	Name of the index
TABLE_OWNER	VARCHAR(128)	Owner of the indexed object
TABLE_SCHEMA	VARCHAR(128)	Schema of the indexed object
TABLE_NAME	VARCHAR(128)	Name of the indexed object
GROUP_ID	NUMBER	Group identifier of the node where the index placed
GROUP_NAME	VARCHAR(128)	Group name of the node where the index placed
MEMBER_ID	NUMBER	Member identifier of the node where the index placed
MEMBER_NAME	VARCHAR(128)	Member name of the node where the index placed
MEMBER_OFFLINE	BOOLEAN	data of the cluster member is offline or not
DISTINCT_KEYS	NUMBER	(deprecated)
SAMPLE_SIZE	NUMBER	(deprecated)
BLOCKS	NUMBER	Number of used blocks of the node where the index placed
LAST_ANALYZED	TIMESTAMP(2) WITH OUT TIME ZONE	(deprecated)

ALL_NONSCHEMA_COMMENTS

ALL_NONSCHEMA_COMMENTS displays comments on all non-schema objects (database, authorizations, schemas, tablespaces) accessible to the current user.

Table 9-20 Column information

Column name	Data type	Description
OBJECT_NAME	VARCHAR(128)	Name of the non-schema object
OBJECT_TYPE	VARCHAR(32)	Type of the non-schema object: DATABASE, AUTHORIZATION, SCHEMA, TABLESPACE
COMMENTS	VARCHAR(1024)	Comments of the non-schema object

ALL_OBJECTS

ALL_OBJECTS describes all objects accessible to the current user.

Table 9-21 Column information

Column name	Data type	Description
OWNER	VARCHAR(128)	Owner of the object
SCHEMA_NAME	VARCHAR(128)	Schema of the object
OBJECT_NAME	VARCHAR(128)	Name of the object
SUBOBJECT_NAME	VARCHAR(128)	Name of the subobject (for example, partition)
OBJECT_ID	NUMBER	Dictionary object number of the object
DATA_OBJECT_ID	NUMBER	Dictionary object number of the segment that contains the object
OBJECT_TYPE	VARCHAR(32)	Type of the object (such as TABLE, INDEX)
CREATED	TIMESTAMP(2) WITHOUT TIME ZONE	Timestamp for the creation of the object
LAST_DDL_TIME	TIMESTAMP(2) WITHOUT TIME ZONE	Timestamp for the last modification of the object resulting from a DDL statement
TIMESTAMP	VARCHAR(32)	Timestamp for the specification of the object (character data)
STATUS	VARCHAR(32)	Status of the object: the value in (VALID, INVALID, N/A)
TEMPORARY	VARCHAR(1)	Indicates whether the object is temporary (the current session can see only data that it placed in this object itself) (Y) or not (N)
GENERATED	VARCHAR(1)	* reserved Indicates whether the name of this object was system-generated (Y) or not (N)
SECONDARY	VARCHAR(1)	• reserved Indicates whether this is a secondary object created by the ODCIIndexCreate method of the Oracle Data Cartridge (Y) or not (N)
NAMESPACE	NUMBER	Namespace for the object
EDITION_NAME	VARCHAR(128)	• reserved Name of the edition in which the object is actual

ALL_PROCEDURES

ALL_PROCEDURES lists all function, procedures or pacakage

Table 9-22 Column information

Column name	Data type	Description
OWNER	VARCHAR(128)	Owner of function, procedures or pacakage
SCHEMA_NAME	VARCHAR(128)	Schema Name of function, procedures or package
OBJECT_NAME	VARCHAR(128)	Name of function, procedures or pacakage
PROCEDURE_NAME	VARCHAR(128)	Name when a procedures in pacakage
OBJECT_ID	NUMBER	ID of a function, procedures or pacakage
SUBPROGRAM_ID	NUMBER	ID of procedures in pacakage
OVERLOAD	VARCHAR(32)	ID of overloading procedure in pacakage
OBJECT_TYPE	VARCHAR(32)	Type of function, procedures or package
AGGREGATE	VARCHAR(3)	Indicate whether the procedure is an aggreage function(YES) or not (NO)
PIPELINED	VARCHAR(3)	Indicate whether the procedure is a pipelined table function(YES) or not(NO)
IMPLTYPEOWNER	VARCHAR(128)	Name of the owner of the implementation type, if any
IMPLTYPENAME	VARCHAR(128)	Name of the implementation type, if any
PARALLEL	VARCHAR(3)	Indicates whether the procedure or function is parallel-enabled (YES) or not (NO)
INTERFACE	VARCHAR(3)	YES, if the procedure/function is a table function implemented using the SQLCLI interface; otherwise NO
DETERMINISTIC	VARCHAR(3)	YES, if the procedure/function is declared to be deterministic; otherwise NO
AUTHID	VARCHAR(32)	Indicates whether the procedure/function is declared to execute as DEFINER or CURRENT_USER (invoker)

ALL_PROC_PRIVS

ALL_PROC_PRIVS describes the procedure grants, for which the current user is the procedure owner, grantor, or grantee, or for which an enabled role or PUBLIC is the grantee.

Table 9-23 Column information

Column name	Data type	Description
GRANTOR	VARCHAR(128)	Name of the user who performed the grant
GRANTEE	VARCHAR(128)	Name of the user or role to whom access was granted
PROCEDURE_OWNER	VARCHAR(128)	Owner of the procedure, function or package
PROCEDURE_SCHEMA	VARCHAR(128)	Schema of the procedure, function or package
PROCEDURE_NAME	VARCHAR(128)	Name of the procedure, function or package
PRIVILEGE	VARCHAR(32)	Privilege on the procedure, function or package
GRANTABLE	VARCHAR(3)	Indicates whether the privilege was granted with the GRANT OPTION (YES) or not (NO)

ALL_PROC_PRIVS_MADE

ALL_PROC_PRIVS_MADE describes the procedure grants for which the current user is the procedure owner or grantor.

Table 9-24 Column information

Column name	Data type	Description
GRANTOR	VARCHAR(128)	Name of the user who performed the grant
GRANTEE	VARCHAR(128)	Name of the user or role to whom access was granted
PROCEDURE_OWNER	VARCHAR(128)	Owner of the procedure, function or package
PROCEDURE_SCHEMA	VARCHAR(128)	Schema of the procedure, function or package
PROCEDURE_NAME	VARCHAR(128)	Name of the procedure, function or package
PRIVILEGE	VARCHAR(32)	Privilege on the procedure, function or package
GRANTABLE	VARCHAR(3)	Indicates whether the privilege was granted with the GRANT OPTION (YES) or not (NO)

ALL_PROC_PRIVS_REC'D

ALL_PROC_PRIVS_REC'D describes the procedure grants, for which the current user is the grantee, or for which an enabled role or PUBLIC is the grantee.

Table 9-25 Column information

Column name	Data type	Description
GRANTOR	VARCHAR(128)	Name of the user who performed the grant
GRANTEE	VARCHAR(128)	Name of the user or role to whom access was granted
PROCEDURE_OWNER	VARCHAR(128)	Owner of the procedure, function or package
PROCEDURE_SCHEMA	VARCHAR(128)	Schema of the procedure, function or package
PROCEDURE_NAME	VARCHAR(128)	Name of the procedure, function or package
PRIVILEGE	VARCHAR(32)	Privilege on the procedure, function or package
GRANTABLE	VARCHAR(3)	Indicates whether the privilege was granted with the GRANT OPTION (YES) or not (NO)

ALL_SCHEMAS

ALL_SCHEMAS identifies the schemata in a catalog that are owned by given user or accessible to given user or role.

Table 9-26 Column information

Column name	Data type	Description
SCHEMA_OWNER	VARCHAR(128)	Owner of the schema
SCHEMA_NAME	VARCHAR(128)	Name of the schema
CREATED_TIME	TIMESTAMP(2) WITHOUT TIME ZONE	Created time of the schema
MODIFIED_TIME	TIMESTAMP(2) WITHOUT TIME ZONE	Last modified time of the schema
COMMENTS	VARCHAR(1024)	Comments of the schema

ALL_SCHEMA_PATH

ALL_SCHEMA_PATH describes the schema search order of the current user and PUBLIC, for naming resolution of unqualified SQL schema objects.

Table 9-27 Column information

Column name	Data type	Description
AUTH_NAME	VARCHAR(128)	Name of the authorization
SCHEMA_NAME	VARCHAR(128)	Name of the schema
SEARCH_ORDER	NUMBER	Schema search order of the authorization

ALL_SCHEMA_PRIVS

ALL_SCHEMA_PRIVS describes the schema grants, for which the current user is the schema owner, grant or, or grantee, or for which an enabled role or PUBLIC is the grantee.

Table 9-28 Column information

Column name	Data type	Description
GRANTOR	VARCHAR(128)	Name of the user who performed the grant
GRANTEE	VARCHAR(128)	Name of the user or role to whom access was granted
OWNER	VARCHAR(128)	Owner of the schema
SCHEMA_NAME	VARCHAR(128)	Name of the schema
PRIVILEGE	VARCHAR(32)	Privilege on the schema
GRANTABLE	VARCHAR(3)	Indicates whether the privilege was granted with the GRANT OPTION (YES) or not (NO)

ALL_SCHEMA_PRIVS_MADE

ALL_SCHEMA_PRIVS_MADE describes the schema grants, for which the current user is the grantor.

Table 9-29 Column information

Column name	Data type	Description
GRANTOR	VARCHAR(128)	Name of the user who performed the grant
GRANTEE	VARCHAR(128)	Name of the user or role to whom access was granted
OWNER	VARCHAR(128)	Owner of the schema
SCHEMA_NAME	VARCHAR(128)	Name of the schema
PRIVILEGE	VARCHAR(32)	Privilege on the schema
GRANTABLE	VARCHAR(3)	Indicates whether the privilege was granted with the GRANT OPTION (YES) or not (NO)

ALL_SCHEMA_PRIVS_REC'D

ALL_SCHEMA_PRIVS_REC'D describes the schema grants, for which the current user is the grantee, or for which an enabled role or PUBLIC is the grantee.

Table 9-30 Column information

Column name	Data type	Description
GRANTOR	VARCHAR(128)	Name of the user who performed the grant
GRANTEE	VARCHAR(128)	Name of the user or role to whom access was granted
OWNER	VARCHAR(128)	Owner of the schema
SCHEMA_NAME	VARCHAR(128)	Name of the schema
PRIVILEGE	VARCHAR(32)	Privilege on the schema
GRANTABLE	VARCHAR(3)	Indicates whether the privilege was granted with the GRANT OPTION (YES) or not (NO)

ALL_SEQUENCES

ALL_SEQUENCES describes all sequences accessible to the current user.

Table 9-31 Column information

Column name	Data type	Description
SEQUENCE_OWNER	VARCHAR(128)	Owner of the sequence
SEQUENCE_SCHEMA	VARCHAR(128)	Schema of the sequence
SEQUENCE_NAME	VARCHAR(128)	Sequence name
MIN_VALUE	NUMBER	Minimum value of the sequence
MAX_VALUE	NUMBER	Maximum value of the sequence
INCREMENT_BY	NUMBER	Value by which sequence is incremented
CYCLE_FLAG	VARCHAR(1)	Indicates whether the sequence wraps around on reaching the limit (Y) or not (N)
ORDER_FLAG	VARCHAR(1)	Indicates whether sequence numbers are generated in order (Y) or not (N)
CACHE_SIZE	NUMBER	Number of sequence numbers to cache
LAST_NUMBER	NUMBER	Last sequence number written to database. If a sequence uses caching, the number written to database is the last number placed in the sequence cache.
COMMENTS	VARCHAR(1024)	Comments of the sequence

ALL_SEQ_PRIVS

ALL_SEQ_PRIVS describes the sequence grants, for which the current user is the sequence owner, grantor, or grantee, or for which an enabled role or PUBLIC is the grantee.

Table 9-32 Column information

Column name	Data type	Description
GRANTOR	VARCHAR(128)	Name of the user who performed the grant
GRANTEE	VARCHAR(128)	Name of the user or role to whom access was granted
SEQUENCE_OWNER	VARCHAR(128)	Owner of the sequence
SEQUENCE_SCHEMA	VARCHAR(128)	Schema of the sequence
SEQUENCE_NAME	VARCHAR(128)	Name of the sequence
PRIVILEGE	VARCHAR(32)	Privilege on the sequence
GRANTABLE	VARCHAR(3)	Indicates whether the privilege was granted with the GRANT OPTION (YES) or not (NO)

ALL_SEQ_PRIVS_MADE

ALL_SEQ_PRIVS_MADE describes the sequence grants for which the current user is the sequence owner or grantor.

Table 9-33 Column information

Column name	Data type	Description
GRANTOR	VARCHAR(128)	Name of the user who performed the grant
GRANTEE	VARCHAR(128)	Name of the user or role to whom access was granted
SEQUENCE_OWNER	VARCHAR(128)	Owner of the sequence
SEQUENCE_SCHEM A	VARCHAR(128)	Schema of the sequence
SEQUENCE_NAME	VARCHAR(128)	Name of the sequence
PRIVILEGE	VARCHAR(32)	Privilege on the sequence
GRANTABLE	VARCHAR(3)	Indicates whether the privilege was granted with the GRANT OPTIO N (YES) or not (NO)

ALL_SEQ_PRIVS_REC'D

ALL_SEQ_PRIVS_REC'D describes the sequence grants, for which the current user is the grantee, or for which an enabled role or PUBLIC is the grantee.

Table 9-34 Column information

Column name	Data type	Description
GRANTOR	VARCHAR(128)	Name of the user who performed the grant
GRANTEE	VARCHAR(128)	Name of the user or role to whom access was granted
SEQUENCE_OWNER	VARCHAR(128)	Owner of the sequence
SEQUENCE_SCHEMA	VARCHAR(128)	Schema of the sequence
SEQUENCE_NAME	VARCHAR(128)	Name of the sequence
PRIVILEGE	VARCHAR(32)	Privilege on the sequence
GRANTABLE	VARCHAR(3)	Indicates whether the privilege was granted with the GRANT OPTION (YES) or not (NO)

ALL_SHARD_KEY_COLUMNS

ALL_SHARD_KEY_COLUMNS describes shard key columns of all shared tables accessible to the current user in the cluster system.



It is available only on a cluster.

Table 9-35 Column information

Column name	Data type	Description
OWNER	VARCHAR(128)	Owner of the table
TABLE_SCHEMA	VARCHAR(128)	Schema of the table
TABLE_NAME	VARCHAR(128)	Name of the table
COLUMN_NAME	VARCHAR(128)	Column name of the shard key
COLUMN_POSITION	NUMBER	Position of the column within the shard key

ALL_SOURCE

ALL_SOURCE describes the text source of the stored objects accessible to the current user.

Table 9-36 Column information

Column name	Data type	Description
OWNER	VARCHAR(128)	Owner of object
SCHEMA_NAME	VARCHAR(128)	Schema Name of object
NAME	VARCHAR(128)	Name of object
TYPE	VARCHAR(32)	Type of object: FUNCTION, PROCEDURE, PACKAGE, PACKAGE BODY, TRIGGER
LINE	NUMBER	Line number of this line of source
TEXT	LONG VARCHAR	Text source of the stored object
ORIGIN_CON_ID	VARCHAR(256)	ID of the container where the data originates

ALL_SYNONYMS

ALL_SYNONYMS describes all synonyms.

Table 9-37 Column information

Column name	Data type	Description
SYNONYM_OWNER	VARCHAR(128)	Owner of the synonym
SYNONYM_SCHEMA	VARCHAR(128)	Schema of the synonym
SYNONYM_NAME	VARCHAR(128)	Synonym name
OBJECT_SCHEMA_NAME	VARCHAR(128)	Object schema name
OBJECT_NAME	VARCHAR(128)	Object name
DB_LINK	VARCHAR(128)	Reserved for future use

ALL_TABLES

ALL_TABLES describes the relational tables accessible to the current user.

Table 9-38 Column information

Column name	Data type	Description
OWNER	VARCHAR(128)	Owner of the table
TABLE_SCHEMA	VARCHAR(128)	Schema of the table
TABLE_NAME	VARCHAR(128)	Name of the table
TABLESPACE_NAME	VARCHAR(128)	Name of the tablespace containing the table
CLUSTER_NAME	VARCHAR(128)	<ul style="list-style-type: none"> reserved Name of the cluster
IOT_NAME	VARCHAR(128)	<ul style="list-style-type: none"> reserved Name of the index-organized table
STATUS	VARCHAR(32)	<ul style="list-style-type: none"> reserved If a previous DROP TABLE operation failed, indicates whether the table is unusable (UNUSABLE) or valid (VALID)
PCT_FREE	NUMBER	Minimum percentage of free space in a block
PCT_USED	NUMBER	Minimum percentage of used space in a block
INI_TRANS	NUMBER	Initial number of transactions
MAX_TRANS	NUMBER	Maximum number of transactions
INITIAL_EXTENT	NUMBER	Size of the initial extent (in bytes)
NEXT_EXTENT	NUMBER	Size of secondary extents (in bytes)
MIN_EXTENTS	NUMBER	Minimum number of extents allowed in the segment
MAX_EXTENTS	NUMBER	Maximum number of extents allowed in the segment
PCT_INCREASE	NUMBER	<ul style="list-style-type: none"> reserved Percentage increase in extent size
FREELISTS	NUMBER	<ul style="list-style-type: none"> reserved Number of process freelists allocated to the segment
FREELIST_GROUPS	NUMBER	<ul style="list-style-type: none"> reserved Number of freelist groups allocated to the segment
LOGGING	VARCHAR(3)	Indicates whether or not changes to the table are logged
BACKED_UP	VARCHAR(1)	<ul style="list-style-type: none"> reserved Indicates whether the table has been backed up since the last modification (Y) or not (N)
NUM_ROWS	NUMBER	Number of rows in the table
BLOCKS	NUMBER	Number of used blocks in the table
EMPTY_BLOCKS	NUMBER	<ul style="list-style-type: none"> reserved Number of empty (never used) blocks in the table
AVG_SPACE	NUMBER	<ul style="list-style-type: none"> reserved Average available free space in the table
		<ul style="list-style-type: none"> reserved

Column name	Data type	Description
CHAIN_CNT	NUMBER	Number of rows in the table that are chained from one data block to another or that have migrated to a new block, requiring a link to preserve the old rowid
AVG_ROW_LEN	NUMBER	<ul style="list-style-type: none"> reserved Average row length, including row overhead
AVG_SPACE_FREELIST_BLOCKS	NUMBER	<ul style="list-style-type: none"> reserved Average freespace of all blocks on a freelist
NUM_FREELIST_BLOCKS	NUMBER	<ul style="list-style-type: none"> reserved Number of blocks on the freelist
DEGREE	VARCHAR(32)	<ul style="list-style-type: none"> reserved Number of threads per instance for scanning the table, or DEFAULT
INSTANCES	VARCHAR(32)	<ul style="list-style-type: none"> reserved Number of instances across which the table is to be scanned, or DEFAULT
CACHE	VARCHAR(1)	<ul style="list-style-type: none"> reserved Indicates whether the table is to be cached in the buffer cache (Y) or not (N)
TABLE_LOCK	VARCHAR(32)	Indicates whether table locking is enabled (ENABLED) or disabled (DISABLED)
SAMPLE_SIZE	NUMBER	Sample size used in analyzing the table
LAST_ANALYZED	TIMESTAMP(6) WITH OUT TIME ZONE	Date on which the table was most recently analyzed
PARTITIONED	VARCHAR(3)	<ul style="list-style-type: none"> reserved Indicates whether the table is partitioned (YES) or not (NO)
IOT_TYPE	VARCHAR(32)	<ul style="list-style-type: none"> reserved If the table is an index-organized table, then IOT_TYPE is IOT, IOT_OVERFLOW, or IOT_MAPPING.
TEMPORARY	VARCHAR(1)	Indicates whether the table is temporary (Y) or not (N)
SECONDARY	VARCHAR(1)	<ul style="list-style-type: none"> reserved Indicates whether the table is a secondary object created by cartridge
NESTED	VARCHAR(3)	<ul style="list-style-type: none"> reserved Indicates whether the table is a nested table (YES) or not (NO)
BUFFER_POOL	VARCHAR(32)	<ul style="list-style-type: none"> reserved Buffer pool to be used for table blocks
FLASH_CACHE	VARCHAR(32)	<ul style="list-style-type: none"> reserved Database Smart Flash Cache hint to be used for table blocks
CELL_FLASH_CACHE	VARCHAR(32)	<ul style="list-style-type: none"> reserved Cell flash cache hint to be used for table blocks
ROW_MOVEMENT	VARCHAR(32)	<ul style="list-style-type: none"> reserved If a partitioned table, indicates whether row movement is enabled

Column name	Data type	Description
		(ENABLED) or disabled (DISABLED)
GLOBAL_STATS	VARCHAR(3)	<ul style="list-style-type: none"> reserved For partitioned tables, indicates whether statistics for the table as a whole (global statistics) are accurate (YES)
USER_STATS	VARCHAR(3)	<ul style="list-style-type: none"> reserved Indicates whether statistics were entered directly by the user (YES) or not (NO)
DURATION	VARCHAR(32)	<ul style="list-style-type: none"> reserved Indicates the duration of a temporary table
SKIP_CORRUPT	VARCHAR(32)	<ul style="list-style-type: none"> reserved Indicates whether Database ignores blocks marked corrupt during table and index scans (ENABLED) or raises an error (DISABLED)
MONITORING	VARCHAR(3)	<ul style="list-style-type: none"> reserved Indicates whether the table has the MONITORING attribute set (YES) or not (NO)
CLUSTER_OWNER	VARCHAR(128)	<ul style="list-style-type: none"> reserved Owner of the cluster, if any
DEPENDENCIES	VARCHAR(32)	<ul style="list-style-type: none"> reserved Indicates whether row-level dependency tracking is enabled (ENABLED) or disabled (DISABLED)
COMPRESSION	VARCHAR(32)	<ul style="list-style-type: none"> reserved Indicates whether table compression is enabled (ENABLED) or not (DISABLED)
COMPRESS_FOR	VARCHAR(32)	<ul style="list-style-type: none"> reserved Default compression for what kind of operations
DROPPED	VARCHAR(3)	<ul style="list-style-type: none"> reserved Indicates whether the table has been dropped and is in the recycle bin (YES) or not (NO)
READ_ONLY	VARCHAR(3)	Indicates whether the table IS READ-ONLY (YES) or not (NO)
SEGMENT_CREATED	VARCHAR(3)	Indicates whether the table segment has been created (YES) or not (NO)
RESULT_CACHE	VARCHAR(32)	<ul style="list-style-type: none"> reserved Result cache mode annotation for the table: the value in (NULL, DEFAULT, FORCE, MANUAL)

ALL_TAB_COLS

ALL_TAB_COLS describes the columns (including hidden columns) of the tables, views, and clusters accessible to the current user.

Table 9-39 Column information

Column name	Data type	Description
OWNER	VARCHAR(128)	Owner of the object
TABLE_SCHEMA	VARCHAR(128)	Schema of the object
TABLE_NAME	VARCHAR(128)	Name of the object
COLUMN_NAME	VARCHAR(128)	Column name
DATA_TYPE	VARCHAR(128)	Datatype of the column
DATA_TYPE_MOD	VARCHAR(3)	<ul style="list-style-type: none"> reserved Datatype modifier of the column
DATA_TYPE_OWNER	VARCHAR(128)	<ul style="list-style-type: none"> reserved Owner of the datatype of the column
DATA_LENGTH	NUMBER	Length of the column (in bytes)
DATA_PRECISION	NUMBER	Decimal precision for NUMBER datatype; binary precision for FLOAT datatype; NULL for all other datatypes
DATA_SCALE	NUMBER	Digits to the right of the decimal point in a number
NULLABLE	VARCHAR(1)	Indicates whether a column allows NULLs.
COLUMN_ID	NUMBER	Sequence number of the column as created
DEFAULT_LENGTH	NUMBER	Length of the default value for the column
DATA_DEFAULT	LONG VARCHAR	Default value for the column
NUM_DISTINCT	NUMBER	Number of distinct values in the column
LOW_VALUE	VARBINARY(32)	Low value in the column
HIGH_VALUE	VARBINARY(32)	High value in the column
DENSITY	NUMBER	<ul style="list-style-type: none"> reserved If a histogram is available on COLUMN_NAME, then this column displays the selectivity of a value that spans fewer than 2 endpoints in the histogram.
NUM_NULLS	NUMBER	Number of NULLs in the column
NUM_BUCKETS	NUMBER	<ul style="list-style-type: none"> reserved Number of buckets in the histogram for the column
LAST_ANALYZED	TIMESTAMP(6) WITH OUT TIME ZONE	Date on which this column was most recently analyzed
SAMPLE_SIZE	NUMBER	Sample size used in analyzing this column
CHARACTER_SET_NAME	VARCHAR(128)	<ul style="list-style-type: none"> reserved Name of the character set
CHAR_COL_DECL_LENGTH	NUMBER	<ul style="list-style-type: none"> reserved Declaration length of the character type column
		<ul style="list-style-type: none"> reserved

Column name	Data type	Description
GLOBAL_STATS	VARCHAR(3)	For partitioned tables, indicates whether column statistics were collected for the table
USER_STATS	VARCHAR(3)	<ul style="list-style-type: none"> reserved Indicates whether statistics were entered directly by the user (YES) or not (NO)
AVG_COL_LEN	NUMBER	Average length of the column (in bytes)
CHAR_LENGTH	NUMBER	Displays the length of the column in characters.
CHAR_USED	VARCHAR(1)	Indicates that the column uses BYTE length semantics (B) or CHAR length semantics (C)
V80_FMT_IMAGE	VARCHAR(3)	<ul style="list-style-type: none"> reserved Indicates whether the column data is in release older image format (YES) or not (NO)
DATA_UPGRADED	VARCHAR(3)	<ul style="list-style-type: none"> reserved Indicates whether the column data has been upgraded to the latest type version format (YES) or not (NO)
HIDDEN_COLUMN	VARCHAR(3)	Indicates whether the column is a hidden column (YES) or not (NO)
VIRTUAL_COLUMN	VARCHAR(3)	<ul style="list-style-type: none"> reserved Indicates whether the column is a virtual column (YES) or not (NO)
SEGMENT_COLUMN_ID	NUMBER	Sequence number of the column in the segment
INTERNAL_COLUMN_ID	NUMBER	Internal sequence number of the column
HISTOGRAM	VARCHAR(32)	<ul style="list-style-type: none"> reserved Indicates existence/type of histogram
QUALIFIED_COLUMN_NAME	VARCHAR(4000)	Qualified column name
IDENTITY_COLUMN	VARCHAR(3)	Indicates whether this is an identity column (YES) or not (NO)

ALL_TAB_COLUMNS

ALL_TAB_COLUMNS describes the columns of the tables, views, and clusters accessible to the current user.

Table 9-40 Column information

Column name	Data type	Description
OWNER	VARCHAR(128)	Owner of the object
TABLE_SCHEMA	VARCHAR(128)	Schema of the object
TABLE_NAME	VARCHAR(128)	Name of the object
COLUMN_NAME	VARCHAR(128)	Column name
DATA_TYPE	VARCHAR(128)	Datatype of the column
DATA_TYPE_MOD	VARCHAR(3)	<ul style="list-style-type: none"> reserved Datatype modifier of the column
DATA_TYPE_OWNER	VARCHAR(128)	<ul style="list-style-type: none"> reserved Owner of the datatype of the column
DATA_LENGTH	NUMBER	Length of the column (in bytes)
DATA_PRECISION	NUMBER	Decimal precision for NUMBER datatype; binary precision for FLOAT datatype; NULL for all other datatypes
DATA_SCALE	NUMBER	Digits to the right of the decimal point in a number
NULLABLE	VARCHAR(1)	Indicates whether a column allows NULLs.
COLUMN_ID	NUMBER	Sequence number of the column as created
DEFAULT_LENGTH	NUMBER	Length of the default value for the column
DATA_DEFAULT	LONG VARCHAR	Default value for the column
NUM_DISTINCT	NUMBER	Number of distinct values in the column
LOW_VALUE	VARBINARY(32)	Low value in the column
HIGH_VALUE	VARBINARY(32)	High value in the column
DENSITY	NUMBER	<ul style="list-style-type: none"> reserved If a histogram is available on COLUMN_NAME, then this column displays the selectivity of a value that spans fewer than 2 endpoints in the histogram.
NUM_NULLS	NUMBER	Number of NULLs in the column
NUM_BUCKETS	NUMBER	<ul style="list-style-type: none"> reserved Number of buckets in the histogram for the column
LAST_ANALYZED	TIMESTAMP(6) WITH OUT TIME ZONE	Date on which this column was most recently analyzed
SAMPLE_SIZE	NUMBER	Sample size used in analyzing this column
CHARACTER_SET_NAME	VARCHAR(128)	<ul style="list-style-type: none"> reserved Name of the character set
CHAR_COL_DECL_LENGTH	NUMBER	Declaration length of the character type column
		<ul style="list-style-type: none"> reserved

Column name	Data type	Description
GLOBAL_STATS	VARCHAR(3)	For partitioned tables, indicates whether column statistics were collected for the table
USER_STATS	VARCHAR(3)	<ul style="list-style-type: none"> reserved Indicates whether statistics were entered directly by the user (YES) or not (NO)
AVG_COL_LEN	NUMBER	Average length of the column (in bytes)
CHAR_LENGTH	NUMBER	Displays the length of the column in characters.
CHAR_USED	VARCHAR(1)	Indicates that the column uses BYTE length semantics (B) or CHAR length semantics (C)
V80_FMT_IMAGE	VARCHAR(3)	<ul style="list-style-type: none"> reserved Indicates whether the column data is in release older image format (YES) or not (NO)
DATA_UPGRADED	VARCHAR(3)	<ul style="list-style-type: none"> reserved Indicates whether the column data has been upgraded to the latest type version format (YES) or not (NO)
HISTOGRAM	VARCHAR(32)	<ul style="list-style-type: none"> reserved Indicates existence/type of histogram
IDENTITY_COLUMN	VARCHAR(3)	Indicates whether this is an identity column (YES) or not (NO)

ALL_TAB_COMMENTS

ALL_TAB_COMMENTS displays comments on the tables and views accessible to the current user.

Table 9-41 Column information

Column name	Data type	Description
OWNER	VARCHAR(128)	Owner of the object
TABLE_SCHEMA	VARCHAR(128)	Schema of the object
TABLE_NAME	VARCHAR(128)	Name of the object
TABLE_TYPE	VARCHAR(32)	Type of the object
COMMENTS	VARCHAR(1024)	Comment on the object

ALL_TAB_IDENTITY_COLS

ALL_TAB_IDENTITY_COLS describes all table identity columns.

Table 9-42 Column information

Column name	Data type	Description
OWNER	VARCHAR(128)	Owner of the table
TABLE_SCHEMA	VARCHAR(128)	Schema of the table
TABLE_NAME	VARCHAR(128)	Name of the table
COLUMN_NAME	VARCHAR(128)	Name of the identity column
GENERATION_TYPE	VARCHAR(32)	Generation type of the identity column. Possible values are ALWAYS or BY DEFAULT
IDENTITY_OPTIONS	VARCHAR(1024)	Options for the identity column sequence generator

ALL_TAB_PLACE

ALL_TAB_PLACE describes node placement of all cluster tables accessible to the current user in the cluster system.



It is available only on a cluster.

Table 9-43 Column information

Column name	Data type	Description
OWNER	VARCHAR(128)	Owner of the table
TABLE_SCHEMA	VARCHAR(128)	Schema of the table
TABLE_NAME	VARCHAR(128)	Name of the table
GROUP_ID	NUMBER	Group identifier of the node where the table placed
GROUP_NAME	VARCHAR(128)	Group name of the node where the table placed
MEMBER_ID	NUMBER	Member identifier of the node where the table placed
MEMBER_NAME	VARCHAR(128)	Member name of the node where the table placed
MEMBER_OFFLINE	BOOLEAN	data of the cluster member is offline or not
SCN	VARCHAR(64)	table scn of the node where the table placed
NUM_ROWS	NUMBER	Number of rows in the table
BLOCKS	NUMBER	Number of used blocks of the node where the table placed
LAST_ANALYZED	TIMESTAMP(6) WITH OUT TIME ZONE	Date on which the table was most recently analyzed

ALL_TAB_SHARDS

ALL_TAB_SHARDS describes shard information of sharded tables accessible to the current user in the cluster system.



It is available only on a cluster.

Table 9-44 Column information

Column name	Data type	Description
OWNER	VARCHAR(128)	Owner of the table
TABLE_SCHEMA	VARCHAR(128)	Schema of the table
TABLE_NAME	VARCHAR(128)	Name of the table
SHARD_STRATEGY	VARCHAR(32)	Sharding strategy of the table: the value in (HASH SHARDING, RANGE SHARDING, LIST SHARDING)
SHARD_NAME	VARCHAR(128)	Shard name
SHARD_NUMBER	NUMBER	Shard number
SHARD_DEFINITION	LONG VARCHAR	Shard definition (if hash sharded, the value is null)
GROUP_ID	NUMBER	Group identifier where the shard placed
GROUP_NAME	VARCHAR(128)	Group Name where the shard placed

ALL_TAB_PRIVS

ALL_TAB_PRIVS describes the object grants, for which the current user is the object owner, grantor, or grantee, or for which an enabled role or PUBLIC is the grantee.

Table 9-45 Column information

Column name	Data type	Description
GRANTOR	VARCHAR(128)	Name of the user who performed the grant
GRANTEE	VARCHAR(128)	Name of the user or role to whom access was granted
OWNER	VARCHAR(128)	Owner of the object
TABLE_SCHEMA	VARCHAR(128)	Schema of the object
TABLE_NAME	VARCHAR(128)	Name of the object
PRIVILEGE	VARCHAR(32)	Privilege on the object
GRANTABLE	VARCHAR(3)	Indicates whether the privilege was granted with the GRANT OPTION (YES) or not (NO)
HIERARCHY	VARCHAR(3)	Indicates whether the privilege was granted with the HIERARCHY OPTION (YES) or not (NO)

ALL_TAB_PRIVS_MADE

ALL_TAB_PRIVS_MADE describes the object grants for which the current user is the object owner or grantor.

Table 9-46 Column information

Column name	Data type	Description
GRANTEE	VARCHAR(128)	Name of the user or role to whom access was granted
OWNER	VARCHAR(128)	Owner of the object
TABLE_SCHEMA	VARCHAR(128)	Schema of the object
TABLE_NAME	VARCHAR(128)	Name of the object
GRANTOR	VARCHAR(128)	Name of the user who performed the grant
PRIVILEGE	VARCHAR(32)	Privilege on the object
GRANTABLE	VARCHAR(3)	Indicates whether the privilege was granted with the GRANT OPTION (YES) or not (NO)
HIERARCHY	VARCHAR(3)	Indicates whether the privilege was granted with the HIERARCHY OPTION (YES) or not (NO)

ALL_TAB_PRIVS_RECD

ALL_TAB_PRIVS_RECD describes object grants, for which the current user is the grantee, or for which an enabled role or PUBLIC is the grantee.

Table 9-47 Column information

Column name	Data type	Description
GRANTEE	VARCHAR(128)	Name of the user or role to whom access was granted
OWNER	VARCHAR(128)	Owner of the object
TABLE_SCHEMA	VARCHAR(128)	Schema of the object
TABLE_NAME	VARCHAR(128)	Name of the object
GRANTOR	VARCHAR(128)	Name of the user who performed the grant
PRIVILEGE	VARCHAR(32)	Privilege on the object
GRANTABLE	VARCHAR(3)	Indicates whether the privilege was granted with the GRANT OPTION (YES) or not (NO)
HIERARCHY	VARCHAR(3)	Indicates whether the privilege was granted with the HIERARCHY OPTION (YES) or not (NO)

ALL_TBS_PRIVS

ALL_TBS_PRIVS describes the tablespace grants, for which the current user is the grantor, or grantee, or for which an enabled role or PUBLIC is the grantee.

Table 9-48 Column information

Column name	Data type	Description
GRANTOR	VARCHAR(128)	Name of the user who performed the grant
GRANTEE	VARCHAR(128)	Name of the user or role to whom access was granted
TABLESPACE_NAME	VARCHAR(128)	Name of the tablespace
PRIVILEGE	VARCHAR(32)	Privilege on the tablespace
GRANTABLE	VARCHAR(3)	Indicates whether the privilege was granted with the GRANT OPTION (YES) or not (NO)

ALL_TBS_PRIVS_MADE

ALL_TBS_PRIVS_MADE describes the tablespace grants for which the current user is the grantor.

Table 9-49 Column information

Column name	Data type	Description
GRANTOR	VARCHAR(128)	Name of the user who performed the grant
GRANTEE	VARCHAR(128)	Name of the user or role to whom access was granted
TABLESPACE_NAME	VARCHAR(128)	Name of the tablespace
PRIVILEGE	VARCHAR(32)	Privilege on the tablespace
GRANTABLE	VARCHAR(3)	Indicates whether the privilege was granted with the GRANT OPTION (YES) or not (NO)

ALL_TBS_PRIVS_REC'D

ALL_TBS_PRIVS_REC'D describes the tablespace grants, for which the current user is the grantee, or for which an enabled role or PUBLIC is the grantee.

Table 9-50 Column information

Column name	Data type	Description
GRANTOR	VARCHAR(128)	Name of the user who performed the grant
GRANTEE	VARCHAR(128)	Name of the user or role to whom access was granted
TABLESPACE_NAME	VARCHAR(128)	Name of the tablespace
PRIVILEGE	VARCHAR(32)	Privilege on the tablespace
GRANTABLE	VARCHAR(3)	Indicates whether the privilege was granted with the GRANT OPTION (YES) or not (NO)

ALL_USERS

ALL_USERS lists all users of the database visible to the current user.

Table 9-51 Column information

Column name	Data type	Description
USERNAME	VARCHAR(128)	Name of the user
USER_ID	NUMBER	ID number of the user
CREATED	TIMESTAMP(2) WITHOUT TIME ZONE	User creation timestamp

ALL_VIEWS

ALL_VIEWS describes the views accessible to the current user.

Table 9-52 Column information

Column name	Data type	Description
OWNER	VARCHAR(128)	Owner of the view
VIEW_SCHEMA	VARCHAR(128)	Schema of the view
VIEW_NAME	VARCHAR(128)	Name of the view
TEXT_LENGTH	NUMBER	Length of the view text
TEXT	LONG VARCHAR	View text
TYPE_TEXT_LENGTH	NUMBER	<ul style="list-style-type: none"> reserved Length of the type clause of the typed view
TYPE_TEXT	VARCHAR(4000)	<ul style="list-style-type: none"> reserved Type clause of the typed view
OID_TEXT_LENGTH	NUMBER	<ul style="list-style-type: none"> reserved Length of the WITH OID clause of the typed view
OID_TEXT	VARCHAR(4000)	<ul style="list-style-type: none"> reserved WITH OID clause of the typed view
VIEW_TYPE_OWNER	VARCHAR(128)	<ul style="list-style-type: none"> reserved Owner of the type of the view if the view is a typed view
VIEW_TYPE	VARCHAR(32)	<ul style="list-style-type: none"> reserved Type of the view if the view is a typed view
SUPERVIEW_NAME	VARCHAR(128)	<ul style="list-style-type: none"> reserved Name of the superview
EDITIONING_VIEW	VARCHAR(1)	<ul style="list-style-type: none"> reserved Reserved for future use
READ_ONLY	VARCHAR(1)	Indicates whether the view is read-only (Y) or not (N)

Views of DBA_family

The current user has DBA privileges (ACCESS CONTROL ON DATABASE), and the user can retrieve information about all objects.

DBA_ALL_TABLES

DBA_ALL_TABLES describes all object tables and relational tables in the database.

Table 9-53 Column information

Column name	Data type	Description
OWNER	VARCHAR(128)	Owner of the table
TABLE_SCHEMA	VARCHAR(128)	Schema of the table
TABLE_NAME	VARCHAR(128)	Name of the table
TABLESPACE_NAME	VARCHAR(128)	Name of the tablespace containing the table
CLUSTER_NAME	VARCHAR(128)	<ul style="list-style-type: none"> reserved Name of the cluster
IOT_NAME	VARCHAR(128)	<ul style="list-style-type: none"> reserved Name of the index-organized table
STATUS	VARCHAR(32)	<ul style="list-style-type: none"> reserved If a previous DROP TABLE operation failed, indicates whether the table is unusable (UNUSABLE) or valid (VALID)
PCT_FREE	NUMBER	Minimum percentage of free space in a block
PCT_USED	NUMBER	Minimum percentage of used space in a block
INI_TRANS	NUMBER	Initial number of transactions
MAX_TRANS	NUMBER	Maximum number of transactions
INITIAL_EXTENT	NUMBER	Size of the initial extent (in bytes)
NEXT_EXTENT	NUMBER	Size of secondary extents (in bytes)
MIN_EXTENTS	NUMBER	Minimum number of extents allowed in the segment
MAX_EXTENTS	NUMBER	Maximum number of extents allowed in the segment
PCT_INCREASE	NUMBER	<ul style="list-style-type: none"> reserved Percentage increase in extent size
FREELISTS	NUMBER	<ul style="list-style-type: none"> reserved Number of process freelists allocated to the segment
FREELIST_GROUPS	NUMBER	<ul style="list-style-type: none"> reserved Number of freelist groups allocated to the segment
LOGGING	VARCHAR(3)	Indicates whether or not changes to the table are logged
BACKED_UP	VARCHAR(1)	<ul style="list-style-type: none"> reserved Indicates whether the table has been backed up since the last modification

Column name	Data type	Description
		(Y) or not (N)
NUM_ROWS	NUMBER	Number of rows in the table
BLOCKS	NUMBER	<ul style="list-style-type: none"> reserved Number of used blocks in the table
EMPTY_BLOCKS	NUMBER	<ul style="list-style-type: none"> reserved Number of empty (never used) blocks in the table
AVG_SPACE	NUMBER	<ul style="list-style-type: none"> reserved Average available free space in the table
CHAIN_CNT	NUMBER	<ul style="list-style-type: none"> reserved Number of rows in the table that are chained from one data block to another or that have migrated to a new block, requiring a link to preserve the old rowid
AVG_ROW_LEN	NUMBER	<ul style="list-style-type: none"> reserved Average row length, including row overhead
AVG_SPACE_FREELIST_BLOCKS	NUMBER	<ul style="list-style-type: none"> reserved Average freespace of all blocks on a freelist
NUM_FREELIST_BLOCKS	NUMBER	<ul style="list-style-type: none"> reserved Number of blocks on the freelist
DEGREE	VARCHAR(32)	<ul style="list-style-type: none"> reserved Number of threads per instance for scanning the table, or DEFAULT
INSTANCES	VARCHAR(32)	<ul style="list-style-type: none"> reserved Number of instances across which the table is to be scanned, or DEFAULT
CACHE	VARCHAR(1)	<ul style="list-style-type: none"> reserved Indicates whether the table is to be cached in the buffer cache (Y) or not (N)
TABLE_LOCK	VARCHAR(32)	Indicates whether table locking is enabled (ENABLED) or disabled (DISABLED)
SAMPLE_SIZE	NUMBER	Sample size used in analyzing the table
LAST_ANALYZED	TIMESTAMP(6) WITHOUT TIME ZONE	Date on which the table was most recently analyzed
PARTITIONED	VARCHAR(3)	<ul style="list-style-type: none"> reserved Indicates whether the table is partitioned (YES) or not (NO)
IOT_TYPE	VARCHAR(32)	<ul style="list-style-type: none"> reserved If the table is an index-organized table, then IOT_TYPE is IOT, IOT_OVERFLOW, or IOT_MAPPING.
OBJECT_ID_TYPE	VARCHAR(32)	<ul style="list-style-type: none"> reserved Indicates whether the object ID (OID) is USER-DEFINED or SYSTEM GENERATED
TABLE_TYPE_OWNER	VARCHAR(128)	<ul style="list-style-type: none"> reserved If an object table, owner of the type from which the table is created

Column name	Data type	Description
TABLE_TYPE	VARCHAR(128)	<ul style="list-style-type: none"> reserved If an object table, type of the table
TEMPORARY	VARCHAR(1)	Indicates whether the table is temporary (Y) or not (N)
SECONDARY	VARCHAR(1)	<ul style="list-style-type: none"> reserved Indicates whether the table is a secondary object created by cartridge
NESTED	VARCHAR(3)	<ul style="list-style-type: none"> reserved Indicates whether the table is a nested table (YES) or not (NO)
BUFFER_POOL	VARCHAR(32)	<ul style="list-style-type: none"> reserved Buffer pool to be used for table blocks
FLASH_CACHE	VARCHAR(32)	<ul style="list-style-type: none"> reserved Database Smart Flash Cache hint to be used for table blocks
CELL_FLASH_CACHE	VARCHAR(32)	<ul style="list-style-type: none"> reserved Cell flash cache hint to be used for table blocks
ROW_MOVEMENT	VARCHAR(32)	<ul style="list-style-type: none"> reserved If a partitioned table, indicates whether row movement is enabled (ENABLED) or disabled (DISABLED)
GLOBAL_STATS	VARCHAR(3)	<ul style="list-style-type: none"> reserved For partitioned tables, indicates whether statistics for the table as a whole (global statistics) are accurate (YES)
USER_STATS	VARCHAR(3)	<ul style="list-style-type: none"> reserved Indicates whether statistics were entered directly by the user (YES) or not (NO)
DURATION	VARCHAR(32)	<ul style="list-style-type: none"> reserved Indicates the duration of a temporary table
SKIP_CORRUPT	VARCHAR(32)	<ul style="list-style-type: none"> reserved Indicates whether Database ignores blocks marked corrupt during table and index scans (ENABLED) or raises an error (DISABLED)
MONITORING	VARCHAR(3)	<ul style="list-style-type: none"> reserved Indicates whether the table has the MONITORING attribute set (YES) or not (NO)
CLUSTER_OWNER	VARCHAR(128)	<ul style="list-style-type: none"> reserved Owner of the cluster, if any
DEPENDENCIES	VARCHAR(32)	<ul style="list-style-type: none"> reserved Indicates whether row-level dependency tracking is enabled (ENABLED) or disabled (DISABLED)
COMPRESSION	VARCHAR(32)	<ul style="list-style-type: none"> reserved Indicates whether table compression is enabled (ENABLED) or not (DISABLED)
COMPRESS_FOR	VARCHAR(32)	<ul style="list-style-type: none"> reserved Default compression for what kind of operations
		<ul style="list-style-type: none"> reserved

Column name	Data type	Description
DROPPED	VARCHAR(3)	Indicates whether the table has been dropped and is in the recycle bin (YES) or not (NO)
READ_ONLY	VARCHAR(3)	Indicates whether the table IS READ-ONLY (YES) or not (NO)
SEGMENT_CREA TED	VARCHAR(3)	Indicates whether the table segment has been created (YES) or not (NO)

DBA_ARGUMENTS

DBA_ARGUMENTS lists all arguments of functions, procedures.

Table 9-54 Column information

Column name	Data type	Description
OWNER	VARCHAR(128)	Owner of function, procedures or package
SCHEMA_NAME	VARCHAR(128)	Schema Name of function, procedures or package
OBJECT_NAME	VARCHAR(128)	Name of function, procedures
PACKAGE_NAME	VARCHAR(128)	Package Name of function, procedures
OBJECT_ID	NUMBER	ID of a function, procedures
SUBPROGRAM_ID	NUMBER	ID of procedures in package
ARGUMENT_NAME	VARCHAR(128)	Name of argument or attribute name of record type argument
POSITION	NUMBER	Position of argument or position of attribute in record type
SEQUENCE	NUMBER	Sequential order of argument and its attributes
DATA_LEVEL	NUMBER	Nesting depth of the argument for composite types
DATA_TYPE	VARCHAR(128)	Data type of the argument
DEFAULTED	VARCHAR(1)	Whether or not the argument is defaulted
DEFAULT_VALUE	VARCHAR(1)	Reserved for future use
DEFAULT_LENGTH	VARCHAR(1)	Reserved for future use
IN_OUT	VARCHAR(32)	Direction of the argument (IN, OUT, IN/OUT)
DATA_LENGTH	NUMBER	Length of the column(in bytes)
DATA_PRECISION	NUMBER	Length in decimal digits(NUMBER) or binary digits(FLOAT)
DATA_SCALE	NUMBER	Digits to the right of the decimal point in a number
RADIX	NUMBER	Argument radix for a number
CHARACTER_SET_NAME	VARCHAR(128)	Character set name for the argument
TYPE_OWNER	VARCHAR(128)	Owner of the type of the argument
TYPE_NAME	VARCHAR(128)	Name of the type of the argument
TYPE_SUBNAME	VARCHAR(128)	Name of the type of the argument declared in package
TYPE_LINK	VARCHAR(128)	Name of the type of the argument declared in a remote package
PLS_TYPE	VARCHAR(128)	Name of the type of the argument at PSM
CHAR_LENGTH	NUMBER	Character limit for string datatypes
CHAR_USED	VARCHAR(1)	Whether the byte limit(B) or char limit(C) is official for the string
ORIGIN_CON_ID	VARCHAR(256)	ID of the container where the data originates

DBA_CATALOG

DBA_CATALOG lists all tables, views, synonyms, and sequences in the database.

Table 9-55 Column information

Column name	Data type	Description
OWNER	VARCHAR(128)	Owner of the TABLE, VIEW, SYNONYM, SEQUENCE, or UNDEFINED
TABLE_SCHEMA	VARCHAR(128)	Schema of the TABLE, VIEW, SYNONYM, SEQUENCE, or UNDEFINED
TABLE_NAME	VARCHAR(128)	Name of the TABLE, VIEW, SYNONYM, SEQUENCE, or UNDEFINED
TABLE_TYPE	VARCHAR(32)	Type of the TABLE, VIEW, SYNONYM, SEQUENCE, or UNDEFINED

DBA_CLUSTER

DBA_CLUSTER describes all cluster members in the cluster system.



It is available only on a cluster.

Table 9-56 Column information

Column name	Data type	Description
GROUP_ID	NUMBER	Group identifier of the cluster member
GROUP_NAME	VARCHAR(128)	Group name of the cluster member
MEMBER_ID	NUMBER	Member identifier of the cluster member
MEMBER_NAME	VARCHAR(128)	Member name of the cluster member
MEMBER_HOST	VARCHAR(128)	Host address of the cluster member
MEMBER_PORT	NUMBER	Port number of the cluster member

DBA_CLUSTER_COMMENTS

DBA_CLUSTER_COMMENTS displays comments on the cluster objects in the cluster system.



It is available only on a cluster.

Table 9-57 Column information

Column name	Data type	Description
OBJECT_NAME	VARCHAR(128)	Name of the cluster object
OBJECT_TYPE	VARCHAR(32)	Type of the cluster object: CLUSTER GROUP, CLUSTER MEMBER
COMMENTS	VARCHAR(1024)	Comment on the cluster object

DBA_CLUSTER_TABLES

DBA_CLUSTER_TABLES describes all cluster tables in the cluster system.



It is available only on a cluster.

Table 9-58 Column information

Column name	Data type	Description
OWNER	VARCHAR(128)	Owner of the table
TABLE_SCHEMA	VARCHAR(128)	Schema of the table
TABLE_NAME	VARCHAR(128)	Name of the table
SHARD_STRATEGY	VARCHAR(32)	Sharding strategy of the table: the value in (CLONED, HASH SHARDING, RANGE SHARDING, LIST S HARDING)
SHARD_PLACEMENT	VARCHAR(32)	Shard placement of the table: the value in (AT CLUSTER WIDE or AT CLUSTER GROUP)
SHARD_COUNT	NUMBER	Shard count of the table (if cloned table, the value is null)
SHARD_KEY_COUNT	NUMBER	Shard key column count of the table (if cloned table, the value is nul l)
HAS_GSI	VARCHAR(3)	Indicate whether the table has global secondary index: (YES) or (NO)

DBA_COL_COMMENTS

DBA_COL_COMMENTS displays comments on the columns of all tables and views in the database.

Table 9-59 Column information

Column name	Data type	Description
OWNER	VARCHAR(128)	Owner of the object
TABLE_SCHEMA	VARCHAR(128)	Schema of the object
TABLE_NAME	VARCHAR(128)	Name of the object
COLUMN_NAME	VARCHAR(128)	Name of the column
COMMENTS	VARCHAR(1024)	Comment on the column

DBA_COL_PRIVS

DBA_COL_PRIVS describes all column object grants in the database.

Table 9-60 Column information

Column name	Data type	Description
GRANTOR	CHARACTER VARYING(128)	Name of the user who performed the grant
GRANTEE	CHARACTER VARYING(128)	Name of the user or role to whom access was granted
OWNER	CHARACTER VARYING(128)	Owner of the object
TABLE_SCHEMA	CHARACTER VARYING(128)	Schema of the object
TABLE_NAME	CHARACTER VARYING(128)	Name of the object
COLUMN_NAME	CHARACTER VARYING(128)	Name of the column
PRIVILEGE	CHARACTER VARYING(32)	Privilege on the column
GRANTABLE	CHARACTER VARYING(3)	Indicates whether the privilege was granted with the GRANT OPTION (YES) or not (NO)

DBA_CONSTRAINTS

DBA_CONSTRAINTS describes all constraint definitions on all tables in the database.

Table 9-61 Column information

Column name	Data type	Description
OWNER	VARCHAR(128)	Owner of the constraint definition
CONSTRAINT_SCHEMA	VARCHAR(128)	Schema of the constraint definition
CONSTRAINT_NAME	VARCHAR(128)	Name of the constraint definition
CONSTRAINT_TYPE	VARCHAR(1)	Type of the constraint definition: the value in (C: check constraint, P: Primary key, U: Unique Key, R: Referential integrity)
TABLE_OWNER	VARCHAR(128)	Owner of the table (or view) associated with the constraint definition
TABLE_SCHEMA	VARCHAR(128)	Schema of the table (or view) associated with the constraint definition
TABLE_NAME	VARCHAR(128)	Name of the table (or view) associated with the constraint definition
SEARCH_CONDITION	LONG VARCHAR	Text of search condition for a check constraint
R_OWNER	VARCHAR(128)	Owner of the unique constraint definition for the referenced table
R_SCHEMA	VARCHAR(128)	Schema of the unique constraint definition for the referenced table
R_CONSTRAINT_NAME	VARCHAR(128)	Name of the unique constraint definition for the referenced table
DELETE_RULE	VARCHAR(32)	Delete rule for a referential constraint: the value in (NO ACTION, RESTRICT, CASCADE, SET NULL, SET DEFAULT)
UPDATE_RULE	VARCHAR(32)	Update rule for a referential constraint: the value in (NO ACTION, RESTRICT, CASCADE, SET NULL, SET DEFAULT)
STATUS	VARCHAR(32)	Enforcement status of the constraint: the value in (ENABLED, DISABLE)
DEFERRABLE	VARCHAR(32)	Indicates whether the constraint is deferrable (DEFERRABLE) or not (NOT DEFERRABLE)
DEFERRED	VARCHAR(32)	Indicates whether the constraint was initially deferred (DEFERRED) or not (IMMEDIATE)
VALIDATED	VARCHAR(32)	Indicates whether all data may obey the constraint or not: the value in (VALIDATED, NOT VALIDATED)
GENERATED	VARCHAR(32)	Indicates whether the name of the constraint is user-generated (USER NAME) or system-generated (GENERATED NAME)
BAD	VARCHAR(32)	<ul style="list-style-type: none"> reserved Indicates whether this constraint specifies a century in an ambiguous manner (BAD) or not (NULL)
RELY	VARCHAR(32)	<ul style="list-style-type: none"> reserved When NOT VALIDATED, indicates whether the constraint is to be taken into account for query rewrite (RELY) or not (NULL)
	TIMESTAMP(2) WITH	

Column name	Data type	Description
LAST_CHANGE	OUT TIME ZONE	When the constraint was last enabled or disabled
INDEX_OWNER	VARCHAR(128)	Owner of the index associated with the key constraint
INDEX_SCHEMA	VARCHAR(128)	Schema of the index associated with the key constraint
INDEX_NAME	VARCHAR(128)	Name of the index associated with the key constraint
INVALID	VARCHAR(32)	Indicates whether the constraint is invalid (INVALID) or not (NULL)
VIEW_RELATED	VARCHAR(32)	<ul style="list-style-type: none"> reserved Indicates whether the constraint depends on a view (DEPEND ON VIEW) or not (NULL)
COMMENTS	VARCHAR(1024)	Comments of the constraint definition

DBA_CONS_COLUMNS

DBA_CONS_COLUMNS describes all columns in the database that are specified in constraints.

Table 9-62 Column information

Column name	Data type	Description
OWNER	VARCHAR(128)	Owner of the constraint definition
CONSTRAINT_SCHEMA	VARCHAR(128)	Schema of the constraint definition
CONSTRAINT_NAME	VARCHAR(128)	Name of the constraint definition
TABLE_OWNER	VARCHAR(128)	Owner of the table with the constraint definition
TABLE_SCHEMA	VARCHAR(128)	Schema of the table with the constraint definition
TABLE_NAME	VARCHAR(128)	Name of the table with the constraint definition
COLUMN_NAME	VARCHAR(128)	Name of the column or attribute of the object type column specified in the constraint definition
POSITION	NUMBER	Original position of the column or attribute in the definition of the object

DBA_DB_PRIVS

DBA_DB_PRIVS describes all database grants in the database.

Table 9-63 Column information

Column name	Data type	Description
GRANTOR	VARCHAR(128)	Name of the user who performed the grant
GRANTEE	VARCHAR(128)	Name of the user or role to whom access was granted
PRIVILEGE	VARCHAR(32)	Privilege on the database
GRANTABLE	VARCHAR(3)	Indicates whether the privilege was granted with the GRANT OPTION (YES) or not (NO)

DBA_DEPENDENCIES

DBA_DEPENDENCIES describes all dependencies between objects in the database

Table 9-64 Column information

Column name	Data type	Description
OWNER	VARCHAR(128)	Owner of object
SCHEMA_NAME	VARCHAR(128)	Schema Name of object
NAME	VARCHAR(128)	Name of object
TYPE	VARCHAR(32)	Type of object: FUNCTION, PROCEDURE, VIEW, PACKAGE, PACKAGE BODY, TRIGGER
REFERENCED_OWNER	VARCHAR(128)	Owner of the referenced object
REFERENCED_SCHEMA_NAME	VARCHAR(128)	Schema Name of the referenced object
REFERENCED_TYPE	VARCHAR(32)	Type of the referenced object: FUNCTION, PROCEDURE, TABLE, VIEW, SEQUENCE, PACKAGE, PACKAGE BODY, TRIGGER
REFERENCED_LINK_NAME	VARCHAR(128)	Name of the link to the parent object
REFERENCED_NAME	VARCHAR(128)	Name of the referenced object
DEPENDENCY_TYPE	VARCHAR(32)	Indicates whether the dependency is a REF dependency (REF) or not (HARD)

DBA_EXTENTS

DBA_EXTENTS describes the extents comprising the segments in all tablespaces in the database.

Table 9-65 Column information

Column name	Data type	Description
OWNER	VARCHAR(128)	Owner of the segment associated with the extent
SEGMENT_SCHEMA	VARCHAR(128)	Schema of the segment associated with the extent
SEGMENT_NAME	VARCHAR(128)	Name of the segment associated with the extent
PARTITION_NAME	VARCHAR(128)	<ul style="list-style-type: none"> reserved Object Partition Name (Set to NULL for non-partitioned objects)
SEGMENT_TYPE	VARCHAR(32)	Type of the segment: TABLE, INDEX
TABLESPACE_NAME	VARCHAR(128)	Name of the tablespace containing the extent
EXTENT_ID	NUMBER	<ul style="list-style-type: none"> reserved Extent number in the segment
FILE_ID	NUMBER	<ul style="list-style-type: none"> reserved File identifier number of the file containing the extent
BLOCK_ID	NUMBER	<ul style="list-style-type: none"> reserved Starting block number of the extent
BYTES	NUMBER	Size of the extent in bytes
BLOCKS	NUMBER	Size of the extent in Oracle blocks
RELATIVE_FNO	NUMBER	<ul style="list-style-type: none"> reserved Relative file number of the first extent block

DBA_GLOBAL_SECONDARY_INDEXES

DBA_GLOBAL_SECONDARY_INDEXES describes all global secondary indexes in the database.



It is available only on a cluster.

Table 9-66 Column information

Column name	Data type	Description
TABLE_OWNER	VARCHAR(128)	Owner of the global secondary indexed object
TABLE_SCHEMA	VARCHAR(128)	Schema of the global secondary indexed object
TABLE_NAME	VARCHAR(128)	Name of the global secondary indexed object
TABLESPACE_NAME	VARCHAR(128)	Name of the tablespace containing the global secondary index
INI_TRANS	NUMBER	Initial number of transactions
MAX_TRANS	NUMBER	Maximum number of transactions
INITIAL_EXTENT	NUMBER	Size of the initial extent
NEXT_EXTENT	NUMBER	Size of secondary extents
MIN_EXTENTS	NUMBER	Minimum number of extents allowed in the segment
MAX_EXTENTS	NUMBER	Maximum number of extents allowed in the segment
PCT_FREE	NUMBER	Minimum percentage of free space in a block
LOGGING	VARCHAR(3)	Indicates whether or not changes to the global secondary index are logged: (YES) or (NO)
BLOCKS	NUMBER	Number of used blocks in the global secondary index

DBA_GSI_PLACE

DBA_GSI_PLACE describes node placement of all global secondary indexes in the cluster system.



It is available only on a cluster.

Table 9-67 Column information

Column name	Data type	Description
TABLE_OWNER	VARCHAR(128)	Owner of the global secondary indexed object
TABLE_SCHEMA	VARCHAR(128)	Schema of the global secondary indexed object
TABLE_NAME	VARCHAR(128)	Name of the global secondary indexed object
GROUP_ID	NUMBER	Group identifier of the node where the global secondary index placed
GROUP_NAME	VARCHAR(128)	Group name of the node where the global secondary index placed
MEMBER_ID	NUMBER	Member identifier of the node where the global secondary index placed
MEMBER_NAME	VARCHAR(128)	Member name of the node where the global secondary index placed
MEMBER_OFFLINE	BOOLEAN	data of the cluster member is offline or not
BLOCKS	NUMBER	Number of used blocks of the node where the global secondary index placed

DBA_INDEXES

DBA_INDEXES describes all indexes in the database.

Table 9-68 Column information

Column name	Data type	Description
OWNER	VARCHAR(128)	Owner of the index
INDEX_SCHEMA	VARCHAR(128)	Schema of the index
INDEX_NAME	VARCHAR(128)	Name of the index
INDEX_TYPE	VARCHAR(32)	Type of the index: the value in (NORMAL, NORMAL/REV, BITMAP, FUNCTION-BASED NORMAL, FUNCTION-BASED NORMAL/REV, FUNCTION-BASED BITMAP, IOT - TOP, DOMAIN)
TABLE_OWNER	VARCHAR(128)	Owner of the indexed object
TABLE_SCHEMA	VARCHAR(128)	Schema of the indexed object
TABLE_NAME	VARCHAR(128)	Name of the indexed object
TABLE_TYPE	VARCHAR(32)	Type of the indexed object: the value in (NEXT OBJECT, INDEX, TABLE, VIEW, SYNONYM, SEQUENCE)
UNIQUENESS	VARCHAR(32)	Indicates whether the index is unique (UNIQUE) or nonunique (NON UNIQUE)
COMPRESSION	VARCHAR(32)	<ul style="list-style-type: none"> reserved Indicates whether index compression is enabled (ENABLED) or not (DISABLED)
PREFIX_LENGTH	NUMBER	<ul style="list-style-type: none"> reserved Number of columns in the prefix of the compression key
TABLESPACE_NAME	VARCHAR(128)	Name of the tablespace containing the index
INI_TRANS	NUMBER	Initial number of transactions
MAX_TRANS	NUMBER	Maximum number of transactions
INITIAL_EXTENT	NUMBER	Size of the initial extent
NEXT_EXTENT	NUMBER	Size of secondary extents
MIN_EXTENTS	NUMBER	Minimum number of extents allowed in the segment
MAX_EXTENTS	NUMBER	Maximum number of extents allowed in the segment
PCT_INCREASE	NUMBER	<ul style="list-style-type: none"> reserved Percentage increase in extent size
PCT_THRESHOLD	NUMBER	<ul style="list-style-type: none"> reserved Threshold percentage of block space allowed per index entry
INCLUDE_COLUMN	NUMBER	<ul style="list-style-type: none"> reserved Column ID of the last column to be included in index-organized table primary key (non-overflow) index
FREELISTS	NUMBER	<ul style="list-style-type: none"> reserved Number of process freelists allocated to this segment
FREELIST_GROUPS	NUMBER	<ul style="list-style-type: none"> reserved Number of freelist groups allocated to this segment

Column name	Data type	Description
PCT_FREE	NUMBER	Minimum percentage of free space in a block
LOGGING	VARCHAR(3)	Indicates whether or not changes to the index are logged: (YES) or (NO)
BLOCKS	NUMBER	Number of used blocks in the index
BLEVEL	NUMBER	<ul style="list-style-type: none"> reserved B-Tree level (depth of the index from its root block to its leaf blocks)
LEAF_BLOCKS	NUMBER	<ul style="list-style-type: none"> reserved Number of leaf blocks in the index
DISTINCT_KEYS	NUMBER	Number of distinct indexed values.
AVG_LEAF_BLOCKS_PER_KEY	NUMBER	<ul style="list-style-type: none"> reserved Average number of leaf blocks in which each distinct value in the index appears, rounded to the nearest integer
AVG_DATA_BLOCKS_PER_KEY	NUMBER	<ul style="list-style-type: none"> reserved Average number of data blocks in the table that are pointed to by a distinct value in the index rounded to the nearest integer
CLUSTERING_FACTOR	NUMBER	<ul style="list-style-type: none"> reserved Indicates the amount of order of the rows in the table based on the values of the index
STATUS	VARCHAR(32)	<ul style="list-style-type: none"> reserved Indicates whether a nonpartitioned index is VALID or UNUSABLE
NUM_ROWS	NUMBER	<ul style="list-style-type: none"> reserved Number of rows in the index
SAMPLE_SIZE	NUMBER	Size of the sample used to analyze the index
LAST_ANALYZED	TIMESTAMP(6) WITH OUT TIME ZONE	Date on which this index was most recently analyzed
DEGREE	VARCHAR(32)	<ul style="list-style-type: none"> reserved Number of threads per instance for scanning the index, or DEFAULT
INSTANCES	VARCHAR(32)	<ul style="list-style-type: none"> reserved Number of instances across which the indexes to be scanned, or DEFAULT
PARTITIONED	VARCHAR(3)	<ul style="list-style-type: none"> reserved Indicates whether the index is partitioned (YES) or not (NO)
TEMPORARY	VARCHAR(1)	Indicates whether the index is on a temporary table (Y) or not (N)
GENERATED	VARCHAR(1)	Indicates whether the name of the index is system-generated (Y) or not (N)
SECONDARY	VARCHAR(1)	<ul style="list-style-type: none"> reserved Indicates whether the index is a secondary object created by the method of the Data Cartridge (Y) or not (N)
		<ul style="list-style-type: none"> reserved

Column name	Data type	Description
BUFFER_POOL	VARCHAR(32)	Buffer pool to be used for index blocks
FLASH_CACHE	VARCHAR(32)	<ul style="list-style-type: none"> reserved Database Smart Flash Cache hint to be used for index blocks
CELL_FLASH_CACHE	VARCHAR(32)	<ul style="list-style-type: none"> reserved Cell flash cache hint to be used for index blocks
USER_STATS	VARCHAR(3)	<ul style="list-style-type: none"> reserved Indicates whether statistics were entered directly by the user (YES) or not (NO)
DURATION	VARCHAR(32)	<ul style="list-style-type: none"> reserved Indicates the duration of a temporary table
PCT_DIRECT_ACCESS	NUMBER	<ul style="list-style-type: none"> reserved For a secondary index on an index-organized table, the percentage of rows with VALID guess
ITYP_OWNER	VARCHAR(128)	<ul style="list-style-type: none"> reserved For a domain index, the owner of the indextype
ITYP_NAME	VARCHAR(128)	<ul style="list-style-type: none"> reserved For a domain index, the name of the indextype
PARAMETERS	VARCHAR(1024)	<ul style="list-style-type: none"> reserved For a domain index, the parameter string
GLOBAL_STATS	VARCHAR(3)	<ul style="list-style-type: none"> reserved For partitioned indexes, indicates whether statistics were collected by analyzing the index as a whole (YES) or were estimated from statistics on underlying index partitions and subpartitions (NO)
DOMIDX_STATUS	VARCHAR(32)	<ul style="list-style-type: none"> reserved Status of a domain index
DOMIDX_OPSTATUS	VARCHAR(32)	<ul style="list-style-type: none"> reserved Status of the operation on a domain index
FUNCIDX_STATUS	VARCHAR(32)	<ul style="list-style-type: none"> reserved Status of a function-based index
JOIN_INDEX	VARCHAR(3)	<ul style="list-style-type: none"> reserved Indicates whether the index is a join index (YES) or not (NO)
IOT_REDUNDANT_PKEY_ELIM	VARCHAR(3)	<ul style="list-style-type: none"> reserved Indicates whether redundant primary key columns are eliminated from secondary indexes on index-organized tables (YES) or not (NO)
DROPPED	VARCHAR(3)	<ul style="list-style-type: none"> reserved Indicates whether the index has been dropped and is in the recycle bin (YES) or not (NO)
VISIBILITY	VARCHAR(3)	<ul style="list-style-type: none"> reserved Indicates whether the index is VISIBLE or INVISIBLE to the optimizer
DOMIDX_MANAGE		<ul style="list-style-type: none"> reserved If this is a domain index, indicates whether the domain index is syst

Column name	Data type	Description
MENT	VARCHAR(32)	em-managed (SYSTEM_MANAGED) or user-managed (USER_MANAGED)
SEGMENT_CREATED	VARCHAR(3)	Indicates whether the index segment has been created (YES) or not (NO)
COMMENTS	VARCHAR(1024)	Comments of the index
EMPTY_BLOCKS	NUMBER	Number of empty blocks in the index

DBA_IND_COLUMNS

DBA_IND_COLUMNS describes the columns of all the indexes on all tables and clusters in the database.

Table 9-69 Column information

Column name	Data type	Description
INDEX_OWNER	VARCHAR(128)	Owner of the index
INDEX_SCHEMA	VARCHAR(128)	Schema of the index
INDEX_NAME	VARCHAR(128)	Name of the index
TABLE_OWNER	VARCHAR(128)	Owner of the table or cluster
TABLE_SCHEMA	VARCHAR(128)	Schema of the table or cluster
TABLE_NAME	VARCHAR(128)	Name of the table or cluster
COLUMN_NAME	VARCHAR(128)	Column name or attribute of the object type column
COLUMN_POSITION	NUMBER	Position of the column or attribute within the index
COLUMN_LENGTH	NUMBER	Indexed length of the column
CHAR_LENGTH	NUMBER	<ul style="list-style-type: none"> reserved Maximum codepoint length of the column
DESCEND	VARCHAR(32)	Indicates whether the column is sorted in descending order (DESC) or ascending order (ASC)
NULL_ORDER	VARCHAR(32)	Indicates whether the null value of the column is sorted in nulls first order (NULLS FIRST) or nulls last order (NULLS LAST)

DBA_IND_PLACE

DBA_IND_PLACE describes node placement of all indexes in the cluster system.



It is available only on a cluster.

Table 9-70 Column information

Column name	Data type	Description
OWNER	VARCHAR(128)	Owner of the index
INDEX_SCHEMA	VARCHAR(128)	Schema of the index
INDEX_NAME	VARCHAR(128)	Name of the index
TABLE_OWNER	VARCHAR(128)	Owner of the indexed object
TABLE_SCHEMA	VARCHAR(128)	Schema of the indexed object
TABLE_NAME	VARCHAR(128)	Name of the indexed object
GROUP_ID	NUMBER	Group identifier of the node where the index placed
GROUP_NAME	VARCHAR(128)	Group name of the node where the index placed
MEMBER_ID	NUMBER	Member identifier of the node where the index placed
MEMBER_NAME	VARCHAR(128)	Member name of the node where the index placed
MEMBER_OFFLINE	BOOLEAN	data of the cluster member is offline or not
DISTINCT_KEYS	NUMBER	(deprecated)
SAMPLE_SIZE	NUMBER	(deprecated)
BLOCKS	NUMBER	Number of used blocks of the node where the index placed
LAST_ANALYZED	TIMESTAMP(2) WITH OUT TIME ZONE	(deprecated)

DBA_NONSCHEMA_COMMENTS

DBA_NONSCHEMA_COMMENTS displays comments on all non-schema objects (database, authorizations, schemas, tablespaces).

Table 9-71 Column information

Column name	Data type	Description
OBJECT_NAME	VARCHAR(128)	Name of the non-schema object
OBJECT_TYPE	VARCHAR(32)	Type of the non-schema object: DATABASE, PROFILE, AUTHORIZATION, SCHEMA, TABLESPACE
COMMENTS	VARCHAR(1024)	Comments of the non-schema object

DBA_OBJECTS

DBA_OBJECTS describes all objects in the database.

Table 9-72 Column information

Column name	Data type	Description
OWNER	VARCHAR(128)	Owner of the object
SCHEMA_NAME	VARCHAR(128)	Schema of the object
OBJECT_NAME	VARCHAR(128)	Name of the object
SUBOBJECT_NAME	VARCHAR(128)	Name of the subobject (for example, partition)
OBJECT_ID	NUMBER	Dictionary object number of the object
DATA_OBJECT_ID	NUMBER	Dictionary object number of the segment that contains the object
OBJECT_TYPE	VARCHAR(32)	Type of the object (such as TABLE, INDEX)
CREATED	TIMESTAMP(2) WITH OUT TIME ZONE	Timestamp for the creation of the object
LAST_DDL_TIME	TIMESTAMP(2) WITH OUT TIME ZONE	Timestamp for the last modification of the object resulting from a DDL statement
TIMESTAMP	VARCHAR(32)	Timestamp for the specification of the object (character data)
STATUS	VARCHAR(32)	Status of the object: the value in (VALID, INVALID, N/A)
TEMPORARY	VARCHAR(1)	Indicates whether the object is temporary (the current session can see only data that it placed in this object itself) (Y) or not (N)
GENERATED	VARCHAR(1)	Indicates whether the name of this object was system-generated (Y) or not (N)
SECONDARY	VARCHAR(1)	Indicates whether this is a secondary object created by the ODCIIndexCreate method of the Oracle Data Cartridge (Y) or not (N)
NAMESPACE	NUMBER	Namespace for the object
EDITION_NAME	VARCHAR(128)	<ul style="list-style-type: none"> reserved Name of the edition in which the object is actual

DBA_PROCEDURES

DBA_PROCEDURES lists all function, procedures or pacakage

Table 9-73 Column information

Column name	Data type	Description
OWNER	VARCHAR(128)	Owner of function, procedures or pacakage
SCHEMA_NAME	VARCHAR(128)	Schema Name of function, procedures or package
OBJECT_NAME	VARCHAR(128)	Name of function, procedures or pacakage
PROCEDURE_NAME	VARCHAR(128)	Name when a procedures in pacakage
OBJECT_ID	NUMBER	ID of a function, procedures or pacakage
SUBPROGRAM_ID	NUMBER	ID of procedures in pacakage
OVERLOAD	VARCHAR(32)	ID of overloading procedure in pacakage
OBJECT_TYPE	VARCHAR(32)	Type of function, procedures or package
AGGREGATE	VARCHAR(3)	Indicate whether the procedure is an aggreage function(YES) or not (NO)
PIPELINED	VARCHAR(3)	Indicate whether the procedure is a pipelined table function(YES) or not(NO)
IMPLTYPEOWNER	VARCHAR(128)	Name of the owner of the implementation type, if any
IMPLTYPENAME	VARCHAR(128)	Name of the implementation type, if any
PARALLEL	VARCHAR(3)	Indicates whether the procedure or function is parallel-enabled (YES) or not (NO)
INTERFACE	VARCHAR(3)	YES, if the procedure/function is a table function implemented using the SQLCLI interface; otherwise NO
DETERMINISTIC	VARCHAR(3)	YES, if the procedure/function is declared to be deterministic; otherwise NO
AUTHID	VARCHAR(32)	Indicates whether the procedure/function is declared to execute as DEFINER or CURRENT_USER (invoker)

DBA_PROC_PRIVS

DBA_PROC_PRIVS describes the procedure grants, for which the current user is the procedure owner, grantor, or grantee, or for which an enabled role or PUBLIC is the grantee.

Table 9-74 Column information

Column name	Data type	Description
GRANTOR	VARCHAR(128)	Name of the user who performed the grant
GRANTEE	VARCHAR(128)	Name of the user or role to whom access was granted
PROCEDURE_OWNER	VARCHAR(128)	Owner of the procedure, function or package
PROCEDURE_SCHEMA	VARCHAR(128)	Schema of the procedure, function or package
PROCEDURE_NAME	VARCHAR(128)	Name of the procedure, function or package
PRIVILEGE	VARCHAR(32)	Privilege on the procedure, function or package
GRANTABLE	VARCHAR(3)	Indicates whether the privilege was granted with the GRANT OPTION (YES) or not (NO)

DBA_PROFILES

DBA_PROFILES displays all profiles and their limits.

Table 9-75 Column information

Column name	Data type	Description
PROFILE_NAME	VARCHAR(128)	Profile name
RESOURCE_NAME	VARCHAR(128)	Resource name
RESOURCE_TYPE	VARCHAR(32)	Indicates whether the resource profile is a KERNEL or a PASSWORD parameter
LIMIT_VALUE	LONG VARCHAR	Limit placed on this resource for this profile
COMMON	VARCHAR(3)	Indicates whether a given profile is common. (YES or NO)

DBA_SCHEMAS

Identify the schemata in the database.

Table 9-76 Column information

Column name	Data type	Description
SCHEMA_OWNER	VARCHAR(128)	Owner of the schema
SCHEMA_NAME	VARCHAR(128)	Name of the schema
CREATED_TIME	TIMESTAMP(2) WITHOUT TIME ZONE	Created time of the schema
MODIFIED_TIME	TIMESTAMP(2) WITHOUT TIME ZONE	Last modified time of the schema
COMMENTS	VARCHAR(1024)	Comments of the schema

DBA_SCHEMA_PATH

DBA_SCHEMA_PATH describes the schema search order of all authorizations in the database.

Table 9-77 Column information

Column name	Data type	Description
AUTH_NAME	VARCHAR(128)	Name of the authorization
SCHEMA_NAME	VARCHAR(128)	Name of the schema
SEARCH_ORDER	NUMBER	Schema search order of the authorization

DBA_SCHEMA_PRIVS

DBA_SCHEMA_PRIVS describes all schema grants in the database.

Table 9-78 Column information

Column name	Data type	Description
GRANTOR	VARCHAR(128)	Name of the user who performed the grant
GRANTEE	VARCHAR(128)	Name of the user or role to whom access was granted
OWNER	VARCHAR(128)	Owner of the schema
SCHEMA_NAME	VARCHAR(128)	Name of the schema
PRIVILEGE	VARCHAR(32)	Privilege on the schema
GRANTABLE	VARCHAR(3)	Indicates whether the privilege was granted with the GRANT OPTION (YES) or not (NO)

DBA_SEQUENCES

DBA_SEQUENCES describes all sequences in the database.

Table 9-79 Column information

Column name	Data type	Description
SEQUENCE_OWNER	VARCHAR(128)	Owner of the sequence
SEQUENCE_SCHEMA	VARCHAR(128)	Schema of the sequence
SEQUENCE_NAME	VARCHAR(128)	Sequence name
MIN_VALUE	NUMBER	Minimum value of the sequence
MAX_VALUE	NUMBER	Maximum value of the sequence
INCREMENT_BY	NUMBER	Value by which sequence is incremented
CYCLE_FLAG	VARCHAR(1)	Indicates whether the sequence wraps around on reaching the limit (Y) or not (N)
ORDER_FLAG	VARCHAR(1)	<ul style="list-style-type: none"> reserved Indicates whether sequence numbers are generated in order (Y) or not (N)
CACHE_SIZE	NUMBER	Number of sequence numbers to cache
LAST_NUMBER	NUMBER	Last sequence number written to database. If a sequence uses caching, the number written to database is the last number placed in the sequence cache.
COMMENTS	VARCHAR(1024)	Comments of the sequence

DBA_SEQ_PRIVS

DBA_SEQ_PRIVS describes all sequence grants in the database.

Table 9-80 Column information

Column name	Data type	Description
GRANTOR	VARCHAR(128)	Name of the user who performed the grant
GRANTEE	VARCHAR(128)	Name of the user or role to whom access was granted
SEQUENCE_OWNER	VARCHAR(128)	Owner of the sequence
SEQUENCE_SCHEMA	VARCHAR(128)	Schema of the sequence
SEQUENCE_NAME	VARCHAR(128)	Name of the sequence
PRIVILEGE	VARCHAR(32)	Privilege on the sequence
GRANTABLE	VARCHAR(3)	Indicates whether the privilege was granted with the GRANT OPTION (YES) or not (NO)

DBA_SHARD_KEY_COLUMNS

DBA_SHARD_KEY_COLUMNS describes shard key columns of all shared tables in the cluster system.



It is available only on a cluster.

Table 9-81 Column information

Column name	Data type	Description
OWNER	VARCHAR(128)	Owner of the table
TABLE_SCHEMA	VARCHAR(128)	Schema of the table
TABLE_NAME	VARCHAR(128)	Name of the table
COLUMN_NAME	VARCHAR(128)	Column name of the shard key
COLUMN_POSITION	NUMBER	Position of the column within the shard key

DBA_SOURCE

DBA_SOURCE describes the text source of the stored objects accessible to the current user.

Table 9-82 Column information

Column name	Data type	Description
OWNER	VARCHAR(128)	Owner of object
SCHEMA_NAME	VARCHAR(128)	Schema Name of object
NAME	VARCHAR(128)	Name of object
TYPE	VARCHAR(32)	Type of object: FUNCTION, PROCEDURE, PACKAGE, PACKAGE BODY, TRIGGER
LINE	NUMBER	Line number of this line of source
TEXT	LONG VARCHAR	Text source of the stored object
ORIGIN_CON_ID	VARCHAR(256)	ID of the container where the data originates

DBA_STAT_SYSTEM

DBA_STAT_SYSTEM describes analyzed system statistics.

Table 9-83 Column information

Column name	Data type	Description
CPU_OPS	NATIVE_BIGINT	OPS(operations per second) of CPU
NETWORK_IOPS	NATIVE_BIGINT	IOPS(I/O operations per second) of Cluster NETWORK
NETWORK_BUFSIZE	NATIVE_BIGINT	buffer size of Cluster NETWORK when analyzed
LAST_ANALYZED	TIMESTAMP(2) WITH OUT TIME ZONE	Date on which the table was most recently analyzed

DBA_SYS_PRIVS

DBA_SYS_PRIVS describes all system (database, tablespace, schema) privileges in the database.

Table 9-84 Column information

Column name	Data type	Description
GRANTEE	VARCHAR(128)	Name of the grantee
PRIVILEGE	VARCHAR(256)	System(database, tablespace, schema) privilege
GRANTABLE	VARCHAR(3)	Indicates whether the privilege was granted with the GRANT OPTION (YES) or not (NO)
ADMIN_OPTION	VARCHAR(3)	equal to GRANTABLE column

DBA_SYNONYMS

DBA_SYNONYMS describes all synonyms in the database.

Table 9-85 Column information

Column name	Data type	Description
SYNONYM_OWNER	VARCHAR(128)	Owner of the synonym
SYNONYM_SCHEMA	VARCHAR(128)	Schema of the synonym
SYNONYM_NAME	VARCHAR(128)	Synonym name
OBJECT_SCHEMA_NAME	VARCHAR(128)	Object schema name
OBJECT_NAME	VARCHAR(128)	Object name
DB_LINK	VARCHAR(128)	Reserved for future use

DBA_TABLES

DBA_TABLES describes all relational tables in the database.

Table 9-86 Column information

Column name	Data type	Description
OWNER	VARCHAR(128)	Owner of the table
TABLE_SCHEMA	VARCHAR(128)	Schema of the table
TABLE_NAME	VARCHAR(128)	Name of the table
TABLESPACE_NAME	VARCHAR(128)	Name of the tablespace containing the table
CLUSTER_NAME	VARCHAR(128)	<ul style="list-style-type: none"> reserved Name of the cluster
IOT_NAME	VARCHAR(128)	<ul style="list-style-type: none"> reserved Name of the index-organized table
STATUS	VARCHAR(32)	<ul style="list-style-type: none"> reserved If a previous DROP TABLE operation failed, indicates whether the table is unusable (UNUSABLE) or valid (VALID)
PCT_FREE	NUMBER	Minimum percentage of free space in a block
PCT_USED	NUMBER	Minimum percentage of used space in a block
INI_TRANS	NUMBER	Initial number of transactions
MAX_TRANS	NUMBER	Maximum number of transactions
INITIAL_EXTENT	NUMBER	Size of the initial extent (in bytes)
NEXT_EXTENT	NUMBER	Size of secondary extents (in bytes)
MIN_EXTENTS	NUMBER	Minimum number of extents allowed in the segment
MAX_EXTENTS	NUMBER	Maximum number of extents allowed in the segment
PCT_INCREASE	NUMBER	<ul style="list-style-type: none"> reserved Percentage increase in extent size
FREELISTS	NUMBER	<ul style="list-style-type: none"> reserved Number of process freelists allocated to the segment
FREELIST_GROUPS	NUMBER	<ul style="list-style-type: none"> reserved Number of freelist groups allocated to the segment
LOGGING	VARCHAR(3)	Indicates whether or not changes to the table are logged
BACKED_UP	VARCHAR(1)	<ul style="list-style-type: none"> reserved Indicates whether the table has been backed up since the last modification (Y) or not (N)
NUM_ROWS	NUMBER	Number of rows in the table
BLOCKS	NUMBER	<ul style="list-style-type: none"> reserved Number of used blocks in the table
EMPTY_BLOCKS	NUMBER	<ul style="list-style-type: none"> reserved Number of empty (never used) blocks in the table
		<ul style="list-style-type: none"> reserved

Column name	Data type	Description
AVG_SPACE	NUMBER	Average available free space in the table
CHAIN_CNT	NUMBER	<ul style="list-style-type: none"> reserved Number of rows in the table that are chained from one data block to another or that have migrated to a new block, requiring a link to preserve the old rowid
AVG_ROW_LEN	NUMBER	<ul style="list-style-type: none"> reserved Average row length, including row overhead
AVG_SPACE_FREELIST_BLOCKS	NUMBER	<ul style="list-style-type: none"> reserved Average freespace of all blocks on a freelist
NUM_FREELIST_BLOCKS	NUMBER	<ul style="list-style-type: none"> reserved Number of blocks on the freelist
DEGREE	VARCHAR(32)	<ul style="list-style-type: none"> reserved Number of threads per instance for scanning the table, or DEFAULT
INSTANCES	VARCHAR(32)	<ul style="list-style-type: none"> reserved Number of instances across which the table is to be scanned, or DEFAULT
CACHE	VARCHAR(1)	<ul style="list-style-type: none"> reserved Indicates whether the table is to be cached in the buffer cache (Y) or not (N)
TABLE_LOCK	VARCHAR(32)	Indicates whether table locking is enabled (ENABLED) or disabled (DISABLED)
SAMPLE_SIZE	NUMBER	Sample size used in analyzing the table
LAST_ANALYZED	TIMESTAMP(6) WITHOUT TIME ZONE	Date on which the table was most recently analyzed
PARTITIONED	VARCHAR(3)	<ul style="list-style-type: none"> reserved Indicates whether the table is partitioned (YES) or not (NO)
IOT_TYPE	VARCHAR(32)	<ul style="list-style-type: none"> reserved If the table is an index-organized table, then IOT_TYPE is IOT, IOT_OVERFLOW, or IOT_MAPPING.
TEMPORARY	VARCHAR(1)	Indicates whether the table is temporary (Y) or not (N)
SECONDARY	VARCHAR(1)	<ul style="list-style-type: none"> reserved Indicates whether the table is a secondary object created by cartridge
NESTED	VARCHAR(3)	<ul style="list-style-type: none"> reserved Indicates whether the table is a nested table (YES) or not (NO)
BUFFER_POOL	VARCHAR(32)	<ul style="list-style-type: none"> reserved Buffer pool to be used for table blocks
FLASH_CACHE	VARCHAR(32)	<ul style="list-style-type: none"> reserved Database Smart Flash Cache hint to be used for table blocks
CELL_FLASH_CACHE	VARCHAR(32)	<ul style="list-style-type: none"> reserved Cell flash cache hint to be used for table blocks
		<ul style="list-style-type: none"> reserved

Column name	Data type	Description
ROW_MOVEMENT	VARCHAR(32)	If a partitioned table, indicates whether row movement is enabled (ENABLED) or disabled (DISABLED)
GLOBAL_STATS	VARCHAR(3)	<ul style="list-style-type: none"> reserved For partitioned tables, indicates whether statistics for the table as a whole (global statistics) are accurate (YES)
USER_STATS	VARCHAR(3)	<ul style="list-style-type: none"> reserved Indicates whether statistics were entered directly by the user (YES) or not (NO)
DURATION	VARCHAR(32)	<ul style="list-style-type: none"> reserved Indicates the duration of a temporary table
SKIP_CORRUPT	VARCHAR(32)	<ul style="list-style-type: none"> reserved Indicates whether Database ignores blocks marked corrupt during table and index scans (ENABLED) or raises an error (DISABLED)
MONITORING	VARCHAR(3)	<ul style="list-style-type: none"> reserved Indicates whether the table has the MONITORING attribute set (YES) or not (NO)
CLUSTER_OWNER	VARCHAR(128)	<ul style="list-style-type: none"> reserved Owner of the cluster, if any
DEPENDENCIES	VARCHAR(32)	<ul style="list-style-type: none"> reserved Indicates whether row-level dependency tracking is enabled (ENABLED) or disabled (DISABLED)
COMPRESSION	VARCHAR(32)	<ul style="list-style-type: none"> reserved Indicates whether table compression is enabled (ENABLED) or not (DISABLED)
COMPRESS_FOR	VARCHAR(32)	<ul style="list-style-type: none"> reserved Default compression for what kind of operations
DROPPED	VARCHAR(3)	<ul style="list-style-type: none"> reserved Indicates whether the table has been dropped and is in the recycle bin (YES) or not (NO)
READ_ONLY	VARCHAR(3)	Indicates whether the table IS READ-ONLY (YES) or not (NO)
SEGMENT_CREATED	VARCHAR(3)	Indicates whether the table segment has been created (YES) or not (NO)
RESULT_CACHE	VARCHAR(32)	<ul style="list-style-type: none"> reserved Result cache mode annotation for the table: the value in (NULL, DEFAULT, FORCE, MANUAL)

DBA_TABLESPACES

DBA_TABLESPACES describes all tablespaces in the database.

Table 9-87 Column information

Column name	Data type	Description
TABLESPACE_NAME	VARCHAR(128)	Name of the tablespace
BLOCK_SIZE	NUMBER	Tablespace block size
INITIAL_EXTENT	NUMBER	<ul style="list-style-type: none"> reserved Default initial extent size (in bytes)
NEXT_EXTENT	NUMBER	<ul style="list-style-type: none"> reserved Default incremental extent size (in bytes)
MIN_EXTENTS	NUMBER	<ul style="list-style-type: none"> reserved Default minimum number of extents
MAX_EXTENTS	NUMBER	<ul style="list-style-type: none"> reserved Default maximum number of extents
MAX_SIZE	NUMBER	<ul style="list-style-type: none"> reserved Default maximum size of segments
PCT_INCREASE	NUMBER	<ul style="list-style-type: none"> reserved Default percent increase for extent size
MIN_EXTLEN	NUMBER	<ul style="list-style-type: none"> reserved Minimum extent size for this tablespace (in bytes)
STATUS	VARCHAR(32)	Tablespace status: the value in (ONLINE, OFFLINE, READ ONLY)
CONTENTS	VARCHAR(32)	Tablespace contents: the value in (SYSTEM, DATA, TEMPORARY, UNDO)
LOGGING	VARCHAR(32)	Default logging attribute: LOGGING, NOLOGGING
FORCE_LOGGING	VARCHAR(3)	<ul style="list-style-type: none"> reserved Indicates whether the tablespace is under force logging mode (YES) or not (NO)
EXTENT_MANAGEMENT	VARCHAR(32)	<ul style="list-style-type: none"> reserved Indicates whether the extents in the tablespace are dictionary managed (DICTIONARY) or locally managed (LOCAL)
ALLOCATION_TYPE	VARCHAR(32)	<ul style="list-style-type: none"> reserved Type of extent allocation in effect for the tablespace: the value in (SYSTEM, UNIFORM, USER)
PLUGGED_IN	VARCHAR(3)	<ul style="list-style-type: none"> reserved Indicates whether the tablespace is plugged in (YES) or not (NO)
SEGMENT_SPACE_MANAGEMENT	VARCHAR(32)	<ul style="list-style-type: none"> reserved Indicates whether the free and used segment space in the tablespace is managed using free lists (MANUAL) or bitmaps (AUTO)
DEF_TAB_COMPRESSION	VARCHAR(32)	<ul style="list-style-type: none"> reserved Indicates whether default table compression is enabled (ENABLED)

Column name	Data type	Description
		or not (DISABLED)
RETENTION	VARCHAR(32)	<ul style="list-style-type: none"> reserved Undo tablespace retention: the value in (GUARANTEE, NOGUARANTEE, NOT APPLY)
BIGFILE	VARCHAR(3)	<ul style="list-style-type: none"> reserved Indicates whether the tablespace is a bigfile tablespace (YES) or a smallfile tablespace (NO)
PREDICATE_EVALUATION	VARCHAR(32)	<ul style="list-style-type: none"> reserved Indicates whether predicates are evaluated by host (HOST) or by storage (STORAGE)
ENCRYPTED	VARCHAR(3)	<ul style="list-style-type: none"> reserved Indicates whether the tablespace is encrypted (YES) or not (NO)
COMPRESS_FOR	VARCHAR(32)	<ul style="list-style-type: none"> reserved Indicates whether the tablespace is encrypted (YES) or not (NO)

DBA_TAB_COLS

DBA_TAB_COLS describes the columns (including hidden columns) of all tables, views, and clusters in the database.

Table 9-88 Column information

Column name	Data type	Description
OWNER	VARCHAR(128)	Owner of the object
TABLE_SCHEMA	VARCHAR(128)	Schema of the object
TABLE_NAME	VARCHAR(128)	Name of the object
COLUMN_NAME	VARCHAR(128)	Column name
DATA_TYPE	VARCHAR(128)	Datatype of the column
DATA_TYPE_MOD	VARCHAR(3)	<ul style="list-style-type: none"> reserved Datatype modifier of the column
DATA_TYPE_OWNER	VARCHAR(128)	<ul style="list-style-type: none"> reserved Owner of the datatype of the column
DATA_LENGTH	NUMBER	Length of the column (in bytes)
DATA_PRECISION	NUMBER	Decimal precision for NUMBER datatype; binary precision for FLOAT datatype; NULL for all other datatypes
DATA_SCALE	NUMBER	Digits to the right of the decimal point in a number
NULLABLE	VARCHAR(1)	Indicates whether a column allows NULLs.
COLUMN_ID	NUMBER	Sequence number of the column as created
DEFAULT_LENGTH	NUMBER	Length of the default value for the column
DATA_DEFAULT	LONG VARCHAR	Default value for the column
NUM_DISTINCT	NUMBER	Number of distinct values in the column
LOW_VALUE	VARBINARY(32)	Low value in the column
HIGH_VALUE	VARBINARY(32)	High value in the column
DENSITY	NUMBER	<ul style="list-style-type: none"> reserved If a histogram is available on COLUMN_NAME, then this column displays the selectivity of a value that spans fewer than 2 endpoints in the histogram.
NUM_NULLS	NUMBER	Number of NULLs in the column
NUM_BUCKETS	NUMBER	<ul style="list-style-type: none"> reserved Number of buckets in the histogram for the column
LAST_ANALYZED	TIMESTAMP(6) WITH OUT TIME ZONE	Date on which this column was most recently analyzed
SAMPLE_SIZE	NUMBER	Sample size used in analyzing this column
CHARACTER_SET_NAME	VARCHAR(128)	<ul style="list-style-type: none"> reserved Name of the character set
CHAR_COL_DECL_LENGTH	NUMBER	Declaration length of the character type column
		<ul style="list-style-type: none"> reserved

Column name	Data type	Description
GLOBAL_STATS	VARCHAR(3)	For partitioned tables, indicates whether column statistics were collected for the table
USER_STATS	VARCHAR(3)	<ul style="list-style-type: none"> reserved Indicates whether statistics were entered directly by the user (YES) or not (NO)
AVG_COL_LEN	NUMBER	Average length of the column (in bytes)
CHAR_LENGTH	NUMBER	Displays the length of the column in characters.
CHAR_USED	VARCHAR(1)	Indicates that the column uses BYTE length semantics (B) or CHARACTER length semantics (C)
V80_FMT_IMAGE	VARCHAR(3)	<ul style="list-style-type: none"> reserved Indicates whether the column data is in release older image format (YES) or not (NO)
DATA_UPGRADED	VARCHAR(3)	<ul style="list-style-type: none"> reserved Indicates whether the column data has been upgraded to the latest type version format (YES) or not (NO)
HIDDEN_COLUMN	VARCHAR(3)	Indicates whether the column is a hidden column (YES) or not (NO)
VIRTUAL_COLUMN	VARCHAR(3)	<ul style="list-style-type: none"> reserved Indicates whether the column is a virtual column (YES) or not (NO)
SEGMENT_COLUMN_ID	NUMBER	Sequence number of the column in the segment
INTERNAL_COLUMN_ID	NUMBER	Internal sequence number of the column
HISTOGRAM	VARCHAR(32)	<ul style="list-style-type: none"> reserved Indicates existence/type of histogram
QUALIFIED_COLUMN_NAME	VARCHAR(4000)	Qualified column name
IDENTITY_COLUMN	VARCHAR(3)	Indicates whether this is an identity column (YES) or not (NO)

DBA_TAB_COLUMNS

DBA_TAB_COLUMNS describes the columns of the tables, views, and clusters accessible to the current user.

Table 9-89 Column information

Column name	Data type	Description
OWNER	VARCHAR(128)	Owner of the object
TABLE_SCHEMA	VARCHAR(128)	Schema of the object
TABLE_NAME	VARCHAR(128)	Name of the object
COLUMN_NAME	VARCHAR(128)	Column name
DATA_TYPE	VARCHAR(128)	Datatype of the column
DATA_TYPE_MOD	VARCHAR(3)	<ul style="list-style-type: none"> reserved Datatype modifier of the column
DATA_TYPE_OWNER	VARCHAR(128)	<ul style="list-style-type: none"> reserved Owner of the datatype of the column
DATA_LENGTH	NUMBER	Length of the column (in bytes)
DATA_PRECISION	NUMBER	Decimal precision for NUMBER datatype; binary precision for FLOAT datatype; NULL for all other datatypes
DATA_SCALE	NUMBER	Digits to the right of the decimal point in a number
NULLABLE	VARCHAR(1)	Indicates whether a column allows NULLs.
COLUMN_ID	NUMBER	Sequence number of the column as created
DEFAULT_LENGTH	NUMBER	Length of the default value for the column
DATA_DEFAULT	LONG VARCHAR	Default value for the column
NUM_DISTINCT	NUMBER	Number of distinct values in the column
LOW_VALUE	VARBINARY(32)	Low value in the column
HIGH_VALUE	VARBINARY(32)	High value in the column
DENSITY	NUMBER	<ul style="list-style-type: none"> reserved If a histogram is available on COLUMN_NAME, then this column displays the selectivity of a value that spans fewer than 2 endpoints in the histogram.
NUM_NULLS	NUMBER	Number of NULLs in the column
NUM_BUCKETS	NUMBER	<ul style="list-style-type: none"> reserved Number of buckets in the histogram for the column
LAST_ANALYZED	TIMESTAMP(6) WITH OUT TIME ZONE	Date on which this column was most recently analyzed
SAMPLE_SIZE	NUMBER	Sample size used in analyzing this column
CHARACTER_SET_NAME	VARCHAR(128)	<ul style="list-style-type: none"> reserved Name of the character set
CHAR_COL_DECL_LENGTH	NUMBER	Declaration length of the character type column
		<ul style="list-style-type: none"> reserved

Column name	Data type	Description
GLOBAL_STATS	VARCHAR(3)	For partitioned tables, indicates whether column statistics were collected for the table
USER_STATS	VARCHAR(3)	<ul style="list-style-type: none"> reserved Indicates whether statistics were entered directly by the user (YES) or not (NO)
AVG_COL_LEN	NUMBER	Average length of the column (in bytes)
CHAR_LENGTH	NUMBER	Displays the length of the column in characters.
CHAR_USED	VARCHAR(1)	Indicates that the column uses BYTE length semantics (B) or CHAR length semantics (C)
V80_FMT_IMAGE	VARCHAR(3)	<ul style="list-style-type: none"> reserved Indicates whether the column data is in release older image format (YES) or not (NO)
DATA_UPGRADED	VARCHAR(3)	<ul style="list-style-type: none"> reserved Indicates whether the column data has been upgraded to the latest type version format (YES) or not (NO)
HISTOGRAM	VARCHAR(32)	<ul style="list-style-type: none"> reserved Indicates existence/type of histogram
IDENTITY_COLUMN	VARCHAR(3)	Indicates whether this is an identity column (YES) or not (NO)

DBA_TAB_COMMENTS

DBA_TAB_COMMENTS displays comments on all tables and views in the database.

Table 9-90 Column information

Column name	Data type	Description
OWNER	VARCHAR(128)	Owner of the object
TABLE_SCHEMA	VARCHAR(128)	Schema of the object
TABLE_NAME	VARCHAR(128)	Name of the object
TABLE_TYPE	VARCHAR(32)	Type of the object
COMMENTS	VARCHAR(1024)	Comment on the object

DBA_TAB_IDENTITY_COLS

DBA_TAB_IDENTITY_COLS describes all table identity columns.

Table 9-91 Column information

Column name	Data type	Description
OWNER	VARCHAR(128)	Owner of the table
TABLE_SCHEMA	VARCHAR(128)	Schema of the table
TABLE_NAME	VARCHAR(128)	Name of the table
COLUMN_NAME	VARCHAR(128)	Name of the identity column
GENERATION_TYPE	VARCHAR(32)	Generation type of the identity column. Possible values are ALWAYS or BY DEFAULT
IDENTITY_OPTIONS	VARCHAR(1024)	Options for the identity column sequence generator

DBA_TAB_PLACE

DBA_TAB_PLACE describes node placement of all cluster tables in the cluster system.



It is available only on a cluster.

Table 9-92 Column information

Column name	Data type	Description
OWNER	VARCHAR(128)	Owner of the table
TABLE_SCHEMA	VARCHAR(128)	Schema of the table
TABLE_NAME	VARCHAR(128)	Name of the table
GROUP_ID	NUMBER	Group identifier of the node where the table placed
GROUP_NAME	VARCHAR(128)	Group name of the node where the table placed
MEMBER_ID	NUMBER	Member identifier of the node where the table placed
MEMBER_NAME	VARCHAR(128)	Member name of the node where the table placed
MEMBER_OFFLINE	BOOLEAN	data of the cluster member is offline or not
SCN	VARCHAR(64)	table scn of the node where the table placed
NUM_ROWS	NUMBER	Number of rows in the table
BLOCKS	NUMBER	Number of used blocks of the node where the table placed
LAST_ANALYZED	TIMESTAMP(6) WITH OUT TIME ZONE	Date on which the table was most recently analyzed

DBA_TAB_PRIVS

DBA_TAB_PRIVS describes all object grants in the database.

Table 9-93 Column information

Column name	Data type	Description
GRANTEE	VARCHAR(128)	Name of the user or role to whom access was granted
OWNER	VARCHAR(128)	Owner of the object
TABLE_SCHEMA	VARCHAR(128)	Schema of the object
TABLE_NAME	VARCHAR(128)	Name of the object
GRANTOR	VARCHAR(128)	Name of the user who performed the grant
PRIVILEGE	VARCHAR(32)	Privilege on the object
GRANTABLE	VARCHAR(3)	Indicates whether the privilege was granted with the GRANT OPTION (YES) or not (NO)
HIERARCHY	VARCHAR(3)	Indicates whether the privilege was granted with the HIERARCHY OPTION (YES) or not (NO)

DBA_TAB_SHARDS

DBA_TAB_SHARDS describes shard information of all sharded tables in the cluster system.



It is available only on a cluster.

Table 9-94 Column information

Column name	Data type	Description
OWNER	VARCHAR(128)	Owner of the table
TABLE_SCHEMA	VARCHAR(128)	Schema of the table
TABLE_NAME	VARCHAR(128)	Name of the table
SHARD_STRATEGY	VARCHAR(32)	Sharding strategy of the table: the value in (HASH SHARDING, RANGE SHARDING, LIST SHARDING)
SHARD_NAME	VARCHAR(128)	Shard name
SHARD_NUMBER	NUMBER	Shard number
SHARD_DEFINITION	LONG VARCHAR	Shard definition (if hash sharded, the value is null)
GROUP_ID	NUMBER	Group identifier where the shard placed
GROUP_NAME	VARCHAR(128)	Group Name where the shard placed

DBA_TBS_PRIVS

DBA_TBS_PRIVS describes all tablespace grants in the database.

Table 9-95 Column information

Column name	Data type	Description
GRANTOR	VARCHAR(128)	Name of the user who performed the grant
GRANTEE	VARCHAR(128)	Name of the user or role to whom access was granted
TABLESPACE_NAME	VARCHAR(128)	Name of the tablespace
PRIVILEGE	VARCHAR(32)	Privilege on the tablespace
GRANTABLE	VARCHAR(3)	Indicates whether the privilege was granted with the GRANT OPTION (YES) or not (NO)

DBA_USERS

DBA_USERS describes all users of the database.

Table 9-96 Column information

Column name	Data type	Description
USERNAME	VARCHAR(128)	Name of the user
USER_ID	NUMBER	ID number of the user
PASSWORD	VARCHAR(128)	encrypted password
ACCOUNT_STATUS	VARCHAR(32)	Account status: the value in (OPEN, EXPIRED, EXPIRED(GRACE), LOCKED(TIMED), LOCKED, EXPIRED & LOCKED(TIMED), EXPIRED(GRACE) & LOCKED(TIMED), EXPIRED & LOCKED, EXPIRED(GRACE) & LOCKED)
LOCK_DATE	TIMESTAMP(2) WITHOUT TIME ZONE	Timestamp the account was locked if account status was LOCKED
EXPIRY_DATE	TIMESTAMP(2) WITHOUT TIME ZONE	Timestamp of expiration of the account
FAILED_LOGIN_ATTEMPTS	NUMBER	Consecutive failed login attempts count
DEFAULT_TABLESPACE	VARCHAR(128)	Default tablespace for data
TEMPORARY_TABLESPACE	VARCHAR(128)	Name of the default tablespace for temporary tables or the name of a tablespace group
INDEX_TABLESPACE	VARCHAR(128)	Default tablespace for index
CREATED	TIMESTAMP(2) WITHOUT TIME ZONE	User creation timestamp
PROFIL_NAME	VARCHAR(128)	User resource profile name
INITIAL_RESOURCE_CONSUMER_GROUP	VARCHAR(128)	<ul style="list-style-type: none"> reserved Initial resource consumer group for the user
EXTERNAL_NAME	VARCHAR(128)	<ul style="list-style-type: none"> reserved User external name
PASSWORD_VERSIONS	VARCHAR(32)	<ul style="list-style-type: none"> reserved Shows the list of versions of the password hashes (verifiers).
EDITIONS_ENABLED	VARCHAR(1)	Indicates whether editions have been enabled for the corresponding user (Y) or not (N).
AUTHENTICATION_TYPE	VARCHAR(32)	<ul style="list-style-type: none"> reserved Indicates the authentication mechanism for the user.

DBA_VIEWS

DBA_VIEWS describes all views in the database.

Table 9-97 Column information

Column name	Data type	Description
OWNER	VARCHAR(128)	Owner of the view
VIEW_SCHEMA	VARCHAR(128)	Schema of the view
VIEW_NAME	VARCHAR(128)	Name of the view
TEXT_LENGTH	NUMBER	Length of the view text
TEXT	LONG VARCHAR	View text
TYPE_TEXT_LENGTH	NUMBER	<ul style="list-style-type: none"> reserved Length of the type clause of the typed view
TYPE_TEXT	VARCHAR(4000)	<ul style="list-style-type: none"> reserved Type clause of the typed view
OID_TEXT_LENGTH	NUMBER	<ul style="list-style-type: none"> reserved Length of the WITH OID clause of the typed view
OID_TEXT	VARCHAR(4000)	<ul style="list-style-type: none"> reserved WITH OID clause of the typed view
VIEW_TYPE_OWNER	VARCHAR(128)	<ul style="list-style-type: none"> reserved Owner of the type of the view if the view is a typed view
VIEW_TYPE	VARCHAR(32)	<ul style="list-style-type: none"> reserved Type of the view if the view is a typed view
SUPERVIEW_NAME	VARCHAR(128)	<ul style="list-style-type: none"> reserved Name of the superview
EDITIONING_VIEW	VARCHAR(1)	Reserved for future use
READ_ONLY	VARCHAR(1)	Indicates whether the view is read-only (Y) or not (N)

Views of USER_family

It retrieves information about objects which are owned by current user.

USER_ALL_TABLES

USER_ALL_TABLES describes the object tables and relational tables owned by the current user.

Table 9-98 Column information

Column name	Data type	Description
TABLE_SCHEMA	VARCHAR(128)	Schema of the table
TABLE_NAME	VARCHAR(128)	Name of the table
TABLESPACE_NAME	VARCHAR(128)	Name of the tablespace containing the table
CLUSTER_NAME	VARCHAR(128)	<ul style="list-style-type: none"> reserved Name of the cluster
IOT_NAME	VARCHAR(128)	<ul style="list-style-type: none"> reserved Name of the index-organized table
STATUS	VARCHAR(32)	<ul style="list-style-type: none"> reserved If a previous DROP TABLE operation failed, indicates whether the table is unusable (UNUSABLE) or valid (VALID)
PCT_FREE	NUMBER	Minimum percentage of free space in a block
PCT_USED	NUMBER	Minimum percentage of used space in a block
INI_TRANS	NUMBER	Initial number of transactions
MAX_TRANS	NUMBER	Maximum number of transactions
INITIAL_EXTENT	NUMBER	Size of the initial extent (in bytes)
NEXT_EXTENT	NUMBER	Size of secondary extents (in bytes)
MIN_EXTENTS	NUMBER	Minimum number of extents allowed in the segment
MAX_EXTENTS	NUMBER	Maximum number of extents allowed in the segment
PCT_INCREASE	NUMBER	<ul style="list-style-type: none"> reserved Percentage increase in extent size
FREELISTS	NUMBER	<ul style="list-style-type: none"> reserved Number of process freelists allocated to the segment
FREELIST_GROUPS	NUMBER	<ul style="list-style-type: none"> reserved Number of freelist groups allocated to the segment
LOGGING	VARCHAR(3)	Indicates whether or not changes to the table are logged
BACKED_UP	VARCHAR(1)	<ul style="list-style-type: none"> reserved Indicates whether the table has been backed up since the last modification (Y) or not (N)
NUM_ROWS	NUMBER	Number of rows in the table
BLOCKS	NUMBER	Number of used blocks in the table

Column name	Data type	Description
EMPTY_BLOCKS	NUMBER	<ul style="list-style-type: none"> reserved Number of empty (never used) blocks in the table
AVG_SPACE	NUMBER	<ul style="list-style-type: none"> reserved Average available free space in the table
CHAIN_CNT	NUMBER	<ul style="list-style-type: none"> reserved Number of rows in the table that are chained from one data block to another or that have migrated to a new block, requiring a link to preserve the old rowid
AVG_ROW_LEN	NUMBER	<ul style="list-style-type: none"> reserved Average row length, including row overhead
AVG_SPACE_FREELIST_BLOCKS	NUMBER	<ul style="list-style-type: none"> reserved Average freespace of all blocks on a freelist
NUM_FREELIST_BLOCKS	NUMBER	<ul style="list-style-type: none"> reserved Number of blocks on the freelist
DEGREE	VARCHAR(32)	<ul style="list-style-type: none"> reserved Number of threads per instance for scanning the table, or DEFAULT
INSTANCES	VARCHAR(32)	<ul style="list-style-type: none"> reserved Number of instances across which the table is to be scanned, or DEFAULT
CACHE	VARCHAR(1)	<ul style="list-style-type: none"> reserved Indicates whether the table is to be cached in the buffer cache (Y) or not (N)
TABLE_LOCK	VARCHAR(32)	Indicates whether table locking is enabled (ENABLED) or disabled (DISABLED)
SAMPLE_SIZE	NUMBER	Sample size used in analyzing the table
LAST_ANALYZED	TIMESTAMP(6) WITHOUT TIME ZONE	Date on which the table was most recently analyzed
PARTITIONED	VARCHAR(3)	<ul style="list-style-type: none"> reserved Indicates whether the table is partitioned (YES) or not (NO)
IOT_TYPE	VARCHAR(32)	<ul style="list-style-type: none"> reserved If the table is an index-organized table, then IOT_TYPE is IOT, IOT_OVERFLOW, or IOT_MAPPING.
OBJECT_ID_TYPE	VARCHAR(32)	<ul style="list-style-type: none"> reserved Indicates whether the object ID (OID) is USER-DEFINED or SYSTEM GENERATED
TABLE_TYPE_OWNER	VARCHAR(128)	<ul style="list-style-type: none"> reserved If an object table, owner of the type from which the table is created
TABLE_TYPE	VARCHAR(128)	<ul style="list-style-type: none"> reserved If an object table, type of the table
TEMPORARY	VARCHAR(1)	Indicates whether the table is temporary (Y) or not (N)
		<ul style="list-style-type: none"> reserved

Column name	Data type	Description
SECONDARY	VARCHAR(1)	Indicates whether the table is a secondary object created by cartridge
NESTED	VARCHAR(3)	<ul style="list-style-type: none"> reserved Indicates whether the table is a nested table (YES) or not (NO)
BUFFER_POOL	VARCHAR(32)	<ul style="list-style-type: none"> reserved Buffer pool to be used for table blocks
FLASH_CACHE	VARCHAR(32)	<ul style="list-style-type: none"> reserved Database Smart Flash Cache hint to be used for table blocks
CELL_FLASH_CACHE	VARCHAR(32)	<ul style="list-style-type: none"> reserved Cell flash cache hint to be used for table blocks
ROW_MOVEMENT	VARCHAR(32)	<ul style="list-style-type: none"> reserved If a partitioned table, indicates whether row movement is enabled (ENABLED) or disabled (DISABLED)
GLOBAL_STATS	VARCHAR(3)	<ul style="list-style-type: none"> reserved For partitioned tables, indicates whether statistics for the table as a whole (global statistics) are accurate (YES)
USER_STATS	VARCHAR(3)	<ul style="list-style-type: none"> reserved Indicates whether statistics were entered directly by the user (YES) or not (NO)
DURATION	VARCHAR(32)	<ul style="list-style-type: none"> reserved Indicates the duration of a temporary table
SKIP_CORRUPT	VARCHAR(32)	<ul style="list-style-type: none"> reserved Indicates whether Database ignores blocks marked corrupt during table and index scans (ENABLED) or raises an error (DISABLED)
MONITORING	VARCHAR(3)	<ul style="list-style-type: none"> reserved Indicates whether the table has the MONITORING attribute set (YES) or not (NO)
CLUSTER_OWNER	VARCHAR(128)	<ul style="list-style-type: none"> reserved Owner of the cluster, if any
DEPENDENCIES	VARCHAR(32)	<ul style="list-style-type: none"> reserved Indicates whether row-level dependency tracking is enabled (ENABLED) or disabled (DISABLED)
COMPRESSION	VARCHAR(32)	<ul style="list-style-type: none"> reserved Indicates whether table compression is enabled (ENABLED) or not (DISABLED)
COMPRESS_FOR	VARCHAR(32)	<ul style="list-style-type: none"> reserved Default compression for what kind of operations
DROPPED	VARCHAR(3)	<ul style="list-style-type: none"> reserved Indicates whether the table has been dropped and is in the recycle bin (YES) or not (NO)
READ_ONLY	VARCHAR(3)	Indicates whether the table IS READ-ONLY (YES) or not (NO)

Column name	Data type	Description
SEGMENT_CREATED	VARCHAR(3)	Indicates whether the table segment has been created (YES) or not (NO)

USER_ARGUMENTS

USER_ARGUMENTS lists all arguments of functions, procedures.

Table 9-99 Column information

Column name	Data type	Description
SCHEMA_NAME	VARCHAR(128)	Schema Name of function, procedures or package
OBJECT_NAME	VARCHAR(128)	Name of function, procedures
PACKAGE_NAME	VARCHAR(128)	Package Name of function, procedures
OBJECT_ID	NUMBER	ID of a function, procedures
SUBPROGRAM_ID	NUMBER	ID of procedures in package
ARGUMENT_NAME	VARCHAR(128)	Name of argument or attribute name of record type argument
POSITION	NUMBER	Position of argument or position of attribute in record type
SEQUENCE	NUMBER	Sequential order of argument and its attributes
DATA_LEVEL	NUMBER	Nesting depth of the argument for composite types
DATA_TYPE	VARCHAR(128)	Data type of the argument
DEFAULTED	VARCHAR(1)	Whether or not the argument is defaulted
DEFAULT_VALUE	VARCHAR(1)	Reserved for future use
DEFAULT_LENGTH	VARCHAR(1)	Reserved for future use
IN_OUT	VARCHAR(32)	Direction of the argument (IN, OUT, IN/OUT)
DATA_LENGTH	NUMBER	Length of the column(in bytes)
DATA_PRECISION	NUMBER	Length in decimal digits(NUMBER) or binary digits(FLOAT)
DATA_SCALE	NUMBER	Digits to the right of the decimal point in a number
RADIX	NUMBER	Argument radix for a number
CHARACTER_SET_NAME	VARCHAR(128)	Character set name for the argument
TYPE_OWNER	VARCHAR(128)	Owner of the type of the argument
TYPE_NAME	VARCHAR(128)	Name of the type of the argument
TYPE_SUBNAME	VARCHAR(128)	Name of the type of the argument declared in package
TYPE_LINK	VARCHAR(128)	Name of the type of the argument declared in a remote package
PLS_TYPE	VARCHAR(128)	Name of the type of the argument at PSM
CHAR_LENGTH	NUMBER	Character limit for string datatypes
CHAR_USED	VARCHAR(1)	Whether the byte limit(B) or char limit(C) is official for the string
ORIGIN_CON_ID	VARCHAR(256)	ID of the container where the data originates

USER_CATALOG

USER_CATALOG lists tables, views, synonyms, and sequences owned by the current user.

Table 9-100 Column information

Column name	Data type	Description
TABLE_SCHEMA	VARCHAR(128)	Schema of the TABLE, VIEW, SYNONYM, SEQUENCE, or UNDEFINED
TABLE_NAME	VARCHAR(128)	Name of the TABLE, VIEW, SYNONYM, SEQUENCE, or UNDEFINED
TABLE_TYPE	VARCHAR(32)	Type of the TABLE, VIEW, SYNONYM, SEQUENCE, or UNDEFINED

USER_COL_COMMENTS

USER_COL_COMMENTS displays comments on the columns of the tables and views owned by the current user.

Table 9-101 Column information

Column name	Data type	Description
TABLE_SCHEMA	VARCHAR(128)	Schema of the object
TABLE_NAME	VARCHAR(128)	Name of the object
COLUMN_NAME	VARCHAR(128)	Name of the column
COMMENTS	VARCHAR(1024)	Comment on the column

USER_CLUSTER_TABLES

USER_CLUSTER_TABLES describes all cluster tables owned by the current user in the cluster system.



It is available only on a cluster.

Table 9-102 Column information

Column name	Data type	Description
TABLE_SCHEMA	VARCHAR(128)	Schema of the table
TABLE_NAME	VARCHAR(128)	Name of the table
SHARD_STRATEGY	VARCHAR(32)	Sharding strategy of the table: the value in (CLONED, HASH SHARDING, RANGE SHARDING, LIST S HARDING)
SHARD_PLACEMENT	VARCHAR(32)	Shard placement of the table: the value in (AT CLUSTER WIDE or AT CLUSTER GROUP)
SHARD_COUNT	NUMBER	Shard count of the table (if cloned table, the value is null)
SHARD_KEY_COUNT	NUMBER	Shard key column count of the table (if cloned table, the value is nul l)
HAS_GSI	VARCHAR(3)	Indicate whether the table has global secondary index: (YES) or (NO)

USER_COL_PRIVS

USER_COL_PRIVS describes the column object grants for which the current user is the object owner, grantor, or grantee.

Table 9-103 Column information

Column name	Data type	Description
GRANTEE	VARCHAR(128)	Name of the user or role to whom access was granted
OWNER	VARCHAR(128)	Owner of the object
TABLE_SCHEMA	VARCHAR(128)	Schema of the object
TABLE_NAME	VARCHAR(128)	Name of the object
COLUMN_NAME	VARCHAR(128)	Name of the column
GRANTOR	VARCHAR(128)	Name of the user who performed the grant
PRIVILEGE	VARCHAR(32)	Privilege on the column
GRANTABLE	VARCHAR(3)	Indicates whether the privilege was granted with the GRANT OPTION (YES) or not (NO)

USER_COL_PRIVS_MADE

USER_COL_PRIVS_MADE describes the column object grants for which the current user is the object owner.

Table 9-104 Column information

Column name	Data type	Description
GRANTEE	VARCHAR(128)	Name of the user or role to whom access was granted
TABLE_SCHEMA	VARCHAR(128)	Schema of the object
TABLE_NAME	VARCHAR(128)	Name of the object
COLUMN_NAME	VARCHAR(128)	Name of the column
GRANTOR	VARCHAR(128)	Name of the user who performed the grant
PRIVILEGE	VARCHAR(32)	Privilege on the column
GRANTABLE	VARCHAR(3)	Indicates whether the privilege was granted with the GRANT OPTION (YES) or not (NO)

USER_COL_PRIVS_RECD

USER_COL_PRIVS_RECD describes the column object grants for which the current user is the grantee.

Table 9-105 Column information

Column name	Data type	Description
GRANTEE	VARCHAR(128)	Name of the user or role to whom access was granted
TABLE_SCHEMA	VARCHAR(128)	Schema of the object
TABLE_NAME	VARCHAR(128)	Name of the object
COLUMN_NAME	VARCHAR(128)	Name of the column
GRANTOR	VARCHAR(128)	Name of the user who performed the grant
PRIVILEGE	VARCHAR(32)	Privilege on the column
GRANTABLE	VARCHAR(3)	Indicates whether the privilege was granted with the GRANT OPTION (YES) or not (NO)

USER_CONSTRAINTS

USER_CONSTRAINTS describes all constraint definitions on tables owned by the current user.

Table 9-106 Column information

Column name	Data type	Description
OWNER	VARCHAR(128)	Owner of the constraint definition
CONSTRAINT_SCHEMA	VARCHAR(128)	Schema of the constraint definition
CONSTRAINT_NAME	VARCHAR(128)	Name of the constraint definition
CONSTRAINT_TYPE	VARCHAR(1)	Type of the constraint definition: the value in (C: check constraint, P: Primary key, U: Unique Key, R: Referential integrity)
TABLE_OWNER	VARCHAR(128)	Owner of the table (or view) associated with the constraint definition
TABLE_SCHEMA	VARCHAR(128)	Schema of the table (or view) associated with the constraint definition
TABLE_NAME	VARCHAR(128)	Name of the table (or view) associated with the constraint definition
SEARCH_CONDITION	LONG VARCHAR	Text of search condition for a check constraint
R_OWNER	VARCHAR(128)	Owner of the unique constraint definition for the referenced table
R_SCHEMA	VARCHAR(128)	Schema of the unique constraint definition for the referenced table
R_CONSTRAINT_NAME	VARCHAR(128)	Name of the unique constraint definition for the referenced table
DELETE_RULE	VARCHAR(32)	Delete rule for a referential constraint: the value in (NO ACTION, RESTRICT, CASCADE, SET NULL, SET DEFAULT)
UPDATE_RULE	VARCHAR(32)	Update rule for a referential constraint: the value in (NO ACTION, RESTRICT, CASCADE, SET NULL, SET DEFAULT)
STATUS	VARCHAR(32)	Enforcement status of the constraint: the value in (ENABLED, DISABLE)
DEFERRABLE	VARCHAR(32)	Indicates whether the constraint is deferrable (DEFERRABLE) or not (NOT DEFERRABLE)
DEFERRED	VARCHAR(32)	Indicates whether the constraint was initially deferred (DEFERRED) or not (IMMEDIATE)
VALIDATED	VARCHAR(32)	Indicates whether all data may obey the constraint or not: the value in (VALIDATED, NOT VALIDATED)
GENERATED	VARCHAR(32)	Indicates whether the name of the constraint is user-generated (USER NAME) or system-generated (GENERATED NAME)
BAD	VARCHAR(32)	<ul style="list-style-type: none"> reserved Indicates whether this constraint specifies a century in an ambiguous manner (BAD) or not (NULL)
RELY	VARCHAR(32)	<ul style="list-style-type: none"> reserved When NOT VALIDATED, indicates whether the constraint is to be taken in to account for query rewrite (RELY) or not (NULL)
LAST_CHANGE	TIMESTAMP(2) WITHOUT TIME ZONE	When the constraint was last enabled or disabled

Column name	Data type	Description
INDEX_OWNER	VARCHAR(128)	Owner of the index associated with the key constraint
INDEX_SCHEMA	VARCHAR(128)	Schema of the index associated with the key constraint
INDEX_NAME	VARCHAR(128)	Name of the index associated with the key constraint
INVALID	VARCHAR(32)	Indicates whether the constraint is invalid (INVALID) or not (NULL)
VIEW_RELATED	VARCHAR(32)	<ul style="list-style-type: none">• reserved Indicates whether the constraint depends on a view (DEPEND ON VIEW) or not (NULL)
COMMENTS	VARCHAR(1024)	Comments of the constraint definition

USER_CONS_COLUMNS

USER_CONS_COLUMNS describes columns that are owned by the current user and that are specified in constraint definitions.

Table 9-107 Column information

Column name	Data type	Description
OWNER	VARCHAR(128)	Owner of the constraint definition
CONSTRAINT_SCHEMA	VARCHAR(128)	Schema of the constraint definition
CONSTRAINT_NAME	VARCHAR(128)	Name of the constraint definition
TABLE_OWNER	VARCHAR(128)	Owner of the table with the constraint definition
TABLE_SCHEMA	VARCHAR(128)	Schema of the table with the constraint definition
TABLE_NAME	VARCHAR(128)	Name of the table with the constraint definition
COLUMN_NAME	VARCHAR(128)	Name of the column or attribute of the object type column specified in the constraint definition
POSITION	NUMBER	Original position of the column or attribute in the definition of the object

USER_DEPENDENCIES

USER_DEPENDENCIES describes dependencies between objects accessible to the current user

Table 9-108 Column information

Column name	Data type	Description
SCHEMA_NAME	VARCHAR(128)	Schema Name of object
NAME	VARCHAR(128)	Name of object
TYPE	VARCHAR(32)	Type of object: FUNCTION, PROCEDURE, VIEW, PACKAGE, PACKAGE BODY, TRIGGER
REFERENCED_OWNER	VARCHAR(128)	Owner of the referenced object
REFERENCED_SCHEMA_NAME	VARCHAR(128)	Schema Name of the referenced object
REFERENCED_TYPE	VARCHAR(32)	Type of the referenced object: FUNCTION, PROCEDURE, TABLE, VIEW, SEQUENCE, PACKAGE, PACKAGE BODY, TRIGGER
REFERENCED_LINK_NAME	VARCHAR(128)	Name of the link to the parent object
REFERENCED_NAME	VARCHAR(128)	Name of the referenced object
DEPENDENCY_TYPE	VARCHAR(32)	Indicates whether the dependency is a REF dependency (REF) or not (HARD)

USER_EXTENTS

USER_EXTENTS describes the extents comprising the segments owned by the current user's objects.

Table 9-109 Column information

Column name	Data type	Description
SEGMENT_SCHEMA	VARCHAR(128)	Schema of the segment associated with the extent
SEGMENT_NAME	VARCHAR(128)	Name of the segment associated with the extent
PARTITION_NAME	VARCHAR(128)	<ul style="list-style-type: none"> reserved Object Partition Name (Set to NULL for non-partitioned objects)
SEGMENT_TYPE	VARCHAR(32)	Type of the segment: TABLE, INDEX
TABLESPACE_NAME	VARCHAR(128)	Name of the tablespace containing the extent
EXTENT_ID	NUMBER	<ul style="list-style-type: none"> reserved Extent number in the segment
BYTES	NUMBER	Size of the extent in bytes
BLOCKS	NUMBER	Size of the extent in Oracle blocks

USER_GLOBAL_SECONDARY_INDEXES

USER_GLOBAL_SECONDARY_INDEXES describes the global secondary indexes on the tables owned by the current user.



It is available only on a cluster.

Table 9-110 Column information

Column name	Data type	Description
TABLE_SCHEMA	VARCHAR(128)	Schema of the global secondary indexed object
TABLE_NAME	VARCHAR(128)	Name of the global secondary indexed object
TABLESPACE_NAME	VARCHAR(128)	Name of the tablespace containing the global secondary index
INI_TRANS	NUMBER	Initial number of transactions
MAX_TRANS	NUMBER	Maximum number of transactions
INITIAL_EXTENT	NUMBER	Size of the initial extent
NEXT_EXTENT	NUMBER	Size of secondary extents
MIN_EXTENTS	NUMBER	Minimum number of extents allowed in the segment
MAX_EXTENTS	NUMBER	Maximum number of extents allowed in the segment
PCT_FREE	NUMBER	Minimum percentage of free space in a block
LOGGING	VARCHAR(3)	Indicates whether or not changes to the global secondary index are logged: (YES) or (NO)
BLOCKS	NUMBER	Number of used blocks in the global secondary index

USER_GSI_PLACE

USER_GSI_PLACE describes node placement of all global secondary indexes on the tables owned by the current user in the cluster system.



It is available only on a cluster.

Table 9-111 Column information

Column name	Data type	Description
TABLE_SCHEMA	VARCHAR(128)	Schema of the global secondary indexed object
TABLE_NAME	VARCHAR(128)	Name of the global secondary indexed object
GROUP_ID	NUMBER	Group identifier of the node where the global secondary index placed
GROUP_NAME	VARCHAR(128)	Group name of the node where the global secondary index placed
MEMBER_ID	NUMBER	Member identifier of the node where the global secondary index placed
MEMBER_NAME	VARCHAR(128)	Member name of the node where the global secondary index placed
MEMBER_OFFLINE	BOOLEAN	data of the cluster member is offline or not
BLOCKS	NUMBER	Number of used blocks of the node where the global secondary index placed

USER_INDEXES

USER_INDEXES describes indexes owned by the current user.

Table 9-112 Column information

Column name	Data type	Description
INDEX_SCHEMA	VARCHAR(128)	Schema of the index
INDEX_NAME	VARCHAR(128)	Name of the index
INDEX_TYPE	VARCHAR(32)	Type of the index: the value in (NORMAL, NORMAL/REV, BITMAP, FUNCTION-BASED NORMAL, FUNCTION-BASED NORMAL/REV, FUNCTION-BASED BITMAP, IOT - TOP, DOMAIN)
TABLE_OWNER	VARCHAR(128)	Owner of the indexed object
TABLE_SCHEMA	VARCHAR(128)	Schema of the indexed object
TABLE_NAME	VARCHAR(128)	Name of the indexed object
TABLE_TYPE	VARCHAR(32)	Type of the indexed object: the value in (NEXT OBJECT, INDEX, TABLE, VIEW, SYNONYM, SEQUENCE)
UNIQUENESS	VARCHAR(32)	Indicates whether the index is unique (UNIQUE) or nonunique (NONUNIQUE)
COMPRESSION	VARCHAR(32)	<ul style="list-style-type: none"> reserved Indicates whether index compression is enabled (ENABLED) or not (DISABLED)
PREFIX_LENGTH	NUMBER	<ul style="list-style-type: none"> reserved Number of columns in the prefix of the compression key
TABLESPACE_NAME	VARCHAR(128)	Name of the tablespace containing the index
INI_TRANS	NUMBER	Initial number of transactions
MAX_TRANS	NUMBER	Maximum number of transactions
INITIAL_EXTENT	NUMBER	Size of the initial extent
NEXT_EXTENT	NUMBER	Size of secondary extents
MIN_EXTENTS	NUMBER	Minimum number of extents allowed in the segment
MAX_EXTENTS	NUMBER	Maximum number of extents allowed in the segment
PCT_INCREASE	NUMBER	<ul style="list-style-type: none"> reserved Percentage increase in extent size
PCT_THRESHOLD	NUMBER	<ul style="list-style-type: none"> reserved Threshold percentage of block space allowed per index entry
INCLUDE_COLUMN	NUMBER	<ul style="list-style-type: none"> reserved Column ID of the last column to be included in index-organized table primary key (non-overflow) index
FREELISTS	NUMBER	<ul style="list-style-type: none"> reserved Number of process freelists allocated to this segment
FREELIST_GROUPS	NUMBER	<ul style="list-style-type: none"> reserved Number of freelist groups allocated to this segment

Column name	Data type	Description
PCT_FREE	NUMBER	Minimum percentage of free space in a block
LOGGING	VARCHAR(3)	Indicates whether or not changes to the index are logged: (YES) or (NO)
BLOCKS	NUMBER	Number of used blocks in the index
BLEVEL	NUMBER	<ul style="list-style-type: none"> reserved B-Tree level (depth of the index from its root block to its leaf blocks)
LEAF_BLOCKS	NUMBER	<ul style="list-style-type: none"> reserved Number of leaf blocks in the index
DISTINCT_KEYS	NUMBER	Number of distinct indexed values.
AVG_LEAF_BLOCKS_PER_KEY	NUMBER	<ul style="list-style-type: none"> reserved Average number of leaf blocks in which each distinct value in the index appears, rounded to the nearest integer
AVG_DATA_BLOCKS_PER_KEY	NUMBER	<ul style="list-style-type: none"> reserved Average number of data blocks in the table that are pointed to by a distinct value in the index rounded to the nearest integer
CLUSTERING_FACTOR	NUMBER	<ul style="list-style-type: none"> reserved Indicates the amount of order of the rows in the table based on the values of the index
STATUS	VARCHAR(32)	<ul style="list-style-type: none"> reserved Indicates whether a nonpartitioned index is VALID or UNUSABLE
NUM_ROWS	NUMBER	<ul style="list-style-type: none"> reserved Number of rows in the index
SAMPLE_SIZE	NUMBER	Size of the sample used to analyze the index
LAST_ANALYZED	TIMESTAMP(6) WITHOUT TIME ZONE	Date on which this index was most recently analyzed
DEGREE	VARCHAR(32)	<ul style="list-style-type: none"> reserved Number of threads per instance for scanning the index, or DEFAULT
INSTANCES	VARCHAR(32)	<ul style="list-style-type: none"> reserved Number of instances across which the indexes to be scanned, or DEFAULT
PARTITIONED	VARCHAR(3)	<ul style="list-style-type: none"> reserved Indicates whether the index is partitioned (YES) or not (NO)
TEMPORARY	VARCHAR(1)	Indicates whether the index is on a temporary table (Y) or not (N)
GENERATED	VARCHAR(1)	Indicates whether the name of the index is system-generated (Y) or not (N)
SECONDARY	VARCHAR(1)	<ul style="list-style-type: none"> reserved Indicates whether the index is a secondary object created by the method of the Data Cartridge (Y) or not (N)
BUFFER_POOL	VARCHAR(32)	<ul style="list-style-type: none"> reserved Buffer pool to be used for index blocks
FLASH_CACHE	VARCHAR(32)	<ul style="list-style-type: none"> reserved Database Smart Flash Cache hint to be used for index blocks
CELL_FLASH_CACHE		<ul style="list-style-type: none"> reserved

Column name	Data type	Description
CHE	VARCHAR(32)	Cell flash cache hint to be used for index blocks
USER_STATS	VARCHAR(3)	<ul style="list-style-type: none"> reserved Indicates whether statistics were entered directly by the user (YES) or not (NO)
DURATION	VARCHAR(32)	<ul style="list-style-type: none"> reserved Indicates the duration of a temporary table
PCT_DIRECT_ACCESS	NUMBER	<ul style="list-style-type: none"> reserved For a secondary index on an index-organized table, the percentage of rows with VALID guess
ITYP_OWNER	VARCHAR(128)	<ul style="list-style-type: none"> reserved For a domain index, the owner of the indextype
ITYP_NAME	VARCHAR(128)	<ul style="list-style-type: none"> reserved For a domain index, the name of the indextype
PARAMETERS	VARCHAR(1024)	<ul style="list-style-type: none"> reserved For a domain index, the parameter string
GLOBAL_STATS	VARCHAR(3)	<ul style="list-style-type: none"> reserved For partitioned indexes, indicates whether statistics were collected by analyzing the index as a whole (YES) or were estimated from statistics on underlying index partitions and subpartitions (NO)
DOMIDX_STATUSES	VARCHAR(32)	<ul style="list-style-type: none"> reserved Status of a domain index
DOMIDX_OPSTATUSES	VARCHAR(32)	<ul style="list-style-type: none"> reserved Status of the operation on a domain index
FUNCIDX_STATUSES	VARCHAR(32)	<ul style="list-style-type: none"> reserved Status of a function-based index
JOIN_INDEX	VARCHAR(3)	<ul style="list-style-type: none"> reserved Indicates whether the index is a join index (YES) or not (NO)
IOT_REDUNDANT_KEY_ELIM	VARCHAR(3)	<ul style="list-style-type: none"> reserved Indicates whether redundant primary key columns are eliminated from secondary indexes on index-organized tables (YES) or not (NO)
DROPPED	VARCHAR(3)	Indicates whether the index has been dropped and is in the recycle bin (YES) or not (NO)
VISIBILITY	VARCHAR(3)	<ul style="list-style-type: none"> reserved Indicates whether the index is VISIBLE or INVISIBLE to the optimizer
DOMIDX_MANAGEMENT	VARCHAR(32)	<ul style="list-style-type: none"> reserved If this is a domain index, indicates whether the domain index is system-managed (SYSTEM_MANAGED) or user-managed (USER_MANAGED)
SEGMENT_CREATED	VARCHAR(3)	Indicates whether the index segment has been created (YES) or not (NO)
COMMENTS	VARCHAR(1024)	Comments of the index
EMPTY_BLOCKS	NUMBER	Number of empty blocks in the index

USER_IND_COLUMNS

USER_IND_COLUMNS describes the columns of the indexes owned by the current user and columns of indexes on tables owned by the current user.

Table 9-113 Column information

Column name	Data type	Description
INDEX_SCHEMA	VARCHAR(128)	Schema of the index
INDEX_NAME	VARCHAR(128)	Name of the index
TABLE_SCHEMA	VARCHAR(128)	Schema of the table or cluster
TABLE_NAME	VARCHAR(128)	Name of the table or cluster
COLUMN_NAME	VARCHAR(128)	Column name or attribute of the object type column
COLUMN_POSITION	NUMBER	Position of the column or attribute within the index
COLUMN_LENGTH	NUMBER	Indexed length of the column
CHAR_LENGTH	NUMBER	<ul style="list-style-type: none"> reserved Maximum codepoint length of the column
DESCEND	VARCHAR(32)	Indicates whether the column is sorted in descending order (DESC) or ascending order (ASC)
NULL_ORDER	VARCHAR(32)	Indicates whether the null value of the column is sorted in nulls first order (NULLS FIRST) or nulls last order (NULLS LAST)

USER_IND_PLACE

USER_IND_PLACE describes node placement of the indexes owned by the current user in the cluster system.



It is available only on a cluster.

Table 9-114 Column information

Column name	Data type	Description
INDEX_SCHEMA	VARCHAR(128)	Schema of the index
INDEX_NAME	VARCHAR(128)	Name of the index
TABLE_OWNER	VARCHAR(128)	Owner of the indexed object
TABLE_SCHEMA	VARCHAR(128)	Schema of the indexed object
TABLE_NAME	VARCHAR(128)	Name of the indexed object
GROUP_ID	NUMBER	Group identifier of the node where the index placed
GROUP_NAME	VARCHAR(128)	Group name of the node where the index placed
MEMBER_ID	NUMBER	Member identifier of the node where the index placed
MEMBER_NAME	VARCHAR(128)	Member name of the node where the index placed
MEMBER_OFFLINE	BOOLEAN	data of the cluster member is offline or not
DISTINCT_KEYS	NUMBER	(deprecated)
SAMPLE_SIZE	NUMBER	(deprecated)
BLOCKS	NUMBER	Number of used blocks of the node where the index placed
LAST_ANALYZED	TIMESTAMP(2) WITH OUT TIME ZONE	(deprecated)

USER_OBJECTS

USER_OBJECTS describes all objects owned by the current user.

Table 9-115 Column information

Column name	Data type	Description
SCHEMA_NAME	VARCHAR(128)	Schema of the object
OBJECT_NAME	VARCHAR(128)	Name of the object
SUBOBJECT_NAME	VARCHAR(128)	Name of the subobject (for example, partition)
OBJECT_ID	NUMBER	Dictionary object number of the object
DATA_OBJECT_ID	NUMBER	Dictionary object number of the segment that contains the object
OBJECT_TYPE	VARCHAR(32)	Type of the object (such as TABLE, INDEX)
CREATED	TIMESTAMP(2) WITHOUT TIME ZONE	Timestamp for the creation of the object
LAST_DDL_TIME	TIMESTAMP(2) WITHOUT TIME ZONE	Timestamp for the last modification of the object resulting from a DDL statement
TIMESTAMP	VARCHAR(32)	Timestamp for the specification of the object (character data)
STATUS	VARCHAR(32)	<ul style="list-style-type: none"> reserved Status of the object: the value in (VALID, INVALID, N/A)
TEMPORARY	VARCHAR(1)	Indicates whether the object is temporary (the current session can see only data that it placed in this object itself) (Y) or not (N)
GENERATED	VARCHAR(1)	Indicates whether the name of this object was system-generated (Y) or not (N)
SECONDARY	VARCHAR(1)	<ul style="list-style-type: none"> reserved Indicates whether this is a secondary object created by the ODCIIndex Create method of the Oracle Data Cartridge (Y) or not (N)
NAMESPACE	NUMBER	Namespace for the object
EDITION_NAME	VARCHAR(128)	<ul style="list-style-type: none"> reserved Name of the edition in which the object is actual

USER_PROCEDURES

USER_PROCEDURES lists of procedures owned by the current user.

Table 9-116 Column information

Column name	Data type	Description
SCHEMA_NAME	VARCHAR(128)	Schema Name of function, procedures or package
OBJECT_NAME	VARCHAR(128)	Name of function, procedures or package
PROCEDURE_NAME	VARCHAR(128)	Name when a procedure in package
OBJECT_ID	NUMBER	ID of a function, procedures or package
SUBPROGRAM_ID	NUMBER	ID of procedure in package
OVERLOAD	VARCHAR(32)	ID of overloading procedure in package
OBJECT_TYPE	VARCHAR(32)	Type of function, procedures or package
AGGREGATE	VARCHAR(3)	Indicate whether the procedure is an aggregate function (YES) or not (NO)
PIPELINED	VARCHAR(3)	Indicate whether the procedure is a pipelined table function (YES) or not (NO)
IMPLTYPEOWNER	VARCHAR(128)	Name of the owner of the implementation type, if any
IMPLTYPENAME	VARCHAR(128)	Name of the implementation type, if any
PARALLEL	VARCHAR(3)	Indicates whether the procedure or function is parallel-enabled (YES) or not (NO)
INTERFACE	VARCHAR(3)	YES, if the procedure/function is a table function implemented using the SQLCLI interface; otherwise NO
DETERMINISTIC	VARCHAR(3)	YES, if the procedure/function is declared to be deterministic; otherwise NO
AUTHID	VARCHAR(32)	Indicates whether the procedure/function is declared to execute as DEFINER or CURRENT_USER (invoker)

USER_PROC_PRIVS

USER_PROC_PRIVS describes the procedure grants for which the current user is the procedure owner, grantor, or grantee.

Table 9-117 Column information

Column name	Data type	Description
GRANTOR	VARCHAR(128)	Name of the user who performed the grant
GRANTEE	VARCHAR(128)	Name of the user or role to whom access was granted
PROCEDURE_OWNER	VARCHAR(128)	Owner of the procedure, function or package
PROCEDURE_SCHEMA	VARCHAR(128)	Schema of the procedure, function or package
PROCEDURE_NAME	VARCHAR(128)	Name of the procedure, function or package
PRIVILEGE	VARCHAR(32)	Privilege on the procedure, function or package
GRANTABLE	VARCHAR(3)	Indicates whether the privilege was granted with the GRANT OPTION (YES) or not (NO)

USER_PROC_PRIVS_MADE

USER_PROC_PRIVS_MADE describes the procedure grants for which the current user is the procedure owner or grantor.

Table 9-118 Column information

Column name	Data type	Description
GRANTOR	VARCHAR(128)	Name of the user who performed the grant
GRANTEE	VARCHAR(128)	Name of the user or role to whom access was granted
PROCEDURE_OWNER	VARCHAR(128)	Owner of the procedure, function or package
PROCEDURE_SCHEMA	VARCHAR(128)	Schema of the procedure, function or package
PROCEDURE_NAME	VARCHAR(128)	Name of the procedure, function or package
PRIVILEGE	VARCHAR(32)	Privilege on the procedure, function or package
GRANTABLE	VARCHAR(3)	Indicates whether the privilege was granted with the GRANT OPTION (YES) or not (NO)

USER_PROC_PRIVS_RECD

USER_PROC_PRIVS_RECD describes the procedure grants, for which the current user is the grantee, or for which an enabled role or PUBLIC is the grantee.

Table 9-119 Column information

Column name	Data type	Description
GRANTOR	VARCHAR(128)	Name of the user who performed the grant
GRANTEE	VARCHAR(128)	Name of the user or role to whom access was granted
PROCEDURE_OWNER	VARCHAR(128)	Owner of the procedure, function or package
PROCEDURE_SCHEMA	VARCHAR(128)	Schema of the procedure, function or package
PROCEDURE_NAME	VARCHAR(128)	Name of the procedure, function or package
PRIVILEGE	VARCHAR(32)	Privilege on the procedure, function or package
GRANTABLE	VARCHAR(3)	Indicates whether the privilege was granted with the GRANT OPTION (YES) or not (NO)

USER_SCHEMAS

USER_SCHEMAS identifies the schemata in a catalog that are owned by current user.

Table 9-120 Column information

Column name	Data type	Description
SCHEMA_OWNER	VARCHAR(128)	Owner of the schema
SCHEMA_NAME	VARCHAR(128)	Name of the schema
CREATED_TIME	TIMESTAMP(2) WITHOUT TIME ZONE	Created time of the schema
MODIFIED_TIME	TIMESTAMP(2) WITHOUT TIME ZONE	Last modified time of the schema
COMMENTS	VARCHAR(1024)	Comments of the schema

USER_SCHEMA_PATH

USER_SCHEMA_PATH describes the schema search order of the current user, for naming resolution of unqualified SQL schema objects.

Table 9-121 Column information

Column name	Data type	Description
AUTH_NAME	VARCHAR(128)	Name of the user
SCHEMA_NAME	VARCHAR(128)	Name of the schema
SEARCH_ORDER	NUMBER	Schema search order of the user

USER_SCHEMA_PRIVS

USER_SCHEMA_PRIVS describes the schema grants, for which the current user is the schema owner, grantor, or grantee.

Table 9-122 Column information

Column name	Data type	Description
GRANTOR	VARCHAR(128)	Name of the user who performed the grant
GRANTEE	VARCHAR(128)	Name of the user or role to whom access was granted
OWNER	VARCHAR(128)	Owner of the schema
SCHEMA_NAME	VARCHAR(128)	Name of the schema
PRIVILEGE	VARCHAR(32)	Privilege on the schema
GRANTABLE	VARCHAR(3)	Indicates whether the privilege was granted with the GRANT OPTION (YES) or not (NO)

USER_SCHEMA_PRIVS_MADE

USER_SCHEMA_PRIVS_MADE describes the schema grants for which the current user is the schema owner.

Table 9-123 Column information

Column name	Data type	Description
GRANTOR	VARCHAR(128)	Name of the user who performed the grant
GRANTEE	VARCHAR(128)	Name of the user or role to whom access was granted
OWNER	VARCHAR(128)	Owner of the schema
SCHEMA_NAME	VARCHAR(128)	Name of the schema
PRIVILEGE	VARCHAR(32)	Privilege on the schema
GRANTABLE	VARCHAR(3)	Indicates whether the privilege was granted with the GRANT OPTION (YES) or not (NO)

USER_SCHEMA_PRIVS_REC'D

USER_SCHEMA_PRIVS_REC'D describes the schema grants for which the current user is the grantee.

Table 9-124 Column information

Column name	Data type	Description
GRANTOR	VARCHAR(128)	Name of the user who performed the grant
GRANTEE	VARCHAR(128)	Name of the user or role to whom access was granted
OWNER	VARCHAR(128)	Owner of the schema
SCHEMA_NAME	VARCHAR(128)	Name of the schema
PRIVILEGE	VARCHAR(32)	Privilege on the schema
GRANTABLE	VARCHAR(3)	Indicates whether the privilege was granted with the GRANT OPTION (YES) or not (NO)

USER_SEQUENCES

USER_SEQUENCES describes all sequences owned by the current user.

Table 9-125 Column information

Column name	Data type	Description
SEQUENCE_OWNER	VARCHAR(128)	Owner of the sequence
SEQUENCE_SCHEMA	VARCHAR(128)	Schema of the sequence
SEQUENCE_NAME	VARCHAR(128)	Sequence name
MIN_VALUE	NUMBER	Minimum value of the sequence
MAX_VALUE	NUMBER	Maximum value of the sequence
INCREMENT_BY	NUMBER	Value by which sequence is incremented
CYCLE_FLAG	VARCHAR(1)	Indicates whether the sequence wraps around on reaching the limit (Y) or not (N)
ORDER_FLAG	VARCHAR(1)	<ul style="list-style-type: none"> reserved Indicates whether sequence numbers are generated in order (Y) or not (N)
CACHE_SIZE	NUMBER	Number of sequence numbers to cache
LAST_NUMBER	NUMBER	Last sequence number written to database. If a sequence uses caching, the number written to database is the last number placed in the sequence cache.
COMMENTS	VARCHAR(1024)	Comments of the sequence

USER_SEQ_PRIVS

USER_SEQ_PRIVS describes the sequence grants for which the current user is the sequence owner, grant or, or grantee.

Table 9-126 Column information

Column name	Data type	Description
GRANTOR	VARCHAR(128)	Name of the user who performed the grant
GRANTEE	VARCHAR(128)	Name of the user or role to whom access was granted
SEQUENCE_OWNER	VARCHAR(128)	Owner of the sequence
SEQUENCE_SCHEM A	VARCHAR(128)	Schema of the sequence
SEQUENCE_NAME	VARCHAR(128)	Name of the sequence
PRIVILEGE	VARCHAR(32)	Privilege on the sequence
GRANTABLE	VARCHAR(3)	Indicates whether the privilege was granted with the GRANT OPTION (YES) or not (NO)

USER_SEQ_PRIVS_MADE

USER_SEQ_PRIVS_MADE describes the sequence grants for which the current user is the sequence owner.

Table 9-127 Column information

Column name	Data type	Description
GRANTOR	VARCHAR(128)	Name of the user who performed the grant
GRANTEE	VARCHAR(128)	Name of the user or role to whom access was granted
SEQUENCE_OWNER	VARCHAR(128)	Owner of the sequence
SEQUENCE_SCHEMA	VARCHAR(128)	Schema of the sequence
SEQUENCE_NAME	VARCHAR(128)	Name of the sequence
PRIVILEGE	VARCHAR(32)	Privilege on the sequence
GRANTABLE	VARCHAR(3)	Indicates whether the privilege was granted with the GRANT OPTION (YES) or not (NO)

USER_SEQ_PRIVS_REC'D

USER_SEQ_PRIVS_REC'D describes the sequence grants for which the current user is the grantee.

Table 9-128 Column information

Column name	Data type	Description
GRANTOR	VARCHAR(128)	Name of the user who performed the grant
GRANTEE	VARCHAR(128)	Name of the user or role to whom access was granted
SEQUENCE_OWNER	VARCHAR(128)	Owner of the sequence
SEQUENCE_SCHEMA	VARCHAR(128)	Schema of the sequence
SEQUENCE_NAME	VARCHAR(128)	Name of the sequence
PRIVILEGE	VARCHAR(32)	Privilege on the sequence
GRANTABLE	VARCHAR(3)	Indicates whether the privilege was granted with the GRANT OPTION (YES) or not (NO)

USER_SHARD_KEY_COLUMNS

USER_SHARD_KEY_COLUMNS describes shard key columns of shared tables owned by the current user in the cluster system.



It is available only on a cluster.

Table 9-129 Column information

Column name	Data type	Description
TABLE_SCHEMA	VARCHAR(128)	Schema of the table
TABLE_NAME	VARCHAR(128)	Name of the table
COLUMN_NAME	VARCHAR(128)	Column name of the shard key
COLUMN_POSITION	NUMBER	Position of the column within the shard key

USER_SOURCE

USER_SOURCE describes the text source of the stored objects accessible to the current user.

Table 9-130 Column information

Column name	Data type	Description
SCHEMA_NAME	VARCHAR(128)	Schema Name of object
NAME	VARCHAR(128)	Name of object
TYPE	VARCHAR(32)	Type of object: FUNCTION, PROCEDURE, PACKAGE, PACKAGE BODY, TRIGGER
LINE	NUMBER	Line number of this line of source
TEXT	LONG VARCHAR	Text source of the stored object
ORIGIN_CON_ID	VARCHAR(256)	ID of the container where the data originates

USER_SYNONYMS

USER_SYNONYMS describes all synonyms owned by the current user.

Table 9-131 Column information

Column name	Data type	Description
SYNONYM_OWNER	VARCHAR(128)	Owner of the synonym
SYNONYM_SCHEMA	VARCHAR(128)	Schema of the synonym
SYNONYM_NAME	VARCHAR(128)	Synonym name
OBJECT_SCHEMA_NAME	VARCHAR(128)	Object schema name
OBJECT_NAME	VARCHAR(128)	Object name
DB_LINK	VARCHAR(128)	Reserved for future use

USER_SYS_PRIVS

USER_SYS_PRIVS describes system (database, tablespace, schema) privileges granted to the current user or PUBLIC.

Table 9-132 Column information

Column name	Data type	Description
USERNAME	VARCHAR(128)	Name of the user, or PUBLIC
PRIVILEGE	VARCHAR(256)	System(database, tablespace, schema) privilege
GRANTABLE	VARCHAR(3)	Indicates whether the privilege was granted with the GRANT OPTION (YES) or not (NO)
ADMIN_OPTION	VARCHAR(3)	equal to GRANTABLE column

USER_TABLES

USER_TABLES describes the relational tables owned by the current user.

Table 9-133 Column information

Column name	Data type	Description
TABLE_SCHEMA	VARCHAR(128)	Schema of the table
TABLE_NAME	VARCHAR(128)	Name of the table
TABLESPACE_NAME	VARCHAR(128)	Name of the tablespace containing the table
CLUSTER_NAME	VARCHAR(128)	<ul style="list-style-type: none"> reserved Name of the cluster
IOT_NAME	VARCHAR(128)	<ul style="list-style-type: none"> reserved Name of the index-organized table
STATUS	VARCHAR(32)	<ul style="list-style-type: none"> reserved If a previous DROP TABLE operation failed, indicates whether the table is unusable (UNUSABLE) or valid (VALID)
PCT_FREE	NUMBER	Minimum percentage of free space in a block
PCT_USED	NUMBER	Minimum percentage of used space in a block
INI_TRANS	NUMBER	Initial number of transactions
MAX_TRANS	NUMBER	Maximum number of transactions
INITIAL_EXTENT	NUMBER	Size of the initial extent (in bytes)
NEXT_EXTENT	NUMBER	Size of secondary extents (in bytes)
MIN_EXTENTS	NUMBER	Minimum number of extents allowed in the segment
MAX_EXTENTS	NUMBER	Maximum number of extents allowed in the segment
PCT_INCREASE	NUMBER	<ul style="list-style-type: none"> reserved Percentage increase in extent size
FREELISTS	NUMBER	<ul style="list-style-type: none"> reserved Number of process freelists allocated to the segment
FREELIST_GROUPS	NUMBER	<ul style="list-style-type: none"> reserved Number of freelist groups allocated to the segment
LOGGING	VARCHAR(3)	Indicates whether or not changes to the table are logged
BACKED_UP	VARCHAR(1)	<ul style="list-style-type: none"> reserved Indicates whether the table has been backed up since the last modification (Y) or not (N)
NUM_ROWS	NUMBER	Number of rows in the table
BLOCKS	NUMBER	Number of used blocks in the table
EMPTY_BLOCKS	NUMBER	<ul style="list-style-type: none"> reserved Number of empty (never used) blocks in the table
AVG_SPACE	NUMBER	<ul style="list-style-type: none"> reserved Average available free space in the table
		<ul style="list-style-type: none"> reserved

Column name	Data type	Description
CHAIN_CNT	NUMBER	Number of rows in the table that are chained from one data block to another or that have migrated to a new block, requiring a link to preserve the old rowid
AVG_ROW_LEN	NUMBER	<ul style="list-style-type: none"> reserved Average row length, including row overhead
AVG_SPACE_FREELIST_BLOCKS	NUMBER	<ul style="list-style-type: none"> reserved Average freespace of all blocks on a freelist
NUM_FREELIST_BLOCKS	NUMBER	<ul style="list-style-type: none"> reserved Number of blocks on the freelist
DEGREE	VARCHAR(32)	<ul style="list-style-type: none"> reserved Number of threads per instance for scanning the table, or DEFAULT
INSTANCES	VARCHAR(32)	<ul style="list-style-type: none"> reserved Number of instances across which the table is to be scanned, or DEFAULT
CACHE	VARCHAR(1)	<ul style="list-style-type: none"> reserved Indicates whether the table is to be cached in the buffer cache (Y) or not (N)
TABLE_LOCK	VARCHAR(32)	Indicates whether table locking is enabled (ENABLED) or disabled (DISABLED)
SAMPLE_SIZE	NUMBER	Sample size used in analyzing the table
LAST_ANALYZED	TIMESTAMP(6) WITHOUT TIME ZONE	Date on which the table was most recently analyzed
PARTITIONED	VARCHAR(3)	<ul style="list-style-type: none"> reserved Indicates whether the table is partitioned (YES) or not (NO)
IOT_TYPE	VARCHAR(32)	<ul style="list-style-type: none"> reserved If the table is an index-organized table, then IOT_TYPE is IOT, IOT_OVERFLOW, or IOT_MAPPING.
TEMPORARY	VARCHAR(1)	Indicates whether the table is temporary (Y) or not (N)
SECONDARY	VARCHAR(1)	<ul style="list-style-type: none"> reserved Indicates whether the table is a secondary object created by cartridge
NESTED	VARCHAR(3)	<ul style="list-style-type: none"> reserved Indicates whether the table is a nested table (YES) or not (NO)
BUFFER_POOL	VARCHAR(32)	<ul style="list-style-type: none"> reserved Buffer pool to be used for table blocks
FLASH_CACHE	VARCHAR(32)	<ul style="list-style-type: none"> reserved Database Smart Flash Cache hint to be used for table blocks
CELL_FLASH_CACHE	VARCHAR(32)	<ul style="list-style-type: none"> reserved Cell flash cache hint to be used for table blocks
ROW_MOVEMENT	VARCHAR(32)	<ul style="list-style-type: none"> reserved If a partitioned table, indicates whether row movement is enabled (ENABLED) or disabled (DISABLED)

Column name	Data type	Description
GLOBAL_STATS	VARCHAR(3)	<ul style="list-style-type: none"> reserved For partitioned tables, indicates whether statistics for the table as a whole (global statistics) are accurate (YES)
USER_STATS	VARCHAR(3)	<ul style="list-style-type: none"> reserved Indicates whether statistics were entered directly by the user (YES) or not (NO)
DURATION	VARCHAR(32)	<ul style="list-style-type: none"> reserved Indicates the duration of a temporary table
SKIP_CORRUPT	VARCHAR(32)	<ul style="list-style-type: none"> reserved Indicates whether Database ignores blocks marked corrupt during table and index scans (ENABLED) or raises an error (DISABLED)
MONITORING	VARCHAR(3)	<ul style="list-style-type: none"> reserved Indicates whether the table has the MONITORING attribute set (YES) or not (NO)
CLUSTER_OWNER	VARCHAR(128)	<ul style="list-style-type: none"> reserved Owner of the cluster, if any
DEPENDENCIES	VARCHAR(32)	<ul style="list-style-type: none"> reserved Indicates whether row-level dependency tracking is enabled (ENABLED) or disabled (DISABLED)
COMPRESSION	VARCHAR(32)	<ul style="list-style-type: none"> reserved Indicates whether table compression is enabled (ENABLED) or not (DISABLED)
COMPRESS_FOR	VARCHAR(32)	<ul style="list-style-type: none"> reserved Default compression for what kind of operations
DROPPED	VARCHAR(3)	<ul style="list-style-type: none"> reserved Indicates whether the table has been dropped and is in the recycle bin (YES) or not (NO)
READ_ONLY	VARCHAR(3)	Indicates whether the table IS READ-ONLY (YES) or not (NO)
SEGMENT_CREATED	VARCHAR(3)	Indicates whether the table segment has been created (YES) or not (NO)
RESULT_CACHE	VARCHAR(32)	<ul style="list-style-type: none"> reserved Result cache mode annotation for the table: the value in (NULL, DEFAULT, FORCE, MANUAL)

USER_TABLESPACES

USER_TABLESPACES describes the tablespaces accessible to the current user.

Table 9-134 Column information

Column name	Data type	Description
TABLESPACE_NAME	VARCHAR(128)	Name of the tablespace
BLOCK_SIZE	NUMBER	Tablespace block size
INITIAL_EXTENT	NUMBER	<ul style="list-style-type: none"> reserved Default initial extent size (in bytes)
NEXT_EXTENT	NUMBER	<ul style="list-style-type: none"> reserved Default incremental extent size (in bytes)
MIN_EXTENTS	NUMBER	<ul style="list-style-type: none"> reserved Default minimum number of extents
MAX_EXTENTS	NUMBER	<ul style="list-style-type: none"> reserved Default maximum number of extents
MAX_SIZE	NUMBER	<ul style="list-style-type: none"> reserved Default maximum size of segments
PCT_INCREASE	NUMBER	<ul style="list-style-type: none"> reserved Default percent increase for extent size
MIN_EXTLEN	NUMBER	<ul style="list-style-type: none"> reserved Minimum extent size for this tablespace (in bytes)
STATUS	VARCHAR(32)	Tablespace status: the value in (ONLINE, OFFLINE, READ ONLY)
CONTENTS	VARCHAR(32)	Tablespace contents: the value in (SYSTEM, DATA, TEMPORARY, UNDO)
LOGGING	VARCHAR(32)	Default logging attribute: LOGGING, NOLOGGING
FORCE_LOGGING	VARCHAR(3)	<ul style="list-style-type: none"> reserved Indicates whether the tablespace is under force logging mode (YES) or not (NO)
EXTENT_MANAGEMENT	VARCHAR(32)	<ul style="list-style-type: none"> reserved Indicates whether the extents in the tablespace are dictionary managed (DICTIONARY) or locally managed (LOCAL)
ALLOCATION_TYPE	VARCHAR(32)	<ul style="list-style-type: none"> reserved Type of extent allocation in effect for the tablespace: the value in (SYSTEM, UNIFORM, USER)
SEGMENT_SPACE_MANAGEMENT	VARCHAR(32)	<ul style="list-style-type: none"> reserved Indicates whether the free and used segment space in the tablespace is managed using free lists (MANUAL) or bitmaps (AUTO)
DEF_TAB_COMPRESSION	VARCHAR(32)	<ul style="list-style-type: none"> reserved Indicates whether default table compression is enabled (ENABLED) or not (DISABLED)
		<ul style="list-style-type: none"> reserved

Column name	Data type	Description
RETENTION	VARCHAR(32)	Undo tablespace retention: the value in (GUARANTEE, NOGUARANTEE, NOT APPLY)
BIGFILE	VARCHAR(3)	<ul style="list-style-type: none"> reserved Indicates whether the tablespace is a bigfile tablespace (YES) or a smallfile tablespace (NO)
PREDICATE_EVALUATION	VARCHAR(32)	<ul style="list-style-type: none"> reserved Indicates whether predicates are evaluated by host (HOST) or by storage (STORAGE)
ENCRYPTED	VARCHAR(3)	<ul style="list-style-type: none"> reserved Indicates whether the tablespace is encrypted (YES) or not (NO)
COMPRESS_FOR	VARCHAR(32)	<ul style="list-style-type: none"> reserved Indicates whether the tablespace is encrypted (YES) or not (NO)

USER_TAB_COLS

USER_TAB_COLS describes the columns (including hidden columns) of the tables, views, and clusters owned by the current user.

Table 9-135 Column information

Column name	Data type	Description
TABLE_SCHEMA	VARCHAR(128)	Schema of the object
TABLE_NAME	VARCHAR(128)	Name of the object
COLUMN_NAME	VARCHAR(128)	Column name
DATA_TYPE	VARCHAR(128)	Datatype of the column
DATA_TYPE_MOD	VARCHAR(3)	<ul style="list-style-type: none"> reserved Datatype modifier of the column
DATA_TYPE_OWNER	VARCHAR(128)	<ul style="list-style-type: none"> reserved Owner of the datatype of the column
DATA_LENGTH	NUMBER	Length of the column (in bytes)
DATA_PRECISION	NUMBER	Decimal precision for NUMBER datatype; binary precision for FLOAT datatype; NULL for all other datatypes
DATA_SCALE	NUMBER	Digits to the right of the decimal point in a number
NULLABLE	VARCHAR(1)	Indicates whether a column allows NULLs.
COLUMN_ID	NUMBER	Sequence number of the column as created
DEFAULT_LENGTH	NUMBER	Length of the default value for the column
DATA_DEFAULT	LONG VARCHAR	Default value for the column
NUM_DISTINCT	NUMBER	Number of distinct values in the column
LOW_VALUE	VARBINARY(32)	Low value in the column
HIGH_VALUE	VARBINARY(32)	High value in the column
DENSITY	NUMBER	<ul style="list-style-type: none"> reserved If a histogram is available on COLUMN_NAME, then this column displays the selectivity of a value that spans fewer than 2 endpoints in the histogram.
NUM_NULLS	NUMBER	Number of NULLs in the column
NUM_BUCKETS	NUMBER	<ul style="list-style-type: none"> reserved Number of buckets in the histogram for the column
LAST_ANALYZED	TIMESTAMP(6) WITHOUT TIME ZONE	Date on which this column was most recently analyzed
SAMPLE_SIZE	NUMBER	Sample size used in analyzing this column
CHARACTER_SET_NAME	VARCHAR(128)	<ul style="list-style-type: none"> reserved Name of the character set
CHAR_COL_DECL_LENGTH	NUMBER	Declaration length of the character type column
GLOBAL_STATS	VARCHAR(3)	<ul style="list-style-type: none"> reserved For partitioned tables, indicates whether column statistics were collected for the table

Column name	Data type	Description
USER_STATS	VARCHAR(3)	<ul style="list-style-type: none"> reserved Indicates whether statistics were entered directly by the user (YES) or not (NO)
AVG_COL_LEN	NUMBER	Average length of the column (in bytes)
CHAR_LENGTH	NUMBER	Displays the length of the column in characters.
CHAR_USED	VARCHAR(1)	Indicates that the column uses BYTE length semantics (B) or CHARACTER length semantics (C)
V80_FMT_IMAGE	VARCHAR(3)	<ul style="list-style-type: none"> reserved Indicates whether the column data is in release older image format (YES) or not (NO)
DATA_UPGRADED	VARCHAR(3)	<ul style="list-style-type: none"> reserved Indicates whether the column data has been upgraded to the latest type version format (YES) or not (NO)
HIDDEN_COLUMN	VARCHAR(3)	Indicates whether the column is a hidden column (YES) or not (NO)
VIRTUAL_COLUMN	VARCHAR(3)	<ul style="list-style-type: none"> reserved Indicates whether the column is a virtual column (YES) or not (NO)
SEGMENT_COLUMN_ID	NUMBER	Sequence number of the column in the segment
INTERNAL_COLUMN_ID	NUMBER	Internal sequence number of the column
HISTOGRAM	VARCHAR(32)	<ul style="list-style-type: none"> reserved Indicates existence/type of histogram
QUALIFIED_COL_NAME	VARCHAR(4000)	Qualified column name
IDENTITY_COLUMN	VARCHAR(3)	Indicates whether this is an identity column (YES) or not (NO)

USER_TAB_COLUMNS

USER_TAB_COLUMNS describes the columns of the tables, views, and clusters owned by the current user.

Table 9-136 Column information

Column name	Data type	Description
TABLE_SCHEMA	VARCHAR(128)	Schema of the object
TABLE_NAME	VARCHAR(128)	Name of the object
COLUMN_NAME	VARCHAR(128)	Column name
DATA_TYPE	VARCHAR(128)	Datatype of the column
DATA_TYPE_MOD	VARCHAR(3)	<ul style="list-style-type: none"> reserved Datatype modifier of the column
DATA_TYPE_OWNER	VARCHAR(128)	<ul style="list-style-type: none"> reserved Owner of the datatype of the column
DATA_LENGTH	NUMBER	Length of the column (in bytes)
DATA_PRECISION	NUMBER	Decimal precision for NUMBER datatype; binary precision for FLOAT datatype; NULL for all other datatypes
DATA_SCALE	NUMBER	Digits to the right of the decimal point in a number
NULLABLE	VARCHAR(1)	Indicates whether a column allows NULLs.
COLUMN_ID	NUMBER	Sequence number of the column as created
DEFAULT_LENGTH	NUMBER	Length of the default value for the column
DATA_DEFAULT	LONG VARCHAR	Default value for the column
NUM_DISTINCT	NUMBER	Number of distinct values in the column
LOW_VALUE	VARBINARY(32)	Low value in the column
HIGH_VALUE	VARBINARY(32)	High value in the column
DENSITY	NUMBER	<ul style="list-style-type: none"> reserved If a histogram is available on COLUMN_NAME, then this column displays the selectivity of a value that spans fewer than 2 endpoints in the histogram.
NUM_NULLS	NUMBER	Number of NULLs in the column
NUM_BUCKETS	NUMBER	<ul style="list-style-type: none"> reserved Number of buckets in the histogram for the column
LAST_ANALYZED	TIMESTAMP(6) WITH OUT TIME ZONE	Date on which this column was most recently analyzed
SAMPLE_SIZE	NUMBER	Sample size used in analyzing this column
CHARACTER_SET_NAME	VARCHAR(128)	<ul style="list-style-type: none"> reserved Name of the character set
CHAR_COL_DECL_LENGTH	NUMBER	Declaration length of the character type column
GLOBAL_STATS	VARCHAR(3)	<ul style="list-style-type: none"> reserved For partitioned tables, indicates whether column statistics were collected for the table

Column name	Data type	Description
USER_STATS	VARCHAR(3)	<ul style="list-style-type: none"> reserved Indicates whether statistics were entered directly by the user (YES) or not (NO)
AVG_COL_LEN	NUMBER	Average length of the column (in bytes)
CHAR_LENGTH	NUMBER	Displays the length of the column in characters.
CHAR_USED	VARCHAR(1)	Indicates that the column uses BYTE length semantics (B) or CHAR length semantics (C)
V80_FMT_IMAGE	VARCHAR(3)	<ul style="list-style-type: none"> reserved Indicates whether the column data is in release older image format (YES) or not (NO)
DATA_UPGRADED	VARCHAR(3)	<ul style="list-style-type: none"> reserved Indicates whether the column data has been upgraded to the latest type version format (YES) or not (NO)
HISTOGRAM	VARCHAR(32)	<ul style="list-style-type: none"> reserved Indicates existence/type of histogram
IDENTITY_COLUMN	VARCHAR(3)	Indicates whether this is an identity column (YES) or not (NO)

USER_TAB_COMMENTS

USER_TAB_COMMENTS displays comments on the tables and views owned by the current user.

Table 9-137 Column information

Column name	Data type	Description
TABLE_SCHEMA	VARCHAR(128)	Schema of the object
TABLE_NAME	VARCHAR(128)	Name of the object
TABLE_TYPE	VARCHAR(32)	Type of the object
COMMENTS	VARCHAR(1024)	Comment on the object

USER_TAB_IDENTITY_COLS

USER_TAB_IDENTITY_COLS describes all table identity columns.

Table 9-138 Column information

Column name	Data type	Description
TABLE_SCHEMA	VARCHAR(128)	Schema of the table
TABLE_NAME	VARCHAR(128)	Name of the table
COLUMN_NAME	VARCHAR(128)	Name of the identity column
GENERATION_TYPE	VARCHAR(32)	Generation type of the identity column. Possible values are ALWAYS or BY DEFAULT
IDENTITY_OPTIONS	VARCHAR(1024)	Options for the identity column sequence generator

USER_TAB_PLACE

USER_TAB_PLACE describes node placement of cluster tables owned by the current user in the cluster system.



It is available only on a cluster.

Table 9-139 Column information

Column name	Data type	Description
TABLE_SCHEMA	VARCHAR(128)	Schema of the table
TABLE_NAME	VARCHAR(128)	Name of the table
GROUP_ID	NUMBER	Group identifier of the node where the table placed
GROUP_NAME	VARCHAR(128)	Group name of the node where the table placed
MEMBER_ID	NUMBER	Member identifier of the node where the table placed
MEMBER_NAME	VARCHAR(128)	Member name of the node where the table placed
MEMBER_OFFLINE	BOOLEAN	data of the cluster member is offline or not
SCN	VARCHAR(64)	table scn of the node where the table placed
NUM_ROWS	NUMBER	Number of rows in the table
BLOCKS	NUMBER	Number of used blocks of the node where the table placed
LAST_ANALYZED	TIMESTAMP(6) WITH OUT TIME ZONE	Date on which the table was most recently analyzed

USER_TAB_PRIVS

USER_TAB_PRIVS describes the object grants for which the current user is the object owner, grantor, or grantee.

Table 9-140 Column information

Column name	Data type	Description
GRANTEE	VARCHAR(128)	Name of the user or role to whom access was granted
OWNER	VARCHAR(128)	Owner of the object
TABLE_SCHEMA	VARCHAR(128)	Schema of the object
TABLE_NAME	VARCHAR(128)	Name of the object
GRANTOR	VARCHAR(128)	Name of the user who performed the grant
PRIVILEGE	VARCHAR(32)	Privilege on the object
GRANTABLE	VARCHAR(3)	Indicates whether the privilege was granted with the GRANT OPTION (YES) or not (NO)
HIERARCHY	VARCHAR(3)	Indicates whether the privilege was granted with the HIERARCHY OPTION (YES) or not (NO)

USER_TAB_PRIVS_MADE

USER_TAB_PRIVS_MADE describes the object grants for which the current user is the object owner.

Table 9-141 Column information

Column name	Data type	Description
GRANTEE	VARCHAR(128)	Name of the user or role to whom access was granted
TABLE_SCHEMA	VARCHAR(128)	Schema of the object
TABLE_NAME	VARCHAR(128)	Name of the object
GRANTOR	VARCHAR(128)	Name of the user who performed the grant
PRIVILEGE	VARCHAR(32)	Privilege on the object
GRANTABLE	VARCHAR(3)	Indicates whether the privilege was granted with the GRANT OPTION (YES) or not (NO)
HIERARCHY	VARCHAR(3)	Indicates whether the privilege was granted with the HIERARCHY OPTION (YES) or not (NO)

USER_TAB_PRIVS_RECD

USER_TAB_PRIVS_RECD describes the object grants for which the current user is the grantee.

Table 9-142 Column information

Column name	Data type	Description
OWNER	VARCHAR(128)	Owner of the object
TABLE_SCHEMA	VARCHAR(128)	Schema of the object
TABLE_NAME	VARCHAR(128)	Name of the object
GRANTOR	VARCHAR(128)	Name of the user who performed the grant
PRIVILEGE	VARCHAR(32)	Privilege on the object
GRANTABLE	VARCHAR(3)	Indicates whether the privilege was granted with the GRANT OPTION (YES) or not (NO)
HIERARCHY	VARCHAR(3)	Indicates whether the privilege was granted with the HIERARCHY OPTION (YES) or not (NO)

USER_TAB_SHARDS

USER_TAB_SHARDS describes shard information of sharded tables owned by the current user in the cluster system.



It is available only on a cluster.

Table 9-143 Column information

Column name	Data type	Description
TABLE_SCHEMA	VARCHAR(128)	Schema of the table
TABLE_NAME	VARCHAR(128)	Name of the table
SHARD_STRATEGY	VARCHAR(32)	Sharding strategy of the table: the value in (HASH SHARDING, RANGE SHARDING, LIST SHARDING)
SHARD_NAME	VARCHAR(128)	Shard name
SHARD_NUMBER	NUMBER	Shard number
SHARD_DEFINITION	LONG VARCHAR	Shard definition (if hash sharded, the value is null)
GROUP_ID	NUMBER	Group identifier where the shard placed
GROUP_NAME	VARCHAR(128)	Group Name where the shard placed

USER_USERS

USER_USERS describes the current user.

Table 9-144 Column information

Column name	Data type	Description
USERNAME	VARCHAR(128)	Name of the user
USER_ID	NUMBER	ID number of the user
ACCOUNT_STATUS	VARCHAR(32)	Account status: the value in (OPEN, EXPIRED, EXPIRED(GRACE), LOCKED(TIMED), LOCKED, EXPIRED & LOCKED(TIMED), EXPIRED(GRACE) & LOCKED(TIMED), EXPIRED & LOCKED, EXPIRED(GRACE) & LOCKED)
LOCK_DATE	TIMESTAMP(2) WITH OUT TIME ZONE	Timestamp the account was locked if account status was LOCKED
EXPIRY_DATE	TIMESTAMP(2) WITH OUT TIME ZONE	Timestamp of expiration of the account
DEFAULT_TABLESPACE	VARCHAR(128)	Default tablespace for data
TEMPORARY_TABLESPACE	VARCHAR(128)	Name of the default tablespace for temporary tables or the name of a tablespace group
INDEX_TABLESPACE	VARCHAR(128)	Default tablespace for index
CREATED	TIMESTAMP(2) WITH OUT TIME ZONE	User creation timestamp
INITIAL_RSRC_CONSUMER_GROUP	VARCHAR(128)	<ul style="list-style-type: none"> reserved Initial resource consumer group for the user
EXTERNAL_NAME	VARCHAR(128)	<ul style="list-style-type: none"> reserved User external name

USER_VIEWS

USER_VIEWS describes the views owned by the current user.

Table 9-145 Column information

Column name	Data type	Description
VIEW_SCHEMA	VARCHAR(128)	Schema of the view
VIEW_NAME	VARCHAR(128)	Name of the view
TEXT_LENGTH	NUMBER	Length of the view text
TEXT	LONG VARCHAR	View text
TYPE_TEXT_LENGTH	NUMBER	<ul style="list-style-type: none"> reserved Length of the type clause of the typed view
TYPE_TEXT	VARCHAR(4000)	<ul style="list-style-type: none"> reserved Type clause of the typed view
OID_TEXT_LENGTH	NUMBER	<ul style="list-style-type: none"> reserved Length of the WITH OID clause of the typed view
OID_TEXT	VARCHAR(4000)	<ul style="list-style-type: none"> reserved WITH OID clause of the typed view
VIEW_TYPE_OWNER	VARCHAR(128)	<ul style="list-style-type: none"> reserved Owner of the type of the view if the view is a typed view
VIEW_TYPE	VARCHAR(32)	<ul style="list-style-type: none"> reserved Type of the view if the view is a typed view
SUPERVIEW_NAME	VARCHAR(128)	<ul style="list-style-type: none"> reserved Name of the superview
EDITIONING_VIEW	VARCHAR(1)	Reserved for future use
READ_ONLY	VARCHAR(1)	Indicates whether the view is read-only (Y) or not (N)

Other Views

There are other views or tables which are none of All-family, DBA-family or USER-family.

AUDIT_POLICIES

AUDIT_POLICIES contains one row for each audit policy.

Table 9-146 Column information

Column name	Data type	Description
POLICY_NAME	VARCHAR(128)	audit policy name
ENABLED	VARCHAR(3)	indicates whether the audit policy is enabled (YES) or not (NO)
CREATED_TIME	TIMESTAMP(2) WITH OUT TIME ZONE	created time of the audit policy
MODIFIED_TIME	TIMESTAMP(2) WITH OUT TIME ZONE	last modified time of the audit policy
COMMENTS	VARCHAR(1024)	comments of the audit policy

AUDIT_POLICY_OPTIONS

AUDIT_POLICY_OPTIONS describes all audit policies created in the database.

Table 9-147 Column information

Column name	Data type	Description
POLICY_NAME	VARCHAR(128)	audit policy name
AUDIT_OPTION	VARCHAR(32)	auditing option defined in the audit policy
AUDIT_OPTION_TYPE	VARCHAR(32)	The values of AUDIT_OPTION_TYPE_NAME in ('DATABASE PRIVILEGE', 'SYSTEM ACTION', 'OBJECT ACTION')
OBJECT_SCHEMA	VARCHAR(128)	schema name, for an object-specific auditing option
OBJECT_NAME	VARCHAR(128)	object name, for an object-specific auditing option
OBJECT_TYPE	VARCHAR(32)	object type name, for an object-specific auditing option

AUDIT_POLICY_ENABLED

AUDIT_POLICY_ENABLE describes all the audit policies that are enable in the database.

Table 9-148 Column information

Column name	Data type	Description
POLICY_NAME	VARCHAR(128)	audit policy name
ENABLED_OPT	VARCHAR(32)	enable option of the audit policy, the possible values are BY, EXCEPT
USER_NAME	VARCHAR(128)	user name for whom the audit policy is enable
WHEN_SUCCESS	VARCHAR(3)	indicates whether the audit policy is enable for auditing successful events or not
WHEN_FAILURE	VARCHAR(3)	indicates whether the audit policy is enable for auditing unsuccessful events or not

AUDIT_TRAIL

AUDIT_TRAIL displays audit records from the audit trail.

Table 9-149 Column information

Column name	Data type	Description
MEMBER_NAME	VARCHAR(128)	cluster member name
SESSION_ID	NUMBER	session identifier
SESSION_SERIAL	NUMBER	session serial number
LOGON_USERNAME	VARCHAR(128)	logon user name of the user whose actions were audited
CURRENT_USERNAME	VARCHAR(128)	effective user for the statement execution
SERVER_PROCESS	NUMBER	server process identifier for the session
CLIENT_PROGRAM_NAME	VARCHAR(128)	client program used for session
CLIENT_USERNAME	VARCHAR(128)	client operating system user name for the session
CLIENT_PROCESS	NUMBER	client process identifier for the session
CLIENT_HOST	VARCHAR(128)	client host ip address for the session
CLIENT_PORT	NUMBER	client port number for the session
CLIENT_TERMINAL	VARCHAR(128)	client terminal name for the session
TRANSACTION_ID	NUMBER	transaction identifier
SCN	VARCHAR(128)	system change number (SCN) string of the query at the time of the event
GCN	NUMBER	global change number (GCN) of the query at the time of the event
DCN	NUMBER	domain change number (DCN) of the query at the time of the event
LCN	NUMBER	local change number (LCN) of the query at the time of the event
STMT_NO	NUMBER	numeric number for each statement run in a session
SQL_TEXT	LONG VARCHAR	SQL associated with the event
SQL_BINDS	LONG VARCHAR	list of bind variables, if any, associated with SQL_TEXT
RETURN_CODE	NUMBER	error code generated by the action, zero if the action succeeded
ERROR_MESSAGE	VARCHAR(1024)	error message generated by the action, null if the action succeeded
ENTRY_ID	NUMBER	audit trail entry identifier in the session
EVENT_TIMESTAMP	TIMESTAMP(2) WITHOUT TIME ZONE	timestamp of the creation of the audit trail entry in local time zone
POLICY_NAME	VARCHAR(128)	audit policy name that caused the current audit record
PRIVILEGE_USED	VARCHAR(32)	database privilege used to execute the action
ACTION_NAME	VARCHAR(32)	action name executed by the user

Column name	Data type	Description
OBJECT_TYPE	VARCHAR(32)	object type of object affected by the action
OBJECT_SCHEMA	VARCHAR(128)	schema name of object affected by the action
OBJECT_NAME	VARCHAR(128)	object name of object affected by the action

DATABASE_PROPERTIES

DATABASE_PROPERTIES lists permanent database properties.

Table 9-150 Column information

Column name	Data type	Description
PROPERTY_NAME	VARCHAR(128)	Property name
PROPERTY_VALUE	VARCHAR(4000)	Property value
DESCRIPTION	VARCHAR(4000)	Property description

DBC_TABLE_TYPE_INFO

Identify the ODBC/JDBC table types available in this database.

Table 9-151 Column information

Column name	Data type	Description
DBC_TABLE_TYPE_ID	NUMBER	number identifier of the table type in ODBC/JDBC
DBC_TABLE_TYPE	VARCHAR(128)	name of the table type in ODBC/JDBC
IS_SUPPORTED	BOOLEAN	is supported feature
COMMENTS	VARCHAR(1024)	comments of the table type

DICTIONARY

DICTIONARY contains descriptions of data dictionary tables and views.

Table 9-152 Column information

Column name	Data type	Description
TABLE_SCHEMA	VARCHAR(128)	Schema of the object
TABLE_NAME	VARCHAR(128)	Name of the object
COMMENTS	VARCHAR(1024)	Text comment on the object

DICT_COLUMNS

DICT_COLUMNS contains descriptions of columns in data dictionary tables and views.

Table 9-153 Column information

Column name	Data type	Description
TABLE_SCHEMA	VARCHAR(128)	Schema of the object that contains the column
TABLE_NAME	VARCHAR(128)	Name of the object that contains the column
COLUMN_NAME	VARCHAR(128)	Name of the column
COMMENTS	VARCHAR(1024)	Text comment on the column

IMPLEMENTATION_INFO

IMPLEMENTATION_INFO contains information about various aspects that are left implementation-defined.

Table 9-154 Column information

Column name	Data type	Description
IMPLEMENTATION_INFO_ID	NUMBER	identifier of the implementation item
IMPLEMENTATION_INFO_NAME	VARCHAR(1024)	descriptive name of the implementation item
INTEGER_VALUE	NUMBER	Value of the implementation item, or null if the value is contained in the column CHARACTER_VALUE
CHARACTER_VALUE	VARCHAR(1024)	Value of the implementation item, or null if the value is contained in the column INTEGER_VALUE
COMMENTS	VARCHAR(1024)	possibly a comment pertaining to the implementation item

IMPLEMENTATION_INFO_BASE

The IMPLEMENTATION_INFO_BASE table has one row for each implementation information item.

Table 9-155 Column information

Column name	Data type	Description
ID	VARCHAR(32)	identifier string of the implementation item
SUB_ID	VARCHAR(32)	identifier string of the implementation item
NAME	VARCHAR(1024)	descriptive name of the implementation item
SUB_NAME	VARCHAR(1024)	descriptive name of the implementation item
IS_SUPPORTED	BOOLEAN	TRUE if the implementation item is supported, FALSE if not
INTEGER_VALUE	NUMBER	Value of the implementation item, or null if the value is contained in the column CHARACTER_VALUE
CHARACTER_VALUE	VARCHAR(1024)	Value of the implementation item, or null if the value is contained in the column INTEGER_VALUE
COMMENTS	VARCHAR(1024)	possibly a comment pertaining to the implementation item

JDBC_CLIENT_PROPS

JDBC_CLIENT_PROPS is the set of jdbc client properties.

Table 9-156 Column information

Column name	Data type	Description
NAME	VARCHAR(128)	property name
MAX_LEN	NATIVE_INTEGER	max length of a value
DEFAULT_VALUE	VARCHAR(128)	default value
DESCRIPTION	VARCHAR(256)	description on that property

PRODUCT

PRODUCT is about the product name, version for ODBC, JDBC interface.

Table 9-157 Column information

Column name	Data type	Description
NAME	VARCHAR(32)	the product name
VERSION	VARCHAR(128)	product full version information
PRODUCT_VERSION	NUMBER	product version
MAJOR_VERSION	NUMBER	major version
MINOR_VERSION	NUMBER	minor version
PATCH_VERSION	NUMBER	patch version

SESSION_PRIVS

SESSION_PRIVS describes the privileges that are currently available to the user.

Table 9-158 Column information

Column name	Data type	Description
PRIVILEGE	VARCHAR(256)	Name of the privilege

SUPPLEMENTAL_LOG_TABLE_INFO

SUPPLEMENTAL_LOG_TABLE_INFO describes table-level supplemental logging status.

Table 9-159 Column information

Column name	Data type	Description
TABLE_SCHEMA	VARCHAR(128)	Schema of the object
TABLE_NAME	VARCHAR(128)	Name of the object
SUPPLEMENTAL_LOG_DATA_PK	VARCHAR(32)	Status of table-level PRIMARY KEY COLUMNS supplemental logging: IMPLICIT, EXPLICIT, NO

Aliased Synonym

It is the public synonym which indicates the view or table in DICTIONARY_SCHEMA.

COLS

COLS is a public synonym for USER_TAB_COLUMNS.

DICT

DICT is a public synonym for DICTIONARY.

IND

IND is a public synonym for USER_INDEXES.

OBJ

OBJ is a public synonym for USER_OBJECTS.

SEQ

SEQ is a public synonym for USER_SEQUENCES.

TABS

TABS is a public synonym for USER_TABLES.

9.2 INFORMATION_SCHEMA

Views of INFORMATION_SCHEMA schema provides the same information as those defined in the SQL standard.

Execute *InformationSchema.sql* as follows to use the views.

- For standalone

```
% gsql sys gliese --as sysdba --import  
$GOLDILOCKS_HOME/admin/standalone/InformationSchema.sql
```

- For cluster

```
% gsql sys gliese --as sysdba --import $GOLDILOCKS_HOME/admin/cluster/InformationSchema.sql
```



Views and tables of INFORMATION_SCHEMA can be retrieved from OPEN phase.

COLUMNS

Identify the columns of tables defined in this catalog that are accessible to given user or role.

Table 9-160 Column information

Column name	Data type	Description
TABLE_CATALOG	VARCHAR(128)	catalog name of the column
TABLE_OWNER	VARCHAR(128)	owner name of the column
TABLE_SCHEMA	VARCHAR(128)	schema name of the column
TABLE_NAME	VARCHAR(128)	table name of the column
COLUMN_NAME	VARCHAR(128)	column name
ORDINAL_POSITION	NUMBER	the ordinal position (> 0) of the column in the table
COLUMN_DEFAULT	LONG VARCHAR	the default for the column
IS_NULLABLE	BOOLEAN	is nullable of the column
DATA_TYPE	VARCHAR(128)	the standard name of the data type
CHARACTER_MAXIMUM_LENGTH	NUMBER	the maximum length in characters
CHARACTER_OCTET_LENGTH	NUMBER	the maximum length in octets
NUMERIC_PRECISION	NUMBER	the numeric precision of the numerical Data type
NUMERIC_PRECISION_RADIX	NUMBER	the radix (2 or 10) of the precision of the numerical data type
NUMERIC_SCALE	NUMBER	the numeric scale of the exact numerical data type
DATETIME_PRECISION	NUMBER	for a datetime or interval type, the value is the fractional seconds precision
INTERVAL_TYPE	VARCHAR(32)	for a interval type, the value is in (YEAR, MONTH, DAY, HOUR, MINUTE, SECOND, YEAR TO MONTH, DAY TO HOUR, DAY TO MINUTE, DAY TO SECOND, HOUR TO MINUTE, HOUR TO SECOND, MINUTE TO SECOND)
INTERVAL_PRECISION	NUMBER	for a interval type, the value is the leading precision
CHARACTER_SET_CATALOG	VARCHAR(128)	catalog name of the character set if is is a character string type
CHARACTER_SET_SCHEMA	VARCHAR(128)	schema name of the character set if is is a character string type
CHARACTER_SET_NAME	VARCHAR(128)	character set name of the character set if is is a character string type
COLLATION_CATALOG	VARCHAR(128)	catalog name of the applicable collation if is is a character string type
COLLATION_SCHEMA	VARCHAR(128)	schema name of the applicable collation if is is a character string type
COLLATION_NAME	VARCHAR(128)	collation name of the applicable collation if is is a character

Column name	Data type	Description
		string type
DOMAIN_CATALOG	VARCHAR(128)	catalog name of the domain used by the column being described
DOMAIN_SCHEMA	VARCHAR(128)	schema name of the domain used by the column being described
DOMAIN_NAME	VARCHAR(128)	domain name of the domain used by the column being described
UDT_CATALOG	VARCHAR(128)	catalog name of the user-defined type of the data type being described
UDT_SCHEMA	VARCHAR(128)	schema name of the user-defined type of the data type being described
UDT_NAME	VARCHAR(128)	user-defined type name of the user-defined type of the data type being described
SCOPE_CATALOG	VARCHAR(128)	catalog name of the referenceable table if DATA_TYPE is REF
SCOPE_SCHEMA	VARCHAR(128)	schema name of the referenceable table if DATA_TYPE is REF
SCOPE_NAME	VARCHAR(128)	scope name of the referenceable table if DATA_TYPE is REF
MAXIMUM_CARDINALITY	NUMBER	maximum cardinality if DATA_TYPE is ARRAY
DTD_IDENTIFIER	NUMBER	data type descriptor identifier
IS_SELF_REFERENCING	BOOLEAN	is a self-referencing column
IS_IDENTITY	BOOLEAN	is an identity column
IDENTITY_GENERATION	VARCHAR(32)	for an identity column, the value is in (ALWAYS, BY DEFAULT)
IDENTITY_START	NUMBER	for an identity column, the start value of the identity column
IDENTITY_INCREMENT	NUMBER	for an identity column, the increment of the identity column
IDENTITY_MAXIMUM	NUMBER	for an identity column, the maximum value of the identity column
IDENTITY_MINIMUM	NUMBER	for an identity column, the minimum value of the identity column
IDENTITY_CYCLE	BOOLEAN	for an identity column, the cycle option
IS_GENERATED	BOOLEAN	is a generated column
GENERATION_EXPRESSION	VARCHAR(128)	for a generated column, the text of the generation expression
IS_SYSTEM_VERSION_START	BOOLEAN	is a system-version start column
IS_SYSTEM_VERSION_END	BOOLEAN	is a system-version end column
SYSTEM_VERSION_TIMESTAMP_GENERATION	VARCHAR(32)	for a system-version column, the value is ALWAYS
IS_UPDATABLE	BOOLEAN	is an updatable column
DECLARED_DATA_TYPE	VARCHAR(128)	the data type name that a user declared

Column name	Data type	Description
DECLARED_NUMERIC_PRECISION	NUMBER	the precision value that a user declared
DECLARED_NUMERIC_SCALE	NUMBER	the scale value that a user declared
COMMENTS	VARCHAR(1024)	comments of the column

COLUMN_PRIVILEGES

Identify the privileges on columns of tables defined in this catalog that are available to or granted by a given user or role.

Table 9-161 Column information

Column name	Data type	Description
GRANTOR	VARCHAR(128)	authorization name of the user who granted column privileges
GRANTEE	VARCHAR(128)	authorization name of some user or role, or PUBLIC to indicate all users, to whom the column privilege being described is granted
TABLE_CATALOG	VARCHAR(128)	catalog name of the column on which the privilege being described was granted
TABLE_OWNER	VARCHAR(128)	table owner name of the column on which the privilege being described was granted
TABLE_SCHEMA	VARCHAR(128)	schema name of the column on which the privilege being described was granted
TABLE_NAME	VARCHAR(128)	table name of the column on which the privilege being described was granted
COLUMN_NAME	VARCHAR(128)	column name of the column on which the privilege being described was granted
PRIVILEGE_TYPE	VARCHAR(32)	the value is in (SELECT, INSERT, UPDATE, REFERENCES)
IS_GRANTABLE	BOOLEAN	is grantable

CONSTRAINT_COLUMN_USAGE

Identify the columns used by referential constraints, unique constraints, check constraints, and assertions defined in this catalog and owned by a given user or role.

Table 9-162 Column information

Column name	Data type	Description
TABLE_CATALOG	VARCHAR(128)	catalog name of the column that participates in the constraint being described
TABLE_OWNER	VARCHAR(128)	owner name of the column that participates in the constraint being described
TABLE_SCHEMA	VARCHAR(128)	schema name of the column that participates in the constraint being described
TABLE_NAME	VARCHAR(128)	table name of the column that participates in the constraint being described
COLUMN_NAME	VARCHAR(128)	column name that participates in the constraint being described
CONSTRAINT_CATALOG	VARCHAR(128)	catalog name of the constraint
CONSTRAINT_OWNER	VARCHAR(128)	owner name of the constraint
CONSTRAINT_SCHEMA	VARCHAR(128)	schema name of the constraint
CONSTRAINT_NAME	VARCHAR(128)	constraint name

CONSTRAINT_TABLE_USAGE

Identify the tables that are used by referential constraints, unique constraints, check constraints, and assertions defined in this catalog and owned by a given user or role.

Table 9-163 Column information

Column name	Data type	Description
TABLE_CATALOG	VARCHAR(128)	catalog name of the table that participates in the constraint being described
TABLE_OWNER	VARCHAR(128)	owner name of the table that participates in the constraint being described
TABLE_SCHEMA	VARCHAR(128)	schema name of the table that participates in the constraint being described
TABLE_NAME	VARCHAR(128)	table name that participates in the constraint being described
CONSTRAINT_CATALOG	VARCHAR(128)	catalog name of the constraint
CONSTRAINT_OWNER	VARCHAR(128)	owner name of the constraint
CONSTRAINT_SCHEMA	VARCHAR(128)	schema name of the constraint
CONSTRAINT_NAME	VARCHAR(128)	constraint name

INFORMATION_SCHEMA_CATALOG_NAME

Identify the catalog that contains the Information Schema

Table 9-164 Column information

Column name	Data type	Description
CATALOG_NAME	VARCHAR(128)	the name of catalog in which this Information Schema resides

KEY_COLUMN_USAGE

Identify the columns defined in this catalog that are constrained as keys and that are accessible by a given user or role.

Table 9-165 Column information

Column name	Data type	Description
CONSTRAINT_CATALOG	VARCHAR(128)	catalog name of the constraint
CONSTRAINT_OWNER	VARCHAR(128)	owner name of the constraint
CONSTRAINT_SCHEMA	VARCHAR(128)	schema name of the constraint
CONSTRAINT_NAME	VARCHAR(128)	constraint name
TABLE_CATALOG	VARCHAR(128)	catalog name of the column that participates in the constraint being described
TABLE_OWNER	VARCHAR(128)	owner name of the column that participates in the constraint being described
TABLE_SCHEMA	VARCHAR(128)	schema name of the column that participates in the constraint being described
TABLE_NAME	VARCHAR(128)	table name of the column that participates in the constraint being described
COLUMN_NAME	VARCHAR(128)	column name that participates in the constraint being described
ORDINAL_POSITION	NUMBER	the ordinal position of the specific column in the constraint being described. If the constraint described is a key of cardinality 1 (one), then the value of ORDINAL_POSITION is always 1 (one).
POSITION_IN_UNIQUE_CONSTRAINT	NUMBER	If the constraint being described is a foreign key constraint, then the value of POSITION_IN_UNIQUE_CONSTRAINT is the ordinal position of the referenced column corresponding to the referencing column being described, in the corresponding unique key constraint.

PARAMETERS

Identify the SQL parameters of SQL-invoked routines defined in this catalog that are accessible to a given user or role.

Table 9-166 Column information

Column name	Data type	Description
SPECIFIC_CATALOG	VARCHAR(128)	catalog name of the specific name of the SQL- invoked routine that contains the SQL parameter being described
SPECIFIC_OWNER	VARCHAR(128)	owner name of the specific name of the SQL- invoked routine that contains the SQL parameter being described
SPECIFIC_SCHEMA	VARCHAR(128)	schema name of the specific name of the SQL- invoked routine that contains the SQL parameter being described
SPECIFIC_NAME	VARCHAR(128)	specific name of the SQL- invoked routine that contains the SQL parameter being described
ORDINAL_POSITION	NUMBER	ordinal position of the SQL- invoked routine that contains the SQL parameter being described
PARAMETER_MODE	VARCHAR(32)	parameter mode of the SQL parameter being described
IS_RESULT	BOOLEAN	the parameter is RESULT parameter of type-preserving function
AS_LOCATOR	BOOLEAN	the parameter is passed as locator
PARAMETER_NAME	VARCHAR(128)	name of the SQL parameter being described
FROM_SQL_SPECIFIC_CATALOG	VARCHAR(128)	specific catalog name of the from-sql routine for the input parameter being described
FROM_SQL_SPECIFIC_SCHEMA	VARCHAR(128)	specific schema name of the from-sql routine for the input parameter being described
FROM_SQL_SPECIFIC_NAME	VARCHAR(128)	specific name of the from-sql routine for the input parameter being described
TO_SQL_SPECIFIC_CATALOG	VARCHAR(128)	specific catalog name of the to-sql routine for the input parameter being described
TO_SQL_SPECIFIC_SCHEMA	VARCHAR(128)	specific schema name of the to-sql routine for the input parameter being described
TO_SQL_SPECIFIC_NAME	VARCHAR(128)	specific name of the to-sql routine for the input parameter being described
DATA_TYPE	VARCHAR(128)	data type of the SQL parameter being described
CHARACTER_MAXIMUM_LENGTH	NUMBER	maximum length of the SQL parameter being described
		maximum length in octets of the SQL parameter being described

Column name	Data type	Description
CHARACTER_OCTET_LENGTH	NUMBER	g described
CHARACTER_SET_CATALOG	VARCHAR(128)	character set catalog name of the data type of the SQL parameter being described
CHARACTER_SET_SCHEMA	VARCHAR(128)	character set schema name of the data type of the SQL parameter being described
CHARACTER_SET_NAME	VARCHAR(128)	character set name of the data type of the SQL parameter being described
COLLATION_CATALOG	VARCHAR(128)	collation catalog name of the data type of the SQL parameter being described
COLLATION_SCHEMA	VARCHAR(128)	collation schema name of the data type of the SQL parameter being described
COLLATION_NAME	VARCHAR(128)	collation name of the data type of the SQL parameter being described
NUMERIC_PRECISION	NUMBER	precision of the data type of the SQL parameter being described
NUMERIC_PRECISION_RADIX	NUMBER	precision radix of the data type of the SQL parameter being described
NUMERIC_SCALE	NUMBER	scale of the data type of the SQL parameter being described
DATETIME_PRECISION	NUMBER	fractional second precisions of the data type of the SQL parameter being described
INTERVAL_TYPE	VARCHAR(32)	interval qualifier of the data type of the SQL parameter being described
INTERVAL_PRECISION	NUMBER	interval precision of the data type of the SQL parameter being described
UDT_CATALOG	VARCHAR(128)	catalog name of UDT of the data type of the SQL parameter being described
UDT_SCHEMA	VARCHAR(128)	schema name of UDT of the data type of the SQL parameter being described
UDT_NAME	VARCHAR(128)	name of UDT of the data type of the SQL parameter being described
SCOPE_CATALOG	VARCHAR(128)	catalog name of referenceable tables of the data type of the SQL parameter being described
SCOPE_SCHEMA	VARCHAR(128)	schema name of referenceable tables of the data type of the SQL parameter being described
SCOPE_NAME	VARCHAR(128)	name of referenceable tables of the data type of the SQL parameter being described
MAXIMUM_CARDINALITY	NUMBER	maximum cardinality of the data type of the SQL parameter being described
DTD_IDENTIFIER	NUMBER	dtd identifier of the data type of the SQL parameter being described
		declared data type of the SQL parameter being described

Column name	Data type	Description
DECLARED_DATA_TYPE	VARCHAR(128)	bed
DECLARED_NUMERIC_PRECISION	NUMBER	precision of declared data type of the SQL parameter being described
DECLARED_NUMERIC_SCALE	NUMBER	scale of declared data type of the SQL parameter being described
PARAMETER_DEFAULT	LONG VARCHAR	default value of the SQL parameter being described

REFERENTIAL_CONSTRAINTS

Identify the referential constraints defined on tables in this catalog that are accessible to a given user or role.

Table 9-167 Column information

Column name	Data type	Description
CONSTRAINT_CATALOG	VARCHAR(128)	catalog name of the referential constraint
CONSTRAINT_OWNER	VARCHAR(128)	owner name who owns the referential constraint
CONSTRAINT_SCHEMA	VARCHAR(128)	schema name of the referential constraint being described
CONSTRAINT_NAME	VARCHAR(128)	referential constraint name
CONSTRAINT_TABLE_NAME	VARCHAR(128)	name of the table to which the referential constraint being described applies
CONSTRAINT_COLUMN_NAME	VARCHAR(128)	column name of the table to which the referential constraint being described applies
ORDINAL_POSITION	NUMBER	the ordinal position of the specific column in the referential constraint being described.
UNIQUE_CONSTRAINT_CATALOG	VARCHAR(128)	catalog name of the unique or primary key constraint applied to the referenced column list being described
UNIQUE_CONSTRAINT_OWNER	VARCHAR(128)	owner name of the unique or primary key constraint applied to the referenced column list being described
UNIQUE_CONSTRAINT_SCHEMA	VARCHAR(128)	schema name of the unique or primary key constraint applied to the referenced column list being described
UNIQUE_CONSTRAINT_NAME	VARCHAR(128)	constraint name of the unique or primary key constraint applied to the referenced column list being described
UNIQUE_CONSTRAINT_TABLE_NAME	VARCHAR(128)	table name of the unique or primary key constraint applied to the referenced column list being described
UNIQUE_CONSTRAINT_COLUMN_NAME	VARCHAR(128)	column name of the unique or primary key constraint applied to the referenced column list being described
IS_PRIMARY_KEY	BOOLEAN	whether the constraint applied to the referenced column list being described, is primary key or not
MATCH_OPTION	VARCHAR(32)	the referential constraint that has a match option: the value in (SIMPLE, PARTIAL, FULL)
UPDATE_RULE	VARCHAR(32)	the referential constraint that has an update rule: the value in (NO ACTION, RESTRICT, CASCADE, SET NULL, SET DEFAULT)
		the referential constraint that has a delete rule: the value in (NO ACTION, R

Column name	Data type	Description
DELETE_RULE	VARCHAR(32)	ESTRICT, CASCADE, SET NULL, SET DEFAULT)
IS_DEFERRABLE	BOOLEAN	is a deferrable constraint
INITIALLY_DEFERRED	BOOLEAN	is an initially deferred constraint

ROUTINES

Identify the SQL-invoked routines in this catalog that are accessible to a given user or role.

Table 9-168 Column information

Column name	Data type	Description
SPECIFIC_CATALOG	VARCHAR(128)	specific catalog name of the routine
SPECIFIC_OWNER	VARCHAR(128)	specific owner name of the routine
SPECIFIC_SCHEMA	VARCHAR(128)	specific schema name of the routine
SPECIFIC_NAME	VARCHAR(128)	specific name of the routine
ROUTINE_CATALOG	VARCHAR(128)	catalog name of the routine
ROUTINE_OWNER	VARCHAR(128)	owner name of the routine
ROUTINE_SCHEMA	VARCHAR(128)	schema name of the routine
ROUTINE_NAME	VARCHAR(128)	null
ROUTINE_TYPE	VARCHAR(128)	name of the routine
MODULE_CATALOG	VARCHAR(128)	module name of the routine
MODULE_SCHEMA	VARCHAR(128)	schema name of the module in which the routine is defined
MODULE_NAME	VARCHAR(128)	name of the module in which the routine is defined
UDT_CATALOG	VARCHAR(128)	catalog name of the user-defined data type which defined the routine as a method function
UDT_SCHEMA	VARCHAR(128)	schema name of the user-defined data type which defined the routine as a method function
UDT_NAME	VARCHAR(128)	name of the user-defined data type which defined the routine as a method function
DATA_TYPE	VARCHAR(128)	data type the routine returns
CHARACTER_MAXIMUM_LENGTH	NUMBER	maximum character length of data type the routine returns
CHARACTER_OCTET_LENGTH	NUMBER	maximum character length in octets of data type the routine returns
CHARACTER_SET_CATALOG	VARCHAR(128)	character set catalog name of data type the routine returns
CHARACTER_SET_SCHEMA	VARCHAR(128)	character set schema name of data type the routine returns
CHARACTER_SET_NAME	VARCHAR(128)	character set name of data type the routine returns
COLLATION_CATALOG	VARCHAR(128)	collation catalog name of data type the routine returns
COLLATION_SCHEMA	VARCHAR(128)	collation schema name of data type the routine returns
COLLATION_NAME	VARCHAR(128)	collation name of data type the routine returns
NUMERIC_PRECISION	NUMBER	precision of data type the routine returns
NUMERIC_PRECISION_RADIX	NUMBER	precision radix of data type the routine returns
NUMERIC_SCALE	NUMBER	scale of data type the routine returns

Column name	Data type	Description
DATETIME_PRECISION	NUMBER	fractional seconds precision of data type the routine returns
INTERVAL_TYPE	VARCHAR(32)	interval qualifier for data type the routine returns
INTERVAL_PRECISION	NUMBER	interval leading field precision of data type the routine returns
TYPE_UDT_CATALOG	VARCHAR(128)	catalog name of the user-defined data type, which is the data type the routine returns
TYPE_UDT_SCHEMA	VARCHAR(128)	schema name of the user-defined data type, which is the data type the routine returns
TYPE_UDT_NAME	VARCHAR(128)	name of the user-defined data type, which is the data type the routine returns
SCOPE_CATALOG	VARCHAR(128)	catalog name of referenceable table
SCOPE_SCHEMA	VARCHAR(128)	schema name of referenceable table
SCOPE_NAME	VARCHAR(128)	name of referenceable table
MAXIMUM_CARDINALITY	NUMBER	maximum cardinality of data type the routine returns
DTD_IDENTIFIER	NUMBER	dtd identifier of data type the routine returns
ROUTINE_BODY	VARCHAR(32)	type of the routine body
ROUTINE_DEFINITION	LONG VARCHAR	catalog name of the routine
EXTERNAL_NAME	VARCHAR(128)	external name of the external routine
EXTERNAL_LANGUAGE	VARCHAR(32)	language of the external routine
PARAMETER_STYLE	VARCHAR(32)	SQL parameter passing style of the external routine
IS_DETERMINISTIC	BOOLEAN	the routine is deterministic or not
SQL_DATA_ACCESS	VARCHAR(32)	routine possibly contains SQL or access data
IS_NULL_CALL	BOOLEAN	routine returns NULL if any of parameter values are NULL
SQL_PATH	VARCHAR(1024)	described SQL PATH when the routine is defined
SCHEMA_LEVEL_ROUTINE	BOOLEAN	the routine is schema-level routine
MAX_DYNAMIC_RESULT_SETS	NUMBER	max result set count of the routine
IS_USER_DEFINED_CAST	BOOLEAN	the routine is a function that is a user-defined cast function
IS_IMPLICITLY_INVOCABLE	BOOLEAN	the user-defined cast function is implicitly invocable
SECURITY_TYPE	VARCHAR(32)	security type of the routine(DEFINER/INVOKER)
TO_SQL_SPECIFIC_CATALOG	VARCHAR(128)	catalog name of the to-sql routine of the result type of routine
TO_SQL_SPECIFIC_SCHEMA	VARCHAR(128)	schema name of the to-sql routine of the result type of routine
TO_SQL_SPECIFIC_NAME	VARCHAR(128)	name of the to-sql routine of the result type of routine
AS_LOCATOR	BOOLEAN	return value of the routine is passed as locator
CREATED	TIMESTAMP(2) WITHOUT TIME ZONE	creation time of the routine
LAST_ALTERED	TIMESTAMP(2) WITHOUT TIME ZONE	most lately altered time of the routine
NEW_SAVEPOINT_LEVEL	BOOLEAN	specify new savepoint level or not

Column name	Data type	Description
IS_UDT_DEPENDENT	BOOLEAN	routine is dependent
RESULT_CAST_FROM_DATA_TYPE	VARCHAR(128)	data type which is specified in result cast clause of the routine definition
RESULT_CAST_AS_LOCATOR	BOOLEAN	locator indication which is specified in result cast clause of the routine definition
RESULT_CAST_CHAR_MAX_LENGTH	NUMBER	maximum character length of data type which is specified in result cast clause of the routine definition
RESULT_CAST_CHAR_OCTET_LENGTH	NUMBER	maximum character length in octets of data type which is specified in result cast clause of the routine definition
RESULT_CAST_CHAR_SET_CATALOG	VARCHAR(128)	character set catalog name of data type which is specified in result cast clause of the routine definition
RESULT_CAST_CHAR_SET_SCHEMA	VARCHAR(128)	character set schema name of data type which is specified in result cast clause of the routine definition
RESULT_CAST_CHARACTER_SET_NAME	VARCHAR(128)	character set name of data type which is specified in result cast clause of the routine definition
RESULT_CAST_COLLATION_CATALOG	VARCHAR(128)	collation catalog name of data type which is specified in result cast clause of the routine definition
RESULT_CAST_COLLATION_SCHEMA	VARCHAR(128)	collation schema name of data type which is specified in result cast clause of the routine definition
RESULT_CAST_COLLATION_NAME	VARCHAR(128)	collation name of data type which is specified in result cast clause of the routine definition
RESULT_CAST_NUMERIC_PRECISION	NUMBER	precision of data type which is specified in result cast clause of the routine definition
RESULT_CAST_NUMERIC_RADIX	NUMBER	precision radix of data type which is specified in result cast clause of the routine definition
RESULT_CAST_NUMERIC_SCALE	NUMBER	scale of data type which is specified in result cast clause of the routine definition
RESULT_CAST_DATETIME_PRECISION	NUMBER	fractional seconds precision of data type which is specified in result cast clause of the routine definition
RESULT_CAST_INTERVAL_TYPE	VARCHAR(32)	interval qualifier of data type which is specified in result cast clause of the routine definition
RESULT_CAST_INTERVAL_PRECISION	NUMBER	interval precision of data type which is specified in result cast clause of the routine definition
RESULT_CAST_TYPE_UDT_CATALOG	VARCHAR(128)	UDT catalog name of data type which is specified in result cast clause of the routine definition
RESULT_CAST_TYPE_UDT_SCHEMA	VARCHAR(128)	UDT schema name of data type which is specified in result cast clause of the routine definition
RESULT_CAST_TYPE_UDT_NAME	VARCHAR(128)	UDT name of data type which is specified in result cast clause of the routine definition
RESULT_CAST_SCOPE_CATALOG	VARCHAR(128)	catalog name of referenceable table described in result cast clause of the routine definition
RESULT_CAST_SCOPE_SCHEMA		schema name of referenceable table described in result cast cl

Column name	Data type	Description
EMA	VARCHAR(128)	ause of the routine definition
RESULT_CAST_SCOPE_NAME	VARCHAR(128)	name of referenceable table described in result cast clause of the routine definition
RESULT_CAST_MAX_CARDINALITY	NUMBER	maximum cardinality of data type which is specified in result cast clause of the routine definition
RESULT_CAST_DTD_IDENTIFIER	NUMBER	dtd identifier of data type which is specified in result cast clause of the routine definition
DECLARED_DATA_TYPE	VARCHAR(128)	declared data type of the routine returns
DECLARED_NUMERIC_PRECISION	NUMBER	declared data type precision of the routine returns
DECLARED_NUMERIC_SCALE	NUMBER	declared data type scale of the routine returns
RESULT_CAST_FROM_DECLARED_DATA_TYPE	VARCHAR(128)	declared data type which is specified in result cast clause of the routine definition
RESULT_CAST_DECLARED_NUMERIC_PRECISION	NUMBER	declared data type precision which is specified in result cast clause of the routine definition
RESULT_CAST_DECLARED_NUMERIC_SCALE	NUMBER	declared data type scale which is specified in result cast clause of the routine definition

ROUTINE_PRIVILEGES

Identify the privileges on SQL-invoked routines defined in this catalog that are available to or granted by a given user or role.

Table 9-169 Column information

Column name	Data type	Description
GRANTOR	VARCHAR(128)	authorization name of the user who granted routine privileges
GRANTEE	VARCHAR(128)	authorization name of some user or role, or PUBLIC to indicate all users, to whom the routine privilege being described is granted
SPECIFIC_CATALOG	VARCHAR(128)	specific catalog name of the SQL-invoked routine on which the privilege being described was granted
SPECIFIC_OWNER	VARCHAR(128)	specific owner name of the the SQL-invoked routine on which the privilege being described was granted
SPECIFIC_SCHEMA	VARCHAR(128)	specific schema name of the the SQL-invoked routine on which the privilege being described was granted
SPECIFIC_NAME	VARCHAR(128)	specific name of the the SQL-invoked routine on which the privilege being described was granted
ROUTINE_CATALOG	VARCHAR(128)	routine catalog name of the SQL-invoked routine on which the privilege being described was granted
ROUTINE_OWNER	VARCHAR(128)	null
ROUTINE_SCHEMA	VARCHAR(128)	routine schema name of the the SQL-invoked routine on which the privilege being described was granted
ROUTINE_NAME	VARCHAR(128)	routine name of the the SQL-invoked routine on which the privilege being described was granted
PRIVILEGE_TYPE	VARCHAR(32)	the value is in (EXECUTE)
IS_GRANTABLE	BOOLEAN	is grantable

ROUTINE_ROUTINE_USAGE

Identify each SQL-invoked routine owned by a given user or role on which an SQL routine defined in this catalog is dependent.

Table 9-170 Column information

Column name	Data type	Description
SPECIFIC_CATALOG	VARCHAR(128)	specific catalog name of the routine
SPECIFIC_OWNER	VARCHAR(128)	specific owner name of the routine
SPECIFIC_SCHEMA	VARCHAR(128)	specific schema name of the routine
SPECIFIC_NAME	VARCHAR(128)	specific name of the routine
ROUTINE_CATALOG	VARCHAR(128)	routine catalog name of a routine contained in routine body of the SQL-invoked routine
ROUTINE_OWNER	VARCHAR(128)	routine owner name of a routine contained in routine body of the SQL-invoked routine
ROUTINE_SCHEMA	VARCHAR(128)	routine schema name of a routine contained in routine body of the SQL-invoked routine
ROUTINE_NAME	VARCHAR(128)	routine name of a routine contained in routine body of the SQL-invoked routine

ROUTINE_SEQUENCE_USAGE

Identify each external sequence generator owned by a given user or role on which some SQL routine defined in this catalog is dependent.

Table 9-171 Column information

Column name	Data type	Description
SPECIFIC_CATALOG	VARCHAR(128)	specific catalog name of the routine
SPECIFIC_OWNER	VARCHAR(128)	specific owner name of the routine
SPECIFIC_SCHEMA	VARCHAR(128)	specific schema name of the routine
SPECIFIC_NAME	VARCHAR(128)	specific name of the routine
SEQUENCE_CATALOG	VARCHAR(128)	catalog name of the sequence of contained in routine body of the SQL-invoked routine
SEQUENCE_OWNER	VARCHAR(128)	owner name of the sequence of contained in routine body of the SQL-invoked routine
SEQUENCE_SCHEMA	VARCHAR(128)	schema name of the sequence of contained in routine body of the SQL-invoked routine
SEQUENCE_NAME	VARCHAR(128)	sequence name of contained in routine body of the SQL-invoked routine

ROUTINE_TABLE_USAGE

Identify the tables owned by a given user or role on which SQL routines defined in this catalog are dependent.

Table 9-172 Column information

Column name	Data type	Description
SPECIFIC_CATALOG	VARCHAR(128)	specific catalog name of the routine
SPECIFIC_OWNER	VARCHAR(128)	specific owner name of the routine
SPECIFIC_SCHEMA	VARCHAR(128)	specific schema name of the routine
SPECIFIC_NAME	VARCHAR(128)	specific name of the routine
TABLE_CATALOG	VARCHAR(128)	catalog name of the table of contained in routine body of the SQL-invoked routine
TABLE_OWNER	VARCHAR(128)	owner name of the table of contained in routine body of the SQL-invoked routine
TABLE_SCHEMA	VARCHAR(128)	schema name of the table of contained in routine body of the SQL-invoked routine
TABLE_NAME	VARCHAR(128)	table name of contained in routine body of the SQL-invoked routine

SCHEMATA

Identify the schemata in a catalog that are owned by given user or accessible to given user or role.

Table 9-173 Column information

Column name	Data type	Description
CATALOG_NAME	VARCHAR(128)	catalog name of the schema
SCHEMA_NAME	VARCHAR(128)	schema name
SCHEMA_OWNER	VARCHAR(128)	authorization name who owns the schema
DEFAULT_CHARACTER_SET_CATALOG	VARCHAR(128)	catalog name of the default character set for columns and domains in the schemata
DEFAULT_CHARACTER_SET_SCHEMA	VARCHAR(128)	schema name of the default character set for columns and domains in the schemata
DEFAULT_CHARACTER_SET_NAME	VARCHAR(128)	character set name of the default character set for columns and domains in the schemata
SQL_PATH	VARCHAR(1024)	character representation of schema path specification
CREATED_TIME	TIMESTAMP(2) WITHOUT TIME ZONE	created time of the schema
MODIFIED_TIME	TIMESTAMP(2) WITHOUT TIME ZONE	last modified time of the schema
COMMENTS	VARCHAR(1024)	comments of the schema

SEQUENCES

Identify the external sequence generators defined in this catalog that are accesible to a given user or role.

Table 9-174 Column information

Column name	Data type	Description
SEQUENCE_CATALOG	VARCHAR(128)	catalog name of the sequence
SEQUENCE_OWNER	VARCHAR(128)	owner name of the sequence
SEQUENCE_SCHEMA	VARCHAR(128)	schema name of the sequence
SEQUENCE_NAME	VARCHAR(128)	sequence name
DATA_TYPE	VARCHAR(128)	the standard name of the data type
NUMERIC_PRECISION	NUMBER	the numeric precision of the numerical data type
NUMERIC_PRECISION_RADIX	NUMBER	the radix (2 or 10) of the precision of the numerical data type
NUMERIC_SCALE	NUMBER	the numeric scale of the exact numerical data type
START_VALUE	NUMBER	the start value of the sequence generator
MINIMUM_VALUE	NUMBER	the minimum value of the sequence generator
MAXIMUM_VALUE	NUMBER	the maximum value of the sequence generator
INCREMENT	NUMBER	the increment of the sequence generator
CYCLE_OPTION	BOOLEAN	cycle option
CACHE_SIZE	NATIVE_INTEGER	number of sequence numbers to cache
DECLARED_DATA_TYPE	VARCHAR(128)	the data type name that a user declared
DECLARED_NUMERIC_PRECISION	NUMBER	the precision value that a user declared
DECLARED_NUMERIC_SCALE	NUMBER	the scale value that a user declared
CREATED_TIME	TIMESTAMP(2) WITHOUT TIME ZONE	created time of the sequence generator
MODIFIED_TIME	TIMESTAMP(2) WITHOUT TIME ZONE	last modified time of the sequence generator
COMMENTS	VARCHAR(1024)	comments of the sequence generator

SQL_FEATURES

List the features and subfeatures of this ISO/IEC 9075 standard, and indicate which of these the SQL-implementation supports.

Table 9-175 Column information

Column name	Data type	Description
FEATURE_ID	VARCHAR(32)	identifier string of the conformance element
FEATURE_NAME	VARCHAR(1024)	descriptive name of the conformance element
SUB_FEATURE_ID	VARCHAR(32)	identifier string of the subfeature, or a single space if not a subfeature
SUB_FEATURE_NAME	VARCHAR(1024)	descriptive name of the subfeature, or a single space if not a subfeature
IS_SUPPORTED	BOOLEAN	TRUE if an SQL-implementation fully supports that conformance element described when SQL-data in the identified catalog is accessed through that implementation, FALSE if not
IS_VERIFIED_BY	VARCHAR(1024)	If full support for the conformance element described has been verified by testing, then the IS_VERIFIED_BY column shall contain information identifying the conformance test used to verify the conformance claim; otherwise, IS_VERIFIED_BY shall be the null value
COMMENTS	VARCHAR(1024)	possibly a comment pertaining to the conformance element

SQL_IMPLEMENTATION_INFO

List the SQL-implementation information items defined in this ISO/IEC 9075 standard and, for each of these, indicate the value supported by the SQL-implementation.

Table 9-176 Column information

Column name	Data type	Description
IMPLEMENTATION_INFO_ID	VARCHAR(32)	identifier string of the implementation information item
IMPLEMENTATION_INFO_NAME	VARCHAR(1024)	descriptive name of the implementation information item
INTEGER_VALUE	NATIVE_INTEGER	value of the implementation information item, or null if the value is contained in the column CHARACTER_VALUE
CHARACTER_VALUE	VARCHAR(32)	value of the implementation information item, or null if the value is contained in the column INTEGER_VALUE
COMMENTS	VARCHAR(1024)	possibly a comment pertaining to the implementation information item

SQL_PACKAGES

List the packages of this ISO/IEC 9075 standard, and indicate which of these the SQL-implementation supports.

Table 9-177 Column information

Column name	Data type	Description
ID	VARCHAR(32)	identifier string of the conformance element
NAME	VARCHAR(1024)	descriptive name of the conformance element
IS_SUPPORTED	BOOLEAN	TRUE if an SQL-implementation fully supports that conformance element described when SQL-data in the identified catalog is accessed through that implementation, FALSE if not
IS_VERIFIED_BY	VARCHAR(1024)	If full support for the conformance element described has been verified by testing, then the IS_VERIFIED_BY column shall contain information identifying the conformance test used to verify the conformance claim; otherwise, IS_VERIFIED_BY shall be the null value
COMMENTS	VARCHAR(1024)	possibly a comment pertaining to the conformance element

SQL_PARTS

List the parts of this ISO/IEC 9075 standard, and indicate which of these the SQL-implementation supports.

Table 9-178 Column information

Column name	Data type	Description
ID	VARCHAR(32)	identifier string of the conformance element
NAME	VARCHAR(1024)	descriptive name of the conformance element
IS_SUPPORTED	BOOLEAN	TRUE if an SQL-implementation fully supports that conformance element described when SQL-data in the identified catalog is accessed through that implementation, FALSE if not
IS_VERIFIED_BY	VARCHAR(1024)	If full support for the conformance element described has been verified by testing, then the IS_VERIFIED_BY column shall contain information identifying the conformance test used to verify the conformance claim; otherwise, IS_VERIFIED_BY shall be the null value
COMMENTS	VARCHAR(1024)	possibly a comment pertaining to the conformance element

SQL_SIZING

List the sizing items of this ISO/IEC 9075 standard, for each of these, indicate the size supported by the SQL-implementation.

Table 9-179 Column information

Column name	Data type	Description
SIZING_ID	NATIVE_INTEGER	identifier of the sizing item
SIZING_NAME	VARCHAR(1024)	descriptive name of the sizing item
SUPPORTED_VALUE	NATIVE_INTEGER	value of the sizing item, or 0 if the size is unlimited or cannot be determined, or null if the features for which the sizing item is applicable are not supported
COMMENTS	VARCHAR(1024)	possibly a comment pertaining to the sizing item

STATISTICS

Provide a list of statistics about a single table and the indexes associated with the table that are accessible to a given user or role.

Table 9-180 Column information

Column name	Data type	Description
TABLE_CATALOG	VARCHAR(128)	catalog name of the table
TABLE_OWNER	VARCHAR(128)	owner name of the table
TABLE_SCHEMA	VARCHAR(128)	schema name of the table
TABLE_NAME	VARCHAR(128)	table name of the table
STAT_TYPE	VARCHAR(32)	statistics type: the value in (TABLE STAT, INDEX CLUSTERED, INDEX HASHED, INDEX OTHER)
NON_UNIQUE	BOOLEAN	indicates whether the index does not allow duplicate values
INDEX_CATALOG	VARCHAR(128)	catalog name of the index
INDEX_OWNER	VARCHAR(128)	owner name of the index
INDEX_SCHEMA	VARCHAR(128)	schema name of the index
INDEX_NAME	VARCHAR(128)	name of the index
COLUMN_NAME	VARCHAR(128)	column name that participates in the index
ORDINAL_POSITION	NUMBER	ordinal position of the specific column in the index described
IS_ASCENDING_ORDER	BOOLEAN	index key column being described is sorted in ASCENDING(TRUE) or DESCENDING(FALSE) order
IS_NULLS_FIRST	BOOLEAN	the null values of the key column are sorted before(TRUE) or after(FALSE) non-null values
CARDINALITY	NUMBER	if STAT_TYPE is (TABLE TYPE), then this is the number of rows in the table; otherwise, it is the number of unique values in the index
PAGES	NUMBER	if STAT_TYPE is (TABLE TYPE), then this is the number of pages used for the table; otherwise, it is the number of pages used for the current index.
FILTER_CONDITION	VARCHAR(1024)	filter condition, if any.
COMMENTS	VARCHAR(1024)	if STAT_TYPE is (TABLE TYPE), then this is the table comments; otherwise, it is the index comments.

TABLES

Identify the tables defined in this catalog that are accessible to a given user or role

Table 9-181 Column information

Column name	Data type	Description
TABLE_CATALOG	VARCHAR(128)	catalog name of the table
TABLE_OWNER	VARCHAR(128)	owner name of the table
TABLE_SCHEMA	VARCHAR(128)	schema name of the table
TABLE_NAME	VARCHAR(128)	table name of the table
TABLE_TYPE	VARCHAR(32)	the value is in (BASE TABLE, VIEW, GLOBAL TEMPORARY, LOCAL TEMPORARY, SYSTEM VERSIONED, FIXED TABLE, DUMP TABLE)
DBC_TABLE_TYPE	VARCHAR(32)	ODBC/JDBC table type: the value is in (TABLE, VIEW, GLOBAL TEMPORARY, LOCAL TEMPORARY, SYSTEM TABLE, ALIAS, SYNONYM)
TABLESPACE_NAME	VARCHAR(128)	tablespace name of the table, NULL if view
SYSTEM_VERSION_START_COLUMN_NAME	VARCHAR(128)	if the table is a system-versioned table, then the name of the system-version start column of the table
SYSTEM_VERSION_END_COLUMN_NAME	VARCHAR(128)	if the table is a system-versioned table, then the name of the system-version end column of the table
SYSTEM_VERSION_RETENTION_PERIOD	VARCHAR(32)	if the table is a system-versioned table, then the character representation of the value of the retention period of the table
SELF_REFERENCING_COLUMN_NAME	VARCHAR(128)	if the table is a typed table, then the name of the self-referencing column of the table
REFERENCE_GENERATION	VARCHAR(32)	if the table has a self-referencing column, the value is in (SYSTEM GENERATED, USER GENERATED, DERIVED)
USER_DEFINED_TYPE_CATALOG	VARCHAR(128)	if the table being described is a table of a structured type, the catalog name of the structured type
USER_DEFINED_TYPE_SCHEMA	VARCHAR(128)	if the table being described is a table of a structured type, the schema name of the structured type
USER_DEFINED_TYPE_NAME	VARCHAR(128)	if the table being described is a table of a structured type, the name of the structured type
IS_INSERTABLE_INTO	BOOLEAN	is an insertable-into table
IS_TYPED	BOOLEAN	is a typed table
COMMIT_ACTION	VARCHAR(32)	if the table is a temporary table, the value is in (DELETE, PRESERVE)
CREATED_TIME	TIMESTAMP(2) WITHOUT TIME ZONE	created time of the table
MODIFIED_TIME	TIMESTAMP(2) WITHOUT TIME ZONE	last modified time of the table
COMMENTS	VARCHAR(1024)	comments of the table

TABLE_CONSTRAINTS

Identify the table constraints defined on tables in this catalog that are accessible to a given user or role

Table 9-182 Column information

Column name	Data type	Description
CONSTRAINT_CATALOG	VARCHAR(128)	catalog name of the constraint
CONSTRAINT_OWNER	VARCHAR(128)	authorization name who owns the constraint
CONSTRAINT_SCHEMA	VARCHAR(128)	schema name of the constraint being described
CONSTRAINT_NAME	VARCHAR(128)	constraint name
TABLE_CATALOG	VARCHAR(128)	catalog name of the table to which the table constraint being described applies
TABLE_OWNER	VARCHAR(128)	authorization name who owns the table to to which the table constraint being described applies
TABLE_SCHEMA	VARCHAR(128)	schema name of the table to to which the table constraint being described applies
TABLE_NAME	VARCHAR(128)	table name of the table to to which the table constraint being described applies
CONSTRAINT_TYPE	VARCHAR(32)	the value is in (PRIMARY KEY, UNIQUE, FOREIGN KEY, NOT NULL, CHECK)
IS_DEFERRABLE	BOOLEAN	is a deferrable constraint
INITIALLY_DEFERRED	BOOLEAN	is an initially deferred constraint
ENFORCED	BOOLEAN	is an enforced constraint
CREATED_TIME	TIMESTAMP(2) WITHOUT TIME ZONE	created time of the constraint
MODIFIED_TIME	TIMESTAMP(2) WITHOUT TIME ZONE	last modified time of the constraint
COMMENTS	VARCHAR(1024)	comments of the constraint

TABLE_PRIVILEGES

Identify the privileges on tables of tables defined in this catalog that are available to or granted by a given user or role.

Table 9-183 Column information

Column name	Data type	Description
GRANTOR	VARCHAR(128)	authorization name of the user who granted table privileges
GRANTEE	VARCHAR(128)	authorization name of some user or role, or PUBLIC to indicate all users, to whom the table privilege being described is granted
TABLE_CATALOG	VARCHAR(128)	catalog name of the table on which the privilege being described was granted
TABLE_OWNER	VARCHAR(128)	table owner name of the table on which the privilege being described was granted
TABLE_SCHEMA	VARCHAR(128)	schema name of the table on which the privilege being described was granted
TABLE_NAME	VARCHAR(128)	table name on which the privilege being described was granted
PRIVILEGE_TYPE	VARCHAR(32)	the value is in (CONTROL, SELECT, INSERT, UPDATE, DELETE, REFERENCES, LOCK, INDEX, ALTER)
IS_GRANTABLE	BOOLEAN	is grantable
WITH_HIERARCHY	BOOLEAN	whether the privilege was granted WITH HIERARCHY OPTION or not

USAGE_PRIVILEGES

Identify the USAGE privileges on objects defined in this catalog that are available to or granted by a given user or role.

Table 9-184 Column information

Column name	Data type	Description
GRANTOR	VARCHAR(128)	authorization name of the user who granted usage privileges, on the object of the type identified by OBJECT_TYPE
GRANTEE	VARCHAR(128)	authorization identifier of some user or role, or PUBLIC to indicate all users, to whom the usage privilege being described is granted
OBJECT_CATALOG	VARCHAR(128)	catalog name of the object of the type identified by OBJECT_TYPE on which the privilege being described was granted
OBJECT_OWNER	VARCHAR(128)	owner name of the object of the type identified by OBJECT_TYPE on which the privilege being described was granted
OBJECT_SCHEMA	VARCHAR(128)	schema name of the object of the type identified by OBJECT_TYPE on which the privilege being described was granted
OBJECT_NAME	VARCHAR(128)	object name of the type identified by OBJECT_TYPE on which the privilege being described was granted
OBJECT_TYPE	VARCHAR(32)	the value is in (DOMAIN, CHARACTER SET, COLLATION, TRANSLATION, SEQUENCE)
PRIVILEGE_TYPE	VARCHAR(32)	the value is in (USAGE)
IS_GRANTABLE	BOOLEAN	is grantable

VIEWS

Identify the viewed tables defined in this catalog that are accessible to a given user or role.

Table 9-185 Column information

Column name	Data type	Description
TABLE_CATALOG	VARCHAR(128)	catalog name of the viewed table
TABLE_OWNER	VARCHAR(128)	owner name of the viewed table
TABLE_SCHEMA	VARCHAR(128)	schema name of the viewed table
TABLE_NAME	VARCHAR(128)	view name of the viewed table
VIEW_DEFINITION	LONG VARCHAR	the character representation of the user-specified query expression contained in the corresponding view descriptor
CHECK_OPTION	VARCHAR(32)	the value is in (CASCADED, LOCAL, NONE)
IS_UPDATABLE	BOOLEAN	is an updatable view
INSERTABLE_INTO	BOOLEAN	is an insertable view
IS_TRIGGER_UPDATABLE	BOOLEAN	whether an update INSTEAD OF trigger is defined on the view or not
IS_TRIGGER_DELETABLE	BOOLEAN	whether a delete INSTEAD OF trigger is defined on the view or not
IS_TRIGGER_INSERTABLE_INTO	BOOLEAN	whether an insert INSTEAD OF trigger is defined on the view or not
IS_COMPILED	BOOLEAN	whether the view is compiled or not
IS_AFFECTED	BOOLEAN	whether the view is affected by modification of underlying object or not
COMMENTS	VARCHAR(1024)	comments of the view

VIEW_ROUTINE_USAGE

Identify each routine owned by a given user or role on which a view defined in this catalog is dependent.

Table 9-186 Column information

Column name	Data type	Description
TABLE_CATALOG	VARCHAR(128)	catalog name of the viewed table
TABLE_OWNER	VARCHAR(128)	owner name of the viewed table
TABLE_SCHEMA	VARCHAR(128)	schema name of the viewed table
TABLE_NAME	VARCHAR(128)	view name of the viewed table
SPECIFIC_CATALOG	VARCHAR(128)	specific catalog name of a routine contained in the query expression of the view being described
SPECIFIC_OWNER	VARCHAR(128)	specific owner name of a routine contained in the query expression of the view being described
SPECIFIC_SCHEMA	VARCHAR(128)	specific schema name of a routine contained in the query expression of the view being described
SPECIFIC_NAME	VARCHAR(128)	specific name of a routine contained in the query expression of the view being described

VIEW_TABLE_USAGE

Identify the tables on which viewed tables defined in this catalog and owned by a given user or role are dependent.

Table 9-187 Column information

Column name	Data type	Description
VIEW_CATALOG	VARCHAR(128)	catalog name of the viewed table
VIEW_OWNER	VARCHAR(128)	owner name of the viewed table
VIEW_SCHEMA	VARCHAR(128)	schema name of the viewed table
VIEW_NAME	VARCHAR(128)	view name of the viewed table
TABLE_CATALOG	VARCHAR(128)	catalog name of a table that is explicitly or implicitly referenced in the original query expression of the compiled view being described
TABLE_OWNER	VARCHAR(128)	owner name of a table that is explicitly or implicitly referenced in the original query expression of the compiled view being described
TABLE_SCHEMA	VARCHAR(128)	schema name of a table that is explicitly or implicitly referenced in the original query expression of the compiled view being described
TABLE_NAME	VARCHAR(128)	table name of a table that is explicitly or implicitly referenced in the original query expression of the compiled view being described

9.3 PERFORMANCE_VIEW_SCHEMA

PERFORMANCE_VIEW_SCHEMA schema consists of views which can retrieve the current state of the system.

Execute *PerformanceViewSchema.sql* as follows to use the views.

- For standalone

```
% gsql sys gliese --as sysdba --import
$GOLDILOCKS_HOME/admin/standalone/PerformanceViewSchema.sql
```

- For cluster

```
% gsql sys gliese --as sysdba --import
$GOLDILOCKS_HOME/admin/cluster/PerformanceViewSchema.sql
```

The retrievable Information of PERFORMANCE_VIEW_SCHEMA views vary upon its phase of the startup. (nomount, mount, open)

Execute the followings to figure out the startup phase in which each views are retrieved.

```
gSQL> select table_name, startup_phase from v$tables order by 1;
```

TABLE_NAME	STARTUP_PHASE
V\$AGABLE_INFO	OPEN
V\$ARCHIVELOG	MOUNT
V\$BACKUP	MOUNT
V\$BALANCER	OPEN
V\$COLUMNS	OPEN
V\$CONTROLFILE	MOUNT
V\$DATAFILE	MOUNT
V\$DB_FILE	MOUNT
V\$DISPATCHER	OPEN
V\$ERROR_CODE	NO_MOUNT
V\$INCREMENTAL_BACKUP	MOUNT
V\$INSTANCE	NO_MOUNT
V\$KEYWORDS	NO_MOUNT
V\$LATCH	NO_MOUNT
V\$LOCK_WAIT	OPEN
V\$LOGFILE	MOUNT
V\$PROCESS_MEM_STAT	NO_MOUNT

```

V$PROCESS_SQL_STAT  NO_MOUNT
V$PROCESS_STAT      NO_MOUNT
V$PROPERTY           NO_MOUNT
TABLE_NAME          STARTUP_PHASE
-----
V$PSM_RESERVED_WORDS NO_MOUNT
V$QUEUE              OPEN
V$RESERVED_WORDS     NO_MOUNT
V$SESSION            NO_MOUNT
V$SESSION_CONNECT_INFO NO_MOUNT
V$SESSION_EVENT      OPEN
V$SESSION_MEM_STAT   NO_MOUNT
V$SESSION_SQL_STAT   NO_MOUNT
V$SESSION_STAT       NO_MOUNT
V$SESSION_WAIT       OPEN
V$SHARED_MODE        OPEN
V$SHARED_SERVER      OPEN
V$SHM_SEGMENT        NO_MOUNT
V$SPROPERTY          NO_MOUNT
V$SQLFN_METADATA     NO_MOUNT
V$SQL_CACHE          NO_MOUNT
V$SQL_COMMAND        OPEN
V$SQL_HISTORY        NO_MOUNT
V$STATEMENT          NO_MOUNT
V$SYSTEM_EVENT       OPEN
TABLE_NAME          STARTUP_PHASE
-----
V$SYSTEM_MEM_STAT    NO_MOUNT
V$SYSTEM_SQL_STAT    NO_MOUNT
V$SYSTEM_STAT        NO_MOUNT
V$TABLES             NO_MOUNT
V$TABLESPACE         MOUNT
V$TABLESPACE_STAT    OPEN
V$TRANSACTION        OPEN
V$WAIT_EVENT_CLASS_NAME OPEN
V$WAIT_EVENT_NAME    OPEN
V$XA_TRANSACTION     OPEN
50 rows selected.

```

GV\$ Global View

The cluster provides GV\$ view corresponding to almost every V\$ views.

V\$ view retrieves the information of the currently connected server, but GV\$ view retrieves the information of all servers.

GV\$ view includes all column information of V\$ view, and it additionally has ORIGIN_MEMBER_NAME column which is a server having acquired the data (cluster member).



It is available only on a cluster.

For example, V\$TRANSACTION information retrieves the transaction information of the currently connected server as follows.

```
gSQL> SELECT TRANS_ID, SESSION_ID, TRANS_VIEW_SCN, START_TIME FROM V$TRANSACTION;
TRANS_ID SESSION_ID TRANS_VIEW_SCN START_TIME
-----
40501296      48 1098.1.26      2017-04-07 17:14:01.912637
```

On the other hand, GV\$TRANSACTION information retrieves the transaction information of all servers as follows.

```
gSQL> SELECT ORIGIN_MEMBER_NAME, TRANS_ID, SESSION_ID, TRANS_VIEW_SCN, START_TIME FROM
GV$TRANSACTION;
ORIGIN_MEMBER_NAME TRANS_ID SESSION_ID TRANS_VIEW_SCN START_TIME
-----
G1N1      40501296      48 1098.1.26      2017-04-07 17:14:01.912637
G2N2      40304688      48 1098.0.888      2017-04-07 17:14:55.134015
G2N1      42205232      48 1098.0.888      2017-04-07 17:14:55.135996
G1N2      40435760      48 1098.1.889      2017-04-07 17:14:01.910138
```

In the example above, ORIGIN_MEMBER_NAME information acquired each transaction information from the cluster member corresponding to G1N1, G2N1, G1N2, G2N2 each.

The information of a specific remote server can be retrieved by using the condition for ORIGIN_MEMBER_NAME column as follows.

```
gSQL>
SELECT ORIGIN_MEMBER_NAME, TRANS_ID, SESSION_ID, TRANS_VIEW_SCN, START_TIME
FROM GV$TRANSACTION
WHERE ORIGIN_MEMBER_NAME IN ( 'G2N1', 'G3N2' );
```

ORIGIN_MEMBER_NAME	TRANS_ID	SESSION_ID	TRANS_VIEW_SCN	START_TIME
G3N2	32178224	48	1099.0.888	2017-04-07 17:33:10.934752
G2N1	42270768	48	1099.0.888	2017-04-07 17:31:14.726007

2 rows selected.

V\$AGABLE_INFO

The V\$AGABLE_INFO displays the system agable information.

Table 9-188 Column information

Column name	Data type	Description
SCN	VARCHAR(32)	system scn
AGABLE_SCN	VARCHAR(32)	system agable scn
AGABLE_SCN_GAP	VARCHAR(32)	gap between system scn and agable scn
OLDEST_SESSION_ID	NUMBER	identifier of session blocking aging

V\$ARCHIVELOG

The V\$ARCHIVELOG displays information of log archiving.

Table 9-189 Column information

Column name	Data type	Description
ARCHIVELOG_MODE	VARCHAR(32)	database log mode: the value in (NOARCHIVELOG, ARCHIVELOG)
LAST_ARCHIVED_LOG	NUMBER	sequence number of last archived log file
ARCHIVELOG_DIR	VARCHAR(1024)	archive destination path
ARCHIVELOG_FILE_PREFIX	VARCHAR(128)	file prefix name of the archived log

V\$AUDITABLE_DB_PRIVILEGES

The V\$AUDITABLE_DB_PRIVILEGES displays auditable database privileges.

Table 9-190 Column information

Column name	Data type	Description
PRIVILEGE_ID	NUMBER	database privilege identifier
PRIVILEGE_NAME	VARCHAR(128)	database privilege name

V\$AUDITABLE_SYSTEM_ACTIONS

The V\$AUDITABLE_SYSTEM_ACTIONS displays auditable system actions.

Table 9-191 Column information

Column name	Data type	Description
ACTION_ID	NUMBER	auditable system action identifier
ACTION_NAME	VARCHAR(128)	auditable system action name

V\$BACKUP

The V\$BACKUP displays information of backup.

Table 9-192 Column information

Column name	Data type	Description
TBS_NAME	VARCHAR(128)	tablespace name
BACKUP_STATUS	VARCHAR(16)	indicates whether the tablespace begin backup (ACTIVE) or not (I NACTIVE)
BACKUP_LSN	NUMBER	the last checkpoint lsn of tablespace when backup started

V\$BALANCER

The V\$BALANCER displays information of balancer.

Table 9-193 Column information

Column name	Data type	Description
PROCESS_ID	NUMBER	balancer process identifier
CUR_CONNECTIONS	NUMBER	current number of connections
CONNECTIONS	NUMBER	total number of connections
CONNECTIONS_HIGHWATER	NUMBER	highest number of connections
MAX_CONNECTIONS	NUMBER	maximum connections
STATUS	VARCHAR(16)	status

V\$CLUSTER_DISPATCHER

The V\$CLUSTER_DISPATCHER displays cluster dispatcher information.



It is available only on a cluster.

Table 9-194 Column information

Column name	Data type	Description
DISPATCHER_ID	NUMBER	dispatcher identifier
IS_SYNC	BOOLEAN	whether the dispatcher is sync or not
RX_BYTES	NUMBER	total amount of data that has received through the dispatcher
TX_BYTES	NUMBER	total amount of data that has transmitted through the dispatcher
RX_JOBS	NUMBER	the total number of jobs received
TX_JOBS	NUMBER	the total number of jobs transmitted

V\$CLUSTER_LOCATION

The V\$CLUSTER_LOCATION displays cluster location information.



It is available only on a cluster.

Table 9-195 Column information

Column name	Data type	Description
MEMBER_NAME	VARCHAR(128)	member name
HOST	VARCHAR(128)	host address of a member
PORT	NUMBER	host port of a member

V\$CLUSTER_MEMBER

The V\$CLUSTER_MEMBER displays cluster member information.



It is available only on a cluster.

Table 9-196 Column information

Column name	Data type	Description
MEMBER_ID	NUMBER	member identifier
MEMBER_POSITION	NUMBER	member position
STATUS	VARCHAR(64)	status of the member: the value in (ACTIVE, INACTIVE)
IS_GLOBAL_COORD	BOOLEAN	indicates whether a member is global coordinator (TRUE) or not (FALSE)
IS_GROUP_COORD	BOOLEAN	indicates whether a member is group coordinator (TRUE) or not (FALSE)

V\$COLUMNS

The V\$COLUMNS has one row for each column of all the performance views (views beginning with V\$).

Execute gsql as follows to retrieve the column information of performance view in nomount or mount phase.

```
gSQL> \desc V$INSTANCE
COLUMN_NAME      TYPE                                IS_NULLABLE
-----
RELEASE_VERSION  VARCHAR(64)                        FALSE
STARTUP_TIME     TIMESTAMP(2) WITHOUT TIME ZONE    FALSE
INSTANCE_STATUS  VARCHAR(16)                        FALSE
```

Table 9-197 Column information

Column name	Data type	Description
TABLE_OWNER	VARCHAR(128)	owner name who owns the performance view
TABLE_SCHEMA	VARCHAR(128)	schema name of the performance view
TABLE_NAME	VARCHAR(128)	name of the performance view
COLUMN_NAME	VARCHAR(128)	column name
ORDINAL_POSITION	NUMBER	the ordinal position (> 0) of the column in the performance view
DATA_TYPE	VARCHAR(128)	the data type name that a user declared
DATA_PRECISION	NUMBER	the precision value that a user declared
DATA_SCALE	NUMBER	the scale value that a user declared
COMMENTS	VARCHAR(1024)	comments of the column

V\$CONTROLFILE

This view displays information about GOLDILOCKS control files.

Table 9-198 Column information

Column name	Data type	Description
STATUS	VARCHAR(16)	control file status (VALID, CORRUPTED)
CONTROLFILE_NAME	VARCHAR(1152)	control file name (absolute path)
LAST_CHECKPOINT_LSN	NATIVE_BIGINT	the last checkpoint lsn
IS_PRIMARY	BOLLEAN	indicates whether the control file is primary

V\$DATAFILE

The V\$DATAFILE displays information of all datafiles.

Table 9-199 Column information

Column name	Data type	Description
TBS_NAME	VARCHAR(128)	tablespace name
DATAFILE_NAME	VARCHAR(1024)	datafile name (absolute path)
CHECKPOINT_LSN	NUMBER	LSN at last checkpoint (null if temporary tablespace)
CREATION_TIME	TIMESTAMP(2) WITH OUT TIME ZONE	timestamp of the datafile creation
FILE_SIZE	NUMBER	datafile size (in bytes)
LOADED_CHECKPOINT_LSN	NUMBER	checkpoint LSN of the datafile loaded in memory
CORRUPT_PAGE_COUNT	NUMBER	number of corrupt pages in the datafile

V\$DB_FILE

The V\$DB_FILE displays a list of all files using in database.

Table 9-200 Column information

Column name	Data type	Description
FILE_NAME	VARCHAR(1024)	file name
FILE_TYPE	VARCHAR(16)	file type

V\$DISPATCHER

The V\$DISPATCHER displays information of dispatchers.

Table 9-201 Column information

Column name	Data type	Description
PROCESS_ID	NUMBER	dispatcher process identifier
RESPONSE_JOB_COUNT	NUMBER	response job count
ACCEPT	NUMBER	indicates whether this dispatcher is accepting new connections
START_TIME	NUMBER	process start time
CUR_CONNECTIONS	NUMBER	current number of connections
CONNECTIONS	NUMBER	total number of connections
CONNECTIONS_HIGHWATER	NUMBER	highest number of connections
MAX_CONNECTIONS	NUMBER	maximum connections
RECV_STATUS	VARCHAR(16)	receive status
RECV_BYTES	NUMBER	total bytes of received
RECV_UNITS	NUMBER	total units of received
RECV_IDLE	NUMBER	total idle time of receive (1/100 second)
RECV_BUSY	NUMBER	total busy time of receive (1/100 second)
SEND_STATUS	VARCHAR(16)	send status
SEND_BYTES	NUMBER	total bytes of sent
SEND_UNITS	NUMBER	total units of sent
SEND_IDLE	NUMBER	total idle time of send (1/100 second)
SEND_BUSY	NUMBER	total busy time of send (1/100 second)

V\$ERROR_CODE

The V\$ERROR_CODE displays a list of all GOLDDILOCKS error codes.

Table 9-202 Column information

Column name	Data type	Description
ERROR_CODE	NUMBER	GOLDDILOCKS error code
SQL_STATE	VARCHAR(32)	standard SQLSTATE code
ERROR_MESSAGE	VARCHAR(1024)	error message

V\$GLOBAL_TRANSACTION

The V\$GLOBAL_TRANSACTION displays information on the currently active global transactions.

Table 9-203 Column information

Column name	Data type	Description
GLOBAL_TRANS_ID	VARCHAR(1024)	global transaction identifier
LOCAL_TRANS_ID	NUMBER	local transaction identifier
GLOBAL_TRANS_STATE	VARCHAR(32)	state of the global transaction: the value in (NOTR, ACTIVE, I DLE, PREPARED, ROLLBACK_ONLY, HEURISTIC_COMPLETED)
ASSO_STATE	VARCHAR(32)	associate state of the global transaction: the value in (NOT_A SSOCIATED, ASSOCIATED, ASSOCIATION_SUSPENDED)
START_TIME	TIMESTAMP(2) WITH OUT TIME ZONE	global transaction start time
IS_REPREPARABLE	BOOLEAN	indicates whether the global transaction is reparable

V\$INCREMENTAL_BACKUP

The V\$INCREMENTAL_BACKUP displays information about control files and datafiles in backup sets from the control file.

Table 9-204 Column information

Column name	Data type	Description
BACKUP_NAME	VARCHAR(1024)	backup file name (absolute path)
BACKUP_SCOPE	VARCHAR(128)	incremental backup scope: the value in (database, tablespace, control)
INCREMENTAL_LEVEL	NUMBER	incremental backup level: the value in (0, 1, 2, 3, 4)
INCREMENTAL_TYPE	VARCHAR(32)	incremental backup type: the value in (DIFFERENTIAL, CUMULATIVE)
LSN	NUMBER	all changes up to checkpoint LSN are included in this backup
BEGIN_TIME	TIMESTAMP(2) WITH OUT TIME ZONE	incremental backup beginning time
COMPLETION_TIME	TIMESTAMP(2) WITH OUT TIME ZONE	incremental backup completion time

V\$INSTANCE

This view displays the state of the current instance.



When database is transited to open phase, it is possible to select *READ ONLY* or *READ WRITE*. If not selected, *DATA_ACCESS_MODE* is determined by the value of *DATABASE_ACCESS_MODE* property. *DATA_ACCESS_MODE* is displayed as *NONE* in nomount or mount phase.

Table 9-205 Column information

Column name	Data type	Description
RELEASE_VERSION	VARCHAR(64)	release version
STARTUP_TIME	TIMESTAMP(2) WITH OUT TIME ZONE	time when the instance was started
INSTANCE_STATUS	VARCHAR(16)	status of the instance: the value in (STARTED, MOUNTED, OPEN)
DATA_ACCESS_MODE	VARCHAR(16)	data access mode of the instance: the value in (NONE, READ_ONLY, READ_WRITE)

V\$JOURNALING

The V\$JOURNALING displays journaling information.



It is available only on a cluster.

Table 9-206 Column information

Column name	Data type	Description
TABLE_NAME	VARCHAR(128)	table name
SHARD_ID	NUMBER	shard identifier
RECORD_COUNT	NUMBER	journalized record count
TOTAL_SIZE	NUMBER	total size of journalized records (byte)

V\$KEYWORDS

The V\$KEYWORDS displays a list of all SQL keywords.

Table 9-207 Column information

Column name	Data type	Description
KEYWORD_NAME	VARCHAR(128)	name of keyword
KEYWORD_LENGTH	NUMBER	length of the keyword
IS_RESERVED	BOOLEAN	indicates whether the keyword cannot be used as an identifier (TRUE) or whether the keyword is not reserved (FALSE)

V\$LATCH

The V\$LATCH shows latch information.

Table 9-208 Column information

Column name	Data type	Description
LATCH_DESCRIPTION	VARCHAR(64)	latch description
REF_COUNT	NUMBER	reference count
SPIN_LOCK	VARCHAR(3)	indicates whether the spin lock is locked (YES) or not (NO)
WAIT_COUNT	NUMBER	wait count
CURRENT_MODE	VARCHAR(32)	current latch mode: the value in (INITIAL, SHARED, EXCLUSIVE)

V\$LOGFILE

The V\$LOGFILE displays information of all redo log members.

Table 9-209 Column information

Column name	Data type	Description
GROUP_ID	NUMBER	redo log group identifier
FILE_NAME	VARCHAR(1024)	name of the log member
GROUP_STATE	VARCHAR(32)	state of the log group: the value in (UNUSED, ACTIVE, CURRENT, IN ACTIVE)
FILE_SEQ	NUMBER	file sequence number of the log member
FILE_SIZE	NUMBER	file size of the log member (in bytes)

V\$LOCK_WAIT

This view lists the locks currently held and outstanding requests for a lock.

Table 9-210 Column information

Column name	Data type	Description
GRANT_TRANS_ID	NUMBER	transaction identifier that holds the lock
REQUEST_TRANS_ID	NUMBER	transaction identifier that requests the lock

V\$PROCESS_STAT

The V\$PROCESS_STAT displays goldilocks process statistics.

Table 9-211 Column information

Column name	Data type	Description
STAT_NAME	VARCHAR(128)	statistic name
PROC_ID	NUMBER	goldilocks process identifier
STAT_VALUE	NUMBER	statistic value

V\$PROCESS_MEM_STAT

The V\$PROCESS_MEM_STAT displays goldilocks process memory statistics.

Table 9-212 Column information

Column name	Data type	Description
STAT_NAME	VARCHAR(128)	statistic name
PROC_ID	NUMBER	goldilocks process identifier
STAT_VALUE	NUMBER	statistic value

V\$PROCESS_SQL_STAT

The V\$PROCESS_SQL_STAT displays goldilocks process SQL statistics.

Table 9-213 Column information

Column name	Data type	Description
STAT_NAME	VARCHAR(128)	statistic name
PROC_ID	NUMBER	goldilocks process identifier
STAT_VALUE	NUMBER	statistic value

V\$PROPERTY

The V\$PROPERTY displays a list of all properties at current session. Otherwise, the instance-wide value.

Table 9-214 Column information

Column name	Data type	Description
PROPERTY_NAME	VARCHAR(128)	name of the property
DESCRIPTION	VARCHAR(2048)	description of the property
DATA_TYPE	VARCHAR(32)	data type of the property
STARTUP_PHASE	VARCHAR(32)	modifiable startup-phase: the value IN (NO MOUNT / MOUNT / OPEN & [BELOW ABOVE])
VALUE_UNIT	VARCHAR(32)	unit of the property value: the value in (NONE, BYTE, MS(milisc))
PROPERTY_VALUE	VARCHAR(2048)	property value for the session. otherwise, the instance-wide value
PROPERTY_SOURCE	VARCHAR(32)	source of the current property value: the value IN (USER, DEFAULT, ENV_VAR, BINARY_FILE, FILE, SYSTEM)
INIT_VALUE	VARCHAR(2048)	property init value for the session
INIT_SOURCE	VARCHAR(32)	source of the current property INIT_VALUE: the value IN (USER, DEFAULT, ENV_VAR, BINARY_FILE, FILE, SYSTEM)
MIN_VALUE	NUMBER	minimum value for property. null if type is varchar
MAX_VALUE	NUMBER	maximum value for property. null if type is varchar
SES_MODIFIABLE	VARCHAR(32)	property can be changed with ALTER SESSION or not: the value in (TRUE, FALSE)
SYS_MODIFIABLE	VARCHAR(32)	property can be changed with ALTER SYSTEM and when the change takes effect: the value in (NONE, FALSE, IMMEDIATE, DEFERRED)
IS_MODIFIABLE	VARCHAR(32)	property can be changed or not: the value in (TRUE, FALSE)

V\$PSM_RESERVED_WORDS

The V\$PSM_RESERVED_WORDS displays a list of all PSM reserved keywords. Reserved words cannot be used in variable name or procedure name.

Table 9-215 Column information

Column name	Data type	Description
KEYWORD_NAME	VARCHAR(128)	name of keyword
KEYWORD_LENGTH	NUMBER	length of the keyword

V\$QUEUE

The V\$QUEUE displays information of queue.

Table 9-216 Column information

Column name	Data type	Description
TYPE	NUMBER	queue type (COMMON or DISPATCHER)
INDEX	NUMBER	index
QUEUED	NUMBER	number of items in the queue
WAIT	NUMBER	total time that all items in this queue have waited (1/100 second)
TOTALQ	VARCHAR(128)	total number of items that have ever been in the queue

V\$RESERVED_WORDS

The V\$RESERVED_WORDS displays a list of all SQL reserved keywords. Reserved words cannot be used in table name or column name.

Table 9-217 Column information

Column name	Data type	Description
KEYWORD_NAME	VARCHAR(128)	name of keyword
KEYWORD_LENGTH	NUMBER	length of the keyword

V\$SESSION

The V\$SESSION displays session information for each current session.

Table 9-218 Column information

Column name	Data type	Description
SESSION_ID	NUMBER	session identifier
SERIAL_NO	NUMBER	session serial number
TRANS_ID	NUMBER	transaction identifier (-1 if inactive transaction)
CONNECTION_TYPE	VARCHAR(32)	connection type: the value in (DA, TCP)
USER_NAME	VARCHAR(128)	user name
SESSION_STATUS	VARCHAR(32)	status of the session: the value in (CONNECTED, SIGNALED, SNIPED, DEAD)
SERVER_TYPE	VARCHAR(32)	server type: the value in (DEDICATED, SHARED)
PROCESS_ID	NUMBER	client process identifier
LOGON_TIME	TIMESTAMP(2) WITH OUT TIME ZONE	logon time
PROGRAM_NAME	VARCHAR(128)	program name
CLIENT_ADDRESS	VARCHAR(1024)	client address (null if DA)
CLIENT_PORT	NUMBER	client port (0 if DA)
FAILOVER_TYPE	VARCHAR(13)	indicates whether and to what extent transparent application failover (TAF) is enabled for the session (NONE, SESSION)
FAILED_OVER	VARCHAR(3)	indicates whether the session is running in failover mode and failover has occurred (YES) or not (NO)
IS_AUDITED	VARCHAR(3)	indicates whether the session is audited (YES) or not (NO)

V\$SESSION_AUDIT

The V\$SESSION_AUDIT displays audited session information.

Table 9-219 Column information

Column name	Data type	Description
SESSION_ID	NUMBER	session identifier
SERIAL_NO	NUMBER	session serial number
POLICY_NAME	VARCHAR(128)	active audit policy name
WHEN_SUCCESS	VARCHAR(3)	indicates whether the audit policy is enable for auditing successful events or not
WHEN_FAILURE	VARCHAR(3)	indicates whether the audit policy is enable for auditing unsuccessful events or not

V\$SESSION_CONNECT_INFO

The V\$SESSION_CONNECT_INFO displays information about network connections for the current session.

Table 9-220 Column information

Column name	Data type	Description
SESSION_ID	NUMBER	session identifier
SERIAL_NO	NUMBER	session serial number
CLIENT_CHARSET	VARCHAR(40)	client character set

V\$SESSION_EVENT

The V\$SESSION_EVENT displays information on waits for an event by a session.

Table 9-221 Column information

Column name	Data type	Description
SESSION_ID	NUMBER	ID of the session
WAIT_EVENT_ID	NUMBER	Identifier of the wait event
WAIT_EVENT_NAME	VARCHAR(64)	Name of the wait event
TOTAL_WAITS	NUMBER	Total number of waits for the event
TOTAL_TIMEOUTS	NUMBER	Total number of timeouts for the event
TIME_WAITED	NUMBER	Total amount of time waited for the event (microsecond)
AVERAGE_WAIT	NUMBER	Average amount of time waited for the event (microsecond)
MAX_WAIT	NUMBER	Maximum time waited for the event by the session (microsecond)
CLASS_NAME	VARCHAR(64)	Name of the class of the wait event

V\$SESSION_STAT

The V\$SESSION_STAT displays session statistics.

Table 9-222 Column information

Column name	Data type	Description
STAT_NAME	VARCHAR(128)	statistic name
SESS_ID	NUMBER	session identifier
STAT_VALUE	NUMBER	statistic value

V\$SESSION_MEM_STAT

The V\$SESSION_MEM_STAT displays session memory statistics.

Table 9-223 Column information

Column name	Data type	Description
STAT_NAME	VARCHAR(128)	statistic name
SESS_ID	NUMBER	session identifier
STAT_VALUE	NUMBER	statistic value

V\$SESSION_SQL_STAT

The V\$SESSION_SQL_STAT displays session SQL statistics.

Table 9-224 Column information

Column name	Data type	Description
STAT_NAME	VARCHAR(128)	statistic name
SESS_ID	NUMBER	session identifier
STAT_VALUE	NUMBER	statistic value

V\$SESSION_WAIT

The V\$SESSION_WAIT displays the current or last wait for each session.

Table 9-225 Column information

Column name	Data type	Description
SESSION_ID	NUMBER	ID of the session
SEQ_NO	NUMBER	Identifier of the wait event
WAIT_EVENT_ID	NUMBER	Name of the wait event
WAIT_EVENT_NAME	VARCHAR(64)	A number that uniquely identifies the current or last wait (incremented for each wait)
P1TEXT	VARCHAR(64)	Description of the first parameter for the wait event
P1	NUMBER	First wait event parameter (in decimal)
P1HEX	VARCHAR(32)	First wait event parameter (in hex)
P2TEXT	VARCHAR(64)	Description of the second parameter for the wait event
P2	NUMBER	Second wait event parameter (in decimal)
P2HEX	VARCHAR(32)	Second wait event parameter (in hex)
P3TEXT	VARCHAR(64)	Description of the third parameter for the wait event
P3	NUMBER	Third wait event parameter (in decimal)
P3HEX	VARCHAR(32)	Third wait event parameter (in hex)
STATE	VARCHAR(64)	Wait state
WAIT_TIME	NUMBER	If the session is currently waiting, then the value is time waited for the current wait. If the session is not in a wait, then the value is the duration of the last wait (in microseconds)
TIME_SINCE_LAST_WAIT	NUMBER	Time elapsed since the end of the last wait (in microseconds). If the session is currently in a wait, then the value is 0.
CLASS_NAME	VARCHAR(64)	Name of the class of the wait event

V\$SHARED_MODE

The V\$SHARED_MODE displays information of shared mode.

Table 9-226 Column information

Column name	Data type	Description
NAME	VARCHAR(128)	name
VALUE	VARCHAR(128)	value

V\$SHARED_SERVER

The V\$SHARED_SERVER displays information of shared servers.

Table 9-227 Column information

Column name	Data type	Description
PROCESS_ID	NUMBER	shared server process identifier
PROCESSED_JOB_COUNT	NUMBER	processed job count
STATUS	VARCHAR(128)	status
IDLE	NUMBER	total idle time (1/100 second)
BUSY	NUMBER	total busy time (1/100 second)

V\$SHM_SEGMENT

The V\$SHM_SEGMENT displays a list of all shared memory segments.

Table 9-228 Column information

Column name	Data type	Description
SHM_NAME	VARCHAR(32)	shared memory segment name
SHM_ID	NUMBER	shared memory segment identifier
SHM_SIZE	NUMBER	shared memory segment size (in bytes)
SHM_KEY	NUMBER	shared memory segment key
SHM_SEQ	NUMBER	shared memory segment sequence
SHM_ADDR	VARCHAR(32)	start address of the shared memory segment

V\$SPROPERTY

The V\$SPROPERTY displays a list of Properties. This is store a binary property file.

Table 9-229 Column information

Column name	Data type	Description
PROPERTY_NAME	VARCHAR(128)	name of the property
DESCRIPTION	VARCHAR(2048)	description of the property
DATA_TYPE	VARCHAR(32)	data type of the property
STARTUP_PHASE	VARCHAR(32)	modifiable startup-phase: the value IN (NO MOUNT / MOUNT / OPEN & [BELOW ABOVE])
VALUE_UNIT	VARCHAR(32)	unit of the property value: the value in (NONE, BYTE, MS(milisc))
PROPERTY_VALUE	VARCHAR(2048)	property value stored in the binary property file
PROPERTY_SOURCE	VARCHAR(32)	source of the current property value: the value is BINARY_FILE
INIT_VALUE	VARCHAR(2048)	property init value for the system
INIT_SOURCE	VARCHAR(32)	source of the current property INIT_VALUE: the value IN (USER, DEFAULT, ENV_VAR, BINARY_FILE, FILE, SYSTEM)
MIN_VALUE	NUMBER	minimum value for property. null if type is varchar
MAX_VALUE	NUMBER	maximum value for property. null if type is varchar
SES_MODIFIABLE	VARCHAR(32)	property can be changed with ALTER SESSION or not: the value in (TRUE, FALSE)
SYS_MODIFIABLE	VARCHAR(32)	property can be changed with ALTER SYSTEM and when the change takes effect: the value in (NONE, FALSE, IMMEDIATE, DEFERRED)
IS_MODIFIABLE	VARCHAR(32)	property can be changed or not: the value in (TRUE, FALSE)

V\$SQLFN_METADATA

The V\$SQLFN_METADATA contains metadata about operators and built-in functions

Table 9-230 Column information

Column name	Data type	Description
FUNC_NAME	VARCHAR(128)	name of the built-in function
MINARGS	NUMBER	minimum number of arguments for the function
MAXARGS	NUMBER	maximum number of arguments for the function
IS_AGGREGATE	BOOLEAN	indicates whether the function is an aggregate function (TRUE) or not (FALSE)

V\$SQL_CACHE

The V\$SQL_CACHE lists statistics of shared SQL plan.

Table 9-231 Column information

Column name	Data type	Description
SQL_HANDLE	NUMBER	SQL handle
HASH_VALUE	NUMBER	hash value of the SQL statement
REF_COUNT	NUMBER	count of prepared statements referencing the statement
PLAN_SIZE	NUMBER	the total plan size of the SQL statement (in bytes)
CLOCK_ID	NUMBER	clock identifier
PLAN_AGE	NUMBER	plan age
USER_NAME	VARCHAR(128)	user name
BIND_PARAM_COUNT	NUMBER	count of bind parameters
SQL_TEXT	LONG VARCHAR	SQL full text
PLAN_COUNT	NUMBER	physical plan count of the SQL statement
PLAN_ID	NUMBER	plan identifier
PLAN_SIZE	NUMBER	the total plan size of the SQL statement (in bytes)
PLAN_IS_ATOMIC	BOOLEAN	plan is atomic array insert or not
PLAN_TEXT	LONG VARCHAR	plan text for SQL statement

V\$SQL_COMMAND

The V\$SQL_COMMAND lists attribute information of each SQL command.

Table 9-232 Column information

Column name	Data type	Description
COMMAND	VARCHAR(128)	SQL command
FROM_PHASE	VARCHAR(32)	executable from start-up phase
UNTIL_PHASE	VARCHAR(32)	executable until start-up phase
ACCESS_MODE	VARCHAR(32)	database access mode: values in (NONE, READ & WRITE, READ, READ & LOCK)
NEED_FETCH	VARCHAR(32)	the command is a query which has result set and need fetch
IS_DDL	VARCHAR(3)	the command is a DDL(Data Defintion Language) or not
AUTO_COMMIT	VARCHAR(3)	the command is auto-commit or not
IS_CACHEABLE	VARCHAR(3)	the command is plan-cacheable or not
AUDIT_ACTION	VARCHAR(128)	auditable action name for the SQL command

V\$SQL_HISTORY

The V\$SQL_HISTORY displays information of SQLs.

Table 9-233 Column information

Column name	Data type	Description
DRIVER_MEMBER_POS	NUMBER	driver member position
SESSION_ID	NUMBER	session identifier
START_TIME	TIMESTAMP(2) WITHOUT TIME ZONE	statement start time
EXEC_TIME	NUMBER	execution time(us)
PREPARED	BOOLEAN	indicates whether the statement is prepared (YES) or not (NO)
SUCCESS	BOOLEAN	indicates whether the statement is success (YES) or not (NO)
STATUS	CHARACTER VARYING(16)	status of the statement: the value in (RUNNING, DONE)
SQL_TEXT	CHARACTER VARYING(1024)	first 1024 bytes of the SQL text for the statement

V\$STATEMENT

The V\$STATEMENT lists all statements.

Table 9-234 Column information

Column name	Data type	Description
SESSION_ID	NUMBER	session identifier
STMT_ID	NUMBER	statement identifier in a session
STMT_VIEW_SCN	NUMBER	statement view scn
SQL_TEXT	VARCHAR(1024)	first 1024 bytes of the SQL text for the statement
START_TIME	TIMESTAMP(2) WITHOUT TIME ZONE	statement start time

V\$SYSTEM_EVENT

The V\$SYSTEM_EVENT displays information on total waits for an event.

Table 9-235 Column information

Column name	Data type	Description
WAIT_EVENT_ID	NUMBER	Identifier of the wait event
WAIT_EVENT_NAME	VARCHAR(64)	Name of the wait event
TOTAL_WAITS	NUMBER	Total number of waits for the event
TOTAL_TIMEOUTS	NUMBER	Total number of timeouts for the event
TIME_WAITED	NUMBER	Total amount of time waited for the event (microsecond)
AVERAGE_WAIT	NUMBER	Average amount of time waited for the event (microsecond)
CLASS_NAME	VARCHAR(64)	Name of the class of the wait event

V\$SYSTEM_STAT

The V\$SYSTEM_STAT displays system statistics.

Table 9-236 Column information

Column name	Data type	Description
STAT_NAME	VARCHAR(128)	statistic name
STAT_VALUE	NUMBER	statistic value
COMMENTS	VARCHAR(1024)	comments

V\$SYSTEM_MEM_STAT

The V\$SYSTEM_MEM_STAT displays system memory statistics.

Table 9-237 Column information

Column name	Data type	Description
STAT_NAME	VARCHAR(128)	statistic name
STAT_VALUE	NUMBER	statistic value
COMMENTS	VARCHAR(1024)	comments

V\$SYSTEM_SQL_STAT

The V\$SYSTEM_SQL_STAT displays system SQL statistics.

Table 9-238 Column information

Column name	Data type	Description
STAT_NAME	VARCHAR(128)	statistic name
STAT_VALUE	NUMBER	statistic value
COMMENTS	VARCHAR(1024)	comments

V\$TABLES

The V\$TABLES contains the definitions of all the performance views (views beginning with V\$).

Table 9-239 Column information

Column name	Data type	Description
TABLE_OWNER	VARCHAR(128)	owner name who owns the performance view
TABLE_SCHEMA	VARCHAR(128)	schema name of the performance view
TABLE_NAME	VARCHAR(128)	name of the performance view
STARTUP_PHASE	VARCHAR(32)	visible startup phase of the performance view
CREATED_TIME	TIMESTAMP(2) WITHOUT TIME ZONE	<ul style="list-style-type: none"> available only in OPEN phase created time of the performance view
MODIFIED_TIME	TIMESTAMP(2) WITHOUT TIME ZONE	<ul style="list-style-type: none"> available only in OPEN phase modified time of the performance view
COMMENTS	VARCHAR(1024)	<ul style="list-style-type: none"> available only in OPEN phase comments of the performance view

V\$TABLESPACE

This view displays tablespace information.

Table 9-240 Column information

Column name	Data type	Description
TBS_NAME	VARCHAR(128)	tablespace name
TBS_ID	NUMBER	tablespace identifier
TBS_ATTR	VARCHAR(128)	tablespace attribute: the value in (device attribute (MEMORY) temporary attribute (TEMPORARY, PERSISTENT) usage attribute(DICT, UNDO, DATA, TEMPORARY))
IS_LOGGING	BOOLEAN	indicates whether the tablespace is a logging tablespace (YES) or not (NO)
IS_ONLINE	BOOLEAN	indicates whether the tablespace is ONLINE (YES) or OFFLINE (NO)
OFFLINE_STATE	VARCHAR(32)	indicates whether the tablespace can be taken online normally (CONSISTENT) or not (INCONSISTENT). null if the tablespace is ONLINE
EXTENT_SIZE	NUMBER	extent size of the tablespace (in bytes)
PAGE_SIZE	NUMBER	page size of the tablespace (in bytes)

V\$TABLESPACE_STAT

This view displays tablespace statistical information.

Table 9-241 Column information

Column name	Data type	Description
TBS_NAME	VARCHAR(128)	tablespace name
TBS_ID	NUMBER	tablespace identifier
TOTAL_EXT_COUNT	NUMBER	total extent count of the tablespace
USED_META_EXT_COUNT	NUMBER	meta extent count currently used on the tablespace
USED_DATA_EXT_COUNT	NUMBER	data extent count currently used on the tablespace
FREE_EXT_COUNT	NUMBER	free extent count of the tablespace
EXTENT_SIZE	NUMBER	extent size of the tablespace (in bytes)

V\$TRANSACTION

The V\$TRANSACTION lists the active transactions in the system.

Table 9-242 Column information

Column name	Data type	Description
TRANS_ID	NUMBER	transaction identifier
SESSION_ID	NUMBER	session identifier (null if the global transaction is unassociated
TRANS_SLOT_ID	NUMBER	transaction slot identifier
PHYSICAL_TRANS_ID	NUMBER	physical transaction identifier
TRANS_STATE	VARCHAR(32)	transaction state: the value in (ACTIVE, BLOCK, PREPARE, COMMIT, ROLLBACK, IDLE, PRECOMMIT)
IS_GLOBAL	BOOLEAN	indicates whether the transaction is global or not
TRANS_ATTRIBUTE	VARCHAR(32)	transaction attribute: the value in (READ_ONLY, UPDATABLE, LOCK ABLE, UPDATABLE LOCKABLE)
ISOLATION_LEVEL	VARCHAR(32)	transaction isolation level: the value in (READ COMMITTED, SERIALI ZABLE)
TRANS_VIEW_SCN	NUMBER	transaction view scn
TCN	NUMBER	transaction change number
TRANS_SEQ	NUMBER	transaction sequence number
START_TIME	TIMESTAMP(2) WITH OUT TIME ZONE	transaction start time

V\$WAIT_EVENT_CLASS_NAME

The V\$WAIT_EVENT_CLASS_NAME displays information about Class of wait event.

Table 9-243 Column information

Column name	Data type	Description
CLASS_ID	NUMBER	Identifier of the class of the wait event
NAME	VARCHAR(64)	Name of the class of the wait event
DESCRIPTION	VARCHAR(128)	Description of the class of the wait event

V\$WAIT_EVENT_NAME

The V\$WAIT_EVENT_NAME displays information about wait events.

Table 9-244 Column information

Column name	Data type	Description
CLASS_ID	NUMBER	Identifier of the wait event
NAME	VARCHAR(64)	Name of the wait event
DESCRIPTION	VARCHAR(128)	Description of the wait event
PARAMETER1	NUMBER	Description of the first parameter for the wait event
PARAMETER1	NUMBER	Description of the second parameter for the wait event
PARAMETER1	NUMBER	Description of the third parameter for the wait event
CLASS_ID	NUMBER	Identifier of the class of the wait event
CLASS_NAME	VARCHAR(64)	Name of the class of the wait event

V\$XA_TRANSACTION

The V\$XA_TRANSACTION displays information on the currently active XA transactions.

Table 9-245 Column information

Column name	Data type	Description
XA_TRANS_ID	VARCHAR(1024)	XA transaction identifier
LOCAL_TRANS_ID	NUMBER	local transaction identifier
XA_TRANS_STATE	VARCHAR(32)	state of the XA transaction: the value in (NOTR, ACTIVE, IDLE, PREPARED, ROLLBACK_ONLY, HEURISTIC_COMPLETED)
ASSO_STATE	VARCHAR(32)	associate state of the XA transaction: the value in (NOT_ASSOCIATED, ASSOCIATED, ASSOCIATION_SUSPENDED)
START_TIME	TIMESTAMP(2) WITH OUT TIME ZONE	XA transaction start time
IS_REPREPARABLE	BOOLEAN	indicates whether the XA transaction is reparable

10.

Server Property

10.1 Server Property Information

For more information about SQL syntax to change properties, refer to the followings.

- **ALTER SYSTEM SET property_name**
- **ALTER SESSION SET property_name**

For more information about property types, refer to the followings.

- **V\$PROPERTY**
- **V\$SPROPERTY**

The followings describe basic information items of property in this manual.

Item	Description
Name	Property name
Summary	Short description of the property
Data type	Data type of the property value
Applicable phase	A startup phase which can be updated with ALTER SYSTEM or ALTER SESSION <ul style="list-style-type: none"> • NONE: Applicable phase does not exist. (If it can be updated, but applicable phase is NONE, then use <i>SCOPE = FILE</i> option.)
Updatable	Whether property is updatable or not <ul style="list-style-type: none"> • If the property value is TRUE, it is updatable. • If the property value is FALSE, only the read-only is possible.
ALTER SESSION	Whether property is updatable or not by using ALTER SESSION SET property_name
ALTER SYSTEM	Whether property is updatable or not by using ALTER SYSTEM SET property_name <ul style="list-style-type: none"> • IMMEDIATE: The updated value is immediately reflected in all session after execution. • DEFERRED: The updated value is reflected only in the session which is connected after execution. However, it is not reflected in already connected session. • FALSE: The updated value is not reflected in the session during execution. However, the updated value is reflected after restart, (Properties are updatable by using only <i>SCOPE=FILE</i> option.) • NONE: It is not updatable.
MIN	If the data type is BIGINT, it is the minimum value of property. If the data type is VARCHAR, the minimum value of property is N/A.
MAX	If the data type is BIGINT, it is the maximum value of property. If the data type is VARCHAR, the maximum value of property is N/A.
Default value	Default value of the property

10.2 AGING_INTERVAL

Basic Information

Item	Description
Name	AGING_INTERVAL
Summary	aging interval time(ms)
Data type	BIGINT
Applicable phase	NO MOUNT or above
Updatable	TRUE
ALTER SESSION	FALSE
ALTER SYSTEM	IMMEDIATE
MIN	1
MAX	100000000
Default value	10

Description

It sets the idle time (second) when an ager thread which deletes the previous version data does not have a job to process in MVCC based database.

10.3 AGING_PLAN_INTERVAL

Basic Information

Item	Description
Name	AGING_PLAN_INTERVAL
Summary	aging plan interval time(s)
Data type	BIGINT
Applicable phase	NO MOUNT or above
Updatable	TRUE
ALTER SESSION	FALSE
ALTER SYSTEM	IMMEDIATE
MIN	0
MAX	31536000
Default value	0

Description

The SQL plan which is older than AGING_PLAN_INTERVAL becomes the aging target.

10.4 ARCHIVELOG_DIR_1 ~ ARCHIVELOG_DIR_10

Basic Information

Item	Description
Name	ARCHIVELOG_DIR_1 ~ ARCHIVELOG_DIR_10
Summary	archive log directory
Data type	VARCHAR
Applicable phase	NO MOUNT or above
Updatable	TRUE
ALTER SESSION	FALSE(ARCHIVELOG_DIR_1), TRUE(ARCHIVELOG_DIR_2 ~ ARCHIVELOG_DIR_10)
ALTER SYSTEM	DEFERRED
MIN	N/A
MAX	N/A
Default value	\$(GOLDILOCKS_DATA)/archive_log

Description

It specifies archiving directory of GOLDILOCKS database's online redo log file. Also, it specifies where to read of archive redo log file at media recovery. The online redo log file creates archive redo log file only in ARCHIVELOG_DIR_1.

ARCHIVELOG_DIR_1 sets only the system, but ARCHIVELOG_DIR_2 ~ ARCHIVELOG_DIR_10 sets the session.

10.5 ARCHIVELOG_FILE

Basic Information

Item	Description
Name	ARCHIVELOG_FILE
Summary	default archive log file
Data type	VARCHAR
Applicable phase	MOUNT or below
Updatable	TRUE
ALTER SESSION	FALSE
ALTER SYSTEM	DEFERRED
MIN	N/A
MAX	N/A
Default value	archive

Description

It sets the prefix of the targeted file name stored in archive directory when archiving online redo logfile. The archive logfile's name consists of prefix '_' set in ARCHIVELOG_FILE, the file sequence and the file extension 'log'. For example, the online logfile whose file sequence is 0 is archived as 'archive_0.log'.

10.6 ARCHIVELOG_MODE

Basic Information

Item	Description
Name	ARCHIVELOG_MODE
Summary	archive log mode(0:disable, 1:enable)
Data type	BIGINT
Applicable phase	NONE
Updatable	FALSE
ALTER SESSION	FALSE
ALTER SYSTEM	FALSE
MIN	0
MAX	1
Default value	0

Description

The property is applied at database creation. The archive log mode can be set to one of the following values.

- 0: NOARCHIVELOG
- 1: ARCHIVELOG

It does not affect archive log mode during operation after database is created. The archive log mode can be modified by using *ALTER DATABASE {ARCHIVELOG | NOARCHIVELOG}* in MOUNT phase.

10.7 BACKUP_DIR_1 ~ BACKUP_DIR_10

Basic Information

Item	Description
Name	BACKUP_DIR_1 ~ BACKUP_DIR_10
Summary	backup directory
Data type	VARCHAR
Applicable phase	NO MOUNT or above
Updatable	TRUE
ALTER SESSION	FALSE(BACKUP_DIR_1), TRUE(BACKUP_DIR_2 ~ BACKUP_DIR_10)
ALTER SYSTEM	DEFERRED
MIN	N/A
MAX	N/A
Default value	\$(GOLDILOCKS_DATA)/backup

Description

A backup file is created when incremental backup is executed. Then it sets a directory of backup file to be read when restoring files using incremental backup. Incremental backups are created only in the directory set in BACKUP_DIR_1.

BACKUP_DIR_1 sets only the system, but BACKUP_DIR_2 ~ BACKUP_DIR_10 sets the session.

10.8 BLOCK_READ_COUNT

Basic Information

Item	Description
Name	BLOCK_READ_COUNT
Summary	value count for a block read
Data type	BIGINT
Applicable phase	NO MOUNT or above
Updatable	TRUE
ALTER SESSION	TRUE
ALTER SYSTEM	DEFERRED
MIN	1
MAX	65536
Default value	20

Description

The SQL executes operation by reading row in the unit of BLOCK_READ_COUNT which is a row bundle. BLOCK_READ_COUNT means the number of rows to be processed at a time when operation is executed. It is a basic unit of pipe-lining process of execution nodes which are used in SQL query processing.

If BLOCK_READ_COUNT value is big the processing performance improves, but many memory resources are used.

The value between 10 and 100 is recommended.

If the value becomes bigger than 100 the resource usage increases proportionately, but, the performance improvement does not increase proportionately.

10.9 BULK_IO_PAGE_COUNT

Basic Information

Item	Description
Name	BULK_IO_PAGE_COUNT
Summary	page count for bulk IO operation
Data type	BIGINT
Applicable phase	NO MOUNT or above
Updatable	TRUE
ALTER SESSION	FALSE
ALTER SYSTEM	IMMEDIATE
MIN	128
MAX	131072
Default value	3840

Description

It is used when IO READ of the data file occurs during server restart, or when IO WRITE occurs during creating a data file.

The heap memory is allocated as big as $BULK_IO_PAGE_COUNT * 8192$ when server restarts or data file is created. If the session's `PRIVATE_STATIC_AREA_SIZE` is smaller than the heap memory size, an error of insufficient memory may occur. In this case, extend `PRIVATE_STATIC_AREA_SIZE`.

10.10 CDISPATCHER_HOT_POLICY_INTERVAL

Basic Information

Item	Description
Name	CDISPATCHER_HOT_POLICY_INTERVAL
Summary	cdispatcher dequeue interval for busy waiting (micro second)
Data type	BIGINT
Applicable phase	NO MOUNT or above
Updatable	TRUE
ALTER SESSION	FALSE
ALTER SYSTEM	IMMEDIATE
MIN	0
MAX	86400000000 (1day)
Default value	100000

Description

It is the time of the busy waiting when performing the dequeue in the cdispatcher. It is a micro second unit. If this value is big, it uses more cpu but the user response time (latency) is decreased.

10.11 CDISPATCHER_SOCKET_BUFFER_SIZE

Basic Information

Item	Description
Name	CDISPATCHER_SOCKET_BUFFER_SIZE
Summary	cdispatcher socket buffer(sender, receiver) size
Data type	BIGINT
Applicable phase	NONE
Updatable	TRUE
ALTER SESSION	FALSE
ALTER SYSTEM	FALSE
MIN	64
MAX	100 Mega
Default value	32768

Description

It is the socket buffer(sender, receiver) size of cdispatcher.

10.12 CDISPATCHER_SYNC_THREADS

Basic Information

Item	Description
Name	CDISPATCHER_SYNC_THREADS
Summary	cdispatcher sync thread count
Data type	BIGINT
Applicable phase	NONE
Updatable	TRUE
ALTER SESSION	FALSE
ALTER SYSTEM	FALSE
MIN	1
MAX	32
Default value	1

Description

It is the thread count of cdispatcher sync.

10.13 CDISPATCHER_THREADS

Basic Information

Item	Description
Name	CDISPATCHER_THREADS
Summary	cdispatcher sender, receiver thread count
Data type	BIGINT
Applicable phase	NONE
Updatable	TRUE
ALTER SESSION	FALSE
ALTER SYSTEM	FALSE
MIN	1
MAX	32
Default value	1

Description

It is the thread count of cdispatcher sender and receiver.

10.14 CHARACTER_SET

Basic Information

Item	Description
Name	CHARACTER_SET
Summary	character set
Data type	VARCHAR
Applicable phase	NONE
Updatable	FALSE
ALTER SESSION	FALSE
ALTER SYSTEM	FALSE
MIN	N/A
MAX	N/A
Default value	UTF8

Description

It is a character set of database, and it is applied when database is created.

The property is set to one of the following values.

Character set	Description
SQL_ASCII	ASCII standards
UTF8	Unicode, 8-bit
UHC	Unified Hangul code
GB18030	Chinese government standards

10.15 CHAR_LENGTH_UNITS

Basic Information

Item	Description
Name	CHAR_LENGTH_UNITS
Summary	char length units
Data type	VARCHAR
Applicable phase	NONE
Updatable	FALSE
ALTER SESSION	FALSE
ALTER SYSTEM	FALSE
MIN	N/A
MAX	N/A
Default value	OCTETS

Description

It is the value of char length units used when defining character string such as CHAR, VARCHAR and omitting char length unit as follows.

```
CREATE TABLE t1
(
  id CHAR( 10 OCTETS ),
  name VARCHAR( 128 CHARACTERS ),
  addr VARCHAR( 128 )
);
```

- id CHAR(10 OCTETS) means 10 bytes.
- name VARCHAR(128 CHARACTERS) means 128 characters.
- addr VARCHAR(128) means that this value is referenced when char length unit is omitted.

When database is created, the property is set to either OCTETS or CHARACTERS. OCTETS is the number of bytes, and CHARACTERS is the number of characters.



The SQL standard defines CHARACTERS as default value. Other DBMS defines the default value of char length unit as follows.

- Oracle and DB2 define OCTETS as default value.
- MS-SQL, MySQL, PostgreSQL define CHARACTERS as default value.

10.16 CHECK_DEDICATE_CONNECTION_INTERVAL

Basic Information

Item	Description
Name	CHECK_DEDICATE_CONNECTION_INTERVAL
Summary	check dedicate socket
Data type	BIGINT
Applicable phase	NO MOUNT or above
Updatable	TRUE
ALTER SESSION	TRUE
ALTER SYSTEM	IMMEDIATE
MIN	0
MAX	100000
Default value	1000

Description

It is the interval of checking for when the client forcibly cut the connection in C/S dedicate environment. The dedicate server(gserver) checks the socket, and it terminates it if it was cut. The default value is 1,000 millisecond (1 second).

10.17 CLIENT_MAX_COUNT

Basic Information

Item	Description
Name	CLIENT_MAX_COUNT
Summary	maximum session count
Data type	BIGINT
Applicable phase	NONE
Updatable	TRUE
ALTER SESSION	FALSE
ALTER SYSTEM	FALSE
MIN	12
MAX	65535
Default value	128

Description

It sets the maximum number of sessions to connect.

10.18 CLIENT_NUMA_POLICY

Basic Information

Item	Description
Name	CLIENT_NUMA_POLICY
Summary	client numa policy(0: by modular, 1: by statistics , 2: by manual)
Data type	BIGINT
Applicable phase	NO MOUNT or above
Updatable	TRUE
ALTER SESSION	TRUE
ALTER SYSTEM	DEFERRED
MIN	0
MAX	2
Default value	0

Description

It determines the policy to distribute client processes to NUMA nodes. This property is operated when NUMA property is set to on.

- 0: It determines the NUMA node to be connected by modularizing the session ID.
- 1: It connects to the NUMA node of which is the least connected based on the statistics information.
- 2: C/S client is determined by TCP_CLIENT_NUMA_NODE property, D/A client is determined by DA_CLIENT_NUMA_NODE property.

10.19 CLOSE_PSM_CHILD_STMTS

Basic Information

Item	Description
Name	CLOSE_PSM_CHILD_STMTS
Summary	close child statements of PSM at the end of each execution
Data type	BOOLEAN
Applicable phase	NO MOUNT or above
Updatable	TRUE
ALTER SESSION	TRUE
ALTER SYSTEM	DEFERRED
MIN	0
MAX	1
Default value	NO

Description

It closes the child statement of PSM at the end of each execution.

10.20 CLUSTER_ASYNC_COMMIT

Basic Information

Item	Description
Name	CLUSTER_ASYNC_COMMIT
Summary	enable asynchronous commit in cluster system
Data type	BOOLEAN
Applicable phase	NO MOUNT or above
Updatable	TRUE
ALTER SESSION	TRUE
ALTER SYSTEM	IMMEDIATE
MIN	0
MAX	1
Default value	YES

Description

It determines whether to internally process the commit protocol on an async mode in cluster system.



If this property is set to on, it asynchronously commits each node, so the temporary inconsistency among nodes may occur. On the other hand, if it is set to off, it synchronizes everytime it commits, so it may reduce the performance. Therefore, it is required to determine the appropriate property depending on the purpose.

10.21 CLUSTER_ASYNC_REPLICATION

Basic Information

Item	Description
Name	CLUSTER_ASYNC_REPLICATION
Summary	enable asynchronous replication
Data type	BOOLEAN
Applicable phase	NO MOUNT or above
Updatable	TRUE
ALTER SESSION	TRUE
ALTER SYSTEM	IMMEDIATE
MIN	0
MAX	1
Default value	YES

Description

It determines whether to internally process the replication on an async mode in cluster system.



If this property is set to on, it asynchronously reflects the data on each node, so the response time varies upon on which node is connected during the operation. On the other hand, if it is set to off, it synchronizes everytime the data is updated, so it may reduce the performance. Therefore, it is required to determine the appropriate property depending on the purpose.

10.22 CLUSTER_CM_BUFFER_COUNT

Basic Information

Item	Description
Name	CLUSTER_CM_BUFFER_COUNT
Summary	communication buffer count for cluster
Data type	BIGINT
Applicable phase	NONE
Updatable	TRUE
ALTER SESSION	FALSE
ALTER SYSTEM	FALSE
MIN	1
MAX	256
Default value	4

Description

It is the communication buffer count for cluster.

10.23 CLUSTER_CM_BUFFER_SIZE

Basic Information

Item	Description
Name	CLUSTER_CM_BUFFER_SIZE
Summary	communication buffer size for cluster
Data type	BIGINT
Applicable phase	NONE
Updatable	TRUE
ALTER SESSION	FALSE
ALTER SYSTEM	FALSE
MIN	10 Mega
MAX	32 Giga
Default value	10 Mega

Description

It is the communication buffer size for cluster.

10.24 CLUSTER_CM_READ_BUFFER_SIZE

Basic Information

Item	Description
Name	CLUSTER_CM_READ_BUFFER_SIZE
Summary	communication read block size
Data type	BIGINT
Applicable phase	NO MOUNT or above
Updatable	TRUE
ALTER SESSION	FALSE
ALTER SYSTEM	IMMEDIATE
MIN	8192
MAX	10485,760
Default value	65536

Description

It is the communication read block size.

10.25 CLUSTER_COMMIT_SLAVES

Basic Information

Item	Description
Name	CLUSTER_COMMIT_SLAVES
Summary	number of commit slaves
Data type	BIGINT
Applicable phase	NONE
Updatable	TRUE
ALTER SESSION	FALSE
ALTER SYSTEM	FALSE
MIN	1
MAX	8
Default value	1

Description

It is the number of commit slaves.

10.26 CLUSTER_COMMIT_STREAM_ISOLATION

Basic Information

Item	Description
Name	CLUSTER_COMMIT_STREAM_ISOLATION
Summary	isolate cluster dispatcher stream for commit protocol
Data type	BOOLEAN
Applicable phase	NONE
Updatable	TRUE
ALTER SESSION	FALSE
ALTER SYSTEM	FALSE
MIN	0
MAX	1
Default value	0

Description

It determines whether to internally perform the commit process flow in the cluster system separately from other protocol process. The performance may be improved when separating the commit process according to the system environment.

10.27 CLUSTER_CONNECTION

Basic Information

Item	Description
Name	CLUSTER_CONNECTION
Summary	connection mode for cluster (socket:0, rdma:1)
Data type	BIGINT
Applicable phase	NONE
Updatable	TRUE
ALTER SESSION	FALSE
ALTER SYSTEM	FALSE
MIN	0
MAX	1
Default value	0: socket

Description

It is the connection mode for cluster. (socket:0, rdma:1)

10.28 CLUSTER_CONNECTION_TIMEOUT_SEC

Basic Information

Item	Description
Name	CLUSTER_CONNECTION_TIMEOUT_SEC
Summary	connection timeout for cluster
Data type	BIGINT
Applicable phase	NO MOUNT or above
Updatable	TRUE
ALTER SESSION	FALSE
ALTER SYSTEM	IMMEDIATE
MIN	0
MAX	86400
Default value	5

Description

It is the connection timeout for cluster.

10.29 CLUSTER_DATA_SYNC_SERVERS

Basic Information

Item	Description
Name	CLUSTER_DATA_SYNC_SERVERS
Summary	count of data synchronization server
Data type	BIGINT
Applicable phase	NONE
Updatable	TRUE
ALTER SESSION	FALSE
ALTER SYSTEM	FALSE
MIN	1
MAX	128
Default value	3

Description

It is the count of data synchronization server.

10.30 CLUSTER_DISPATCHER_IN_QUEUE_SIZE

Basic Information

Item	Description
Name	CLUSTER_DISPATCHER_IN_QUEUE_SIZE
Summary	in-queue size for cluster dispatcher
Data type	BIGINT
Applicable phase	NONE
Updatable	TRUE
ALTER SESSION	FALSE
ALTER SYSTEM	FALSE
MIN	1024
MAX	32768
Default value	1024

Description

It is the in-queue size for cluster dispatcher

10.31 CLUSTER_DISPATCHER_NUMA_STREAM_MAP

AP

Basic Information

Item	Description
Name	CLUSTER_DISPATCHER_NUMA_STREAM_MAP
Summary	numa stream map for cluster dispatcher
Data type	VARCHAR
Applicable phase	NONE
Updatable	TRUE
ALTER SESSION	FALSE
ALTER SYSTEM	FALSE
MIN	N/A
MAX	N/A
Default value	'x' : no binding

Description

It determines a NUMA node to which the cluster dispatcher is to be connected. This property is operated when NUMA property is set to on.



If CLUSTER_COMMIT_STREAM_ISOLATION property is set to on, then the 0 stream is set to NUMA node of a commit stream.

The following is an example of three dispatchers. It connects number 0 stream to number 0 NUMA node, connects number 1 stream to number 1 NUMA node, and number 2 stream to number 2 NUMA node.

```
CLUSTER_DISPATCHER_NUMA_STREAM_MAP = '0:1:2'
```

10.32 CLUSTER_DISPATCHER_OUT_QUEUE_SIZE

Basic Information

Item	Description
Name	CLUSTER_DISPATCHER_OUT_QUEUE_SIZE
Summary	out-queue size for cluster dispatcher
Data type	BIGINT
Applicable phase	NONE
Updatable	TRUE
ALTER SESSION	FALSE
ALTER SYSTEM	FALSE
MIN	1024
MAX	32768
Default value	1024

Description

It is the out-queue size for cluster dispatcher.

10.33 CLUSTER_HEARTBEAT_INTERVAL

Basic Information

Item	Description
Name	CLUSTER_HEARTBEAT_INTERVAL
Summary	interval seconds for health checking of cluster
Data type	BIGINT
Applicable phase	NO MOUNT or above
Updatable	TRUE
ALTER SESSION	FALSE
ALTER SYSTEM	IMMEDIATE
MIN	0
MAX	86400
Default value	3

Description

It is the interval seconds for health checking of cluster. 0 means that it is disabled.

10.34 CLUSTER_HEARTBEAT_RETRY_COUNT

Basic Information

Item	Description
Name	CLUSTER_HEARTBEAT_RETRY_COUNT
Summary	retry count for health checking of cluster
Data type	BIGINT
Applicable phase	NO MOUNT or above
Updatable	TRUE
ALTER SESSION	FALSE
ALTER SYSTEM	IMMEDIATE
MIN	1
MAX	65536
Default value	5

Description

It is the retry count for health checking of cluster.

10.35 CLUSTER_IGNORE_INACTIVE_MEMBER

Basic Information

Item	Description
Name	CLUSTER_IGNORE_INACTIVE_MEMBER
Summary	ignore in-active member for cluster
Data type	BOOLEAN
Applicable phase	NO MOUNT or above
Updatable	TRUE
ALTER SESSION	TRUE
ALTER SYSTEM	FALSE
MIN	0
MAX	1
Default value	NO

Description

It ignores in-active member for cluster.

10.36 CLUSTER_MAX_PACKET_SIZE

Basic Information

Item	Description
Name	CLUSTER_MAX_PACKET_SIZE
Summary	maximum packet size for cluster session
Data type	BIGINT
Applicable phase	NO MOUNT or above
Updatable	TRUE
ALTER SESSION	FALSE
ALTER SYSTEM	IMMEDIATE
MIN	10 Mega
MAX	32 Giga
Default value	100 Mega

Description

It sets the maximum packet size of which the remote protocol can transfer at a time. If the column size to be remotely transferred exceeds the property size, then the property size should be set bigger than the column size.

10.37 CLUSTER_MAX_PAYLOAD_SIZE

Basic Information

Item	Description
Name	CLUSTER_MAX_PAYLOAD_SIZE
Summary	maximum packet payload size for cluster session (byte)
Data type	BIGINT
Applicable phase	NO MOUNT or above
Updatable	TRUE
ALTER SESSION	TRUE
ALTER SYSTEM	IMMEDIATE
MIN	524288
MAX	33554432
Default value	524288

Description

The cluster packet which is remotely transferred may be delivered in pieces, and this property sets the maximum size of data to be stored in a piece.

10.38 CLUSTER_PACKET_ALLOCATION_TIMEOUT

Basic Information

Item	Description
Name	CLUSTER_PACKET_ALLOCATION_TIMEOUT
Summary	a time limit (sec) for how long statemets will wait to allocate packet memory
Data type	BIGINT
Applicable phase	NO MOUNT or above
Updatable	TRUE
ALTER SESSION	FALSE
ALTER SYSTEM	IMMEDIATE
MIN	1
MAX	100000000
Default value	3

Description

It sets the maximum time (second) of waiting when allocating memory required for cluster packet configuration.

10.39 CLUSTER_PROTOCOL_SESSION_FATAL_POLICY_TIMEOUT

Basic Information

Item	Description
Name	CLUSTER_PROTOCOL_SESSION_FATAL_POLICY_TIMEOUT
Summary	a time limit of session fatal policy to wait for a response from the cluster protocol
Data type	BIGINT
Applicable phase	NO_MOUNT or above
Updatable	TRUE
ALTER SESSION	FALSE
ALTER SYSTEM	IMMEDIATE
MIN	0
MAX	100000000
Default value	0

Description

It is the maximum time of when waiting for the response after transferring the protocol in cluster. If it does not respond within the specified time, then GOLDILOCKS, depending on the protocol, may terminate the protocol or make the remote cluster member which does not respond to be failover. Specify the time limit by using `CLUSTER_PROTOCOL_SESSION_FATAL_POLICY_TIMEOUT` property to use the policy terminating the session. However, specify the time limit by using `CLUSTER_PROTOCOL_FAILOVER_POLICY_TIMEOUT` property to use the failover policy.

10.40 CLUSTER_PROTOCOL_FAILOVER_POLICY_TIMEOUT

Basic Information

Item	Description
Name	CLUSTER_PROTOCOL_FAILOVER_POLICY_TIMEOUT
Summary	a time limit of failover policy to wait for a response from the cluster protocol
Data type	BIGINT
Applicable phase	NO_MOUNT or above
Updatable	TRUE
ALTER SESSION	FALSE
ALTER SYSTEM	IMMEDIATE
MIN	0
MAX	100000000
Default value	0

Description

It is the maximum time of when waiting for the response after transferring the protocol in cluster. If it does not respond within the specified time, then GOLDILOCKS, depending on the protocol, may terminate the protocol or make the remote cluster member which does not respond to be failover. Specify the time limit by using `CLUSTER_PROTOCOL_FAILOVER_POLICY_TIMEOUT` property to use the failover policy. However, specify the time limit by using `CLUSTER_PROTOCOL_SESSION_FATAL_POLICY_TIMEOUT` property to use the policy terminating the session.

10.41 CLUSTER_SERVER_RESPONSE_QUEUE_SIZE

Basic Information

Item	Description
Name	CLUSTER_SERVER_RESPONSE_QUEUE_SIZE
Summary	response queue size for cluster server
Data type	BIGINT
Applicable phase	NONE
Updatable	TRUE
ALTER SESSION	FALSE
ALTER SYSTEM	FALSE
MIN	30
MAX	32768
Default value	30

Description

It sets the maximum queue size to get response from the remote server.

10.42 CLUSTER_SPLIT_BRAIN_RESOLUTION_POLICY

Basic Information

Item	Description
Name	CLUSTER_SPLIT_BRAIN_RESOLUTION_POLICY
Summary	split brain resolution policy for cluster system
Data type	BIGINT
Applicable phase	NO MOUNT or above
Updatable	TRUE
ALTER SESSION	FALSE
ALTER SYSTEM	IMMEDIATE
MIN	0
MAX	2
Default value	0

Description

It sets the policy to resolve split-brain situation in the cluster system. If the value is set to 1 or over, it enquires the solution of a locator.



If the query for a locator is timed out, it tries to enquire as many times as CLUSTER_SPLIT_BRAIN_RETRY_COUNT. If the property value after the retry failure is 1, then it forcibly proceeds the fail over. If it is 2, then it terminates the fatal.

10.43 CLUSTER_SPLIT_BRAIN_RETRY_COUNT

Basic Information

Item	Description
Name	CLUSTER_SPLIT_BRAIN_RETRY_COUNT
Summary	retry count for split brain resolution policy(1 ~ 65536)
Data type	BIGINT
Applicable phase	NO MOUNT or above
Updatable	TRUE
ALTER SESSION	FALSE
ALTER SYSTEM	IMMEDIATE
MIN	1
MAX	65536
Default value	4

Description

It is used when CLUSTER_SPLIT_BRAIN_RESOLUTION_POLICY is set to 1 or over in cluster system. It sets the times of retrying to enquire when the query to a locator does not respond.

10.44 COMMITTER_HOT_POLICY_INTERVAL

Basic Information

Item	Description
Name	COMMITTER_HOT_POLICY_INTERVAL
Summary	committer deque interval for busy waiting
Data type	BIGINT
Applicable phase	NO MOUNT or above
Updatable	TRUE
ALTER SESSION	FALSE
ALTER SYSTEM	IMMEDIATE
MIN	0
MAX	86400000000 (1 day)
Default value	0 (cold policy)

Description

It sets the timezone interval of busy waiting when the commit cserver is dequeing to read the commit protocol message. If it is set to 1,000,000 (1 second), and the time is not passed over 1 second from the last deque success to another deque retry, then it sets the timeout in deque to 0 and performs the busy waiting.

10.45 CONTROL_FILE_0 ~ CONTROL_FILE_7

Basic Information

Item	Description
Name	CONTROL_FILE_0
Summary	control file name
Data type	VARCHAR
Applicable phase	NONE
Updatable	TRUE
ALTER SESSION	FALSE
ALTER SYSTEM	FALSE
MIN	N/A
MAX	N/A
Default value	\$(GOLDILOCKS_DATA)/wal/control_0.ctl

Description

If a control file is corrupted, database can not be used. Therefore, the control file is multiplexed for stability of database. It specifies the directory and file name of which stores each control file.

10.46 CONTROL_FILE_COUNT

Basic Information

Item	Description
Name	CONTROL_FILE_COUNT
Summary	control file count
Data type	BIGINT
Applicable phase	NONE
Updatable	TRUE
ALTER SESSION	FALSE
ALTER SYSTEM	FALSE
MIN	2
MAX	8
Default value	2

Description

If a control file is corrupted, database can not be used. The control file is multiplexed for stability of database. CONTROL_FILE_COUNT specifies the multiplexing number of control files. A control file is multiplexed at least 2 up to 8.

10.47 CONTROL_FILE_TEMP_NAME

Basic Information

Item	Description
Name	CONTROL_FILE_TEMP_NAME
Summary	temporary file name for control file
Data type	VARCHAR
Applicable phase	NO MOUNT or above
Updatable	TRUE
ALTER SESSION	FALSE
ALTER SYSTEM	DEFERRED
MIN	N/A
MAX	N/A
Default value	\$GOLDILOCKS_DATA/backup/control.tmp

Description

During database operation, a control file is frequently changed, and its temporary copy can be made if necessary. CONTROL_FILE_TEMP_NAME specifies the directory and its file name to temporarily store the control file.

10.48 COORDINATOR_COMMIT_WRITE_MODE

Basic Information

Item	Description
Name	COORDINATOR_COMMIT_WRITE_MODE
Summary	coordinator commit write mode(0:disable, 1:wait mode)
Data type	BIGINT
Applicable phase	NO MOUNT or above
Updatable	TRUE
ALTER SESSION	FALSE
ALTER SYSTEM	IMMEDIATE
MIN	0
MAX	1
Default value	0

Description

It is a commit write mode applied to a coordinator. If TRANSACTION_COMMIT_WRITE_MODE is *no wait*, and its property is *wait*, then the coordinator node is operated as *wait*, and other nodes are operated as *no wait*.

10.49 CSERVERS

Basic Information

Item	Description
Name	CSERVERS
Summary	number of cserver processes
Data type	BIGINT
Applicable phase	MOUNT or below
Updatable	TRUE
ALTER SESSION	FALSE
ALTER SYSTEM	IMMEDIATE
MIN	1
MAX	512
Default value	10

Description

It is a number of cserver process.

10.50 DATABASE_ACCESS_MODE

Basic Information

Item	Description
Name	DATABASE_ACCESS_MODE
Summary	database access mode (0: read only, 1: read write)
Data type	BIGINT
Applicable phase	NO MOUNT or below
Updatable	TRUE
ALTER SESSION	FALSE
ALTER SYSTEM	IMMEDIATE
MIN	0
MAX	1
Default value	1

Description

When database starts, it sets the access mode.

- 0: It is able to read operation, but unable to insert/ update/ delete operations on database.
- 1: It is able to read/ insert/ update/ delete operations on database.

10.51 DATABASE_INSTANCE_NAME

Basic Information

Item	Description
Name	DATABASE_INSTANCE_NAME
Summary	database instance name
Data type	VARCHAR
Applicable phase	NONE
Updatable	TRUE
ALTER SESSION	FALSE
ALTER SYSTEM	FALSE
MIN	N/A
MAX	N/A
Default value	GOLDILOCKS

Description

It is the database instance name.

10.52 DATA_STORE_MODE

Basic Information

Item	Description
Name	DATA_STORE_MODE
Summary	data store mode(cds:1,tds:2)
Data type	BIGINT
Applicable phase	NONE
Updatable	TRUE
ALTER SESSION	FALSE
ALTER SYSTEM	FALSE
MIN	1
MAX	2
Default value	2

Description

It sets the storing method of database.

- 1: CDS mode supports the concurrency for multiple users but it does not guarantee the durability. It does not record logs for all update operations such as insert/ delete/ update data, consequentially a failure can not be recovered.
- 2: TDS mode guarantees the concurrency for multiple users and the durability using logs.

10.53 DA_CLIENT_NUMA_NODE

Basic Information

Item	Description
Name	DA_CLIENT_NUMA_NODE
Summary	numa node for DA clients
Data type	BIGINT
Applicable phase	NONE
Updatable	TRUE
ALTER SESSION	FALSE
ALTER SYSTEM	FALSE
MIN	-1
MAX	63
Default value	-1

Description

It sets the NUMA node ID to which the direct access (D/A) session is to be bound. This property is operated when NUMA property is set to ON.

10.54 DDL_AUTOCOMMIT

Basic Information

Item	Description
Name	DDL_AUTOCOMMIT
Summary	DDL auto commit
Data type	BOOL
Applicable phase	NO MOUNT or above
Updatable	TRUE
ALTER SESSION	TRUE
ALTER SYSTEM	IMMEDIATE
MIN	0
MAX	1
Default value	NO

Description

It sets whether to autocommit DDL operations which is not autocommitted yet. For example, autocommit is not applied to the operations such as creating/altering a table, so if DDL_AUTOCOMMIT is 0, a table creation and alteration can be undone by the rollback. On the other hand, if DDL_AUTOCOMMIT is 1, DDL to which autocommit is not applied is committed immediately.

10.55 DDL_LOCK_TIMEOUT

Basic Information

Item	Description
Name	DDL_LOCK_TIMEOUT
Summary	a time limit (sec) for how long DDL statemets will wait
Data type	BIGINT
Applicable phase	NO MOUNT or above
Updatable	TRUE
ALTER SESSION	TRUE
ALTER SYSTEM	IMMEDIATE
MIN	0
MAX	100000000
Default value	0

Description

It means the lock wait time when DDL operations occur to the same object at the same time. The default value is 0 second, and it does not wait for a lock when the DDL operation occurs.

When operations of altering a table structure simultaneously occur, they wait for the time specified in DDL_LOCK_TIMEOUT, without waiting for other transactions termination as follows.

- Transaction A

```
ALTER TABLE t1 ADD COLUMN ( new_column NUMBER );
```

- Transaction B

```
TRUNCATE TABLE t1;
```

If the waiting time exceeds DDL_LOCK_TIMEOUT, an error occurs as follows.

```
gSQL> TRUNCATE TABLE t1;
ERR-HYT00(14026): resource busy or timeout expired
```

10.56 DEFAULT_GLOBAL_SECONDARY_INDEX_CREATION

Basic Information

Item	Description
Name	DEFAULT_GLOBAL_SECONDARY_INDEX_CREATION
Summary	specifies whether or not create global secondary index at table creation
Data type	BOOLEAN
Applicable phase	NO MOUNT or above
Updatable	TRUE
ALTER SESSION	TRUE
ALTER SYSTEM	FALSE
MIN	0
MAX	1
Default value	YES

Description

It sets whether to create the global secondary index when creating a table in cluster system. A non-deterministic query for the table which did not create the global secondary index fails. The global secondary index can be separately created after creating the table when the property is set to NO.

10.57 DEFAULT_INDEX_LOGGING

Basic Information

Item	Description
Name	DEFAULT_INDEX_LOGGING
Summary	default logging flag of indexes
Data type	BOOLEAN
Applicable phase	NO MOUNT or above
Updatable	TRUE
ALTER SESSION	TRUE
ALTER SYSTEM	IMMEDIATE
MIN	0
MAX	1
Default value	NO

Description

If LOGGING property is not explicitly set by a user when an index is created, then it is set to DEFAULT_INDEX_LOGGING value. If an index is created in LOGGING tablespace, the LOGGING property should be set.

10.58 DEFAULT_INDEX_PCTFREE

Basic Information

Item	Description
Name	DEFAULT_INDEX_PCTFREE
Summary	default pctfree value of indexes (%)
Data type	BIGINT
Applicable phase	NO MOUNT or above
Updatable	TRUE
ALTER SESSION	TRUE
ALTER SYSTEM	IMMEDIATE
MIN	0
MAX	99
Default value	0

Description

If a user does not explicitly specify PCTFREE syntax when creating an index. The PCTFREE is set to DEFAULT_INDEX_PCTFREE property value.

10.59 DEFAULT_INITRANS

Basic Information

Item	Description
Name	DEFAULT_INITRANS
Summary	default initrans value of tables
Data type	BIGINT
Applicable phase	NO MOUNT or above
Updatable	TRUE
ALTER SESSION	TRUE
ALTER SYSTEM	IMMEDIATE
MIN	1
MAX	32
Default value	4

Description

If a user does not explicitly set INITRANS syntax when creating a table or an index, then it is set to DEFAULT_INITRANS property value.

10.60 DEFAULT_MAXTRANS

Basic Information

Item	Description
Name	DEFAULT_MAXTRANS
Summary	default maxtrans value of tables
Data type	BIGINT
Applicable phase	NO MOUNT or above
Updatable	TRUE
ALTER SESSION	TRUE
ALTER SYSTEM	IMMEDIATE
MIN	1
MAX	32
Default value	8

Description

If a user does not explicitly set the MAXTRANS syntax when creating a table or an index, then it is set to DEFAULT_MAXTRANS property value.

10.61 DEFAULT_PCTFREE

Basic Information

Item	Description
Name	DEFAULT_PCTFREE
Summary	default pctfree value of tables (%)
Data type	BIGINT
Applicable phase	NO MOUNT or above
Updatable	TRUE
ALTER SESSION	TRUE
ALTER SYSTEM	IMMEDIATE
MIN	0
MAX	99
Default value	10

Description

If a user does not explicitly set the PCTFREE property when creating a table, it is set to DEFAULT_PCTFREE property value.

10.62 DEFAULT_PCTUSED

Basic Information

Item	Description
Name	DEFAULT_PCTUSED
Summary	default pctused value of tables (%)
Data type	BIGINT
Applicable phase	NO MOUNT or above
Updatable	TRUE
ALTER SESSION	TRUE
ALTER SYSTEM	IMMEDIATE
MIN	0
MAX	99
Default value	60

Description

If a user does not explicitly set the PCTUSED property when creating a table, it is set to DEFAULT_PCTUSED value.

10.63 DEFAULT_REMOVAL_BACKUP_FILE

Basic Information

Item	Description
Name	DEFAULT_REMOVAL_BACKUP_FILE
Summary	default removal flag of incremental backup files
Data type	BOOLEAN
Applicable phase	NO MOUNT or above
Updatable	TRUE
ALTER SESSION	TRUE
ALTER SYSTEM	IMMEDIATE
MIN	0
MAX	1
Default value	NO

Description

It specifies whether to delete the backup file when deleting the backup list.

10.64 DEFAULT_REMOVAL_OBSOLETE_BACKUP_LIST

Basic Information

Item	Description
Name	DEFAULT_REMOVAL_OBSOLETE_BACKUP_LIST
Summary	default removal flag of obsolete incremental backup lists
Data type	BOOLEAN
Applicable phase	NO MOUNT or above
Updatable	TRUE
ALTER SESSION	TRUE
ALTER SYSTEM	IMMEDIATE
MIN	0
MAX	1
Default value	NO

Description

It specifies whether to delete the previous obsoleted backup list when executing INCREMENTAL BACKUP.

10.65 DEFAULT_SHARDING

Basic Information

Item	Description
Name	DEFAULT_SHARDING
Summary	default sharding strategy (0: cloned, 1: hash sharding)
Data type	BOOLEAN
Applicable phase	NO MOUNT or above
Updatable	TRUE
ALTER SESSION	TRUE
ALTER SYSTEM	DEFERRED
MIN	0
MAX	1
Default value	NO

Description

It sets the default sharding strategy to be used if the sharding strategy is not determined when creating a table.

The following is an example of executing CREATE TABLE statement.

```
CREATE TABLE t1
(
  id INTEGER,
  name VARCHAR(128)
);
```

If DEFAULT_SHARDING value is 0 (cloned), the table is created as a cloned table as follows.

```
CREATE TABLE t1
(
  id INTEGER,
  name VARCHAR(128)
)
CLONED
```

```
AT CLUSTER WIDE
;
```

If DEFAULT_SHARDING value is 1 (hash sharding), the table is created as a hash-sharded table as follows.

```
CREATE TABLE t1
(
  id INTEGER,
  name VARCHAR(128)
)
SHARDING BY HASH (id)
SHARD COUNT 24
AT CLUSTER WIDE
;
```

If DEFAULT_SHARDING is 1 (hash sharding) and <table sharding strategy> is not described, then the hash sharding key is determined based on the following order.

1. If PRIMARY KEY constraint is defined, primary key is used as a sharding key.

- The original message

```
CREATE TABLE t1 ( id INTEGER PRIMARY KEY, name VARCHAR(128) );
```

- Translation

```
CREATE TABLE t1 ( id INTEGER PRIMARY KEY, name VARCHAR(128) )
SHARDING BY HASH(id)
SHARD COUNT 24
AT CLUSTER WIDE;
```

2. If UNIQUE constraint is defined, the firstly described UNIQUE constraint is used as the sharding key.

- The original message

```
CREATE TABLE t1 ( id INTEGER, name VARCHAR(128) UNIQUE );
```

- Translation

```
CREATE TABLE t1 ( id INTEGER, name VARCHAR(128) UNIQUE )
SHARDING BY HASH(name)
SHARD COUNT 24
AT CLUSTER WIDE;
```

3. If key constraint is not defined, the first column except for the following excluded data type is used as a sharding key.
 - The excluded data type: LONG VARCHAR, LONG VARBINARY, BOOLEAN
- The original message

```
CREATE TABLE t1 ( is_man BOOLEAN, id INTEGER, name VARCHAR(128) );
```

- Translation

```
CREATE TABLE t1 ( is_man BOOLEAN, id INTEGER, name VARCHAR(128) )  
    SHARDING BY HASH(id)  
    SHARD COUNT 24  
    AT CLUSTER WIDE;
```

10.66 DISABLE_DDL_CDC_GIVEUP

Basic Information

Item	Description
Name	DISABLE_DDL_CDC_GIVEUP
Summary	disable DDL which causing CDC give-up
Data type	BOOLEAN
Applicable phase	OPEN
Updatable	TRUE
ALTER SESSION	TRUE
ALTER SYSTEM	TRUE
MIN	0
MAX	1
Default value	NO

Description

It prohibits DDL operation on the table of supplemental log, because it affects CDC's give up.

For more information, refer to **Table 45-1 The occurrence of give up and whether to allow DDL statements according to DDL category.**

10.67 DISABLE_UPDATE_PK_CDC_GIVEUP

Basic Information

Item	Description
Name	DISABLE_UPDATE_PK_CDC_GIVEUP
Summary	disable UPDATE primary key which caused CDC give-up
Data type	BOOLEAN
Applicable phase	NO MOUNT or above
Updatable	TRUE
ALTER SESSION	TRUE
ALTER SYSTEM	IMMEDIATE
MIN	0
MAX	1
Default value	NO

Description

It disables UPDATE primary key which caused CDC give up.

10.68 DISALLOWED_PROTOCOL_TARGETTYPE

Basic Information

Item	Description
Name	DISALLOWED_PROTOCOL_TARGETTYPE
Summary	disallowed TARGETTYPE protocol
Data type	BOOLEAN
Applicable phase	NO MOUNT or above
Updatable	TRUE
ALTER SESSION	FALSE
ALTER SYSTEM	DEFERRED
MIN	0
MAX	1
Default value	NO

Description

It disallows TARGETTYPE protocol.

10.69 DISALLOWED_PROTOCOL_TARGETTYPE_WITH_ALL

Basic Information

Item	Description
Name	DISALLOWED_PROTOCOL_TARGETTYPE_WITH_ALL
Summary	disallowed TARGETTYPE_WITH_ALL protocol
Data type	BOOLEAN
Applicable phase	NO MOUNT or above
Updatable	TRUE
ALTER SESSION	FALSE
ALTER SYSTEM	DEFERRED
MIN	0
MAX	1
Default value	NO

Description

It disallows TARGETTYPE_WITH_ALL protocol.

10.70 DISALLOWED_PROTOCOL_TARGETTYPE_WITH_NAME

Basic Information

Item	Description
Name	DISALLOWED_PROTOCOL_TARGETTYPE_WITH_NAME
Summary	disallowed TARGETTYPE_WITH_NAME protocol
Data type	BOOLEAN
Applicable phase	NO MOUNT or above
Updatable	TRUE
ALTER SESSION	FALSE
ALTER SYSTEM	DEFERRED
MIN	0
MAX	1
Default value	NO

Description

It disallows TARGETTYPE_WITH_NAME protocol.

10.71 DISPATCHER_CM_BUFFER_SIZE

Basic Information

Item	Description
Name	DISPATCHER_CM_BUFFER_SIZE
Summary	communication buffer size
Data type	BIGINT
Applicable phase	NONE
Updatable	TRUE
ALTER SESSION	FALSE
ALTER SYSTEM	FALSE
MIN	10485760
MAX	34359738368
Default value	31457280

Description

It is the size of entire communication buffer used in shared mode. It is allocated to and used in Shared Static Area (SSA).

10.72 DISPATCHER_CM_UNIT_SIZE

Basic Information

Item	Description
Name	DISPATCHER_CM_UNIT_SIZE
Summary	communication unit size
Data type	BIGINT
Applicable phase	MOUNT or below
Updatable	TRUE
ALTER SESSION	FALSE
ALTER SYSTEM	IMMEDIATE
MIN	1024
MAX	10485760
Default value	1024

Description

It is the unit size managed by dispatcher in shared mode. If the size is large, the memory is wasted. If it is small, the performance is degraded. It is set to the maximum communication packet size in the shared mode.

10.73 DISPATCHER_CONNECTIONS

Basic Information

Item	Description
Name	DISPATCHER_CONNECTIONS
Summary	maximum number of connections for each dispatcher
Data type	BIGINT
Applicable phase	MOUNT or below
Updatable	TRUE
ALTER SESSION	FALSE
ALTER SYSTEM	IMMEDIATE
MIN	10
MAX	32768
Default value	950

Description

It is the maximum number of connection (client) which a dispatcher can manage in shared mode.

If the system- supported maximum value is smaller than the set value, it is internally set to the system maximum.

10.74 DISPATCHER_HOT_POLICY_INTERVAL

Basic Information

Item	Description
Name	DISPATCHER_HOT_POLICY_INTERVAL
Summary	dispatcher dequeue interval for busy waiting
Data type	BIGINT
Applicable phase	NO MOUNT or above
Updatable	TRUE
ALTER SESSION	FALSE
ALTER SYSTEM	IMMEDIATE
MIN	0
MAX	86400000000: 1 day
Default value	100000: 0.1 second

Description

It is the dispatcher dequeue interval for busy waiting. (micro second)

10.75 DISPATCHER_LOAD_BALANCING

Basic Information

Item	Description
Name	DISPATCHER_LOAD_BALANCING
Summary	load balancing algorithm for shared mode (0: number of clients, 1: round robin)
Data type	BIGINT
Applicable phase	NO MOUNT or above
Updatable	TRUE
ALTER SESSION	FALSE
ALTER SYSTEM	IMMEDIATE
MIN	0
MAX	1
Default value	0

Description

It is an algorithm allocating a dispatcher when connecting to a client in the shared mode.

- 0: It is allocated to a dispatcher of which the number of currently attached clients are small.
- 1: It is sequentially allocated to a dispatcher.

10.76 DISPATCHER_NUMA_STREAM_MAP

Basic Information

Item	Description
Name	DISPATCHER_NUMA_STREAM_MAP
Summary	numa stream map for dispatcher
Data type	VARCHAR
Applicable phase	NONE
Updatable	TRUE
ALTER SESSION	FALSE
ALTER SYSTEM	FALSE
MIN	N/A
MAX	N/A
Default value	'x' : no binding

Description

It determines NUMA node to which dispatchers are to be connected. This property is operated when NUMA property is set to on.

The following is an example of three dispatchers. It connects number 0 stream to number 0 NUMA node, connects number 1 stream to number 1 NUMA node, and number 2 stream to number 2 NUMA node.

```
DISPATCHER_NUMA_STREAM_MAP = '0:1:2'
```

10.77 DISPATCHER_QUEUE_SIZE

Basic Information

Item	Description
Name	DISPATCHER_QUEUE_SIZE
Summary	dispatcher queue size
Data type	BIGINT
Applicable phase	MOUNT or below
Updatable	TRUE
ALTER SESSION	FALSE
ALTER SYSTEM	IMMEDIATE
MIN	1024
MAX	32768
Default value	1024

Description

In shared mode, it sets the queue size for the communication between the dispatcher and the shared-server.

10.78 DISPATCHER_REQUEST_MINI_QUEUE_COUNT

Basic Information

Item	Description
Name	DISPATCHER_REQUEST_MINI_QUEUE_COUNT
Summary	count of mini queue per request queue
Data type	BIGINT
Applicable phase	NONE
Updatable	TRUE
ALTER SESSION	FALSE
ALTER SYSTEM	FALSE
MIN	1
MAX	16
Default value	4

Description

It is the count of mini queue per request queue.

10.79 DISPATCHER_RESPONSE_MINI_QUEUE_COUNT

Basic Information

Item	Description
Name	DISPATCHER_RESPONSE_MINI_QUEUE_COUNT
Summary	count of mini queue per response queue
Data type	BIGINT
Applicable phase	NONE
Updatable	TRUE
ALTER SESSION	FALSE
ALTER SYSTEM	FALSE
MIN	1
MAX	16
Default value	4

Description

It is the count of mini queue per response queue.

10.80 DISPATCHERS

Basic Information

Item	Description
Name	DISPATCHERS
Summary	number of dispatcher processes
Data type	BIGINT
Applicable phase	NO MOUNT or above
Updatable	TRUE
ALTER SESSION	FALSE
ALTER SYSTEM	IMMEDIATE
MIN	1
MAX	256
Default value	2

Description

It sets the number of dispatcher processes when using the shared mode.
It can not reduce the value by using alter system on open phase.

10.81 FETCH_FAILOVER

Basic Information

Item	Description
Name	FETCH_FAILOVER
Summary	enable fetch failover
Data type	BOOLEAN
Applicable phase	NO MOUNT or above
Updatable	TRUE
ALTER SESSION	TRUE
ALTER SYSTEM	FALSE
MIN	0
MAX	1
Default value	NO

Description

It enables the fetch failover.

10.82 GLOBAL_CONNECTION_ALLOW_SESSION_DEPENDENCY

Basic Information

Item	Description
Name	GLOBAL_CONNECTION_ALLOW_SESSION_DEPENDENCY
Summary	allowed session dependent features in global connection
Data type	BOOLEAN
Applicable phase	NO MOUNT or above
Updatable	TRUE
ALTER SESSION	TRUE
ALTER SYSTEM	TRUE
MIN	0
MAX	1
Default value	NO

Description

It sets whether to support the query execution including the session dependent information in the global connection.

10.83 GLOBAL_JOURNAL_BUFFER_SIZE

Basic Information

Item	Description
Name	GLOBAL_JOURNAL_BUFFER_SIZE
Summary	global journal buffer size
Data type	BIGINT
Applicable phase	NONE
Updatable	TRUE
ALTER SESSION	FALSE
ALTER SYSTEM	FALSE
MIN	1024
MAX	10 Giga
Default value	1 Mega

Description

It is the size of global journal buffer.

10.84 GLOBAL_JOURNAL_BUFFER_TOTAL_MAX_SIZE

Basic Information

Item	Description
Name	GLOBAL_JOURNAL_BUFFER_TOTAL_MAX_SIZE
Summary	global journal buffer total max size
Data type	BIGINT
Applicable phase	NONE
Updatable	TRUE
ALTER SESSION	FALSE
ALTER SYSTEM	FALSE
MIN	1 Mega
MAX	100 Giga
Default value	64 Mega

Description

It is the total max size of global journal buffer.

10.85 GLOBAL_PROPERTY_LOCK_TIMEOUT

Basic Information

Item	Description
Name	GLOBAL_PROPERTY_LOCK_TIMEOUT
Summary	a time limit(second) for how long global property lock statements will wait
Data type	BIGINT
Applicable phase	NO MOUNT or above
Updatable	TRUE
ALTER SESSION	TRUE
ALTER SYSTEM	IMMEDIATE
MIN	0 (infinite)
MAX	100000000
Default value	0

Description

When changing the global property, it performs the lock to control the concurrency. In this case, the waiting time to perform the lock is set.

10.86 GLOBAL_TRANSACTION_COMMIT_WRITE_MODE

Basic Information

Item	Description
Name	GLOBAL_TRANSACTION_COMMIT_WRITE_MODE
Summary	global transaction commit write mode (0: no_wait, 1: wait, 2: disable)
Data type	BIGINT
Applicable phase	NO MOUNT or above
Updatable	TRUE
ALTER SESSION	TRUE
ALTER SYSTEM	IMMEDIATE
MIN	0
MAX	2
Default value	2

Description

It is a property to change the commit write mode of the global transaction. TRANSACTION_COMMIT_WRITE_MODE property is applied to all transactions, but GLOBAL_TRANSACTION_COMMIT_WRITE_MODE property is applied only to a global transaction. If the property is set to 2, then it follows the TRANSACTION_COMMIT_WRITE_MODE.

- 0: It does not wait.
- 1: It waits.
- 2: It follows the value of TRANSACTION_COMMIT_WRITE_MODE.

10.87 GLOBAL_TRANSACTION_ISOLATION_SCOPE

Basic Information

Item	Description
Name	GLOBAL_TRANSACTION_ISOLATION_SCOPE
Summary	isolation scope for global transaction(0: system, 1: group)
Data type	BIGINT
Applicable phase	NO MOUNT or above
Updatable	TRUE
ALTER SESSION	TRUE
ALTER SYSTEM	IMMEDIATE
MIN	0
MAX	1
Default value	0

Description

It determines whether to process the data with a global transaction or with multiple domain transactions when the transaction changed the data through two cluster groups.

- 0: It processes with a global transaction.
- 1: It processes with multiple domain transactions.



If this property is set to 1, it commits each cluster group with a separate transaction, so it does not guarantee the transaction atomicity.

10.88 GLOBAL_TRANSACTION_LOG_DIR

Basic Information

Item	Description
Name	GLOBAL_TRANSACTION_LOG_DIR
Summary	default global transaction log directory
Data type	VARCHAR
Applicable phase	NO MOUNT or above
Updatable	TRUE
ALTER SESSION	FALSE
ALTER SYSTEM	DEFERRED
MIN	N/A
MAX	N/A
Default value	\$(GOLDILOCKS_DATA)/wal

Description

It is the default directory of global transaction log.

10.89 GLOBAL_TRANSACTION_LOG_FILE_SIZE

Basic Information

Item	Description
Name	GLOBAL_TRANSACTION_LOG_FILE_SIZE
Summary	global transaction log file size
Data type	BIGINT
Applicable phase	NONE
Updatable	TRUE
ALTER SESSION	FALSE
ALTER SYSTEM	FALSE
MIN	20 Mega
MAX	10 Giga
Default value	100 Mega

Description

It is the file size of global transaction log.

10.90 GMASTER_NUMA_NODE

Basic Information

Item	Description
Name	GMASTER_NUMA_NODE
Summary	numa node for gmaster process
Data type	BIGINT
Applicable phase	NONE
Updatable	TRUE
ALTER SESSION	FALSE
ALTER SYSTEM	FALSE
MIN	-1
MAX	63
Default value	-1

Description

It sets the ID of NUMA node to be used by gmaster daemon. This property is operated when NUMA property is set to on.

10.91 GMON_AUTOSTART

Basic Information

Item	Description
Name	GMON_AUTOSTART
Summary	Indicate whether gmon process automatically starts or not (0 1)
Data type	BOOLEAN
Applicable phase	MOUNT or below
Updatable	TRUE
ALTER SESSION	FALSE
ALTER SYSTEM	FALSE
MIN	0
MAX	1
Default value	1

Description

It sets whether to start gmon process automatically.

10.92 HINT_ERROR

Basic Information

Item	Description
Name	HINT_ERROR
Summary	enable hint error
Data type	BOOLEAN
Applicable phase	NO MOUNT or above
Updatable	TRUE
ALTER SESSION	TRUE
ALTER SYSTEM	DEFERRED
MIN	0
MAX	1
Default value	NO

Description

It sets whether to check syntax error and validation error for hint syntax.

10.93 IDLE_TIMEOUT

Basic Information

Item	Description
Name	IDLE_TIMEOUT
Summary	idle timeout(s)
Data type	BIGINT
Applicable phase	NO MOUNT or above
Updatable	TRUE
ALTER SESSION	TRUE
ALTER SYSTEM	IMMEDIATE
MIN	0
MAX	10000000
Default value	0

Description

It sets the maximum IDLE time possible to wait in C/S session. If it exceeds the specified idle time, TIMEOUT error occurs.

- 0: It means infinite waiting, and TIMEOUT error does not occur.

10.94 INDEX_BUILD_PARALLEL_FACTOR

Basic Information

Item	Description
Name	INDEX_BUILD_PARALLEL_FACTOR
Summary	index build parallel factor
Data type	BIGINT
Applicable phase	NO MOUNT or above
Updatable	TRUE
ALTER SESSION	TRUE
ALTER SYSTEM	IMMEDIATE
MIN	0
MAX	64
Default value	0

Description

When creating an index, it specifies the number of parallel factor.

- 0: It is specified as the number of the core factor in the system.

10.95 INDEX_TREE_MERGE_PARALLEL_FACTOR

Basic Information

Item	Description
Name	INDEX_TREE_MERGE_PARALLEL_FACTOR
Summary	parallel factor for merging sub-trees
Data type	BIGINT
Applicable phase	NO MOUNT or above
Updatable	TRUE
ALTER SESSION	TRUE
ALTER SYSTEM	IMMEDIATE
MIN	0
MAX	64
Default value	0

Description

When creating an index, it specifies the number of parallel factor to merge the sub-tree.

If that value is bigger than INDEX_BUILD_PARALLEL_FACTOR, then INDEX_BUILD_PARALLEL_FACTOR is used.

- 0: It follows INDEX_BUILD_PARALLEL_FACTOR.

10.96 INST_ALLOCATOR_COUNT

Basic Information

Item	Description
Name	INST_ALLOCATOR_COUNT
Summary	memory allocator count for instant tables or indexes
Data type	BIGINT
Applicable phase	NONE
Updatable	TRUE
ALTER SESSION	FALSE
ALTER SYSTEM	FALSE
MIN	3
MAX	128
Default value	3

Description

This property increases the parallel property of operation allocating or deleting an instant block.

10.97 INST_TABLE_BLOCK_SIZE

Basic Information

Item	Description
Name	INST_TABLE_BLOCK_SIZE
Summary	a block size of instant tables or indexes
Data type	BIGINT
Applicable phase	NO MOUNT or above
Updatable	TRUE
ALTER SESSION	TRUE
ALTER SYSTEM	IMMEDIATE
MIN	8192
MAX	1048576
Default value	16384

Description

It determines the size of an instant block. If the anchor area of an instant record is bigger than an instant block, then the following error occurs.

```
gSQL> SELECT DISTINCT * FROM T1, T1, T1, T1, T1, T1, T1, T1, T1, T1;
ERR-HY000(14098): maximum record length(16360) exceeds
```

10.98 IN_DOUBT_DECISION

Basic Information

Item	Description
Name	IN_DOUBT_DECISION
Summary	decision for in-doubt transaction
Data type	BIGINT
Applicable phase	MOUNT or below
Updatable	TRUE
ALTER SESSION	FALSE
ALTER SYSTEM	IMMEDIATE
MIN	1
MAX	2
Default value	2

Description

It determines whether to commit or to rollback the in-doubt transaction of distributed transactions.

- 1: Commit
- 2: Rollback

10.99 JOURNAL_TEMP_DIR

Basic Information

Item	Description
Name	JOURNAL_TEMP_DIR
Summary	journaling temporary directory
Data type	VARCHAR
Applicable phase	NO MOUNT or above
Updatable	TRUE
ALTER SESSION	FALSE
ALTER SYSTEM	DEFERRED
MIN	N/A
MAX	N/A
Default value	\$(GOLDILOCKS_DATA)/journal

Description

It is the temporary directory of journaling.

10.100 KEEPALIVE_IDLE_TIME

Basic Information

Item	Description
Name	KEEPALIVE_IDLE_TIME
Summary	tcp keepalive idle time for checking dead client session (sec)
Data type	BIGINT
Applicable phase	NO MOUNT or above
Updatable	TRUE
ALTER SESSION	FALSE
ALTER SYSTEM	DEFERRED
MIN	1
MAX	16383
Default value	300

Description

It means the idle duration between the server and client without tcp packet exchange before sending keep alive packet. If there is not tcp packet exchange for seconds (KEEPALIVE_IDLE_TIME), keep alive mechanism starts execution to detect the dead connection on the server side.

10.101 LOCAL_CLUSTER_MEMBER

Basic Information

Item	Description
Name	LOCAL_CLUSTER_MEMBER
Summary	local cluster member name
Data type	VARCHAR
Applicable phase	NONE
Updatable	FALSE
ALTER SESSION	FALSE
ALTER SYSTEM	NONE
MIN	N/A
MAX	N/A
Default value	'G1N1'

Description

It is the local cluster member name.

10.102 LOCAL_CLUSTER_MEMBER_HOST

Basic Information

Item	Description
Name	LOCAL_CLUSTER_MEMBER_HOST
Summary	host name of local cluster member
Data type	VARCHAR
Applicable phase	NONE
Updatable	FALSE
ALTER SESSION	FALSE
ALTER SYSTEM	NONE
MIN	N/A
MAX	N/A
Default value	'127.0.0.1'

Description

It is host name of local cluster member.

10.103 LOCAL_CLUSTER_MEMBER_PORT

Basic Information

Item	Description
Name	LOCAL_CLUSTER_MEMBER_PORT
Summary	listen port of local cluster member
Data type	BIGINT
Applicable phase	NONE
Updatable	FALSE
ALTER SESSION	FALSE
ALTER SYSTEM	NONE
MIN	1024
MAX	49151
Default value	10101

Description

It is listen port of local cluster member.

10.104 LOCAL_JOURNAL_BUFFER_SIZE

Basic Information

Item	Description
Name	LOCAL_JOURNAL_BUFFER_SIZE
Summary	local journal buffer size
Data type	BIGINT
Applicable phase	NONE
Updatable	TRUE
ALTER SESSION	FALSE
ALTER SYSTEM	FALSE
MIN	1024
MAX	10737418240 (10 Giga)
Default value	65536

Description

It is the local journal buffer size.

10.105 LOCATION_FILE

Basic Information

Item	Description
Name	LOCATION_FILE
Summary	location file name
Data type	VARCHAR
Applicable phase	NONE
Updatable	TRUE
ALTER SESSION	FALSE
ALTER SYSTEM	FALSE
MIN	N/A
MAX	N/A
Default value	<code>\$GOLDILOCKS_DATA/wal/location.ctl</code>

Description

It is the location file name.

10.106 LOCATOR_QUERY_TIMEOUT

Basic Information

Item	Description
Name	LOCATOR_QUERY_TIMEOUT
Summary	timeout for waiting locator response (sec)
Data type	BIGINT
Applicable phase	NO MOUNT or above
Updatable	TRUE
ALTER SESSION	FALSE
ALTER SYSTEM	IMMEDIATE
MIN	0
MAX	10000000
Default value	20

Description

It sets the time (second) waiting for the response after the cluster system enquires of a locator about the solution of split-brain situation. This property is used only when CLUSTER_SPLIT_BRAIN_RESOLUTION_POLICY is set to 1 or more.

10.107 LOCK_HASH_TABLE_SIZE

Basic Information

Item	Description
Name	LOCK_HASH_TABLE_SIZE
Summary	lock manager hash table size (The number of buckets)
Data type	BIGINT
Applicable phase	MOUNT or below
Updatable	TRUE
ALTER SESSION	FALSE
ALTER SYSTEM	IMMEDIATE
MIN	2
MAX	1000000
Default value	65519

Description

It specifies the maximum hash table size managed by a lock manager.

10.108 LOG_BLOCK_SIZE

Basic Information

Item	Description
Name	LOG_BLOCK_SIZE
Summary	log block size (byte)
Data type	BIGINT
Applicable phase	NONE
Updatable	FALSE
ALTER SESSION	FALSE
ALTER SYSTEM	FALSE
MIN	512
MAX	4096
Default value	512

Description

It means the minimum size of what log buffer is flushed to the log file of the disk. Its value should be set to one of 512, 1024, 2048, 4096.

10.109 LOG_BUFFER_SIZE

Basic Information

Item	Description
Name	LOG_BUFFER_SIZE
Summary	default log buffer size (byte)
Data type	BIGINT
Applicable phase	NO MOUNT or below
Updatable	TRUE
ALTER SESSION	FALSE
ALTER SYSTEM	IMMEDIATE
MIN	1048576
MAX	10737418240
Default value	10485760

Description

A log buffer is the shared memory space in which the redo logs generated in database by the DML/DDL operations are stored. LOG_BUFFER_SIZE is referenced to set the memory size for the log buffer.

10.110 LOG_DIR

Basic Information

Item	Description
Name	LOG_DIR
Summary	default log directory
Data type	VARCHAR
Applicable phase	NO MOUNT or above
Updatable	TRUE
ALTER SESSION	FALSE
ALTER SYSTEM	DEFERRED
MIN	N/A
MAX	N/A
Default value	\$GOLDILOCKS_DATA/wal

Description

The log recorded in the log buffer is flushed to the logfile which exists in a non-volatile storage device to ensure the database durability. LOG_DIR sets the path to the log file.

10.111 LOG_FILE_SIZE

Basic Information

Item	Description
Name	LOG_FILE_SIZE
Summary	log file size (byte)
Data type	BIGINT
Applicable phase	NONE
Updatable	FALSE
ALTER SESSION	FALSE
ALTER SYSTEM	FALSE
MIN	20 Mbytes
MAX	60 Gbytes
Default value	100 Mbytes

Description

It sets the size of the logfile used in database. It is referenced only when creating the database, then log file size can not be updated after then.

10.112 LOG_GROUP_COUNT

Basic Information

Item	Description
Name	LOG_GROUP_COUNT
Summary	initial count of log group
Data type	BIGINT
Applicable phase	NONE
Updatable	FALSE
ALTER SESSION	FALSE
ALTER SYSTEM	FALSE
MIN	4
MAX	254
Default value	4

Description

It sets the number of log group used in database. It is referenced only when creating the database, but after that, it does not affect any operations. After creating database, the operation to add or remove a log group is supported by a separate syntax.

10.113 LOG_MIRROR_MODE

Basic Information

Item	Description
Name	LOG_MIRROR_MODE
Summary	LogMirror Mode (1:Enable, 0:Disable)
Data type	BOOLEAN
Applicable phase	MOUNT or below
Updatable	TRUE
ALTER SESSION	FALSE
ALTER SYSTEM	IMMEDIATE
MIN	0
MAX	1
Default value	NO

Description

It is the property to configure the required shared memory when operating LogMirror, the redo log replication tool, at database startup.

It should be enabled to execute the LogMirror.

The size of the shared Memory can be changed using LOG_MIRROR_SHARED_MEMORY_STATIC_SIZE.

10.114 LOG_MIRROR_SHARED_MEMORY_STATIC_SIZE

Basic Information

Item	Description
Name	LOG_MIRROR_SHARED_MEMORY_STATIC_SIZE
Summary	shared memory size for LogMirror (byte)
Data type	BIGINT
Applicable phase	MOUNT or below
Updatable	TRUE
ALTER SESSION	FALSE
ALTER SYSTEM	IMMEDIATE
MIN	10485760 (10 M)
MAX	1073741824 (1 G)
Default value	104857600 (100 M)

Description

It sets the size of the shared memory used in LogMirror, the redo-log replication tool. It is applied in the state which LOG_MIRROR_MODE is enabled.

10.115 LOG_MIRROR_TIMEOUT

Basic Information

Item	Description
Name	LOG_MIRROR_TIMEOUT
Summary	logmirror retry timeout (sec)
Data type	BIGINT
Applicable phase	NO MOUNT or above
Updatable	TRUE
ALTER SESSION	FALSE
ALTER SYSTEM	IMMEDIATE
MIN	0
MAX	100000000
Default value	0

Description

It is the response waiting time of the LogMirror.

If its value is 0, it waits indefinitely. Otherwise, it waits as long as the value set, then TIMEOUT occurs, and it stops LogMirror service. Later, the server is operated normally.

It is applied in the state which LOG_MIRROR_MODE is enabled.

10.116 LOG_SYNC_INTERVAL

Basic Information

Item	Description
Name	LOG_SYNC_INTERVAL
Summary	interval for synchronize log (s)
Data type	BIGINT
Applicable phase	NO MOUNT or above
Updatable	TRUE
ALTER SESSION	FALSE
ALTER SYSTEM	IMMEDIATE
MIN	1
MAX	10000
Default value	3

Description

Log flusher of GOLDILOCKS is a system thread which flushes the log buffer contents to disk logfile. When log flusher wakes up in the idle phase, it checks if log to flush exists. Then it flushes the log if any. If the log flusher did not flush within the time set in LOG_SYNC_INTERVAL, it synchronizes the log buffer and the log file by performing a flush until the last block of the current log buffer.

10.117 LOG_SYNC_INTERVAL_MSEC

Basic Information

Item	Description
Name	LOG_SYNC_INTERVAL_MSEC
Summary	milli-second interval for synchronize log
Data type	BIGINT
Applicable phase	NO MOUNT or above
Updatable	TRUE
ALTER SESSION	FALSE
ALTER SYSTEM	IMMEDIATE
MIN	0
MAX	10000000
Default value	0

Description

It is the millisecond interval for synchronize log.

10.118 MAX_GROUP_COUNT

Basic Information

Item	Description
Name	MAX_GROUP_COUNT
Summary	maximum group count
Data type	BIGINT
Applicable phase	NONE
Updatable	TRUE
ALTER SESSION	FALSE
ALTER SYSTEM	FALSE
MIN	0
MAX	8192
Default value	32

Description

It is the maximum group count.

10.119 MAX_JOURNAL_FILE_SIZE

Basic Information

Item	Description
Name	MAX_JOURNAL_FILE_SIZE
Summary	maximum journal file size
Data type	BIGINT
Applicable phase	MOUNT or above
Updatable	TRUE
ALTER SESSION	FALSE
ALTER SYSTEM	IMMEDIATE
MIN	0
MAX	1099511627776 (1 Terabytes)
Default value	0 (no limit)

Description

It sets the maximum size (quota) of the global journaling file which internally stores journaling data when a journaling occurs in cluster system.

10.120 MAX_NODE_COUNT

Basic Information

Item	Description
Name	MAX_NODE_COUNT
Summary	maximum node count
Data type	BIGINT
Applicable phase	NONE
Updatable	FALSE
ALTER SESSION	FALSE
ALTER SYSTEM	NONE
MIN	1
MAX	8192
Default value	64

Description

It is the maximum node count.

10.121 MAXIMUM_CONCURRENT_ACTIVITIES

Basic Information

Item	Description
Name	MAXIMUM_CONCURRENT_ACTIVITIES
Summary	maximum number of active statements that the driver can support for a connection
Data type	BIGINT
Applicable phase	NO MOUNT or above
Updatable	TRUE
ALTER SESSION	FALSE
ALTER SYSTEM	DEFERRED
MIN	1
MAX	65535
Default value	1024

Description

It sets the number of statements which can be executed simultaneously.

10.122 MAXIMUM_FLANGE_COUNT

Basic Information

Item	Description
Name	MAXIMUM_FLANGE_COUNT
Summary	maximum flange count in a plan clock
Data type	BIGINT
Applicable phase	NO MOUNT or above
Updatable	TRUE
ALTER SESSION	FALSE
ALTER SYSTEM	IMMEDIATE
MIN	128
MAX	65535
Default value	1024

Description

It is the maximum number of flanges which can be expanded in plan clock.

10.123 MAXIMUM_FLUSH_LOG_BLOCK_COUNT

Basic Information

Item	Description
Name	MAXIMUM_FLUSH_LOG_BLOCK_COUNT
Summary	maximum number of log block count to be flushing
Data type	BIGINT
Applicable phase	NO MOUNT or above
Updatable	TRUE
ALTER SESSION	FALSE
ALTER SYSTEM	IMMEDIATE
MIN	1000
MAX	2000000
Default value	100000

Description

When flushing the contents of the log buffer to disk log file, it sets the maximum number of log blocks to be flushed with a single writing operation.

10.124 MAXIMUM_FLUSH_PAGE_COUNT

Basic Information

Item	Description
Name	MAXIMUM_FLUSH_PAGE_COUNT
Summary	maximum number of page count to be flushing
Data type	BIGINT
Applicable phase	NO MOUNT or above
Updatable	TRUE
ALTER SESSION	FALSE
ALTER SYSTEM	IMMEDIATE
MIN	1
MAX	8192
Default value	1024

Description

GOLDILOCKS datafiles are flushed to the disk by the checkpoint and certain DDL statements. For flushing datafiles, it sets the maximum number of data pages to be flushed with a single writing operation.

10.125 MAXIMUM_JOURNAL_REPLAY_COUNT

Basic Information

Item	Description
Name	MAXIMUM_JOURNAL_REPLAY_COUNT
Summary	maximum number of replaying journals for rebalance table
Data type	BIGINT
Applicable phase	NO_MOUNT or above
Updatable	TRUE
ALTER SESSION	TRUE
ALTER SYSTEM	IMMEDIATE
MIN	2
MAX	1024
Default value	2

Description

The table rebalancing online can be performed together with dml in the cluster environment, and dml records the updates on the journal log at that moment. The table rebalancing initially applies the journal logs which occurred during synchronizing tables, then applies journal logs which were accumulated while applying the journal logs. This property sets how many times the journal logs are applied in this way.

10.126 MAXIMUM_NAMED_CURSOR_COUNT

Basic Information

Item	Description
Name	MAXIMUM_NAMED_CURSOR_COUNT
Summary	maximum number of named cursor that the driver can support for a connection
Data type	BIGINT
Applicable phase	NO MOUNT or above
Updatable	TRUE
ALTER SESSION	FALSE
ALTER SYSTEM	DEFERRED
MIN	1
MAX	100000
Default value	128

Description

It is the maximum number of named cursor which can be used within a single session.

A named cursor is created in the following cases.

- When a named cursor is declared using functions like `SQLSetCursorName()`, `SQLGetCursorName()`.

```
{
  ...
  SQLSetCursorName( stmt,
                   "my_cursor",
                   SQL_NTS );
  ...
}
```

- When the DECLARE cursor syntax is used by a function such as `SQLExecDirect ()`, `SQLPrepare ()`.

```
{
  ...
  SQLExecDirect( stmt,
                "DECLARE my_cursor CURSOR FOR SELECT col_name FROM tab_name",
```

```

        SQL_NTS );
    ...
}

```

- When DECLARE cursor FOR UPDATE syntax is used in an embedded SQL.

```

{
    ...
    EXEC SQL DECLARE my_cursor CURSOR FOR SELECT col_name FROM tab_name FOR UPDATE;
    ...
    EXEC SQL OPEN my_cursor;
    ...
    EXEC SQL FETCH my_cursor INTO :data;
    EXEC SQL DELETE FROM tab_name WHERE CURRENT OF my_cursor;
    ...
    EXEC SQL CLOSE my_cursor;
}

```



In an embedded SQL, DECLARE CURSOR syntax without FOR UPDATE as follows does not create a named cursor on the session.

```

{
    ...
    EXEC SQL DECLARE my_cursor CURSOR FOR SELECT col_name FROM tab_name;
    ...
}

```

10.127 MAXIMUM_SESSION_CM_BUFFER_SIZE

Basic Information

Item	Description
Name	MAXIMUM_SESSION_CM_BUFFER_SIZE
Summary	maximum communication bytes per shared mode session
Data type	BIGINT
Applicable phase	MOUNT or below
Updatable	TRUE
ALTER SESSION	TRUE
ALTER SYSTEM	IMMEDIATE
MIN	1048576
MAX	1073741824
Default value	20971520

Description

It sets the maximum buffer size available in a single session which is connected to shared mode. For more information, refer to **DISPATCHER_CM_BUFFER_SIZE**.

10.128 MEASURE_CLUSTER_LATENCY

Basic Information

Item	Description
Name	MEASURE_CLUSTER_LATENCY
Summary	measure cluster latency
Data type	BOOL
Applicable phase	NO MOUNT or above
Updatable	TRUE
ALTER SESSION	TRUE
ALTER SYSTEM	IMMEDIATE
MIN	0
MAX	1
Default value	NO

Description

It is the measure cluster latency.

10.129 MEMORY_MERGE_RUN_COUNT

Basic Information

Item	Description
Name	MEMORY_MERGE_RUN_COUNT
Summary	merge run count for memory index
Data type	BIGINT
Applicable phase	NO MOUNT or above
Updatable	TRUE
ALTER SESSION	TRUE
ALTER SYSTEM	IMMEDIATE
MIN	2
MAX	64
Default value	32

Description

Memory B-tree index of bottom-up approach is created by extracting all keys from a table, sorting them in certain block size (MEMORY_SORT_RUN_SIZE) units, merging the sorted blocks, and generating the internal node. MEMORY_MERGE_RUN_COUNT sets the number of the sorted blocks to be merged at a time.

10.130 MEMORY_SORT_RUN_SIZE

Basic Information

Item	Description
Name	MEMORY_SORT_RUN_SIZE
Summary	sort run size for memory index (byte)
Data type	BIGINT
Applicable phase	NO MOUNT or above
Updatable	TRUE
ALTER SESSION	TRUE
ALTER SYSTEM	IMMEDIATE
MIN	8192
MAX	32768
Default value	8192

Description

Memory B-tree index of bottom-up approach is created by extracting all keys from a table, sorting them in a certain block size (MEMORY_SORT_RUN_SIZE) unit, merging the sorted blocks, and generating the internal node. MEMORY_SORT_RUN_SIZE sets the size of a single block to be sorted.

10.131 MINIMUM_UNDO_PAGE_COUNT

Basic Information

Item	Description
Name	MINIMUM_UNDO_PAGE_COUNT
Summary	minimum undo page count
Data type	BIGINT
Applicable phase	NO MOUNT or above
Updatable	TRUE
ALTER SESSION	FALSE
ALTER SYSTEM	IMMEDIATE
MIN	16
MAX	1048576
Default value	16

Description

DML uses the undo page to store the previous image. Undo page is consumed by using a single undo segment per DML. If all allocated pages of undo segments are consumed, the page of another undo segment can be used. MINIMUM UNDO PAGE_COUNT is the minimum number of undo page to specify the undo segment to import page when undo pages are insufficient. If the undo pages are insufficient, the pages can be imported only from the undo segment having more pages than MINIMUM UNDO PAGE_COUNT.

10.132 MIN_SAMPLE_ROW_COUNT

Basic Information

Item	Description
Name	MIN_SAMPLE_ROW_COUNT
Summary	minimum sampling row count for analyze table
Data type	BIGINT
Applicable phase	NO MOUNT or above
Updatable	TRUE
ALTER SESSION	TRUE
ALTER SYSTEM	DEFERRED
MIN	0
MAX	9223372036854775807 (INT64_MAX)
Default value	100000

Description

It is the minimum number of sampling rows when executing **ANALYZE TABLE** by using the sampling.

10.133 NET_BUFFER_SIZE

Basic Information

Item	Description
Name	NET_BUFFER_SIZE
Summary	TCP network buffer size (byte)
Data type	BIGINT
Applicable phase	NO MOUNT or above
Updatable	TRUE
ALTER SESSION	FALSE
ALTER SYSTEM	DEFERRED
MIN	1024
MAX	1073741824
Default value	32768

Description

It sets the TCP communications buffer size.

In the dedicated mode, it is set to the maximum communication packet size.

In the shared mode, it is set to `DISPATCHER_CM_UNIT_SIZE`.

10.134 NLS_DATE_FORMAT

Basic Information

Item	Description
Name	NLS_DATE_FORMAT
Summary	nls date format
Data type	VARCHAR
Applicable phase	NO MOUNT or above
Updatable	TRUE
ALTER SESSION	TRUE
ALTER SYSTEM	FALSE
MIN	N/A
MAX	N/A
Default value	YYYY-MM-DD

Description

NLS_DATE_FORMAT specifies the default date format of TO_CHAR and TO_DATE functions.

10.135 NLS_TIME_FORMAT

Basic Information

Item	Description
Name	NLS_TIME_FORMAT
Summary	nls time format
Data type	VARCHAR
Applicable phase	NO MOUNT or above
Updatable	TRUE
ALTER SESSION	TRUE
ALTER SYSTEM	FALSE
MIN	N/A
MAX	N/A
Default value	HH24:MI:SS.FF6

Description

NLS_DATE_FORMAT specifies the default time format of TO_CHAR and TO_DATE functions.

10.136 NLS_TIME_WITH_TIME_ZONE_FORMAT

Basic Information

Item	Description
Name	NLS_TIME_WITH_TIME_ZONE_FORMAT
Summary	nls time with time zone format
Data type	VARCHAR
Applicable phase	NO MOUNT or above
Updatable	TRUE
ALTER SESSION	TRUE
ALTER SYSTEM	FALSE
MIN	N/A
MAX	N/A
Default value	HH24:MI:SS.FF6 TZH:TZM

Description

NLS_TIME_WITH_TIME_ZONE_FORMAT specifies the default time with time zone format of TO_CHAR and TO_TIME_WITH_TIME_ZONE functions.

10.137 NLS_TIMESTAMP_FORMAT

Basic Information

Item	Description
Name	NLS_TIMESTAMP_FORMAT
Summary	nls timestamp format
Data type	VARCHAR
Applicable phase	NO MOUNT or above
Updatable	TRUE
ALTER SESSION	TRUE
ALTER SYSTEM	FALSE
MIN	N/A
MAX	N/A
Default value	YYYY-MM-DD HH24:MI:SS.FF6

Description

NLS_TIMESTAMP_FORMAT specifies the default timestamp format of TO_CHAR and TO_TIMESTAMP functions.

10.138 NLS_TIMESTAMP_WITH_TIME_ZONE_FORMAT

Basic Information

Item	Description
Name	NLS_TIMESTAMP_WITH_TIME_ZONE_FORMAT
Summary	nls timestamp with time zone format
Data type	VARCHAR
Applicable phase	NO MOUNT or above
Updatable	TRUE
ALTER SESSION	TRUE
ALTER SYSTEM	FALSE
MIN	N/A
MAX	N/A
Default value	YYYY-MM-DD HH24:MI:SS.FF6 TZH:TZM

Description

NLS_TIMESTAMP_WITH_TIME_ZONE_FORMAT specifies the default timestamp with time zone format of TO_CHAR and TO_TIMESTAMP WITH TIMEZONE functions.

10.139 NUMA

Basic Information

Item	Description
Name	NUMA
Summary	enable numa
Data type	BOOLEAN
Applicable phase	NONE
Updatable	TRUE
ALTER SESSION	FALSE
ALTER SYSTEM	FALSE
MIN	0
MAX	1
Default value	NO

Description

It enables NUMA.



To use the NUMA property in AIX, the user account should be modified. Execute the following command as a root user.

```
# chuser "capabilities=CAP_NUMA_ATTACH,CAP_PROPAGATE" <username>
```

<username> is not a root but it is a user account of AIX.

Logout then login again to apply the modifications.

10.140 NUMA_MAP

Basic Information

Item	Description
Name	NUMA_MAP
Summary	numa node map
Data type	VARCHAR
Applicable phase	NONE
Updatable	TRUE
ALTER SESSION	FALSE
ALTER SYSTEM	FALSE
MIN	N/A
MAX	N/A
Default value	'x' : no binding

Description

It sets the map to connect cores of the system to NUMA node. This property is operated when NUMA property is set to on.

The following is an example of the system having four cores.

- Connect core 0 and 1 to number 0 NUMA node, and core 2 and 3 to number 1 NUMA node.

```
NUMA_MAP = '0:0:1:1' # core
```

- Connect core 0 and 1 to number 0 NUMA node, and core 2 and 3 to number 1 NUMA node, and core 1 and 3 to number 2 NUMA node.

```
NUMA_MAP = '0:0,2:1:1,2' # core
```

10.141 OFFLINE_MEMBER_AFTER_FAILOVER

Basic Information

Item	Description
Name	OFFLINE_MEMBER_AFTER_FAILOVER
Summary	Automatically offline member after failover
Data type	BOOLEAN
Applicable phase	NO MOUNT or above
Updatable	TRUE
ALTER SESSION	FALSE
ALTER SYSTEM	IMMEDIATE
MIN	0
MAX	1
Default value	YES

Description

The background process automatically takes the errored member offline after completing the failover caused by the node error.

If it is not possible to take the errored member offline because it is set to *NO*, then execute the following syntax before the errored member joins the system again.

```
gSQL> ALTER DATABASE OFFLINE INACTIVE CLUSTER MEMBERS;  
Database altered.
```

10.142 ONLINE_JOURNAL_REPLAY_THRESHOLD

Basic Information

Item	Description
Name	ONLINE_JOURNAL_REPLAY_THRESHOLD
Summary	threshold bytes for replaying journals without table lock
Data type	BIGINT
Applicable phase	NO_MOUNT or above
Updatable	TRUE
ALTER SESSION	TRUE
ALTER SYSTEM	IMMEDIATE
MIN	0
MAX	10737418240 (10G)
Default value	1048576 (1M)

Description

The table rebalancing online applies journal logs several times which were recorded by dml occurred during the performance in the cluster environment. `MAXIMUM_JOURNAL_REPLAY_COUNT` sets how many times to apply the journal logs. However, if the amount of journal logs to be applied are small, then it is not repeated as many as it is set to be, but instantly set the table the `EXCLUSIVE` lock, and uses it as the threshold value to apply the last journal log.

10.143 OS_GROUP_ACCESS

Basic Information

Item	Description
Name	OS_GROUP_ACCESS
Summary	enable access database with OS group permission
Data type	BOOLEAN
Applicable phase	NO MOUNT or above
Updatable	TRUE
ALTER SESSION	FALSE
ALTER SYSTEM	DEFERRED
MIN	0
MAX	1
Default value	NO

Description

To connect to DA with another user of the same group, this property should be set to *YES*. Also, the `umask` of the system should be modified to `0002`.

10.144 PACKET_COMPRESSION_THRESHOLD

Basic Information

Item	Description
Name	PACKET_COMPRESSION_THRESHOLD
Summary	The size limit at which packets are compressed(bytes)
Data type	BIGINT
Applicable phase	NO MOUNT or above
Updatable	TRUE
ALTER SESSION	FALSE
ALTER SYSTEM	IMMEDIATE
MIN	32
MAX	2113929216
Default value	2113929216

Description

If the data size to be sent to the client is bigger than PACKET_COMPRESSION_THRESHOLD, it compresses the communication data.

10.145 PAGE_CHECKSUM_TYPE

Basic Information

Item	Description
Name	PAGE_CHECKSUM_TYPE
Summary	page checksum type (0:LSN, 1:CRC)
Data type	BIGINT
Applicable phase	NO MOUNT or above
Updatable	TRUE
ALTER SESSION	FALSE
ALTER SYSTEM	IMMEDIATE
MIN	0
MAX	1
Default value	0

Description

A checksum is used to guarantee the physical consistency for each page of the datafile. GOLDILOCKS supports a page checksum of LSN, CRC scheme.

- 0: LSN
- 1: CRC

10.146 PARALLEL_IO_FACTOR

Basic Information

Item	Information
Name	PARALLEL_IO_FACTOR
Summary	parallel load factor
Data type	BIGINT
Applicable phase	NO MOUNT or below
Updatable	TRUE
ALTER SESSION	FALSE
ALTER SYSTEM	DEFERRED
MIN	1
MAX	16
Default value	1

Description

It sets the number of threads for the parallel loading of data file when starting database and the number of threads for parallel recording of data file at checkpoint.

10.147 PARALLEL_IO_GROUP_1 ~ PARALLEL_IO_GROUP_16

Basic Information

Item	Description
Name	PARALLEL_IO_GROUP_1
Summary	parallel load group 1
Data type	VARCHAR
Applicable phase	NO MOUNT or below
Updatable	TRUE
ALTER SESSION	FALSE
ALTER SYSTEM	DEFERRED
MIN	N/A
MAX	N/A
Default value	\$GOLDILOCKS_DATA/db

Description

It sets the group directory for parallel I/O of data file. It sets the number of group as many as PARALLEL_I
O_FACTOR, then parallel I/O is performed in data file unit which belongs to each group.

10.148 PARALLEL_LOAD_FACTOR

Basic Information

Item	Description
Name	PARALLEL_LOAD_FACTOR
Summary	parallel load factor
Data type	BIGINT
Applicable phase	NO MOUNT or below
Updatable	TRUE
ALTER SESSION	FALSE
ALTER SYSTEM	IMMEDIATE
MIN	1
MAX	64
Default value	1

Description

When starting database, it sets the number of threads for parallel operation after loading the memory of a data file.

10.149 PENDING_LOG_BUFFER_COUNT

Basic Information

Item	Description
Name	PENDING_LOG_BUFFER_COUNT
Summary	default pending log buffer count
Data type	BIGINT
Applicable phase	NO MOUNT or below
Updatable	TRUE
ALTER SESSION	FALSE
ALTER SYSTEM	IMMEDIATE
MIN	0
MAX	32
Default value	4

Description

When multiple transactions are simultaneously running, the pending log buffer is used to reduce the competition for the log buffer. PENDING LOG_BUFFER COUNT sets the number of pending log buffer which can be used simultaneously.

10.150 PLAN_CACHE

Basic Information

Item	Description
Name	PLAN_CACHE
Summary	caching sql plan
Data type	BOOLEAN
Applicable phase	NO MOUNT or above
Updatable	TRUE
ALTER SESSION	TRUE
ALTER SYSTEM	DEFERRED
MIN	0
MAX	1
Default value	YES

Description

It determines whether to use the plan cache.

10.151 PLAN_CACHE_SIZE

Basic Information

Item	Description
Name	PLAN_CACHE_SIZE
Summary	sql plan cache size (byte)
Data type	BIGINT
Applicable phase	NONE
Updatable	TRUE
ALTER SESSION	FALSE
ALTER SYSTEM	FALSE
MIN	20971520
MAX	1099511627776
Default value	104857600

Description

It sets the memory size to be used for the plan cache.

10.152 PRIVATE_STATIC_AREA_SIZE

Basic Information

Item	Description
Name	PRIVATE_STATIC_AREA_SIZE
Summary	Shared Static Area Size (byte)
Data type	BIGINT
Applicable phase	NO MOUNT or above
Updatable	TRUE
ALTER SESSION	TRUE
ALTER SYSTEM	IMMEDIATE
MIN	104857600
MAX	34359738368
Default value	104857600

Description

It specifies the maximum heap memory size to be allocated by the session.

10.153 PROCESS_MAX_COUNT

Basic Information

Item	Description
Name	PROCESS_MAX_COUNT
Summary	Process Max Count
Data type	BIGINT
Applicable phase	NONE
Updatable	TRUE
ALTER SESSION	FALSE
ALTER SYSTEM	FALSE
MIN	12
MAX	65535
Default value	128

Description

It specifies the maximum number of processes (threads) available on the system.

Creating system process

- The process is created each time of connection to D/A mode or C/S dedicated mode.
- In C/S shared mode, processes are basic balancer, dispatcher and shared-server. A process is not created when connecting from client.

10.154 QUERY_TIMEOUT

Basic Information

Item	Description
Name	QUERY_TIMEOUT
Summary	query timeout (s)
Data type	BIGINT
Applicable phase	NO MOUNT or above
Updatable	TRUE
ALTER SESSION	TRUE
ALTER SYSTEM	IMMEDIATE
MIN	0
MAX	10000000
Default value	0

Description

It specifies the maximum time which a command received from the session can be executed. If the execution time exceeds, the TIMEOUT error occurs.

- 0: It means infinite waiting, and TIMEOUT error does not occur.

10.155 READABLE_ARCHIVELOG_DIR_COUNT

Basic Information

Item	Description
Name	READABLE_ARCHIVELOG_DIR_COUNT
Summary	readable archive log directory count
Data type	BIGINT
Applicable phase	NO MOUNT or above
Updatable	TRUE
ALTER SESSION	TRUE
ALTER SYSTEM	DEFERRED
MIN	1
MAX	10
Default value	1

Description

It sets the number of directories in which archive redo logs exist when executing media recovery.

10.156 READABLE_BACKUP_DIR_COUNT

Basic Information

Item	Description
Name	READABLE_BACKUP_DIR_COUNT
Summary	readable backup directory count
Data type	BIGINT
Applicable phase	NO MOUNT or above
Updatable	TRUE
ALTER SESSION	TRUE
ALTER SYSTEM	DEFERRED
MIN	1
MAX	10
Default value	1

Description

It sets the number of directories in which incremental backups exist when restoring files using incremental backups.

10.157 REBALANCE_BLOCK_READ_COUNT

Basic Information

Item	Description
Name	REBALANCE_BLOCK_READ_COUNT
Summary	block read count for rebalance
Data type	BIGINT
Applicable phase	NO MOUNT or above
Updatable	TRUE
ALTER SESSION	TRUE
ALTER SYSTEM	DEFERRED
MIN	1
MAX	65536
Default value	1

Description

It is the block read count for rebalance.

10.158 RECOMPILE_CHECK_MINIMUM_PAGE_COUNT



It is not supported after 3.1.

Basic Information

Item	Description
Name	RECOMPILE_CHECK_MINIMUM_PAGE_COUNT
Summary	minimum page count for recompile check
Data type	BIGINT
Applicable phase	NO MOUNT or above
Updatable	TRUE
ALTER SESSION	TRUE
ALTER SYSTEM	IMMEDIATE
MIN	1
MAX	10000
Default value	64

Description

It sets the minimum page count to check if the plan is recompiled due to the page count modification.

10.159 RECOMPILE_PAGE_PERCENT



It is not supported after 3.1.

Basic Information

Item	Description
Name	RECOMPILE_PAGE_PERCENT
Summary	recompile page percent
Data type	BIGINT
Applicable phase	NO MOUNT or above
Updatable	TRUE
ALTER SESSION	TRUE
ALTER SYSTEM	IMMEDIATE
MIN	0
MAX	1000
Default value	30

Description

It sets the page percent when recompiles the plan due to the page count modification. If its value is 0, it does not recompile due to the page count modification.

10.160 RECOVERY_LOG_BUFFER_SIZE

Basic Information

Item	Description
Name	RECOVERY_LOG_BUFFER_SIZE
Summary	default log buffer size for recovery
Data type	BIGINT
Applicable phase	NO MOUNT or above
Updatable	TRUE
ALTER SESSION	TRUE
ALTER SYSTEM	IMMEDIATE
MIN	786432
MAX	32 Mega
Default value	10 Mega

Description

It is the default log buffer size for recovery

10.161 REDO_LOG_COMPRESSION_THRESHOLD

Basic Information

Item	Description
Name	REDO_LOG_COMPRESSION_THRESHOLD
Summary	The size limit at which redo log are compressed(bytes)
Data type	BIGINT
Applicable phase	NO MOUNT or above
Updatable	TRUE
ALTER SESSION	FALSE
ALTER SYSTEM	IMMEDIATE
MIN	32
MAX	2113929216
Default value	256

Description

If the size of the created REDO LOG is bigger than REDO_LOG_COMPRESSION_THRESHOLD value, it compresses REDO LOG.

10.162 REFINE_RELATION

Basic Information

Item	Description
Name	REFINE_RELATION
Summary	refine aged relations
Data type	BOOLEAN
Applicable phase	NO MOUNT or above
Updatable	TRUE
ALTER SESSION	FALSE
ALTER SYSTEM	IMMEDIATE
MIN	0
MAX	1
Default value	YES

Description

If this property is set to NO, then REFINE RELATION process is not performed when restarting the server.

This property can be used when an error occurs during the REFINE RELATION process. However, segments of RELATIONS (tables or indexes) which were dropped but not REFINEd can not be reused. When resolving the error then setting this property to YES and restarting, it tries to REFINE Relations which were not dropped.

10.163 SESSION_FATAL_BEHAVIOR

Basic Information

Item	Description
Name	SESSION_FATAL_BEHAVIOR
Summary	session fatal behavior
Data type	BIGINT
Applicable phase	NO MOUNT or above
Updatable	TRUE
ALTER SESSION	FALSE
ALTER SYSTEM	IMMEDIATE
MIN	0
MAX	1
Default value	0

Description

When session fatal occurs, it determines whether to terminate only the thread which caused the fatal or to terminate the process.

- 0: It terminates only the thread which caused fatal.
- 1: It terminates the process.

If multiple sessions are simultaneously performed in the process, the process is terminated after all sessions finish using database.

10.164 SESSION_MEMORY_INIT_SIZE

Basic Information

Item	Description
Name	SESSION_MEMORY_INIT_SIZE
Summary	initial memory size for session
Data type	BIGINT
Applicable phase	NO MOUNT or above
Updatable	TRUE
ALTER SESSION	FALSE
ALTER SYSTEM	IMMEDIATE
MIN	131072 (128K)
MAX	1073741824 (1G)
Default value	131072 (128K)

Description

It sets the shared memory size to be allocated in advance so that it can be used in the session.

10.165 SESSION_MEMORY_SHRINK_THRESHOLD

Basic Information

Item	Description
Name	SESSION_MEMORY_SHRINK_THRESHOLD
Summary	threshold bytes to attempt to shrink session memory allocator (byte)
Data type	BIGINT
Applicable phase	NO MOUNT or above
Updatable	TRUE
ALTER SESSION	FALSE
ALTER SYSTEM	IMMEDIATE
MIN	131072 (128K)
MAX	1073741824 (1G)
Default value	131072 (128K)

Description

It sets the threshold value to determine whether to return the dynamic shared memory which is not used by the session to the system when releasing the dynamic shared memory used in the session. In other words, if the memory chunk which is bigger than the set value among unused memory exists, then it is returned to the system.

10.166 SHARED_MEMORY_ADDRESS

Basic Information

Item	Description
Name	SHARED_MEMORY_ADDRESS
Summary	shared memory address
Data type	BIGINT
Applicable phase	NONE
Updatable	TRUE
ALTER SESSION	FALSE
ALTER SYSTEM	FALSE
MIN	N/A
MAX	N/A
Default value	1610612736

Description

It specifies the address of Shared Static Area (SSA).

10.167 SHARED_MEMORY_STATIC_KEY

Basic Information

Item	Description
Name	SHARED_MEMORY_STATIC_KEY
Summary	Shared Memory Static KEY
Data type	BIGINT
Applicable phase	NONE
Updatable	TRUE
ALTER SESSION	FALSE
ALTER SYSTEM	FALSE
MIN	N/A
MAX	N/A
Default value	542353

Description

When running server, it specifies the shared memory key values which are used to allocate Static Shared Area (SSA) space.

10.168 SHARED_MEMORY_STATIC_NAME

Basic Information

Item	Description
Name	SHARED_MEMORY_STATIC_NAME
Summary	Shared Memory Static Name
Data type	VARCHAR
Applicable phase	NONE
Updatable	TRUE
ALTER SESSION	FALSE
ALTER SYSTEM	FALSE
MIN	N/A
MAX	N/A
Default value	_STATIC

Description

When running server, it specifies the shared memory name which is used to allocate Static Shared Area (S SA) space.

10.169 SHARED_MEMORY_STATIC_SIZE

Basic Information

Item	Description
Name	SHARED_MEMORY_STATIC_SIZE
Summary	Shared Memory Static Size (byte)
Data type	BIGINT
Applicable phase	NONE
Updatable	TRUE
ALTER SESSION	FALSE
ALTER SYSTEM	FALSE
MIN	104857600
MAX	1099511627776
Default value	629145600

Description

It specifies the size of the Shared Static Area (SSA).

10.170 SHARED_REQUEST_QUEUE_COUNT

Basic Information

Item	Description
Name	SHARED_REQUEST_QUEUE_COUNT
Summary	count of global request queue
Data type	BIGINT
Applicable phase	NONE
Updatable	TRUE
ALTER SESSION	FALSE
ALTER SYSTEM	FALSE
MIN	1
MAX	16
Default value	1

Description

In shared mode, it sets the number of queues of which the dispatcher requests to the shared-server. A queue is used when multiple dispatchers allocate user's requests to the shared-server. Generally, a single queue is used for the load-balance.

However, SHARED_REQUEST_QUEUE_COUNT value is increased because if the number of dispatcher and shared-server increase, then a conflict to the queue causes performance degradation.

If the the value becomes bigger, the load-balance can be inefficient and the possibility of deadlock increases.

10.171 SHARED_SERVERS

Basic Information

Item	Description
Name	SHARED_SERVERS
Summary	number of shared-server processes
Data type	BIGINT
Applicable phase	NO MOUNT or above
Updatable	TRUE
ALTER SESSION	FALSE
ALTER SYSTEM	IMMEDIATE
MIN	1
MAX	2048
Default value	10

Description

It sets the number of shared-server processes on shared mode.

At open phase, the value can not be decreased by using alter system.

10.172 SHARED_SESSION

Basic Information

Item	Description
Name	SHARED_SESSION
Summary	to enable shared session
Data type	BOOL
Applicable phase	MOUNT or below
Updatable	TRUE
ALTER SESSION	FALSE
ALTER SYSTEM	IMMEDIATE
MIN	0
MAX	1
Default value	YES

Description

It sets whether to activate shared mode. If the value is set to *NO*, load-balancer (gbalancer), dispatcher (g dispatcher), shared-server (gserver) are not executed.

10.173 SNAPSHOT_STATEMENT_TIMEOUT

Basic Information

Item	Description
Name	SNAPSHOT_STATEMENT_TIMEOUT
Summary	snapshot statement timeout (s)
Data type	BIGINT
Applicable phase	NO MOUNT or above
Updatable	TRUE
ALTER SESSION	FALSE
ALTER SYSTEM	IMMEDIATE
MIN	1
MAX	22118400 (1 year)
Default value	22118400 (1 year)

Description

It sets the maximum holding time of the statement required for the snapshot read. TIMEOUT error occurs for a snapshot statement which exceeds the time.

10.174 SQL_HISTORY_SIZE

Basic Information

Item	Description
Name	SQL_HISTORY_SIZE
Summary	history size for SQLs
Data type	BIGINT
Applicable phase	NO MOUNT or above
Updatable	TRUE
ALTER SESSION	FALSE
ALTER SYSTEM	DEFERRED
MIN	0
MAX	100000
Default value	0

Description

It is the history size for SQLs.

10.175 SQL_HISTORY_TYPE

Basic Information

Item	Description
Name	SQL_HISTORY_TYPE
Summary	history type for SQLs
Data type	BIGINT
Applicable phase	NO MOUNT or above
Updatable	TRUE
ALTER SESSION	TRUE
ALTER SYSTEM	IMMEDIATE
MIN	0
MAX	2
Default value	0

Description

It is the history type for SQLs.

- 0: Direct-execute
- 1: Prepare-execute
- 2: All

10.176 SUPPLEMENTAL_LOG_DATA_PRIMARY_KEY

Basic Information

Item	Description
Name	SUPPLEMENTAL_LOG_DATA_PRIMARY_KEY
Summary	supplemental log data of primary key columns be logged in redo log files
Data type	BOOLEAN
Applicable phase	MOUNT or below
Updatable	TRUE
ALTER SESSION	FALSE
ALTER SYSTEM	IMMEDIATE
MIN	0
MAX	1
Default value	NO

Description

It records supplemental log for all changes in the database.

10.177 SYSTEM_LOGGER_DIR

Basic Information

Item	Description
Name	SYSTEM_LOGGER_DIR
Summary	system logger directory
Data type	VARCHAR
Applicable phase	NONE
Updatable	TRUE
ALTER SESSION	FALSE
ALTER SYSTEM	FALSE
MIN	N/A
MAX	N/A
Default value	\$GOLDILOCKS_DATA/trc

Description

It sets the disk path on which the trace log message is recorded.

10.178 SYSTEM_MEMORY_AUX_TABLESPACE_SIZE

Basic Information

Item	Description
Name	SYSTEM_MEMORY_AUX_TABLESPACE_SIZE
Summary	default system memory auxiliary tablespace size (byte)
Data type	BIGINT
Applicable phase	NONE
Updatable	FALSE
ALTER SESSION	FALSE
ALTER SYSTEM	NONE
MIN	32 Mega
MAX	30 Giga
Default value	200 Mega

Description

It determines the size of initial MEM_AUX_TBS tablespace when creating the database.

10.179 SYSTEM_MEMORY_DATA_TABLESPACE_SIZE

Basic Information

Item	Description
Name	SYSTEM_MEMORY_DATA_TABLESPACE_SIZE
Summary	default system memory data tablespace size (byte)
Data type	BIGINT
Applicable phase	NONE
Updatable	FALSE
ALTER SESSION	FALSE
ALTER SYSTEM	NONE
MIN	32 Mega
MAX	30 Giga
Default value	200 Mega

Description

It determines the initial tablespace size of MEM_DATA_TBS when creating database.

10.180 SYSTEM_MEMORY_DICT_TABLESPACE_SIZE

Basic Information

Item	Description
Name	SYSTEM_MEMORY_DICT_TABLESPACE_SIZE
Summary	default dictionary tablespace size (byte)
Data type	BIGINT
Applicable phase	NONE
Updatable	FALSE
ALTER SESSION	FALSE
ALTER SYSTEM	NONE
MIN	256 Mega
MAX	30 Giga
Default value	256 Mega

Description

It determines the initial tablespace size of `DICTIONARY_TBS` when creating database.

10.181 SYSTEM_MEMORY_TEMP_TABLESPACE_SIZE

Basic Information

Item	Description
Name	SYSTEM_MEMORY_TEMP_TABLESPACE_SIZE
Summary	default system memory temporary tablespace size (byte)
Data type	BIGINT
Applicable phase	NONE
Updatable	FALSE
ALTER SESSION	FALSE
ALTER SYSTEM	NONE
MIN	32 Mega
MAX	30 Giga
Default value	200 Mega

Description

It determines the initial tablespace size of MEM_TEMP_TBS when creating database.

10.182 SYSTEM_MEMORY_UNDO_TABLESPACE_SIZE

Basic Information

Item	Description
Name	SYSTEM_MEMORY_UNDO_TABLESPACE_SIZE
Summary	default system memory undo tablespace size (byte)
Data type	BIGINT
Applicable phase	NONE
Updatable	FALSE
ALTER SESSION	FALSE
ALTER SYSTEM	NONE
MIN	32 Mega
MAX	30 Giga
Default value	32 Mega

Description

It determines the initial tablespace size of MEM_UNDO_TBS when creating database.

10.183 SYSTEM_TABLESPACE_DIR

Basic Information

Item	Description
Name	SYSTEM_TABLESPACE_DIR
Summary	system tablespace directory
Data type	VARCHAR
Applicable phase	NO MOUNT or above
Updatable	TRUE
ALTER SESSION	FALSE
ALTER SYSTEM	DEFERRED
MIN	N/A
MAX	N/A
Default value	\$(GOLDILOCKS_DATA)/db

Description

It sets the path to which the initial system tablespaces are stored when creating database.

10.184 SYSTEM_UDS_DIR

Basic Information

Item	Description
Name	SYSTEM_UDS_DIR
Summary	system unix domain socket directory
Data type	VARCHAR
Applicable phase	NONE
Updatable	TRUE
ALTER SESSION	FALSE
ALTER SYSTEM	FALSE
MIN	N/A
MAX	N/A
Default value	'/tmp'

Description

It sets a directory on which the unix domain socket file is created.

Setting the directory for the unix domain socket except for DB system, such asglsnr, is managed by a separate configuration file.

The maximum setting value is 60 bytes. (The maximum size of the absolute path (directory + file name) for the unix domain socket file varies according to OS, but generally it is around 100 bytes.)

10.185 TCP_CLIENT_NUMA_NODE

Basic Information

Item	Description
Name	TCP_CLIENT_NUMA_NODE
Summary	numa node for TCP clients
Data type	BIGINT
Applicable phase	NONE
Updatable	TRUE
ALTER SESSION	FALSE
ALTER SYSTEM	FALSE
MIN	-1
MAX	63
Default value	-1

Description

It sets the NUMA node ID to which the client server session is bound. This property is operated when NUMA property is set to on.

10.186 TCP_NODELAY

Basic Information

Item	Description
Name	TCP_NODELAY
Summary	no delays in buffer flushing within the TCP/IP protocol stack
Data type	BOOLEAN
Applicable phase	NO MOUNT or above
Updatable	TRUE
ALTER SESSION	FALSE
ALTER SYSTEM	DEFERRED
MIN	0
MAX	1
Default value	YES

Description

It sets TCP_NODELAY option of the socket when transferring the data to a client in C/S method (TCP socket).

Set it to *NO* when fast latency is not required and reducing the network load is needed.

10.187 TEMP_SEGMENT_CACHE_SIZE

Basic Information

Item	Description
Name	TEMP_SEGMENT_CACHE_SIZE
Summary	the number of segments to be cached for global temporary tables and indexes in each session
Data type	BIGINT
Applicable phase	NO MOUNT or above
Updatable	TRUE
ALTER SESSION	FALSE
ALTER SYSTEM	DEFERRED
MIN	0
MAX	4294967295
Default value	3

Description

It sets the number of segments to catch in a session instead of returning to a tablespace when dropping a global temporary table or a global temporary index segment. Segments in a segment cache is reused later in a global temporary table or a global temporary index.

- 0: It does not use a segment cache of a global temporary table or of a global temporary index in a session.
- 1 ~ 4294967295: It keeps the specific number of segment caches of a global temporary table or of a global temporary index in a session.

10.188 TEMP_UNDO_ENABLED

Basic Information

Item	Description
Name	TEMP_UNDO_ENABLED
Summary	enables writing undo records of global temporary tables to the temp table space
Data type	BOOLEAN
Applicable phase	NO MOUNT or above
Updatable	TRUE
ALTER SESSION	TRUE
ALTER SYSTEM	IMMEDIATE
MIN	0
MAX	1
Default value	0

Description

It defines the location of logging undo records for a global temporary table.

- 0 (FALSE): It records the undo records in the default undo tablespace of database.
- 1 (TRUE): It records the undo records in the default temporary tablespace of database.

10.189 TIMED_STATISTICS

Basic Information

Item	Description
Name	TIMED_STATISTICS
Summary	timed statistics
Data type	BIGINT
Applicable phase	NO MOUNT or above
Updatable	TRUE
ALTER SESSION	TRUE
ALTER SYSTEM	IMMEDIATE
MIN	0
MAX	2
Default value	0

Description

It is whether to check the wait event.

To record the statistics related to wait event on v\$system_event, v\$session_event and v\$session_wait table, set this property.

- 0: It does not record the statistics.
- 1: It records the statistics.
- 2: It records the statistics by using the high precision timer.

10.190 TIMEZONE

Basic Information

Item	Description
Name	TIMEZONE
Summary	timezone
Data type	VARCHAR
Applicable phase	NONE
Updatable	FALSE
ALTER SESSION	FALSE
ALTER SYSTEM	FALSE
MIN	N/A
MAX	N/A
Default value	+09:00

Description

It is a time zone value of database.

It is applied when creating database, and it uses the value of the range from '-14:00' to '+14:00'.

10.191 TRACE_ALTER_SYSTEM

Basic Information

Item	Description
Name	TRACE_ALTER_SYSTEM
Summary	write trace messages for ALTER SYSTEM
Data type	BOOLEAN
Applicable phase	NO MOUNT or above
Updatable	TRUE
ALTER SESSION	FALSE
ALTER SYSTEM	IMMEDIATE
MIN	0
MAX	1
Default value	NO

Description

It records the SQL statements in trace file (\$GOLDILOCKS_DATA/trc/system.trc) when executing ALTER SYSTEM syntax.

Set TRACE_ALTER_SYSTEM property to *ON* to record system changes.

SELECT inquiry, and execution of INSERT, UPDATE, DELETE syntax have nothing to do with TRACE_ALTER_SYSTEM property, so they do not affect the performance of TRACE_ALTER_SYSTEM.

10.192 TRACE_DDL

Basic Information

Item	Description
Name	TRACE_DDL
Summary	write trace messages for DDL
Data type	BOOLEAN
Applicable phase	NO MOUNT or above
Updatable	TRUE
ALTER SESSION	TRUE
ALTER SYSTEM	IMMEDIATE
MIN	0
MAX	1
Default value	NO

Description

When executing DDL, it records the executed SQL statements in trace file (\$GOLDILOCKS_DATA/trc/system.trc).

Set *TRACE_ALTER_SYSTEM* property to *ON* to record SQL statements execution such as CREATE/DROP/ALTER table.

TRACE_DDL property affects only to DDL statements. However, it has nothing to do with SELECT inquiry, and execution of INSERT, UPDATE, DELETE syntax. Therefore, it does not affect the performance.

10.193 TRACE_LOG_ID

Basic Information

Item	Description
Name	TRACE_LOG_ID
Summary	trace log ID
Data type	BIGINT
Applicable phase	NO MOUNT or above
Updatable	TRUE
ALTER SESSION	TRUE
ALTER SYSTEM	IMMEDIATE
MIN	0
MAX	100000000
Default value	0

Description

The execution plan for the query, and other related information are recorded in the trace file (opt_p[process ID_s [session ID].trc) under the trace directory (\$GOLDILOCKS_DATA/trc/) when processing queries. To record SQL statement for the query, the execution plan and the execution time, refer to the following flag information.

Table 10-1 Flag information for TRACE_LOG_ID

Information	Flag(on)	Flag(off)
Whether to output the successful SQL query	100000	0
Whether to output the failed SQL query	10000	0
Whether to output the execution plan	1000	0
Whether to output the execution type (direct/prepare)	100	0
Whether to output the bind value	10	0
Whether to output the execution time per section	1	0

To set it in a form of "output the successful SQL query" + "output the execution plan" + "output the bind value", set the TRACE_LOG_ID value to 101010.

10.194 TRACE_LOG_MSGBUF_SIZE

Basic Information

Item	Description
Name	TRACE_LOG_MSGBUF_SIZE
Summary	memory buffer size for trace log message
Data type	BIGINT
Applicable phase	NONE
Updatable	TRUE
ALTER SESSION	FALSE
ALTER SYSTEM	FALSE
MIN	8192
MAX	10485760
Default value	8192

Description

It sets the size of the heap memory buffer which is used to configure the log message to be recorded in the trace logfile.

10.195 TRACE_LOG_TIME_DETAIL

Basic Information

Item	Description
Name	TRACE_LOG_TIME_DETAIL
Summary	detail trace log time
Data type	BOOLEAN
Applicable phase	NO MOUNT or above
Updatable	TRUE
ALTER SESSION	TRUE
ALTER SYSTEM	IMMEDIATE
MIN	0
MAX	1
Default value	NO

Description

It sets whether to increase the time accuracy when recording trace log.

If the value is ON, it has an accuracy of 1 us.

If the value is OFF, it has an accuracy of 10 ms.

10.196 TRACE_LOGGER

Basic Information

Item	Description
Name	TRACE_LOGGER
Summary	trace log type (1:file, 2:file & remote)
Data type	BIGINT
Applicable phase	NONE
Updatable	TRUE
ALTER SESSION	FALSE
ALTER SYSTEM	IMMEDIATE
MIN	1
MAX	2
Default value	1

Description

It sets the target on which the trace log is written.

If it is 1, then it is recorded in a file, and if it is 2, then it is remotely recorded in a file.

When it is remotely written, then it remotely collects trace logs from gtrclogger and records in a file.

10.197 TRACE_LOGGER_REMOTE_HOST

Basic Information

Item	Description
Name	TRACE_LOGGER_REMOTE_HOST
Summary	remote host for trace logger
Data type	BIGINT
Applicable phase	NONE
Updatable	TRUE
ALTER SESSION	FALSE
ALTER SYSTEM	IMMEDIATE
MIN	0
MAX	255255255255
Default value	127000000001

Description

It sets the host to which the trace log is remotely transferred by setting TRACE_LOGGER to 2.

10.198 TRACE_LOGGER_REMOTE_PORT

Basic Information

Item	Description
Name	TRACE_LOGGER_REMOTE_PORT
Summary	remote port for trace logger
Data type	BIGINT
Applicable phase	NONE
Updatable	TRUE
ALTER SESSION	FALSE
ALTER SYSTEM	IMMEDIATE
MIN	1024
MAX	49151
Default value	21470

Description

It sets the port to which the trace log is remotely transferred by setting TRACE_LOGGER to 2.

10.199 TRACE_LOGIN

Basic Information

Item	Description
Name	TRACE_LOGIN
Summary	write login trace messages for user
Data type	BOOLEAN
Applicable phase	NO MOUNT or above
Updatable	TRUE
ALTER SESSION	FALSE
ALTER SYSTEM	IMMEDIATE
MIN	0
MAX	1
Default value	NO

Description

It records the related access information in trace file (\$GOLDILOCKS_DATA/trc/login.trc) on login. Set TRACE_LOGIN property to *ON* to record the related information on login.

10.200 TRACE_LONG_RUN_CURSOR

Basic Information

Item	Description
Name	TRACE_LONG_RUN_CURSOR
Summary	write trace SQL for cursor life-time over specific time (mili-sec. 0 ~ 10000000)
Data type	BIGINT
Applicable phase	NO MOUNT or above
Updatable	TRUE
ALTER SESSION	TRUE
ALTER SYSTEM	IMMEDIATE
MIN	0
MAX	10000000
Default value	0

Description

When cursor life-time is longer than the specified property time, then it records the SQL statement of the cursor in the trace file (\$GOLDILOCKS_DATA/trc/system.trc).

- Description of value
 - Unit: millisecond
 - Value 0: It does not record information.
 - Recommended value: 20 (millisecond) or longer
 - The value of 20 or longer is recommended because the execution time is measured using the time in 10 ms period.
- The following is an example of recording the SQL statement whose cursor life-time is longer than 1 second.

```
gSQL> ALTER SYSTEM SET TRACE_LONG_RUN_CURSOR = 1000;
```

- The following is an example of restoring to the default value.

```
gSQL> ALTER SYSTEM SET TRACE_LONG_RUN_CURSOR TO DEFAULT;
```

It is used to trace the user program maintaining the cursor for a long time as follows.

```
int main()
{
    ...
    EXEC SQL DECLARE cur1 CURSOR FOR SELECT name FROM t1 WHERE pk = :s_id;
    EXEC SQL OPEN cur1
    EXEC SQL FETCH cur1 INTO :s_name;
```

- Due to the user logic, ager fails to clean up resources for a long time.

```
long_run_user_logic( s_name );
    EXEC SQL CLOSE cur1;
    ...
}
```

10.201 TRACE_LONG_RUN_SQL

Basic Information

Item	Description
Name	TRACE_LONG_RUN_SQL
Summary	write trace for long-run SQL over specific execution time (mili-sec. 0 ~ 10000000)
Data type	BIGINT
Applicable phase	NO MOUNT or above
Updatable	TRUE
ALTER SESSION	TRUE
ALTER SYSTEM	IMMEDIATE
MIN	0
MAX	10000000
Default value	0

Description

It records the SQL statement whose execution time is longer than the specified property time in the trace file (\$GOLDILOCKS_DATA/trc/system.trc).

- Description of value
 - Unit: millisecond
 - Value 0: It does not record information.
 - Recommended value: 20 (millisecond) or longer
 - The value of 20 or longer is recommended because the execution time is measured using the time in 10 ms period.

The following is an example of recording the SQL statement whose execution time is longer than 1 second.

```
gSQL> ALTER SYSTEM SET TRACE_LONG_RUN_SQL = 1000;
```

The following is an example of restoring to the default value.

```
gSQL> ALTER SYSTEM SET TRACE_LONG_RUN_SQL TO DEFAULT;
```

10.202 TRACE_XA

Basic Information

Item	Description
Name	TRACE_XA
Summary	logging trace log for xa interfaces
Data type	BOOLEAN
Applicable phase	NO MOUNT or above
Updatable	TRUE
ALTER SESSION	FALSE
ALTER SYSTEM	IMMEDIATE
MIN	0
MAX	1
Default value	NO

Description

It specifies whether to output trace messages when using XA interface. Message is output to the 'SYSTEM_LOGGER_DIR / xa.trc'.

10.203 TRANSACTION_ALLOCATION_TIMEOUT

Basic Information

Item	Description
Name	TRANSACTION_ALLOCATION_TIMEOUT
Summary	a time limit (sec) for allocating transaction slot
Data type	BIGINT
Applicable phase	NO MOUNT or above
Updatable	TRUE
ALTER SESSION	TRUE
ALTER SYSTEM	IMMEDIATE
MIN	0
MAX	100000000
Default value	3

Description

It is the maximum waiting time when allocating transaction slots.

The following error occurs when the waiting time exceeds TRANSACTION_ALLOCATION_TIMEOUT.

```
gSQL> insert into t1 values(1);  
ERR-HYT00(14129): transaction allocation time exceeded
```

10.204 TRANSACTION_COMMIT_WRITE_MODE

Basic Information

Item	Description
Name	TRANSACTION_COMMIT_WRITE_MODE
Summary	transaction commit write mode (0: no_wait, 1: wait)
Data type	BIGINT
Applicable phase	NO MOUNT or above
Updatable	TRUE
ALTER SESSION	TRUE
ALTER SYSTEM	IMMEDIATE
MIN	0
MAX	1
Default value	0

Description

TRANSACTION_COMMIT_WRITE_MODE specifies whether a log generated by the transaction is flushed to the disk log file, when the transaction is committed. If TRANSACTION_COMMIT_WRITE_MODE is '1', the log should be flushed to the disk log file at the time of the transaction commit. Otherwise the transaction is committed regardless of log flush.

If the system is operated when TRANSACTION_COMMIT_WRITE_MODE is set to '0', the latest data will be lost when GOLDILOCKS is abnormally terminated without log flush after COMMIT transaction. It is because the logs are not recorded in this case.

Therefore, if all committed transactions should be remained (stored) in database, the system should be operated after setting TRANSACTION_COMMIT_WRITE_MODE to '1'. Or, 'ALTER SYSTEM FLUSH LOGS' statement should be explicitly performed at the time of transaction commit in order to flush log after TRANSACTION_COMMIT_WRITE_MODE is set to '0'.

- 0: no wait
- 1: wait

10.205 TRANSACTION_MAXIMUM_UNDO_PAGE_COUNT

Basic Information

Item	Description
Name	TRANSACTION_MAXIMUM_UNDO_PAGE_COUNT
Summary	The maximum number of undo pages that a transaction can write.
Data type	BIGINT
Applicable phase	NO MOUNT or below
Updatable	TRUE
ALTER SESSION	TRUE
ALTER SYSTEM	IMMEDIATE
MIN	1
MAX	838860800
Default value	838860800

Description

It means the maximum number of undo pages which the transaction can record. The minimum value is 1 (8 Kbytes) and the maximum value is 838860800 (100 Gbytes).

10.206 TRANSACTION_TABLE_SIZE

Basic Information

Item	Description
Name	TRANSACTION_TABLE_SIZE
Summary	transaction table size
Data type	BIGINT
Applicable phase	NO MOUNT or below
Updatable	TRUE
ALTER SESSION	FALSE
ALTER SYSTEM	IMMEDIATE
MIN	64
MAX	10240
Default value	1024

Description

It sets the maximum number of transaction table which is executed in database. The transaction table is allocated to ensure ACID of transaction when updating database. The database should restart to modify the number of transaction tables, and the number can be modified only to the number bigger than the previously specified number.

If it is modified to a smaller number, then the restart fails. For example, if the value set as 1,024 is modified to 512, then the restart fails as follows. In this case, modify it to 1,024 or bigger, then the restart succeeds.

```
gSQL> ALTER SYSTEM SET TRANSACTION_TABLE_SIZE = 512 SCOPE = FILE;
```

```
System altered.
```

```
gSQL> \CONNECT sys gliese as sysdba
```

```
gSQL> \SHUTDOWN
```

```
Shutdown success
```

- The restart fails.

```
gSQL> \STARTUP
```

```
ERR-HY000(14118): TRANSACTION_TABLE_SIZE property value must be equal to or greater than
```

```
'1024'
```

```
gSQL> ALTER SYSTEM SET TRANSACTION_TABLE_SIZE = 1024 SCOPE = FILE;
```

```
System altered.
```

```
gSQL> \SHUTDOWN
```

```
Shutdown success
```

```
gSQL> \STARTUP
```

```
Startup success
```

10.207 TRANSACTION_TIMEOUT

Basic Information

Item	Description
Name	TRANSACTION_TIMEOUT
Summary	transaction timeout (s)
Data type	BIGINT
Applicable phase	NO MOUNT or above
Updatable	TRUE
ALTER SESSION	FALSE
ALTER SYSTEM	IMMEDIATE
MIN	0
MAX	10000000
Default value	0

Description

It sets the duration of when the transaction is activated. It is used to prevent the side effects of when the transaction is activated for a long time. If a transaction exceeds the specified time, then gmaster daemon automatically terminates the session owned by that transaction.

10.208 UNDO_RELATION_ALLOCATION_TIMEOUT

Basic Information

Item	Description
Name	UNDO_RELATION_ALLOCATION_TIMEOUT
Summary	a time limit (sec) for allocating undo relation
Data type	BIGINT
Applicable phase	NO MOUNT or above
Updatable	TRUE
ALTER SESSION	TRUE
ALTER SYSTEM	IMMEDIATE
MIN	0
MAX	100000000
Default value	3

Description

It is the maximum waiting time when allocating undo relations.

The following error occurs when the waiting time exceeds UNDO_RELATION_ALLOCATION_TIMEOUT.

```
gSQL> insert into t1 values(1);  
ERR-HYT00(14130): undo relation allocation time exceeded
```

10.209 UNDO_RELATION_COUNT

Basic Information

Item	Description
Name	UNDO_RELATION_COUNT
Summary	undo relation count
Data type	BIGINT
Applicable phase	NO MOUNT or below
Updatable	TRUE
ALTER SESSION	FALSE
ALTER SYSTEM	IMMEDIATE
MIN	8
MAX	10240
Default value	128

Description

It sets the number of undo relation to be used in database. Undo relation is allocated for the purpose that the transaction executing DML uses undo segment. The database should restart to modify the number of undo relations, and the number can be modified only to the number bigger than the previously specified number.

If it is modified to a smaller number, then the restart fails. For example, if the value set as 128 is modified to 64, then the restart fails as follows. In this case, modify it to 128 or bigger, then the restart succeeds.

```
gSQL> ALTER SYSTEM SET UNDO_RELATION_COUNT = 64 SCOPE = FILE;
```

```
System altered.
```

```
gSQL> \CONNECT sys gliese as sysdba
```

```
gSQL> \SHUTDOWN
```

```
Shutdown success
```

- The restart fails.

```
gSQL> \STARTUP
```

```
ERR-HY000(14119): UNDO_RELATION_COUNT property value must be equal to or greater than '128'
```

```
gSQL> ALTER SYSTEM SET UNDO_RELATION_COUNT = 128 SCOPE = FILE;
```



```
System altered.  
gSQL> \SHUTDOWN  
Shutdown success  
gSQL> \STARTUP  
Startup success
```

10.210 UNDO_SHRINK_THRESHOLD

Basic Information

Item	Description
Name	UNDO_SHRINK_THRESHOLD
Summary	threshold bytes to attempt to shrink undo segment (byte)
Data type	BIGINT
Applicable phase	NO MOUNT or above
Updatable	TRUE
ALTER SESSION	FALSE
ALTER SYSTEM	IMMEDIATE
MIN	1048576
MAX	107374182400
Default value	10485760

Description

Ager thread periodically (10 seconds) checks the undo segment space. If an undo segment uses too much space, a part of it is returned to the tablespace. The property specifies the size (in bytes) of the space to be returned at a time.

10.211 USE_LARGE_PAGES

Basic Information

Item	Description
Name	USE_LARGE_PAGES
Summary	use large pages
Data type	BIGINT
Applicable phase	NO MOUNT or above
Updatable	TRUE
ALTER SESSION	FALSE
ALTER SYSTEM	IMMEDIATE
MIN	0
MAX	2
Default value	0

Description

It uses HugePage. HugePage should be set in the device beforehand to use USE_LARGE_PAGES.

- 0: It does not use the large page.
- 1: It uses the large page. If it fails to allocate the shared memory, then an error occurs.
- 2: It tries to allocate the shared memory by using the large page. If it fails to allocate the shared memory, then it allocates the memory by using the regular page.



It can be used only in Linux kernel 2.6.32-573 or higher.

Part III.

SQL Manual

11. SQL Elements	863
11.1 Syntax Elements	864
Identifiers	864
Literals	864
Null Value	877
Comments	878
SQL Reserved Words and Keywords	879
Compatibility for Syntax Elements	884
11.2 Data Type	885
Numeric Type	885
CHARACTER STRING Type	887
BINARY STRING Type	887
Date/ Time Type	888
INTERVAL Type	888
BOOLEAN Type	888
ROWID Type	889
Type Comparison	889
Type Conversion	896
Type Combination	903
Compatibility for Data Type	908
11.3 Format String	911
Number Format String	911
Datetime Format String	914
11.4 Expressions	925
Boolean Value Expression	925
CASE Expression	927
CAST Specification	929
Scalar Subquery Expression	930
Compatibility	930
11.5 Pseudo Columns	932
ROWID Pseudo Column	932
CLUSTER_GROUP_ID Pseudo Column	933
CLUSTER_MEMBER_ID Pseudo Column	934
CLUSTER_GROUP_NAME Pseudo Column	934
CLUSTER_MEMBER_NAME Pseudo Column	935
Compatibility	935
11.6 Operators	937
Arithmetic Operator	937
Concatenation Operator	938

Set Operator	938
Compatibility	939
11.7 Functions	940
Single Row Function	940
Aggregate Function	946
Compatibility	946
11.8 Conditions	948
Condition	948
Comparison Conditions	948
Logical Conditions	952
Null Condition	953
Compound Conditions	954
Pattern-matching Conditions	954
BETWEEN Condition	955
IN Condition	956
EXISTS Condition	957
Compatibility	958
11.9 Built-in Data Type References	960
Aliases of Built-in Data Types	960
BINARY	963
BINARY VARYING	964
BINARY LONG VARYING	965
BOOLEAN	966
CHARACTER	967
CHARACTER VARYING	968
CHARACTER LONG VARYING	969
DATE	970
FLOAT	971
INTERVAL	972
NATIVE_BIGINT	976
NATIVE_DOUBLE	977
NATIVE_INTEGER	978
NATIVE_REAL	979
NATIVE_SMALLINT	980
NUMBER	981
NUMERIC	983
ROWID	984
TIME	985
TIMESTAMP	986

11.10 Built-in Function References	987
* (MULTIPLICATION)	987
+ (ADDITION)	989
+ (POSITIVE)	991
- (NEGATIVE)	992
- (SUBTRACTION)	993
/ (DIVISION)	996
(CONCATENATE)	998
ABS	999
ACOS	1,000
ADDDATE	1,001
ADDTIME	1,002
ADD_MONTHS	1,003
ASCII	1,004
ASIN	1,005
ATAN	1,006
ATAN2	1,007
AVG	1,008
BITAND	1,009
BITNOT	1,010
BITOR	1,011
BITXOR	1,012
BIT_LENGTH	1,013
BYTE_LENGTH	1,014
CASE2	1,015
CBRT	1,017
CEIL	1,018
CHAR_LENGTH	1,019
CHR	1,020
CLOCK_DATE	1,021
CLOCK_LOCALTIME	1,022
CLOCK_LOCALTIMESTAMP	1,023
CLOCK_TIME	1,024
CLOCK_TIMESTAMP	1,025
COALESCE	1,026
CONCAT	1,027
CONCATENATE	1,028
COS	1,029
COT	1,030

COUNT	1,031
COUNT(*)	1,032
CURRENT_CATALOG	1,033
CURRENT_DATE	1,034
CURRENT_SCHEMA	1,035
CURRENT_TIME	1,036
CURRENT_TIMESTAMP	1,037
CURRENT_USER	1,038
CURRVAL	1,039
DATEADD	1,040
DATEDIFF	1,042
DATE_ADD	1,044
DATE_PART	1,045
DECODE	1,046
DEGREES	1,048
DIGEST	1,049
DUMP	1,050
EXP	1,051
EXTRACT	1,052
FACTORIAL	1,054
FLOOR	1,055
FROM_BASE64	1,056
GREATEST	1,057
HEX	1,058
INITCAP	1,059
INSTR	1,060
LAST_DAY	1,062
LAST_IDENTITY_VALUE	1,063
LEAST	1,066
LENGTH	1,067
LENGTHB	1,068
LN	1,069
LOCALTIME	1,070
LOCALTIMESTAMP	1,071
LOCAL_GROUP_ID	1,072
LOCAL_GROUP_NAME	1,073
LOCAL_MEMBER_ID	1,074
LOCAL_MEMBER_NAME	1,075
LOG	1,076

LOGON_USER	1,077
LOWER	1,078
LPAD	1,079
LTRIM	1,080
MAX	1,081
MIN	1,082
MOD	1,083
MONTHS_BETWEEN	1,084
NEXT_DAY	1,086
NEXTVAL	1,088
NULLIF	1,089
NVL	1,090
NVL2	1,091
OCTET_LENGTH	1,092
OVERLAY	1,093
PI	1,095
POSITION	1,096
POWER	1,097
RADIANS	1,098
RANDOM	1,099
REPEAT	1,100
REPLACE	1,101
REVERSE	1,102
ROUND(number)	1,103
ROUND(date)	1,104
ROWID_GRID_BLOCK_ID	1,106
ROWID_GRID_BLOCK_SEQ	1,107
ROWID_MEMBER_ID	1,108
ROWID_OBJECT_ID	1,109
ROWID_PAGE_ID	1,110
ROWID_ROW_NUMBER	1,111
ROWID_SHARD_ID	1,112
ROWID_TABLESPACE_ID	1,113
ROWNUM	1,114
RPAD	1,118
RTRIM	1,119
SESSION_ID	1,120
SESSION_SERIAL	1,121
SESSION_USER	1,122

SHARD_GROUP_ID	1,123
SHARD_GROUP_NAME	1,124
SHARD_ID	1,125
SHARD_NAME	1,126
SHIFT_LEFT	1,127
SHIFT_RIGHT	1,128
SIGN	1,129
SIN	1,130
SPLIT_PART	1,131
SQRT	1,132
STATEMENT_DATE	1,133
STATEMENT_LOCALTIME	1,134
STATEMENT_LOCALTIMESTAMP	1,135
STATEMENT_TIME	1,136
STATEMENT_TIMESTAMP	1,137
STATEMENT_VIEW_SCN	1,138
STATEMENT_VIEW_SCN_DCN	1,139
STATEMENT_VIEW_SCN_GCN	1,140
STATEMENT_VIEW_SCN_LCN	1,141
STDDEV	1,142
STDDEV_POP	1,144
STDDEV_SAMP	1,145
SUBSTR	1,146
SUBSTRB	1,147
SUBSTRING	1,148
SUM	1,150
SYSDATE	1,151
SYS_EXTRACT_UTC	1,152
SYSTIME	1,153
SYSTIMESTAMP	1,154
TAN	1,155
TO_BASE64	1,156
TO_CHAR(datetime)	1,157
TO_CHAR(number)	1,159
TO_DATE	1,160
TO_NATIVE_DOUBLE	1,161
TO_NATIVE_REAL	1,162
TO_NUMBER	1,163
TO_TIME	1,164

TO_TIME_TZ	1,165
TO_TIME_WITH_TIME_ZONE	1,166
TO_TIMESTAMP	1,168
TO_TIMESTAMP_TZ	1,170
TO_TIMESTAMP_WITH_TIME_ZONE	1,171
TRANSACTION_DATE	1,173
TRANSACTION_LOCALTIME	1,174
TRANSACTION_LOCALTIMESTAMP	1,175
TRANSACTION_TIME	1,176
TRANSACTION_TIMESTAMP	1,177
TRANSLATE	1,178
TRIM	1,180
TRUNC(number)	1,182
TRUNC(date)	1,183
UPPER	1,185
UNHEX	1,186
UNHEX_TO_CHARSTR	1,187
USER_ID	1,188
UUID	1,189
VAR_POP	1,190
VAR_SAMP	1,192
VARIANCE	1,194
VERSION	1,196
WIDTH_BUCKET	1,197
12. SQL Languages	1,199
12.1 Data Definition Language	1,200
DDL Related Statements	1,200
Concepts of DDL	1,200
DDL and Transaction	1,201
12.2 Data Manipulation Language	1,210
DML Related Statements	1,210
Concepts of DML	1,210
Inserting Data	1,211
Deleting Data	1,213
Updating Data	1,213
Manipulating Data Using Cursor	1,214
DML Query	1,215
12.3 Data Query Language	1,218
Query Related Statements	1,218

Concepts of Query	1,218
Basic Query	1,219
SET Operator	1,221
Join	1,222
Grouping Result Set (group by)	1,227
Sorting Result Set (order by)	1,229
Subquery	1,230
12.4 Control Language	1,232
Control Language Related Statements	1,232
Transaction Control	1,232
Session Control	1,235
System Control	1,236
12.5 Processing SQL in Cluster	1,237
Processing DDL in Cluster	1,237
Processing SELECT in Cluster	1,238
Processing DML in Cluster	1,272
13. SQL Objects	1,285
13.1 Database	1,286
Database-related Statements	1,286
Database Configuration Objects	1,287
Built-in Objects	1,290
13.2 Profile	1,293
Profile-related Statements	1,293
Concepts of Profile	1,293
13.3 Audit Policy	1,299
Audit Policy-related Statement	1,299
Examples	1,299
Concepts of Audit Policy	1,303
13.4 Authorization	1,327
Authorization-related Statements	1,327
Concepts of User	1,328
Creating Objects and Privileges	1,329
Privileges	1,332
13.5 Schema	1,338
Schema-related Statements	1,338
Concepts of Schema	1,338
User and Schema	1,339
Schema Path	1,341
PUBLIC Schema	1,344

User and Examples of Using Schema	1,346
13.6 Tablespace	1,349
Tablespace-related Statements	1,349
Concepts of Tablespace	1,349
13.7 Table	1,352
Table-related Statements	1,352
Concepts of Table	1,353
Global Temporary Table	1,355
Table in Cluster	1,357
13.8 Index	1,358
Index-related Statements	1,358
Concepts of Index	1,358
Concepts of UNIQUE	1,360
13.9 View	1,362
View-related Statements	1,362
Concepts of View	1,362
13.10 Sequence	1,365
Sequence-related Statements	1,365
Concepts of Sequence	1,365
Cluster Sequence	1,368
13.11 Synonym	1,369
Synonym-related Statements	1,369
Concepts of Synonym	1,369
13.12 Stored Procedure	1,372
Stored Procedure-related Statements	1,372
Concepts of Stored Procedure	1,372
13.13 Stored Function	1,374
Stored Function-related Statements	1,374
Concepts of Stored Function	1,374
14. Cluster Objects	1,377
14.1 Cluster System	1,378
Cluster System Related Statements	1,378
Concepts of Cluster System	1,378
Availability of Cluster System	1,381
Expanding Cluster System	1,382
14.2 Cluster Group	1,385
Cluster Group Related Statements	1,385
Concepts of Cluster Group	1,385
14.3 Cluster Member	1,387

Cluster Member Related Statements	1,387
Concepts of Cluster Member	1,387
14.4 Cluster Location	1,389
Cluster Location Related Statements	1,389
Concepts of Cluster Location	1,389
14.5 Cluster Table and Shard	1,390
Shard Related Statements	1,390
Cluster Table Type	1,390
Cloned Table	1,391
Hash-sharded table	1,393
Range-sharded Table	1,395
List-sharded Table	1,397
Rebalancing Cluster Table	1,399
14.6 Global Secondary Index	1,406
Global Secondary Index Related Statements	1,406
Concepts of Global Secondary Index	1,406
15. SQL Tuning	1,409
15.1 Overview	1,410
15.2 SQL Processing	1,411
SQL Parser	1,412
Plan Cache Check	1,412
SQL Validation	1,412
Optimization	1,413
Plan Generation	1,413
Plan Cache Registration	1,414
Execution	1,415
15.3 Query Optimizer	1,417
Overview	1,417
Query Transformations	1,418
Access Paths	1,424
Join	1,430
Cluster	1,447
Statistics Information	1,450
Adjusting Optimizer	1,450
15.4 SQL Execution Plan	1,451
Overview	1,451
Output	1,451
Reading	1,454
15.5 SQL Trace Log	1,490

Overview	1,490
Output	1,490
Output Format	1,491
Examples	1,493
16. SQL References	1,497
16.1 ALTER AUDIT POLICY	1,498
Function	1,498
Syntax	1,498
Invocation and Access Rules	1,498
Syntax Rules and Parameters	1,499
Description	1,499
Examples	1,500
Compatibility	1,500
For More Information	1,500
16.2 ALTER CLUSTER GROUP name ADD MEMBER	1,501
Function	1,501
Syntax	1,501
Invocation and Access Rules	1,501
Syntax Rules and Parameters	1,501
Description	1,502
Examples	1,502
Compatibility	1,503
For More Information	1,503
16.3 ALTER CLUSTER GROUP name OFFLINE MEMBER	1,504
Function	1,504
Syntax	1,504
Invocation and Access Rules	1,504
Syntax Rules and Parameters	1,504
Description	1,505
Examples	1,505
Compatibility	1,505
For More Information	1,506
16.4 ALTER CLUSTER LOCATION	1,507
Function	1,507
Syntax	1,507
Invocation and Access Rules	1,507
Syntax Rules and Parameters	1,507
Description	1,508
Examples	1,508

Compatibility	1,508
For More Information	1,508
16.5 ALTER DATABASE ADD LOGFILE	1,509
Function	1,509
Syntax	1,509
Invocation and Access Rules	1,509
Syntax Rules and Parameters	1,509
Description	1,510
Examples	1,511
Compatibility	1,511
For More Information	1,511
16.6 ALTER DATABASE ARCHIVELOG	1,512
Function	1,512
Syntax	1,512
Invocation and Access Rules	1,512
Syntax Rules and Parameters	1,512
Description	1,512
Example	1,513
Compatibility	1,513
For More Information	1,513
16.7 ALTER DATABASE BACKUP	1,514
Function	1,514
Syntax	1,514
Invocation and Access Rules	1,514
Syntax Rules and Parameters	1,515
Description	1,516
Examples	1,516
Compatibility	1,517
For More Information	1,517
16.8 ALTER DATABASE CLEAR AUDIT TRAIL	1,518
Function	1,518
Syntax	1,518
Invocation and Access Rules	1,518
Description	1,518
Storing Audit Trail	1,518
Examples	1,519
Compatibility	1,519
For More Information	1,519
16.9 ALTER DATABASE CLEAR PASSWORD HISTORY	1,520

Function	1,520
Syntax	1,520
Invocation and Access Rules	1,520
Description	1,520
Examples	1,521
Compatibility	1,521
For More Information	1,521
16.10 ALTER DATABASE DELETE BACKUP	1,522
Function	1,522
Syntax	1,522
Invocation and Access Rules	1,522
Syntax Rules and Parameters	1,522
Description	1,523
Example	1,523
Compatibility	1,523
For More Information	1,524
16.11 ALTER DATABASE DROP INACTIVE CLUSTER MEMBERS	1,525
Function	1,525
Syntax	1,525
Invocation and Access Rules	1,525
Description	1,525
Examples	1,526
Compatibility	1,526
For More Information	1,526
16.12 ALTER DATABASE DROP LOGFILE	1,527
Function	1,527
Syntax	1,527
Invocation and Access Rules	1,527
Syntax Rules and Parameters	1,527
Description	1,528
Examples	1,528
Compatibility	1,528
For More Information	1,529
16.13 ALTER DATABASE MOVE SHARD	1,530
Function	1,530
Syntax	1,530
Invocation and Access Rules	1,530
Syntax Rules and Parameters	1,530
Description	1,531

Examples	1,532
Compatibility	1,532
For More Information	1,532
16.14 ALTER DATABASE OFFLINE INACTIVE CLUSTER MEMBERS	1,533
Function	1,533
Syntax	1,533
Invocation and Access Rules	1,533
Syntax Rules and Parameters	1,533
Description	1,534
Examples	1,534
Compatibility	1,534
For More Information	1,534
16.15 ALTER DATABASE REBALANCE	1,535
Function	1,535
Syntax	1,535
Invocation and Access Rules	1,535
Syntax Rules and Parameters	1,535
Description	1,536
Examples	1,536
Compatibility	1,537
For More Information	1,537
16.16 ALTER DATABASE REBALANCE EXCLUDE CLUSTER GROUP	1,538
Function	1,538
Syntax	1,538
Invocation and Access Rules	1,538
Syntax Rules and Parameters	1,538
Description	1,539
Examples	1,539
Compatibility	1,540
For More Information	1,540
16.17 ALTER DATABASE RENAME LOGFILE	1,541
Function	1,541
Syntax	1,541
Invocation and Access Rules	1,541
Syntax Rules and Parameters	1,541
Description	1,542
Example	1,542
Compatibility	1,542
For More Information	1,542

16.18 ALTER DATABASE RECOVER	1,543
Function	1,543
Syntax	1,543
Invocation and Access Rules	1,544
Syntax Rules and Parameters	1,544
Description	1,546
Examples	1,546
Compatibility	1,547
For More Information	1,547
16.19 ALTER DATABASE REGISTER	1,548
Function	1,548
Syntax	1,548
Invocation and Access Rules	1,548
Syntax Rules and Parameters	1,548
Description	1,549
Example	1,549
Compatibility	1,549
For More Information	1,549
16.20 ALTER DATABASE RESET LOCAL CLUSTER MEMBER	1,550
Function	1,550
Syntax	1,550
Invocation and Access Rules	1,550
Description	1,550
Examples	1,551
Compatibility	1,551
For More Information	1,551
16.21 ALTER DATABASE RESTORE	1,552
Function	1,552
Syntax	1,552
Invocation and Access Rules	1,552
Syntax Rules and Parameters	1,552
Description	1,553
Examples	1,553
Compatibility	1,554
For More Information	1,554
16.22 ALTER INDEX	1,555
Function	1,555
Syntax	1,555
Invocation and Access Rules	1,555

Syntax Rules and Parameters	1,555
Description	1,556
Examples	1,556
Compatibility	1,556
16.23 ALTER INDEX name AGING	1,557
Function	1,557
Syntax	1,557
Invocation and Access Rules	1,557
Syntax Rules and Parameters	1,557
Description	1,557
Examples	1,558
Compatibility	1,558
For More Information	1,558
16.24 ALTER INDEX name STORAGE	1,559
Function	1,559
Syntax	1,559
Invocation and Access Rules	1,559
Syntax Rules and Parameters	1,560
Description	1,562
Examples	1,562
Compatibility	1,562
For More Information	1,562
16.25 ALTER INDEX name RENAME TO	1,563
Function	1,563
Syntax	1,563
Invocation and Access Rules	1,563
Syntax Rules and Parameters	1,563
Description	1,564
Examples	1,564
Compatibility	1,564
For More Information	1,564
16.26 ALTER PROFILE	1,565
Function	1,565
Syntax	1,565
Invocation and Access Rules	1,565
Syntax Rules and Parameters	1,566
Examples	1,567
Compatibility	1,568
For More Information	1,568

16.27 ALTER SEQUENCE	1,569
Function	1,569
Syntax	1,569
Invocation and Access Rules	1,570
Syntax Rules and Parameters	1,570
Description	1,572
Examples	1,573
Compatibility	1,573
For More Information	1,574
16.28 ALTER SESSION CLEANUP GLOBAL TEMPORARY SEGMENT POOL;	1,575
Function	1,575
Syntax	1,575
Description	1,575
Examples	1,575
Compatibility	1,575
For More Information	1,576
16.29 ALTER SESSION SET property_name	1,577
Function	1,577
Syntax	1,577
Syntax Rules and Parameters	1,577
Description	1,577
Examples	1,578
Compatibility	1,578
For More Information	1,578
16.30 ALTER SYSTEM CHECKPOINT	1,579
Function	1,579
Syntax	1,579
Invocation and Access Rules	1,579
Syntax Rules and Parameters	1,579
Description	1,580
Example	1,580
Compatibility	1,580
16.31 ALTER SYSTEM CLEANUP PLAN	1,581
Function	1,581
Syntax	1,581
Invocation and Access Rules	1,581
Syntax Rules and Parameters	1,581
Description	1,581
Examples	1,582

Compatibility	1,582
16.32 ALTER SYSTEM IRRECOVERABLE CLUSTER MEMBER	1,583
Function	1,583
Syntax	1,583
Invocation and Access Rules	1,583
Syntax Rules and Parameters	1,583
Description	1,584
Examples	1,584
Compatibility	1,584
16.33 ALTER SYSTEM JOIN DATABASE	1,585
Function	1,585
Syntax	1,585
Invocation and Access Rules	1,585
Description	1,585
Examples	1,586
Compatibility	1,586
For More Information	1,587
16.34 ALTER SYSTEM {MOUNT OPEN} DATABASE	1,588
Function	1,588
Syntax	1,588
Invocation and Access Rules	1,588
Syntax Rules and Parameters	1,588
Examples	1,589
Compatibility	1,589
For More Information	1,590
16.35 ALTER SYSTEM [KILL DISCONNECT] SESSION	1,591
Function	1,591
Syntax	1,591
Invocation and Access Rules	1,591
Syntax Rules and Parameters	1,591
Description	1,592
Example	1,592
Compatibility	1,593
16.36 ALTER SYSTEM RECONNECT GLOBAL CONNECTION	1,594
Function	1,594
Syntax	1,594
Invocation and Access Rules	1,594
Description	1,594
Examples	1,595

Compatibility	1,595
16.37 ALTER SYSTEM RESET property_name	1,596
Function	1,596
Syntax	1,596
Invocation and Access Rules	1,596
Syntax Rules and Parameters	1,596
Description	1,597
Examples	1,597
Compatibility	1,598
For More Information	1,598
16.38 ALTER SYSTEM SET property_name	1,599
Function	1,599
Syntax	1,599
Invocation and Access Rules	1,599
Syntax Rules and Parameters	1,599
Description	1,601
Examples	1,601
Compatibility	1,601
For More Information	1,602
16.39 ALTER SYSTEM SWITCH LOGFILE	1,603
Function	1,603
Syntax	1,603
Invocation and Access Rules	1,603
Syntax Rules and Parameters	1,603
Description	1,604
Example	1,604
Compatibility	1,604
For More Information	1,604
16.40 ALTER TABLE	1,605
Function	1,605
Syntax	1,605
Invocation and Access Rules	1,605
Syntax Rules and Parameters	1,606
Description	1,608
Example	1,608
Compatibility	1,608
16.41 ALTER TABLE name ADD COLUMN	1,610
Function	1,610
Syntax	1,610

Invocation and Access Rules	1,610
Syntax Rules and Parameters	1,611
Description	1,612
Examples	1,612
Compatibility	1,613
For More Information	1,613
16.42 ALTER TABLE name SET UNUSED COLUMN	1,614
Function	1,614
Syntax	1,614
Invocation and Access Rules	1,614
Syntax Rules and Parameters	1,614
Description	1,615
Example	1,615
Compatibility	1,616
For More Information	1,616
16.43 ALTER TABLE name ALTER COLUMN	1,617
Function	1,617
Syntax	1,617
Invocation and Access Rules	1,618
Syntax Rules and Parameters	1,618
Description	1,626
Examples	1,627
Compatibility	1,628
For More Information	1,628
16.44 ALTER TABLE name RENAME COLUMN	1,629
Function	1,629
Syntax	1,629
Invocation and Access Rules	1,629
Syntax Rules and Parameters	1,629
Description	1,630
Example	1,630
Compatibility	1,630
For More Information	1,630
16.45 ALTER TABLE name ADD CONSTRAINT	1,631
Function	1,631
Syntax	1,631
Invocation and Access Rules	1,631
Syntax Rules and Parameters	1,632
Description	1,632

Examples	1,632
Compatibility	1,633
For More Information	1,633
16.46 ALTER TABLE name DROP CONSTRAINT	1,634
Function	1,634
Syntax	1,634
Invocation and Access Rules	1,634
Syntax Rules and Parameters	1,635
Description	1,635
Examples	1,635
Compatibility	1,636
For More Information	1,636
16.47 ALTER TABLE name ALTER CONSTRAINT	1,637
Function	1,637
Syntax	1,637
Invocation and Access Rules	1,637
Syntax Rules and Parameters	1,638
Description	1,639
Example	1,639
Compatibility	1,639
16.48 ALTER TABLE name RENAME CONSTRAINT	1,640
Function	1,640
Syntax	1,640
Invocation and Access Rules	1,640
Syntax Rules and Parameters	1,640
Description	1,641
Examples	1,641
Compatibility	1,641
For More Information	1,642
16.49 ALTER TABLE name ADD GLOBAL SECONDARY INDEX	1,643
Function	1,643
Syntax	1,643
Invocation and Access Rules	1,644
Syntax Rules and Parameters	1,644
Description	1,647
Examples	1,647
Compatibility	1,648
For More Information	1,648
16.50 ALTER TABLE name DROP GLOBAL SECONDARY INDEX	1,649

Function	1,649
Syntax	1,649
Invocation and Access Rules	1,649
Syntax Rules and Parameters	1,649
Description	1,650
Examples	1,650
Compatibility	1,650
For More Information	1,650
16.51 ALTER TABLE name ALTER GLOBAL SECONDARY INDEX	1,651
Function	1,651
Syntax	1,651
Invocation and Access Rules	1,651
Syntax Rules and Parameters	1,652
Description	1,654
Examples	1,654
Compatibility	1,654
For More Information	1,655
16.52 ALTER TABLE name MOVE SHARD	1,656
Function	1,656
Syntax	1,656
Invocation and Access Rules	1,656
Syntax Rules and Parameters	1,656
Description	1,657
Examples	1,658
Compatibility	1,658
For More Information	1,658
16.53 ALTER TABLE name REBALANCE	1,659
Function	1,659
Syntax	1,659
Invocation and Access Rules	1,659
Syntax Rules and Parameters	1,659
Description	1,660
Examples	1,660
Compatibility	1,660
16.54 ALTER TABLE name REBALANCE EXCLUDE CLUSTER GROUP cluster_group_list	1,661
Function	1,661
Syntax	1,661
Invocation and Access Rules	1,661
Syntax Rules and Parameters	1,661

Description	1,662
Examples	1,662
Compatibility	1,663
16.55 ALTER TABLE name SPLIT SHARD	1,664
Function	1,664
Syntax	1,664
Invocation and Access Rules	1,664
Syntax Rules and Parameters	1,665
Description	1,666
Examples	1,667
Compatibility	1,667
For More Information	1,667
16.56 ALTER TABLE name RENAME SHARD	1,668
Function	1,668
Syntax	1,668
Invocation and Access Rules	1,668
Syntax Rules and Parameters	1,668
Description	1,669
Examples	1,669
Compatibility	1,669
For More Information	1,670
16.57 ALTER TABLE name READ { ONLY WRITE }	1,671
Function	1,671
Syntax	1,671
Invocation and Access Rules	1,671
Syntax Rules and Parameters	1,671
Description	1,672
Examples	1,672
Compatibility	1,673
For More Information	1,673
16.58 ALTER TABLE name RENAME TO	1,674
Function	1,674
Syntax	1,674
Invocation and Access Rules	1,674
Syntax Rules and Parameters	1,674
Description	1,675
Example	1,675
Compatibility	1,675
For More Information	1,675

16.59 ALTER TABLE name STORAGE	1,676
Function	1,676
Syntax	1,676
Invocation and Access Rules	1,676
Syntax Rules and Parameters	1,677
Description	1,677
Example	1,677
Compatibility	1,678
For More Information	1,678
16.60 ALTER TABLE name ADD SUPPLEMENTAL LOG	1,679
Function	1,679
Syntax	1,679
Invocation and Access Rules	1,679
Syntax Rules and Parameters	1,679
Description	1,680
Example	1,680
Compatibility	1,680
For More Information	1,680
16.61 ALTER TABLE name DROP SUPPLEMENTAL LOG	1,681
Function	1,681
Syntax	1,681
Invocation and Access Rules	1,681
Syntax Rules and Parameters	1,681
Description	1,682
Example	1,682
Compatibility	1,682
16.62 ALTER TABLESPACE	1,683
Function	1,683
Syntax	1,683
Invocation and Access Rules	1,683
Syntax Rules and Parameters	1,683
Description	1,684
Example	1,684
Compatibility	1,684
For More Information	1,685
16.63 ALTER TABLESPACE name RENAME TO	1,686
Function	1,686
Syntax	1,686
Invocation and Access Rules	1,686

Syntax Rules and Parameters	1,686
Description	1,687
Example	1,687
Compatibility	1,687
For More Information	1,687
16.64 ALTER TABLESPACE name BACKUP	1,688
Function	1,688
Syntax	1,688
Invocation and Access Rules	1,688
Syntax Rules and Parameters	1,688
Description	1,690
Examples	1,690
Compatibility	1,690
For More Information	1,690
16.65 ALTER TABLESPACE name [ONLINE OFFLINE]	1,691
Function	1,691
Syntax	1,691
Invocation and Access Rules	1,691
Syntax Rules and Parameters	1,691
Description	1,692
Examples	1,692
Compatibility	1,693
For More Information	1,693
16.66 ALTER TABLESPACE name ADD [DATAFILE MEMORY]	1,694
Function	1,694
Syntax	1,694
Invocation and Access Rules	1,694
Syntax Rules and Parameters	1,694
Description	1,696
Example	1,696
Compatibility	1,696
For More Information	1,696
16.67 ALTER TABLESPACE name DROP [DATAFILE MEMORY]	1,697
Function	1,697
Syntax	1,697
Invocation and Access Rules	1,697
Syntax Rules and Parameters	1,697
Description	1,698
Example	1,698

Compatibility	1,698
For More Information	1,698
16.68 ALTER TABLESPACE name RENAME DATAFILE	1,699
Function	1,699
Syntax	1,699
Invocation and Access Rules	1,699
Syntax Rules and Parameters	1,699
Description	1,700
Example	1,700
Compatibility	1,700
For More Information	1,700
16.69 ALTER USER	1,701
Function	1,701
Syntax	1,701
Invocation and Access Rules	1,702
Syntax Rules and Parameters	1,702
Description	1,705
Examples	1,705
Compatibility	1,706
For More Information	1,707
16.70 ALTER VIEW	1,708
Function	1,708
Syntax	1,708
Invocation and Access Rules	1,708
Syntax Rules and Parameters	1,708
Description	1,709
Example	1,709
Compatibility	1,710
For More Information	1,710
16.71 ANALYZE SYSTEM	1,711
Function	1,711
Syntax	1,711
Invocation and Access Rules	1,711
Syntax Rules and Parameters	1,711
Description	1,712
Examples	1,712
Compatibility	1,712
For More Information	1,713
16.72 ANALYZE TABLE	1,714

Function	1,714
Syntax	1,714
Invocation and Access Rules	1,714
Syntax Rules and Parameters	1,715
Description	1,718
Examples	1,718
Compatibility	1,720
For More Information	1,720
16.73 AUDIT POLICY	1,721
Function	1,721
Syntax	1,721
Invocation and Access Rules	1,721
Syntax Rules and Parameters	1,721
Description	1,722
Examples	1,725
Compatibility	1,726
For More Information	1,726
16.74 CLOSE cursor_name	1,727
Function	1,727
Syntax	1,727
Syntax Rules and Parameters	1,727
Description	1,727
Example	1,727
Compatibility	1,728
For More Information	1,728
16.75 COMMENT ON name IS	1,729
Function	1,729
Syntax	1,729
Invocation and Access Rules	1,729
Syntax Rules and Parameters	1,731
Description	1,732
Examples	1,733
Compatibility	1,734
16.76 COMMIT	1,735
Function	1,735
Syntax	1,735
Syntax Rules and Parameters	1,735
Description	1,736
Example	1,737

Compatibility	1,737
For More Information	1,737
16.77 CREATE AUDIT POLICY	1,738
Function	1,738
Syntax	1,738
Invocation and Access Rules	1,738
Syntax Rules and Parameters	1,739
Description	1,741
Examples	1,743
Compatibility	1,744
For More Information	1,744
16.78 CREATE CLUSTER GROUP	1,745
Function	1,745
Syntax	1,745
Invocation and Access Rules	1,745
Syntax Rules and Parameters	1,745
Description	1,746
Examples	1,747
Compatibility	1,747
For More Information	1,747
16.79 CREATE CLUSTER LOCATION	1,748
Function	1,748
Syntax	1,748
Invocation and Access Rules	1,748
Syntax Rules and Parameters	1,748
Description	1,749
Examples	1,749
Compatibility	1,749
For More Information	1,749
16.80 CREATE INDEX	1,750
Function	1,750
Syntax	1,750
Invocation and Access Rules	1,751
Syntax Rules and Parameters	1,751
Description	1,755
Examples	1,756
Compatibility	1,757
For more information	1,757
16.81 CREATE PROFILE	1,758

Function	1,758
Syntax	1,758
Invocation and Access Rules	1,758
Syntax Rules and Parameters	1,759
Description	1,763
Examples	1,767
Compatibility	1,768
For More Information	1,768
16.82 CREATE SCHEMA	1,769
Function	1,769
Syntax	1,769
Invocation and Access Rules	1,769
Syntax Rules and Parameters	1,770
Description	1,771
Examples	1,772
Compatibility	1,772
For More Information	1,773
16.83 CREATE SEQUENCE	1,774
Function	1,774
Syntax	1,774
Invocation and Access Rules	1,775
Syntax Rules and Parameters	1,775
Description	1,778
Examples	1,778
Compatibility	1,779
For More Information	1,779
16.84 CREATE SYNONYM	1,780
Function	1,780
Syntax	1,780
Invocation and Access Rules	1,780
Syntax Rules and Parameters	1,781
Description	1,782
Examples	1,782
Compatibility	1,783
For More Information	1,783
16.85 CREATE TABLE	1,784
Function	1,784
Syntax	1,784
Invocation and Access Rules	1,789

Syntax Rules and Parameters	1,790
Description	1,810
Examples	1,811
Compatibility	1,817
For More Information	1,818
16.86 CREATE TABLE AS SELECT	1,819
Function	1,819
Syntax	1,819
Invocation and Access Rules	1,821
Syntax Rules and Parameters	1,821
Description	1,822
Examples	1,822
Compatibility	1,824
For More Information	1,825
16.87 CREATE GLOBAL TEMPORARY TABLE	1,826
Function	1,826
Syntax	1,826
Invocation and Access Rules	1,826
Syntax Rules and Parameters	1,827
Description	1,827
Examples	1,828
Compatibility	1,829
For More Information	1,830
16.88 CREATE TABLESPACE	1,831
Function	1,831
Syntax	1,831
Invocation and Access Rules	1,831
Syntax Rules and Parameters	1,831
Description	1,832
Example	1,832
Compatibility	1,832
For More Information	1,832
16.89 CREATE MEMORY DATA TABLESPACE	1,833
Function	1,833
Syntax	1,833
Invocation and Access Rules	1,833
Syntax Rules and Parameters	1,834
Description	1,835
Examples	1,836

Compatibility	1,836
For More Information	1,836
16.90 CREATE MEMORY TEMPORARY TABLESPACE	1,837
Function	1,837
Syntax	1,837
Invocation and Access Rules	1,837
Syntax Rules and Parameters	1,838
Description	1,839
Examples	1,839
Compatibility	1,839
For More Information	1,840
16.91 CREATE USER	1,841
Function	1,841
Syntax	1,841
Invocation and Access Rules	1,841
Syntax Rules and Parameters	1,842
Description	1,844
Examples	1,845
Compatibility	1,846
For More Information	1,847
16.92 CREATE VIEW	1,848
Function	1,848
Syntax	1,848
Invocation and Access Rules	1,848
Syntax Rules and Parameters	1,849
Description	1,850
Examples	1,851
Compatibility	1,852
For More Information	1,852
16.93 DECLARE cursor_name	1,853
Function	1,853
Syntax	1,853
Invocation and Access Rules	1,854
Syntax Rules and Parameters	1,854
Description	1,858
Examples	1,860
Compatibility	1,864
For More Information	1,864
16.94 DELETE FROM	1,866

Function	1,866
Syntax	1,866
Invocation and Access Rules	1,866
Syntax Rules and Parameters	1,867
Description	1,868
Examples	1,868
Compatibility	1,869
For More Information	1,869
16.95 DELETE FROM name RETURNING	1,870
Function	1,870
Syntax	1,870
Invocation and Access Rules	1,870
Syntax Rules and Parameters	1,871
Description	1,872
Examples	1,872
Compatibility	1,873
For More Information	1,873
16.96 DELETE FROM name RETURNING .. INTO	1,874
Function	1,874
Syntax	1,874
Invocation and Access Rules	1,874
Syntax Rules and Parameters	1,875
Description	1,876
Example	1,876
Compatibility	1,876
For More Information	1,877
16.97 DELETE FROM name WHERE CURRENT OF cursor_name	1,878
Function	1,878
Syntax	1,878
Invocation and Access Rules	1,878
Syntax Rules and Parameters	1,878
Description	1,879
Example	1,879
Compatibility	1,880
For More Information	1,880
16.98 DROP AUDIT POLICY	1,882
Function	1,882
Syntax	1,882
Invocation and Access Rules	1,882

Syntax Rules and Parameters	1,882
Description	1,882
Examples	1,883
Compatibility	1,883
For More Information	1,883
16.99 DROP CLUSTER GROUP	1,884
Function	1,884
Syntax	1,884
Invocation and Access Rules	1,884
Syntax Rules and Parameters	1,884
Description	1,884
Examples	1,885
Compatibility	1,885
For More Information	1,885
16.100 DROP CLUSTER LOCATION	1,886
Function	1,886
Syntax	1,886
Invocation and Access Rules	1,886
Syntax Rules and Parameters	1,886
Description	1,886
Example	1,887
Compatibility	1,887
For More Information	1,887
16.101 DROP INDEX	1,888
Function	1,888
Syntax	1,888
Invocation and Access Rules	1,888
Syntax Rules and Parameters	1,888
Description	1,889
Examples	1,889
Compatibility	1,889
For More Information	1,889
16.102 DROP PROFILE	1,890
Function	1,890
Syntax	1,890
Invocation and Access Rules	1,890
Syntax Rules and Parameters	1,890
Example	1,891
Compatibility	1,891

For More Information	1,891
16.103 DROP SCHEMA	1,892
Function	1,892
Syntax	1,892
Invocation and Access Rules	1,892
Syntax Rules and Parameters	1,892
Description	1,893
Examples	1,893
Compatibility	1,893
For More Information	1,894
16.104 DROP SEQUENCE	1,895
Function	1,895
Syntax	1,895
Invocation and Access Rules	1,895
Syntax Rules and Parameters	1,895
Description	1,896
Examples	1,896
Compatibility	1,896
For More Information	1,896
16.105 DROP SYNONYM	1,898
Function	1,898
Syntax	1,898
Invocation and Access Rules	1,898
Syntax Rules and Parameters	1,898
Description	1,899
Examples	1,899
Compatibility	1,899
For More Information	1,900
16.106 DROP TABLE	1,901
Function	1,901
Syntax	1,901
Invocation and Access Rules	1,901
Syntax Rules and Parameters	1,901
Description	1,902
Examples	1,902
Compatibility	1,903
For More Information	1,904
16.107 DROP TABLESPACE	1,905
Function	1,905

Syntax	1,905
Invocation and Access Rules	1,905
Syntax Rules and Parameters	1,905
Description	1,907
Examples	1,907
Compatibility	1,907
For More Information	1,907
16.108 DROP USER	1,908
Function	1,908
Syntax	1,908
Invocation and Access Rules	1,908
Syntax Rules and Parameters	1,908
Description	1,910
Examples	1,910
Compatibility	1,910
For More Information	1,911
16.109 DROP VIEW	1,912
Function	1,912
Syntax	1,912
Invocation and Access Rules	1,912
Syntax Rules and Parameters	1,912
Description	1,913
Examples	1,913
Compatibility	1,913
For More Information	1,913
16.110 EXECUTE statement_name	1,914
Function	1,914
Syntax	1,914
Invocation and Access Rules	1,914
Syntax Rules and Parameters	1,914
Description	1,917
Example	1,917
Compatibility	1,917
For More Information	1,918
16.111 EXECUTE IMMEDIATE 'sql_string'	1,919
Function	1,919
Syntax	1,919
Invocation and Access Rules	1,919
Syntax Rules and Parameters	1,919

Description	1,920
Example	1,920
Compatibility	1,921
For More Information	1,921
16.112 FETCH cursor_name	1,922
Function	1,922
Syntax	1,922
Syntax Rules and Parameters	1,922
Description	1,924
Example	1,924
Compatibility	1,927
For More Information	1,927
16.113 GRANT privileges TO	1,928
Function	1,928
Syntax	1,928
Syntax Rules and Parameters	1,931
Description	1,937
Examples	1,937
Compatibility	1,939
For More Information	1,939
16.114 INSERT INTO	1,940
Function	1,940
Syntax	1,940
Invocation and Access Rules	1,940
Syntax Rules and Parameters	1,941
Description	1,942
Examples	1,942
Compatibility	1,944
For More Information	1,944
16.115 INSERT INTO name RETURNING	1,945
Function	1,945
Syntax	1,945
Invocation and Access Rules	1,945
Syntax Rules and Parameters	1,946
Description	1,947
Examples	1,947
Compatibility	1,948
For More Information	1,948
16.116 INSERT INTO name RETURNING .. INTO	1,949

Function	1,949
Syntax	1,949
Invocation and Access Rules	1,949
Syntax Rules and Parameters	1,950
Description	1,951
Example	1,951
Compatibility	1,952
For More Information	1,952
16.117 LOCK TABLE	1,953
Function	1,953
Syntax	1,953
Invocation and Access Rules	1,953
Syntax Rules and Parameters	1,954
Description	1,955
Examples	1,955
Compatibility	1,955
For More Information	1,956
16.118 NOAUDIT POLICY	1,957
Function	1,957
Syntax	1,957
Invocation and Access Rules	1,957
Syntax Rules and Parameters	1,957
Description	1,958
Examples	1,961
Compatibility	1,961
For More Information	1,961
16.119 OPEN cursor_name	1,963
Function	1,963
Syntax	1,963
Invocation and Access Rules	1,963
Syntax Rules and Parameters	1,963
Description	1,964
Examples	1,965
Compatibility	1,966
For More Information	1,966
16.120 PREPARE statement_name	1,967
Function	1,967
Syntax	1,967
Invocation and Access Rules	1,967

Syntax Rules and Parameters	1,967
Description	1,970
Example	1,970
Compatibility	1,971
For More Information	1,971
16.121 RELEASE SAVEPOINT savepoint_specifier	1,972
Function	1,972
Syntax	1,972
Syntax Rules and Parameters	1,972
Description	1,972
Example	1,972
Compatibility	1,973
For More Information	1,973
16.122 REVOKE privileges FROM	1,974
Function	1,974
Syntax	1,974
Syntax Rules and Parameters	1,974
Description	1,975
Examples	1,976
Compatibility	1,977
For More Information	1,977
16.123 ROLLBACK	1,978
Function	1,978
Syntax	1,978
Syntax Rules and Parameters	1,978
Description	1,979
Examples	1,979
Compatibility	1,980
For More Information	1,981
16.124 SAVEPOINT savepoint_specifier	1,982
Function	1,982
Syntax	1,982
Syntax Rules and Parameters	1,982
Description	1,982
Example	1,983
Compatibility	1,984
For More Information	1,984
16.125 SELECT	1,985
query expression	1,985

query specification	1,989
select list	1,994
from clause	1,997
joined table	2,004
where clause	2,010
group by clause	2,012
having clause	2,015
order by clause	2,017
offset limit clause	2,021
set operator	2,026
subquery	2,032
hint clause	2,036
16.126 SELECT .. FOR UPDATE	2,068
Function	2,068
Syntax	2,068
Invocation and Access Rules	2,068
Syntax Rules and Parameters	2,069
Description	2,070
Examples	2,071
Compatibility	2,072
16.127 SELECT .. INTO	2,073
Function	2,073
Syntax	2,073
Invocation and Access Rules	2,073
Syntax Rules and Parameters	2,073
Description	2,074
Example	2,075
16.128 SELECT .. INTO .. FOR UPDATE	2,076
Function	2,076
Syntax	2,076
Invocation and Access Rules	2,076
Syntax Rules and Parameters	2,077
Description	2,079
Examples	2,080
For More Information	2,081
16.129 SET CONSTRAINTS	2,082
Function	2,082
Syntax	2,082
Invocation and Access Rules	2,082

Syntax Rules and Parameters	2,082
Description	2,083
Examples	2,090
Compatibility	2,090
For More Information	2,090
16.130 SET SESSION AUTHORIZATION user_identifier	2,091
Function	2,091
Syntax	2,091
Invocation and Access Rules	2,091
Syntax Rules and Parameters	2,092
Description	2,092
Example	2,092
Compatibility	2,092
16.131 SET SESSION CHARACTERISTICS AS transaction_mode	2,093
Function	2,093
Syntax	2,093
Syntax Rules and Parameters	2,093
Description	2,094
Examples	2,094
Compatibility	2,094
For More Information	2,094
16.132 SET TIME ZONE	2,095
Function	2,095
Syntax	2,095
Syntax Rules and Parameters	2,095
Description	2,095
Example	2,096
Compatibility	2,096
16.133 SET TRANSACTION transaction_mode	2,097
Function	2,097
Syntax	2,097
Syntax Rules and Parameters	2,097
Description	2,098
Example	2,098
Compatibility	2,098
For More Information	2,098
16.134 TRUNCATE TABLE	2,099
Function	2,099
Syntax	2,099

Invocation and Access Rules	2,099
Syntax Rules and Parameters	2,099
Description	2,100
Examples	2,100
Compatibility	2,101
16.135 UPDATE	2,102
Function	2,102
Syntax	2,102
Invocation and Access Rules	2,102
Syntax Rules and Parameters	2,103
Description	2,104
Examples	2,105
Compatibility	2,106
16.136 UPDATE name RETURNING	2,107
Function	2,107
Syntax	2,107
Invocation and Access Rules	2,108
Syntax Rules and Parameters	2,108
Description	2,109
Examples	2,110
Compatibility	2,110
16.137 UPDATE name RETURNING .. INTO	2,111
Function	2,111
Syntax	2,111
Invocation and Access Rules	2,112
Syntax Rules and Parameters	2,112
Description	2,113
Example	2,113
Compatibility	2,114
16.138 UPDATE name WHERE CURRENT OF cursor_name	2,115
Function	2,115
Syntax	2,115
Invocation and Access Rules	2,115
Syntax Rules and Parameters	2,115
Description	2,116
Examples	2,116
Compatibility	2,118
For More Information	2,118

11.

SQL Elements

11.1 Syntax Elements

Identifiers

Identifier is divided into an ordinary identifier and a delimited identifier.

An ordinary identifier consists of a letter or letters and numbers and it is used by internally substituting all characters to uppercase letters. Therefore, an ordinary identifier is not case-sensitive.

The following is an example of an ordinary identifier.

```
GOLDILOCKS  
GoldiLocks
```

A delimited identifier consists of a letter or letters and numbers and they are enclosed with double quotes ("). All the characters are used as internally described. Therefore, a delimited identifier is case-sensitive.

The following is an example of a delimited identifier.

```
"GOLDILOCKS"  
"GoldiLocks"
```

Literals

Literals mean representation of non-null value.

Text Literals

Text literals mean representation of strings and binary strings.

Use single quote (') at the beginning and end of a string to write string of text literals.

Not only the double quotes (") string but also all strings except for the single quote (') string can be written within a single quote (').

Use a single quote twice without white spaces in between to write a single quote (') in a string.

A maximum of 4000 characters can be written in a string.

The followings are examples of text literals for a string.

```
'GOLDILOCKS'  
'Sunje' 's DBMS'
```

A binary string of text literals is a string of hexadecimal numbers which starts with x'(X') and ends with '. Only the characters corresponding to 0 ~ 9, A (a) ~ F (f) can be written in each position of a hexadecimal string. The length of a hexadecimal string should always be an even number because its two digits mean one byte. A maximum of 4,000 characters can be written in a binary string.

The followings are examples of text literals for a binary string.

```
x'001f'  
X'FF0A'  
x'aF37BBc013'
```

Numeric Literals

Numeric literals mean literals of numeric type, and integers or the number with decimal point can be written. The syntax for numeric literals is as follows.

```
[ + | - ] <digits> [ . <digits> ] [ E | e [ + | - ] <digits> ] [ f | F | d | D ]
```

- The first +/- means a positive or negative value of the entire number, and it can be omitted. If omitted, the default value is a positive value.
- In <digits>, numbers from 0 to 9 can be listed without white space, the number with decimal point can be written by using decimal point (.).
- An exponent form can be written after the first <digits>, and E or e is written, and it stands for exponent. Then +/- is written according to exponent sign, and <digits> is written. +/- of exponent can be omitted. If omitted, the default value is a positive value.
- Lastly, character such as f, F, d, D can be written after numbers. It means that it is a number of BINARY_FLOAT, BINARY_DOUBLE. If the corresponding character is omitted, the number is considered as NUMBER type.

The followings are examples of numeric literals.

```
20  
+123.45  
0.03  
+1.23E-02  
-1.5  
10f  
+123.45F  
1.2E-3F  
-22d
```

123.45D

-1.23E+05D

Datetime Literals

Datetime literals are representation of date/time type.

Datetime value is specified using string literal, or by converting character or numeric value to datetime value using TO_*function (TO_DATE, etc).

Datetime data types are DATE, TIME, TIME WITH TIME ZONE, TIMESTAMP, TIMESTAMP WITH TIME ZONE.

Date Literals

Date literals are written in a form of DATE'string literal' or TO_DATE(string_literal [, format]).

- DATE'string literal'
 - The format of date type is ' SYYYY-MM-DD'.
 - DATE'2002-07-15'
- TO_DATE(string_literal [, format])
 - If the format is not specified, the format of date type is NLS_DATE_FORMAT by default.
 - If the format is specified, the specified format is applied.
- The date type includes year, month, day, hour, minute, second (except for fractional seconds).
- If the date is omitted, the default value is the first day of the current month.
- If the hour, minute, second are omitted, the default value is midnight.
 - HH24 format: '00:00:00'
 - HH12 format: '12:00:00'
- To set the hour, minute, second to the default value (midnight) when the date value includes hour, minute, second, then use the TRUNC(date) function.
- For example, in TRUNC(SYSDATE), SYSDATE includes the values of the year, month, day, hour, minute, second.
- To compare only the values of the year, month, day among date values, then set the values of the hour, minute, second are set to midnight using the TRUNC function.

For more information, refer to **TO_DATE**, **Datetime Format String**, **NLS_DATE_FORMAT**.

- The following is an example of date literals.

```
DATE'2002-07-15'
```

- The following is an example of when the format is not specified, so NLS_DATE_FORMAT is 'YYYY-MM-DD'.

```
TO_DATE( '2002-07-15' )
```

- The followings are examples of when the format is specified.

```
TO_DATE( '15-JUL-02', 'DD-MON-RR' )
TO_DATE( '2002-07-15 00:00:00', 'YYYY-MM-DD HH24:MI:SS' )
TO_DATE( '2002-07-15 13:25:30', 'YYYY-MM-DD HH24:MI:SS' )
```

- The following is an example of when the date is omitted. (It is set to the first day of the current month).

```
gSQL> SELECT TO_DATE( '2000-07', 'YYYY-MM' ) FROM DUAL;
TO_DATE( '2000-07', 'YYYY-MM' )
-----
2000-07-01
```

- The following is an example of when the hour, minute, second are omitted. (It is set to the midnight).

```
gSQL> SELECT
      TO_CHAR( DATE'2002-07-15', 'YYYY-MM-DD HH24:MI:SS' ) AS RESULT
      FROM DUAL;
RESULT
-----
2002-07-15 00:00:00
```

- The following is an example of setting the hour, minute, second of DATE value (SYSDATE) to the default value (midnight).

```
gSQL> SELECT
      TO_CHAR( SYSDATE,
              'YYYY-MM-DD HH24:MI:SS' ) AS RESULT_SYSDATE,
      TO_CHAR( TRUNC( SYSDATE ),
              'YYYY-MM-DD HH24:MI:SS' ) AS RESULT_TRUNC_SYSDATE
      FROM DUAL;
RESULT_SYSDATE      RESULT_TRUNC_SYSDATE
-----
2014-08-19 10:06:49 2014-08-19 00:00:00
```

- The following is an example of comparing only the values of the year, month, day among date values.

```
gSQL> SELECT
      TO_DATE( '2002-08-12' ) =
```

```

TRUNC( TO_DATE( '2002-08-12 23:59:59', 'YYYY-MM-DD HH24:MI:SS' ) )
AS RESULT FROM DUAL;

RESULT
-----
TRUE

```

Time Literals

Time literals are written in a form of `TIME'string literal'` or `TO_TIME(string_literal [, format])`.

- `TIME'string literal'`
 - The format of time type is `'HH24:MI:SS[.FF6]'`.
 - `TIME'15:30:59.999999'`
- `TO_TIME(string_literal [, format])`
 - If the format is not specified, the format of time type is `NLS_TIME_FORMAT` by default.
 - If the format is specified, the specified format is applied.

The time type includes hour, minute, second (fractional seconds).

Fractional seconds can be specified to maximum six digits numbers format.

For more information, refer to [TO_TIME](#), [Datetime Format String](#), [NLS_TIME_FORMAT](#).

- The following is an example of time literals.

```
TIME'15:30:59.999999'
```

- The following is an example of when the format is not specified, so `NLS_TIME_FORMAT` is `'HH24:MI:SS.FF6'`.

```
TO_TIME( '15:30:59.999999' )
```

- The following is an example of when the format is specified.

```
TO_TIME( '09.45.03.546873 AM', 'HH12.MI.SS.FF6 AM' )
TO_TIME( '09:45:03', 'HH12:MI:SS' )
```

Time with Time Zone Literals

Time with time zone literals is written in a form of `TIME'string literal'`, `TIME WITH TIME ZONE'string literal'`, `TO_TIME_WITH_TIME_ZONE(string_literal [, format])`, or `TO_TIME_TZ(string_literal [, format])`.

- `TIME'string literal'` or `TIME WITH TIME ZONE'string literal'`
 - The format of time with time zone type is `'HH24:MI:SS[.FF6] TZh:TzM'`.

- `TIME'15:30:59.999999 +09:00'`
- `TIME WITH TIME ZONE'15:30:59.999999 +09:00'`
- `TO_TIME_WITH_TIME_ZONE(string_literal [, format])`
 - If the format is not specified, the format of time with time zone type is `NLS_TIME_WITH_TIME_ZONE_FORMAT` by default.
 - If the format is specified, the specified format is applied.

Time with time zone type includes hour, minute, second (fractional seconds), and time zone offset (time zone hour, time zone minute).

Fractional seconds can be specified to maximum six digits numbers format.

For more information, refer to `TO_TIME_WITH_TIME_ZONE`, `Datetime Format String`, `NLS_TIME_WITH_TIME_ZONE_FORMAT`.

- The followings are examples of time with time zone literals.

```
TIME'15:30:59.999999 +09:00'
TIME WITH TIME ZONE'15:30:59.999999 +09:00'
```

- The following is an example of when the format is not specified, so `NLS_TIME_WITH_TIME_ZONE_FORMAT` is `'HH24:MI:SS.FF6 TZH:TZM'`.

```
TO_TIME_WITH_TIME_ZONE( '15:30:59.999999 +09:00' )
TO_TIME_TZ( '15:30:59.999999 +09:00' )
```

- The following is an example of when the format is specified.

```
TO_TIME_WITH_TIME_ZONE( '09.45.03.546873 +09:00 AM',
                        'HH12.MI.SS.FF6 TZH:TZM AM' )
```

Timestamp Literals

Timestamp literals are written in a form of `TIMESTAMP'string literal'` or `TO_TIMESTAMP(string_literal [, format])`.

- `TIMESTAMP'string literal'`
 - The format of timestamp type is `'YYYY-MM-DD HH24:MI:SS[. [FF6]]'`.
 - `TIMESTAMP'2002-07-15 15:39:59.999999'`
- `TO_TIMESTAMP(string_literal [, format])`
 - If the format is not specified, the format of timestamp type is `NLS_TIMESTAMP_FORMAT` by default.
 - If the format is specified, the specified format is applied.

Timestamp type includes year, month, day, hour, minute, second (fractional seconds).

Fractional seconds can be specified to maximum six digits numbers format.

For more information, refer to **TO_TIMESTAMP**, **Datetime Format String**, **NLS_TIMESTAMP_FORMAT**.

- The following is an example of timestamp literals.

```
TIMESTAMP '2002-07-15 15:39:59.999999'
```

- The following is an example of when the format is not specified, so **NLS_TIMESTAMP_FORMAT** is 'YYYY-MM-DD HH24:MI:SS.FF6'.

```
TO_TIMESTAMP( '2002-07-15 15:39:59.999999' )
```

- The following is an example of when the format is specified.

```
TO_TIMESTAMP( '15-JUL-02 11.06.30.123456 AM',
              'DD-MON-RR HH12.MI.SS.FF6 AM' )
```

Timestamp with Time Zone Literals

Timestamp with time zone literals is written in a form of **TIMESTAMP**'string literal', **TIMESTAMP WITH TIME_ZONE**'string literal', **TO_TIMESTAMP_WITH_TIME_ZONE**(string_literal [, format]), or **TO_TIMESTAMP_TZ**(string_literal [, format]).

- **TIMESTAMP**'string literal' or **TIMESTAMP WITH TIME_ZONE**'string literal'
 - The format of timestamp with time zone type is 'SYYYY-MM-DD HH24:MI:SS[.FF6] TZH:TZM'.
 - **TIMESTAMP**'2002-07-15 15:39:59.999999 +09:00'
 - **TIMESTAMP WITH TIME_ZONE**'2002-07-15 15:39:59.999999 +09:00'
- **TO_TIMESTAMP_WITH_TIME_ZONE**(string_literal [, format])
 - If the format is not specified, the format of timestamp with time zone type is **NLS_TIMESTAMP_WITH_TIME_ZONE_FORMAT** by default.
 - If the format is specified, the specified format is applied.

Timestamp with time zone type includes year, month, day, hour, minute, second (fractional seconds), time zone offset (time zone hour, time zone minute).

Fractional seconds can be specified to maximum six digits numbers format.

For more information, refer to **TO_TIMESTAMP_WITH_TIME_ZONE**, **Datetime Format String** , **NLS_TIMESTAMP_WITH_TIME_ZONE_FORMAT**.

- The following is an example of timestamp with time zone literals.

```
TIMESTAMP'2002-07-15 15:39:59.999999 +09:00'
TIMESTAMP WITH TIME ZONE'2002-07-15 15:39:59.999999 +09:00'
```

- The following is an example of when the format is not specified, so NLS_TIMESTAMP_WITH_TIME_ZONE_FORMAT is 'YYYY-MM-DD HH24:MI:SS.FF6 TZH:TZM'.

```
TO_TIMESTAMP_WITH_TIME_ZONE( '2002-07-15 15:39:59.999999 +09:00' )
TO_TIMESTAMP_TZ( '2002-07-15 15:39:59.999999 +09:00' )
```

- The following is an example of when the format is specified.

```
TO_TIMESTAMP_WITH_TIME_ZONE( '15-JUL-02 11.06.30.123456 +09:00 AM',
                              'DD-MON-RR HH12.MI.SS.FF6 TZH:TZM AM' )
TO_TIMESTAMP_TZ( '15-JUL-02 11.06.30.123456 +09:00 AM',
                 'DD-MON-RR HH12.MI.SS.FF6 TZH:TZM AM' )
```

Interval Literals

The interval literals specify the time interval.

Intervals are classified and expressed as follows.

- Year-month INTERVAL values
 - It includes YEAR and MONTH.
 - Display string expression: 'year-month'
- Day-time INTERVAL values
 - It includes DAY, HOUR, MINUTE, SECOND (fractional seconds).
 - Display string expression: 'day hour:minute:second.fractional_seconds'
- The interval value's sign is specified only once at the beginning of the string representation.
 - e.g. INTERVAL'+3 11:22:33.999999'DAY TO SECOND (O)
 - INTERVAL'-3 +11:22:33.999999'DAY TO SECOND (X)

The followings are the list of interval types.

- INTERVAL YEAR (leading precision)
- INTERVAL MONTH (leading precision)
- INTERVAL YEAR (leading precision) TO MONTH
- INTERVAL DAY (leading precision)
- INTERVAL HOUR (leading precision)
- INTERVAL MINUTE (leading precision)
- INTERVAL SECOND (leading precision[, fractional seconds precision])
- INTERVAL DAY (leading precision) TO HOUR

- INTERVAL DAY (leading precision) TO MINUTE
- INTERVAL DAY (leading precision) TO SECOND (fractional seconds precision)
- INTERVAL HOUR (leading precision) TO MINUTE
- INTERVAL HOUR (leading precision) TO SECOND (fractional seconds precision)
- INTERVAL MINUTE (leading precision) TO SECOND (fractional seconds precision)

Leading precision

- It is the digit number of the field, it can be specified from 2 to 6. If it is not specified, the default value is set to 2.
- If the leading field value exceeds the leading precision, then an error is returned.

Fractional seconds precision

- It is the digit number of fractional seconds, and it can be specified from 0 to 6. If it is not specified, the default value is set to 6.
- If the fractional second field value exceeds the fractional seconds precision, then it is rounded off.

For more information, refer to **INTERVAL, Precisions and value range of the second or later field in INTERVAL * TO ***.

Examples of Using Interval Literals.

The followings are examples of using interval literals.

Interval YEAR

The followings are examples of using interval YEAR literals.

Example	Description	Display string
INTERVAL'1'YEAR INTERVAL'01-00'YEAR	1 year	+01-00
INTERVAL'100'YEAR	It exceeds the leading precision 2, so it returns the error.	-
INTERVAL'100'YEAR(3)	100 year	+100-00
INTERVAL'+999999'YEAR(6)	999999 year	+999999-00
INTERVAL'-999999'YEAR(6)	-(999999 year)	-999999-00

Interval MONTH

The followings are examples of using interval MONTH literals.

Example	Description	Display string
INTERVAL'1'MONTH INTERVAL'00-01'MONTH	1 month	+00-01
INTERVAL'100'MONTH	It exceeds the leading precision 2, so it returns the error.	-

Example	Description	Display string
INTERVAL'100'MONTH(3)	8 year 4 month	+008-04
INTERVAL'+999999'MONTH(6)	83333 year 3 month	+083333-03
INTERVAL'-999999'MONTH(6)	-(83333 year 3 month)	-083333-03

Interval YEAR TO MONTH

The followings are examples of using interval YEAR TO MONTH literals.

Example	Description	Display string
INTERVAL'1-06'YEAR TO MONTH	1 year 6 month	+01-06
INTERVAL'1-12'YEAR TO MONTH	The month value exceeded 11, so it returns the error.	-
INTERVAL'100-11'YEAR TO MONTH	It exceeds the leading precision 2, so it returns the error.	-
INTERVAL'100-11'YEAR(3) TO MONTH	100 year 11 month	+100-11
INTERVAL'+999999-11'YEAR(6) TO MONTH	999999 year 11 month	+999999-11
INTERVAL'-999999-11'YEAR(6) TO MONTH	-(999999 year 11 month)	-999999-11

Interval DAY

The followings are examples of using interval DAY literals.

Example	Description	Display string
INTERVAL'1'DAY INTERVAL'01 00:00:00'DAY	1 day	+01 00:00:00
INTERVAL'100'DAY	It exceeds the leading precision 2, so it returns the error.	-
INTERVAL'100'DAY(3)	100 day	+100 00:00:00
INTERVAL'+999999'DAY(6)	999999 day	+999999 00:00:00
INTERVAL'-999999'DAY(6)	-(999999 day)	-999999 00:00:00

Interval HOUR

The followings are examples of using interval HOUR literals.

Example	Description	Display string
INTERVAL'1'HOUR INTERVAL'00 01:00:00'HOUR	1 hour	+00 01:00:00
INTERVAL'1000'HOUR(3)	It exceeds the leading precision 3, so it returns the error	-
INTERVAL'1000'HOUR(4)	41 day 16 hour	+0041 16:00:00
INTERVAL'+999999'HOUR(6)	41666 day 15 hour	+041666 15:00:00
INTERVAL'-999999'HOUR(6)	-(41666 day 15 hour)	-041666 15:00:00

Interval MINUTE

The following are examples of using interval MINUTE literals.

Example	Description	Display string
INTERVAL'1'MINUTE INTERVAL'00 00:01:00'MINUTE	1 minute	+00 00:01:00
INTERVAL'12345'MINUTE(4)	It exceeds the leading precision 4, so it returns the error	-
INTERVAL'12345'MINUTE(5)	8 day 13 hour 45 minute	+00008 13:45:00
INTERVAL'+999999'MINUTE(6)	694 day 10 hour 39 minute	+000694 10:39:00
INTERVAL'-999999'MINUTE(6)	-(694 day 10 hour 39 minute)	-000694 10:39:00

Interval SECOND

The followings are examples of using interval SECOND literals.

Example	Description	Display string
INTERVAL'1'SECOND INTERVAL'00 00:00:01.000000'SECOND	1 second	+00 00:00:01.000000
INTERVAL'100'SECOND	It exceeds the leading precision 2, so it returns the error.	-
INTERVAL'99.999999'SECOND INTERVAL'99.999999'SECOND(2,6)	The fractional seconds are rounded off to become 100 second, then it exceeds the leading precision 2, so it returns the error.	-
INTERVAL'99.999999'SECOND(3)	1 minute 40 second	+000 00:01:40.000000
INTERVAL'29.506167'SECOND(2, 2)	29.51 second	+00 00:00:29.51
INTERVAL'999999.999999'SECOND(6,6)	11day 13 hour 46 minute 39.999999 second	+000011 13:46:39.999999
INTERVAL'-999999.999999'SECOND(6,6)	-(11day 13 hour 46 minute 39.999999 second)	-000011 13:46:39.999999

Interval DAY TO HOUR

The followings are examples of using interval DAY TO HOUR literals.

Example	Description	Display string
INTERVAL'1 23'DAY TO HOUR INTERVAL'01 23:00:00'DAY TO HOUR	1 day 23 hour	+01 23:00:00
INTERVAL'1 24'DAY TO HOUR	The hour value exceeds 23 (invalid), so it returns the error.	-
INTERVAL'100 23'DAY TO HOUR	It exceeds the leading precision 2, so it returns the error.	-
INTERVAL'100 23'DAY(3) TO HOUR	100 day 23 hour	+100 23:00:00

Example	Description	Display string
INTERVAL'+999999 23'DAY(6) TO HOUR	999999 day 23 hour	+999999 23:00:00
INTERVAL'-999999 23'DAY(6) TO HOUR	-(999999 day 23 hour)	-999999 23:00:00
INTERVAL'-999999 +23'DAY(6) TO HOUR	Invalid sign error	-

Interval DAY TO MINUTE

The followings are examples of using interval DAY TO MINUTE literals.

Example	Description	Display string
INTERVAL'1 23:59'DAY TO MINUTE INTERVAL'01 23:59:00'DAY TO MINUTE	1 day 23 hour 59 second	+01 23:59:00
INTERVAL'1 24:59'DAY TO MINUTE	The hour value exceeds 23 (invalid), so it returns the error.	-
INTERVAL'1 23:60'DAY TO MINUTE	The minute value exceeds 59 (invalid), so it returns the error.	-
INTERVAL'100 23:59'DAY TO MINUTE	It exceeds the leading precision 2, so it returns the error.	-
INTERVAL'100 23:59'DAY(3) TO MINUTE	100 day 23 hour 59 minute	+100 23:59:00
INTERVAL'+999999 23:59'DAY(6) TO MINUTE	999999 day 23 hour 59 minute	+999999 23:59:00
INTERVAL'-999999 23:59'DAY(6) TO MINUTE	-(999999 day 23 hour 59 minute)	-999999 23:59:00

Interval DAY TO SECOND

The followings are examples of using interval DAY TO SECOND literals.

Example	Description	display string
INTERVAL '1 23:59:59.999999'DAY TO SECOND	1 day 23 hour 59 minute 59.999999 second	+01 23:59:59.999999
INTERVAL '1 24:59:59.999999'DAY TO SECOND	The hour value exceeds 23, so it returns the error.	-
INTERVAL '1 23:60:59.999999'DAY TO SECOND	The minute value exceeds 59, so it returns the error.	-
INTERVAL '1 23:59:60.999999'DAY TO SECOND	The second value exceeds 60, so it returns the error.	-
INTERVAL '99 23:59:59.999999'DAY TO SECOND	The fractional seconds are rounded off to become 100 day, then it exceeds the leading precision 2, so it returns the error.	-

Example	Description	display string
INTERVAL '99 23:59:59.9999999'DAY(3) TO SECOND	100 day	+100 00:00:00.000000
INTERVAL '1 11:22:33.567890'DAY(2) TO SECOND(2)	1 day 11 hour 22 minute 33.57 second	+01 11:22:33.57
INTERVAL '+999999 23:59:59.999999'DAY(6) TO SECOND(6)	999999 day 23 hour 59 minute 59.999999 hour	+999999 23:59:59.999999
INTERVAL '-999999 23:59:59.999999'DAY(6) TO SECOND(6)	-(999999 day 23 hour 59 minute 59.999999 hour)	-999999 23:59:59.999999

Interval HOUR TO MINUTE

The followings are examples of using interval HOUR TO MINUTE literals.

Example	Description	Display string
INTERVAL '23:59'HOUR TO MINUTE INTERVAL '00 23:59:00'HOUR TO MINUTE	23 hour 59 minute	+00 23:59:00
INTERVAL '23:60'HOUR TO MINUTE	The minute value exceeds 59, so it returns the error.	-
INTERVAL '100:59'HOUR TO MINUTE	It exceeds the leading precision 2, so it returns the error.	-
INTERVAL '100:59'HOUR(3) TO MINUTE	4 day 4 hour 59 minute	+004 04:59:00
INTERVAL '+999999:59'HOUR(6) TO MINUTE	41666 day 15 hour 59 minute	+041666 15:59:00
INTERVAL '-999999:59'HOUR(6) TO MINUTE	-(41666 day 15 hour 59 minute)	-041666 15:59:00

Interval HOUR TO SECOND

The followings are examples of using interval HOUR TO SECOND literals.

Example	Description	Display string
INTERVAL '23:59:59.999999'HOUR TO SECOND INTERVAL '00 23:59:59.999999'HOUR TO SECOND	23 hour 59 minute 59.999999 second	+00 23:59:59.999999
INTERVAL '23:60:59.999999'HOUR TO SECOND	The minute value exceeds 59, so it returns the error.	-
INTERVAL '23:59:60.999999'HOUR TO SECOND	The second value exceeds 59, so it returns the error.	-
INTERVAL '99:59:59.999999'HOUR TO SECOND	The fractional seconds are rounded off to become 100 hour, then it exceeds the leading precision 2, so it returns the error.	-

Example	Description	Display string
INTERVAL '99:59:59.9999999'HOUR(3) TO SECOND	4 day 4 hour	+004 04:00:00.000000
INTERVAL '11:22:29.569'HOUR(3) TO SECOND(1)	11 hour 22 minute 29.6 second	+000 11:22:29.6
INTERVAL '+9999999:59:59.999999'HOUR(6) TO SECOND(6)	41666 day 15 hour 59 minute 59.999999 second	+041666 15:59:59.999999
INTERVAL '-9999999:59:59.999999'HOUR(6) TO SECOND(6)	-(41666 day 15 hour 59 minute 59.999999 second)	-041666 15:59:59.999999

Interval MINUTE TO SECOND

The followings are examples of using interval MINUTE TO SECOND literals.

Example	Description	Display string
INTERVAL '15:23.123456'MINUTE TO SECOND INTERVAL '00 00:15:23.123456'MINUTE TO SECOND	15 minute 23.123456 second	+00 00:15:23.123456
INTERVAL '15:60.123456'MINUTE TO SECOND	The second value exceeds 59, so it returns the error.	-
INTERVAL '99:59.999999'MINUTE TO SECOND(2)	The fractional seconds are rounded off to become 100 minute, then it exceeds the leading precision 2, so it returns the error.	-
INTERVAL '99:59.999999'MINUTE(3) TO SECOND(2)	1 hour 40 minute	+000 01:40:00.00
INTERVAL '+9999999:59.999999'MINUTE(6) TO SECOND(6)	694 day 10 hour 39 minute 59.999999 second	+000694 10:39:59.999999
INTERVAL '-9999999:59.999999'MINUTE(6) TO SECOND(6)	-(694 day 10 hour 39 minute 59.999999 second)	-000694 10:39:59.999999

Null Value

Null value is an unknown value or an undefined value. NULL value can be a value of any data type. The unknown value of the boolean type is represented as null value.

Null value is defined as a keyword and it is not case-sensitive.

The following is an example of null value representation.

NULL

Null

Comments

Single Line Comment

A single line comment is a comment which starts with `--` or `//`. The single line comment processes a comment from the behind of the comment's symbol to the end of the line.

The following is an example of using a single line comment.

```
gSQL> SELECT I1, -- I2, I3,
2 I4, I5
3 FROM T1;
I1      I4      I5
-----
column i1 column i4 column i5
1 row selected.
gSQL> SELECT I1, // I2, I3,
2 I4, I5
3 FROM T1;
I1      I4      I5
-----
column i1 column i4 column i5
1 row selected.
```

Multiple Line Comment

A multiple line comment is a comment which starts with `/*` and ends with `*/`. Multiple line comments specify a comment from `/*` to `*/`, and it can use multiple lines to represent comments.

The following is an example of using multiple line comment.

```
gSQL> SELECT I1, I2, I3, I4, I5
2 /* Output
3 all columns of TABLE T1 */
4 FROM T1;
I1      I2      I3      I4      I5
-----
column i1 column i2 column i3 column i4 column i5
```

1 row selected.

Hint Comment

A hint comment is a comment which starts with `/*+` and ends with `*/`. Hint comment is similar to multiple line comment, but the difference is that the hint comment has `+` at the beginning.

Do not use a space between `*` and `+`. If so, it will be treated as multiple line comment.

Unlike other comments, a hint comment is specified to be used only at the location which is right after the `SELECT` keyword. The processing method which a user specified to GOLDILOCKS optimizer is described in the hint comment. For more information, refer to **hint clause**.

The following is an example of using hint comment.

```
gSQL> SELECT /*+ FULL(T1) */ * FROM T1;
I1          I2          I3          I4          I5
-----
column i1 column i2 column i3 column i4 column i5
1 row selected.
```

SQL Reserved Words and Keywords

SQL Reserved Words

GOLDILOCKS supports reserved words which are specified as SQL reserved words. The SQL reserved word can not be used without quotation marks other than specified location. However, it is not recommended to use SQL reserved words with quotation marks.

The followings are SQL reserved words of GOLDILOCKS. * marked SQL reserved words are supported by the SQL standard.

For more information about the list, refer to **V\$RESERVED_WORDS**.

```
ABSOLUTE
ACCESS
ALL *
ALLOCATE *
ALTER *
AND *
ANY *
ARE *
AS *
```

ASYMMETRIC *
AT *
AUTHORIZATION *
BEGIN *
BETWEEN *
BOTH *
BY *
CALL *
CASE *
CHECK *
CLOSE *
COLUMN *
COMMENT
COMMIT *
CONNECT *
CONSTRAINT *
CREATE *
CROSS *
CURRENT *
CURRENT_CATALOG *
CURRENT_DATE *
CURRENT_DEFAULT_TRANSFORM_GROUP *
CURRENT_PATH *
CURRENT_ROLE *
CURRENT_ROW *
CURRENT_SCHEMA *
CURRENT_TIME *
CURRENT_TIMESTAMP *
CURRENT_TRANSFORM_GROUP_FOR_TYPE *
CURRENT_USER *
DATABASE
DEALLOCATE *
DECLARE *
DEFAULT *
DELETE *
DEREF *
DESCRIBE *
DETERMINISTIC *
DISCONNECT *
DISTINCT *
DROP *

ELSE *
END *
END_EXEC *
ESCAPE *
EXCEPT *
EXEC *
EXECUTE *
EXISTS *
FALSE *
FETCH *
FILTER *
FIRST
FOR *
FOREIGN *
FREE *
FROM *
FULL *
FUNCTION *
GET *
GLOBAL *
GRANT *
GROUP *
HAVING *
HOLD *
IDENTIFIED
IF
IMMEDIATE
IN *
INDICATOR *
INNER *
INOUT *
INSERT *
INTERSECT *
INTO *
IS *
JOIN *
LAST
LEADING *
LEFT *
LIKE *
LIMIT

LOCAL *
LOCALTIME *
LOCALTIMESTAMP *
MATCH *
MEMBER *
MERGE *
MINUS
NATURAL *
NEW *
NEXT
NOT *
NULL *
OF *
OFFSET *
OLD *
ON *
OPEN *
OR *
ORDER *
OUT *
PREPARE *
PRIMARY *
PRIOR
PROCEDURE *
PROFILE
REF *
REFERENCES *
RELATIVE
RELEASE *
RENAME
RETURN *
RETURNING
RETURNS *
REVOKE *
RIGHT *
ROLLBACK *
ROW *
ROWID
ROWS *
ROW_NUMBER *
SAVEPOINT *

SELECT *
SESSION_USER *
SET *
SOME *
SQL *
SQLEXCEPTION *
SQLSTATE *
SQLWARNING *
START *
SYMMETRIC *
SYNONYM
SYSDATE
SYSTEM *
SYSTEM_USER *
SYSTIME
SYSTIMESTAMP
TABLE *
THEN *
TO *
TRAILING *
TRIGGER *
TRUE *
TRUNCATE *
UNION *
UNIQUE *
UNKNOWN *
UPDATE *
UPPER *
USER *
USING *
VALUES *
VIEW
WHEN *
WHENEVER *
WHERE *
WINDOW *
WITH *
WITHOUT *

SQL Keywords

GOLDILOCKS SQL keywords are not reserved words. However, they are keywords which are internally used by GOLDILOCKS. Therefore, it is not recommended to use GOLDILOCKS SQL keywords because it can decrease the readability of the results.

GOLDILOCKS SQL keywords list can be viewed through `V$KEYWORDS`.

Compatibility for Syntax Elements

The SQL standard compatibility for syntax element is as follows.

Table 11-1 SQL standard compatibility for syntax element

Feature ID	Description	Availability
E021-03	Character literals	O
E131	Null value support (nulls in lieu of values)	O
E161	SQL comments using leading double minus	O
F051-01	DATE data type (including support of DATE literal)	O
F051-02	TIME data type (including support of TIME literal) with fractional seconds precision of at least 0	O
F051-03	TIMESTAMP data type (including support of TIMESTAMP literal) with fractional seconds precision of at least 0 and 6	O
F271	Compound character literals	X
F383	Set column not null clause	O
F391	Long identifiers	X
F392	Unicode escapes in identifiers	X
F393	Unicode escapes in literals	X
T023	Compound binary literals	X
T024	Spaces in binary literals	X
T101	Enhanced nullability determination	X
T351	Bracketed comments	X
T591	UNIQUE constraints of possibly null columns	O
X041	Basic table mapping: null absent	X
X042	Basic table mapping: null as nil	X
X051	Advanced table mapping: null absent	X
X052	Advanced table mapping: null as nil	X
X170	XML null handling options	X
X400	Name and identifier mapping	X

11.2 Data Type

Numeric Type

Numeric data types are classified according to the storage method and the fractional part representation.

- Classification by the storage method
 - Decimal numeric type
 - It stores decimal numbers in 100 digits basis.
 - Types: NUMBER, NUMERIC, FLOAT
 - Binary numeric type
 - It stores numbers of C language as it is.
 - Types: NATIVE_INTEGER, NATIVE_DOUBLE
- Classification by fractional part representation
 - Fixed point data type (exact numeric)
 - It is a numeric type whose scale is fixed.
 - Types: NUMERIC(precision, scale), NATIVE_INTEGER
 - Floating point data type (approximate numeric)
 - It is a numeric type whose scale is not fixed.
 - Types: FLOAT(precision), NATIVE_DOUBLE

Decimal Numeric Type

This type's precision and scale are based on decimal number. The precision indicates accuracy of the valid digits, and the scale indicates the range of fraction.

Decimal Fixed Point Number Type

The decimal fixed point number type is defined in SQL.

Table 11-2 Decimal fixed point number type

Type	Decimal precision	Decimal scale	Refer to
NUMBER(p)	p	0	NUMBER
NUMBER(p, s)	p	s	NUMBER
NUMERIC(p)	p	0	NUMERIC
NUMERIC(p, s)	p	s	NUMERIC
DECIMAL(p)	p	0	NUMERIC type alias
DECIMAL(p, s)	p	s	NUMERIC type alias

Type	Decimal precision	Decimal scale	Refer to
DEC(p)	p	0	NUMERIC type alias
DEC(p, s)	p	s	NUMERIC type alias
SMALLINT	5	0	NUMERIC type alias
INTEGER	10	0	NUMERIC type alias
BIGINT	19	0	NUMERIC type alias
INT2	5	0	NUMERIC type alias
INT4	10	0	NUMERIC type alias
INT8	19	0	NUMERIC type alias

Decimal Floating Point Number Type

The decimal floating point number type is defined in SQL.

Table 11-3 Decimal floating point number type

Type	Decimal precision	Decimal scale	Refer to
NUMBER	38	N/A	NUMBER
FLOAT(p)	$\text{ceil}(\log_{10} 2^p)$	N/A	FLOAT
REAL	$\text{ceil}(\log_{10} 2^{24}) = 8$	N/A	FLOAT type alias
DOUBLE	$\text{ceil}(\log_{10} 2^{53}) = 16$	N/A	FLOAT type alias
FLOAT4	$\text{ceil}(\log_{10} 2^{24}) = 8$	N/A	FLOAT type alias
FLOAT8	$\text{ceil}(\log_{10} 2^{53}) = 16$	N/A	FLOAT type alias

Binary Number Type

This type's precision and scale are based on binary number. The precision indicates accuracy of the valid digits, and the scale indicates the range of fraction.

Binary Fixed Point Number Type

The binary fixed point number type refers to the signed integer data type of C language.

1 bit is used to represent the sign bit, and other bits are used to represent the precision, but not any bit is used to represent the scale.

Table 11-4 Binary fixed point number type

Type	Binary precision	Binary scale	Refer to
NATIVE_SMALLINT	15	0	NATIVE_SMALLINT
NATIVE_INTEGER	31	0	NATIVE_INTEGER
NATIVE_BIGINT	63	0	NATIVE_BIGINT

Binary Floating Point Number Type

The binary floating point type refers to the float and double data type in C language.

1 bit is used to represent the sign bit, and other bits are used to represent the precision and scale.

Table 11-5 Binary floating point number type

Type	Binary precision	Binary scale	Refer to
NATIVE_REAL	23	8	NATIVE_REAL
NATIVE_DOUBLE	52	11	NATIVE_DOUBLE



The precision and scale of binary floating point type is subject to change depending on the influence of the compiler and OS.

CHARACTER STRING Type

CHARACTER STRING data types are classified according to whether it is a variable length string and the maximum length of string.

- Classification by whether a variable length string exists
 - Fixed length string
 - Refer to **CHARACTER**.
 - Variable length string
 - Refer to **CHARACTER VARYING**, **CHARACTER LONG VARYING**.
- Classification by the maximum length of a string
 - 2000 [characters or bytes]
 - Refer to **CHARACTER**.
 - 4000 [characters or bytes]
 - Refer to **CHARACTER VARYING**.
 - 100 megabytes
 - Refer to **CHARACTER LONG VARYING**.

BINARY STRING Type

BINARY STRING data types are classified according to whether it is a variable length binary string and the maximum length of binary string.

- Classification by whether it is a variable length binary string

- Fixed length binary string
 - Refer to **BINARY**.
- Variable length binary string
 - Refer to **BINARY VARYING**, **BINARY LONG VARYING**.
- Classification by the maximum length of binary string
 - 2000
 - Refer to **BINARY**.
 - 4000
 - Refer to **BINARY VARYING**.
 - 100 Mega Bytes
 - Refer to **BINARY LONG VARYING**.

Date/ Time Type

Date/ time data type specifies the year, month, day, hour, minute, second, time zone offset in accordance with their representation method.

Date/ time data type has **DATE**, **TIME**, **TIMESTAMP** types.

INTERVAL Type

INTERVAL data type specifies the time interval.

It specifies the time interval of the year, month, day, hour, minute, second in accordance with their representation method.

INTERVAL data types are classified to the YEAR TO MONTH family type and the DAY TO SECOND family type, according to the range of value representation.

BOOLEAN Type

The **BOOLEAN** data type stores values of **TRUE**, **FALSE**, **UNKNOWN**. **UNKNOWN** value is represented as a null value. All expressions used as condition returns the **BOOLEAN** value and the column or the value defined as a **BOOLEAN** data type can be used as a condition.

For more information, refer to **BOOLEAN**.

ROWID Type

All the records stored in the database has a unique location information. The record identifier (ROWID) is used to distinguish each record.

ROWID data type is used to store and manage the record identifier (ROWID).

Record identifier (ROWID) is obtained by the query using the ROWID pseudo column.

For more information, refer to **ROWID**.

Type Comparison

Comparing two types is executed on the basis of one representative type. If the comparison target type is different from the representative type, then the comparison can go through a type conversion.

The representative types for type comparison defines the representative type for comparing two types.

The following table describes target type conversion for comparison per each representative type.

- Type conversion for the VC comparison
- Type conversion for the LC comparison
- Type conversion for the VB comparison
- Type conversion for the LB comparison
- Type conversion for the NB comparison
- Type conversion for the ND comparison
- Type conversion for the NU comparison
- Type conversion for the DA comparison
- Type conversion for the TI comparison
- Type conversion for the TZ comparison
- Type conversion for the TS comparison
- Type conversion for the SZ comparison
- Type conversion for the YM comparison
- Type conversion for the DS comparison
- Type conversion for the BO comparison
- Type conversion for the RI comparison



The followings are abbreviations which are used for the type comparison.

- "VC": CHARACTER VARYING
- "LC": CHARACTER LONG VARYING

- "VB": BINARY VARYING
- "LB": BINARY LONG VARYING
- "NB": NATIVE_BIGINT
- "ND": NATIVE_DOUBLE
- "NU": NUMBER
- "DA": DATE
- "TI": TIME
- "TZ": TIME WITH TIMEZONE
- "TS": TIMESTAMP
- "SZ": TIMESTAMP WITH TIMEZONE
- "YM": INTERVAL YEAR TO MONTH
- "DS": INTERVAL DAY TO SECOND
- "B0": BOOLEAN
- "RI": ROWID



In the type comparison table, the built-in data types are represented by an abbreviated word enclosed in double quotes ("").

- "CHAR": CHARACTER
- "VARCHAR": CHARACTER VARYING
- "LONG VARCHAR": CHARACTER LONG VARYING
- "VARBINARY": BINARY VARYING
- "LONG VARBINARY": BINARY LONG VARYING
- "TIME_TZ": TIME WITH TIMEZONE
- "TIMESTAMP_TZ": TIMESTAMP WITH TIMEZONE
- "INTERVAL_YM": INTERVAL YEAR TO MONTH
- "INTERVAL_DS": INTERVAL DAY TO SECOND

Table 11-6 The representative types for type comparison

Data type	C H A R	V A R C H A R	L O N G V A R C H A R	B I N A R Y	V A R B I N A R Y	L O N G V A R B I N A R Y	N A T I V E	N A T I V E	N A T I V E	N A T I V E	N A T I V E	N U M B E R	N U M B E R	F L O A T	D A T E	T I M E	T I M E	T I M E	T I M E	I N T E R V A L	I N T E R V A L	B O L E A N	R O W I D
CHAR	VC	VC	LC				NU	NU	NU	NU	ND	NU	NU	NU	DA	TI	TZ	TS	SZ	YM	DS	BO	RI
VARCHAR	VC	VC	LC				NU	NU	NU	NU	ND	NU	NU	NU	DA	TI	TZ	TS	SZ	YM	DS	BO	RI
LONG VARCHAR	LC	LC	LC				NU	NU	NU	NU	ND	NU	NU	NU	DA	TI	TZ	TS	SZ	YM	DS	BO	RI
BINARY				VB	VB	LB																	
VARIABLE				VB	VB	LB																	
LONG VARIABLE				LB	LB	LB																	
NATIVE_SMALLINT	NU	NU	NU				NB	NB	NB	ND	ND	NU	NU	NU						YM	DS		
NATIVE_INTEGER	NU	NU	NU				NB	NB	NB	ND	ND	NU	NU	NU						YM	DS		
NATIVE_BIGINT	NU	NU	NU				NB	NB	NB	ND	ND	NU	NU	NU						YM	DS		
NATIVE_REAL	NU	NU	NU				ND	ND	ND	ND	ND	NU	NU	NU									
NATIVE_DOUBLE	ND	ND	ND				ND	ND	ND	ND	ND	ND	ND	ND									
NUMB																				YM	DS		

Data type	CHAR	VARCHAR	LONG VARCHAR	BINARY	VARBINARY	LONG VARCHAR	NUMERIC	NUMERIC	NUMERIC	NUMERIC	NUMERIC	NUMERIC	NUMERIC	NUMERIC	DATE	TIME	TIME	TIME	TIME	INTERVAL	INTERVAL	BOOLEAN	ROWID
ER	NU	NU	NU				NU	NU	NU	NU	ND	NU	NU	NU									
NUMERIC	NU	NU	NU				NU	NU	NU	NU	ND	NU	NU	NU						YM	DS		
FLOAT	NU	NU	NU				NU	NU	NU	NU	ND	NU	NU	NU						YM	DS		
DATE	DA	DA	DA												DA			TS	SZ				
TIME	TI	TI	TI													TI	TZ						
TIME_TZ	TZ	TZ	TZ													TZ	TZ						
TIMES TAMP	TS	TS	TS												TS			TS	SZ				
TIMES TAMP _TZ	SZ	SZ	SZ												SZ			SZ	SZ				
INTER VAL_Y M	YM	YM	YM				YM	YM	YM			YM	YM	YM						YM			
INTER VAL_D S	DS	DS	DS				DS	DS	DS			DS	DS	DS							DS		
BOOLE AN	B0	B0	B0																			B0	
ROWI D	RI	RI	RI																				RI

Table 11-7 Type conversion for the VC comparison

Source type	Converted type
CHAR	CHAR (no conversion)
VARCHAR	VARCHAR (no conversion)

Table 11-8 Type conversion for the LC comparison

Source type	Converted type
CHAR	CHAR (no conversion)
VARCHAR	VARCHAR (no conversion)
LONG VARCHAR	LONG VARCHAR (no conversion)

Table 11-9 Type conversion for the VB comparison

Source type	Converted type
BINARY	BINARY (no conversion)
VARBINARY	VARBINARY (no conversion)

Table 11-10 Type conversion for the LB comparison

Source type	Converted type
BINARY	BINARY (no conversion)
VARBINARY	VARBINARY (no conversion)
LONG VARBINARY	LONG VARBINARY (no conversion)

Table 11-11 Type conversion for the NB comparison

Source type	Converted type
CHAR	NATIVE_BIGINT
VARCHAR	NATIVE_BIGINT
LONG VARCHAR	NATIVE_BIGINT
NATIVE_SMALLINT	NATIVE_SMALLINT (no conversion)
NATIVE_INTEGER	NATIVE_INTEGER (no conversion)
NATIVE_BIGINT	NATIVE_BIGINT (no conversion)

Table 11-12 Type conversion for the ND comparison

Source type	Converted type
CHAR	NATIVE_DOUBLE
VARCHAR	NATIVE_DOUBLE
LONG VARCHAR	NATIVE_DOUBLE
NATIVE_SMALLINT	NATIVE_SMALLINT (no conversion)
NATIVE_INTEGER	NATIVE_INTEGER (no conversion)
NATIVE_BIGINT	NATIVE_BIGINT (no conversion)
NATIVE_REAL	NATIVE_REAL (no conversion)
NATIVE_DOUBLE	NATIVE_DOUBLE (no conversion)
NUMBER	NUMBER (no conversion)
NUMERIC	NUMERIC (no conversion)
FLOAT	FLOAT (no conversion)

Table 11-13 Type conversion for the NU comparison

Source type	Converted type
CHAR	NUMBER
VARCHAR	NUMBER
LONG VARCHAR	NUMBER
NATIVE_SMALLINT	NATIVE_SMALLINT (no conversion)
NATIVE_INTEGER	NATIVE_INTEGER (no conversion)
NATIVE_BIGINT	NATIVE_BIGINT (no conversion)
NATIVE_REAL	NATIVE_REAL (no conversion)
NATIVE_DOUBLE	NATIVE_DOUBLE (no conversion)
NUMBER	NUMBER (no conversion)
NUMERIC	NUMERIC (no conversion)
FLOAT	FLOAT (no conversion)

Table 11-14 Type conversion for the DA comparison

Source type	Converted type
CHAR	DATE
VARCHAR	DATE
LONG VARCHAR	DATE
DATE	DATE (no conversion)

Table 11-15 Type conversion for the TI comparison

Source type	Converted type
CHAR	TIME
VARCHAR	TIME
LONG VARCHAR	TIME
TIME	TIME (no conversion)

Table 11-16 Type conversion for the TZ comparison

Source type	Converted type
CHAR	TIME_TZ
VARCHAR	TIME_TZ
LONG VARCHAR	TIME_TZ
TIME	TIME_TZ
TIME_TZ	TIME_TZ (no conversion)

Table 11-17 Type conversion for the TS comparison

Source type	Converted type
CHAR	TIMESTAMP
VARCHAR	TIMESTAMP

Source type	Converted type
LONG VARCHAR	TIMESTAMP
DATE	DATE (no conversion)
TIMESTAMP	TIMESTAMP (no conversion)

Table 11-18 Type conversion for the SZ comparison

Source type	Converted type
CHAR	TIMESTAMP_TZ
VARCHAR	TIMESTAMP_TZ
LONG VARCHAR	TIMESTAMP_TZ
DATE	TIMESTAMP_TZ
TIMESTAMP	TIMESTAMP_TZ
TIMESTAMP_TZ	TIMESTAMP_TZ (no conversion)

Table 11-19 Type conversion for the YM comparison

Source type	Converted type
CHAR	INTERVAL_YM
VARCHAR	INTERVAL_YM
LONG VARCHAR	INTERVAL_YM
NATIVE_SMALLINT	INTERVAL_YM
NATIVE_INTEGER	INTERVAL_YM
NATIVE_BIGINT	INTERVAL_YM
NUMBER	INTERVAL_YM
NUMERIC	INTERVAL_YM
FLOAT	INTERVAL_YM
INTERVAL_YM	INTERVAL_YM (no conversion)

Table 11-20 Type conversion for the DS comparison

Source type	Converted type
CHAR	INTERVAL_DS
VARCHAR	INTERVAL_DS
LONG VARCHAR	INTERVAL_DS
NATIVE_SMALLINT	INTERVAL_DS
NATIVE_INTEGER	INTERVAL_DS
NATIVE_BIGINT	INTERVAL_DS
NUMBER	INTERVAL_DS
NUMERIC	INTERVAL_DS
FLOAT	INTERVAL_DS
INTERVAL_DS	INTERVAL_DS (no conversion)

Table 11-21 Type conversion for the BO comparison

Source type	Converted type
CHAR	BOOLEAN
VARCHAR	BOOLEAN
LONG VARCHAR	BOOLEAN
BOOLEAN	BOOLEAN (no conversion)

Table 11-22 Type conversion for the RI comparison

Source type	Converted type
CHAR	ROWID
VARCHAR	ROWID
LONG VARCHAR	ROWID
ROWID	ROWID (no conversion)

Type Conversion

Type conversions are classified into implicit type conversion and explicit type conversion.

- Implicit type conversion occurs in an expression, an operator, a function, a condition, for select, insert, delete, update.
- Explicit type conversion occurs through the CAST operator.

Table 11-23 The availability of type conversion describes the availability of data type conversion from a type to another type.



In the type conversion table, the built-in data types are represented by an abbreviated string enclosed in double quotes ("").

- "CHAR": CHARACTER
- "VARCHAR": CHARACTER VARYING
- "LONG VARCHAR": CHARACTER LONG VARYING
- "VARBINARY": BINARY VARYING
- "LONG VARBINARY": BINARY LONG VARYING
- "TIME_TZ": TIME WITH TIMEZONE
- "TIMESTAMP_TZ": TIMESTAMP WITH TIMEZONE
- "INTERVAL_YM": INTERVAL YEAR TO MONTH
- "INTERVAL_DS": INTERVAL DAY TO SECOND

Data type	C H A R C H A R	V A R C H A R	L O N G V A R C H A R	B I N A R Y	V A R B I N A R Y	L O N G V A R B I N A R Y	N A T I V E S M A L L I N T	N A T I V E S I N T E R	N A T I V E S B I G I N T	N A T I V E S R E A L	N A T I V E S D O U B L E	N U M B E R	N U M E R I C	F L O A T	D A T E	T I M E	T I M E T Z	T I M E S T A M P	T I M E S T A M P T Z	I N T E R V A L Y M	I N T E R V A L D S	B O O L E A N	R O W I D
NUMB ER	0	0	0				0	0	0	0	0	0	0	0						0	0		
NUME RIC	0	0	0				0	0	0	0	0	0	0	0						0	0		
FLOAT	0	0	0				0	0	0	0	0	0	0							0	0		
DATE	0	0	0												0			0	0				
TIME	0	0	0													0	0						
TIME_ T Z	0	0	0													0	0						
TIMES TAMP	0	0	0												0	0		0	0				
TIMES TAMP _T Z	0	0	0												0	0	0	0	0				
INTER VAL_Y M	0	0	0				0	0	0			0	0	0						0			
INTER VAL_D S	0	0	0				0	0	0			0	0	0							0		
BOOLE AN	0	0	0																			0	
ROWI D	0	0	0																				0

- Conversion to CHARACTER type
 - When the source type is CHARACTER type:
 - If the source type precision is bigger than the CHARACTER type precision, then an error occu

- rs.
- If the source type precision is equal to the CHARACTER type precision, then the string is not changed.
- If the source type precision is smaller than the CHARACTER type precision, then space characters are added to the string as many as the precision difference.
- When the source type is CHARACTER VARYING type or CHARACTER LONG VARYING type:
 - If the source type string length is bigger than the CHARACTER type precision, then an error occurs.
 - If the source type string length is equal to the CHARACTER type precision, then the string is not changed.
 - If the source type string length is smaller than the CHARACTER type precision, then space characters are added to the string as many as precision difference.
- When the source type is numeric type, date/time type, INTERVAL type, BOOLEAN type or ROWID type:
 - If the converted string length of the source type is bigger than the CHARACTER type precision, then an error occurs.
 - If the converted string length of the source type is equal to the CHARACTER type precision, the string is not changed.
 - If the converted string length of the source type is smaller than the CHARACTER type precision, then space characters are added to the string as many as precision difference.
- Conversion to CHARACTER VARYING type
 - When the source type is CHARACTER type:
 - If the source type precision is bigger than the CHARACTER VARYING type precision, then an error occurs.
 - If the source type precision is equal or smaller than the CHARACTER VARYING type precision, then the string is not changed.
 - When the source type is CHARACTER VARYING type or CHARACTER LONG VARYING type:
 - If the source type string length is bigger than the CHARACTER VARYING type precision, then an error occurs.
 - If the source type string length is equal or smaller than the CHARACTER VARYING type precision, then the string is not changed.
 - When the source type is numeric type, date/time type, INTERVAL type, BOOLEAN type or ROWID type:
 - If the converted string length of the source type is bigger than the CHARACTER VARYING type precision, then an error occurs.
 - If the converted string length of the source type is equal or smaller than the CHARACTER VARYING type precision, then the string is not changed.
- Conversion to CHARACTER LONG VARYING type
 - When the source type is CHARACTER STRING type:
 - The source type string is not changed.
 - When the source type is numeric type, date/time type, INTERVAL type, BOOLEAN type or ROWID type:

- The converted string of the source type is not changed.
- Conversion to BINARY type
 - When the source type is BINARY type:
 - If the source type precision is bigger than the BINARY type precision, then an error occurs.
 - If the source type precision is equal to the BINARY type precision, then the binary string is not changed.
 - If the source type precision is smaller than the BINARY type precision, the X'00' characters are added to the binary string as many as the precision difference.
 - When the source type is BINARY VARYING type or BINARY LONG VARYING type:
 - If the source type binary string length is bigger than the BINARY type precision, then an error occurs.
 - If the source type binary string length is equal to the BINARY type precision, then the binary string is not changed.
 - If the source type binary string length is smaller than the BINARY type precision, the X'00' characters are added to a binary string as many as precision difference.
- Conversion to BINARY VARYING type
 - When the source type is BINARY type:
 - If the source type precision is bigger than the BINARY VARYING type precision, then an error occurs.
 - If the source type precision is equal or smaller than the BINARY VARYING type precision, then the binary string is not changed.
 - When the source type is BINARY VARYING type, BINARY LONG VARYING type:
 - If the source type binary string length is bigger than the BINARY VARYING type precision, then an error occurs.
 - If the source type binary string length is equal or smaller than the BINARY VARYING type precision, the binary string is not changed.
- Conversion to BINARY LONG VARYING type
 - If the source type is BINARY STRING type, the source type binary string is not changed.
- Conversion to numeric type
 - When the source type is CHARACTER STRING type:
 - If the string does not comply with the numeric format, then an error occurs.
 - An overflow or rounding can occur due to the precision and scale which is defined in the converted type.
 - When the source type is numeric type:
 - An overflow or rounding can occur due to the precision and scale which is defined in the converted type.
 - When the source type is INTERVAL type:
 - It can be converted to the numeric type only when the source type is the single field (YEAR, MONTH, DAY, HOUR, MINUTE, SECOND).

- An overflow or rounding can occur due to the precision and scale which is defined in the converted type.
- Conversion to DATE type
 - When the source type is CHARACTER STRING type:
 - If the string does not comply with the DATE type format, then an error occurs.
 - An overflow can occur due to a value range which is defined in the converted type.
 - When the source type is DATE type or TIMESTAMP type:
 - The error does not occur.
 - When the source type is TIMESTAMP WITH TIME ZONE type:
 - It is converted to the DATE type value upon consideration of the time zone offset.
- Conversion to TIME type
 - When the source type is CHARACTER STRING type:
 - If the string does not comply with the TIME type format, then an error occurs.
 - A rounding can occur due to a value range which is defined in the converted type.
 - When the source type is TIME type or TIMESTAMP type:
 - The error does not occur.
 - When the source type is TIME WITH TIME ZONE type or TIMESTAMP WITH TIME ZONE type:
 - It is converted to the value of TIME type upon consideration of the time zone offset.
- Conversion to TIME WITH TIME ZONE type
 - When the source type is CHARACTER STRING type:
 - If the string does not comply with the TIME WITH TIME ZONE type format, then an error occurs.
 - A rounding can occur due to a value range which is defined in the converted type.
 - When the source type is TIME type, TIME WITH TIME ZONE type or TIMESTAMP WITH TIME ZONE type:
 - It is converted to the value of TIME WITH TIME ZONE type upon consideration of the time zone offset.
- Conversion to TIMESTAMP type
 - When the source type is CHARACTER STRING type:
 - If the string does not comply with the TIMESTAMP type format, then an error occurs.
 - An overflow or rounding can occur due to a value range which is defined in the converted type.
 - When the source type is DATE type or TIMESTAMP type:
 - The error does not occur.
 - When the source type is TIMESTAMP WITH TIME ZONE type:
 - It is converted to the TIMESTAMP type value upon consideration of the time zone offset.
- Conversion to TIMESTAMP WITH TIME ZONE type
 - When the source type is CHARACTER STRING type:

- If the string does not comply with the `TIMESTAMP WITH TIME ZONE` type format, then an error occurs.
- An overflow or rounding can occur due to a value range which is defined in the converted type.
- When the source type is `DATE` type, `TIMESTAMP` type or `TIMESTAMP WITH TIME ZONE` type:
 - It is converted to the value of `TIMESTAMP WITH TIME ZONE` type upon consideration of the time zone offset.
- Conversion to `INTERVAL YEAR TO MONTH` family type
 - When the source type is `CHARACTER STRING` type:
 - If the string does not comply with the year-month interval literal format, then an error occurs.
 - For more information, refer to **Interval Literals**.
 - An overflow can occur due to a precision which is defined in the converted type.
 - When the source type is `NATIVE_SMALLINT`, `NATIVE_INTEGER`, `NATIVE_BIGINT`, `NUMBER`, `NUMERIC` or `FLOAT` type:
 - The converted type should be a single field (`YEAR`, `MONTH`).
 - An overflow can occur due to a precision which is defined in the converted type.
 - When the source type is `INTERVAL YEAR TO MONTH` family type:
 - An overflow can occur due to a precision which is defined in the converted type.
- Conversion to `INTERVAL DAY TO SECOND` family type
 - When the source type is `CHARACTER STRING` type:
 - If the string does not comply with the day-time interval literal format, then an error occurs.
 - For more information, refer to **Interval Literals**.
 - An overflow or rounding can occur due to the precision which is defined in the converted type.
 - When the source type is `NATIVE_SMALLINT`, `NATIVE_INTEGER`, `NATIVE_BIGINT`, `NUMBER`, `NUMERIC`, or `FLOAT` type:
 - The converted type should be a single field (`DAY`, `HOUR`, `MINUTE`, `SECOND`)
 - An overflow or rounding can occur due to the precision which is defined in the converted type.
 - When the source type is `INTERVAL DAY TO SECOND` family type:
 - An overflow or rounding can occur due to the precision which is defined in the converted type.
- Conversion to `BOOLEAN` type
 - When the source type is `CHARACTER STRING` type:
 - The conversion is available when the string is `"TRUE"` or `"FALSE"`, and it is case-insensitive. (It is convertible even when the string includes a space before and after it.)
 - When the source type is `BOOLEAN` type:
 - The error does not occur.
- Conversion to `ROWID` type

- When the source type is CHARACTER STRING type:
 - If the string does not comply with the ROWID type format, then an error occurs.
- When the source type is ROWID type:
 - The error does not occur.

Type Combination

When Type Combination Is Required

A CASE operator and a **set operator** have many expressions as a result of operation. Each expression can have different types each other as follows. In this case, the result type should be determined.

- The following describes an execution result of a CASE operator.

```
SELECT CASE expr WHEN expr THEN char(3)
           WHEN expr THEN char(5)
           ELSE char(1)
        END
FROM t1;
```

- The following describes an execution result of a set operator.

```
SELECT float_column
FROM t1
UNION ALL
SELECT number_precision_column
FROM t2
UNION ALL
SELECT native_integer_column
FROM t3;
```

A rule is applied to determine the result type according to the type combination. The following is an example of applying the rule.

- Result type combination rule
 - **set operator**
 - CASE operator
 - CASE Expression
 - COALESCE

- **NULLIF**

Result Type Combination Rule

Each expression's data type should be the same family type which is available to combine.

- Examples of applying result type combination rule
 - **set operator**
 - CASE operator
 - **CASE Expression**
 - **COALESCE**
 - **NULLIF**

The result types determined by result type combination rule are described in the following table.



The following abbreviations are used to describe the result type combination rule.

- "VC": CHARACTER VARYING
- "LC": CHARACTER LONG VARYING
- "VB": BINARY VARYING
- "LB": BINARY LONG VARYING
- "NS": NATIVE_SMALLINT
- "NI": NATIVE_INTEGER
- "NB": NATIVE_BIGINT
- "NR": NATIVE_REAL
- "ND": NATIVE_DOUBLE
- "FL": FLOAT
- "NU": NUMBER
- "DA": DATE
- "TI": TIME
- "TZ": TIME WITH TIMEZONE
- "TS": TIMESTAMP
- "SZ": TIMESTAMP WITH TIMEZONE
- "YM": INTERVAL YEAR TO MONTH
- "DS": INTERVAL DAY TO SECOND
- "BO": BOOLEAN
- "RI": ROWID

Data type	CHAR	VARCHAR	LONG VARCHAR	BINARY	VARBINARY	LONG VARCHAR	NATIVE_INTEGER	NATIVE_SMALLINT	NATIVE_INTEGER	NATIVE_BIGINT	NATIVE_REAL	NATIVE_DOUBLE	NUMBER	NUMERIC	FLOAT	DATE	TIME	TIME_TZ	TIMESTAMP	TIMESTAMP_TZ	INTERVAL	INTERVAL_DS	BLOB	ROWID	
NARY																									
NATIVE_SMALLINT							NS	NI	NB	ND	ND	NU	NU	NU											
NATIVE_INTEGER							NI	NI	NB	ND	ND	NU	NU	NU											
NATIVE_BIGINT							NB	NB	NB	ND	ND	NU	NU	NU											
NATIVE_REAL							ND	ND	ND	NR	ND	ND	ND	ND											
NATIVE_DOUBLE							ND	ND	ND	ND	ND	ND	ND	ND											
NUMBER							NU	NU	NU	ND	ND	NU	NU	NU											
NUMERIC							NU	NU	NU	ND	ND	NU	NU	NU											
FLOAT							NU	NU	NU	ND	ND	NU	NU	FL											
DATE																DA			TS	SZ					
TIME																	TI	TZ							
TIME_TZ																	TZ	TZ							
TIMESTAMP																TS			TS	SZ					
TIMESTAMP_TZ																SZ			SZ	SZ					

Data type	C	V	L	B	V	L	N	N	N	N	N	N	N	F	D	T	T	T	T	I	I	B	R
	H	A	O	I	A	O	A	A	A	A	A	U	U	L	A	I	I	I	I	N	N	O	O
	A	R	N	N	R	N	T	T	T	T	T	M	M	O	T	M	M	M	M	T	T	E	E
	R	C	G	A	B	G	I	I	I	I	I	B	E	A	E	E	E	E	E	E	E	L	D
	H			R	I		V	V	V	V	V	E	R	T			S	S	R	R	V	E	
	A	V	Y	N	V	A	E	E	E	E	E	R	I			T	T	V	V	A	A	A	
	R	A		A	R	R	S	I	B	R	D					Z	M	A	A	L	L	N	
	C			Y	B	M	N	I	E	O						P	M	P					
	H				I	A	T	G	A	U									Y	D			
	A				N	L	E	I	L	B									M	S			
	R				A	R	I	E		L													
	R				Y	N	T	R		E													
TZ																							
INTERV AL_Y M																				YM			
INTERV AL_DS																					DS		
BOOLE AN																						B0	
ROWI D																							RI

- The result type of when all is CHAR type
 - If the lengths are different, then it is VARCHAR type.
 - If the lengths are equal, then it is CHAR type.
- The result type of when all is BINARY type
 - If the lengths are different, then it is VARBINARY type.
 - If the lengths are equal, then it is BINARY type.
- The result type of INTERVAL YEAR TO MONTH type
 - If YEAR type and MONTH type are mixed, then it is INTERVAL YEAR TO MONTH type.
 - If there is only YEAR type, then it is INTERVAL YEAR type.
 - If there is only MONTH type, then it is INTERVAL MONTH type.
- The result type of INTERVAL DAY TO SECOND type
 - The start field is the biggest range field of each target expression.
 - The end field is the smallest range field of each target expression.
 - e.g. {INTERVAL DAY, INTERVAL HOUR} => INTERVAL DAY TO HOUR
- The precision, scale of the result type
 - CHARACTER STRING type
 - The maximum character length of the target expression

- BINARY STRING type
 - The maximum character length of the target expression
- NUMERIC type
 - It specifies an acceptable maximum range of the type's value.
- TIME/TIMESTAMP type
 - The maximum fractional seconds precision of the target expression
- INTERVAL YEAR TO MONTH
 - The maximum leading precision of the target expression
- INTERVAL DAY TO SECOND
 - Leading precision is the maximum leading precision of the start field
 - Fractional seconds precision is the maximum fractional seconds precision.
- For more information, refer to **Type Comparison**.

Compatibility for Data Type

The SQL standard compatibility for data type is as follows.

Table 11-25 SQL standard compatibility for data type

Feature ID	Description	Availability
B033	Untyped SQL-invoked function arguments	X
E011-01	INTEGER and SMALLINT data types	O
E011-02	REAL, DOUBLE PRECISION, and FLOAT data types	O
E011-03	DECIMAL and NUMERIC data types	X
E011-04	Arithmetic operators	O
E011-05	Numeric comparison	O
E011-06	Implicit casting among the numeric data types	O
E021-01	CHARACTER data type	O
E021-02	CHARACTER VARYING data type	O
E021-03	Character literals	O
E021-04	CHARACTER_LENGTH function	O
E021-05	OCTET_LENGTH function	O
E021-06	SUBSTRING function	O
E021-07	Character concatenation	O
E021-08	UPPER and LOWER functions	O
E021-09	TRIM function	O
E021-10	Implicit casting among the fixed-length and variable-length character string types	O
E021-11	POSITION function	O
E021-12	Character comparison	O
	Columns combined via table operators need not have exactly the same data	

Feature ID	Description	Availability
E071-05	type	O
F051-01	DATE data type (including support of DATE literal)	O
F051-02	TIME data type (including support of TIME literal) with fractional seconds precision of at least 0	O
F051-03	TIMESTAMP data type (including support of TIMESTAMP literal) with fractional seconds precision of at least 0 and 6	O
F051-04	Comparison predicate on DATE, TIME, and TIMESTAMP data types	X
F051-05	Explicit CAST between datetime types and character string types	O
F054	TIMESTAMP in DATE type precedence list	X
F382	Alter column data type	O
F611	Indicator data types	X
F741	Referential MATCH types	X
J521	JDBC data types	X
J622	external Java types	X
S011-01	USER_DEFINED_TYPES view	X
S023	Basic structured types	X
S024	Enhanced structured types	X
S025	Final structured types	X
S026	Self-referencing structured types	X
S041	Basic reference types	X
S043	Enhanced reference types	X
S051	Create table of type	X
S071	SQL paths in function and type name resolution	X
S091-01	Arrays of built-in data types	X
S091-02	Arrays of distinct types	X
S092	Arrays of user-defined types	X
S094	Arrays of reference types	X
S161	Subtype treatment	X
S162	Subtype treatment for references	X
S201-02	Array as result type of functions	X
S231	Structured type locators	X
S261	Specific type method	X
S272	Multisets of user-defined types	X
S274	Multisets of reference types	X
S281	Nested collection types	X
S401	Distinct types based on array types	X
S402	Distinct types based on distinct types	X
T021	BINARY and VARBINARY data types	O
T022	Advanced support for BINARY and VARBINARY data types	O
T031	BOOLEAN data type	O

Feature ID	Description	Availability
T041	Basic LOB data type support	X
T042	Extended LOB data type support	X
T051	Row types	X
T071	BIGINT data type	O
T201	Comparable data types for referential constraints	X
T322	Declared data type attributes	X
X010	XML type	X
X011	Arrays of XML type	X
X012	XMLMultisets of XML type	X
X013	Distinct types of XML type	X
X014	Attributes of XML type	X
X015	Fields of XML type	X
X181	XML(DOCUMENT(UNTYPED)) type	X
X182	XML(DOCUMENT(ANY)) type	X
X190	XML(SEQUENCE) type	X
X191	XML(DOCUMENT(XMLSCHEMA)) type	X
X192	XML(CONTENT(XMLSCHEMA)) type	X
X231	XML(CONTENT(UNTYPED)) type	X
X232	XML(CONTENT(ANY)) type	X
X251	Persistent XML values of XML(DOCUMENT(UNTYPED)) type	X
X252	Persistent XML values of XML(DOCUMENT(ANY)) type	X
X253	Persistent XML values of XML(CONTENT(UNTYPED)) type	X
X254	Persistent XML values of XML(CONTENT(ANY)) type	X
X255	Persistent XML values of XML(SEQUENCE) type	X
X256	Persistent XML values of XML(DOCUMENT(XMLSCHEMA)) type	X
X257	Persistent XML values of XML(CONTENT(XMLSCHEMA)) type	X
X260	XML type: ELEMENT clause	X
X261	XML type: NAMESPACE without ELEMENT clause	X
X263	XML type: NO NAMESPACE with ELEMENT clause	X
X264	XML type: schema location	X
X410	Alter column data type: XML type	X

11.3 Format String

Format string defines the format which is used when a numeric type or date/time type is converted to a character string or when a character string is converted to a numeric type or date/time type.

- When a numeric type or date/time type is converted to a character string type, the representation format of the string is as follows.
 - Refer to **TO_CHAR(number), TO_CHAR(datetime)**.
 - Numeric type: `TO_CHAR(1234.56, 'S9,999.99')` → '+1,234.56'
 - Date/time type: `TO_CHAR(SYSDATE, 'YYYY-MM-DD')` → '2012-07-15'
- When a character string is converted to the numeric type or date/time type, the representation format of the string is as follows.
 - Refer to **TO_NUMBER, TO_NATIVE_REAL, TO_NATIVE_DOUBLE**.
 - Refer to **TO_DATE**.
 - Refer to **TO_TIMESTAMP, TO_TIMESTAMP_WITH_TIME_ZONE**.
 - Refer to **TO_TIME, TO_TIME_WITH_TIME_ZONE**.
 - Numeric type: `TO_NUMBER('+1,234.56', 'S9,999.99')` → NUMBER TYPE
 - Date/time type: `TO_DATE('2012-07-15', 'YYYY-MM-DD')` → DATE TYPE

Format strings are classified according to the type.

- Numeric data type: Refer to **Number Format String**.
- Date/time type: Refer to **Datetime Format String**.

Number Format String

Number format string defines the format which is used when a numeric type is converted to a character string type, or when a character string type is converted to a numeric type.

Number format string is used as an argument of the functions such as **TO_CHAR(number), TO_NUMBER, TO_NATIVE_REAL, TO_NATIVE_DOUBLE**.

Number format string can specify multiple format elements according to the desired format.

All number format elements are rounded off to fit the format.

If the number of digits before the decimal point of the value to be converted is bigger than the number of digits specified in the format string, then they are replaced with '#' character.

If the format element representing the sign of MI, S, PR is not specified, a negative number returns - sign and a positive number returns a white space to the front of the number.

Table 11-26 Number format elements

Format element	Example	Description
, (comma)	9,999	It returns a comma to the specified position. Multiple commas can be specified. Format string can not begin with a comma, and it can not come after the decimal point (.).
. (period)	99.99	It returns a decimal point(.) to the specified position. The decimal point in the format string can be specified only once.
\$	\$9999	It returns the \$ sign to the front of the number.
0	0999 9990	It returns zero(0) to the front of or to the end of the number. If the number of digit of the value to be converted is smaller than the number of digit to the zero position of the format string, then the gap is filled with zero(0)s and is returned.
9	9999	It returns a white space and numbers according to the sign and the number of specified 9. If the number of digit of the value to be converted is smaller than the number of the specified 9, then the gap is filled with white spaces and is returned. For a positive number, a white space is returned to the front of the number. For a negative number, '-' symbol is returned to the front of the number. If the value before the format string's decimal point is 0, then 0 is returned as a white space. e.g. TO_CHAR(0.123, '9.999') → .123 e.g. TO_CHAR(0, '9') → 0
B	B9999	If the value is zero, it returns a white space.
EEEE	9.9EEEE	It returns in exponential notation. It can be at the end of format string or it can be in front of S, MI, PR. It can not be specified together with a comma (,).
MI	9999MI	For a positive number, a white space is returned to the end of the number. For a negative number, '-' symbol is returned to the end of the number. It can be specified only at the end of format string and it can not be specified together with S, PR.
PR	9999PR	For a positive number, white spaces are returned to the beginning and end of the number. For a negative number, it returns the number into the inside of angle brackets. <number> It can be specified only at the end of format string, and it can not be specified together with S, MI.
RN rn	RN rn	Roman numerals are converted to uppercase and returned. (RN) Roman numerals are converted to lowercase and returned. (rn) Only the numbers between 1 ~ 3999 are returned. It can be specified together only with FM format element, but it can not be specified with any other format elements. It can not be used in TO_NUMBER function.

Format element	Example	Description
S	S9999 9999S	For a positive number, '+' symbol is returned to the front of the number. For a negative number '-' symbol is returned to the front of the number.(S9999 9 For a positive number, '+' symbol is returned to the end of the number. For a negative number '-' symbol is returned to the end of the number.(9999S) It can be specified only at the beginning of format string or at the end of format string. It can not be specified together with MI, PR.
V	999V99	10^n (n: the digit number of 9 after V format element) multiplied by the value is returned. It can not specified together with the decimal point (.). It can not be used in TO_NUMBER function.
X	XXXX xxxx	It returns the white space and hexadecimal number according to the digit number of the specified X. It converts an integer value to the hexadecimal number, and returns it. (A non-integer value is rounded off to make it to an integer value) XXX returns hexadecimal uppercase letters and xxxx returns hexadecimal lowercase letters. If the number of the converted hexadecimal digit is smaller than the number of the specified X, then the gap is filled with white spaces and is returned. Only 0 and positive integers are processed, and negative numbers are replaced with '#'. It can be specified together only with format element 0 and FM, but it can not be specified with any other format elements.
FM	FM	It removes the front and end white spaces, and returns left aligned effect. It removes the front and end white spaces of the number. It removes zero(0)s under the decimal point which are added by 9 format element.

Followings are examples of using number format string.

```

TO_CHAR( 12345, '99,999' )           : ' 12,345'
TO_CHAR( 123456789, '999,999,999' ) : ' 123,456,789'
TO_CHAR( 12.345, '99.999' )         : ' 12.345'
TO_CHAR( 1234.56, '$9,999.99' )     : ' $1,234.56'
TO_CHAR( 123, '099999' )            : ' 000123'
TO_CHAR( 0.2, '0.9' )               : ' 0.2'
TO_CHAR( 123.45, '999999.99' )     : '   123.45'
TO_CHAR( -123.45, '999999.99' )    : '  -123.45'
TO_CHAR( 123.45, 'FM999999.99' )   : '123.45'
TO_CHAR( -123.45, 'FM999999.99' )  : '-123.45'

```

```

TO_CHAR( 12345.67, '999.99' )      : '#####'
TO_CHAR( 123.100567, '999.999' )  : ' 123.101'
TO_CHAR( 0.2, '90.99' )           : ' 0.20'
TO_CHAR( 0.2, '99.99' )           : ' .20'
TO_CHAR( 0, '90.99' )             : ' 0.00'
TO_CHAR( 0, 'B90.99' )            : '      '
TO_CHAR( 123.45, '9.9EEEE' )      : ' 1.2E+02'
TO_CHAR( 123.45, '999.99MI' )     : '123.45 '
TO_CHAR( -123.45, '999.99MI' )    : '123.45-'
TO_CHAR( 123.45, '999.99PR' )     : ' 123.45 '
TO_CHAR( -123.45, '999.99PR' )    : '<123.45>'
TO_CHAR( 123, 'RN' )               : '      CXXIII'
TO_CHAR( 123, 'rn' )               : '      cxxiii'
TO_CHAR( 123, 'FMRN' )             : 'CXXIII'
TO_CHAR( 4000, 'RN' )              : '#####'
TO_CHAR( 123.45, 'S999.99' )      : '+123.45'
TO_CHAR( -123.45, 'S999.99' )     : '-123.45'
TO_CHAR( 123.45, '999.99S' )      : '123.45+'
TO_CHAR( -123.45, '999.99S' )     : '123.45-'
TO_CHAR( 123.45, '999V999' )      : ' 123450'
TO_CHAR( 123, 'XX' )               : ' 7B'
TO_CHAR( 123, 'xx' )               : ' 7b'
TO_CHAR( 45678, 'XXXXXXX' )       : '      B26E'
TO_CHAR( 45678, 'FMXXXXXXX' )     : 'B26E'
TO_CHAR( 123.45, '99,999.999999' ) : '      123.450000'
TO_CHAR( 123.45, 'FM99,999.999999' ) : '123.45'

```

Datetime Format String

Datetime format string defines the format which is used when a date/time type is converted to a character string type, or when a character string type is converted to a date/time type.

Datetime format string is used as an argument of the functions such as `TO_CHAR(datetime)`, `TO_DATE`, `TO_TIMESTAMP`, `TO_TIMESTAMP_WITH_TIME_ZONE`, `TO_TIME`, `TO_TIME_WITH_TIME_ZONE`.

For datetime format string, if the format string is not specified, then the default value is used. The default value of each type is specified in the session property (`NLS _ * _ FORMAT`).

- DATE: Refer to `NLS_DATE_FORMAT`.
- TIMESTAMP: Refer to `NLS_TIMESTAMP_FORMAT`.

- **TIMESTAMP WITH TIME ZONE**: Refer to **NLS_TIMESTAMP_WITH_TIME_ZONE_FORMAT**.
- **TIME**: Refer to **NLS_TIME_FORMAT**.
- **TIME WITH TIME ZONE**: Refer to **NLS_TIME_WITH_TIME_ZONE_FORMAT**.

NLS * _FORMAT values can be changed by using **ALTER SESSION SET property_name**.

In datetime format string, multiple format elements can be specified upon the desired representation.

Table 11-27 Datetime format elements

Format element	Whether to use T O_* datetime	Description
- / , . ; : "text" Special characters	Y	It returns the format element character to the specified location.
AD A.D.	Y	AD with or without periods.
AM A.M.	Y	AM with or without periods.
BC B.C.	Y	BC with or without periods.
CC	N	Century If the last two digits of the four digits year is 01~ 99, the value which is added by one to the first two digits is returned. (e.g. If the year is 2005, 21 is returned.) If the last two digits of the four digits year is 00, The first two digits value is returned. (e.g. If the year is 2000, 20 is returned.)
D	Y	It returns the sequence of the day in a week. (1 ~ 7) Sunday is 1, saturday is 7, and so on.
DAY Day day	Y	It returns the day of the week. (e.g. SUNDAY) <ul style="list-style-type: none"> • DAY: The day which is all in uppercase is returned. • Day: The day whose first character is uppercase and others are lowercase is returned. • day: The day which is all in lowercase is returned.
DD	Y	It returns the sequence of the day in a month. (1 ~ 31)
DDD	Y	It returns the sequence of the day in a year. (1 ~ 366)
DY		It returns the abbreviated word for the day of the week. (e.g. SUN) <ul style="list-style-type: none"> • DY: The day which is all in uppercase is returned.

Format element	Whether to use T O_* datetime	Description
Dy dy	Y	<ul style="list-style-type: none"> Dy: The day whose first character is uppercase and others are lowercase is returned. dy: The day which is all in lowercase is returned.
FF[1..6]	Y	<p>It returns fractional seconds as many as the number of the specified digits (1-6) after FF.</p> <p>If the number is not specified, the default value is 6. (FF is equal to FF6.)</p> <p>If the number of fractional seconds digit is bigger than the number specified after FF, then it is rounded down.</p> <p>If the number of fractional seconds digit is smaller than the number specified after FF, then zero(0) is added according to the specified number.</p> <p>It can not be used in DATE type.</p>
HH HH12	Y	The hour (1 ~ 12)
HH24	Y	The hour (0 ~ 23)
IW	N	<p>The week containing the first thursday of the year designated as the calendar week by ISO 8601 standards (1 ~ 52 week or 1 ~ 53 weeks) becomes the first week.</p> <ul style="list-style-type: none"> The calendar week starts from monday. The first calendar week includes January 4th. The first calendar week may includes December 29th, 30th, and 31st. The last calendar week may include January 1st, 2nd, and 3rd.
IYYY	N	The 4 digits year embracing the calendar week defined by ISO 8601 standards
IYY IY I	N	<p>The 3 digits year embracing the calendar week defined by ISO 8601 standards</p> <p>The 2 digits year embracing the calendar week defined by ISO 8601 standards</p> <p>The single digit year embracing the calendar week defined by ISO 8601 standards</p>
J	Y	Julian day: The number of days since BC 4714-11-24
MI	Y	Minute (0 ~ 59)
MM	Y	Month (01 ~ 12), January(01)~December(12)
MON Mon mon	Y	<p>The abbreviated word for the month. (e.g. JAN)</p> <ul style="list-style-type: none"> MON: The month which is all in uppercase is returned. Mon: The month whose first character is uppercase and others are lowercase is returned. mon: The month which is all in lowercase is returned.
MONTH Month	Y	<p>The month name (e.g. JANUARY)</p> <ul style="list-style-type: none"> MONTH: All uppercase month name is returned. Month: The month name that only the first letter is uppercase and others are lowercase is returned.

Format element	Whether to use T O_* datetime	Description
month		<p>ers are lowercase is returned.</p> <ul style="list-style-type: none"> month: The month of which is all in lowercase is returned.
PM P.M.	Y	PM with or without periods.
Q	N	<p>The quarter of the year (1 ~ 4) January to March is 1 and October to December is 4.</p>
RM Rm rm	Y	<p>It returns the roman numeral month. (e.g. I)</p> <ul style="list-style-type: none"> RM: The month which is all in uppercase is returned. Rm: The month whose first character is uppercase and others are lowercase is returned. rm: The month which is all in lowercase is returned.
RR	Y	<p>Adjusted two digit year The two digit year represented by RR can be converted to four digit year as follows.</p> <ul style="list-style-type: none"> When the two digit year represented by RR is 00~49: <ul style="list-style-type: none"> If the last two digits of the current year is 00~50, <ul style="list-style-type: none"> the four digit year is represented using the first two digits of the current year and the two digits which is represented by RR. If the last two digits of the current year is 51~99, <ul style="list-style-type: none"> the four digit year is represented using "the first two digits of the current year+1" and the two digits which is represented by RR. When the two digit year represented by RR is 50~99: <ul style="list-style-type: none"> If the last two digits of the current year is 00~50, <ul style="list-style-type: none"> the four digit year is represented using "the first two digit of the current year - 1" and the two digits which is represented by RR. If the last two digit of the current year is 51~99, <ul style="list-style-type: none"> the four digit year is expressed using the first two digit of the current year and the two digits which is represented by RR.
RRRR	Y	<p>Adjusted four digit year Two digit or four digit can be input. Two digit input is processed in the same way as RR.</p>
SS	Y	Second (0 ~ 59)
SSSSS	Y	Seconds since last midnight (0 ~ 86399)
TZH	Y	<p>Time Zone Hour It can not be used in DATE, TIMESTAMP, TIME types. It is available in TIMESTAMP WITH TIME ZONE, TIME WITH TIME ZONE types.</p>
TZM	Y	<p>Time Zone Minute It can not be used in DATE, TIMESTAMP, TIME types. It can be used only in</p>

Format element	Whether to use T O_* datetime	Description
		TIMESTAMP WITH TIME ZONE, TIME WITH TIME ZONE types.
WW	N	The sequence of the week in a year. (1~ 53) The first week 1 starts on the first day of the year and continues to the seventh day of the year.
W	N	The sequence of the week in a month. (1 ~ 5) The first week 1 starts on the first day of the month and ends on the seventh day.
Y,YYY	Y	It returns the year with comma in the Y,YYY form.
YYYY SYYYY	Y	Four digit year. If it is BC, SYYYY returns '-' signal.
YYY YY Y	Y	<ul style="list-style-type: none"> • YYY: The last three digit year of the current year • YY: The last two digit year of the current year • Y: The last one digit year of the current year

The followings are examples of using datetime format string.

* - / , . ; : "text" Special character

- TO_CHAR(TO_DATE('2012-07-15 03:30:30', 'YYYY-MM-DD HH12:MI:SS'),
'YYYY/MM/DD HH12:MI:SS')
=> '2012/07/15 03:30:30'
- TO_CHAR(TO_DATE('2012-07-15', 'YYYY-MM-DD'),
'YYYY"year" DDD"th day"')
=> '2012year 197th day'

* AD

- TO_CHAR(TO_DATE('2012-07-15 AD', 'YYYY-MM-DD AD'), 'YYYY AD')
=> '2012 AD'
- TO_CHAR(TO_DATE('0001-01-01 BC', 'YYYY-MM-DD AD'), 'YYYY AD')
=> '0001 BC'

* BC

- TO_CHAR(TO_DATE('0001-01-01 BC', 'YYYY-MM-DD BC'), 'YYYY BC')
=> '0001 BC'
- TO_CHAR(TO_DATE('2012-07-15', 'YYYY-MM-DD'), 'YYYY BC')
=> '2012 AD'

* AM

- TO_CHAR(TO_DATE('2012-07-15 03:30:30 AM',
'YYYY-MM-DD HH12:MI:SS AM'),
'HH12:MI:SS AM')

==> '03:30:30 AM'

- TO_CHAR(TO_DATE('2012-07-15 21:30:30', 'YYYY-MM-DD HH24:MI:SS'),
'HH12:MI:SS AM')

==> '09:30:30 PM'

* PM

- TO_CHAR(TO_DATE('2012-07-15 03:30:30',
'YYYY-MM-DD HH24:MI:SS'),
'HH12:MI:SS PM')

==> '03:30:30 AM'

- TO_CHAR(TO_DATE('2012-07-15 09:30:30 PM',
'YYYY-MM-DD HH12:MI:SS PM'),
'HH12:MI:SS PM')

==> '09:30:30 PM'

* CC

- TO_CHAR(TO_DATE('2012-07-15', 'YYYY-MM-DD'), 'CC')

==> '21'

* D

- TO_CHAR(TO_DATE('2012-07-15', 'YYYY-MM-DD'), 'D')

==> '1'

* DD

- TO_CHAR(TO_DATE('2012-07-15', 'YYYY-MM-DD'), 'DD')

==> '15'

* DDD

- TO_CHAR(TO_DATE('2012-07-15', 'YYYY-MM-DD'), 'DDD')

==> '197'

* DAY

- TO_CHAR(TO_DATE('2012-07-15', 'YYYY-MM-DD'), 'DAY')

==> 'SUNDAY'

- TO_CHAR(TO_DATE('2012-07-15', 'YYYY-MM-DD'), 'Day')

==> 'Sunday'

- TO_CHAR(TO_DATE('2012-07-15', 'YYYY-MM-DD'), 'day')

==> 'sunday'

* DY

- TO_CHAR(TO_DATE('2012-07-15', 'YYYY-MM-DD'), 'DY')

==> 'SUN'

- TO_CHAR(TO_DATE('2012-07-15', 'YYYY-MM-DD'), 'Dy')

==> 'Sun'

- TO_CHAR(TO_DATE('2012-07-15', 'YYYY-MM-DD'), 'dy')

```
==> 'sun'
```

```
* FF[1 ... 6]
```

```
• TO_CHAR( TO_TIMESTAMP( '2012-07-15 03:30:45.123456',
                        'YYYY-MM-DD HH24:MI:SS.FF6' ),
          'FF' )
```

```
==> '123456'
```

```
• TO_CHAR( TO_TIMESTAMP( '2012-07-15 03:30:45.123456',
                        'YYYY-MM-DD HH24:MI:SS.FF6' ),
          'FF5' )
```

```
==> '12345'
```

```
• TO_CHAR( TO_TIMESTAMP( '2012-07-15 03:30:45.9',
                        'YYYY-MM-DD HH24:MI:SS.FF1' ),
          'FF6' )
```

```
==> '900000'
```

```
* HH HH12 HH24
```

```
• TO_CHAR( TO_TIMESTAMP( '2012-07-15 03:30:45.123456',
                        'YYYY-MM-DD HH24:MI:SS.FF6' ),
          'HH12' )
```

```
==> '03'
```

```
• TO_CHAR( TO_TIMESTAMP( '2012-07-15 23:30:45.123456',
                        'YYYY-MM-DD HH24:MI:SS.FF6' ),
          'HH12' )
```

```
==> '11'
```

```
• TO_CHAR( TO_TIMESTAMP( '2012-07-15 23:30:45.123456',
                        'YYYY-MM-DD HH24:MI:SS.FF6' ),
          'HH24' )
```

```
==> '23'
```

```
* IW
```

```
• TO_CHAR( DATE '2016-01-01', 'IW' )
```

```
==> 53
```

```
• TO_CHAR( DATE '2014-12-30', 'IW' )
```

```
==> 01
```

```
* IYYY
```

```
• TO_CHAR( DATE '2016-01-01', 'IYYY' )
```

```
==> 2015
```

```
• TO_CHAR( DATE '2014-12-30', 'IYYY' )
```

```
==> 2015
```

*** IYY**

- TO_CHAR(DATE'2016-01-01', 'IYY')
==> 015

*** IY**

- TO_CHAR(DATE'2016-01-01', 'IY')
==> 15

*** I**

- TO_CHAR(DATE'2016-01-01', 'I')
==> 5

*** J**

- TO_CHAR(TO_DATE('2012-07-15', 'YYYY-MM-DD'), 'J')
==> '2456124'
- TO_CHAR(TO_DATE('2456124', 'J'), 'YYYY-MM-DD')
==> '2012-07-15'

*** MI**

- TO_CHAR(TO_TIMESTAMP('2012-07-15 23:30:45.123456',
 'YYYY-MM-DD HH24:MI:SS.FF6'),
 'MI')
==> '30'

*** MM**

- TO_CHAR(TO_TIMESTAMP('2012-07-15 23:30:45.123456',
 'YYYY-MM-DD HH24:MI:SS.FF6'),
 'MM')
==> '07'

*** MON**

- TO_CHAR(TO_DATE('2012-07-15', 'YYYY-MM-DD'), 'MON')
==> 'JUL'
- TO_CHAR(TO_DATE('2012-07-15', 'YYYY-MM-DD'), 'Mon')
==> 'Jul'
- TO_CHAR(TO_DATE('2012-07-15', 'YYYY-MM-DD'), 'mon')
==> 'jul'

*** MONTH**

- TO_CHAR(TO_DATE('2012-07-15', 'YYYY-MM-DD'), 'MONTH')
==> 'JULY'
- TO_CHAR(TO_DATE('2012-07-15', 'YYYY-MM-DD'), 'Month')
==> 'July'
- TO_CHAR(TO_DATE('2012-07-15', 'YYYY-MM-DD'), 'month')

```
==> 'july      '
```

* Q

- TO_CHAR(TO_DATE('2012-07-15', 'YYYY-MM-DD'), 'Q')
==> '3'

* RM

- TO_CHAR(TO_DATE('2012-07-15', 'YYYY-MM-DD'), 'RM')
==> 'VII '
- TO_CHAR(TO_DATE('2012-07-15', 'YYYY-MM-DD'), 'Rm')
==> 'Vii '
- TO_CHAR(TO_DATE('2012-07-15', 'YYYY-MM-DD'), 'rm')
==> 'vii '

* RR, RRRR (The current year is 2014.)

- TO_CHAR(TO_DATE('49-07-15', 'RR-MM-DD'), 'RRRR')
==> '2049'
- TO_CHAR(TO_DATE('49-07-15', 'RR-MM-DD'), 'YYYY')
==> '2049'
- TO_CHAR(TO_DATE('50-07-15', 'RR-MM-DD'), 'RRRR')
==> '1950'
- TO_CHAR(TO_DATE('50-07-15', 'RR-MM-DD'), 'YYYY')
==> '1950'
- TO_CHAR(TO_DATE('50-07-15', 'YY-MM-DD'), 'RRRR')
==> '2050'
- TO_CHAR(TO_DATE('49-07-15', 'RRRR-MM-DD'), 'YYYY')
==> '2049'
- TO_CHAR(TO_DATE('50-07-15', 'RRRR-MM-DD'), 'YYYY')
==> '1950'

* RR, RRRR (The current year is 2051.)

- TO_CHAR(TO_DATE('49-07-15', 'RR-MM-DD'), 'RRRR')
==> '2149'
- TO_CHAR(TO_DATE('49-07-15', 'RR-MM-DD'), 'YYYY')
==> '2149'
- TO_CHAR(TO_DATE('50-07-15', 'RR-MM-DD'), 'RRRR')
==> '2050'
- TO_CHAR(TO_DATE('50-07-15', 'RR-MM-DD'), 'YYYY')
==> '2050'
- TO_CHAR(TO_DATE('50-07-15', 'YY-MM-DD'), 'RRRR')
==> '2050'
- TO_CHAR(TO_DATE('49-07-15', 'RRRR-MM-DD'), 'YYYY')

==> '2149'

- TO_CHAR(TO_DATE('50-07-15', 'RRRR-MM-DD'), 'YYYY')
==> '2050'

* SS

- TO_CHAR(TO_TIMESTAMP('2012-07-15 23:30:45.123456',
 'YYYY-MM-DD HH24:MI:SS.FF6'),
 'SS')
==> '45'

* SSSSS

- TO_CHAR(TO_TIMESTAMP('2012-07-15 23:30:45.123456',
 'YYYY-MM-DD HH24:MI:SS.FF6'),
 'SSSSS')
==> '84645'

* TZH

- TO_CHAR(TO_TIMESTAMP_TZ('2012-07-15 23:30:45.123456 +09:00',
 'YYYY-MM-DD HH24:MI:SS.FF6 TZH:TZM'),
 'TZH')
==> '+09'

* TZM

- TO_CHAR(TO_TIMESTAMP_TZ('2012-07-15 23:30:45.123456 +09:00',
 'YYYY-MM-DD HH24:MI:SS.FF6 TZH:TZM'),
 'TZM')
==> '00'
- TO_CHAR(TO_TIMESTAMP_TZ('2012-07-15 23:30:45.123456 +09:00',
 'YYYY-MM-DD HH24:MI:SS.FF6 TZH:TZM'),
 'TZH:TZM')
==> '+09:00'

* WW

- TO_CHAR(TO_DATE('2012-07-15', 'YYYY-MM-DD'), 'WW')
==> '29'

* W

- TO_CHAR(TO_DATE('2012-07-15', 'YYYY-MM-DD'), 'W')
==> '3'

* Y,YYY

- TO_CHAR(TO_DATE('2,012-07-15', 'Y,YYY-MM-DD'), 'Y,YYY')
==> '2,012'

* YYYY

- `TO_CHAR(TO_DATE('2012-07-15', 'YYYY-MM-DD'), 'YYYY')`
==> '2012'

* SYYYY

- `TO_CHAR(TO_DATE('-0001-01-01', 'SYYYY-MM-DD'), 'SYYYY')`
==> '-0001'

* YYY

- `TO_CHAR(TO_DATE('012-07-15', 'YYY-MM-DD'), 'YYY')`
==> '012'
- `TO_CHAR(TO_DATE('012-07-15', 'YYY-MM-DD'), 'YYYY')`
==> '2012' ((Current year / 1000) is 2)

* YY

- `TO_CHAR(TO_DATE('12-07-15', 'YY-MM-DD'), 'YY')`
==> '12'
- `TO_CHAR(TO_DATE('12-07-15', 'YY-MM-DD'), 'YYYY')`
==> '2012' ((Current year / 100) is 20)
==> '2112' ((Current year / 100) is 21)

* Y

- `TO_CHAR(TO_DATE('2-07-15', 'Y-MM-DD'), 'Y')`
==> '2'
- `TO_CHAR(TO_DATE('12-07-15', 'YY-MM-DD'), 'YYYY')`
==> '2012' ((Current year / 10 years) is 201)
==> '2052' ((Current year / 10 years) is 205)

11.4 Expressions

Expression is a combination of value, operator and function for getting data values.

The following is the position of the SQL commands in which expression can be used.

- Target clause in SELECT
- GROUP BY clause in SELECT
- ORDER BY clause in SELECT
- WHERE clause and HAVING clause in SELECT
- INSERT VALUES clause
- UPDATE SET clause
- RETURN clause in INSERT, DELETE, UPDATE

Expression types are various as follows.

- Simple expression
- Compound expression
- Boolean value expression
- Case expression
- Datetime expression
- Scalar subquery expression
- Sequence manipulation expression

Simple expressions are column, pseudo columns, literals, and null value.

Compound expressions are combination of multiple expressions.

For more information, refer to the followings.

- **Null Value**
- **Literals**
- **Pseudo Columns**
- **Operators**
- **Functions**

Boolean Value Expression

Syntax

```
<boolean value expression> ::=
    <boolean term>
    | <boolean value expression> OR <boolean term>
```

```

<boolean term> ::=
    <boolean factor>
    | <boolean term> AND <boolean factor>
<boolean factor> ::=
    [ NOT ] <boolean test>
<boolean test> ::=
    <boolean primary> [ IS [ NOT ] <truth value> ]
<truth value> ::=
    TRUE
    | FALSE
    | UNKNOWN
<boolean primary> ::=
    <column>
    <condition>
    | <boolean predicand>
<boolean predicand> ::=
    <parenthesized boolean value expression>
    | <nonparenthesized value expression primary>
<parenthesized boolean value expression> ::=
    <left paren> <boolean value expression> <right paren>

```

Description

<boolean value expression> describes a boolean value. <boolean primary> with boolean value are <column>, <condition>, and <boolean predicand>. <column> should be declared as BOOLEAN type, and it is allowed to return a boolean value using CAST.

<boolean value expression> can use logical operators such as AND, OR, NOT, and the dedicated operators of boolean value such as IS, IS NOT are also supported.

IS operator and IS NOT operator which are described in <boolean test> determine whether the boolean value described in <boolean primary> matches with one of the <truth value> (TRUE, FALSE, UNKNOWN).

For more information, refer to **Conditions**.

Example

```

gSQL> SELECT * FROM T1 WHERE CAST('TRUE' AS BOOLEAN);
I1
-----
TRUE

```

```

FALSE
null
3 rows selected.
gSQL> SELECT * FROM T1 WHERE I1;
I1
----
TRUE
1 row selected.
gSQL> SELECT * FROM T1 WHERE I1 IS TRUE;
I1
----
TRUE
1 row selected.
gSQL> SELECT * FROM T1 WHERE I1 IS NOT FALSE;
I1
----
TRUE
null
2 rows selected.
gSQL> SELECT * FROM T1 WHERE I1 IS UNKNOWN;
I1
----
null
1 row selected.

```

CASE Expression

Syntax

```

<case expression> ::=
    <simple case>
  | <searched case>
<simple case> ::=
    CASE expr WHEN comparison_expr THEN result
      [ WHEN comparison_expr THEN result ... ]
      [ ELSE result ]
    END
<searched case> ::=
    CASE WHEN condition THEN result

```

```

        [ WHEN condition THEN result ... ]
        [ ELSE result ]
    END

```

Description

WHEN ... THEN clause is evaluated in the order of which is described in the CASE statement.

If a comparison result is FALSE, the subsequent WHEN ... THEN clauses are evaluated until TRUE comes up.

If a comparison result is TRUE, the result is returned, and the evaluation is not executed any more.

- Simple case

The comparison_expr of CASE expr and WHEN ... THEN clause is evaluated as the equal operation. (expr = comparison_expr).

- Searched case

The condition of WHEN ... THEN clause is evaluated.

If all evaluation results of the WHEN clause are FALSE, then result of ELSE clause is returned.

If ELSE clause is omitted, NULL is returned as a result.

If there are multiple types of THEN or ELSE clause results, the result type is determined by **Result Type Combination Rule**.

For more information, refer to the followings.

- COALESCE
- NULLIF

Example

- Simple case

```

gSQL> SELECT I1,
           CASE I1 WHEN 1 THEN 'ONE'
                  WHEN 2 THEN 'TWO'
                  ELSE 'NUMBER'
           END AS CASE_RESULT1,
           CASE I1 WHEN 1 THEN 'ONE'
                  WHEN 2 THEN 'TWO'
           END AS CASE_RESULT2
FROM T1;
I1 CASE_RESULT1 CASE_RESULT2

```



```

-----
 1 ONE          ONE
 2 TWO          TWO
 3 NUMBER      null
3 rows selected.

```

- Searched case

```

gSQL> SELECT I1,
           CASE WHEN I1 = 1 THEN 'ONE'
                WHEN I1 = 2 THEN 'TWO'
                ELSE 'NUMBER'
           END AS CASE_RESULT1,
           CASE WHEN I1 = 1 THEN 'ONE'
                WHEN I1 = 2 THEN 'TWO'
           END AS CASE_RESULT2
FROM T1;
I1 CASE_RESULT1 CASE_RESULT2
-----
 1 ONE          ONE
 2 TWO          TWO
 3 NUMBER      null
3 rows selected.

```

CAST Specification

Syntax

```
CAST( expression AS data_type )
```

Description

CAST converts the expression data type to the data type of the specified data_type.

Example

```

gSQL> SELECT CAST( '1-2' AS INTERVAL YEAR TO MONTH ) AS RESULT FROM DUAL;
RESULT
-----

```

+01-02

1 row selected.

Scalar Subquery Expression

Scalar subquery expression is a subquery which returns a single row with one column as a result. The scalar subquery expression result is the values described in select list of the subquery.

If the subquery does not return any row, then the result value is NULL, and if it returns two or more rows, then an error occurs.

Scalar subquery expression can be described on most position which describes expression. The subquery should be enclosed in parentheses. Even when scalar subquery expression is used as a function argument and the scalar subquery expression is enclosed in parentheses, other parentheses for the subquery is required regardless of the function parentheses. Otherwise, an error occurs

The following is an example of using scalar subquery expression.

```
gSQL> select * from dual where dummy = (select * from dual);
DUMMY
-----
X
1 row selected.
gSQL> select sum(select 1 from dual) from dual;
ERR-42000(40000): syntax error
select sum(select 1 from dual) from dual
.....^    ^
Error at line 1
gSQL> select sum((select 1 from dual)) from dual;
SUM((SELECT 1 FROM DUAL))
-----
1
1 row selected.
```

Compatibility

The SQL standard compatibility for expression is as follows.

Table 11-28 SQL standard compatibility for expression

Feature ID	Description	Availability
E121-03	Value expressions in ORDER BY clause	O
F051-05	Basic date and time Explicit CAST between datetime types and character string types	O
F201	CAST function	O
F261-01	Simple CASE	O
F261-02	Searched CASE	O
F261-03	NULLIF	O
F261-04	COALESCE	O
F263	Comma-separated predicates in simple CASE expression	X
F301	CORRESPONDING in query expressions	X
F385	Drop column generation expression clause	X
F561	Full value expressions	X
F846	Octet support in regular expression operators	X
F847	Nonconstant regular expressions	X
F850	Top-level <order by clause> in <query expression>	O
F855	Nested <order by clause> in <query expression>	O
F856	Nested <fetch first clause> in <query expression>	O
F857	Top-level <fetch first clause> in <query expression>	O
F861	Top-level <result offset clause> in <query expression>	O
F863	Nested <result offset clause> in <query expression>	O
S091-03	Arrays expressions	X
S111	ONLY in query expressions	X
T121	WITH (excluding RECURSIVE) in query expression	X
T581	Regular expression substring function	X

11.5 Pseudo Columns

Pseudo column is not only similar to function, but also it is similar to table column because it can return different value in row unit every time the pseudo column is executed.

Table 11-29 Supported pseudo column

Name	Description	Remarks
CURRVAL	It is a pseudo column which is related to a sequence.	CURRVAL
NEXTVAL	It is a pseudo column which is related to a sequence.	NEXTVAL
ROWNUM	It is the row number which satisfies the condition.	ROWNUM
ROWID	It returns the record identifier in database.	ROWID Pseudo Column
CLUSTER_GROUP_ID	It returns the record identifier in database.	CLUSTER_GROUP_ID Pseudo Column
CLUSTER_MEMBER_ID	It returns the member identifier in which the record is stored.	CLUSTER_MEMBER_ID Pseudo Column
CLUSTER_GROUP_NAME	It returns the group name in which the record is stored.	CLUSTER_GROUP_NAME Pseudo Column
CLUSTER_MEMBER_NAME	It returns the member name in which the record is stored.	CLUSTER_MEMBER_NAME Pseudo Column

ROWID Pseudo Column

ROWID pseudo column is a record identifier, and it returns the identification information of each database record.

ROWID has the following information to identify the location within the database depending on the system.

Standalone system

- OBJECT_ID
- TABLESPACE_ID
- PAGE_ID
- OFFSET in PAGE

Cluster system

- GRID_BLOCK_SEQUENCE
- GRID_BLOCK_ID

- MEMBER_ID
- SHARD_ID

The information stored inside in base 64 encoding is converted into the value such as A-Z, a-z, 0-9, +, / then output when querying ROWID.

Each information to identify the address within database stored in ROWID can be obtained using the ROWID-related functions.

The address of the deleted record can be newly reassigned to the record to be inserted.

ROWID pseudo column can be used only in SELECT operation, but it can not be used in INSERT, UPDATE, DELETE operations.

For more information, refer to **ROWID, ROWID-related Functions**.

The following is an example of querying ROWID pseudo column.

```
gSQL> SELECT ROWID FROM T1;
                ROWID
-----
AAAAAAAAAFpEAACAAAEkAAA
AAAAAAAAAFpEAACAAAEkAAB
AAAAAAAAAFpEAACAAAEkAAC
AAAAAAAAAFpEAACAAAEkAAD
AAAAAAAAAFpEAACAAAEkAAE
5 rows selected.
```

CLUSTER_GROUP_ID Pseudo Column

CLUSTER_GROUP_ID pseudo column returns the group identifier of a server in which the record is stored.

CLUSTER_GROUP_ID pseudo column can perform the SELECT, but it can not perform the INSERT, UPDATE, or DELETE.



This information is valid in the cluster system.

The following is an example of retrieving CLUSTER_GROUP_ID pseudo column.

```
gSQL> SELECT T1.C1, T1.CLUSTER_GROUP_ID FROM T1;
C1 T1.CLUSTER_GROUP_ID
-- -----
A          1
B          2
C          3
3 rows selected.
```

CLUSTER_MEMBER_ID Pseudo Column

CLUSTER_MEMBER_ID pseudo column returns the member identifier of a server in which the record is stored.

CLUSTER_MEMBER_ID pseudo column can perform the SELECT, but it can not perform the INSERT, UPDATE, or DELETE.



This information is valid in the cluster system.

The following is an example of retrieving CLUSTER_MEMBER_ID pseudo column.

```
gSQL> SELECT T1.C1, T1.CLUSTER_MEMBER_ID FROM T1;
C1 T1.CLUSTER_MEMBER_ID
-- -----
A          1
B          3
C          5
3 rows selected.
```

CLUSTER_GROUP_NAME Pseudo Column

CLUSTER_GROUP_NAME pseudo column returns the group name of a server in which the record is stored.

CLUSTER_GROUP_NAME pseudo column can perform the SELECT, but it can not perform the INSERT, UPDATE, or DELETE.



This information is valid in the cluster system.

The following is an example of retrieving CLUSTER_GROUP_NAME pseudo column.

```
gSQL> SELECT T1.C1, T1.CLUSTER_GROUP_NAME FROM T1;
C1 T1.CLUSTER_GROUP_NAME
-- -----
A  G1
B  G2
C  G3
3 rows selected.
```

CLUSTER_MEMBER_NAME Pseudo Column

CLUSTER_MEMBER_NAME pseudo column returns the member name of a server in which the record is stored.

CLUSTER_MEMBER_NAME pseudo column can perform the SELECT, but it can not perform the INSERT, UPDATE, or DELETE.



This information is valid in the cluster system.

The following is an example of retrieving CLUSTER_MEMBER_NAME pseudo column.

```
gSQL> SELECT T1.C1, T1.CLUSTER_MEMBER_NAME FROM T1;
C1 T1.CLUSTER_MEMBER_NAME
-- -----
A  G1N1
B  G2N1
C  G3N1
3 rows selected.
```

Compatibility

The SQL standard compatibility for pseudo column is as follows.

Table 11-30 SQL standard compatibility for pseudo column

Feature ID	Description	Availability
T176	Sequence generator support	O
T177	Sequence generator support: simple restart option	O

11.6 Operators

An operator is represented by one or more specific symbols or keywords, and it performs an operation using one or more arguments.

The operator types are various as follows.

- Arithmetic operator
- Concatenation operator
- Set operator

Arithmetic Operator

Syntax

```

<arithmetic operator> ::=
    <value term>
    | <expression> + <value term>
    | <expression> - <value term>
<value term> ::=
    <value factor>
    | <value term> * <value factor>
    | <value term> / <value factor>
<value factor> ::=
    <expression>
    | + <expression>
    | - <expression>
  
```

Description

An arithmetic operator performs an arithmetic operation of the numeric types, date/time types or interval types.

The arithmetic operator precedence is as follows.

1. + (POSITIVE), - (NEGATIVE)
2. * (MULTIPLICATION), / (DIVISION)
3. + (ADDITION), - (SUBTRACTION)

Concatenation Operator

Syntax

```
<concatenation operator> ::=
    <expression> || <expression>
```

Description

A concatenation operator returns strings which connect between values of CHARACTER STRING type or BINARY STRING type.

For more information, refer to **|| (CONCATENATE), CONCATENATE**.

Set Operator

Syntax

```
<set operator> ::=
    <set operator term>
    | <subquery> UNION [ ALL | DISTINCT ] <set operator term>
    | <subquery> EXCEPT [ ALL | DISTINCT ] <set operator term>
    | <subquery> MINUS [ ALL | DISTINCT ] <set operator term>
<set operator term> ::=
    <subquery>
    | <subquery> INTERSECT [ ALL | DISTINCT ] <set operator term>
```

Description

A set operator performs a set operation of the subquery results.

For more information, refer to **set operator**.

INTERSECT ALL/DISTINCT has a higher precedence than other set operators.

Table 11-31 Set operators

Operator	Description
UNION ALL	It is the union which does not exclude duplicated rows of the subquery result.
UNION DISTINCT	It is the union which excludes duplicated rows of the subquery result.
EXCEPT ALL	It is the difference set which does not exclude duplicated rows of the subquery result.

Operator	Description
EXCEPT DISTINCT	It is the difference set which excludes duplicated rows of the subquery result.
MINUS ALL	It is as same as EXCEPT ALL.
MINUS DISTINCT	It is as same as EXCEPT DISTINCT.
INTERSECT ALL	It is the intersection which does not exclude duplicated rows of the subquery result.
INTERSECT DISTINCT	It is the intersection which excludes duplicated rows of the subquery result.

Compatibility

The SQL standard compatibility for operator is as follows.

Table 11-32 SQL standard compatibility for operator

Feature ID	Description	Availability
E011-04	Arithmetic operators	O
E021-07	Character concatenation	O
E071-01	UNION DISTINCT table operator	O
E071-02	UNION ALL table operator	O
E071-03	EXCEPT DISTINCT table operator	O
E071-05	Columns combined via table operators need not have exactly the same data type	O
E071-06	Table operators in subqueries	O
F041-08	All comparison operators are supported (rather than just =)	O
F302-01	INTERSECT DISTINCT table operator	O
F302-02	INTERSECT ALL table operator	O
F304	EXCEPT ALL table operator	O
F846	Octet support in regular expression operators	X
J571	NEW operator	X

11.7 Functions

Functions and operators are similar in features. However, to represent arguments, functions use parentheses after its name. A function can have zero or more arguments.

The function has two types as follows.

- Single row function
- Aggregate function

Single Row Function

Single row function creates a single result row for each row in the table or view.

The single row functions are as follows.

- Numeric function
- Character string function returning character values
- Character string function returning number values
- Datetime function
- General comparison function
- Conversion function
- Conditional function
- NULL-related function
- ROWID-related function
- Encryption function
- System information function

Numeric Functions

A numeric value is input in numeric function, and the numeric function returns a numeric result.

For more information about the numeric function types, refer to the followings.

- **ABS**
- **ACOS**
- **ASIN**
- **ATAN**
- **ATAN2**
- **BITAND**

- BITNOT
- BITOR
- BITXOR
- CBRT
- CEIL
- COS
- COT
- DEGREES
- EXP
- FACTORIAL
- FLOOR
- LN
- LOG
- MOD
- PI
- POWER
- RADIANS
- RANDOM
- ROUND(number)
- SHARD_ID
- SHIFT_LEFT
- SHIFT_RIGHT
- SIGN
- SIN
- SQRT
- TAN
- TRUNC(number)
- WIDTH_BUCKET

Character String Functions Returning Character Values

A character string type value is input in character string functions returning character values, and the function returns the result of character string type.

For more information about character string functions returning character values types, refer to the following.

- CHR
- CONCAT
- CONCATENATE
- INITCAP
- LOWER

- LPAD
- LTRIM
- OVERLAY
- REPEAT
- REPLACE
- REVERSE
- RPAD
- RTRIM
- SPLIT_PART
- SUBSTR
- SUBSTRB
- TRANSLATE
- TRIM
- UPPER

Character String Functions Returning Number Values

A character string type value is input in character string functions returning number values the value, and the function returns the result of number type.

For more information about character string functions returning number values types, refer to the followings.

- ASCII
- BIT_LENGTH
- BYTE_LENGTH
- CHAR_LENGTH
- INSTR
- LENGTH
- LENGTHB
- OCTET_LENGTH
- POSITION

Datetime Functions

The value of date/time/timestamp/interval type is input in datetime function, and the function returns the result of date/time/timestamp/interval type.

For more information about datetime functions types, refer to the followings.

- ADDDATE
- ADDTIME

- ADD_MONTHS
- DATEADD
- DATEDIFF
- DATE_ADD
- DATE_PART
- EXTRACT
- LAST_DAY
- MONTHS_BETWEEN

General Comparison Functions

General comparison function returns a minimum value or a maximum value for the value set.

For more information about general comparison function types, refer to the followings.

- GREATEST
- LEAST

Conversion Functions

Conversion function sets the value of a particular data type.

For more information about conversion function types, refer to the followings.

- TO_CHAR(datetime)
- TO_CHAR(number)
- TO_DATE
- TO_NATIVE_DOUBLE
- TO_NATIVE_REAL
- TO_NUMBER
- TO_TIME
- TO_TIME_TZ
- TO_TIME_WITH_TIME_ZONE
- TO_TIMESTAMP
- TO_TIMESTAMP_TZ
- TO_TIMESTAMP_WITH_TIME_ZONE

Conditional Functions

Conditional function returns a result of specific value depending on a condition.

For more information about conditional function types, refer to the followings.

- CASE2
- DECODE

NULL-related Functions

NULL-related function returns a result of specific value depending on whether the input value is a NULL value.

For more information about null-related function types, refer to the followings.

- COALESCE
- NULLIF
- NVL
- NVL2

ROWID-related Functions

ROWID-related function is used to obtain information about the ROWID.

For more information about ROWID-related function types, refer to the followings.

- Valid functions in standalone
 - ROWID_OBJECT_ID
 - ROWID_TABLESPACE_ID
 - ROWID_PAGE_ID
 - ROWID_ROW_NUMBER
- Valid functions in cluster
 - ROWID_GRID_BLOCK_ID
 - ROWID_GRID_BLOCK_SEQ
 - ROWID_MEMBER_ID
 - ROWID_SHARD_ID

Encryption Functions

Encryption function encrypt, decrypts, or hashes the given plain text by using the specific algorithm, then returns the result.

For more information about the encryption function, refer to **DIGEST**.

System Information Functions

System information function is used to obtain information about sessions and the system.

For more information about system information function type, refer to the followings.

- CLOCK_DATE
- CLOCK_LOCALTIME
- CLOCK_LOCALTIMESTAMP
- CURRENT_CATALOG
- CURRENT_DATE
- CURRENT_SCHEMA
- CURRENT_TIME
- CURRENT_TIMESTAMP
- CURRENT_USER
- LAST_IDENTITY_VALUE
- LOCALTIME
- LOCALTIMESTAMP
- LOGON_USER
- SESSION_ID
- SESSION_SERIAL
- SESSION_USER
- STATEMENT_DATE
- STATEMENT_LOCALTIME
- STATEMENT_LOCALTIMESTAMP
- STATEMENT_TIME
- STATEMENT_TIMESTAMP
- STATEMENT_VIEW_SCN
- SYSDATE
- SYSTIME
- SYSTIMESTAMP
- TRANSACTION_DATE
- TRANSACTION_LOCALTIME
- TRANSACTION_LOCALTIMESTAMP
- TRANSACTION_TIME
- TRANSACTION_TIMESTAMP
- USER_ID
- VERSION

Aggregate Function

Aggregate function creates a single result row for multiple rows.

For more information about aggregate function types, refer to the followings.

- COUNT
- COUNT(*)
- SUM
- AVG
- MIN
- MAX
- STDDEV
- STDDEV_POP
- STDDEV_SAMP
- VAR_POP
- VAR_SAMP
- VARIANCE

Compatibility

The SQL standard compatibility for function is as follows.

Table 11-33 SQL standard compatibility for function

Feature ID	Description	Availability
B033	Untyped SQL-invoked function arguments	X
E021-04	CHARACTER_LENGTH function	O
E021-05	OCTET_LENGTH function	O
E021-06	SUBSTRING function	O
E021-08	UPPER and LOWER functions	O
E021-09	TRIM function	O
E021-11	POSITION function	O
E091-01	AVG	O
E091-02	COUNT	O
E091-03	MAX	O
E091-04	MIN	O
E091-05	SUM	O
E091-06	ALL quantifier	O
E091-07	DISTINCT quantifier	O

Feature ID	Description	Availability
F131-03	Set functions supported in queries with grouped views	O
F201	CAST function	O
F441	Extended set function support	X
F442	Mixed column references in set functions	X
F801	Full set function	X
F842	OCCURRENCES_REGEX function	X
F843	POSITION_REGEX function	X
S071	SQL paths in function and type name resolution	X
S201-02	Array as result type of functions	X
S211	User-defined cast functions	X
S241	Transform functions	X
T041-03	POSITION, LENGTH, LOWER, TRIM, UPPER, and SUBSTRING functions for LOB data types	X
T312	OVERLAY function	O
T321-01	User-defined functions with no overloading	X
T326	Table functions	X
T341	Overloading of SQL-invoked functions and SQL-invoked procedures	X
T433	Multiargument GROUPING function	X
T441	ABS and MOD functions	O
T571	Array-returning external SQL-invoked functions	X
T572	Multiset-returning external SQL-invoked functions	X
T581	Regular expression substring function	X
T614	NTILE function	X
T615	LEAD and LAG functions	X
T616	Null treatment option for LEAD and LAG functions	X
T617	FIRST_VALUE and LAST_VALUE functions	X
T618	NTH_VALUE function	X
T619	Nested window functions	X
T621	Enhanced numeric functions	O

11.8 Conditions

Condition

Condition is an expression which is evaluated as TRUE, FALSE, UNKNOWN.

Condition can be used in the following SQL statements.

- WHERE clauses in DELETE, UPDATE statements
- WHERE and HAVING clauses in SELECT statement
- Where the BOOLEAN TYPE can be used

The condition types are as follows.

- Comparison condition
- Logical condition
- Null condition
- Compound condition
- Pattern-matching condition
- Between condition
- In condition
- Exists condition

Table 11-34 Condition precedence

Precedence	Condition type
1	Operators in condition clauses
2	=, !=, <, >, <=, >=
3	IS [NOT] NULL, [NOT] BETWEEN, [NOT] IN, LIKE, EXISTS
4	NOT
5	AND
6	OR

Comparison Conditions

It compares both conditional expressions, and returns the boolean type of TRUE, FALSE, UNKNOWN values.

Table 11-35 Comparison conditions

Condition	Description
=	It checks if both conditions are equal.
!=, <>	It checks if both conditions are not equal.
>	It compares which one of both conditions is bigger.
<	It compares which one of both conditions is smaller.
>=	It compares which one of both conditions is bigger or equal.
<=	It compares which one of both conditions is smaller or equal.
ANY, SOME	If there is a condition whose left expr satisfies at least one of right expr_list (or subquery results), then it returns TRUE. If there is not right subquery result, then it returns FALSE.
ALL	If there is a condition whose left expr satisfies all right expr_list (or subquery results), then it returns TRUE. If there is not right subquery result, then it returns TRUE.

For more information, refer to **Type Comparison**.

< Simple Comparison Conditions >

Syntax

```

<simple_comparison_condition> ::=
    <expr>          <comparison_operator> <expr>
  | <expr>          <comparison_operator> ( <subquery> )
  | ( <subquery> ) <comparison_operator> <expr>
  | ( <subquery> ) <comparison_operator> ( <subquery> )
  | ( <expr_list> ) <comparison_operator> ( <expr_list> )
  | ( <expr_list> ) <comparison_operator> ( <subquery> )
  | ( <subquery> ) <comparison_operator> ( <expr_list> )
  | ( <subquery> ) <comparison_operator> ( <subquery> )

<comparison_operator> ::=
    < = >
  | < != >
  | < < >
  | < > >
  | < <= >
  | < >= >

<expr_list> ::=
    <expr>
  | <expr>, ... , <expr>
  | ( <expr> )

```

```
| ( <expr> , ... , <expr> )
```

For more information, refer to [Scalar Subquery Expression](#).

Description

If the expr list or subquery comes to both left and right of comparison_operator, then the number of expr or subquery target to be compared should be same.

If there is a subquery, the number of result record should be one.

Example

Table 11-36 Example of simple comparison conditions

Conditional expression	Result
'abc' = 'abc'	TRUE
'abc' != 'abc'	FALSE
'abc' < 'abc'	FALSE
'abc' <= 'abc'	TRUE
'abc' > 'abc'	FALSE
'abc' >= 'abc'	TRUE
(1, 2, 3) = (1, 2, 3)	TRUE
(1, 2, 3) = (1, 2, 4)	FALSE
(1, 2, 3) != (4, 5, 6)	TRUE
(1, 2, 3) != (1, 2, 3)	FALSE
(1, 2, 3) < (1, 2, 4)	TRUE
(1, 2, 3) < (1, 2, 3)	FALSE
(1, 2, 3) <= (1, 2, 4)	TRUE
(1, 2, 3) <= (1, 2, 2)	FALSE
(1, 2, 3) > (1, 2, 2)	TRUE
(1, 2, 3) > (1, 2, 4)	FALSE
(1, 2, 3) >= (1, 2, 2)	TRUE
(1, 2, 3) >= (1, 2, 4)	FALSE

<Group Comparison Conditions>

Syntax

```
<group_comparison_condition> ::=
    <expr>          <comparison_operator> <quantifier> ( <expr_list> )
  | <expr>          <comparison_operator> <quantifier> ( <subquery> )
  | ( <expr_list> ) <comparison_operator> <quantifier> ( <expr_list_list> )
```

```

| ( <expr_list> ) <comparison_operator> <quantifier> ( <subquery> )
| ( <subquery> ) <comparison_operator> <quantifier> ( <expr_list> )
| ( <subquery> ) <comparison_operator> <quantifier> ( <expr_list_list> )
| ( <subquery> ) <comparison_operator> <quantifier> ( <subquery> )
<comparison_operator> ::=
    < = >
    | < != >
    | < < >
    | < > >
    | < <= >
    | < >= >
<quantifier> ::=
    ALL
    | ANY
    | SOME
<expr_list> ::=
    <expr>
    | <expr>, ... , <expr>
    | ( <expr> )
    | ( <expr> , ... , <expr> )
<expr_list_list> ::=
    <expr_list>
    | <expr_list>, ... , <expr_list>

```

For more information, refer to [Scalar Subquery Expression](#).

Description

If the expr list or subquery comes to both left and right of comparison_operator, then the number of expr or subquery target to be compared should be same.

If a subquery comes to the left of comparison_operator, the number of result record should be one.

If a subquery comes to the right of comparison_operator, the number of result record can be multiple.

Example

Table 11-37 Example of group comparison conditions

Conditional expression	Result
1 =any (1, 2, 3, 4, 5)	TRUE
1 =any (1, 2, null, 4, 5)	TRUE
1 =any (2, null, 4, 5)	NULL
1 =any (100, 2, 3, 4, 5)	FALSE
1 =all (1, +1, 1E+0)	TRUE

Conditional expression	Result
1 =all (1, +1, 1E+0, null)	NULL
1 =all (1, 2, 3, 4, 5)	FALSE
(1, 2) =any ((0, 1), (1, 2), (3, 4))	TRUE
(1, 2) =any ((0, 1), (1, 2), (null, null))	TRUE
(1, 2) =any ((0, 1), (2, 3), (3, 4))	FALSE
(1, 2) =all ((1, 2), (+1, +2), (1E+0, 2E+0))	TRUE
(1, 2) =all ((1, 2), (+1, +2), (null, null))	NULL
(1, 2) =all ((0, 1), (2, 3), (3, 4))	FALSE
When the result record of comparison_operator's right subquery is 0	
('X') =any (select dummy from dual where dummy = 'Y')	FALSE
('X') =all (select dummy from dual where dummy = 'Y')	TRUE

Logical Conditions

Logical conditions are such as AND, OR, NOT.

AND

Syntax

| <boolean value expression> AND <boolean value expression>

Description

Table 11-38 Truth table of AND boolean operator

AND	True	False	Unknown
True	True	False	Unknown
False	False	False	False
Unknown	Unknown	False	Unknown

OR

Syntax

| <boolean value expression> OR <boolean value expression>

Description

Table 11-39 Truth table of OR boolean operator

OR	True	False	Unknown
True	True	True	True
False	True	False	Unknown
Unknown	True	Unknown	Unknown

NOT

Syntax

| NOT <boolean value expression>

Description

Table 11-40 Truth table of NOT boolean operator

expr	NOT
True	False
False	True
Unknown	Unknown

Null Condition

Syntax

| <expr> IS [NOT] NULL

Description

It checks whether the result value of expr is NULL.

Table 11-41 Result table of IS NULL condition

expr	IS NULL	IS NOT NULL
NULL	True	False
NOT NULL	False	True

Example

```
gSQL> SELECT 'hello%' LIKE 'h%o!%' ESCAPE '!' AS RESULT FROM DUAL;
RESULT
-----
TRUE
• 'represent' LIKE 'represent' => TRUE
• 'represent' LIKE ' represent ' => FALSE
• 'represent' LIKE 'REPRESENT' => FALSE
• 'represent' LIKE 'r_pr_s_nt' => TRUE
• 'represent' LIKE 're%t' => TRUE
• 'represent' LIKE 'rep' => FALSE
• 'summer_vacation' LIKE 'summer\_vacation' ESCAPE '\\' => TRUE
• NULL LIKE 'summer\_vacation' ESCAPE '\\' => NULL
• 'summer_vacation' LIKE NULL ESCAPE '\\' => NULL
• 'summer_vacation' LIKE 'summer\_vacation' ESCAPE NULL => NULL
```

BETWEEN Condition

Syntax

```
<between condition> ::=
  <expr1> [ NOT ] BETWEEN [ ASYMMETRIC | SYMMETRIC ] <expr2> AND <expr3>
```

Description

It checks whether `expr1` is within the range between `expr2` and `expr3`.

If `ASYMMETRIC` or `SYMMETRIC` is omitted, the default is `ASYMMETRIC`.

If data types among `expr1`, `expr2`, `expr3` are different, they are converted.

For more information, refer to [Type Comparison](#), [Type Conversion](#).

Table 11-42 Equivalence of between conditions

A	B
X BETWEEN ASYMMETRIC Y AND Z	X BETWEEN Y AND Z
X BETWEEN Y AND Z	X >= Y AND X <= Z
X NOT BETWEEN Y AND Z	NOT(X BETWEEN Y AND Z)
X BETWEEN SYMMETRIC Y AND Z	((X BETWEEN Y AND Z) OR (X BETWEEN Z AND Y))
X NOT BETWEEN SYMMETRIC Y AND Z	NOT(X BETWEEN SYMMETRIC Y AND Z)

Example

Table 11-43 Example of between condition

	Conditional expression	Result
BETWEEN [ASYMMETRIC]	3 BETWEEN 1 AND 5	TRUE
	NULL BETWEEN 1 AND 5	NULL
	3 BETWEEN NULL AND 5	
	3 BETWEEN 1 AND NULL	
	3 BETWEEN 5 AND 1	FALSE
BETWEEN SYMMETRIC	3 BETWEEN SYMMETRIC 1 AND 5	TRUE
	NULL BETWEEN SYMMETRIC 1 AND 5	NULL
	3 BETWEEN SYMMETRIC NULL AND 5	
	3 BETWEEN SYMMETRIC 1 AND NULL	
	3 BETWEEN SYMMETRIC 5 AND 1	TRUE

IN Condition

Syntax

```

<in_condition> ::=
    <expr>          [NOT] IN ( <expr_list> )
  | <expr>          [NOT] IN ( <subquery> )
  | ( <expr_list> ) [NOT] IN ( <expr_list_list> )
  | ( <expr_list> ) [NOT] IN ( <subquery> )
  | ( <subquery> ) [NOT] IN ( <expr_list> )
  | ( <subquery> ) [NOT] IN ( <expr_list_list> )
  | ( <subquery> ) [NOT] IN ( <subquery> )

<expr_list> ::=
    <expr>
  | <expr>, ... , <expr>
  | ( <expr> )
  | ( <expr> , ... , <expr> )

<expr_list_list> ::=
    <expr_list>
  | <expr_list>, ... , <expr_list>

```

Description

IN condition returns the same result as = ANY.

NOT IN condition returns the same result as !=ALL.

For more information, refer to **Comparison Conditions**.

Example

Table 11-44 Example of IN condition

Conditional expression	Result
1 IN (1, 2, 3, 4, 5)	TRUE
1 IN (1, 2, null, 4, 5)	TRUE
1 IN (2, null, 4, 5)	NULL
1 IN (100, 2, 3, 4, 5)	FALSE
NULL IN (1, 2, 3)	NULL
1 NOT IN (2, 3, 4, 5)	TRUE
1 NOT IN (2, null, 4, 5)	NULL
1 NOT IN (1, 2, null, 4, 5)	FALSE
1 NOT IN (100, 2, 3, 4, 5)	TRUE
NULL NOT IN (1, 2, 3)	NULL

EXISTS Condition

Syntax

```
exists_conditions ::=
    EXISTS ( subquery )
```

Description

It checks whether the result record of subquery exists.

If the result record of subquery exists, it returns TRUE. Otherwise, it returns FALSE.

Example

```

gSQL> SELECT * FROM DUAL WHERE EXISTS ( SELECT * FROM DUAL );
      DUMMY
      -----
      X
1 row selected.
gSQL> SELECT * FROM DUAL
      WHERE EXISTS ( SELECT * FROM DUAL WHERE DUMMY = 'Y' );
no rows selected.

```

Compatibility

The SQL standard compatibility for condition is as follows.

Table 11-45 SQL standard compatibility for condition

Feature ID	Description	Availability
E061-01	Comparison predicate	O
E061-02	BETWEEN predicate	O
E061-03	IN predicate with list of values	O
E061-04	LIKE predicate	O
E061-05	LIKE predicate: ESCAPE clause	O
E061-06	NULL predicate	O
E061-07	Quantified comparison predicate	O
E061-08	EXISTS predicate	O
E061-09	Subqueries in comparison predicate	O
E061-11	Subqueries in IN predicate	O
E061-12	Subqueries in quantified comparison predicate	O
E061-13	Correlated subqueries	O
E061-14	Search condition	O
F051-04	Comparison predicate on DATE, TIME, and TIMESTAMP data types	X
F053	OVERLAPS predicate	X
F263	Comma-separated predicates in simple CASE expression	X
F291	UNIQUE predicate	X
F481	Expanded NULL predicate	O
F841	LIKE_REGEX predicate	X
P008	Comma-separated predicates in a CASE statement Extended CASE	X
S151	Type predicate	X
T141	SIMILAR predicate	X

Feature ID	Description	Availability
T151	DISTINCT predicate	X
T152	DISTINCT predicate with negation	X
T461	Symmetric BETWEEN predicate	O
T501	Enhanced EXISTS predicate	X
T631	IN predicate with one list element	X
X090	XML document predicate	X
X091	XML content predicate	X
X141	IS VALID predicate: data-driven case	X
X142	IS VALID predicate: ACCORDING TO clause	X
X143	IS VALID predicate: ELEMENT clause	X
X144	IS VALID predicate: schema location	X
X145	IS VALID predicate outside check constraints	X
X151	IS VALID predicate with DOCUMENT option	X
X152	IS VALID predicate with CONTENT option	X
X153	IS VALID predicate with SEQUENCE option	X
X155	IS VALID predicate: NAMESPACE without ELEMENT clause	X
X157	IS VALID predicate: NO NAMESPACE with ELEMENT clause	X

11.9 Built-in Data Type References

Aliases of Built-in Data Types

- BIGINT
 - It is as same as NUMBER(19,0).
 - Refer to **NUMBER**
- BINARY
 - Refer to **BINARY**
- BINARY VARYING
 - Refer to **BINARY VARYING**
- BINARY LONG VARYING
 - Refer to **BINARY LONG VARYING**
- BOOLEAN
 - Refer to **BOOLEAN**
- CHAR
 - It is as same as CHARACTER.
 - Refer to **CHARACTER**
- CHARACTER
 - Refer to **CHARACTER**
- CHARACTER VARYING
 - Refer to **CHARACTER VARYING**
- CHARACTER LONG VARYING
 - Refer to **CHARACTER LONG VARYING**
- DATE
 - Refer to **DATE**
- DEC
 - It is as same as NUMERIC.
 - Refer to **NUMERIC**
- DECIMAL
 - It is as same as NUMERIC.
 - Refer to **NUMERIC**
- DOUBLE
 - It is as same as FLOAT(53).
 - Refer to **FLOAT**
- DOUBLE PRECISION
 - It is as same as FLOAT(53).
 - Refer to **FLOAT**
- FLOAT

- Refer to **FLOAT**
- **FLOAT4**
 - It is as same as **FLOAT(24)**.
 - Refer to **FLOAT**
- **FLOAT8**
 - It is as same as **FLOAT(53)**.
 - Refer to **FLOAT**
- **INT**
 - It is as same as **NUMBER(10,0)**.
 - Refer to **NUMBER**
- **INT2**
 - It is as same as **NUMBER(5,0)**.
 - Refer to **NUMBER**
- **INT4**
 - It is as same as **NUMBER(10,0)**.
 - Refer to **NUMBER**
- **INT8**
 - It is as same as **NUMBER(19,0)**.
 - Refer to **NUMBER**
- **INTEGER**
 - It is as same as **NUMBER(10,0)**.
 - Refer to **NUMBER**
- **INTERVAL**
 - Refer to **INTERVAL**
- **LONG BINARY VARYING**
 - It is as same as **BINARY LONG VARYING**.
 - Refer to **BINARY LONG VARYING**
- **LONG CHAR VARYING**
 - It is as same as **CHARACTER LONG VARYING**.
 - Refer to **CHARACTER LONG VARYING**
- **LONG CHARACTER VARYING**
 - It is as same as **CHARACTER LONG VARYING**.
 - Refer to **CHARACTER LONG VARYING**
- **LONG VARCHAR**
 - It is as same as **CHARACTER LONG VARYING**.
 - Refer to **CHARACTER LONG VARYING**
- **NATIVE_BIGINT**
 - Refer to **NATIVE_BIGINT**
- **NATIVE_DOUBLE**
 - Refer to **NATIVE_DOUBLE**
- **NATIVE_INTEGER**

- Refer to **NATIVE_INTEGER**
- **NATIVE_REAL**
 - Refer to **NATIVE_REAL**
- **NATIVE_SMALLINT**
 - Refer to **NATIVE_SMALLINT**
- **NUMBER**
 - Refer to **NUMBER**
- **NUMERIC**
 - Refer to **NUMERIC**
- **ROWID**
 - Refer to **ROWID**
- **SMALLINT**
 - It is as same as **NUMBER(5,0)**.
 - Refer to **NUMBER**
- **TIME**
 - Refer to **TIME**
- **TIMESTAMP**
 - Refer to **TIMESTAMP**
- **VARBINARY**
 - It is as same as **BINARY VARYING**.
 - Refer to **BINARY VARYING**
- **VARCHAR**
 - It is as same as **CHARACTER VARYING**.
 - Refer to **CHARACTER VARYING**
- **VARCHAR2**
 - It is as same as **CHARACTER VARYING**.
 - Refer to **CHARACTER VARYING**

BINARY

Syntax

BINARY [(length)]

Syntax Rules and Parameters

- length: It is the binary string length.
 - Range: 1 ~ 2000
 - Default value: 1

Description

A fixed-length binary string is stored.

If the binary string length to be stored is shorter than the specified length, 'X'00' is stored in the remaining part.

- Storage size: Bytes of the length value

For More Information

Refer to the followings.

- **BINARY VARYING**
- **BINARY LONG VARYING**

BINARY VARYING

Syntax

BINARY VARYING (length)

Syntax Rules and Parameters

- length: It is the maximum length of binary string.
 - Range: 1 ~ 4000

Description

The variable-length binary string is stored.

- Storage size: Bytes of the binary string to be stored
- Alias names: VARBINARY

For More Information

Refer to the followings.

- **BINARY**
- **BINARY LONG VARYING**

BINARY LONG VARYING

Syntax

BINARY LONG VARYING

Description

The value of the long variable binary string is stored.

- Maximum storage size: 100 megabytes
- Storage size: Bytes of the binary string to be stored
- Alias names: LONG BINARY VARYING, LONG VARBINARY

It can not be used as a column of the key, so there are limitations as follows.

- It can not be used as a key column of an index.
- It can not be used as the expression of ORDER BY clause.
- It can not be used as the expression of GROUP BY clause.
- It can not be used as the expression of DISTINCT clause.
- It can not be used as the expression of UNION, INTERSECT, EXCEPT clauses.

For More Information

Refer to the followings.

- **BINARY**
- **BINARY VARYING**

BOOLEAN

Syntax

BOOLEAN

Description

TRUE or FALSE is stored.

- Storage size: 1 byte.

CHARACTER

Syntax

CHARACTER [(length [CHARACTERS | OCTETS | CHAR | BYTE])]

Syntax Rules and Parameters

- length: It is the string length.
 - Range: 1 ~ 2000
 - Default value: 1
- [CHARACTERS | OCTETS | CHAR | BYTE]: It is unit of length.
 - CHARACTERS
 - The number of characters
 - CHAR is as same as CHARACTERS.
 - OCTETS
 - The number of bytes
 - BYTE is as same as OCTETS.
 - If omitted, the default is the property value of **CHAR_LENGTH_UNITS** which is set when creating database.

Description

A fixed-length string is stored.

If the length of the string to be stored is shorter than the specified length, white spaces are stored in the remaining part.

- Storage size: Bytes of the length value
- Alias names: CHAR

For More Information

Refer to the followings.

- **CHARACTER VARYING**
- **CHARACTER LONG VARYING**

CHARACTER VARYING

Syntax

```
CHARACTER VARYING ( length [ CHARACTERS | OCTETS | CHAR | BYTE ] )
```

Syntax Rules and Parameters

- length: It is the string length.
 - Range: 1 ~ 4000
- [CHARACTERS | OCTETS | CHAR | BYTE]: It is unit of length.
 - CHARACTERS
 - The number of characters
 - CHAR is as same as CHARACTERS.
 - OCTETS
 - The number of bytes
 - BYTE is as same as OCTETS.
 - If omitted, the default is the property value of **CHAR_LENGTH_UNITS** which is set when creating database.

Description

The variable-length string is stored.

- Storage size: Bytes of the string to be stored
- Alias names: VARCHAR, VARCHAR2

For More Information

Refer to the followings.

- CHARACTER
- CHARACTER LONG VARYING

CHARACTER LONG VARYING

Syntax

CHARACTER LONG VARYING

Description

The value of the long variable-length string is stored.

- Maximum storage size: 100 megabytes
- Storage size: Bytes of the string to be stored
- Alias names: LONG CHARACTER VARYING, LONG CHAR VARYING, LONG VARCHAR

It can not be used as a column of the key, so there are limitations as follows.

- It can not be used as a key column of an index.
- It can not be used as the expression of ORDER BY clause.
- It can not be used as the expression of GROUP BY clause.
- It can not be used as the expression of DISTINCT clause.
- It can not be used as the expression of UNION, INTERSECT, EXCEPT clauses.

For More Information

Refer to the followings.

- CHARACTER
- CHARACTER VARYING

DATE

Syntax

DATE

Description

It is the date type including YEAR, MONTH, DAY, HOUR, MINUTE and SECOND (excluding fractional seconds).

- Value range: Date value between '4714-11-24 BC' and '9999-12-31 AD'
- Storage size: 8 bytes

For More Information

Refer to the followings.

- [Date Literals](#)
- [TIME](#)
- [TIMESTAMP](#)

FLOAT

Syntax

`FLOAT[(precision)]`

Syntax Rules and Parameters

- precision: It is the binary precision of significant digits.
 - Precision range: 1 ~ 126
 - Default value: 126

Description

The floating point value with a binary precision is stored.

- Exponential range: 1E-130 ~ 1E+125
- Storage size: (number of digits in integer part+ 1) / 2 + (number of digits in fractional part + 1) / 2 + 1(exponent, sign)

It has a binary precision value unlike **NUMBER**, **NUMERIC** types.

- Alias names: REAL = FLOAT(24), DOUBLE = FLOAT(53), DOUBLE PRECISION = FLOAT(53), FLOAT4 = FLOAT(24), FLOAT8 = FLOAT(53).

For More Information

Refer to the followings.

- **NUMBER**
- **NUMERIC**

INTERVAL

Syntax

```

<interval_type> ::=
    INTERVAL YEAR [ ( leading_precision ) ]
  | INTERVAL MONTH [ ( leading_precision ) ]
  | INTERVAL DAY [ ( leading_precision ) ]
  | INTERVAL HOUR [ ( leading_precision ) ]
  | INTERVAL MINUTE [ ( leading_precision ) ]
  | INTERVAL SECOND [ ( leading_precision [ , fractional_seconds_precision ] ) ]
  | INTERVAL YEAR [ ( leading_precision ) ] TO MONTH
  | INTERVAL DAY [ ( leading_precision ) ] TO HOUR
  | INTERVAL DAY [ ( leading_precision ) ] TO MINUTE
  | INTERVAL DAY [ ( leading_precision ) ] TO SECOND [ ( fractional_seconds_precision ) ]
  | INTERVAL HOUR [ ( leading_precision ) ] TO MINUTE
  | INTERVAL HOUR [ ( leading_precision ) ] TO SECOND [ ( fractional_seconds_precision ) ]
  | INTERVAL MINUTE [ ( leading_precision ) ] TO SECOND [ ( fractional_seconds_precision ) ]

```

Syntax Rules and Parameters

- INTERVAL YEAR [(leading_precision)]: A period of YEAR is stored.
 - leading_precision
 - The number of digits in YEAR
 - Value range: 2 ~ 6
 - Default value: 2
- INTERVAL MONTH [(leading_precision)]: A period of MONTH is stored.
 - leading_precision
 - The number of digits in MONTH
 - Value range: 2 ~ 6
 - Default value: 2
- INTERVAL YEAR [(leading_precision)] TO MONTH: A period of YEAR and MONTH is stored.
 - leading_precision
 - The number of digits in YEAR
 - Value range: 2 ~ 6
 - Default value: 2
- INTERVAL DAY [(leading_precision)]: A period of DAY is stored.

- leading_precision
 - The number of digits in DAY
 - Value range: 2 ~ 6
 - Default value: 2
- INTERVAL HOUR [(leading_precision)]: A period of HOUR is stored.
 - leading_precision
 - The number of digits in HOUR
 - Value range: 2 ~ 6
 - Default value: 2
- INTERVAL MINUTE [(leading_precision)]: A period of MINUTE is stored.
 - leading_precision
 - The number of digits in MINUTE
 - Value range: 2 ~ 6
 - Default value: 2
- INTERVAL SECOND [(leading_precision [, fractional_seconds_precision])]: A period of SECOND is stored.
 - leading_precision
 - The number of digits in SECOND
 - Value range: 2 ~ 6
 - Default value: 2
 - fractional_seconds_precision
 - The number of digits in fractional seconds
 - Value range: 0 ~ 6
 - Default value: 6
- INTERVAL DAY [(leading_precision)] TO HOUR: A period of DAY and HOUR is stored.
 - leading_precision
 - The number of digits in DAY
 - Value range: 2 ~ 6
 - Default value: 2
- INTERVAL DAY [(leading_precision)] TO MINUTE: A period of DAY, HOUR, and MINUTE is stored.
 - leading_precision
 - The number of digits in DAY
 - Value range: 2 ~ 6
 - Default value: 2
- INTERVAL DAY [(leading_precision)] TO SECOND [(fractional_seconds_precision)]: A period of DAY, HOUR, MINUTE, and SECOND is stored.
 - leading_precision

- The number of digits in DAY
 - Value range: 2 ~ 6
 - Default value: 2
- fractional_seconds_precision
 - The number of digits in fractional seconds
 - Value range: 0 ~ 6
 - Default value: 6
- INTERVAL HOUR [(leading_precision)] TO MINUTE: A period of HOUR and MINUTE is stored.
 - leading_precision
 - The number of digits in HOUR
 - Value range: 2 ~ 6
 - Default value: 2
- INTERVAL HOUR [(leading_precision)] TO SECOND [(fractional_seconds_precision)]: A period of HOUR, MINUTE and SECOND is stored.
 - leading_precision
 - The number of digits in HOUR
 - Value range: 2 ~ 6
 - Default value: 2
 - fractional_seconds_precision
 - The number of digits in fractional seconds
 - Value range: 0 ~ 6
 - Default value: 6
- INTERVAL MINUTE [(leading_precision)] TO SECOND [(fractional_seconds_precision)]: A period of MINUTE and SECOND is stored.
 - leading_precision
 - The number of digits in MINUTE
 - Value range: 2 ~ 6
 - Default value: 2
 - fractional_seconds_precision
 - The number of digits in fractional seconds
 - Value range: 0 ~ 6
 - Default value: 6

Description

INTERVAL types are classified into YEAR TO MONTH family type and DAY TO SECOND family type depending on the range of value representation as follows.

- YEAR TO MONTH family type: Its storage size is 8 bytes.

- INTERVAL YEAR
- INTERVAL MONTH
- INTERVAL YEAR TO MONTH
- DAY TO SECOND family type: Its storage size is 16 bytes.
 - INTERVAL DAY
 - INTERVAL HOUR
 - INTERVAL MINUTE
 - INTERVAL SECOND
 - INTERVAL DAY TO HOUR
 - INTERVAL DAY TO MINUTE
 - INTERVAL DAY TO SECOND
 - INTERVAL HOUR TO MINUTE
 - INTERVAL HOUR TO SECOND
 - INTERVAL MINUTE TO SECOND

If the number which is bigger than number of the specified digits is in the field to which the `leading_precision` is specified, then an error is returned.

If the number which is bigger than number of the specified digits is in the field to which the `fractional_seconds_precision` is specified, it is rounded off.

Table 11-46 Precisions and value range of the second or later field in INTERVAL * TO *

Field	Precision	Value range
MONTH	2	0 ~ 11
HOUR	2	0 ~ 23
MINUTE	2	0 ~ 59
SECOND (interger part)	2	0 ~ 59

For More Information

Refer to [Interval Literals](#).

NATIVE_BIGINT

Syntax

NATIVE_BIGINT

Description

Signed 8-byte integer is stored.

It is as same as long long data type of C language (8 bytes integer).

- Value range: -9,223,372,036,854,775,808 ~ 9,223,372,036,854,775,807
- Storage size: 8 bytes

NATIVE_DOUBLE

Syntax

`NATIVE_DOUBLE`

Description

Double precision floating-point number (8 bytes) is stored.

It is as same as double data type of C language.

- Exponential range: $1E-307 \sim 1E+308$
- Storage size: 8 bytes

NATIVE_INTEGER

Syntax

NATIVE_INTEGER

Description

Signed 4 byte integer is stored.

It is as same as integer data type of C language (4 bytes).

- Value range: -2,147,483,648 ~ +2,147,483,647
- Storage size: 4 bytes

NATIVE_REAL

Syntax

`NATIVE_REAL`

Description

Single precision floating-point number (4 bytes) is stored.

It is as same as float data type of C language.

- Exponential range: $1E-37 \sim 1E+37$
- Storage size: 4 bytes

NATIVE_SMALLINT

Syntax

NATIVE_SMALLINT

Description

Signed 2 byte integer is stored.

It is as same as short data type of C language.

- Value range: -32,768 ~ 32,767
- Storage size: 2 bytes

NUMBER

Syntax

`NUMBER [(precision [, scale])]`

Syntax Rules and Parameters

- **NUMBER**: A floating point number without a precision and scale is stored.
 - The range of significant digits: 38
 - Exponential range: 1E-130 ~ 1E+125
 - It is as same as **FLOAT** (126).
- **NUMBER(precision)**: The integer with significant digits of precision is stored.
 - Precision range: 1 ~ 38
 - The scale value: 0
 - It has a decimal precision value unlike **FLOAT** type.
 - It is as same as **NUMBER(precision, 0)**, **NUMERIC(precision, 0)**.
- **NUMBER(precision, scale)**: A fixed point number with precision and scale is stored.
 - Precision range: 1 ~ 38
 - Scale range: -84 ~ 127
 - It has a decimal precision value unlike **FLOAT** type.
 - It is as same as **NUMERIC (precision,scale)**.
 - Alias names: **SMALLINT** = **NUMBER(5,0)**, **INTEGER** = **NUMBER(10,0)**, **BIGINT** = **NUMBER(19,0)**, **INT2** = **NUMBER(5,0)**, **INT4** = **NUMBER(10,0)**, **INT8** = **NUMBER(19,0)**

Description

NUMBER type is similar to **NUMERIC** type, but if both the precision and scale are omitted, **NUMBER** type stores the floating point number whose precision and scale are not specified.

- **NUMBER** without precision, scale: Floating-point number
- **NUMERIC** without precision, scale: The fixed point number of **NUMERIC(38, 0)**
- Storage size: (number of digits in integer part + 1) / 2 + (number of digits in fractional part + 1) / 2 + 1(exponent, sign)

For More Information

Refer to the followings.

- **FLOAT**
- **NUMERIC**

NUMERIC

Syntax

```
NUMERIC [ ( precision [ , scale ] ) ]
```

Syntax Rules and Parameters

- precision: It is the decimal precision of significant digits.
 - precision range: 1 ~ 38
 - Default value: 38
- scale: It is the decimal point range.
 - scale range: -84 ~ 127
 - Default value: 0

Description

A fixed point number with precision and scale is stored.

If the precision and scale are omitted, it means as follows.

- NUMERIC = NUMERIC(38,0)
- NUMERIC(p) = NUMERIC(p,0)

NUMBER type is similar to NUMERIC type, but if both the precision and scale are omitted, NUMBER type stores the floating-point number whose precision and scale is not specified.

- NUMBER without precision, scale: Floating point number
- NUMERIC without precision, scale: Fixed point number of NUMERIC(38,0)
- Storage size: (number of digits in integer part + 1) / 2 + (number of digits in fractional part + 1) / 2 + 1(exponent, sign)

For More Information

Refer to the followings.

- FLOAT
- NUMBER

ROWID

Syntax

ROWID

Description

A record identifier (ROWID) is stored.

A record identifier (ROWID) is the identification information of each record in database.

When querying the ROWID pseudo column, each record identifier (ROWID) is obtained. This ROWID pseudo column has the ROWID data type information.

ROWID type consists of the followings in a standalone system.

- OBJECT_ID
- TABLESPACE_ID
- PAGE_ID
- OFFSET within PAGE

ROWID type consists of the followings in a cluster system.

- GRID_BLOCK_SEQUENCE
- GRID_BLOCK_ID
- MEMBER_ID
- SHARD_ID

ROWID is stored in the base 64 value, which can include A ~ Z, a ~ z, 0 ~ 9, +, /.

Each component information of ROWID is obtained using ROWID-related functions.

- Storage size: 16 bytes

For More Information

Refer to the followings.

- [ROWID Pseudo Column](#)
- [ROWID-related Functions](#)

TIME

Syntax

```
TIME [ ( fractional_seconds_precision ) ] [ WITH TIME ZONE | WITHOUT TIME ZONE ]
```

Syntax Rules and Parameters

- `fractional_seconds_precision`: It is the number of significant digits in fractional seconds.
 - `fractional_seconds_precision` range: 0 ~ 6
 - Default value: 6
- `[WITH TIME ZONE | WITHOUT TIME ZONE]`: It specifies whether to store TIME ZONE value.
 - `WITH TIME ZONE`: The time which includes time zone
 - `WITHOUT TIME ZONE`: The time which does not include time zone
 - Default value: `WITHOUT TIME ZONE`

Description

The time which includes HOUR, MINUTE and SECOND is stored.

- Storage size
 - `TIME WITHOUT TIME ZONE`: 8 bytes
 - `TIME WITH TIME ZONE`: 12 bytes

For More Information

Refer to the followings.

- [Time Literals](#)
- [Time with Time Zone Literals](#)
- [DATE](#)
- [TIMESTAMP](#).

TIMESTAMP

Syntax

```
TIMESTAMP [ ( fractional_seconds_precision ) ] [ WITH TIME ZONE | WITHOUT TIME ZONE ]
```

Syntax Rules and Parameters

- `fractional_seconds_precision`: It is the number of significant digits in the fractional seconds.
 - `fractional_seconds_precision` range: 0 ~ 6
 - Default value: 6
- `[WITH TIME ZONE | WITHOUT TIME ZONE]`: It specifies whether to store TIME ZONE value.
 - `WITH TIME ZONE`: The time which includes time zone.
 - `WITHOUT TIME ZONE`: The time which does not include time zone.
 - Default value: `WITHOUT TIME ZONE`

Description

The time which includes YEAR, MONTH, DATE, HOUR, MINUTE and SECOND is stored.

- Storage size
 - `TIMESTAMP WITHOUT TIME ZONE`: 8 bytes
 - `TIMESTAMP WITH TIME ZONE`: 12 bytes

For More Information

Refer to the followings.

- [Timestamp Literals](#)
- [Timestamp with Time Zone Literals](#)
- [DATE](#)
- [TIME](#)

11.10 Built-in Function References

* (MULTIPLICATION)

Syntax

`expr1 * expr2`

Description

It returns the multiplication result of `expr1` and `expr2`.

The multiplication types and result types are as follows.

For more information, refer to [Type Conversion](#).

Table 11-47 Numeric * operation

expr1 (expr2)	expr2 (expr1)	Result type
NATIVE INTEGER family <ul style="list-style-type: none"> NATIVE_SMALLINT NATIVE_INTEGER NATIVE_BIGINT 	NATIVE INTEGER family <ul style="list-style-type: none"> NATIVE_SMALLINT NATIVE_INTEGER NATIVE_BIGINT 	NATIVE_BIGINT
NUMBER	NUMBER	NUMBER
NATIVE DOUBLE family <ul style="list-style-type: none"> NATIVE_REAL NATIVE_DOUBLE 	NATIVE DOUBLE family <ul style="list-style-type: none"> NATIVE_REAL NATIVE_DOUBLE 	NATIVE_DOUBLE

Table 11-48 INTERVAL * operation

expr1 (expr2)	expr2 (expr1)	Result type
INTERVAL YEAR TO MONTH	Numeric type	INTERVAL YEAR TO MONTH (The result type is the interval type.)
INTERVAL DAY TO SECOND	Numeric type	INTERVAL DAY TO SECOND (The result type is the interval type.)
Refer to INTERVAL type details which is included in INTERVAL type written in the following table.		

Table 11-49 INTERVAL type details which is included in INTERVAL type written in the following table

INTERVAL YEAR TO MONTH	INTERVAL DAY TO SECOND
	<ul style="list-style-type: none"> INTERVAL DAY INTERVAL HOUR

INTERVAL YEAR TO MONTH	INTERVAL DAY TO SECOND
<ul style="list-style-type: none"> • INTERVAL YEAR • INTERVAL MONTH • INTERVAL YEAR TO MONTH 	<ul style="list-style-type: none"> • INTERVAL MINUTE • INTERVAL SECOND • INTERVAL DAY TO HOUR • INTERVAL DAY TO MINUTE • INTERVAL DAY TO SECOND • INTERVAL HOUR TO MINUTE • INTERVAL HOUR TO SECOND • INTERVAL MINUTE TO SECOND

Example

```
gSQL> SELECT INTERVAL '1-2' YEAR TO MONTH * 2 AS RESULT FROM DUAL;
```

```
RESULT
```

```
-----  
+000002-04
```

```
1 row selected.
```

```
gSQL> SELECT INTERVAL '1 01:02:03.400000' DAY TO SECOND * 2 AS RESULT  
FROM DUAL;
```

```
RESULT
```

```
-----  
+000002 02:04:06.800000
```

```
1 row selected.
```

+ (ADDITION)

Syntax

`expr1 + expr2`

Description

It returns the addition result of `expr1` and `expr2`.

The addition types and result types are as follows.

For more information, refer to **Type Conversion**.

Table 11-50 Numeric + operation

expr1 (expr2)	expr2 (expr1)	Result type
NATIVE INTEGER family <ul style="list-style-type: none"> NATIVE_SMALLINT NATIVE_INTEGER NATIVE_BIGINT 	NATIVE INTEGER family <ul style="list-style-type: none"> NATIVE_SMALLINT NATIVE_INTEGER NATIVE_BIGINT 	NATIVE_BIGINT
NUMBER	NUMBER	NUMBER
NATIVE DOUBLE family <ul style="list-style-type: none"> NATIVE_REAL NATIVE_DOUBLE 	NATIVE DOUBLE family <ul style="list-style-type: none"> NATIVE_REAL NATIVE_DOUBLE 	NATIVE_DOUBLE

Table 11-51 (DATETIME/INTERVAL) + operation

expr1 (expr2)	expr2 (expr1)	Result type
DATE	NUMERIC	DATE
DATE	INTERVAL YEAR TO MONTH	DATE
DATE	INTERVAL DAY	DATE
DATE	INTERVAL DAY TO SECOND	TIMESTAMP
TIME	NUMERIC	TIME
TIME	INTERVAL YEAR TO MONTH	TIME
TIME	INTERVAL DAY TO SECOND	TIME
TIME WITH TIME ZONE	NUMERIC	TIME WITH TIME ZONE
TIME WITH TIME ZONE	INTERVAL YEAR TO MONTH	TIME WITH TIME ZONE
TIME WITH TIME ZONE	INTERVAL DAY TO SECOND	TIME WITH TIME ZONE
TIMESTAMP	NUMERIC	TIMESTAMP
TIMESTAMP	INTERVAL YEAR TO MONTH	TIMESTAMP
TIMESTAMP	INTERVAL DAY TO SECOND	TIMESTAMP
TIMESTAMP WITH TIME ZONE	NUMERIC	TIMESTAMP WITH TIME ZONE

expr1 (expr2)	expr2 (expr1)	Result type
TIMESTAMP WITH TIME ZONE	INTERVAL YEAR TO MONTH	TIMESTAMP WITH TIME ZONE
TIMESTAMP WITH TIME ZONE	INTERVAL DAY TO SECOND	TIMESTAMP WITH TIME ZONE
INTERVAL YEAR TO MONTH	INTERVAL YEAR TO MONTH	INTERVAL YEAR TO MONTH (The result type includes all the interval range of expr1 and expr2.)
INTERVAL DAY TO SECOND	INTERVAL DAY TO SECOND	INTERVAL DAY TO SECOND (The result type includes all the interval range of expr1 and expr2.)

Refer to **INTERVAL type details** which is included in **INTERVAL type** written in the following table.

Example

```

gSQL> SELECT TO_DATE( '2012-05-05', 'YYYY-MM-DD' ) + 5 AS RESULT FROM DUAL;
RESULT
-----
2012-05-10
1 row selected.
gSQL> SELECT
    TO_DATE( '2012-05-05', 'YYYY-MM-DD' ) + INTERVAL'01-01'YEAR TO MONTH
    AS RESULT
    FROM DUAL;
RESULT
-----
2013-06-05
1 row selected.
gSQL> SELECT
    INTERVAL'01-01'YEAR TO MONTH + INTERVAL'02-10'YEAR TO MONTH
    AS RESULT
    FROM DUAL;
RESULT
-----
+000003-11
1 row selected.

```

+ (POSITIVE)

Syntax

```
+ expr
```

Description

The + sign is displayed in expr.

Example

```
gSQL> SELECT +3 AS RESULT1, +(-3) AS RESULT2 FROM DUAL;  
RESULT1 RESULT2  
-----  
3      -3  
1 row selected.
```

- (NEGATIVE)

Syntax

```
- expr
```

Description

The - sign is displayed in expr.

Example

```
gSQL> SELECT -3 AS RESULT1, -(-3) AS RESULT2 FROM DUAL;  
RESULT1 RESULT2  
-----  
      -3         3  
1 row selected.
```

- (SUBTRACTION)

Syntax

`expr1 - expr2`

Description

It returns the subtraction result of `expr1` and `expr2`.

The subtraction types and result types are as follows.

For more information, refer to **Type Conversion**.

Table 11-52 Numeric - operation

expr1	expr2	Result type
NATIVE INTEGER family <ul style="list-style-type: none"> NATIVE_SMALLINT NATIVE_INTEGER NATIVE_BIGINT 	NATIVE INTEGER family <ul style="list-style-type: none"> NATIVE_SMALLINT NATIVE_INTEGER NATIVE_BIGINT 	NATIVE_BIGINT
NUMBER	NUMBER	NUMBER
NATIVE DOUBLE family <ul style="list-style-type: none"> NATIVE_REAL NATIVE_DOUBLE 	NATIVE DOUBLE family <ul style="list-style-type: none"> NATIVE_REAL NATIVE_DOUBLE 	NATIVE_DOUBLE

Table 11-53 (DATETIME/INTERVAL) - operation

expr1	expr2	Result type
DATE	DATE	NUMBER
DATE	Numeric type	DATE
DATE	INTERVAL YEAR TO MONTH	DATE
DATE	INTERVAL DAY	DATE
DATE	INTERVAL DAY TO SECOND	TIMESTAMP
TIME	TIME	INTERVAL DAY TO SECOND
TIME	Numeric type	TIME
TIME	INTERVAL YEAR TO MONTH	TIME
TIME	INTERVAL DAY TO SECOND	TIME
TIME WITH TIME ZONE	Numeric type	TIME WITH TIME ZONE
TIME WITH TIME ZONE	INTERVAL YEAR TO MONTH	TIME WITH TIME ZONE
TIME WITH TIME ZONE	INTERVAL DAY TO SECOND	TIME WITH TIME ZONE
TIMESTAMP	TIMESTAMP	INTERVAL DAY TO SECOND
TIMESTAMP	Numeric type	TIMESTAMP

expr1	expr2	Result type
TIMESTAMP	INTERVAL YEAR TO MONTH	TIMESTAMP
TIMESTAMP	INTERVAL DAY TO SECOND	TIMESTAMP
TIMESTAMP WITH TIME ZONE	TIMESTAMP WITH TIME ZONE	INTERVAL DAY TO SECOND
TIMESTAMP WITH TIME ZONE	Numeric type	TIMESTAMP WITH TIME ZONE
TIMESTAMP WITH TIME ZONE	INTERVAL YEAR TO MONTH	TIMESTAMP WITH TIME ZONE
TIMESTAMP WITH TIME ZONE	INTERVAL DAY TO SECOND	TIMESTAMP WITH TIME ZONE
INTERVAL YEAR TO MONTH	INTERVAL YEAR TO MONTH	INTERVAL YEAR TO MONTH (The result type includes all the interval range of expr1 and expr2.)
INTERVAL DAY TO SECOND	INTERVAL DAY TO SECOND	INTERVAL DAY TO SECOND (The result type includes all the interval range of expr1 and expr2.)

Refer to Table 11-49 INTERVAL type details which is included in INTERVAL type written in the following table.

Example

```

gSQL> SELECT
    TO_DATE( '2012-05-05' ) - TO_DATE( '2012-01-01' ) AS RESULT
    FROM DUAL;
RESULT
-----
    125
1 row selected.
gSQL> SELECT TO_DATE( '2012-05-05' ) - 3 AS RESULT FROM DUAL;
RESULT
-----
2012-05-02
1 row selected.
gSQL> SELECT
    TO_DATE( '2012-05-05' ) - INTERVAL'01-02'YEAR TO MONTH AS RESULT
    FROM DUAL;
RESULT
-----
2011-03-05
1 row selected.
gSQL> SELECT
    INTERVAL'05-11'YEAR TO MONTH - INTERVAL'02-01'YEAR TO MONTH
    AS RESULT
    FROM DUAL;

```

```
RESULT
```

```
-----
```

```
+000003-10
```

```
1 row selected.
```

```
gSQL> SELECT INTERVAL '15 23:59:59.999999' DAY TO SECOND  
        - INTERVAL '10 23:59:59.999999' DAY TO SECOND AS RESULT  
        FROM DUAL;
```

```
RESULT
```

```
-----
```

```
+000005 00:00:00.000000
```

```
1 row selected.
```

/ (DIVISION)

Syntax

```
expr1 / expr2
```

Description

It returns the division result of expr1 and expr2.

The division types and result types are as follows.
For more information, refer to **Type Conversion**.

Table 11-54 Numeric / operation

expr1	expr2	Result type
NATIVE INTEGER family <ul style="list-style-type: none"> • NATIVE_SMALLINT • NATIVE_INTEGER • NATIVE_BIGINT 	NATIVE INTEGER family <ul style="list-style-type: none"> • NATIVE_SMALLINT • NATIVE_INTEGER • NATIVE_BIGINT 	NATIVE_DOUBLE
NUMBER	NUMBER	NUMBER
NATIVE_DOUBLE	NATIVE_DOUBLE	NATIVE_DOUBLE

Table 11-55 (DATETIME/INTERVAL) / operation

expr1	expr2	Result type
INTERVAL YEAR TO MONTH	Numeric type	INTERVAL YEAR TO MONTH (The result type is interval type.)
INTERVAL DAY TO SECOND	Numeric type	INTERVAL DAY TO SECOND (The result type is interval type.)
Refer to INTERVAL type details which is included in INTERVAL type written in the following table.		

Example

```
gSQL> SELECT INTERVAL '20-10' YEAR TO MONTH / 2 AS RESULT FROM DUAL;
RESULT
-----
+000010-05
1 row selected.
gSQL> SELECT INTERVAL '02 02:04:06.800000' DAY TO SECOND / 2 AS RESULT
FROM DUAL;
```

RESULT

+000001 01:02:03.400000

1 row selected.

|| (CONCATENATE)

Syntax

```
str1 || str2
```

Description

CONCATENATE returns the string concatenating str1 and str2.

If either str1 or str2 is NULL, the string except NULL is returned. If both of str1 and str2 are NULL, NULL is returned.

The argument can be a type which can be converted to either character string type or binary string type. For more information, refer to **Type Conversion**.

It is an alias of **CONCAT**, **CONCATENATE**.

The result types are as follows.

Table 11-56 The result types of || (CONCATENATE)

Data type	CHAR	VARCHAR	LONG VARCHAR
CHAR	CHAR	VARCHAR	LONG VARCHAR
VARCHAR	VARCHAR	VARCHAR	LONG VARCHAR
LONG VARCHAR	LONG VARCHAR	LONG VARCHAR	LONG VARCHAR
Data type	BINARY	VARBINARY	LONG VARBINARY
BINARY	BINARY	VARBINARY	LONG VARBINARY
VARBINARY	VARBINARY	VARBINARY	LONG VARBINARY
LONG VARBINARY	LONG VARBINARY	LONG VARBINARY	LONG VARBINARY

Example

```
gSQL> SELECT 'DATA' || 'BASE' AS RESULT1,
           'DATA' || NULL  AS RESULT2,
           NULL || NULL   AS RESULT3
       FROM DUAL;
RESULT1  RESULT2  RESULT3
-----  -
DATABASE DATA    null
1 row selected.
```

ABS

Syntax

```
ABS( num )
```

Description

ABS returns the absolute value of num.

The num argument can be a numeric type or types which can be converted to number.

Example

```
gSQL> SELECT ABS(-1) AS RESULT1, ABS(1) AS RESULT2 FROM DUAL;  
RESULT1 RESULT2  
-----  
1      1  
1 row selected.
```

ACOS

Syntax

ACOS(num)

Description

ACOS returns the arc cosine value of num.
The num argument should be in the range of -1 to 1.
It returns the radians value in the range of 0 and pi.

Example

```
gSQL> SELECT ACOS( 1 ) FROM DUAL;  
ACOS( 1 )  
-----  
          0  
1 row selected.
```

ADDDATE

Syntax

```
ADDDATE( date, INTERVAL expr unit )
```

```
ADDDATE( expr, days )
```

Description

ADDDATE adds the second argument to the first argument, then returns the result.

If any of the input argument value is NULL, the result is also NULL.

The first argument data type can be DATE, TIMESTAMP, TIMESTAMP WITH TIME ZONE, and the second argument data type can be INTERVAL or numeric.

The result type is as same as **(DATETIME/INTERVAL) + operation**.

Example

```
gSQL> SELECT ADDDATE( TO_DATE( '2012-12-12', 'YYYY-MM-DD' ), 1 ) AS RESULT
          FROM DUAL;
```

```
RESULT
```

```
-----
```

```
2012-12-13
```

```
1 row selected.
```

```
gSQL> SELECT ADDDATE( TO_DATE( '2012-12-12', 'YYYY-MM-DD' ),
          INTERVAL '01-01' YEAR TO MONTH ) AS RESULT
```

```
          FROM DUAL;
```

```
RESULT
```

```
-----
```

```
2014-01-12
```

```
1 row selected.
```

ADDTIME

Syntax

```
ADDTIME( expr1, expr2 )
```

Description

ADDTIME adds expr2 to expr1, then returns the result.

If expr1 or expr2 is NULL, the result is NULL.

expr1 data type can be TIME, TIME WITH TIME ZONE, TIMESTAMP, TIMESTAMP WITH TIME ZONE TYPE, and expr2 data type can be INTERVAL DAY TO SECOND TYPE.

The result type is as same as **(DATETIME/INTERVAL) + operation**.

Example

```
gSQL> SELECT
      ADDTIME( TO_TIMESTAMP( '2001-05-10 11:22:33',
                           'YYYY-MM-DD HH24:MI:SS' ),
              INTERVAL'0 01:02:03.999999'DAY TO SECOND ) AS RESULT
    FROM DUAL;
RESULT
-----
2001-05-10 12:24:36.999999
1 row selected.
```

ADD_MONTHS

Syntax

```
ADD_MONTHS( date, number )
```

Description

ADD_MONTHS adds as many month as the number to the date, then returns the result.

If any of the input argument is NULL, the result is NULL.

After ADD_MONTHS operation, if the date is bigger than the last day of the month, it is adjusted to the last day of the month.

The data type of date argument can be DATE, TIMESTAMP, TIMESTAMP WITH TIME ZONE, and the number argument can be a numeric type.

The result type is always DATE regardless of the input argument date type.

Example

```
gSQL> SELECT
      ADD_MONTHS( TO_DATE( '2001-07-31', 'YYYY-MM-DD' ), 1 ) AS RESULT1,
      ADD_MONTHS( TO_DATE( '2001-07-31', 'YYYY-MM-DD' ), 2 ) AS RESULT2
    FROM DUAL;
RESULT1    RESULT2
-----
2001-08-31 2001-09-30
1 row selected.
```

ASCII

Syntax

ASCII(char)

Description

It returns the database character set code of the first character of char in decimal form.

The data type of char can be a character type such as CHARACTER, CHARACTER VARYING, CHARACTER LONG VARYING or can be a type which can be converted to a character type, and the return type is NUMBER.

Example

```
gSQL> SELECT ASCII( 'G' ) AS RESULT FROM DUAL;  
RESULT  
-----  
       71  
1 row selected.
```

ASIN

Syntax

```
ASIN( num )
```

Description

ASIN returns the arc sin value of num.

The num argument should be in the range of -1 to 1.

It returns the radians value in the range of $-\pi/2$ and $\pi/2$.

Example

```
gSQL> SELECT ASIN( 0 ) FROM DUAL;
```

```
ASIN( 0 )
```

```
-----
```

```
0
```

```
1 row selected.
```

ATAN

Syntax

ATAN(num)

Description

ATAN returns the arc tangent value of num.

The num value range is not limited. It returns the radians value in the range of $-\pi/2$ and $\pi/2$.

Example

```
gSQL> SELECT ATAN( 1 ) FROM DUAL;  
          ATAN( 1 )  
-----  
.785398163397448  
1 row selected.
```

ATAN2

Syntax

```
ATAN2( num1, num2 )
```

Description

ATAN2 returns the arc tangent value of num1 and num2.

The num1 argument value range is not limited. It returns the radians value in the range of $-\pi$ and π .

Example

```
gSQL> SELECT ATAN2( 1, 0 ) FROM DUAL;  
  ATAN2( 1, 0 )  
-----  
1.5707963267949  
1 row selected.
```

AVG

Syntax

```
AVG( [ ALL | DISTINCT ] num )
```

Description

It is an aggregate function, and it obtains average value of exprs.

If ALL is explicitly specified, aggregation is executed for all values.

If DISTINCT is explicitly specified, aggregation is executed for the values which exclude duplicate values.

If ALL or DISTINCT is not explicitly specified, it is processed in the same way as when ALL is specified.

Example

```
gSQL> SELECT AVG(c1) FROM t1;
```

```
AVG(C1)
```

```
-----
```

```
2
```

```
1 row selected.
```

BITAND

Syntax

```
BITAND( num1, num2 )
```

Description

It returns the AND operation result for the bits of num1 and num2.

The input argument data type can be NATIVE_SMALLINT, NATIVE_INTEGER, NATIVE_BIGINT or a data type which can be converted to NATIVE_BIGINT.

When converting to NATIVE_BIGINT type, the decimal point is truncated.

The result type is NATIVE_BIGINT.

Example

```
gSQL> SELECT BITAND( 5, 3 ) AS RESULT FROM DUAL;  
RESULT  
-----  
      1  
1 row selected.
```

BITNOT

Syntax

```
BITNOT( num )
```

Description

It returns the NOT operation result for the num bit.

The input argument data type can be NATIVE_SMALLINT, NATIVE_INTEGER, NATIVE_BIGINT or a data type which can be converted to NATIVE_BIGINT.

When converting to NATIVE_BIGINT type, the decimal point is truncated.

The result type is as follows.

- If the input argument is NATIVE_SMALLINT type, its result type is NATIVE_SMALLINT type.
- If the input argument is NATIVE_INTEGER type, its result type is NATIVE_INTEGER type.
- If the input argument is NATIVE_BIGINT type, its result type is NATIVE_BIGINT type.

Example

```
gSQL> SELECT BITNOT( 5 ) AS RESULT FROM DUAL;
```

```
RESULT
```

```
-----
```

```
      -6
```

```
1 row selected.
```

BITOR

Syntax

```
BITOR( num1, num2 )
```

Description

It returns the OR operation result for the bits of num1 and num2.

The input argument data type can be NATIVE_SMALLINT, NATIVE_INTEGER, NATIVE_BIGINT types or a data type which can be converted to NATIVE_BIGINT type.

When converting to NATIVE_BIGINT type, the decimal point is truncated.

The result type is NATIVE_BIGINT type.

Example

```
gSQL> SELECT BITOR( 5, 3 ) FROM DUAL;  
BITOR( 5, 3 )  
-----  
              7  
1 row selected.
```

BITXOR

Syntax

```
BITXOR( num1, num2 )
```

Description

It returns the XOR operation result for the bits of num1 and num2.

The input argument data type can be NATIVE_SMALLINT, NATIVE_INTEGER, NATIVE_BIGINT or a data type which can be converted to NATIVE_BIGINT.

When converting to NATIVE_BIGINT type, the decimal point is truncated.

The result type is NATIVE_BIGINT.

Example

```
gSQL> SELECT BITXOR( 5, 3 ) FROM DUAL;  
BITXOR( 5, 3 )  
-----  
6  
1 row selected.
```

BIT_LENGTH

Syntax

```
BIT_LENGTH( str )
```

Description

BIT_LENGTH returns the number of bits for str.

Example

```
gSQL> SELECT BIT_LENGTH( 'LIKE' ) AS RESULT FROM DUAL;  
RESULT  
-----  
          32  
1 row selected.
```

BYTE_LENGTH

Syntax

```
BYTE_LENGTH( str )
```

Description

It is an alias of OCTET_LENGTH.

For more information, refer to **OCTET_LENGTH**, **LENGTHB**.

Example

- Multi byte character set (e.g. UTF8): 1 byte character

```
gSQL> SELECT BYTE_LENGTH( 'OCTET_LENGTH' ) AS RESULT_1BYTE_CHARACTERS
        FROM DUAL;
RESULT_1BYTE_CHARACTERS
-----
                        12
1 row selected.
```

- Multi byte character set (e.g. UTF8): 2 byte character

```
gSQL> SELECT BYTE_LENGTH( 'αβ' ) AS RESULT_2BYTE_CHARACTERS FROM DUAL;
RESULT_2BYTE_CHARACTERS
-----
                        4
1 row selected.
```

CASE2

Syntax

```
CASE2( condition1, result1
      [, condition2, result2
      , ...
      , conditionN, resultN ]
      [, default ] )
```

Description

CASE2 evaluates the condition in the described order.

If the comparison result is FALSE, it continues evaluating until TRUE comes up.

If the comparison result is TRUE, it returns the corresponding result, and does not evaluate any more.

If all the evaluation results are FALSE, it returns the default value. If the default is omitted, it returns NULL.

The result type is the data type of result1 (the first result).

If the data type of result1 (the first result) is a numeric type and a character type then each data type includes the range of result1, ..., resultN.

If result1 (the first result) is CHAR or NULL, then the result type is VARCHAR.

CASE2 can be expressed by using CASE as follows.

- CASE2(condition1, res1, condition2, res2)

```
CASE WHEN condition1 THEN res1
      WHEN condition2 THEN res2
      ELSE NULL
END
```

- CASE2(condition1, res1, condition2, res2, default)

```
CASE WHEN condition1 THEN res1
      WHEN condition2 THEN res2
      ELSE default
END
```

Example

```
gSQL> SELECT I1,  
           CASE2( I1 = 1, 'ONE', I1 = 2, 'TWO' ) AS CASE2_RESULT1,  
           CASE2( I1 = 1, 'ONE', I1 = 2, 'TWO', 'NUMBER' ) AS CASE2_RESULT2  
FROM T1;  
I1 CASE2_RESULT1 CASE2_RESULT2  
-----  
1 ONE           ONE  
2 TWO           TWO  
3 null          NUMBER  
3 rows selected.
```

CBRT

Syntax

```
CBRT( num )
```

Description

It returns the cube root of num.

If the num argument is NULL, the result is also NULL.

Example

```
gSQL> SELECT CBRT( 27 ) FROM DUAL;  
CBRT( 27 )  
-----  
          3  
1 row selected.
```

CEIL

Syntax

```
CEIL( num )  
CEILING( num )
```

Description

CEIL returns the smallest integer which is equal to or bigger than num.

Example

```
gSQL> SELECT CEIL( 3.5 ) AS RESULT1, CEIL( -3.5 ) AS RESULT2 FROM DUAL;  
RESULT1 RESULT2  
-----  
4      -3  
1 row selected.
```

CHAR_LENGTH

Syntax

```
CHAR_LENGTH( str )  
CHARACTER_LENGTH( str )
```

Description

CHAR_LENGTH returns the number of character for str according to the character set.

The str can be a character type such as CHARACTER, CHARACTER VARYING, CHARACTER LONG VARYING, or it can be a data type which can be converted to character type. The return type is NATIVE_BIGINT.

If the data type of str is CHARACTER, the trailing blanks are included in the calculation.
If str is NULL, it returns NULL.

It is an alias of **LENGTH**.

Example

Multi byte character set: (e.g. UTF8)

```
gSQL> SELECT CHAR_LENGTH( 'αβ-SUMMER' ) AS RESULT FROM DUAL;  
  RESULT  
-----  
          9  
1 row selected.
```

CHR

Syntax

CHR(num)

Description

It returns a character in the database character set code corresponding to num.

An input argument can be a numeric type and the return type is VARCHAR.

Example

```
gSQL> SELECT CHR(71) FROM DUAL;  
CHR(71)  
-----  
G  
1 row selected.
```

CLOCK_DATE

Syntax

```
CLOCK_DATE()
```

Description

Whenever the `CLOCK_DATE` function is called, the current date (DATE type) value is obtained.

The differences among the functions to obtain the current date are as follows.

- `TRANSACTION_DATE()`: All date values in the transaction are same.
- `STATEMENT_DATE()`: All date values in an SQL statement are same.
- `CLOCK_DATE()`: Whenever the function is called, the current date value is obtained.

Example

Each row can have a different date value.

```
gSQL> SELECT CLOCK_DATE() FROM t1;
CLOCK_DATE()
-----
2013-12-12
2013-12-12
2013-12-13
3 rows selected.
```

CLOCK_LOCALTIME

Syntax

```
CLOCK_LOCALTIME()
```

Description

Whenever the `CLOCK_LOCALTIME` function is called, the current time value without TIME ZONE (TIME WITHOUT TIME ZONE type) is obtained.

The differences among the functions to obtain the current time are as follows.

- `TRANSACTION_LOCALTIME()`: All time values in the transaction are same.
- `STATEMENT_LOCALTIME()`: All time values in an SQL statement are same.
- `CLOCK_LOCALTIME()`: Whenever the function is called, the current time value is obtained.

Example

Each row can have a different time value.

```
gSQL> SELECT CLOCK_LOCALTIME() FROM t1;
CLOCK_LOCALTIME()
-----
14:42:05.470757
14:42:05.470759
14:42:05.470759
3 rows selected.
```

CLOCK_LOCALTIMESTAMP

Syntax

```
CLOCK_LOCALTIMESTAMP()
```

Description

Whenever the `CLOCK_LOCALTIMESTAMP()` function is called, the current `TIMESTAMP` value without `TIME ZONE` (`TIMESTAMP WITHOUT TIME ZONE` type) is obtained.

The differences among the functions to obtain the current `TIMESTAMP` are as follows.

- `TRANSACTION_LOCALTIMESTAMP()`: All `TIMESTAMP` values in the transaction are same.
- `STATEMENT_LOCALTIMESTAMP()`: All `TIMESTAMP` values in an SQL statement are same.
- `CLOCK_LOCALTIMESTAMP()`: Whenever the function is called, the current timestamp value is obtained.

Example

Each row can have a different timestamp value.

```
gSQL> SELECT CLOCK_LOCALTIMESTAMP() FROM t1;
CLOCK_LOCALTIMESTAMP()
-----
2013-12-12 14:46:17.309206
2013-12-12 14:46:17.309209
2013-12-12 14:46:17.309209
```

CLOCK_TIME

Syntax

```
CLOCK_TIME()
```

Description

Whenever the `CLOCK_TIME()` function is called, the current time value with TIME ZONE (TIME WITH TIME ZONE type) is obtained.

The differences among the functions to obtain the current time are as follows.

- `TRANSACTION_TIME()`: All time values in the transaction are same.
- `STATEMENT_TIME()`: All time values in an SQL statement are same.
- `CLOCK_TIME()`: Whenever the function is called, the current time value is obtained.

Example

Each row can have a different time value.

```
gSQL> SELECT CLOCK_TIME() FROM t1;
CLOCK_TIME()
-----
14:48:21.052324 +09:00
14:48:21.052326 +09:00
14:48:21.052327 +09:00
3 rows selected.
```

CLOCK_TIMESTAMP

Syntax

```
CLOCK_TIMESTAMP()
```

Description

Whenever `CLOCK_TIMESTAMP()` function is called, the current `TIMESTAMP` value with `TIME ZONE` (`TIMESTAMP WITH TIME ZONE` type) is obtained.

The differences among the functions to obtain the current `TIMESTAMP` are as follows.

- `TRANSACTION_TIMESTAMP()`: All `TIMESTAMP` values in the transaction are same.
- `STATEMENT_TIMESTAMP()`: All `TIMESTAMP` values in an SQL statement are same.
- `CLOCK_TIMESTAMP()`: Whenever the function is called, the current `TIMESTAMP` value is obtained.

Example

Each row can have a different timestamp value.

```
gSQL> SELECT CLOCK_TIMESTAMP() FROM t1;
CLOCK_TIMESTAMP()
-----
2013-12-12 14:49:45.051709 +09:00
2013-12-12 14:49:45.051714 +09:00
2013-12-12 14:49:45.051714 +09:00
3 rows selected.
```

COALESCE

Syntax

```
COALESCE( expr1, ..., exprN )
```

Description

It returns the first non null expr in the expr list.

If all expr in the expr list are null, it returns null.

In the expr list, there should be two or more expr.

If multiple types are in the expr list, the result type is determined by the **Result Type Combination Rule**.

COALESCE can be expressed by using CASE as follows.

- COALESCE(expr1, expr2)

```
CASE WHEN expr1 IS NOT NULL THEN expr1
      ELSE expr2
END
```

- COALESCE(expr1, expr2, ..., exprN)

```
CASE WHEN expr1 IS NOT NULL THEN expr1
      ELSE COALESCE( expr2, ..., exprN )
END
```

Example

```
gSQL> SELECT COALESCE( NULL, 1, 2 ) FROM DUAL;
COALESCE( NULL, 1, 2 )
-----
                1
1 row selected.
gSQL> SELECT COALESCE( NULL, NULL, NULL ) FROM DUAL;
COALESCE( NULL, NULL, NULL )
-----
null
1 row selected.
```

CONCAT

Syntax

```
CONCAT( str1, str2, ... )
```

Description

It is an alias of `||` (`CONCATENATE`).

It is an argument of `CONCAT` function and 2 ~ 254 number of `CONCAT`s can be set.

For more information, refer to `||` (`CONCATENATE`), `CONCATENATE`.

Example

```
gSQL> SELECT CONCAT( 'DATA', 'BASE' ) AS RESULT FROM DUAL;  
RESULT  
-----  
DATABASE  
1 row selected.
```

CONCATENATE

Syntax

```
CONCATENATE( str1, str2, ... )
```

Description

It is an alias of || (CONCATENATE).

It is an argument of CONCATENATE function and 2 ~ 254 number of CONCATENATEs can be set.

For more information, refer to [CONCAT, || \(CONCATENATE\)](#).

Example

```
gSQL> SELECT CONCATENATE( 'DATA', 'BASE' ) AS RESULT FROM DUAL;  
RESULT  
-----  
DATABASE  
1 row selected.
```

COS

Syntax

```
COS(num)
```

Description

It returns the COSINE value of num.

If the num argument is NULL, the result is also NULL.

Example

```
gSQL> SELECT COS( 0 ) FROM DUAL;  
COS( 0 )  
-----  
          1  
1 row selected.
```

COT

Syntax

COT(num)

Description

It returns the COTANGENT value of num.
If the num argument is NULL, the result is also NULL.

Example

```
gSQL> SELECT COT( 1 ) FROM DUAL;  
          COT( 1 )  
-----  
.642092615934331  
1 row selected.
```

COUNT

Syntax

```
COUNT( [ ALL | DISTINCT ] expr )
```

Description

It is an aggregate function. It returns the number of row whose expr is not NULL.

If ALL is explicitly specified, aggregation is executed for all values.

If DISTINCT is explicitly specified, aggregation is executed for the values which exclude duplicate values.

If ALL or DISTINCT is not explicitly specified, it is processed in the same way as when ALL is specified.

Example

```
gSQL> SELECT COUNT(c1) FROM t1;
```

```
COUNT(C1)
```

```
-----
```

```
3
```

```
1 row selected.
```

COUNT(*)

Syntax

COUNT(*)

Description

It is an aggregate function, and the number of rows is obtained.

It has nothing to do with whether it is NULL or not because an expression is not explicitly specified.

Example

```
gSQL> SELECT COUNT(*) FROM t1;
COUNT(*)
-----
         4
1 row selected.
```

CURRENT_CATALOG

Syntax

```
CURRENT_CATALOG [(<)]
```

Description

The catalog name (database name) is obtained.

Example

```
gSQL> SELECT CURRENT_CATALOG FROM dual;  
CURRENT_CATALOG  
-----  
TEST_DB  
1 row selected.
```

CURRENT_DATE

Syntax

```
CURRENT_DATE [(  
STATEMENT_DATE(  
))]
```

Description

The current date (DATE type) is obtained.

CURRENT_DATE is an SQL standard function.

The differences among the functions to obtain the current date are as follows.

- TRANSACTION_DATE(): All date values in the transaction are same.
- CURRENT_DATE, STATEMENT_DATE(): All date values in an SQL statement are same.
- CLOCK_DATE(): Whenever the function is called, the current date value is obtained.

Example

```
gSQL> SELECT CURRENT_DATE FROM t1;  
CURRENT_DATE  
-----  
2013-12-12  
2013-12-12  
2013-12-12  
3 rows selected.
```

CURRENT_SCHEMA

Syntax

```
CURRENT_SCHEMA [()]
```

Description

User's current SCHEMA is obtained.

Example

```
gSQL> SELECT CURRENT_SCHEMA FROM dual;  
CURRENT_SCHEMA  
-----  
PUBLIC  
1 row selected.
```

CURRENT_TIME

Syntax

```
CURRENT_TIME [(  
STATEMENT_TIME(  
)
```

Description

The current TIME WITH TIME ZONE type value based on the session time is obtained.

CURRENT_TIME is an SQL standard function.

The differences among the functions to obtain the current time are as follows.

- TRANSACTION_TIME(): All time values in the transaction are same.
- CURRENT_TIME, STATEMENT_TIME(): All time values in an SQL statement are same.
- CLOCK_TIME(): Whenever the function is called, the current time value is obtained.

Example

All rows have the same value.

```
gSQL> SELECT CURRENT_TIME FROM t1;  
CURRENT_TIME  
-----  
16:27:10.116396 +09:00  
16:27:10.116396 +09:00  
16:27:10.116396 +09:00  
3 rows selected.
```

CURRENT_TIMESTAMP

Syntax

```
CURRENT_TIMESTAMP [()]  
STATEMENT_TIMESTAMP()
```

Description

It obtains the `TIMESTAMP WITH TIME ZONE` type value based on the session time.

`CURRENT_TIMESTAMP` is an SQL standard function.

The differences among the functions to obtain the current `TIMESTAMP` are as follows.

- `TRANSACTION_TIMESTAMP()`: All `TIMESTAMP` values in the transaction are same.
- `CURRENT_TIMESTAMP`, `STATEMENT_TIMESTAMP()`: All `TIMESTAMP` values in an SQL statement are same.
- `CLOCK_TIMESTAMP()`: Whenever the function is called, the current timestamp value is obtained.

Example

All rows have the same value.

```
gSQL> SELECT CURRENT_TIMESTAMP FROM t1;  
CURRENT_TIMESTAMP  
-----  
2013-12-12 16:34:55.649632 +09:00  
2013-12-12 16:34:55.649632 +09:00  
2013-12-12 16:34:55.649632 +09:00  
3 rows selected.
```

CURRENT_USER

Syntax

```
CURRENT_USER [()]
```

Description

It returns the current user.

The user information is managed in three types as follows.

- Logon user: It is a user who performed login, and it is maintained until the connection is closed.
- Session user: It is as same as the first logon user, but it can be changed using the SET SESSION AUTHORIZATION statement.
- Current user: It is generally as same as the session user, but it is temporarily changed internally in system to control access when using the PSM, view.
 - The session user and current user is similar to the difference between the unix system's real user and the effective user.

Example

```
% gsql sys gliese
gSQL> SET SESSION AUTHORIZATION test;
Session set.
gSQL> SELECT
    LOGON_USER() AS result1,
    SESSION_USER() AS result2,
    CURRENT_USER() AS result3
FROM DUAL;
RESULT1 RESULT2 RESULT3
-----
SYS     TEST     TEST
1 row selected.
```

CURRVAL

Syntax

```
seq_name.CURRVAL  
CURRVAL(seq_name)
```

Description

The current value of the sequence object is obtained.

A sequence value should be set with NEXTVAL(seq_name) at least once.

Example

```
gSQL> SELECT seq.CURRVAL FROM dual;  
SEQ.CURRVAL  
-----  
              1  
1 row selected.
```

DATEADD

Syntax

```
DATEADD( datepart, number, date )
```

Description

It adds number to the specified datepart of date, and returns the result.

If the number is decimal point, it is not rounded off.

The date data type can be DATE, TIMESTAMP, TIMESTAMP WITH TIME ZONE, TIME, TIME WITH TIME ZONE.

If number or date is NULL, the result is also NULL.

The result type which is as same as the input date argument type is returned.

Table 11-57 Available string format in datepart

datepart	Description
YEAR	Year
QUARTER	Quarter
MONTH	Month
DAYOFYEAR	Day of year
DAY	Day
WEEK	Week
WEEKDAY	Weekday
HOUR	Hour
MINUTE	Minute
SECOND	Second
MILLISECOND	Millisecond
MICROSECOND	Microsecond

Example

```
gSQL> SELECT
    DATEADD( YEAR, 1, TO_DATE( '2013-05-14', 'YYYY-MM-DD' ) ) AS RESULT
FROM DUAL;
RESULT
-----
```

2014-05-14

1 row selected.

```
gSQL> SELECT
```

```
    DATEADD( MONTH, 13, TO_DATE('2013-05-14', 'YYYY-MM-DD') ) AS RESULT
  FROM DUAL;
```

```
RESULT
```

```
-----
```

2014-06-14

1 row selected.

```
gSQL> SELECT
```

```
    DATEADD( DAY, 397, TO_DATE('2013-05-14', 'YYYY-MM-DD') ) AS RESULT
  FROM DUAL;
```

```
RESULT
```

```
-----
```

2014-06-15

1 row selected.

DATEDIFF

Syntax

```
DATEDIFF( datepart, startdate, enddate )
```

Description

It subtracts startdate from enddate, then returns the result to the specified datepart.

If the startdate or enddate is NULL, the result is also NULL.

The data type of startdate and enddate can be DATE, TIMESTAMP, TIMESTAMP WITH TIME ZONE, TIME.

The result type is NUMBER.

Table 11-58 Available string format in datepart

datepart	Description
YEAR	Year
QUARTER	Quarter
MONTH	Month
DAYOFYEAR	Day of year
DAY	Day
HOUR	Hour
MINUTE	Minute
SECOND	Second
MILLISECOND	Millisecond
MICROSECOND	Microsecond

Example

```
gSQL> SELECT
      DATEDIFF( YEAR,
              TO_DATE( '2013-05-14', 'YYYY-MM-DD' ),
              TO_DATE( '2014-06-15', 'YYYY-MM-DD' ) ) AS RESULT
      FROM DUAL;

RESULT
-----
      1
1 row selected.
```

```
gSQL> SELECT
    DATEDIFF( MONTH,
             TO_DATE( '2013-05-14', 'YYYY-MM-DD' ),
             TO_DATE( '2014-06-15', 'YYYY-MM-DD' ) ) AS RESULT
FROM DUAL;
```

RESULT

13

1 row selected.

```
gSQL> SELECT
    DATEDIFF( DAY,
             TO_DATE( '2013-05-14', 'YYYY-MM-DD' ),
             TO_DATE( '2014-06-15', 'YYYY-MM-DD' ) ) AS RESULT
FROM DUAL;
```

RESULT

397

1 row selected.

DATE_ADD

Syntax

```
DATE_ADD( date, INTERVAL expr unit )
```

Description

It is the same function as **ADDDATE** (date, INTERVAL expr unit).

Example

```
gSQL> SELECT
    DATE_ADD( TO_DATE( '2012-01-02', 'YYYY-MM-DD' ),
              INTERVAL '2-2' YEAR TO MONTH ) AS RESULT
FROM DUAL;
RESULT
-----
2014-03-02
1 row selected.
```

DATE_PART

Syntax

```
DATE_PART( field, datetime )
```

Description

The result of DATE_PART is as same as the result of the EXTRACT function. It searches for the specified field from the input datetime type, and returns it.

The field argument should be text literal, and YEAR, MONTH, DAY, HOUR, MINUTE, SECOND, TIMEZONE_HOUR, TIMEZONE_MINUTE can be specified to text literal.

The datetime argument data type can be DATE, TIMESTAMP, TIMESTAMP WITH TIME ZONE, TIME, TIME WITH TIME ZONE, INTERVAL.

If field is not in the range of datetime, an error is returned. For DATE type, field should be YEAR, MONTH, DAY, otherwise an error is returned.

The return type is NUMBER.

For more information, refer to **EXTRACT**.

Example

```
gSQL> SELECT
    DATE_PART( 'DAY', TO_DATE( '2012-01-02', 'YYYY-MM-DD' ) ) AS RESULT
FROM DUAL;
```

RESULT

2

1 row selected.

```
gSQL> SELECT
    DATE_PART( 'YEAR', INTERVAL'9-11'YEAR TO MONTH ) AS RESULT
FROM DUAL;
```

RESULT

9

1 row selected.

DECODE

Syntax

```
DECODE( expr, comparison_expr1, result1
      [ , comparison_expr2, result2
      , ...
      , comparison_exprN, resultN ]
      [ , default ] )
```

Description

It evaluates `expr` and `comparison_expr` in the described order in `DECODE` statement using equal operation.

If the comparison result is `FALSE`, it continues evaluating until `TRUE` comes up.

If the comparison result is `TRUE`, it returns the corresponding result, and does not evaluate any more.

If `expr` and `comparison_expr` are equal, or if both `expr` and `comparison_expr` are `NULL` (`null = null`), it is evaluated as `TRUE`, and returns the corresponding result.

If all of the evaluated results are `FALSE`, it returns `default`. If the `default` is omitted, it returns `NULL`.

- Comparing `expr` and `comparison_expr`
 All `expr`, `comparison_expr1`, ..., `comparison_exprN` are converted to the data type of `comparison_expr1` (the first `comparison_expr`), then they are compared.
 If `comparison_expr1` (the first `comparison_expr`) is a character type and a numeric type then it becomes the type including the range of types described in each `expr`, `comparison_expr1`, ..., `comparison_exprN`.
 If all types described in `expr`, `comparison_expr1`, ..., `comparison_exprN` are `CHAR`, then `VARCHAR` type comparison is performed.
- Result type
 The result type becomes the data type of `result1` (the first result).
 If the data type of `result1` (the first result) is a character type and a numeric type then it becomes the type including the range of types described in `result1`, ..., `resultN` each.
 If `result1` (the first result) is `CHAR` or `NULL`, then the result type is `VARCHAR`.

`DECODE` can be expressed by using `CASE` as follows.

- `DECODE(expr, comp_expr1, res1, comp_expr2, res2)`

```

CASE WHEN (expr = comp_expr1) OR (expr IS NULL AND comp_expr1 IS NULL ) THEN res1
      WHEN (expr = comp_expr2) OR (expr IS NULL AND comp_expr2 IS NULL ) THEN res2
      ELSE NULL
END

```

- DECODE(expr, comp_expr1, res1, comp_expr2, res2, default)

```

CASE WHEN (expr = comp_expr1) OR (expr IS NULL AND comp_expr1 IS NULL ) THEN res1
      WHEN (expr = comp_expr2) OR (expr IS NULL AND comp_expr2 IS NULL ) THEN res2
      ELSE default
END

```

Example

```

gSQL> SELECT I1,
           DECODE( I1, 1, 'ONE',
                  2, 'TWO',
                  NULL, 'NULL VALUE',
                  'DEFAULT VALUE' ) AS DECODE_RESULT
FROM T1;
I1 DECODE_RESULT
-----
1 ONE
2 TWO
null NULL VALUE
3 DEFAULT VALUE
4 rows selected.

```

DEGREES

Syntax

DEGREES(radians)

Description

It converts a degree radians to a value in degrees, and returns the converted value.

Example

```
gSQL> SELECT DEGREES( PI() ) AS RESULT FROM DUAL;  
RESULT  
-----  
      180  
1 row selected.
```

DIGEST

Syntax

```
DIGEST( data, type )
```

Description

It hashes the data to the given type, and returns the result in VARBINARY type.

An implicit conversion may occur when inputting data type based on the following rules.

- Input the BINARY, VARBINARY type data in VARBINARY type.
- Input LONG VARBINARY type data in LONG VARBINARY type.
- Input LONG VARCHAR type data in LONG VARCHAR type.
- Input all other type of data after implicitly converting it to VARCHAR type.

DIGEST function supports the following hash types.

- The result of 'SHA1' is 20 byte varbinary.
- The result of 'SHA224' is 28 byte varbinary.
- The result of 'SHA256' is 32 byte varbinary.
- The result of 'SHA384' is 48 byte varbinary.
- The result of 'SHA512' is 64 byte varbinary.

Use HEX function to view the result in hexadecimal character because the result is returned in VARBINAR Y type. In this case, the length becomes double of the original.

Example

```
gSQL> SELECT HEX( DIGEST( 'my password', 'SHA256' ) ) AS RESULT FROM DUAL;  
RESULT  
-----  
BB14292D91C6D0920A5536BB41F3A50F66351B7B9D94C804DFCE8A96CA1051F2  
1 row selected.
```

DUMP

Syntax

DUMP(expr)

Description

It returns internal representation information of expr.

Internal representation information is displayed as the data type, byte length and data information.

expr can be any data types, and the return type is CHARACTER VARYING.

Example

```
gSQL> SELECT DUMP( 'DUMP' ) AS RESULT FROM DUAL;  
RESULT  
-----  
Type=CHAR Len=4 : Str=68,85,77,80  
1 row selected.
```

EXP

Syntax

`EXP(num)`

Description

It returns squared value of e (base of natural logarithm)'s num.

Example

```
gSQL> SELECT EXP( 1 ) AS RESULT FROM DUAL;  
          RESULT  
-----  
2.71828182845905  
1 row selected.
```

EXTRACT

Syntax

```
EXTRACT( <field> FROM datetime )
<field> ::=
    YEAR
    | MONTH
    | DAY
    | HOUR
    | MINUTE
    | SECOND
    | TIMEZONE_HOUR
    | TIMEZONE_MINUTE
```

Description

It searches for the specified field from an input datetime type, and returns it.

The datetime argument data type can be DATE, TIMESTAMP, TIMESTAMP WITH TIME ZONE, TIME, TIME WITH TIME ZONE, INTERVAL.

If field is not in the range of datetime, an error is returned.

For DATE type, the field should be YEAR, MONTH, DAY, otherwise an error is returned.

The return type is NUMBER.

Result of EXTRACT is as same as the result of the **DATE_PART** function.

Example

```
gSQL> SELECT
    EXTRACT( SECOND FROM TO_TIMESTAMP( '2012-12-13 01:23:44.5',
                                        'YYYY-MM-DD HH24:MI:SS.FF1' ) )
    AS RESULT
FROM DUAL;
RESULT
-----
    44.5
1 row selected.
gSQL> SELECT
```

```
EXTRACT( YEAR FROM CAST('2-3' AS INTERVAL YEAR TO MONTH) ) AS RESULT  
FROM DUAL;
```

```
RESULT
```

```
-----
```

```
2
```

```
1 row selected.
```

FACTORIAL

Syntax

```
FACTORIAL( num )
```

Description

It multiplies the successive natural numbers from 1 to num in order, and returns the result.

Example

```
gSQL> SELECT FACTORIAL( 5 ) AS RESULT FROM DUAL;  
RESULT  
-----  
      120  
1 row selected.
```

FLOOR

Syntax

```
FLOOR( num )
```

Description

It returns the biggest integer which is equal to or smaller than num.

Example

```
gSQL> SELECT FLOOR(42.8) AS RESULT1, FLOOR(-42.8) AS RESULT2 FROM DUAL;  
RESULT1 RESULT2  
-----  
42      -43  
1 row selected.
```

GREATEST

Syntax

```
GREATEST( expr1 [, expr2, ... exprn ] )
```

Description

It returns the largest value among the received expr argument.

If any expr argument is NULL, the result value is NULL.

The result type becomes the data type of expr1 (the first expr).

If the data type of expr1 (the first expr) is a character type and a numeric type then it becomes the type including the range of expr1, ..., exprN each.

If all of expr1, ..., exprN is described in CHAR type, then all exprs are compared in VARCHAR type and the result type is VARCHAR.

Example

```
gSQL> SELECT GREATEST( 100, 0, 200, 150, 1 ) AS RESULT FROM DUAL;  
RESULT  
-----  
      200  
1 row selected.
```

HEX

Syntax

```
HEX( str )
```

Description

It returns a str argument in hexadecimal character.

A str argument data type can be a character type such as CHARACTER, CHARACTER VARYING, CHARACTER LONG VARYING, a type which can be converted to a character type, or a binary character type such as BINARY, BINARY VARYING, BINARY LONG VARYING.

The result type is a character type such as CHARACTER VARYING or CHARACTER LONG VARYING.

If str is NULL, then the result value is also NULL.

If an argument of HEX function is a numeric type, then it returns an error.

To convert a decimal number to a hexadecimal number, use TO_CHAR() function by using 'X' number format.

e.g. TO_CHAR(255, 'XX')

For more information, refer to **UNHEX**.

Example

```
gSQL> SELECT HEX( 'abc' ) FROM DUAL;  
HEX( 'abc' )  
-----  
616263  
1 row selected.
```

INITCAP

Syntax

```
INITCAP( str )
```

Description

It converts the first letter in each word of string `str` into uppercase, and converts all other letters into lowercase, then it returns the result.

`str` data type can be a character type such as CHARACTER, CHARACTER VARYING, CHARACTER LONG VARYING.

Each word in string is classified by white space or characters which are not alphanumeric. If `str` is NULL, the result is also NULL.

The return type is as same as `str` argument datatype.

Example

```
gSQL> SELECT INITCAP( 'hi GLIESE' ) AS RESULT FROM DUAL;  
RESULT  
-----  
Hi Gliese  
1 row selected.
```

INSTR

Syntax

```
INSTR( str, substr [, position [, occurrence ] ] )
```

Description

It search for occurrenceth substr starting from str's position, and returns its location.

The data types of str arguments and substr arguments can be a character type such as CHARACTER, CHARACTER VARYING, CHARACTER LONG VARYING, or a binary character type such as BINARY, BINARY VARYING, BINARY LONG VARYING.

The position argument and the occurrence argument can be numeric data type.

If position and occurrence are omitted, the default is 1.

The position and occurrence start from 1, and they are calculated in character unit according to character set (not in byte unit).

The position means the first position to search substr in str, it should not be zero, but an integer value.

- If the position is positive: It compares forwards (toward the right) from the beginning of str until it finds the position of substr.
- If the position is negative: It compares backwards (toward the left) from the end of str it finds the position of substr.
- If the position is 0: The result is 0.

The occurrence means the number of repeating the subtr in the str, and it should be a positive integer.

Example

```
gSQL> SELECT INSTR( 'INSTR( STR, SUBSTR )', 'SUB' ) AS RESULT1,
              INSTR( 'INSTR( STR, SUBSTR )', 'SUB', 5 ) AS RESULT2
        FROM DUAL;
RESULT1 RESULT2
-----
      13      13
1 row selected.
gSQL> SELECT INSTR( 'INSTR( STR, SUBSTR )', 'STR', 6, 2 ) AS RESULT1,
              INSTR( 'INSTR( STR, SUBSTR )', 'STR', -6, 2 ) AS RESULT2
```

```
FROM DUAL;  
RESULT1 RESULT2  
-----  
16      3  
1 row selected.
```

LAST_DAY

Syntax

```
LAST_DAY( date )
```

Description

It returns the last day of the month which is included in date.

The date argument data type can be DATE, TIMESTAMP, TIMESTAMP WITH TIME ZONE.
The return type is always DATE regardless of the date argument data type.

Example

```
gSQL> SELECT
      LAST_DAY( TO_DATE( '2012-07-10', 'YYYY-MM-DD' ) ) AS RESULT FROM DUAL;
RESULT
-----
2012-07-31
1 row selected.
```

LAST_IDENTITY_VALUE

Syntax

```
LAST_IDENTITY_VALUE()
```

Description

It is the recent value automatically created for an identity column in the current session, and the result type is NATIVE_BIGINT.

If there is not an automatically created value, then it returns null.

This function is similar to @@IDENTITY of MS-SQL and LAST_INSERT_ID() of MySQL. Be cautious when using it because the last altered table determines the value when performing DML for multiple tables as follows.

```
gSQL> INSERT INTO t1(name) VALUES ( 'leekmo' );
1 row created.
gSQL> SELECT LAST_IDENTITY_VALUE() FROM dual;
LAST_IDENTITY_VALUE()
-----
                        12
1 row selected.
gSQL> INSERT INTO t2(name) VALUES ( 'leekmo' );
1 row created.
gSQL> SELECT LAST_IDENTITY_VALUE() FROM dual;
LAST_IDENTITY_VALUE()
-----
                        2
1 row selected.
```

To obtain an identity column value created when performing the INSERT, use **INSERT INTO name RETURNING .. INTO** statement as follows.

```
gSQL> CREATE TABLE t1 ( id INTEGER GENERATED BY DEFAULT AS IDENTITY, name VARCHAR(32) );
Table created.
gSQL> \var v1 integer
gSQL> INSERT INTO t1(name) VALUES ( 'leekmo' ) RETURN id INTO :v1;
V1
--
```

```
1
```

```
1 row created.
```

Example

The following is an example of using `LAST_IDENTITY_VALUE()` function.

```
gSQL> CREATE TABLE t1 ( id  INTEGER GENERATED BY DEFAULT AS IDENTITY,  
                        name VARCHAR(32) );
```

```
Table created.
```

```
gSQL> COMMIT;
```

```
Commit complete.
```

- There is not an identity value created in the current session.

```
gSQL> SELECT LAST_IDENTITY_VALUE() FROM dual;
```

```
LAST_IDENTITY_VALUE()  
-----
```

```
                null
```

```
1 row selected.
```

- Identity value (1) is automatically created.

```
gSQL> INSERT INTO t1(name) VALUES ( 'leekmo' );
```

```
1 row created.
```

- Result: 1

```
gSQL> SELECT LAST_IDENTITY_VALUE() FROM dual;
```

```
LAST_IDENTITY_VALUE()  
-----
```

```
                1
```

```
1 row selected.
```

- Identity value (2) is automatically created as a default value.

```
gSQL> UPDATE t1 SET id = DEFAULT;
```

```
1 row updated.
```

- Result: 2

```
gSQL> SELECT LAST_IDENTITY_VALUE() FROM dual;
LAST_IDENTITY_VALUE()
-----
                        2
1 row selected.
```

- The user input value does not automatically create an identity value.

```
INSERT INTO t1 VALUES ( 100, 'jhkim' );
1 row updated.
```

- Result: 2

```
SELECT LAST_IDENTITY_VALUE() FROM dual;
LAST_IDENTITY_VALUE()
-----
                        2
1 row selected.
```

LEAST

Syntax

```
LEAST( expr1 [, expr2, ... exprn ] )
```

Description

It returns the smallest value among received expr arguments.

If any of expr is NULL, the result is NULL.

The result type is determined according to the data type of expr1 (the first expr).

If the data type of expr1 (the first expr) is a character type and a numeric type then it becomes the type including the range of expr1, ..., exprN each.

If all of expr1, ..., exprN is described in CHAR type, then all exprs are compared in VARCHAR type and the result type is VARCHAR.

Example

```
gSQL> SELECT LEAST( 100, 0, 200, 150, 1 ) AS RESULT FROM DUAL;  
RESULT  
-----  
      0  
1 row selected.
```

LENGTH

Syntax

```
LENGTH( str )
```

Description

It is an alias of `CHAR_LENGTH`.

Example

Multi byte character set: (e.g.UTF8)

```
gSQL> SELECT LENGTH( 'αβ-SUMMER' ) AS RESULT FROM DUAL;  
RESULT  
-----  
          9  
1 row selected.
```

LENGTHB

Syntax

```
LENGTHB( str )
```

Description

It is an alias of `OCTET_LENGTH`.

For more information, refer to `BYTE_LENGTH`.

Example

- Multi byte character set (e.g.UTF8): 1 byte character

```
gSQL> SELECT LENGTHB( 'OCTET_LENGTH' ) AS RESULT_1BYTE_CHARACTERS
        FROM DUAL;
RESULT_1BYTE_CHARACTERS
-----
                        12
1 row selected.
```

- Multi byte character set (e.g.UTF8): 2 byte character

```
gSQL> SELECT LENGTHB( 'αβ' ) AS RESULT_2BYTE_CHARACTERS FROM DUAL;
RESULT_2BYTE_CHARACTERS
-----
                        4
1 row selected.
```

LN

Syntax

```
LN( num )
```

Description

It returns the natural logarithm value of num.
num should be a value which is bigger than 0.

Example

```
gSQL> SELECT LN( 2.71828182845905 ) AS RESULT FROM DUAL;  
RESULT  
-----  
      1  
1 row selected.
```

LOCALTIME

Syntax

```
LOCALTIME [()]  
STATEMENT_LOCALTIME()
```

Description

The current TIME WITHOUT TIME ZONE type value based on the session time is obtained.

LOCALTIME is an SQL standard function.

The differences among the functions to obtain the current time are as follows.

- TRANSACTION_LOCALTIME(): All time values in the transaction are same.
- LOCALTIME, STATEMENT_LOCALTIME(): All time values in an SQL statement are same.
- CLOCK_LOCALTIME(): Whenever the function is called, the current time value is obtained.

Example

All rows have the same value.

```
gSQL> SELECT LOCALTIME FROM t1;  
LOCALTIME  
-----  
16:17:08.592459  
16:17:08.592459  
16:17:08.592459  
3 rows selected.
```

LOCALTIMESTAMP

Syntax

```
LOCALTIMESTAMP [()]  
STATEMENT_LOCALTIMESTAMP()
```

Description

The current `TIMESTAMP WITHOUT TIME ZONE` type value based on the session time is obtained.

`LOCALTIMESTAMP` is an SQL standard function.

The differences among the functions to obtain the current `TIMESTAMP` are as follows.

- `TRANSACTION_LOCALTIMESTAMP()`: All `TIMESTAMP` values in the transaction are same.
- `LOCALTIMESTAMP`, `STATEMENT_LOCALTIMESTAMP()`: All `TIMESTAMP` values in an SQL statement are same.
- `CLOCK_LOCALTIMESTAMP()`: Whenever the function is called, the current timestamp value is obtained.

Example

All rows have the same value.

```
gSQL> SELECT LOCALTIMESTAMP FROM t1;  
LOCALTIMESTAMP  
-----  
2013-12-12 16:21:51.790614  
2013-12-12 16:21:51.790614  
2013-12-12 16:21:51.790614  
3 rows selected.
```

LOCAL_GROUP_ID

Syntax

`LOCAL_GROUP_ID()`

Description

It returns a cluster group ID for a server which processes a query from a user.



It is a valid information in a cluster system.

Example

All rows have the same value.

```
gSQL> SELECT LOCAL_GROUP_ID() FROM DUAL;  
LOCAL_GROUP_ID()  
-----  
1  
1 row selected.
```

LOCAL_GROUP_NAME

Syntax

```
LOCAL_GROUP_NAME()
```

Description

It returns a cluster group name for a server which processes a query from a user.



It is a valid information in a cluster system.

Example

All rows have the same value.

```
gSQL> SELECT LOCAL_GROUP_NAME() FROM DUAL;  
LOCAL_GROUP_NAME()  
-----  
G1  
1 row selected.
```

LOCAL_MEMBER_ID

Syntax

LOCAL_MEMBER_ID()

Description

It returns a cluster member ID for a server which processes a query from a user.



It is a valid information in a cluster system.

Example

All rows have the same value.

```
gSQL> SELECT LOCAL_MEMBER_ID() FROM DUAL;  
LOCAL_MEMBER_ID()  
-----  
1  
1 row selected.
```

LOCAL_MEMBER_NAME

Syntax

```
LOCAL_MEMBER_NAME()
```

Description

It returns a cluster member name for a server which processes a query from a user.



It is a valid information in a cluster system.

Example

All rows have the same value.

```
gSQL> SELECT LOCAL_MEMBER_NAME() FROM DUAL;  
LOCAL_MEMBER_NAME()  
-----  
G1N1  
1 row selected.
```

LOG

Syntax

```
LOG( num2 )  
LOG( num1, num2 )
```

Description

It returns the logarithm of num2 in the num1 base.

If num1 is omitted, it returns the logarithm value whose base is 10.

num1 should be a positive number except 1 and 0, and num2 should be a positive number.

Example

```
gSQL> SELECT LOG( 100 ) AS RESULT1, LOG( 4, 16 ) AS RESULT2 FROM DUAL;  
RESULT1 RESULT2  
-----  
2         2  
1 row selected.
```

LOGON_USER

Syntax

```
LOGON_USER()
```

Description

It returns the logged-in user.

The user information is managed in three types as follows.

- Logon user: It is a user who performed login, and it is maintained until the connection is closed.
- Session user: It is as same as the first logon user, but it can be changed using the SET SESSION AUTHORIZATION statement.
- Current user: It is generally as same as the session user, but it is temporarily changed internally in system to control access when using the PSM, view.
 - The session user and current user is similar to the difference between the unix system's real user and the effective user.

Example

```
% gsql test test
gSQL> SELECT LOGON_USER() AS result FROM DUAL;
RESULT
-----
TEST
1 row selected.
```

LOWER

Syntax

```
LOWER( str )
```

Description

It returns lowercases of str.

The str argument data type can be a character type such as CHARACTER, CHARACTER VARYING, CHARACTER LONG VARYING.

If str is NULL, the result is also NULL.

The return type is the same datatype as the str argument.

Example

```
gSQL> SELECT LOWER( 'SPRING' ) AS RESULT FROM DUAL;  
RESULT  
-----  
spring  
1 row selected.
```

LPAD

Syntax

```
LPAD( str, length, [, fill] )
```

Description

It adds character string fill to the left side of str until the string length becomes length, then returns the result.

The str argument data type can be character type such as CHARACTER, CHARACTER VARYING, CHARACTER LONG VARYING, and a binary character type such as BINARY, BINARY VARYING, BINARY LONG VARYING.

The length argument is numeric type.

length means the number of characters, and its maximum range is the maximum precision of the result type.

If fill is omitted, a white space is added.

If str is longer than the length, it cuts the str as long as the length, then returns it.

If any of str, length, fill is NULL, the result is also NULL.

If length is 0 or a negative number, the result is NULL.

The following table describes the result types.

Table 11-59 Result type of LPAD

str type	Result type
CHAR or VARCHAR	VARCHAR
LONG VARCHAR	LONG VARCHAR
BINARY or VARBINARY	VARBINARY
LONG VARBINARY	LONG VARBINARY

Example

```
gSQL> SELECT LPAD( 'aa', 5, 'b' ) AS RESULT FROM DUAL;
RESULT
-----
bbbaa
1 row selected.
```

LTRIM

Syntax

```
LTRIM( trim_source [, trim_character ] )
```

Description

It removes the matching characters by comparing from the left side of trim_character in trim_source until the matching character does not exist. Then it returns the result.

The data type of trim_character argument and trim_source argument can be a character type such as CHARACTER, CHARACTER VARYING, CHARACTER LONG VARYING, and a binary character type such as BINARY, BINARY VARYING, BINARY LONG VARYING.

If any of trim_character, trim_source is NULL, the result is NULL.

If trim_character is omitted, a single blank space (' ') is specified by default.

The following table describes the result types.

Table 11-60 Result type of LTRIM

trim_source, trim_character type	Result type
CHAR or VARCHAR	VARCHAR
LONG VARCHAR	LONG VARCHAR
BINARY or VARBINARY	VARBINARY
LONG VARBINARY	LONG VARBINARY

Example

```
gSQL> SELECT LTRIM( '____LTRIM', '_' ) AS RESULT FROM DUAL;
RESULT
-----
LTRIM
1 row selected.
```

MAX

Syntax

```
MAX( [ ALL | DISTINCT ] expr )
```

Description

It is an aggregate function and the maximum value among rows' exprs is obtained.

If ALL is explicitly specified, aggregation is executed for all values.

If DISTINCT is explicitly specified, aggregation is executed for the values which exclude duplicate values.

If ALL or DISTINCT is not explicitly specified, it is processed in the same way as when ALL is specified.

MAX function returns the same result without being affected by the ALL and DISTINCT.

Example

```
gSQL> SELECT MAX(c1) FROM t1;
MAX(C1)
-----
      3
1 row selected.
```

MIN

Syntax

```
MIN( [ ALL | DISTINCT ] expr )
```

Description

It is an aggregate function and the minimum value among rows' exprs is obtained.

If ALL is explicitly specified, aggregation is executed for all values.

If DISTINCT is explicitly specified, aggregation is executed for the values which exclude duplicate values.

If ALL or DISTINCT is not explicitly specified, it is processed in the same way as when ALL is specified.

MIN function returns the same result without being affected by the ALL and DISTINCT.

Example

```
gSQL> SELECT MIN(c1) FROM t1;
MIN(C1)
-----
      1
1 row selected.
```

MOD

Syntax

```
MOD( num1, num2 )
```

Description

It divides num1 by num2, and returns the remainder.

The num1 argument and num2 argument can be a numeric data type.

If num2 is 0, an error is returned.

Example

```
gSQL> SELECT MOD(5, 4) AS RESULT1, MOD(-5, 4) AS RESULT2 FROM DUAL;
```

```
RESULT1 RESULT2
```

```
-----  
1      -1
```

```
1 row selected.
```

MONTHS_BETWEEN

구문

```
MONTHS_BETWEEN( date1, date2 )
```

Description

MONTHS_BETWEEN returns the number of months of which days between date2 and date1 are divided by 31.

If date1 or date2 is NULL, then the result is also NULL.

The date1 argument and date2 argument can be DATE, TIMESTAMP, TIMESTAMP WITH TIME ZONE type.

The result type is NUMBER.



If the same date (e.g. 2014-01-15 and 2014-02-15), or the last day of the month (e.g. 2014-08-31 and 2014-09-30) is included both in date1 and date2, then it returns the integer result regardless of the agreement of timestamp section (if it exists).

Example

```
gSQL> SELECT
      MONTHS_BETWEEN('2018-01-18', '2018-01-17')
    FROM DUAL;
MONTHS_BETWEEN('2018-01-18', '2018-01-17')
-----
                        3.225806451612903E-2
```

1 row selected.

```
gSQL> SELECT
      MONTHS_BETWEEN('2018-02-17', '2018-01-17')
    FROM DUAL;
MONTHS_BETWEEN('2018-02-17', '2018-01-17')
-----
                        1
```

1 row selected.

```
gSQL> SELECT
      MONTHS_BETWEEN('2018-02-28', '2018-01-31')
```

```
FROM DUAL;  
MONTHS_BETWEEN('2018-02-28', '2018-01-31')
```

1

1 row selected.

NEXT_DAY

Syntax

```
NEXT_DAY( date, day )
```

Description

It obtains a date of the day (day of week) which comes first after the given date (an argument).

The second day argument can be a string or a number which indicates the day.

- String: SUNDAY ~ SATURDAY or SUN ~ SAT
- Number: 1 (sunday) ~ 7 (saturday)

The return type is always DATE regardless of the input type of the date.

The hour, minute and second of the result value returns the same hour, minute and second of the input argument date.

Example

```
gSQL> SELECT NEXT_DAY( TO_DATE( '2010-05-01', 'YYYY-MM-DD' ),
                        'SUNDAY' ) AS RESULT1
```

```
FROM DUAL;
```

```
RESULT1
```

```
-----
```

```
2010-05-02
```

```
gSQL> SELECT NEXT_DAY( TO_DATE( '2010-05-01', 'YYYY-MM-DD' ),
                        'SUN' ) AS RESULT1
```

```
FROM DUAL;
```

```
RESULT1
```

```
-----
```

```
2010-05-02
```

```
gSQL> SELECT NEXT_DAY( TO_DATE( '2010-05-01', 'YYYY-MM-DD' ),
                        1 ) AS RESULT1
```

```
FROM DUAL;
```

```
RESULT1
```

```
-----
```

```
2010-05-02
```

```
gSQL> SELECT TO_CHAR( NEXT_DAY( TO_DATE( '2010-05-01', 'YYYY-MM-DD' ),
```

```
'SUNDAY' ),  
'YYYY-MM-DD HH24:MI:SS' ) AS RESULT2
```

```
FROM DUAL;
```

```
RESULT2
```

```
-----
```

```
2010-05-02 00:00:00
```

NEXTVAL

Syntax

```
seq_name.NEXTVAL  
NEXTVAL( seq_name )  
NEXT VALUE FOR seq_name
```

Description

It obtains the next value of the sequence object.

Example

```
gSQL> CREATE SEQUENCE seq;  
Sequence created.  
gSQL> COMMIT;  
Commit complete.  
gSQL> SELECT seq.NEXTVAL FROM dual;  
SEQ.NEXTVAL  
-----  
1  
1 row selected.  
gSQL> SELECT NEXTVAL( seq ) FROM dual;  
NEXTVAL( SEQ )  
-----  
2  
1 row selected.  
gSQL> SELECT NEXT VALUE FOR seq FROM dual;  
NEXT VALUE FOR SEQ  
-----  
3  
1 row selected.
```

NULLIF

Syntax

```
NULLIF( expr1, expr2 )
```

Description

If expr1 is equal to expr2, it returns NULL. If it is not equal it returns expr1 which is the first argument.

If the data types of expr1 and expr2 are different, the result type is determined by **Result Type Combination Rule**.

NULLIF can be expressed by using CASE as follows.

- NULLIF(expr1, expr2)

```
CASE WHEN expr1 = expr2 THEN NULL
      ELSE expr1
END
```

Example

```
gSQL> SELECT NULLIF( 'SUN', 'SUN' ) AS RESULT1,
              NULLIF( 'SUN', 'MOON' ) AS RESULT2
        FROM DUAL;
RESULT1 RESULT2
-----
null    SUN
1 row selected.
```

NVL

Syntax

```
NVL( expr1, expr2 )
```

Description

If expr1 is not NULL, then it returns expr1. If expr1 is NULL, it returns expr2.

The result type is determined according to the data type of expr1.

If NULL is described in expr1, then the result type is determined according to the data type of expr2.

If the data type of expr1 is a character type and a numeric type then it becomes the type including the range of expr1 and expr2 each.

If the data type of both expr1 and expr2 is CHAR type, then the result type is VARCHAR.

Example

```
gSQL> SELECT I1, NVL( I1, 0 ) FROM T1;
  I1 NVL( I1, 0 )
-----
   1           1
null           0
2 rows selected.
```

NVL2

Syntax

```
NVL2( expr1, expr2, expr3 )
```

Description

If expr1 is not null, then it returns expr2. If expr1 is NULL, it returns expr3.

The result type is determined according to the data type of expr2.

If NULL is described in expr2, then the result type is determined according to the data type of expr3.

If the data type of expr2 is a character type and a numeric type then it becomes the type including the range of expr2 and expr3 each.

If the data type of both expr2 and expr3 is CHAR type, then the result type is VARCHAR.

Example

```
gSQL> SELECT I1, NVL2( I1, I1 * 1000, 0 ) FROM T1;
  I1 NVL2( I1, I1 * 1000, 0 )
-----
   1                1000
null                  0
2 rows selected.
```

OCTET_LENGTH

Syntax

```
OCTET_LENGTH( str )  
BYTE_LENGTH( str )  
LENGTHB( str )
```

Description

It returns the number of bytes in str.

The str argument data type can be a character type such as CHARACTER, CHARACTER VARYING, CHARACTER LONG VARYING, or a binary character type such as BINARY, BINARY VARYING, BINARY LONGVARYING.

If the str data type is CHARACTER, the white spaces are included in the calculation.

If str is NULL, the result is also NULL.

It is an alias of **BYTE_LENGTH** and **LENGTHB**.

Example

- Multi byte character set (e.g. UTF8): 1 byte character

```
gSQL> SELECT OCTET_LENGTH( 'OCTET_LENGTH' ) AS RESULT_1BYTE_CHARACTERS  
        FROM DUAL;  
RESULT_1BYTE_CHARACTERS  
-----  
                            12  
1 row selected.
```

- Multi byte character set (e.g. UTF8): 2 byte character

```
gSQL> SELECT OCTET_LENGTH( 'αβ' ) AS RESULT_2BYTE_CHARACTERS FROM DUAL;  
RESULT_2BYTE_CHARACTERS  
-----  
                            4  
1 row selected.
```

OVERLAY

Syntax

```
OVERLAY( str1 PLACING str2 FROM start_position [ FOR string_length ] )
```

Description

It overlays the characters in the range between str1's start_position and string_length with str2.

The data types of str1 argument and str2 argument can be a character type such as CHARACTER, CHARACTER VARYING, CHARACTER LONG VARYING, or a binary character type such as BINARY, BINARY VARYING, BINARY LONG VARYING

The start_position argument and string_length argument can be numeric data type.

- OVERLAY function has the following result.
 - When FOR is specified.

```
SUBSTRING( str1 FROM 1 FOR (start_position - 1) )
|| str2
|| SUBSTRING( str1 FROM (start_position + string_length )
```
 - When FOR is omitted.

```
SUBSTRING( str1 FROM 1 FOR (start_position - 1) )
|| str2
|| SUBSTRING( str1 FROM (start_position + CHAR_LENGTH(str2))
```

For more information, refer to **SUBSTRING**.

The following table describes the result types.

Table 11-61 Result type of OVERLAY

str1, str2 types	Result type
CHAR or VARCHAR	VARCHAR
LONG VARCHAR	LONG VARCHAR
BINARY or VARBINARY	VARBINARY
LONG VARBINARY	LONG VARBINARY

Example

```
gSQL> SELECT  
      OVERLAY( 'RESULT_OF_XXX_FUNC' PLACING 'OVERLAY' FROM 11 FOR 3 )  
      AS RESULT  
      FROM DUAL;
```

```
RESULT
```

```
-----  
RESULT_OF_OVERLAY_FUNC
```

```
1 row selected.
```

PI

Syntax

PI()

Description

It returns " π " constant.

Example

```
gSQL> SELECT PI() AS RESULT FROM DUAL;  
          RESULT  
-----  
3.141592653589793E+0  
1 row selected.
```

POSITION

Syntax

```
POSITION( str1 IN str2 )
```

Description

It searches for the first str1 within str2, then returns its location.

The data type of str1 argument and str2 argument can be a character type such as CHARACTER, CHARACTER VARYING, CHARACTER LONG VARYING, or a binary character type BINARY, BINARY VARYING, BINARY LONG VARYING.

If str1 can not be found within str2, the return value is 0.

If str1 is found within str2, the position of str1 is returned, and the return value starts from 1.

The returned position value is calculated in character unit (not in byte unit).

If str1 or str2 is NULL, the return value is also NULL.

Example

```
gSQL> SELECT POSITION( 'CHAR' IN 'LONG CHAR 2000' ) AS RESULT FROM DUAL;
```

```
RESULT
```

```
-----
```

```
6
```

```
1 row selected.
```

POWER

Syntax

```
POWER( num1, num2 )
```

Description

It squares num1 to num2, and returns the result.

The num1 argument and num2 argument can be a numeric data type.

If num1 is a negative number, num2 should be an integer.

If num1 or num2 is NULL, the result is also NULL.

Example

```
gSQL> SELECT POWER( 2, 3 ) AS RESULT FROM DUAL;  
RESULT  
-----  
      8  
1 row selected.
```

RADIANS

Syntax

```
RADIANS( degrees )
```

Description

It returns the radians of degrees.

The degrees argument can be a numeric data type.

Example

```
gSQL> SELECT RADIANS( 180 ) AS RESULT FROM DUAL;  
          RESULT  
-----  
3.14159265358979  
1 row selected.
```

RANDOM

Syntax

```
RANDOM( min, max )
```

Description

It returns a random value in the range above min and below max.
The min argument and max argument can be a numeric data type.

Example

```
gSQL> SELECT RANDOM( 1, 100 ) AS RESULT FROM DUAL;  
          RESULT  
-----  
34.1870528003201  
1 row selected.
```

REPEAT

Syntax

```
REPEAT( str, num )
```

Description

The string repeats `str` as many times as specified in `num`, and returns the result.

The `str` argument can be a character type such as `CHARACTER`, `CHARACTER VARYING`, `CHARACTER LONG VARYING`, or a binary character type such as `BINARY`, `BINARY VARYING`, `BINARY LONG VARYING`.

The `num` argument can be a numeric data type.

If either `str` or `num` is `NULL`, the result is also `NULL`.

If `num` is 0 or a negative number, the result is also `NULL`.

The following table describes the result types.

Table 11-62 Result type of REPEAT

str type	Result type
CHAR or VARCHAR	VARCHAR
LONG VARCHAR	LONG VARCHAR
BINARY or VARBINARY	VARBINARY
LONG VARBINARY	LONG VARBINARY

Example

```
gSQL> SELECT REPEAT( 'ab', 3 ) AS RESULT FROM DUAL;  
RESULT  
-----  
ababab  
1 row selected.
```

REPLACE

Syntax

```
REPLACE( str, from, to )
```

Description

It replaces all *from* strings in *str* string with *to* strings, and returns the result.

The *str* argument, the *from* argument, and the *to* argument can be a character data types such as CHAR, CHARACTER, CHARACTER VARYING, CHARACTER LONG VARYING.

If *str* is NULL, the result is also NULL.

If *from* is NULL, the *str* is returned without replacement.

If *to* value is omitted or NULL, the *str* value of which *from* is removed is returned.

The following table describes the result types.

Table 11-63 Result type of REPLACE

str type	Result type
CHAR or VARCHAR	VARCHAR
LONG VARCHAR	LONG VARCHAR

Example

```
gSQL> SELECT REPLACE( 'HI GLIESE', 'HI', 'HELLO' ) AS RESULT FROM DUAL;
RESULT
-----
HELLO GLIESE
1 row selected.
```

REVERSE

Syntax

```
REVERSE( str )
```

Description

REVERSE returns characters of str in reverse order.

The str argument can be types which is convertible to a character string type or a binary string type. A character string type is performed in a character unit, and a binary stringtype can be performed in a byte unit.

If str is NULL, then it returns NULL.

The following table describes the arguments and result types.

Table 11-64 Argument and result type of REVERSE

str	Result type
CHAR	CHAR
VARCHAR	VARCHAR
LONG VARCHAR	LONG VARCHAR
BINARY	BINARY
VARBINARY	VARBINARY
LONG VARBINARY	LONG VARBINARY

Example

```
gSQL> SELECT REVERSE( 'GOLDILOCKS' ) AS RESULT FROM DUAL;
RESULT
-----
SKCOLIDLOG
1 row selected.
gSQL> SELECT REVERSE( '선재소프트 2018' ) AS RESULT FROM DUAL;
RESULT
-----
8102 트프소재선
1 row selected.
```

ROUND(number)

Syntax

```
ROUND( num [, scale ] )
```

Description

It rounds off num based on scale, and returns the result.

The num argument and scale argument can be a numeric data type.

If scale is omitted, the scale becomes 0 and is executed as if it is ROUND(num, 0).

If scale is a positive number, it is rounded off based on the number of right digit of the decimal point. If scale is a negative number, it is rounded off based on the number of left digit of the decimal point.

Example

```
gSQL> SELECT ROUND( 152.4282, 2 ) AS RESULT FROM DUAL;  
RESULT  
-----  
152.43  
1 row selected.  
gSQL> SELECT ROUND( 152.4282, -2 ) AS RESULT FROM DUAL;  
RESULT  
-----  
200  
1 row selected.
```

ROUND(date)

Syntax

```
ROUND( date [ , fmt ] )
```

Description

It rounds off the date in the specified `fmt` unit, and returns the result.

The data type of `date` argument can be `DATE`, `TIMESTAMP`, `TIMESTAMP WITH TIME ZONE`.

The `fmt` argument can be a character type such as `CHARACTER`, `CHARACTER VARYING`.

The result type is always `DATE` regardless of the `date` argument data type.

If `fmt` is omitted, the default is `DAY`.

The following table describes the available format strings.

Table 11-65 Available format string of `fmt`

String	Description
CC, SCC	It is represented in four digit year by rounding off from 51 year. (e.g. XX01)
YYYY, YEAR, SYYYY, SYEAR, YYY, YY, Y	It is rounded off from July 1st.
IYYY, IYY, IY, I	It is the year embracing the calendar week defined by ISO 8601 standards, and it is rounded off from July 1st.
Q	It is rounded off from the 16th day in the second month of the quarter.
MONTH, MON, MM, RM	It is rounded off from the 16th day.
WW	A week starts from January 1st of the year, and it is rounded off on wednesday 12 p.m of WEEK.
IW	It is the calendar week defined by ISO 8601 standards (1 ~ 52 week or 1 ~ 53 weeks), and it is rounded off on thursday 12 p.m.
W	A week starts from the 1st day of the month, and it is rounded off on wednesday 12 p.m of WEEK.
DDD, DD, J	It is rounded off at 12 p.m.
DAY, DY, D	It is rounded off on wednesday 12 p.m of WEEK.
HH, HH12, HH24	It is rounded off from 30 minutes.
MI	It is rounded off from 30 seconds.

Example

```
gSQL> SELECT
    ROUND( TO_DATE( '2051-07-16', 'YYYY-MM-DD' ), 'CC' ) AS RESULT
    FROM DUAL;
RESULT
-----
2101-01-01
1 row selected.
gSQL> SELECT
    ROUND( TO_DATE( '2051-07-16', 'YYYY-MM-DD' ), 'YYYY' ) AS RESULT
    FROM DUAL;
RESULT
-----
2052-01-01
1 row selected.
gSQL> SELECT
    ROUND( TO_DATE( '2051-07-16', 'YYYY-MM-DD' ), 'MONTH' ) AS RESULT
    FROM DUAL;
RESULT
-----
2051-08-01
1 row selected.
gSQL> SELECT
    ROUND( TO_TIMESTAMP( '2001-05-05 15:22:33.999999',
                        'YYYY-MM-DD HH24:MI:SS.FF6' ) ) AS RESULT
    FROM DUAL;
RESULT
-----
2001-05-06
1 row selected.
```

ROWID_GRID_BLOCK_ID

Syntax

```
ROWID_GRID_BLOCK_ID( rowid )
```

Description

It returns the GRID block ID.



It is a valid information in a cluster system.

Example

```
gSQL> SELECT C1, ROWID_GRID_BLOCK_ID( ROWID ) FROM T1;
C1 ROWID_GRID_BLOCK_ID( ROWID )
-- -----
1          52
2          52
3          52
3 rows selected.
```

ROWID_GRID_BLOCK_SEQ

Syntax

```
ROWID_GRID_BLOCK_SEQ( rowid )
```

Description

It returns the GRID block sequence.



It is a valid information in a cluster system.

Example

```
gSQL> SELECT C1, ROWID_GRID_BLOCK_SEQ( ROWID ) FROM T1;
C1 ROWID_GRID_BLOCK_SEQ( ROWID )
-- -----
1          747465
2          747466
3          747467
3 rows selected.
```

ROWID_MEMBER_ID

Syntax

```
ROWID_MEMBER_ID( rowid )
```

Description

It returns the member ID.



It is a valid information in a cluster system.

Example

```
gSQL> SELECT C1, ROWID_MEMBER_ID( ROWID ) FROM T1;
```

```
C1 ROWID_MEMBER_ID( ROWID )
```

```
-- -----
```

```
1 1
```

```
2 1
```

```
3 1
```

```
3 rows selected.
```

ROWID_OBJECT_ID

Syntax

```
ROWID_OBJECT_ID( rowid )
```

Description

It returns the object ID.



It is an invalid information in a cluster system.

Example

```
gSQL> SELECT ROWID_OBJECT_ID( t1.ROWID ) FROM t1;
```

```
ROWID_OBJECT_ID( T1.ROWID )
```

```
-----  
22012  
22012  
22012  
22012
```

```
4 rows selected.
```

ROWID_PAGE_ID

Syntax

`ROWID_PAGE_ID(rowid)`

Description

It returns the page ID.



It is an invalid information in a cluster system.

Example

```
gSQL> SELECT ROWID_PAGE_ID( t1.ROWID ) FROM t1;
```

```
ROWID_PAGE_ID( T1.ROWID )
```

```
-----
```

```
8227
```

```
8227
```

```
8227
```

```
8227
```

```
4 rows selected.
```

ROWID_ROW_NUMBER

Syntax

```
ROWID_ROW_NUMBER( rowid )
```

Description

It returns the row number.



It is an invalid information in a cluster system.

Example

```
gSQL> SELECT ROWID_ROW_NUMBER( t1.ROWID ) FROM t1;
```

```
ROWID_ROW_NUMBER( T1.ROWID )
```

```
-----  
0  
1  
2  
3
```

```
4 rows selected.
```

ROWID_SHARD_ID

Syntax

```
ROWID_SHARD_ID( rowid )
```

Description

It returns the shard ID.



It is a valid information in a cluster system.

Example

```
gSQL> SELECT C1, ROWID_SHARD_ID( ROWID ) FROM T1;
```

```
C1 ROWID_SHARD_ID( ROWID )
```

```
-- -----
```

```
1 0
```

```
2 1
```

```
3 2
```

```
3 rows selected.
```

ROWID_TABLESPACE_ID

Syntax

```
ROWID_TABLESPACE_ID( rowid )
```

Description

It returns the tablespace ID.



It is an invalid information in a cluster system.

Example

```
gSQL> SELECT ROWID_TABLESPACE_ID( t1.ROWID ) FROM t1;
```

```
ROWID_TABLESPACE_ID( T1.ROWID )
```

```
-----  
2  
2  
2  
2
```

```
4 rows selected.
```

ROWNUM

Syntax

ROWNUM

Description

It sequentially allocates a number starting from 1 to rows which satisfy the WHERE condition.

It allows using ROWNUM in WHERE clause for the compatibility with Oracle.

However, to restrict the number of the query results, it is recommended to use **offset limit clause** (the SQL standard) as follows.

- (Non standard) Describing the number of the results by using ROWNUM

```
gSQL> SELECT * FROM t1 WHERE ROWNUM <= 3;
C1
--
A
B
C
3 rows selected.
```

- (SQL standard) Describing the number of the results by using FETCH statement

```
gSQL> SELECT * FROM t1 FETCH 3;
C1
--
A
B
C
3 rows selected.
```

To restrict the range of the query results, it is recommended to use OFFSET, FETCH statement as follows.

- (Non standard) Describing the range of the number of the results by using ROWNUM

```
gSQL> SELECT c1
        FROM ( SELECT ROWNUM rn, c1
                FROM t1 )
```

```

        WHERE rn BETWEEN 2 AND 3;
C1
--
B
C
2 rows selected.

```

- (SQL standard) Describing the range of the number of the results by using ROWNUM OFFSET, FETCH statement

```

gSQL> SELECT c1 FROM t1 OFFSET 1 FETCH 2;
C1
--
B
C
2 rows selected.

```

It is not recommended to use ROWNUM in WHERE clause for any other uses than the restriction of the number of the results.

The results for the same query may be different according to the execution method as follows when using the ambiguous condition (WHERE c1 < ROWNUM + 3).

- Creating the data

```

CREATE TABLE t1 ( c1 INTEGER );
CREATE INDEX t1_idx ON t1(c1);
INSERT INTO t1 VALUES (1);
INSERT INTO t1 VALUES (2);
INSERT INTO t1 VALUES (3);
INSERT INTO t1 VALUES (4);
INSERT INTO t1 VALUES (5);
COMMIT;

```

- In case of Oracle

```

SQL> SELECT ROWNUM, c1 FROM t1 WHERE c1 < ROWNUM + 3;
  ROWNUM      C1
-----
1          1
2          2
SQL> DROP INDEX t1_idx;

```

- The index has been deleted.

```
SQL> SELECT ROWNUM, c1 FROM t1 WHERE c1 < ROWNUM + 3;
```

ROWNUM	C1
1	1
2	2
3	3
4	4
5	5

- In case of GOLDILOCKS

```
gSQL> SELECT ROWNUM, c1 FROM t1 WHERE c1 < ROWNUM + 3;
```

```
ROWNUM C1
```

ROWNUM	C1
1	1
2	2
3	3
4	4
5	5

5 rows selected.

```
gSQL> DROP INDEX t1_idx;
```

Index dropped.

```
gSQL> SELECT ROWNUM, c1 FROM t1 WHERE c1 < ROWNUM + 3;
```

```
ROWNUM C1
```

ROWNUM	C1
1	1
2	2
3	3
4	4
5	5

5 rows selected.

Example

```
gSQL> SELECT ROWNUM, c1 FROM t1;
```

```
ROWNUM C1
```

ROWNUM	C1
1	A
2	B

3 C

4 D

5 E

5 rows selected.

RPAD

Syntax

```
RPAD( str, length, [, fill] )
```

Description

It adds fill string to the right side of str until the string's length becomes length, and it returns the result.

The str argument can be a character type such as CHARACTER, CHARACTER VARYING, CHARACTER LONG VARYING, or a binary character type such as BINARY, BINARY VARYING, BINARY LONG VARYING.

The length argument can be a numeric type.

length means the number of characters, and its maximum range is the maximum PRECISION of the result type.

If fill is omitted, a white space is added.

If str is longer than length, it cuts the str as long as the length, then returns it.

If any of str, length, fill is NULL, the result is also NULL.

If length is 0 or a negative number, the result is NULL.

The following table describes the result types.

Table 11-66 Result type of RPAD

str type	Result type
CHAR or VARCHAR	VARCHAR
LONG VARCHAR	LONG VARCHAR
BINARY or VARBINARY	VARBINARY
LONG VARBINARY	LONG VARBINARY

Example

```
gSQL> SELECT RPAD( 'aa', 5, 'b' ) AS RESULT FROM DUAL;
RESULT
-----
aabbb
1 row selected.
```

RTRIM

Syntax

```
RTRIM( trim_source [, trim_character ] )
```

Description

It removes the matching characters by comparing from the right side of trim_character in trim_source until the matching character does not exist. Then it returns the result.

The data type of trim_character argument and trim_source argument can be a character type such as CHARACTER, CHARACTER VARYING, CHARACTER LONG VARYING or a binary data type such as BINARY, BINARY VARYING, BINARY LONG VARYING.

If any of trim_character, trim_source is NULL, the result is NULL.

If trim_character is omitted, a single blank space (' ') is specified by default.

The following table describes the result types.

Table 11-67 Result type of RTRIM

trim_source type, trim_character type	Result type
CHAR or VARCHAR	VARCHAR
LONG VARCHAR	LONG VARCHAR
BINARY or VARBINARY	VARBINARY
LONG VARBINARY	LONG VARBINARY

Example

```
gSQL> SELECT RTRIM( 'RTRIM_____', '_' ) AS RESULT FROM DUAL;
RESULT
-----
RTRIM
1 row selected.
```

SESSION_ID

Syntax

SESSION_ID()

Description

It obtains the current session ID.

Example

```
gSQL> SELECT SESSION_ID() FROM dual;
SESSION_ID()
-----
          4
1 row selected.
```

SESSION_SERIAL

Syntax

```
SESSION_SERIAL()
```

Description

It obtains the serial number of current session.

Example

```
gSQL> SELECT SESSION_SERIAL() FROM dual;
SESSION_SERIAL()
-----
                16
1 row selected.
```

SESSION_USER

Syntax

```
SESSION_USER[()]
```

Description

It returns the session user.

The user information is managed in three types as follows.

- Logon user: It is a user who performed login, and it is maintained until the connection is closed.
- Session user: It is as same as the first logon user, but it can be changed using the SET SESSION AUTHORIZATION statement.
- Current user: It is generally as same as the session user, but it is temporarily changed internally in system to control access when using the PSM, View.
 - The session user and current user is similar to the difference between the unix system's real user and the effective user.

Example

```
% gsql sys gliese
gSQL> SET SESSION AUTHORIZATION test;
Session set.
gSQL> SELECT LOGON_USER() AS result1, SESSION_USER() AS result2 FROM DUAL;
RESULT1 RESULT2
-----
SYS      TEST
1 row selected.
```

SHARD_GROUP_ID

Syntax

```
SHARD_GROUP_ID( table_name, shard_key_value [ , ... ] )
```

Description

It returns the group ID managing the shard which stores `shard_key_value` when the shard strategy is defined in the `table_name`.

The `table_name` (an input argument) should be described by an identifier. If an object corresponding to the `table_name` is not a base table, or if the shard strategy is not defined, then an error occurs.

The `shard_key_value` (an input argument) should be listed in an order of shard key column in the shard strategy defined in the `table_name`. If the number of `shard_key_value` and the number of shard key column is not same, then an error occurs.

The result type is `NATIVE_BIGINT`.



It is a valid information in a cluster system.

Example

```
gSQL> SELECT T1.C1, SHARD_GROUP_ID( T1, T1.C1 ) FROM T1;
```

```
C1 SHARD_GROUP_ID( T1, T1.C1 )
```

```
-- -----
```

```
A                1
```

```
B                2
```

```
C                3
```

3 rows selected.

```
gSQL> SELECT SHARD_GROUP_ID( T1, 'B' ) FROM DUAL;
```

```
SHARD_GROUP_ID( T1, 'B' )
```

```
-----
```

```
                2
```

1 row selected.

SHARD_GROUP_NAME

Syntax

```
SHARD_GROUP_NAME( table_name, shard_key_value [, ... ] )
```

Description

It returns the group NAME managing the shard which stores shard_key_value when the shard strategy is defined in the table_name.

The table_name (an input argument) should be described by an identifier. If an object corresponding to the table_name is not a base table, or if the shard strategy is not defined, then an error occurs.

The shard_key_value (an input argument) should be listed in an order of shard key column in the shard strategy defined in the table_name. If the number of shard_key_value and the number of shard key column is not same, then an error occurs.

The result type is VARCHAR.



It is a valid information in a cluster system.

Example

```
gSQL> SELECT T1.C1, SHARD_GROUP_NAME( T1, T1.C1 ) FROM T1;
C1 SHARD_GROUP_NAME( T1, T1.C1 )
-- -----
A  G1
B  G2
C  G3
3 rows selected.
gSQL> SELECT SHARD_GROUP_NAME( T1, 'B' ) FROM DUAL;
SHARD_GROUP_NAME( T1, 'B' )
-----
G2
1 row selected.
```

SHARD_ID

Syntax

```
SHARD_ID( table_name, shard_key_value [, ... ] )
```

Description

It returns the ID for the shard which stores `shard_key_value` when the shard strategy is defined in the table `table_name`.

The `table_name` (an input argument) should be described by an identifier. If an object corresponding to the `table_name` is not a base table, or if the shard strategy is not defined, then an error occurs.

The `shard_key_value` (an input argument) should be listed in an order of shard key column in the shard strategy defined in the `table_name`. If the number of `shard_key_value` and the number of shard key column is not same, then an error occurs.

The result type is `NATIVE_BIGINT`.



It is a valid information in a cluster system.

Example

```
gSQL> SELECT T1.C1, SHARD_ID( T1, T1.C1 ) FROM T1;
C1 SHARD_ID( T1, T1.C1 )
-- -----
A                0
B                1
C                2
3 rows selected.
gSQL> SELECT SHARD_ID( T1, 'B' ) FROM DUAL;
SHARD_ID( T1, 'B' )
-----
1
1 row selected.
```

SHARD_NAME

Syntax

```
SHARD_NAME( table_name, shard_key_value [, ... ] )
```

Description

It returns the NAME for the shard which stores shard_key_value when the shard strategy is defined in the table_name.

The table_name (an input argument) should be described by an identifier. If an object corresponding to the table_name is not a base table, or if the shard strategy is not defined, then an error occurs.

The shard_key_value (an input argument) should be listed in an order of shard key column in the shard strategy defined in the table_name. If the number of shard_key_value and the number of shard key column is not same, then an error occurs.

The result type is VARCHAR.



It is a valid information in a cluster system.

Example

```
gSQL> SELECT T1.C1, SHARD_NAME( T1, T1.C1 ) FROM T1;
C1 SHARD_NAME( T1, T1.C1 )
-- -----
A  S1
B  S2
C  S3
3 rows selected.
gSQL> SELECT SHARD_NAME( T1, 'B' ) FROM DUAL;
SHARD_NAME( T1, 'B' )
-----
S2
1 row selected.
```

SHIFT_LEFT

Syntax

```
SHIFT_LEFT( num, cnt )
```

Description

It moves num to the left as many as cnt bits, and returns the movement values.

The data type of input num argument and cnt argument can be NATIVE_SMALLINT, NATIVE_INTEGER, NATIVE_BIGINT, or the type which can be converted to NATIVE_BIGINT.

When converting to NATIVE_BIGINT type, the decimal point is truncated.

cnt is masked with 6 bit, and it is processed to a value in the range within 6 bit.

The result type is NATIVE_BIGINT.

Example

```
gSQL> SELECT SHIFT_LEFT( 7, 3 ) AS RESULT FROM DUAL;
```

```
RESULT
```

```
-----
```

```
56
```

```
1 row selected.
```

SHIFT_RIGHT

Syntax

```
SHIFT_RIGHT( num, cnt )
```

Description

It moves num to the right as many as cnt bits, and returns the movement values.

The data type of input num argument and cnt argument can be NATIVE_SMALLINT, NATIVE_INTEGER, NATIVE_BIGINT, or the type which can be converted to NATIVE_BIGINT.

When converting to NATIVE_BIGINT type, the decimal point is truncated.

cnt is masked with 6 bit, and it is processed to a value in the range within 6 bit.

The result type is NATIVE_BIGINT.

Example

```
gSQL> SELECT SHIFT_RIGHT( 56, 3 ) AS RESULT FROM DUAL;  
RESULT  
-----  
          7  
1 row selected.
```

SIGN

Syntax

```
SIGN( num )
```

Description

It returns the sign of num.

The num argument can be a numeric data type.

The return value is as follows.

- If $\text{num} < 0$, -1 is returned.
- If $\text{num} = 0$, 0 is returned.
- If $\text{num} > 0$, 1 is returned.

Example

```
gSQL> SELECT SIGN(-10) AS RESULT1,  
           SIGN(0) AS RESULT2,  
           SIGN(10) AS RESULT3 FROM DUAL;
```

```
RESULT1 RESULT2 RESULT3
```

```
-----  
-1      0      1
```

```
1 row selected.
```

SIN

Syntax

SIN(num)

Description

It returns the sine value of num.

Example

```
gSQL> SELECT SIN( 0 ) AS RESULT FROM DUAL;  
RESULT  
-----  
      0  
1 row selected.
```

SPLIT_PART

Syntax

```
SPLIT_PART( string, delimiter, field )
```

Description

It returns a character string of the field by specifying a character as delimiter within a string.

The data type of string argument and delimiter argument can be a character data type such as CHARACTER, CHARACTER VARYING, CHARACTER LONG VARYING.

The field argument can be a numeric data type.

If any of string, delimiter, field is NULL, the result is also NULL.

The value of field should be a numeric value above 1, and if it is 0 or a negative number, an error is returned.

The following table describes the result types.

Table 11-68 Result type of SPLIT_PART

string type	Result type
CHAR or VARCHAR	VARCHAR
LONG VARCHAR	LONG VARCHAR

Example

```
gSQL> SELECT SPLIT_PART( 'AB;CD;EF;GH', ';', 3 ) AS RESULT FROM DUAL;
RESULT
-----
EF
1 row selected.
```

SQRT

Syntax

`SQRT(num)`

Description

It returns the square root of num.

The num argument can be a numeric type, and it should not be a negative number, but above 0.

Example

```
gSQL> SELECT SQRT( 9 ) AS RESULT FROM DUAL;  
RESULT  
-----  
          3  
1 row selected.
```

STATEMENT_DATE

Syntax

```
STATEMENT_DATE()  
CURRENT_DATE [( )]
```

Description

The current date (DATE type) value is obtained.

The differences among the functions to obtain the current date are as follows.

- TRANSACTION_DATE(): All date values in the transaction are same.
- STATEMENT_DATE(): All date values in an SQL statement are same.
- CLOCK_DATE(): Whenever the function is called, the current date value is obtained.

Example

```
gSQL> SELECT STATEMENT_DATE() AS result FROM t1;  
RESULT  
-----  
2013-12-12  
2013-12-12  
2013-12-12  
3 rows selected.
```

STATEMENT_LOCALTIME

Syntax

```
STATEMENT_LOCALTIME()  
LOCALTIME [()]
```

Description

The current TIME WITHOUT TIME ZONE type value based on the session time is obtained.

LOCALTIME is an SQL standard function.

The differences among the functions to obtain the current time are as follows.

- TRANSACTION_LOCALTIME(): All time values in the transaction are same.
- STATEMENT_LOCALTIME(): All time values in an SQL statement are same.
- CLOCK_LOCALTIME(): Whenever the function is called, the current time value is obtained.

Example

All rows have the same time value.

```
gSQL> SELECT STATEMENT_LOCALTIME() AS result FROM t1;  
RESULT  
-----  
16:18:50.775870  
16:18:50.775870  
16:18:50.775870  
3 rows selected.
```

STATEMENT_LOCALTIMESTAMP

Syntax

```
STATEMENT_LOCALTIMESTAMP()  
LOCALTIMESTAMP [()]
```

Description

The current `TIMESTAMP WITHOUT TIME ZONE` type value based on the session time is obtained.

`LOCALTIMESTAMP` is an SQL standard function.

The differences among the functions to obtain the current timestamp are as follows.

- `TRANSACTION_LOCALTIMESTAMP()`: All timestamp values in the transaction are same.
- `STATEMENT_LOCALTIMESTAMP()`: All timestamp values in an SQL statement are same.
- `CLOCK_LOCALTIMESTAMP()`: Whenever the function is called, the current timestamp value is obtained.

Example

All rows have the same value.

```
gSQL> SELECT STATEMENT_LOCALTIMESTAMP() FROM t1;  
STATEMENT_LOCALTIMESTAMP()  
-----  
2013-12-12 16:23:39.782187  
2013-12-12 16:23:39.782187  
2013-12-12 16:23:39.782187  
3 rows selected.
```

STATEMENT_TIME

Syntax

```
STATEMENT_TIME()  
CURRENT_TIME [( )]
```

Description

The current TIME WITH TIME ZONE type value is obtained.

CURRENT_TIME is an SQL standard function.

The differences among the functions to obtain the current time are as follows.

- TRANSACTION_TIME(): All time values in the transaction are same.
- STATEMENT_TIME(): All time values in an SQL statement are same.
- CLOCK_TIME(): Whenever the function is called, the current time value is obtained.

Example

All rows have the same time value.

```
gSQL> SELECT STATEMENT_TIME() AS result FROM t1;  
RESULT  
-----  
16:28:19.268513 +09:00  
16:28:19.268513 +09:00  
16:28:19.268513 +09:00  
3 rows selected.
```

STATEMENT_TIMESTAMP

Syntax

```
STATEMENT_TIMESTAMP()  
CURRENT_TIMESTAMP [( )]
```

Description

The current `TIMESTAMP WITH TIME ZONE` type value is obtained.

`CURRENT_TIMESTAMP` is an SQL standard function.

The differences among the functions to obtain the current timestamp are as follows.

- `TRANSACTION_TIMESTAMP()`: All timestamp values in the transaction are same.
- `STATEMENT_TIMESTAMP()`: All timestamp values in an SQL statement are same.
- `CLOCK_TIMESTAMP()`: Whenever the function is called, the current timestamp value is obtained.

Example

All rows have the same value.

```
gSQL> SELECT STATEMENT_TIMESTAMP() AS result FROM t1;  
RESULT  
-----  
2013-12-12 16:36:11.032957 +09:00  
2013-12-12 16:36:11.032957 +09:00  
2013-12-12 16:36:11.032957 +09:00  
3 rows selected.
```

STATEMENT_VIEW_SCN

Syntax

STATEMENT_VIEW_SCN()

Description

It obtains VIEW SCN of the current STATEMENT.

Example

```
gSQL> SELECT STATEMENT_VIEW_SCN() FROM dual;
STATEMENT_VIEW_SCN()
-----
17697.658.17880
1 row selected.
```

STATEMENT_VIEW_SCN_DCN

Syntax

```
STATEMENT_VIEW_SCN_DCN()
```

Description

It obtains the Domain Change Number (DCN) value of the current STATEMENT's VIEW SCN.

Example

```
gSQL> SELECT STATEMENT_VIEW_SCN_DCN() FROM dual;
STATEMENT_VIEW_SCN_DCN()
-----
                           658
1 row selected.
```

STATEMENT_VIEW_SCN_GCN

Syntax

STATEMENT_VIEW_SCN_GCN()

Description

It obtains the Global Change Number (GCN) value of the current STATEMENT's VIEW SCN.

Example

```
gSQL> SELECT STATEMENT_VIEW_SCN_GCN() FROM dual;
STATEMENT_VIEW_SCN_GCN()
-----
                        17697
1 row selected.
```

STATEMENT_VIEW_SCN_LCN

Syntax

```
STATEMENT_VIEW_SCN_LCN()
```

Description

It obtains the Local Change Number (LCN) value of the current STATEMENT's VIEW SCN.

Example

```
gSQL> SELECT STATEMENT_VIEW_SCN_LCN() FROM dual;
STATEMENT_VIEW_SCN_LCN()
-----
                        17880
1 row selected.
```

STDDEV

Syntax

```
STDDEV( [ ALL | DISTINCT ] expr )
```

Description

It is an aggregation function, and it obtains the standard deviation of an expr set.

If ALL is specified, this function is performed for all values. If DISTINCT is specified, this function is performed for the values of which the duplicates were deleted from. If it is not specified, it is processed as if ALL is specified.

If the number of expr sets except for NULL after deleting the duplicates by using DISTINCT is one, then it returns 0 like as **VARIANCE**.

The following table describes the arguments and result types.

Table 11-69 Argument and result type of STDDEV

expr	Result type
NATIVE_INTEGER family <ul style="list-style-type: none"> NATIVE_SMALLINT NATIVE_INTEGER NATIVE_BIGINT 	NATIVE_DOUBLE
NUMBER	NUMBER
NATIVE_DOUBLE family <ul style="list-style-type: none"> NATIVE_REAL NATIVE_DOUBLE 	NATIVE_DOUBLE

GOLDILOCKS gets the standard deviation as follows.

- If the number of expr sets are 1, then it returns 0.
- If the number of expr sets are bigger than 1, It returns the value of **STDDEV_SAMP(expr)**.



The standard deviation is a positive square root of a variance, and it is obtained calculating the square root of the variance. In other words, the STDDEV function is as same as the square root of **VARIANCE** function.

```
STDDEV( [ ALL ] expr )
= SQRT( VARIANCE( [ ALL ] expr ) )
```

```
STDDEV( DISTINCT expr )  
= SQRT( VARIANCE( DISTINCT expr ) )
```

Example

```
gSQL> SELECT STDDEV(c1) FROM t1;  
      STDDEV(C1)  
-----  
11.4978258814438  
1 row selected.  
gSQL> SELECT STDDEV(ALL c1) FROM t1;  
      STDDEV(ALL C1)  
-----  
11.4978258814438  
1 row selected.  
gSQL> SELECT STDDEV(DISTINCT c1) FROM t1;  
      STDDEV(DISTINCT C1)  
-----  
      13.2759180473518  
1 row selected.
```

STDDEV_POP

Syntax

STDDEV_POP(expr)

Description

It is an aggregation function, and it obtains the population standard deviation of an expr set. If the number of expr sets except for NULL is one, then it returns 0.

The following table describes the arguments and result types.

Table 11-70 Argument and result type of STDDEV_POP

expr	Result type
NATIVE_INTEGER family <ul style="list-style-type: none"> NATIVE_SMALLINT NATIVE_INTEGER NATIVE_BIGINT 	NATIVE_DOUBLE
NUMBER	NUMBER
NATIVE_DOUBLE family <ul style="list-style-type: none"> NATIVE_REAL NATIVE_DOUBLE 	NATIVE_DOUBLE



The population standard deviation is a positive square root of a population variance, and it is obtained by calculating the square root of the population variance. In other words, the STDDEV_POP function is as same as the square root of **VAR_POP** function.

```
STDDEV_POP( expr )
= SQRT( VAR_POP( expr ) )
```

Example

```
gSQL> SELECT STDDEV_POP(c1) FROM t1;
STDDEV_POP(C1)
-----
10.283968105746
1 row selected.
```

STDDEV_SAMP

Syntax

```
STDDEV_SAMP( expr )
```

Description

It is an aggregation function, and it obtains the sample standard deviation of an expr set. If the number of expr sets except for NULL is one, then it returns NULL.

The following table describes the arguments and result types.

Table 11-71 Argument and result type of STDDEV_SAMP

expr	Result type
NATIVE_INTEGER family <ul style="list-style-type: none"> NATIVE_SMALLINT NATIVE_INTEGER NATIVE_BIGINT 	NATIVE_DOUBLE
NUMBER	NUMBER
NATIVE_DOUBLE family <ul style="list-style-type: none"> NATIVE_REAL NATIVE_DOUBLE 	NATIVE_DOUBLE



The sample standard deviation is a positive square root of a sample variance, and it is obtained by calculating the square root of the sample variance. In other words, the STDDEV_SAMP function is as same as the square root of **VAR_SAMP** function.

```
STDDEV_SAMP( expr )
= SQRT( VAR_SAMP( expr ) )
```

Example

```
gSQL> SELECT STDDEV_SAMP(c1) FROM t1;
STDDEV_SAMP(C1)
-----
11.4978258814438
1 row selected.
```

SUBSTR

Syntax

```
SUBSTR( str FROM start_position [ FOR string_length ] )  
SUBSTR( str, start_position [ , string_length ] )
```

Description

It is an alias of **SUBSTRING**.

Example

- Multi byte character set (e.g. UTF8): 1 byte character

```
gSQL> SELECT  
      SUBSTR( 'DATABASE MANAGEMENT SYSTEM', 10, 10 ) AS RESULT  
      FROM DUAL;  
RESULT  
-----  
MANAGEMENT  
1 row selected.
```

- Multi byte character set (e.g. UTF8): 2 bytes or 3 bytes character

```
gSQL> SELECT SUBSTR( ' " αβ ≠ AB " ', 2, 5 ) AS RESULT FROM DUAL;  
RESULT  
-----  
αβ ≠ AB  
1 row selected.
```

SUBSTRB

Syntax

```
SUBSTRB( str, start_position [ , string_length ] )
```

Description

It extracts characters which are within `string_length` range from `start_position`, and returns the result for `s`tr.

This function is as same as **SUBSTRING** function, except that `start_position` and `string_length` of the **SUBSTR** function are calculated in byte units.

Example

- Multi byte character set (e.g. UTF8): 1 byte character

```
gSQL> SELECT
      SUBSTRB( 'DATABASE MANAGEMENT SYSTEM', 10, 10 ) AS RESULT
FROM DUAL;
RESULT
-----
MANAGEMENT
1 row selected.
```

- Multi byte character set (e.g. UTF8): 2 bytes or 3 bytes character

```
gSQL> SELECT SUBSTRB( ' “ αβ ≠ AB ” ', 4, 11 ) AS RESULT FROM DUAL;
RESULT
-----
αβ ≠ AB
1 row selected.
```

SUBSTRING

Syntax

```
SUBSTRING( str FROM start_position [ FOR string_length ] )
SUBSTRING( str, start_position [ , string_length ] )
```

Description

It extracts characters which are within `string_length` range from `start_position`, and returns the result for `str`.

The `str` argument data type can be a character data type such as `CHARACTER`, `CHARACTER VARYING`, `CHARACTER LONG VARYING`, or a binary data type such as `BINARY`, `BINARY VARYING`, `BINARY LONG VARYING`.

The `start_position` argument and `string_length` argument can be a numeric data type.

If any of `str`, `start_position`, `string_length` is `NULL`, the result is `NULL`.

The `start_position` and `string_length` start from 1, and they are calculated in character unit according to character set (not in byte unit).

If `start_position` is 0, the `start_position` is assigned to 1.

If `start_position` is a positive number, it searches for the position forwards (towards right) from the beginning of `str`.

If `start_position` is a negative number, it searches for the position backwards (towards left) from the end of `str`.

If `string_length` is omitted, characters from the `start_position` to the last character of `str`, is returned.

If `string_length` is 0 or a negative number, the result is `NULL`.

If `start_position` > (`str` length), the result is `NULL`.

If $(\text{str length} + \text{start_position}) < 0$, the result is `NULL`.

It is an alias of **SUBSTR**.

For more information, refer to **SUBSTRB**.

The following table describes the result types.

Table 11-72 Result type of SUBSTRING

str type	Result type
CHAR or VARCHAR	VARCHAR

str type	Result type
LONG VARCHAR	LONG VARCHAR
BINARY or VARBINARY	VARBINARY
LONG VARBINARY	LONG VARBINARY

Example

- Multi byte character set (e.g. UTF8): 1 byte character

```
gSQL> SELECT
      SUBSTRING( 'DATABASE MANAGEMENT SYSTEM' FROM 10 FOR 10 ) AS RESULT
FROM DUAL;
RESULT
-----
MANAGEMENT
1 row selected.
```

- Multi byte character set (e.g. UTF8): 2 bytes or 3 bytes character

```
gSQL> SELECT SUBSTRING( ' " αβ ≠ AB " ' FROM 2 FOR 5 ) AS RESULT FROM DUAL;
RESULT
-----
αβ ≠ AB
1 row selected.
```

SUM

Syntax

```
SUM( [ ALL | DISTINCT ] expr )
```

Description

It is an aggregate function and the sum of expr value is obtained.

If ALL is explicitly specified, aggregation is executed for all values.

If DISTINCT is explicitly specified, aggregation is executed for the values which exclude duplicate values.

If ALL or DISTINCT is not explicitly specified, it is processed in the same way as when ALL is specified.

Example

```
gSQL> SELECT SUM(c1) FROM t1;
SUM(C1)
-----
      6
1 row selected.
```

SYSDATE

Syntax

SYSDATE

Description

It obtains the current DATE type value based on the OS time of the database server.

Example

```
gSQL> SELECT SYSDATE FROM t1;
SYSDATE
-----
2013-12-12
2013-12-12
2013-12-12
3 rows selected.
```

SYS_EXTRACT_UTC

Syntax

```
SYS_EXTRACT_UTC( datetime_with_timezone )
```

Description

It returns the UTC (Coordinated Universal Time—formerly Greenwich Mean Time) value. If the timezone is not specified, it is calculated as session time zone.

The data type of an input argument can be time, time with time zone, timestamp, timestamp with time zone.

The result type is time or timestamp type.

Example

```
gSQL> SELECT
      SYS_EXTRACT_UTC(
        TO_TIMESTAMP_TZ( '2017-05-25 21:13:32.123456 +09:00',
                        'YYYY-MM-DD HH24:MI:SS.FF6 TZH:TZM' )
        ) AS RESULT
      FROM DUAL;
RESULT
-----
2017-05-25 12:13:32.123456
1 row selected.
```

SYSTIME

Syntax

SYSTIME

Description

It obtains the current TIME WITH TIME ZONE type value based on the OS time of the database server.

Example

```
gSQL> SELECT SYSTIME FROM t1;
SYSTIME
-----
16:30:46.954941 +09:00
16:30:46.954941 +09:00
16:30:46.954941 +09:00
3 rows selected.
```

SYSTIMESTAMP

Syntax

SYSTIMESTAMP

Description

It obtains the current `TIMESTAMP WITH TIME ZONE` type value based on the OS time of the database server.

Example

```
gSQL> SELECT SYSTIMESTAMP FROM t1;
SYSTIMESTAMP
-----
2013-12-12 16:37:34.432241 +09:00
2013-12-12 16:37:34.432241 +09:00
2013-12-12 16:37:34.432241 +09:00
3 rows selected.
```

TAN

Syntax

TAN(num)

Description

It returns the tangent value of num in radians unit.

Example

```
gSQL> SELECT TAN( 1 ) AS RESULT FROM DUAL;  
          RESULT  
-----  
1.5574077246549  
1 row selected.
```

TO_BASE64

Syntax

```
TO_BASE64( str )
```

Description

It converts `str` by using base64 encoding, and returns the converted character.

`str` argument can be a character type such as `CHARACTER`, `CHARACTER VARYING`, `CHARACTER LONG VARYING`, a type which can be converted to a character type, or a binary character type such as `BINARY`, `BINARY VARYING`, `BINARY LONG VARYING`.

The result type is a character such as `CHARACTER VARYING` or `CHARACTER LONG VARYING`.

If `str` is `NULL`, the result value is also `NULL`.

Base64 encoding represents 8 bit binary data in 64 characters consisting of ascii areas.

64 characters consist of `A~Z`, `a~z`, `0~9`, `+`, `/`.

6 bit is represented as a character, and three characters (24 bits) are represented with 4 characters as a unit.

If the encoded characters can not fill 4 characters, then others are filled with `'='`.

If encoded characters are over 76, then a newline is added and they are divided into multiple lines.

Use `FROM_BASE64()` function to decode the base64 encoded character.

The newline, carriage return, tab, space are ignored when decoding base64.

For more information, refer to [FROM_BASE64](#).

Example

```
gSQL> SELECT TO_BASE64( 'abc' ), TO_BASE64( 'abcd' ) FROM DUAL;
TO_BASE64( 'abc' ) TO_BASE64( 'abcd' )
-----
YWJj                YWJjZA==
1 row selected.
```

TO_CHAR(datetime)

Syntax

```
TO_CHAR( datetime [, fmt ] )
```

Description

It converts datetime to a string in the specified fmt format, and returns the result.

The datetime argument data type can be DATE, TIMESTAMP, TIMESTAMP WITH TIME ZONE, TIME, TIME WITH TIME ZONE, INTERVAL.

The fmt argument data type can be a character data type such as CHARACTER, CHARACTER VARYING.

If fmt is omitted, it follows the default format.

- DATE: Refer to **NLS_DATE_FORMAT**.
- TIMESTAMP: Refer to **NLS_TIMESTAMP_FORMAT**.
- TIMESTAMP WITH TIME ZONE: Refer to **NLS_TIMESTAMP_WITH_TIME_ZONE_FORMAT**.
- TIME: Refer to **NLS_TIME_FORMAT**.
- TIME WITH TIME ZONE: Refer to **NLS_TIME_WITH_TIME_ZONE_FORMAT**.

If the data type of the datetime argument is INTERVAL, it is converted to a string then returned regardless of fmt.

For more information about the string which can be specified in fmt, refer to **Datetime Format String**.

The result type is CHARACTER VARYING.

Example

The following is an example of when fmt is omitted, and NLS_DATE_FORMAT = 'YYYY-MM-DD'.

```
gSQL> SELECT
      TO_CHAR( TO_DATE( '2012-03-15', 'YYYY-MM-DD' ) ) AS RESULT
FROM DUAL;
RESULT
-----
2012-03-15
1 row selected.
```

The following is an example of when fmt is specified.

```
gSQL> SELECT  
      TO_CHAR( TO_DATE('2012-03-15','YYYY-MM-DD'), 'DD-MON-YY' ) AS RESULT  
      FROM DUAL;
```

RESULT

15-MAR-12

1 row selected.

TO_CHAR(number)

Syntax

```
TO_CHAR( number [, fmt ] )
```

Description

It converts the number to a string in the specified fmt format, and returns the result.

The number argument can be a numeric data type.

The fmt argument data type can be a character data type such as CHARACTER, CHARACTER VARYING.

If fmt is omitted, all significant digits are converted to the string and returned.

For more information about the string which can be specified in fmt, refer to **Number Format String**.

The result type is CHARACTER VARYING.

Example

```
gSQL> SELECT TO_CHAR( 12500000 ) AS RESULT FROM DUAL;
RESULT
-----
12500000
1 row selected.
gSQL> SELECT TO_CHAR( 12500000, 'S999,999,999' ) AS RESULT FROM DUAL;
RESULT
-----
+12,500,000
1 row selected.
```

TO_DATE

Syntax

```
TO_DATE( str [, fmt ] )
```

Description

It converts the str string in the specified fmt format to DATE type, and returns the result.

The str argument and fmt argument data type can be a character data type such as CHARACTER, CHARACTER VARYING, CHARACTER LONG VARYING.

If fmt is omitted, the default format is NLS_DATE_FORMAT, and in this case str should be the default format string.

For more information about the string which can be specified in fmt, refer to **Datetime Format String**. For more information, refer to **NLS_DATE_FORMAT**.

The result type is DATE.

Example

The following is an example of when fmt is omitted, and NLS_DATE_FORMAT = 'YYYY-MM-DD'.

```
gSQL> SELECT TO_DATE( '2009-07-29' ) AS RESULT FROM DUAL;
RESULT
-----
2009-07-29
1 row selected.
```

The following is an example of when fmt is specified.

```
gSQL> SELECT TO_DATE( '29-JUL-09', 'DD-MON-YY' ) AS RESULT FROM DUAL;
RESULT
-----
2009-07-29
1 row selected.
```

TO_NATIVE_DOUBLE

Syntax

```
TO_NATIVE_DOUBLE( str [, fmt ] )
```

Description

It converts the `str` string in the specified `fmt` format to `NATIVE_DOUBLE` type, and returns the result.

The data type of `str` argument and `fmt` argument can be a character data type such as `CHARACTER`, `CHARACTER VARYING`, `CHARACTER LONG VARYING`.

If any of `str`, `fmt` is `NULL`, the result is also `NULL`.

For more information about the string which can be specified in `fmt`, refer to **Number Format String**.

The result type is `NATIVE_DOUBLE`.

Example

```
gSQL> SELECT TO_NATIVE_DOUBLE( '123.45' ) AS RESULT1,  
            TO_NATIVE_DOUBLE( '+123.45', 'S999.99' ) AS RESULT2  
            FROM DUAL;  
RESULT1 RESULT2  
-----  
123.45  123.45  
1 row selected.
```

TO_NATIVE_REAL

Syntax

```
TO_NATIVE_REAL( str [, fmt ] )
```

Description

It converts the `str` string in the specified `fmt` format to `NATIVE_REAL` type, and returns the result.

The data type of `str` argument and `fmt` argument can be a character data type such as `CHARACTER`, `CHARACTER VARYING`, `CHARACTER LONG VARYING`.

If any of `str`, `fmt` is `NULL`, the result is also `NULL`.

For more information about the string which can be specified in `fmt`, refer to **Number Format String**.

The result type is `NATIVE_REAL`.

Example

```
gSQL> SELECT TO_NATIVE_REAL( '123.45' ) AS RESULT1,  
            TO_NATIVE_REAL( '+123.45', 'S999.99' ) AS RESULT2  
        FROM DUAL;  
RESULT1 RESULT2  
-----  
123.45  123.45
```

TO_NUMBER

Syntax

```
TO_NUMBER( str [, fmt] )
```

Description

It converts the `str` string in the specified `fmt` format to `NUMBER` type, and returns the result.

The data type of `str` argument and `fmt` argument can be a character data type such as `CHARACTER`, `CHARACTER VARYING`, `CHARACTER LONG VARYING`.

If any of `str`, `fmt` is `NULL`, the result is also `NULL`.

For more information about the string which can be specified in `fmt`, refer to **Number Format String**.

The result type is `NUMBER`.

Example

```
gSQL> SELECT TO_NUMBER( '123.45' ) AS RESULT1,  
            TO_NUMBER( '+123.45', 'S999.99' ) AS RESULT2  
        FROM DUAL;  
RESULT1 RESULT2  
-----  
123.45  123.45  
1 row selected.
```

TO_TIME

Syntax

```
TO_TIME( str [, fmt ] )
```

Description

It converts the str string in the specified fmt format to TIME type, and returns the result.

The data type of str argument and fmt argument can be a character data type such as CHARACTER, CHARACTER VARYING, CHARACTER LONG VARYING.

If fmt is omitted, the default format is NLS_TIME_FORMAT, and in this case str should be the default format string.

For more information about the string which can be specified in fmt, refer to **Datetime Format String**. For more information, refer to **NLS_TIME_FORMAT**.

The result type is TIME.

Example

The following is an example of when fmt is omitted, and NLS_TIME_FORMAT = 'HH24:MI:SS.FF6'.

```
gSQL> SELECT TO_TIME( '11:22:33.999999' ) AS RESULT FROM DUAL;
RESULT
-----
11:22:33.999999
1 row selected.
```

The following is an example of when fmt is specified.

```
gSQL> SELECT
      TO_TIME( '112233.999999/P.M.', 'HH12MISS.FF6/P.M.' ) AS RESULT
FROM DUAL;
RESULT
-----
23:22:33.999999
1 row selected.
```

TO_TIME_TZ

Syntax

```
TO_TIME_TZ( str [, fmt ] )
```

Description

It is an alias of `TO_TIME_WITH_TIME_ZONE`.

For more information, refer to `NLS_TIME_WITH_TIME_ZONE_FORMAT`.

Example

The following is an example of when `fmt` is omitted, and `NLS_TIME_WITH_TIME_ZONE_FORMAT = 'HH24:MI:SS.FF6 TZH:TZM'`.

```
gSQL> SELECT TO_TIME_TZ( '11:22:33.999999 +09:00' ) AS RESULT FROM DUAL;
RESULT
-----
11:22:33.999999 +09:00
1 row selected.
```

The following is an example of when `fmt` is specified.

```
gSQL> SELECT TO_TIME_TZ( '11:22:33.999999 +09:00 PM',
                        'HH12:MI:SS.FF6 TZH:TZM PM' ) AS RESULT
        FROM DUAL;
RESULT
-----
23:22:33.999999 +09:00
1 row selected.
```



```
AS RESULT
FROM DUAL;
RESULT
-----
23:22:33.999999 +09:00
1 row selected.
```

TO_TIMESTAMP

Syntax

```
TO_TIMESTAMP( str [, fmt ] )
```

Description

It converts the str string in the specified fmt format to TIMESTAMP type, and returns the result.

The data type of str argument and fmt argument can be a character data type such as CHARACTER, CHARACTER VARYING, CHARACTER LONG VARYING.

If fmt is omitted, the default format is NLS_TIMESTAMP_FORMAT, and in this case str should be the default format string.

For more information about the string which can be specified in fmt, refer to **Datetime Format String**.

For more information, refer to **NLS_TIMESTAMP_FORMAT**.

The result type is TIMESTAMP.

Example

The following is an example of when fmt is omitted, and NLS_TIMESTAMP_FORMAT = 'YYYY-MM-DD HH24:MI:SS.FF6'.

```
gSQL> SELECT
      TO_TIMESTAMP( '2009-07-29 11:22:33.999999' ) AS RESULT
      FROM DUAL;
RESULT
-----
2009-07-29 11:22:33.999999
1 row selected.
```

The following is an example of when fmt is specified.

```
gSQL> SELECT
      TO_TIMESTAMP( '090729 112233999999 PM', 'YMMDD HH12MISSFF6 PM' )
      AS RESULT
      FROM DUAL;
RESULT
-----
```

2009-07-29 23:22:33.999999

1 row selected.

TO_TIMESTAMP_TZ

Syntax

```
TO_TIMESTAMP_TZ( str [, fmt ] )
```

Description

It is an alias of `TO_TIMESTAMP_WITH_TIME_ZONE`.

For more information, refer to `NLS_TIMESTAMP_WITH_TIME_ZONE_FORMAT`.

Example

The following is an example of when `fmt` is omitted, and `NLS_TIMESTAMP_WITH_TIME_ZONE_FORMAT = 'YYYY-MM-DD HH24:MI:SS.FF6 TZH:TZM'`.

```
gSQL> SELECT
      TO_TIMESTAMP_TZ( '2009-07-29 11:22:33.999999 +09:00' ) AS RESULT
    FROM DUAL;
RESULT
-----
2009-07-29 11:22:33.999999 +09:00
1 row selected.
```

The following is an example of when `fmt` is specified.

```
gSQL> SELECT
      TO_TIMESTAMP_TZ( '29-JUL-09 11:22:33.999999 +09:00',
                      'DD-MON-RR HH12:MI:SS.FF6 TZH:TZM' ) AS RESULT
    FROM DUAL;
RESULT
-----
2009-07-29 11:22:33.999999 +09:00
1 row selected.
```

TO_TIMESTAMP_WITH_TIME_ZONE

Syntax

```
TO_TIMESTAMP_WITH_TIME_ZONE( str [, fmt ] )
TO_TIMESTAMP_TZ( str [, fmt ] )
```

Description

It converts the `str` string in the specified `fmt` format to `TIMESTAMP WITH TIME ZONE` type, and returns the result.

The data type of `str` argument and `fmt` argument can be a character data type such as `CHARACTER`, `CHARACTER VARYING`, `CHARACTER LONG VARYING`.

If `fmt` is omitted, the default format is `NLS_TIMESTAMP_WITH_TIME_ZONE_FORMAT`, and in this case `str` should be the default format string.

For more information about the string which can be specified in `fmt`, refer to [Datetime Format String](#).

For more information, refer to `NLS_TIMESTAMP_WITH_TIME_ZONE_FORMAT`.

It is an alias of `TO_TIMESTAMP_TZ`.

The result type is `TIMESTAMP WITH TIME ZONE`.

Example

The following is an example of when `fmt` is omitted, and `NLS_TIMESTAMP_WITH_TIME_ZONE_FORMAT = 'YYYY-MM-DD HH24:MI:SS.FF6 TZH:TZM'`.

```
gSQL> SELECT
      TO_TIMESTAMP_WITH_TIME_ZONE( '2009-07-29 11:22:33.999999 +09:00' )
      AS RESULT
      FROM DUAL;
RESULT
-----
2009-07-29 11:22:33.999999 +09:00
1 row selected.
```

The following is an example of when `fmt` is specified.

```
gSQL> SELECT
      TO_TIMESTAMP_WITH_TIME_ZONE( '29-JUL-09 11:22:33.999999 +09:00' ,
                                   'DD-MON-RR HH12:MI:SS.FF6 TZH:TZM' )
      AS RESULT
      FROM DUAL;
RESULT
-----
2009-07-29 11:22:33.999999 +09:00
1 row selected.
```

TRANSACTION_DATE

Syntax

```
TRANSACTION_DATE()
```

Description

It obtains the current date (DATE type) value based on the session time.

The differences among the functions to obtain the current date are as follows.

- TRANSACTION_DATE(): All date values in the transaction are same.
- STATEMENT_DATE(): All date values in an SQL statement are same.
- CLOCK_DATE(): Whenever the function is called, the current date value is obtained.

Example

All date values are always same within a single transaction.

```
gSQL> SELECT TRANSACTION_DATE() FROM dual;
TRANSACTION_DATE()
-----
2013-12-12
1 row selected.
gSQL> SELECT TRANSACTION_DATE() FROM dual;
TRANSACTION_DATE()
-----
2013-12-12
1 row selected.
gSQL> COMMIT;
Commit complete.
gSQL> SELECT TRANSACTION_DATE() FROM dual;
TRANSACTION_DATE()
-----
2013-12-13
1 row selected.
```

TRANSACTION_LOCALTIME

Syntax

```
TRANSACTION_LOCALTIME()
```

Description

It obtains the current TIME WITHOUT TIME ZONE type value based on the session time.

The differences among the functions to obtain the current time are as follows.

- TRANSACTION_LOCALTIME(): All time values in the transaction are same.
- STATEMENT_LOCALTIME(): All time values in an SQL statement are same.
- CLOCK_LOCALTIME(): Whenever the function is called, the current time value is obtained.

Example

All time values are always same within a single transaction.

```
gSQL> SELECT TRANSACTION_LOCALTIME() FROM dual;
TRANSACTION_LOCALTIME()
-----
16:43:24.391834
1 row selected.
gSQL> SELECT TRANSACTION_LOCALTIME() FROM dual;
TRANSACTION_LOCALTIME()
-----
16:43:24.391834
1 row selected.
gSQL> COMMIT;
Commit complete.
gSQL> SELECT TRANSACTION_LOCALTIME() FROM dual;
TRANSACTION_LOCALTIME()
-----
16:43:32.651833
1 row selected.
```

TRANSACTION_LOCALTIMESTAMP

Syntax

```
TRANSACTION_LOCALTIMESTAMP()
```

Description

It obtains the current `TIMESTAMP WITHOUT TIME ZONE` type value based on the session time.

The differences among the functions to obtain the current timestamp are as follows.

- `TRANSACTION_LOCALTIMESTAMP()`: All timestamp values in the transaction are same.
- `STATEMENT_LOCALTIMESTAMP()`: All timestamp values in an SQL statement are same.
- `CLOCK_LOCALTIMESTAMP()`: Whenever the function is called, the current timestamp value is obtained.

Example

All timestamp values are always same within a single transaction.

```
gSQL> SELECT TRANSACTION_LOCALTIMESTAMP() FROM dual;
TRANSACTION_LOCALTIMESTAMP()
-----
2013-12-12 16:43:32.651833
1 row selected.
gSQL> SELECT TRANSACTION_LOCALTIMESTAMP() FROM dual;
TRANSACTION_LOCALTIMESTAMP()
-----
2013-12-12 16:43:32.651833
1 row selected.
gSQL> COMMIT;
Commit complete.
gSQL> SELECT TRANSACTION_LOCALTIMESTAMP() FROM dual;
TRANSACTION_LOCALTIMESTAMP()
-----
2013-12-12 16:46:07.831834
1 row selected.
```

TRANSACTION_TIME

Syntax

```
TRANSACTION_TIME()
```

Description

It obtains the current TIME WITH TIME ZONE type value based on the session time.

The differences among the functions to obtain the current time are as follows.

- TRANSACTION_TIME(): All time values in the transaction are same.
- STATEMENT_TIME(): All time values in an SQL statement are same.
- CLOCK_TIME(): Whenever the function is called, the current time value is obtained.

Example

All time values are always same within a single transaction.

```
gSQL> SELECT TRANSACTION_TIME() FROM dual;
TRANSACTION_TIME()
-----
16:46:07.831834 +09:00
1 row selected.
gSQL> SELECT TRANSACTION_TIME() FROM dual;
TRANSACTION_TIME()
-----
16:46:07.831834 +09:00
1 row selected.
gSQL> COMMIT;
Commit complete.
gSQL> SELECT TRANSACTION_TIME() FROM dual;
TRANSACTION_TIME()
-----
16:48:00.691827 +09:00
1 row selected.
```

TRANSACTION_TIMESTAMP

Syntax

```
TRANSACTION_TIMESTAMP()
```

Description

It obtains the current `TIMESTAMP WITH TIME ZONE` type value based on the session time.

The differences among the functions to obtain the current timestamp are as follows.

- `TRANSACTION_TIMESTAMP()`: All timestamp values in the transaction are same.
- `STATEMENT_TIMESTAMP()`: All timestamp values in an SQL statement are same.
- `CLOCK_TIMESTAMP()`: Whenever the function is called, the current timestamp value is obtained.

Example

All timestamp values are always same within a single transaction.

```
gSQL> SELECT TRANSACTION_TIMESTAMP() FROM dual;
TRANSACTION_TIMESTAMP()
-----
2013-12-12 16:48:00.691827 +09:00
1 row selected.
gSQL> SELECT TRANSACTION_TIMESTAMP() FROM dual;
TRANSACTION_TIMESTAMP()
-----
2013-12-12 16:48:00.691827 +09:00
1 row selected.
gSQL> COMMIT;
Commit complete.
gSQL> SELECT TRANSACTION_TIMESTAMP() FROM dual;
TRANSACTION_TIMESTAMP()
-----
2013-12-12 16:49:26.291827 +09:00
1 row selected.
```

TRANSLATE

Syntax

```
TRANSLATE( string, from, to )
```

Description

It converts all characters which are same as the characters in *from* to its corresponding characters in *to*. Then it returns the result.

The data type of the string argument, the from argument, and the to argument can be a data type such as CHARACTER, CHARACTER VARYING, CHARACTER LONG VARYING.

If any of *string*, *from*, *to* is NULL, the result is also NULL.

Characters in string which are not same as characters in *from*, are not replaced.

Characters in string which are same as characters in *from*, are replaced to its corresponding characters in *to*.

If the number of characters in *from* is bigger than the number of characters in *to*, the characters in *from* which does not correspond to the characters in *to*, are removed, and returned.

If the same characters are repeated multiple times in *from*, they are replaced with the first mapped character.

The following table describes the result types.

Table 11-73 Result type of TRANSLATE

string type	Result type
CHAR or VARCHAR	VARCHAR
LONG VARCHAR	LONG VARCHAR

Example

```
gSQL> SELECT TRANSLATE( '12345', '15', 'FL' ) AS RESULT FROM DUAL;
```

```
RESULT
```

```
-----
```

```
F234L
```

```
1 row selected.
```

```
gSQL> SELECT TRANSLATE( 'ABC12345', 'ABC12345', 'XYZ' ) AS RESULT FROM DUAL;
```

```
RESULT
```

XYZ

1 row selected.

```
gSQL> SELECT TRANSLATE( 'ABC12345ABC', 'ABCABCABC', 'XYZ^&*xyz' ) AS RESULT
      FROM DUAL;
```

RESULT

XYZ12345XYZ

1 row selected.

TRIM

Syntax

```
TRIM([ [ LEADING | TRAILING | BOTH ] [trim_character] FROM ] trim_source)
```

Description

It removes the matching characters by comparing trim_character in trim_source from the LEADING, TRAILING, BOTH direction until the matching character does not exist. Then it returns the result.

The trim_character argument and trim_source argument can be a character data type such as CHARACTER, CHARACTER VARYING, CHARACTER LONG VARYING or a binary character data type such as BINARY, BINARY VARYING, BINARY LONG VARYING.

If any of trim_character, trim_source is NULL, the result is NULL.

- [LEADING | TRAILING | BOTH]
 - LEADING: Removes trim_character from the beginning of trim_source.
 - TRAILING: Removes trim_character from the back of trim_source.
 - BOTH: Removes trim_character from the both direction (the beginning, the back) of trim_source.
- trim_character should be a single character.
- If trim_character is omitted, single blank space (' ') is specified by default.
- When FROM is specified
 - [LEADING | TRAILING | BOTH], trim_character or [LEADING | TRAILING | BOTH] trim_character should be specified.
 - e.g. TRIM(LEADING FROM ' abc') , TRIM('x' FROM 'xabc') , TRIM(LEADING 'x' FROM 'xabc')
 - If [LEADING | TRAILING | BOTH] is omitted, BOTH is specified by default.
- When FROM is omitted.
 - It is TRIM(trim_source), it is executed in the same way as TRIM(BOTH ' ' FROM trim_source).

The following table describes the result types.

Table 11-74 Result type of TRIM

trim_character, trim_source type	Result type
CHAR or VARCHAR	VARCHAR
LONG VARCHAR	LONG VARCHAR
BINARY or VARBINARY	VARBINARY
LONG VARBINARY	LONG VARBINARY

Example

```
gSQL> SELECT TRIM( LEADING '_' FROM '___TRIM FUNCTION___' ) AS RESULT
        FROM DUAL;
```

```
RESULT
```

```
-----
TRIM FUNCTION___
```

```
1 row selected.
```

```
gSQL> SELECT TRIM( TRAILING '_' FROM '___TRIM FUNCTION___' ) AS RESULT
        FROM DUAL;
```

```
RESULT
```

```
-----
___TRIM FUNCTION
```

```
1 row selected.
```

```
gSQL> SELECT TRIM( BOTH '_' FROM '___TRIM FUNCTION___' ) AS RESULT
        FROM DUAL;
```

```
RESULT
```

```
-----
TRIM FUNCTION
```

```
1 row selected.
```

TRUNC(number)

Syntax

```
TRUNC( num [ , scale ] )
```

Description

It truncates the num based on scale, then returns the result.

The num argument and scale argument can be a numeric type.

If scale is omitted, the scale becomes 0, and it is executed as same as TRUNC(num, 0).

If scale is a positive number, it is truncated based on the number of right digit of the decimal point.

If scale is a negative number, it is truncated off based on the number of left digit of the decimal point.

Example

```
gSQL> SELECT TRUNC( 142.4282, 2 ) AS RESULT FROM DUAL;  
RESULT  
-----  
142.42  
1 row selected.  
gSQL> SELECT TRUNC( 142.4282, -2 ) AS RESULT FROM DUAL;  
RESULT  
-----  
100  
1 row selected.
```

TRUNC(date)

Syntax

```
TRUNC( date [ , fmt ] )
```

Description

It truncates the date in a specified *fmt* unit, and returns the result.

The *date* argument data type can be DATE, TIMESTAMP, TIMESTAMP WITH TIME ZONE.

The *fmt* argument data type can be a character data type such as CHARACTER, CHARACTER VARYING.

The result type is always DATE regardless of the input date type.

If *fmt* is omitted, the default is *DAY*, and the available format string is described in the following table.

Table 11-75 Available format string in *fmt*

Format string	Description
CC, SCC	Century
YYYY, YEAR, SYYYY, SYEAR, YYY, YY, Y	Year
IYYY, IYY, IY, I	The year embracing the calendar week defined by ISO 8601 standards
Q	Quarter
MONTH, MON, MM, RM	Month
WW	The week whose first week starts from January 1st of the year
IW	The week containing the first thursday of the year designated as the calendar week by ISO 8601 standards (1 ~ 52 week or 1 ~ 53 weeks) becomes the first week.
W	The week whose first week starts from the first day of the month
DDD, DD, J	Day
DAY, DY, D	Day of week
HH, HH12, HH24	Hour
MI	Minute

Example

```
gSQL> SELECT
      TRUNC( TO_DATE( '2051-07-16', 'YYYY-MM-DD' ), 'CC' ) AS RESULT
FROM DUAL;
RESULT
```

```
-----
```

```
2001-01-01
```

```
1 row selected.
```

```
gSQL> SELECT
```

```
    TRUNC( TO_DATE( '2051-07-16', 'YYYY-MM-DD' ), 'YYYY' ) AS RESULT
```

```
    FROM DUAL;
```

```
RESULT
```

```
-----
```

```
2051-01-01
```

```
1 row selected.
```

```
gSQL> SELECT
```

```
    TRUNC( TO_DATE( '2051-07-16', 'YYYY-MM-DD' ), 'MONTH' ) AS RESULT
```

```
    FROM DUAL;
```

```
RESULT
```

```
-----
```

```
2051-07-01
```

```
1 row selected.
```

```
gSQL> SELECT
```

```
    TRUNC( TO_TIMESTAMP( '2001-05-05 11:22:33.999999',
```

```
        'YYYY-MM-DD HH24:MI:SS.FF6' ) ) AS RESULT
```

```
    FROM DUAL;
```

```
RESULT
```

```
-----
```

```
2001-05-05
```

```
1 row selected.
```

UPPER

Syntax

```
UPPER( str )
```

Description

It returns the uppercase characters of `str`.

The `str` argument can be a character data type such as `CHARACTER`, `CHARACTER VARYING`, `CHARACTER LONG VARYING`.

If `str` is `NULL`, the result is `NULL`.

The return type is as same as the `str` argument type.

Example

```
gSQL> SELECT UPPER( 'spring' ) AS RESULT FROM DUAL;  
RESULT  
-----  
SPRING  
1 row selected.
```

UNHEX

Syntax

```
UNHEX( str )
```

Description

str argument is a hexadecimal character and this function represents it as each byte and returns it as a binary string.

The input argument can be a character type such as CHARACTER VARYING, CHARACTER LONG VARYING. The result type is a binary character type such as BINARY VARYING or BINARY LONG VARYING.

If str is NULL, then the result value is also NULL.

If str includes a character which does not belong to the hexadecimal range, then it returns an error.

For more information, refer to [HEX](#).

Example

```
gSQL> SELECT UNHEX( HEX( 'abc' ) ) FROM DUAL;  
UNHEX( HEX( 'abc' ) )  
-----  
616263  
1 row selected.
```

UNHEX_TO_CHARSTR

Syntax

```
UNHEX_TO_CHARSTR( str )
```

Description

str argument is a hexadecimal character and this function represents it as each byte and returns it as a character string.

The input argument can be a character type such as CHARACTER VARYING, CHARACTER LONG VARYING. The result type is a character type such as CHARACTER VARYING, CHARACTER LONG VARYING.

If str is NULL, then the result value is also NULL.

If str includes a character which does not belong to the hexadecimal range, then it returns an error.

When returning it as a character string, it applies the currently applicable character set and returns the result value because the str argument is a hexadecimal character of an unknown data.

If it is not included in the currently applicable character set, then it returns an error.

For more information, refer to [HEX](#), [UNHEX](#).

Example

```
gSQL> SELECT UNHEX_TO_CHARSTR( '616263' ) FROM DUAL;
UNHEX_TO_CHARSTR( '616263' )
-----
abc
1 row selected.
gSQL> SELECT UNHEX_TO_CHARSTR( HEX( 'abc' ) ) FROM DUAL;
UNHEX_TO_CHARSTR( HEX( 'abc' ) )
-----
abc
1 row selected.
```

USER_ID

Syntax

USER_ID ()

Description

It obtains the current user's number ID.



In cluster system, the value may vary depending on the connected server.

It is recommended to use **CURRENT_USER** function obtaining the current username.

Example

```
% gsql test test
gSQL> SELECT USER_ID() FROM dual;
USER_ID()
-----
        6
1 row selected.
```

UUID

Syntax

UUID()

Description

It creates the universal unique identifier, then returns it.
The return type is VARBINARY type, and it internally consists of 16 bytes.

Example

```
gSQL> SELECT HEX( UUID() ) FROM DUAL;  
HEX( UUID() )  
-----  
E6F0A5C2387511E8B95259E479C2FD50  
1 row selected.
```

VAR_POP

Syntax

`VAR_POP(expr)`

Description

It is an aggregation function, and it obtains the population variance of an expr set. If the number of expr sets except for NULL is one, then it returns 0.

The following table describes the arguments and result types.

Table 11-76 Argument and result type of VAR_POP

expr	Result type
NATIVE_INTEGER family <ul style="list-style-type: none"> NATIVE_SMALLINT NATIVE_INTEGER NATIVE_BIGINT 	NATIVE_DOUBLE
NUMBER	NUMBER
NATIVE_DOUBLE family <ul style="list-style-type: none"> NATIVE_REAL NATIVE_DOUBLE 	NATIVE_DOUBLE



The population variance is a variance of the population (entire) group, and it is the average of the square value of deviation. In other words, it is calculated by extracting the population average (the entire average) from each value of the data, and squaring each value, then adding them together and dividing them by the number of datas in the population group.

This value is used to figure out how far each value is from the average value.

For more information, refer to `STDDEV_POP`.

Example

```
gSQL> SELECT VAR_POP(c1) FROM t1;
```

```
VAR_POP(C1)
```

```
-----
```

```
105.76
```

1 row selected.

VAR_SAMP

Syntax

`VAR_SAMP(expr)`

Description

It is an aggregation function, and it obtains the sample variance of an expr set. If the number of expr sets except for NULL is one, then it returns NULL.

The following table describes the arguments and result types.

Table 11-77 Argument and result type of VAR_SAMP

expr	Result type
NATIVE_INTEGER family <ul style="list-style-type: none"> NATIVE_SMALLINT NATIVE_INTEGER NATIVE_BIGINT 	NATIVE_DOUBLE
NUMBER	NUMBER
NATIVE_DOUBLE family <ul style="list-style-type: none"> NATIVE_REAL NATIVE_DOUBLE 	NATIVE_DOUBLE



Unlike the population variance dealing with the population (entire) group, the sample variance deals with the average and deviation of extracted samples. In other words, it is calculated by extracting the sample average from each value of the data, and squaring each value, then adding them together and dividing them by the number of datas in the population group minus 1. This value is used to figure out the variance of the population group.

For more information, refer to `STDDEV_SAMP`.

Example

```
gSQL> SELECT VAR_SAMP(c1) FROM t1;
VAR_SAMP(C1)
-----
          132.2
```

1 row selected.

VARIANCE

Syntax

```
VARIANCE( [ ALL | DISTINCT ] expr )
```

Description

It is an aggregation function, and it obtains the variance of an expr set.

If ALL is specified, this function is performed for all values. If DISTINCT is specified, this function is performed for the values of which the duplicates were deleted from. If it is not specified, it is processed as if ALL is specified.

If the number of expr sets except for NULL after deleting the duplicates by using DISTINCT is one, then it returns 0.

The following table describes the arguments and result types.

Table 11-78 Argument and result type of VARIANCE

expr	Result type
NATIVE_INTEGER family <ul style="list-style-type: none"> NATIVE_SMALLINT NATIVE_INTEGER NATIVE_BIGINT 	NATIVE_DOUBLE
NUMBER	NUMBER
NATIVE_DOUBLE family <ul style="list-style-type: none"> NATIVE_REAL NATIVE_DOUBLE 	NATIVE_DOUBLE



GOLDILOCKS gets the variance as follows.

- If the number of expr sets are 1, then it returns 0.
- If the number of expr sets are bigger than 1, It returns the value of **STDDEV_SAMP (expr)**.

For more information, refer to **STDDEV**.

Example

```
gSQL> SELECT VARIANCE(c1) FROM t1;
```

```
VARIANCE(C1)
```

```
-----
```

```
132.2
```

```
1 row selected.
```

```
gSQL> SELECT VARIANCE(ALL c1) FROM t1;
```

```
VARIANCE(ALL C1)
```

```
-----
```

```
132.2
```

```
1 row selected.
```

```
gSQL> SELECT VARIANCE(DISTINCT c1) FROM t1;
```

```
VARIANCE(DISTINCT C1)
```

```
-----
```

```
176.25
```

```
1 row selected.
```

VERSION

Syntax

VERSION()

Description

It obtains the product's version string.

Example

```
gSQL> SELECT VERSION() FROM dual;
```

```
VERSION()
```

```
-----
```

```
Release Name.X.X.X revision(XXXXX)
```

```
1 row selected.
```

WIDTH_BUCKET

Syntax

```
WIDTH_BUCKET( num, min, max, cnt )
```

Description

It creates a section of the same width as cnt within a range between specified min and max, and it returns the section location in which the num is located.

The data type of num argument, min argument, max argument and cnt argument can be a numeric data type.

min, max means the range for the section. If the min value is equal to the max value, an error is returned. cnt means the number of sections. The cnt value should be a positive number. If the cnt value is 0 or a negative number, an error is returned.

The section's location is numbered from one.

If any of num, min, max, cnt is NULL, the result is also NULL.

Example

```
gSQL> SELECT WIDTH_BUCKET( 5, 1, 20, 5 ) AS RESULT FROM DUAL;
```

```
RESULT
```

```
-----
```

```
2
```

```
1 row selected.
```

12.

SQL Languages

Structured Query Languages (SQL) are classified as follows.

- Data Definition Language
- Data Manipulation Language
- Data Query Language
- Control Language

12.1 Data Definition Language

DDL Related Statements

For more information, refer to the followings.

- Non-schema object DDL
 - Database Related Statements
 - Profile Related Statements
 - Audit Policy Related Statement
 - Authorization Related Statements
 - Schema Related Statements
 - Tablespace Related Statements
- SQL schema object DDL
 - Table Related Statements
 - Index Related Statements
 - View Related Statements
 - Sequence Related Statements
 - Synonym Related Statements
- Cluster object DDL
 - Cluster System Related Statements
 - Cluster Group Related Statements
 - Cluster Member Related Statements
 - Cluster Location Related Statements
 - Global Secondary Index Related Statements

Concepts of DDL

Data Definition Language (DDL) is an SQL language which creates, drops and alters SQL objects.

SQL objects of a database are listed in the following table. For more information, refer to the links in the following table.

Table 12-1 SQL objects types

Object type	Object	Description	Refer to
		It is an object which defines a password man	

Object type	Object	Description	Refer to
Non-schema object	Profile	agement policy.	Profile
	Audit policy	It is an object which defines the SQL audit policy.	Audit Policy
	User	It is a user object which consists of a set of privileges.	Authorization
	Schema	It is a logical position including SQL schema objects such as tables.	Schema
	Tablespace	It is a physical storage of objects such as tables, indexes, etc.	Tablespace
	Public synonym	It is a public synonym.	Public Synonym
SQL schema object	Table	It is a physical relation where the data is stored.	Table
	View	It is a logical relation which consists of queries.	View
	Index	It is an index objects to improve query performance.	Index
	Sequence	It is an object which generate sequence number.	Sequence
	Synonym	It is an object which declares an alias for an object.	Synonym
	Stored procedure	It is an user defined procedure object.	Stored Procedure
	Stored function	It is an user defined function object.	Stored Function
Cluster object	Cluster group	It is a cluster member set.	Cluster Group
	Cluster member	It is a data server which configures a cluster system.	Cluster Member
	Cluster location	It is a location object of a cluster member.	Cluster Location
	Shard	It is a set of rows which horizontally divides a cluster table.	Cluster Table and Shard
	Global secondary index	It is an index for the row identifier of a cluster.	Global Secondary Index

DDL and Transaction

A transaction of GOLDILOCKS includes not only DML statements such as INSERT, DELETE, UPDATE data, but also DDL statement such as CREATE, DROP, ALTER objects. Many DBMS performs implicit transactions of DDL. On the other hand, GOLDILOCKS includes a DDL statement in the transaction, and it guarantees the atomicity and consistency of transaction.

This feature is useful when a user needs to atomically perform batch DDL such as database migration or tool installation, or to recover a mistake through ROLLBACK when statement such as DROP TABLE or TRUNCATE

NCATE TABLE is executed by user mistake.

If the property of DDL statement is auto-commit, then it automatically commits when executing the statement. On the other hand, if it is not auto-commit, then it can rollback the transaction even after the statement was executed. Whether the DDL is auto-commit or not is queried by using **V\$SQL_COMMAND** view as follows.

```
gSQL>
SELECT command, auto_commit
  FROM V$SQL_COMMAND
 WHERE is_ddl = 'YES';
```

COMMAND	AUTO_COMMIT
ALTER AUDIT POLICY	YES
ALTER CLUSTER GROUP .. ADD CLUSTER MEMBER	YES
ALTER CLUSTER GROUP .. OFFLINE CLUSTER MEMBER	YES
ALTER DATABASE DROP INACTIVE CLUSTER MEMBERS	YES
ALTER DATABASE OFFLINE INACTIVE CLUSTER MEMBERS	YES
ALTER DATABASE RESET LOCAL CLUSTER MEMBER	YES
ALTER DATABASE ADD LOGFILE GROUP	YES
ALTER DATABASE ADD LOGFILE MEMBER	YES
ALTER DATABASE DROP LOGFILE GROUP	YES
ALTER DATABASE DROP LOGFILE MEMBER	YES
ALTER DATABASE RENAME LOGFILE	YES
ALTER DATABASE ARCHIVELOG	YES
ALTER DATABASE NOARCHIVELOG	YES
ALTER DATABASE CLEAR PASSWORD HISTORY	NO
ALTER FUNCTION	NO
ALTER INDEX AGING	NO
ALTER INDEX .. STORAGE	NO
ALTER INDEX .. RENAME	NO
ALTER PROCEDURE	NO
ALTER PROFILE	YES
ALTER SEQUENCE	YES
ALTER SYSTEM SWITCH LOGFILE	YES
ALTER TABLE .. ADD COLUMN	NO
ALTER TABLE .. SET UNUSED COLUMN	NO
ALTER TABLE .. ALTER COLUMN .. SET DEFAULT	NO
ALTER TABLE .. ALTER COLUMN .. DROP DEFAULT	NO
ALTER TABLE .. ALTER COLUMN .. SET NOT NULL	NO
ALTER TABLE .. ALTER COLUMN .. DROP NOT NULL	NO
ALTER TABLE .. ALTER COLUMN .. SET DATA TYPE	YES

ALTER TABLE .. ALTER COLUMN .. AS IDENTITY	NO
ALTER TABLE .. ALTER COLUMN .. DROP IDENTITY	NO
ALTER TABLE .. RENAME COLUMN	NO
ALTER TABLE .. STORAGE	NO
ALTER TABLE .. ADD CONSTRAINT	NO
ALTER TABLE .. ALTER CONSTRAINT	NO
ALTER TABLE .. DROP CONSTRAINT	NO
ALTER TABLE .. RENAME CONSTRAINT	NO
ALTER TABLE .. RENAME TO ..	NO
ALTER TABLE .. REBALANCE ..	YES
ALTER TABLE .. MOVE SHARD .. TO CLUSTER GROUP ..	YES
ALTER TABLE .. SPLIT SHARD .. INTO .. AT CLUSTER GROUP ..	YES
ALTER TABLE .. RENAME SHARD .. TO ..	NO
ALTER TABLE .. ADD SUPPLEMENTAL LOG	NO
ALTER TABLE .. ADD GLOBAL SECONDARY INDEX	NO
ALTER TABLE .. ALTER GLOBAL SECONDARY INDEX	NO
ALTER TABLE .. ALTER GLOBAL SECONDARY INDEX AGING	NO
ALTER TABLE .. DROP GLOBAL SECONDARY INDEX	NO
ALTER TABLE .. DROP SUPPLEMENTAL LOG	NO
ALTER TABLE .. READ ONLY	YES
ALTER TABLE .. READ WRITE	YES
ALTER TABLESPACE .. ADD	YES
ALTER TABLESPACE .. DROP	YES
ALTER TABLESPACE .. ONLINE	YES
ALTER TABLESPACE .. OFFLINE	YES
ALTER TABLESPACE .. RENAME TO	YES
ALTER TABLESPACE .. RENAME { DATAFILE MEMORY }	YES
ALTER USER	YES
ALTER USER .. IDENTIFIED BY	YES
ALTER VIEW	NO
ANALYZE SYSTEM COMPUTE STATISTICS	NO
ANALYZE SYSTEM DELETE STATISTICS	NO
ANALYZE TABLE .. [COMPUTE ESTIMATE] STATISTICS	YES
ANALYZE TABLE .. DELETE STATISTICS	NO
AUDIT POLICY	YES
COMMENT ON .. IS	NO
CREATE AUDIT POLICY	YES
CREATE CLUSTER GROUP	YES
CREATE FUNCTION	NO
CREATE INDEX	NO
CREATE PROCEDURE	NO

CREATE PROFILE	YES
CREATE SCHEMA	YES
CREATE SEQUENCE	YES
CREATE SYNONYM	NO
CREATE TABLE	NO
CREATE TABLE ... AS SELECT	NO
CREATE TABLESPACE	YES
CREATE USER	YES
CREATE VIEW	NO
DROP AUDIT POLICY	YES
DROP CLUSTER GROUP	YES
DROP FUNCTION	NO
DROP INDEX	NO
DROP PROCEDURE	NO
DROP PROFILE	YES
DROP SCHEMA	YES
DROP SEQUENCE	YES
DROP SYNONYM	NO
DROP TABLE	NO
DROP TABLESPACE	YES
DROP USER	YES
DROP VIEW	NO
GRANT .. ON DATABASE	NO
GRANT .. ON TABLESPACE	NO
GRANT .. ON SCHEMA	NO
GRANT .. ON TABLE	NO
GRANT USAGE ON ..	NO
GRANT .. ON PROCEDURE	NO
NOAUDIT POLICY	YES
REVOKE .. ON DATABASE	NO
REVOKE .. ON TABLESPACE	NO
REVOKE .. ON SCHEMA	NO
REVOKE .. ON TABLE	NO
REVOKE USAGE ON ..	NO
REVOKE .. ON PROCEDURE	NO
TRUNCATE TABLE	NO

106 rows selected.

The followings are examples of COMMIT and ROLLBACK when table-related DDL statements are included in the transactions, and examples of its effects on other transactions. The example shows that the transaction including DDL guarantees the transaction atomicity. In addition, it ensures the reading consistency of

the transaction, which is not affected by other transactions before transaction's commitment or when the transaction is rolled back.

Creating Object and Transaction

- Before committing or rolling back a transaction of creating table

When a table is created, and transaction is not committed, the table data can be manipulated on the DDL transaction as follows. However, other transactions are not allowed to enquire the table until the creating table transaction is committed. CREATE TABLE statement, like as INSERT statement, can not be queried by any other transaction until the transaction is committed.

- Transaction A: Table t1 is created but the transaction is not committed.

```
gSQL> CREATE TABLE t1 ( id INTEGER, name VARCHAR(128) );
Table created.
gSQL> INSERT INTO t1 VALUES ( 1, 'leekmo' );
1 row created.
gSQL> SELECT * FROM t1;
ID NAME
-- -----
1 leekmo
1 row selected.
```

As above, if table t1 is created on the transaction A and the transaction is not yet committed, the transaction B in another session can not enquire the table t1 and can not create the table named as t1.

- Transaction B: Table t1 can not be enquired until committing the transaction A.

```
gSQL> SELECT * FROM t1;
ERR-42000(16040): table or view does not exist :
SELECT * FROM t1
          *
ERROR at line 1:
```

- Table t1 can not be created until the transaction A is rolled back.

```
gSQL> CREATE TABLE t1 ( emp_no INTEGER );
ERR-HYT00(14026): resource busy or timeout expired
```

- After committing a transaction of creating table

If the transaction A is committed, table t1 can be enquired by the transaction B and CREATE TABLE statement returns a validation error to notify that the table t1 exists as follows.

- Transaction B: After committing the transaction A, the table can be enquired as follows.

```
gSQL> SELECT * FROM t1;
ID NAME
-- -----
1 leekmo
1 row selected.
```

- After the transaction A is committed, a validation error is returned.

```
gSQL> CREATE TABLE t1 ( emp_no INTEGER );
ERR-42000(16005): name 'PUBLIC.T1' is already used by an existing object :
CREATE TABLE t1 ( emp_no INTEGER )
          *
ERROR at line 1:
```

- After rolling back a transaction of creating table

If the transaction A is rolled back, creating table t1 is also rolled back, and table t1 can be created by the transaction B.

- Transaction B: The transaction A is rolled back and its state becomes as same as before creating table t1.

```
gSQL> SELECT * FROM t1;
ERR-42000(16040): table or view does not exist :
SELECT * FROM t1
          *
ERROR at line 1:
```

- The transaction A is rolled back and it can create the table t1.

```
gSQL> CREATE TABLE t1 ( emp_no INTEGER );
Table created.
```

Dropping Object and Transaction

- Before committing or rolling back a transaction of dropping table

When a table is dropped, and transaction is not committed, other transactions can enquire the dropped table until the DROP TABLE transaction is committed. DROP TABLE statement, like as DELETE statement, retrieves the state of before deleting the table when other transaction enquires it until the transaction is committed.

The following example describes the state which the transaction A drops the table t1, then it creates new table t1, and the transaction is not committed.

- Transaction A: There is a row having two columns in the table t1 before dropping the table.

```
gSQL> SELECT * FROM t1;
ID NAME
-- -----
1 leekmo
1 row selected.
```

- Dropping the existing table t1

```
gSQL> DROP TABLE t1;
Table dropped.
```

- Creating the new table t1

```
gSQL> CREATE TABLE t1 ( addr VARCHAR(128) );
Table created.
```

- Creating a new row in the newly created table t1

```
gSQL> INSERT INTO t1 VALUES ( 'Seoul, Korea' );
1 row created.
gSQL> SELECT * FROM t1;
ADDR
-----
Seoul, Korea
1 row selected.
```

If the transaction B enquires when the transaction A is not committed, the information which is before the transaction A is executed is obtained as follows. DROP TABLE statement, like as DELETE statement, does not affect any other transaction until the transaction is committed.

- Transaction B: The transaction B retrieves the table which is before the execution of the transaction A.

```
gSQL> SELECT * FROM t1;
ID NAME
-- -----
1 leekmo
1 row selected.
```

- After committing a transaction of dropping table

If the transaction A is committed, then the transaction B enquires the newly created table t1 as follows.

- Transaction B: After committing the transaction A, the transaction B enquires the newly created table t1.

```
gSQL> SELECT * FROM t1;
ADDR
-----
Seoul, Korea
1 row selected.
```

- After rolling back a transaction of dropping table

If the transaction A is rolled back, the transaction B enquires the table t1 which is before the execution of the transaction A as follows. Namely, if the transaction A is rolled back, the rollback transaction does not affect the data of which the transaction B enquires.

- Transaction B: If the transaction A is rolled back, the transaction B enquires the information which is before the execution of the transaction A.

```
gSQL> SELECT * FROM t1;
ID NAME
-- -----
1 leekmo
1 row selected.
```

Altering Object and Transaction

ALTER TABLE statement is used to alter the table structure. ALTER TABLE statement also ensures atomicity and consistency of the transaction like as CREATING TABLE or DROPPING TABLE statements. Before committing a transaction in which a column is added to a table, other transactions retrieve the information of the existing table as follows. Namely, ALTER TABLE statement, like as UPDATE statement, retrieves information which is before DDL transaction in other transaction until the transaction is committed.

- Transaction A: It adds a new UPDATE_TIME column.

```
gSQL> ALTER TABLE t1 ADD COLUMN ( update_time TIMESTAMP DEFAULT CURRENT_TIMESTAMP );  
Table altered.
```

- The table t1 including the added column is retrieved.

```
gSQL> select * from t1;  
ID NAME    UPDATE_TIME  
-----  
1 leekmo 2014-07-10 12:50:33.540495  
1 row selected.
```

If the transaction B is executed before committing the transaction A as follows, then the table t1 which is before adding a column is retrieved.

- Transaction B: The added column UPDATE_TIME is not retrieve, because the transaction A is not committed.

```
gSQL> SELECT * FROM t1;  
ID NAME  
-----  
1 leekmo  
1 row selected.
```

12.2 Data Manipulation Language

DML Related Statements

For more information, refer to the followings.

- INSERT related statements
 - **INSERT INTO**
 - **INSERT INTO name RETURNING**
 - **INSERT INTO name RETURNING .. INTO**
- UPDATE related statements
 - **UPDATE**
 - **UPDATE name RETURNING**
 - **UPDATE name RETURNING .. INTO**
 - **UPDATE name WHERE CURRENT OF cursor_name**
- DELETE related statements
 - **DELETE FROM**
 - **DELETE FROM name RETURNING**
 - **DELETE FROM name RETURNING .. INTO**
 - **DELETE FROM name WHERE CURRENT OF cursor_name**
- SELECT related statements: **SELECT .. INTO**
- Dynamic SQL related statements
 - **EXECUTE IMMEDIATE 'sql_string'**
 - **PREPARE statement_name**
 - **EXECUTE statement_name**

Concepts of DML

Data Manipulation Language (DML) is an SQL language which manipulates and enquires data in existing tables such as INSERT, DELETE, UPDATE.

This chapter describes only DML statements which change data. For more information about queries, refer to **Data Query Language**.

The DDL statements change the SQL object structure, but DML statements manipulate the objects contents. For example, ALTER TABLE statement alters the table structure, but INSERT statement adds one or more rows in the table.

DML statements such as inserting, deleting, updating data in table are classified as follows.

Table 12-2 Data manipulation statements

Category	Statements	Description
INSERT	INSERT .. VALUES	It adds a single row to the table.
	INSERT .. SELECT	It adds the query results to the table.
	INSERT .. RETURN .. INTO	It sets the value of the added row as a variable.
	INSERT .. RETURN	It retrieves the added row as the query result.
DELETE	DELETE .. WHERE	It deletes the row which satisfies the condition.
	DELETE .. WHERE CURRENT OF	It deletes the row which is at the cursor's position.
	DELETE .. RETURN .. INTO	It sets the value of the removed row as a variable.
	DELETE .. RETURN	It retrieves the removed row as the query result.
UPDATE	UPDATE .. WHERE	It updates the row which satisfies the condition.
	UPDATE .. WHERE CURRENT OF	It updates the row which is at the cursor's position.
	UPDATE .. RETURN .. INTO	It sets the value of the updated row as a variable.
	UPDATE .. RETURN	It retrieves the updated row as the query result.

Inserting Data

It adds data in a row unit when adding data to a table. The INSERT statement can add one or more rows to a table. Even when the data in some columns are omitted, all rows are added with completed columns to the table.

The following is an example of a table.

```
CREATE TABLE t1
(
  id    NUMBER(10,0),
  name  VARCHAR(128),
  addr  VARCHAR(1024) DEFAULT 'n/a'
);
```

The most basic way to add a row is as follows.

```
INSERT INTO t1 VALUES ( 1, 'leekmo', 'Seoul, Korea' );
```

The values listed in the VALUES clause are inserted in accordance with the sequence of the listed column when the table is created.

However, the example above can cause an unexpected failure when inserting or deleting columns, so it is recommended to explicitly specify the column name as follows.

```
INSERT INTO t1 (id, name, addr) VALUES ( 1, 'leekmo', 'Seoul, Korea' );
INSERT INTO t1 (name, addr, id) VALUES ( 'leekmo', 'Seoul, Korea', 1 );
```

The two INSERT statements above are listed in different order from the columns, but the added row of the table t1 has the same data.

If the table does not list all the columns, unspecified column is set to the default value to complete the row. The addr column which was not used in the statement stores the default value (n/a) which was specified when creating table as follows.

```
INSERT INTO t1 ( id, name ) VALUES ( 1, 'leekmo' );
INSERT INTO t1 ( id, name ) SELECT id, name FROM emp;
```

Use DEFAULT to explicitly specify the default value for the column as follows.

```
INSERT INTO t1 ( id, name, addr ) VALUES ( 1, 'leekmo', DEFAULT );
```

Use either of the following two statements to set all the columns to the default value.

```
INSERT INTO t1 ( id, name, addr ) VALUES ( DEFAULT, DEFAULT, DEFAULT );
INSERT INTO t1 DEFAULT VALUES;
```

Use a single INSERT statement to add multiple rows. The following is an example of adding three new rows using a single INSERT statement.

```
INSERT INTO t1 (id, name, addr) VALUES
  ( 1, 'leekmo', 'Seoul, Korea' ),
  ( 2, 'mkkim', 'Seoul, Korea' ),
  ( 3, 'xcom', 'Inchon, Korea' );
```

Use the SELECT query results to add multiple rows. The following is an example of adding rows to the table t1 by retrieving employees who joined the company more than three years ago.

```
INSERT INTO t1 ( id, name, addr )
SELECT id, name, addr
FROM emp
WHERE DATEDIFF( YEAR, SYSDATE, join_date ) >= 3;
```

Deleting Data

DELETE statement deletes data from the table in a row unit like when inserting data. Rows can be deleted by using WHERE condition or by using row's ID(ROWID).

The following is an example of deleting rows which satisfy WHERE condition.

```
DELETE FROM t1 WHERE id = 1;
```

The following is an example of deleting the row using ROWID.

```
gSQL> SELECT rowid FROM t1 WHERE id = 1;
                ROWID
-----
AAAAAAAAAFNHAACAAAAAIAAA
1 row selected.
gSQL> DELETE FROM t1 WHERE ROWID = 'AAAAAAAAAFNHAACAAAAAIAAA';
1 row deleted.
```

DELETE statement without a WHERE clause deletes the entire row in a table. DELETE statement without a WHERE clause is similar to TRUNCATE TABLE statement in terms of deleting entire row, but it is recommended to use the TRUNCATE TABLE statement.

```
DELETE FROM t1;
TRUNCATE TABLE t1;
```

Updating Data

Update data by using UPDATE statement. One or more rows and columns can be updated. Other columns which is not specified in the UPDATE statement is not affected.

The following is an example of updating a column in rows which satisfy the condition.

```
UPDATE t1 SET page_view = page_view + 1 WHERE id = 1;
```

The followings are examples of updating multiple columns, and the two UPDATE statements mean the same.

```
UPDATE t1 SET page_view = page_view + 1, status = 'F' WHERE id = 1;
UPDATE t1 SET (page_view, status) = (page_view + 1, 'F') WHERE id = 1;
```

Use DEFAULT as follows to set the column value to a default value.

```
UPDATE t1 SET addr = DEFAULT WHERE id = 1;
```

Manipulating Data Using Cursor

Cursor is a session object to execute queries and to manipulate the query result. Use cursor to update or delete the query result set.

The following is an example of declaring updatable cursor, and updating or deleting the row at the position of the current cursor using the updatable cursor.

```
gSQL> DECLARE cur1 CURSOR FOR SELECT id, data FROM t1 FOR UPDATE;
Cursor declared.
gSQL> OPEN cur1;
Cursor is open.
gSQL> \var v_id INTEGER
gSQL> \var v_data VARCHAR(128)
gSQL> FETCH cur1 INTO :v_id, :v_data;
V_ID V_DATA
----
      1 data_1
1 row fetched.
gSQL> FETCH cur1 INTO :v_id, :v_data;
V_ID V_DATA
----
      2 data_2
1 row fetched.
gSQL> DELETE FROM t1 WHERE CURRENT OF cur1;
1 row deleted.
gSQL> FETCH cur1 INTO :v_id, :v_data;
V_ID V_DATA
----
      3 data_3
1 row fetched.
gSQL> UPDATE t1 SET id = id + :v_id WHERE CURRENT OF cur1;
1 row updated.
gSQL> COMMIT;
Commit complete.
gSQL> SELECT * FROM t1 ORDER BY 1;
```

```
ID DATA
-- -----
1 data_1
6 data_3
2 rows selected.
```

The examples above describe the followings.

Use **DECLARE cursor_name** to declare FOR UPDATE cursor, and use **OPEN cursor_name** to open the cursor.

Use **FETCH cursor_name** to move the cursor to the specified position.

Use **DELETE FROM name WHERE CURRENT OF cursor_name** to delete the row in the specified position.

Use **UPDATE name WHERE CURRENT OF cursor_name** to update the row in the specified position.

FOR UPDATE cursor is closed using **CLOSE cursor_name**, or it is closed when committing transaction.

DML Query

When executing DML statements changing the data, use RETURNING clause to retrieve the changed data. The RETURNING clause of DML statements, like as SELECT, can retrieve data, so the execution of the DML statement and the SELECT statement can be replaced with the DML query.

The following is an example of using **INSERT INTO name RETURNING** syntax to insert data and retrieve the result. The join_date value which was input by using SYSDATE function can be retrieved by a single DML query.

```
gSQL> INSERT INTO t1 ( id, join_date ) VALUES ( 1, SYSDATE ) RETURNING id, join_date;
ID JOIN_DATE
-- -----
1 2014-07-18
1 row created.
```

The following is an example of using **DELETE FROM name RETURNING** syntax to delete data and retrieve the result. The result data can be manipulated by using operation in RETURNING clause.

```
gSQL> DELETE FROM t1 RETURNING ( id || ': ' || join_date ) AS id_and_join_date;
ID_AND_JOIN_DATE
-----
1: 2014-07-18
1 row deleted.
```

The following is an example of using **UPDATE name RETURNING** syntax to update rows and retrieve the

updated values. The value which is before updating can be retrieved by using OLD clause.

- It updates the row and retrieves the updated value.

```
gSQL> UPDATE t1 SET page_view = page_view + 1 WHERE id = 1 RETURNING page_view;
PAGE_VIEW
-----
          102
1 row updated.
```

- It updates the row and retrieves the value which is before the updating.

```
gSQL> UPDATE t1 SET page_view = page_view + 1 WHERE id = 1 RETURNING OLD page_view;
PAGE_VIEW
-----
          102
1 row updated.
```

RETURNING clause of DML statements, like as SELECT query, can retrieve multiple query results. However, if the DML is executed only for a single row, then the host variable can be obtained by using RETURNING INTO clause. In this case, the number of changed rows should be one or less, like **SELECT .. INTO** clause .

The following is an example of setting the value to the host variable using RETURNING .. INTO clause of each DML statement.

- It declares the host variable.

```
gSQL> \var v_id          INTEGER
gSQL> \var v_page_view  BIGINT
gSQL> \var v_date       DATE
```

- After inserting the row, a value is set to the host variable.

```
gSQL> INSERT INTO t1 ( id, join_date ) VALUES ( 1, SYSDATE ) RETURNING join_date INTO :v_date;
V_DATE
-----
2014-07-18 16:57:11.000000
1 row created.
```

- After updating the row, a value is set to the host variable.

```
gSQL> UPDATE t1 SET page_view = page_view + 1 WHERE id = 1 RETURN page_view INTO :v_page_view;
V_PAGE_VIEW
```



```
-----  
          101  
1 row updated.
```

- After deleting the row, a value is set to the host variable.

```
gSQL> DELETE FROM t1 WHERE id = 1 RETURN id, page_view INTO :v_id, :v_page_view;  
V_ID V_PAGE_VIEW  
----  
    1          101  
1 row deleted.
```

For more information about DML query, refer to the followings.

- **INSERT INTO name RETURNING**
- **INSERT INTO name RETURNING .. INTO**
- **DELETE FROM name RETURNING**
- **DELETE FROM name RETURNING .. INTO**
- **UPDATE name RETURNING**
- **UPDATE name RETURNING .. INTO**

12.3 Data Query Language

Query Related Statements

For more information, refer to the followings.

- SELECT query related statements
 - **SELECT**
 - **SELECT .. FOR UPDATE**
- DML query related statements
 - **INSERT INTO name RETURNING**
 - **UPDATE name RETURNING**
 - **DELETE FROM name RETURNING**
- Cursor related statements
 - **DECLARE cursor_name**
 - **OPEN cursor_name**
 - **FETCH cursor_name**
 - **CLOSE cursor_name**
 - **DELETE FROM name WHERE CURRENT OF cursor_name**
 - **UPDATE name WHERE CURRENT OF cursor_name**

Concepts of Query

Query means a series of operations to retrieve data for one or more of the table or view. By using the query, a user can get the result data which satisfies the specific condition in the desired form from the stored data.

Query is a SELECT statement which is at the top in the entire SQL statement separated by ';'. Top-level SELECT statement can include another SELECT statement in it. In this case, the subordinate SELECT statement is called as a subquery.

In GOLDILOCKS, query is divided into SELECT query, DML query, and cursor. SELECT query returns the result by using the SELECT statement. DML query returns the result by using the RETURNING phrase in INSERT, DELETE, UPDATE statements. Cursor temporarily saves the result sets when it is enquired once, and randomly accesses to a row of the saved result set, then brings the result.

A user can get the results at once by using SELECT query and DML query. On the other hand, by using th

e cursor, SELECT statement specified with DECLARE cursor is executed in OPEN cursor, and then it holds the result set until CLOSE cursor is called. Then it repeatedly brings the result by randomly accessing to a row of the result set using FETCH cursor.

This chapter describes SELECT query, DML query and cursor.

Basic Query

The basic form of a query is *SELECT <select list> FROM <table expression>*. *<select list>* which is between SELECT and FROM keywords, specifies one or more columns or expressions to be included in rows which are the result for the table or view described in *<table expression>*.

```
SELECT n_name
       , INITCAP( n_name )
FROM nation
WHERE n_regionkey = 1;
```

N_NAME	INITCAP(N_NAME)
ARGENTINA	Argentina
BRAZIL	Brazil
CANADA	Canada
PERU	Peru
UNITED STATES	United States

5 rows selected.

One or more tables or views can be described in *<table expression>*, and same column can be included in two tables or views. In this case, the name of table or view should be specified together when describing that column in *<select list>*. When describing a table or a column, it is recommended to clearly describe the schema names and table names, etc.

- A wrong example

```
SELECT n_name
FROM nation AS n
       , v_nation AS v
WHERE n.n_nationkey = v.n_nationkey
      AND v.n_regionkey = 1;
```

ERR-42000(16142): column ambiguously defined :

```
SELECT n_name
       *
```

ERROR at line 1:

- A correct example

```
SELECT n.n_name
      FROM nation AS n
           , v_nation AS v
 WHERE n.n_nationkey = v.n_nationkey
       AND v.n_regionkey = 1;
N_NAME
-----
ARGENTINA
BRAZIL
CANADA
PERU
UNITED STATES
5 rows selected.
```

<select list> supports the alias name. It changes output column names in each columns which are separated by comma (,). Alias name can be used only in the <order by clause>, and it can not to be used in other phrases.

```
SELECT p_type
      , p_retailprice * 0.9 AS discount_price
 FROM part
 ORDER BY discount_price
 FETCH 5;
   2   3   4   5
P_TYPE          DISCOUNT_PRICE
-----
PROMO BURNISHED COPPER          810.9
ECONOMY BRUSHED NICKEL          810.9
LARGE BRUSHED BRASS             811.8
LARGE BRUSHED NICKEL            811.8
PROMO ANODIZED STEEL           811.8
5 rows selected.
```

In addition to <select list>, <hint clause> and <set quantifier> can also be used between SELECT and FROM keywords. <hint clause> allows a user to directly adjust the query execution plan. For more information, refer to **hint clause**. <set quantifier> removes the duplicate data of the row which is returned as the result. For more information, refer to **query specification**.

- An example of using hint

```

SELECT
    /*+ INDEX( part ) */
    p_type
    , p_retailprice
FROM part
WHERE p_partkey = 100;
P_TYPE          P_RETAILPRICE
-----
ECONOMY ANODIZED TIN          1000.1
1 row selected.

```

- An example of using <set quantifier>

```

SELECT DISTINCT
    o_orderpriority
FROM orders;
O_ORDERPRIORITY
-----
5-LOW
2-HIGH
3-MEDIUM
1-URGENT
4-NOT SPECIFIED
5 rows selected.

```

SET Operator

SET operators combine the result set of two or more queries into a single result set. SET operators are UNION, EXCEPT, INTERSECT, and MINUS. MINUS operates as same as EXCEPT. Each SET operator has additional options such as ALL and DISTINCT. If the option is omitted, DISTINCT is used by default.

When using the SET operators to describe two or more queries, generally the queries are processed sequentially from the left. When parentheses are used to explicitly specify the processing order of the queries, then those queries are processed first.

```

SELECT n_name
FROM nation
WHERE n_nationkey < 10

```

```

INTERSECT
( SELECT n_name
  FROM nation
  WHERE n_regionkey = 1
UNION ALL
SELECT n_name
  FROM nation
  WHERE n_regionkey = 2 );
N_NAME
-----
BRAZIL
ARGENTINA
INDONESIA
INDIA
CANADA
5 rows selected.

```

Each query of the SET operators should have the same number of the target, and the target at the same positions of each query should have a data type which belongs to the same group.

⟨order by clause⟩ of SET operator sorts the final result set. Each query of SET operators can have its own ⟨order by clause⟩ to sort themselves.

For more information about SET operators, refer to **set operator**.

Join

Join is a query that combines rows from more than one table or view in ⟨from clause⟩. If there is not a join condition, the result is obtained by combining each result row of the left table or view with each result row of the right table or view.

If tables or views have a column name in common when joining two or more tables or views in ⟨from clause⟩, a user should distinguish these columns by using the table or view name in ⟨select list⟩, ⟨where clause⟩. Otherwise, a validation error occurs.

Join queries either contain the join condition or do not contain the join condition. Join condition is for comparing columns from two different tables or views. If the join condition is not specified, each row of a table or view is combined with each row of another table or view, and the combined row is returned. If the join condition is specified, rows from each table or view which satisfies the join condition, are returned in the combined form.

Equi-join is a join whose join condition contains an equality operator(=). Equi-join condition is an importa

nt factor in optimizing the join operation by the optimizer.

Self-join is a join operation which has only the same tables in <from clause>. To describe column in <select list>, the alias name in each table is described and table alias in column is used.

CROSS JOIN

CROSS JOIN is a join operation whose join condition does not exist, and it is also called as Cartesian Product. CROSS JOIN combines each row of one table or view with each row of the other, and the combined row is returned as a result.

```
SELECT a.r_name
       , b.r_name
  FROM region AS a
       , region AS b
  FETCH 5;
```

R_NAME	R_NAME
AFRICA	AFRICA
AFRICA	AMERICA
AFRICA	ASIA
AFRICA	EUROPE
AFRICA	MIDDLE EAST

5 rows selected.

INNER JOIN

INNER JOIN returns the rows which satisfy the join condition for two or more tables or views. INNER JOIN is when *inner join* is explicitly specified in <from clause>. Or, when tables or views are listed with comma (,) in <from clause> and its join condition is specified in <where clause>.

If there are explicit *inner join* in <from clause>, and the join condition in <where clause>, then they are processed as one inner join condition.

- An example of using an INNER JOIN statement

```
SELECT n_name
  FROM region INNER JOIN nation ON r_regionkey = n_regionkey
  WHERE r_name = 'AFRICA';
```

N_NAME
ALGERIA

```

ETHIOPIA
KENYA
MOROCCO
MOZAMBIQUE
5 rows selected.

```

- An example of a list using a comma (,)

```

SELECT n_name
   FROM region
      , nation
 WHERE r_regionkey = n_regionkey
      AND r_name = 'AFRICA';
N_NAME
-----
ALGERIA
ETHIOPIA
KENYA
MOROCCO
MOZAMBIQUE
5 rows selected.

```

OUTER JOIN

OUTER JOIN returns all rows which satisfy the join condition for two or more tables or views. It also returns rows which do not satisfy the join condition for one or both side of table or view depending on the direction of OUTER JOIN.

OUTER JOIN can be classified as LEFT OUTER JOIN , RIGHT OUTER JOIN, FULL OUTER JOIN. All three OUTER JOIN returns rows which satisfy the join condition, but they are distinguished by the additional results. LEFT OUTER JOIN returns all rows of the left table which do not satisfy the join condition by filling NULL for all of its right rows. RIGHT OUTER JOIN returns all rows of the right table which do not satisfy the join condition by filling NULL for all of its left rows. FULL OUTER JOIN returns all additional return results of LEFT OUTER JOIN and RIGHT OUTER JOIN.

```

SELECT r_name
      , n_name
   FROM region LEFT OUTER JOIN nation
      ON r_regionkey = n_regionkey AND r_name = 'AFRICA';
R_NAME          N_NAME
-----

```

AFRICA	ALGERIA
AFRICA	ETHIOPIA
AFRICA	KENYA
AFRICA	MOROCCO
AFRICA	MOZAMBIQUE
AMERICA	null
ASIA	null
EUROPE	null
MIDDLE EAST	null

9 rows selected.

GOLDILOCKS supports the outer join operator(+) for compatibility with Oracle, and which is not supported in the SQL standard. The outer join operator(+) lists tables by using a comma(,) in <from clause> and it adds a (+) to a node column which is operated as the outer node in the join condition of <where clause>.

When using the outer join operator (+), the sign(+) should be specified on the right side of the column as follows.

```
select * from t1, t2 where t1.i1 = t2.i1(+);
```

The syntax rules of the outer join operator (+) are as follows.

- <Join outer operator> can be used only for <where clause>.
- <Join outer operator> can be used only for <column reference> of <table reference> which is a target of <joined table>.
- <value expression> including <join outer operator>, can not be combined with other conditions which use <OR logical operator>.
- <column reference> including <join outer operator> can not be used as the argument of IN function.
- A <table reference> can not be used as null generated table of many outer joins (constraints on the outer join)
- When executing the outer join of two or more tables, they are listed according to the left outer join sequence, and executes the outer join from the very left of them.
- When executing Out Join of two or more tables and multiple tables are combined into a table by the outer join, then the outer join is executed according to the sequence of calculation by an optimizer.

Even when the outer join operator (+) is specified, it is ignored in the following cases.

- <join outer operator> can be used for <value expression> which can be used as the join condition between the two tables, if it can not be used as the join condition, then it is ignored and an error or warning does not occur.
- <join outer operator> which is specified in <column reference> of the outer query is ignored, and an error or warning does not occur.
- If two <table reference> are outer joined using <join outer operator>, then <join outer operator> should be specified in all <column reference> which belong to null generated tables. Otherwise, join of two

- o `<table reference>` is processed as an inner join, an error or warning does not occur.

Differences between Oracle and GOLDILOCKS for the outer join operator (+) are as follows.

- Quantified comparison (in, = any, = all = row, etc.)
 - GOLDILOCKS: It processes the operation as a validation error.
 - Oracle: The and/or operation is applied, and performs the validation check.
- Or sub-clause in an *and* clause
 - GOLDILOCKS: Validation is applied on the columns of an *or* sub-clause.
 - Oracle: Validation is ignored on the columns of an *or* sub-clause.
- When the condition clause includes a subquery
 - GOLDILOCKS: The outer join is applied and the condition is processed as a join condition.
 - Oracle: The outer join is applied but the condition is processed as a where filter.



GOLDILOCKS supports the outer join operator (+) for compatibility with Oracle. It is recommended to specify OUTER JOIN in `<from clause>`. (Oracle also recommends to specify OUTER JOIN in `<from clause>`.)

NATURAL JOIN

NATURAL JOIN uses the join condition of an equality operator(=) for columns of same name when joining two or more tables or views. It is as same as INNER JOIN except that NATURAL JOIN has the implicit join condition for columns of the same name.

```
SELECT r_name
   FROM region a NATURAL JOIN region b;
R_NAME
-----
AFRICA
AMERICA
ASIA
EUROPE
MIDDLE EAST
5 rows selected.
```

SEMI JOIN

SEMI JOIN returns the corresponding left rows if there exist right rows which satisfy the join condition. Unlike other join operations to return the rows which combine the left and right rows, SEMI JOIN returns only the left rows as the result.

- An example of using the semi join

```
SELECT r_name
   FROM region
  WHERE r_regionkey IN ( SELECT n_regionkey
                        FROM nation
                        WHERE n_nationkey < 5 );
```

R_NAME

AFRICA
AMERICA
MIDDLE EAST
3 rows selected.

ANTI-SEMI JOIN

ANTI-SEMI JOIN returns the corresponding left rows if there does not exist any right rows which satisfy the join condition. It returns only the left rows as the result like as SEMI JOIN.

- An example of using the anti-semi join

```
SELECT r_name
   FROM region
  WHERE r_regionkey NOT IN ( SELECT n_regionkey
                            FROM nation
                            WHERE n_nationkey < 5 );
```

R_NAME

ASIA
EUROPE
2 rows selected.

For more information about the join operation, refer to [joined table](#).

Grouping Result Set (group by)

<group by clause> is used in order to group the rows which have the same column into one. <group by clause> lists and delimiters columns by using the comma (,), and GOLDILOCKS supports the group operation based on it.

```

SELECT
    o_orderpriority
    , MIN( o_totalprice ) AS min_price
    , MAX( o_totalprice ) AS max_price
FROM orders
GROUP BY
    o_orderpriority;
O_ORDERPRIORITY MIN_PRICE MAX_PRICE
-----
5-LOW            857.71 530604.44
2-HIGH           896.8 522720.61
3-MEDIUM        875.52 508668.52
1-URGENT         866.9 544089.09
4-NOT SPECIFIED 884.82 555285.16
5 rows selected.

```

If `<group by clause>` is specified, only the columns and the aggregate functions described in `<group by clause>` can be included in `<select list>`.

If only constants or parentheses instead of columns are specified in `<group by clause>`, it is assumed to be empty grouping set which includes the imaginary columns of the same value in each row. Then, the grouping in column base is performed. It is same when specifying `<having clause>` without `<group by clause>`.

`<having clause>` can be used to get the specified rows from grouped results by `<group by clause>`. `<having clause>` describes the conditions for each group, and it can describes the condition using the aggregate operation.

```

SELECT
    o_orderpriority
    , MIN( o_totalprice ) AS min_price
    , MAX( o_totalprice ) AS max_price
FROM orders
GROUP BY
    o_orderpriority
HAVING
    MIN( o_totalprice ) < 870;
O_ORDERPRIORITY MIN_PRICE MAX_PRICE
-----
5-LOW            857.71 530604.44
1-URGENT         866.9 544089.09
2 rows selected.

```

For more information about the grouping, refer to **group by clause**.

Sorting Result Set (order by)

⟨Order by clause⟩ sorts the result set based on the specific columns. ⟨order by clause⟩ can sort based on all types of column except the LONG type.

When a positive integer value is in ⟨order by clause⟩, it means the column which is located in the corresponding to an integer value for the targets in the ⟨select list⟩. The range of positive integer value which can be described in ⟨order by clause⟩ is from 1 and to the number of the targets in ⟨select list⟩.

```
SELECT
    o_orderpriority
    , MIN( o_totalprice ) AS min_price
    , MAX( o_totalprice ) AS max_price
FROM orders
GROUP BY
    o_orderpriority
ORDER BY 1;
O_ORDERPRIORITY MIN_PRICE MAX_PRICE
-----
1-URGENT          866.9 544089.09
2-HIGH            896.8 522720.61
3-MEDIUM         875.52 508668.52
4-NOT SPECIFIED  884.82 555285.16
5-LOW             857.71 530604.44
5 rows selected.
```

If the column data type in ⟨order by clause⟩ is numeric, it is sorted by numeric comparison. If the column data type is a character type, it is sorted by character comparison.

Each column in ⟨order by clause⟩ can be described by using the sorting direction option such as ASC, DESC. If it is omitted, it is regarded as ASC.

For more information about sorting, refer to **order by clause**.

Subquery

Subquery supports a multi-level search request. The multi-level search request means that the result of the current query depends on the result of the subquery.

For example, the query to get people who is older than the average age of the people in a specific group is written in multi-step. The first query is to obtain the average age of people in a specific group, then the second query is to retrieve the number of people who is older than the average using the first query.

```
SELECT e_name
FROM emp
WHERE e_age > ( SELECT AVG(e_age)
                FROM emp
                WHERE e_dept = 'RND' );
```

A subquery can be used in <from clause>, <where clause>. The subquery in <from clause> is "inline view" and the subquery in <where clause> is "nested subquery".

The column name of a table or view in nested subquery can be same as the column name of a table or view in the query including the nested subquery when using the nested subquery. If only the column name exists in <select list> of the nested subquery, then it refers to the column of the table or view in the nested subquery. If the column name in <select list> of the nested subquery does not exist in the nested subquery's table or view, then it refers to the column name of the table or view in the query which includes the nested subquery, if exists.

```
SELECT r_name
FROM region
WHERE EXISTS ( SELECT *
               FROM nation
               WHERE n_nationkey < 5          /* nation.n_nationkey */
               AND n_regionkey = r_regionkey ) /* nation.n_regionkey = region.r_regionkey */
;
```

The optimizer unnests the nested subquery of <where clause> in the query which includes the nested subquery. Then it processes it as SEMI JOIN or ANTI-SEMI JOIN operation.

This is an optimization of the nested subquery, and the optimizer determines it by calculating the cost of unnesting if the subquery exists in IN, NOT IN, EXISTS, NOT EXISTS, quantify operator.

If a user wants to forcibly unnest the nested subquery, the user can use <hint clause> of nested subquery.

For more information about unnesting the nested subquery, refer to **hint clause**.

```
SELECT r_name
  FROM region
 WHERE r_regionkey IN ( SELECT /*+ UNNEST */
                        n_regionkey
                        FROM nation
                        WHERE n_nationkey < 5 );
```

For more information about subquery, refer to **subquery**.

12.4 Control Language

Control Language Related Statements

Transaction control related statements: Refer to the followings.

- COMMIT
- ROLLBACK
- LOCK TABLE
- SAVEPOINT *savepoint_specifier*
- RELEASE SAVEPOINT *savepoint_specifier*

Session control related statements: Refer to the followings.

- ALTER SESSION SET *property_name*
- SET SESSION AUTHORIZATION *user_identifier*
- SET SESSION CHARACTERISTICS AS *transaction_mode*
- SET TIME ZONE
- SET TRANSACTION *transaction_mode*

System control related statements: Refer to the followings.

- ALTER SYSTEM CHECKPOINT
- ALTER SYSTEM {MOUNT | OPEN} DATABASE
- ALTER SYSTEM [KILL | DISCONNECT] SESSION
- ALTER SYSTEM SET *property_name*
- ALTER SYSTEM RESET *property_name*
- ALTER SYSTEM SWITCH LOGFILE

Transaction Control

Transaction control statements are used to manage the changes caused by executing DML or DDL statements in the transactions. Transaction control statements can be committed to keep the changes permanently, or rolled back to undo the changes.

Transaction control statements are classified as follows.

Table 12-3 Transaction control statements

Statement	Description	Refer to
COMMIT	It terminates the transaction normally.	COMMIT
ROLLBACK	It undoes the transaction.	ROLLBACK

Statement	Description	Refer to
SAVEPOINT	It creates the savepoint.	SAVEPOINT savepoint_specifier
RELEASE SAVEPOINT	It removes the savepoint.	RELEASE SAVEPOINT savepoint_specifier
LOCK TABLE	It sets the table-level lock.	LOCK TABLE
SET TRANSACTION	It controls the transaction properties. (Read/write, isolation level)	SET TRANSACTION transaction_mode
SET CONSTRAINTS	It controls the checkpoint of the deferrable constraints.	SET CONSTRAINTS

A transaction is automatically created when the DML statements or DDL statements are executed for the first time. DML statements change the data and DDL statements change the SQL objects. However, the SELECT statements or the control statement do not generate a transaction.

The transaction rollbacks are classified as total rollback and partial rollback. The partial rollback is executed either in an explicit method or an implicit method. The total rollback is executed by ROLLBACK statement, and it undoes any changes performed by DML, DDL within the transaction.

The explicit partial rollback is a method which a user executes ROLLBACK statement using the savepoints as follows.

The following example describes that savepoints sp1, sp2 are declared, and then the partial rollback is explicitly executed.

```

gSQL> CREATE TABLE t1 ( id INTEGER, name VARCHAR(128) );
Table created.
gSQL> COMMIT;
Commit complete.
gSQL> INSERT INTO t1 VALUES ( 1, 'leekmo' );
1 row created.
gSQL> SAVEPOINT sp1;
Savepoint created.
gSQL> INSERT INTO t1 VALUES ( 2, 'mkkim' );
1 row created.
gSQL> SAVEPOINT sp2;
Savepoint created.
gSQL> INSERT INTO t1 VALUES ( 3, 'xcom' );
1 row created.
gSQL> ROLLBACK TO SAVEPOINT sp2;
Rollback complete.
gSQL> SELECT * FROM t1;
ID NAME
-- -----

```

```

1 leekmo
2 mkkim
2 rows selected.
gSQL> ROLLBACK TO SAVEPOINT sp1;
Rollback complete.
gSQL> SELECT * FROM t1;
ID NAME
-- -----
1 leekmo
1 row selected.
gSQL> ROLLBACK WORK;
Rollback complete.
gSQL> SELECT * FROM t1;
no rows selected.

```

The implicit partial rollback is undoing only the changes of the corresponding statement when an error occurs while executing the statement.

The following example describes the implicit partial rollback.

If a unique constraint is violated, only the INSERT statement is rolled back and the previous changes of the transaction are retained.

```

gSQL> ALTER TABLE t1 ADD CONSTRAINT t1_uk UNIQUE(id);
Table altered.
gSQL> COMMIT;
Commit complete.
gSQL> INSERT INTO t1 VALUES ( 4, 'egonspace' );
1 row created.
gSQL> INSERT INTO t1 VALUES ( 1, 'jhkim' );
ERR-40002(16057): unique constraint (PUBLIC.T1_UK) violated
gSQL> SELECT * FROM t1;
ID NAME
-- -----
1 leekmo
2 mkkim
3 xcom
4 egonspace
4 rows selected.

```

Session Control

Session is a logical object to manage the user's state information who accesses the database. Session control statement changes the session properties.

Session control statements are classified as follows.

Table 12-4 Session control statements

Statement	Description	Refer to
SET SESSION CHARACTERISTICS	It controls the transaction properties in the session.	SET SESSION CHARACTERISTICS AS TRANSACTION MODE
SET TIME ZONE	It alters the time zone of the session.	SET TIME ZONE
SET SESSION AUTHORIZATION	It alters the user of the session.	SET SESSION AUTHORIZATION user_identifier
ALTER SESSION SET	It alters the session property.	ALTER SESSION SET property_name

SET TRANSACTION statement is the transaction controlling statement and SET SESSION CHARACTERISTICS statement is session controlling statement. Both SET TRANSACTION statement and SET SESSION CHARACTERISTICS statement control the transaction properties.

The difference between SET TRANSACTION statement and SET SESSION CHARACTERISTICS statement is that SET TRANSACTION statement is applied only to a transaction which will be executed next. On the other hand, SET SESSION CHARACTERISTICS statement is applied for all transactions which occur in the session afterwards.

The following is a result of CURRENT_TIMESTAMP statement which obtains the current date and time after changing the time zone by using SET TIME ZONE statement.

```
gSQL> SELECT CURRENT_TIMESTAMP FROM DUAL;
CURRENT_TIMESTAMP
-----
2014-07-21 11:42:49.828276 +09:00
1 row selected.
gSQL> SET TIME ZONE '+00:00';
Session set.
gSQL> SELECT CURRENT_TIMESTAMP FROM DUAL;
CURRENT_TIMESTAMP
-----
2014-07-21 02:43:03.437940 +00:00
1 row selected.
```

System Control

System control statements manage the database system, and they are classified as follows.

Table 12-5 System control statements

Statement	Description	Refer to
ALTER SYSTEM {OPEN MOUNT} DATABASE	It starts up the database.	ALTER SYSTEM {MOUNT OPEN} DATABASE
ALTER SYSTEM CHECKPOINT	It performs the checkpoint.	ALTER SYSTEM CHECKPOINT
ALTER SYSTEM KILL SESSION	It forcibly terminates the specific session.	ALTER SYSTEM [KILL DISCONNECT] SESSION
ALTER SYSTEM SWITCH LOGFILE	It switches the log file.	ALTER SYSTEM SWITCH LOGFILE
ALTER SYSTEM SET	It sets the system properties.	ALTER SYSTEM SET property_name
ALTER SYSTEM RESET	It removes the system properties.	ALTER SYSTEM RESET property_name

The following is an example of enquiring sessions connected to the database, and terminating the specific session.

```

gSQL> SELECT USER_NAME, SESSION_ID, SERIAL_NO, SESSION_STATUS, PROGRAM_NAME FROM V$SESSION
WHERE USER_NAME = 'TEST';
USER_NAME SESSION_ID SERIAL_NO SESSION_STATUS PROGRAM_NAME
-----
TEST          62          49 CONNECTED    gsql
TEST          65          109 CONNECTED    gsqlnet
TEST          66          130 CONNECTED    gsql
3 rows selected.
gSQL> ALTER SYSTEM DISCONNECT SESSION 65, 109;
System altered.

```

12.5 Processing SQL in Cluster

This chapter describes how to process various SQL statements in a cluster environment.

Processing DDL in Cluster

DDL Processing Procedure in Cluster

GOLDILOCKS cluster does not have a separate meta server, and a user can perform DDL in any cluster member configuring the cluster system.

DDL is executed following the procedure below in a cluster environment.

Figure 1 Processing DDL in cluster

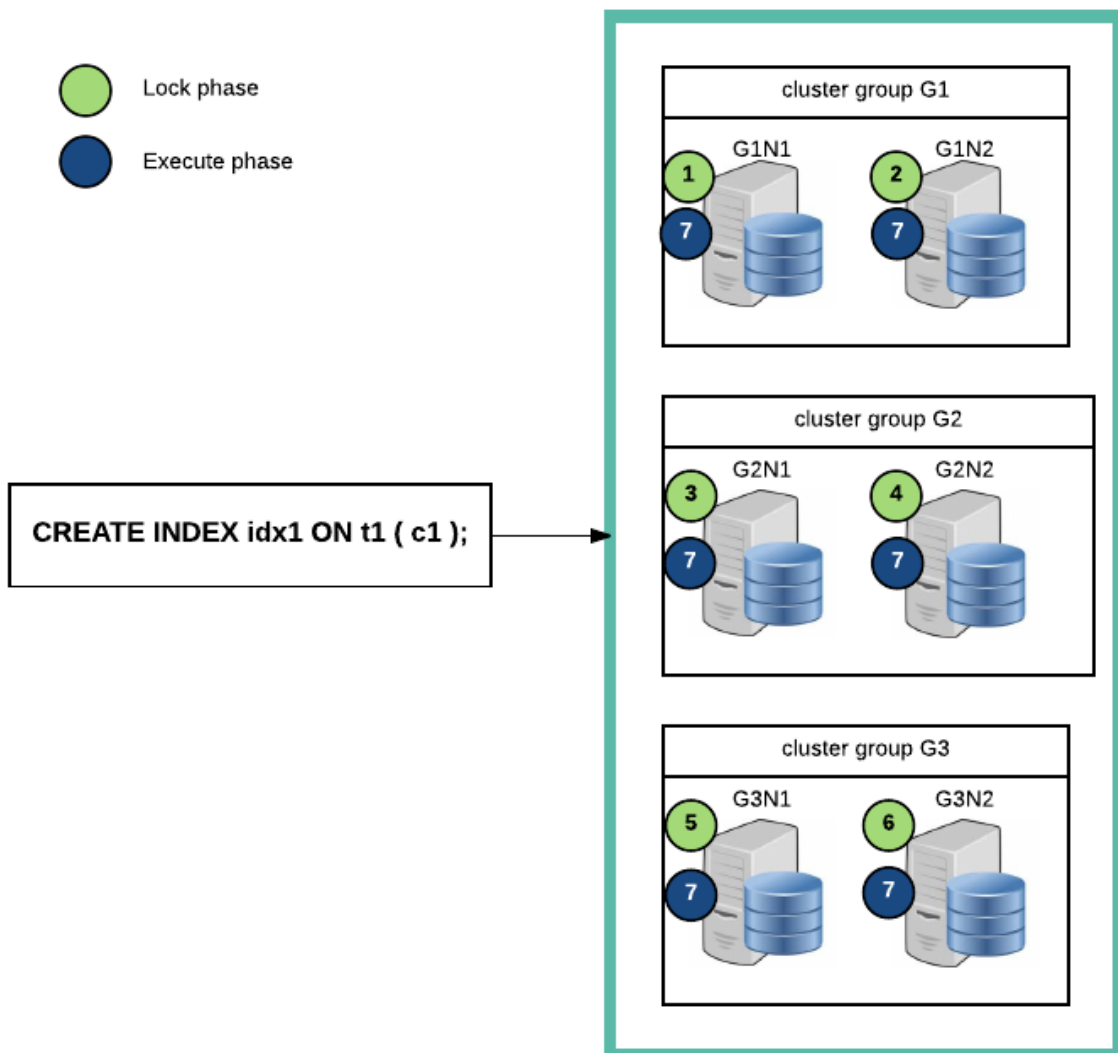

DDL is performed through two phases, which are a lock phase and an execution phase. On the lock phase, a lock which is required for performing DDL is acquired and DDL is sequentially performed on every cluster member. On the execute phase, DDL is simultaneously performed for every cluster member.

DDL is completed when DDL is successfully performed on every cluster member. If DDL fails on a specific cluster member, then DDL operations on every cluster member are cancelled. DDL can not be performed if an error occurred in any cluster member. All cluster members synchronize meta information for objects through this process.

Simultaneous DDL Execution

The cluster object DDL which changes the cluster system configuration and the SQL object DDL can not be simultaneously performed. The availability of simultaneously performing the cluster object DDL and the SQL object DDL are as follows.

Table 12-6 Availability of simultaneously performing DDL

DDL	Cluster object DDL	SQL object DDL
Cluster object DDL	X	X
SQL object DDL	X	O

The following DDL can not be simultaneously performed as given above.

- Cluster object DDL and cluster object DDL
 - (X) CREATE CLUSTER GROUP g2 CLUSTER MEMBER g2n1 HOST '192.168.0.21' PORT 10210;
 - (X) ALTER CLUSTER GROUP g1 ADD CLUSTER MEMBER g1n2 HOST '192.168.0.12' PORT 10120;
- Cluster object DDL and SQL object DDL
 - (X) CREATE CLUSTER GROUP g2 CLUSTER MEMBER g2n1 HOST '192.168.0.21' PORT 10210;
 - (X) CREATE TABLE t1 (c1 INTEGER);
- SQL object DDL and SQL object DDL
 - (O) CREATE TABLE t1 (c1 INTEGER);
 - (O) CREATE TABLE t2 (a1 INTEGER);

Processing SELECT in Cluster

Processing Query in Cluster

Generally, a query processing of the cluster is similar to that of the stand alone. However, when the data exist on both a local server and a remote server, it is different that the cluster requests the query processing to a remote server and receives the result from it.

There are a sharded table and a cloned table (Refer to **Cluster Table and Shard**) in a cluster environment,

and each table data is stored in a local server and a remote server. The sharded table data is dividedly stored in a group, and its duplicated data is stored in members of the same group. The data is duplicated and stored in every group and member of a cloned table.

The following figure describes a 3 x 2 GOLDILOCKS cluster and tables stored in that cluster.

Figure 2 3 x 2 cluster configuration and tables

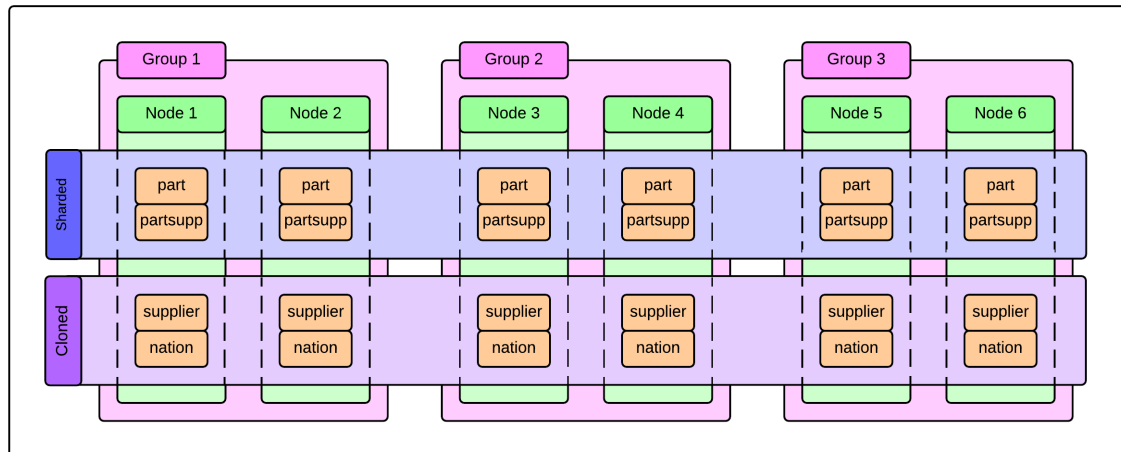

The following DDL creates the tables given above.

```
CREATE TABLE part
(
    p_partkey    INTEGER
, p_name       VARCHAR(55)
, p_brand      CHAR(10)
, p_type       VARCHAR(25)
, p_size       INTEGER
, p_retailprice NUMERIC(12,2)
, CONSTRAINT part_pk PRIMARY KEY( p_partkey ) INDEX part_pk_index
)
SHARDING BY HASH(p_partkey)
SHARD COUNT 3;
CREATE TABLE partsupp
(
    ps_partkey   INTEGER
, ps_suppkey    INTEGER
, ps_availqty   INTEGER
, ps_supplycost NUMERIC(12,2)
, CONSTRAINT partsupp_pk PRIMARY KEY( ps_partkey, ps_suppkey ) INDEX partsupp_pk_index
)
SHARDING BY HASH(ps_partkey)
SHARD COUNT 3;
```

```

CREATE TABLE supplier
(
    s_suppkey    INTEGER
  , s_name      CHAR(25)
  , s_nationkey INTEGER
  , s_phone     CHAR(15)
  , CONSTRAINT supplier_pk PRIMARY KEY( s_suppkey ) INDEX supplier_pk_index
) CLONED;
CREATE TABLE nation
(
    n_nationkey  INTEGER
  , n_name       CHAR(25)
) CLONED;

```

In the figure above, the part table and the partsupp table is a sharded table, and their data are dividedly stored per a group. The supplier table is a cloned table and its data is duplicated and stored in every node.

GOLDILOCKS in a cluster environment processes a query depending on the table type and the location of search target data. The query processing in the cluster is divided into a query processing at a single table and a processing at two or more tables.

Query Process in a Single Table

The query processing in a single table is divided into a processing in a sharded table and a processing in a cloned table. A processing in a sharded table is dividedly stored in n groups, so it requests a query to both a local server and a remote server, and collects results to make a result set. GOLDILOCKS uses an access node called as cluster access to request a query to a remote server and receive a result. The cluster access simultaneously requests a query to both a local server and a remote server, and collects results in parallel to make a result set.

The following is an example of processing a query at a part table which is a sharded table.

```

gSQL> \explain plan
SELECT p_name, p_brand, p_type, cluster_group_id
FROM part;
P_NAME P_BRAND    P_TYPE CLUSTER_GROUP_ID
-----
Part#3 Brand#2    STEEL  1
Part#2 Brand#1    NICKEL 2
Part#5 Brand#3    STEEL  2
Part#1 Brand#1    COPPER 3
Part#4 Brand#3    NICKEL 3
5 rows selected.

```



```

>>> start print plan
< Execution Plan >
=====
|  IDX  |  NODE DESCRIPTION                               |  ROWS  |
=====
|   0   |  SELECT STATEMENT                               |         |
|   1   |    CLUSTER ACCESS ("PART") [HASH SHARDING]     |         5 |
|   2   |      TABLE ACCESS ("PART") [HASH SHARDING]    |         1 |
=====

1 - SQL : SELECT /*+ FULL("_A1") */
"A1"."P_NAME","A1"."P_BRAND","A1"."P_TYPE","A1".CLUSTER_GROUP_ID FROM
"PUBLIC"."PART"@LOCAL "_A1"
2 - READ COLUMNS : P_NAME, P_BRAND, P_TYPE
<<< end print plan

```

GOLDILOCKS specifies **Cluster Domain** for a sharded table, or specifies a shard with an equi condition of a shard key. When using a cluster domain, the search target is only the data in a specified domain. In this case, only the nodes belonging to the specified domain are accessible. If the cluster domain only needs to access a local server by using it, then a cluster access does not occur.

The following is an example of processing a query when allowing to access only to a local server by using the cluster domain.

```

gSQL> \explain plan
SELECT p_name, p_brand, p_type, cluster_group_id
FROM part@g1;
P_NAME P_BRAND P_TYPE CLUSTER_GROUP_ID
-----
Part#3 Brand#2 STEEL 1
1 row selected.
>>> start print plan
< Execution Plan >
=====
=====
|  IDX  |  NODE DESCRIPTION                               |  ROWS  |
=====
|   0   |  SELECT STATEMENT                               |         |
|   1   |    TABLE ACCESS ("PART"@G1) [HASH SHARDING]   |         1 |
=====

```

```

=====
====
1 - READ COLUMNS : P_NAME, P_BRAND, P_TYPE
<<< end print plan

```

Using an equi condition of a shard key indicates a specific shard of a table, and the query is transferred only to the domain in which the data of the corresponding shard key is located. When indicating a shard whose equi condition of a shard key is in a local server, differently from when specifying a cluster domain, a cluster access occurs, but it accesses only to a local server at an actual execution.

The following is an example of processing a query by using an equi condition.

```

gSQL> \explain plan
SELECT p_name, p_brand, p_type, cluster_group_id
  FROM part
 WHERE p_partkey = 3;
P_NAME P_BRAND   P_TYPE CLUSTER_GROUP_ID
-----
Part#3 Brand#2   STEEL          1
1 row selected.
>>> start print plan
< Execution Plan >
=====
====
|  IDX  |  NODE DESCRIPTION          |
ROWS |
-----
|   0   |  SELECT STATEMENT          |
|       |                             |
|   1   |  CLUSTER ACCESS ("PART") [HASH SHARDING] |
1 |
|   2   |  INDEX ACCESS ("PART", "PART_PK_INDEX") [HASH SHARDING] | 1)
1 |
=====
====
1 - SQL : SELECT /*+ INDEX_ASC("_A1", "PART_PK_INDEX") */
_A1"."P_PARTKEY", "_A1"."P_NAME", "_A1"."P_BRAND", "_A1"."P_TYPE", "_A1".CLUSTER_GROUP_ID FROM
"PUBLIC"."PART"@LOCAL "_A1" WHERE "_A1"."P_PARTKEY" = ?
      BIND PARAMS : {0} IN
      REFERENCE SHARD KEY VALUE : (3)
2 - READ INDEX COLUMNS : P_PARTKEY

```

```

READ TABLE COLUMNS : P_NAME, P_BRAND, P_TYPE
MIN RANGE : P_PARTKEY = 3
MAX RANGE : P_PARTKEY = 3

```

```
<<< end print plan
```

When processing a query for a cloned table in a cloned table, it is available in most of local servers because every node has a duplicated data unlike a sharded table. However, if a new group or a member is added, there is not any data for a cloned table in that group or that member. Therefore, the data should be retrieved from a remote server, then a cluster access occurs.

The following is an example of processing a query for a supplier, which is a cloned table.

```
gSQL> \explain plan
```

```
SELECT s_name, s_nation
FROM supplier;
```

S_NAME	S_NATION
Supplier#1	FRANCE
Supplier#2	KOREA
Supplier#3	GERMANY
Supplier#4	UNITED STATES
Supplier#5	CANADA

```
5 rows selected.
```

```
>>> start print plan
```

```
< Execution Plan >
```

```

=====
====
|  IDX  |  NODE DESCRIPTION          |
ROWS |
-----
|   0   |  SELECT STATEMENT          |
|       |                             |
|   1   |  TABLE ACCESS ("SUPPLIER") [CLONED] |
5 |
=====
====
1 - READ COLUMNS : S_NAME, S_NATION

```

```
<<< end print plan
```

Processing the Join Query

Whether to process a query for two or more tables in a cluster depends on the sharding type of the those tables. If the join condition for those tables are equi-join condition for a shard key, then GOLDILOCK processes that join in a local server and a remote server in parallel by using a join node of a cluster join.

A parallel processing for a join is available when data for a join processing is logically located in the same position. The combinations are a sharded table and a sharded table, a sharded table and a cloned table, a cloned table and a cloned table.

If the sharding strategy of a sharded table and a sharded table is same, and there is an equi condition for a shard key, then a parallel processing is available. It is because it is an equi-join with a same shard of when the shard arrangement is same.

In the figure above, it is assumed that a shard key of a part table is p_partkey, and a shard key of a partsupp is ps_partkey, and the following is an example of processing a query with an equi condition for a shard key of two tables.

```
gSQL> \explain plan
SELECT p_name, ps_availqty
   FROM part, partsupp
  WHERE p_partkey = ps_partkey;
```

```
P_NAME PS_AVAILQTY
```

```
-----
Part#3      8895
Part#3      4969
Part#2      3956
Part#2      4069
Part#5      4651
Part#5      4093
Part#1      3325
Part#1      8076
Part#4      8539
Part#4      3025
```

```
10 rows selected.
```

```
>>> start print plan
```

```
< Execution Plan >
```

```
=====
====
|  IDX  |  NODE DESCRIPTION  |
ROWS |
-----
----
```

```

| 0 | SELECT STATEMENT |
|
| 1 | CLUSTER JOIN |
10 |
| 2 | HASH JOIN (INNER JOIN) |
2 |
| 3 | TABLE ACCESS ("PARTSUPP") [HASH SHARDING] |
2 |
| 4 | HASH JOIN INSTANT ACCESS |
2 |
| 5 | TABLE ACCESS ("PART") [HASH SHARDING] |
1 |
=====
====
1 - SQL : SELECT /*+ KEEP_JOINED_TABLE FULL("_A1") USE_HASH("_A1") FULL("_A2")
USE_HASH("_A2") */ "_A2"."P_NAME", "_A1"."PS_AVAILQTY" FROM "PUBLIC"."PARTSUPP"@LOCAL "_A1"
INNER JOIN "PUBLIC"."PART"@LOCAL "_A2" ON "_A2"."P_PARTKEY" = "_A1"."PS_PARTKEY"
2 - JOINED COLUMNS : PART.P_NAME, PARTSUPP.PS_AVAILQTY
3 - READ COLUMNS : PS_PARTKEY, PS_AVAILQTY
4 - INDEX COLUMNS : P_PARTKEY
TABLE COLUMNS : P_NAME
READ COLUMNS : P_PARTKEY, P_NAME
HASH FILTER : P_PARTKEY = {PS_PARTKEY}
5 - READ COLUMNS : P_PARTKEY, P_NAME
<<< end print plan

```

In case when it is a sharded table and a cloned table, a parallel processing without any condition is available if a cloned table is also in the group in which a sharded table is. The following is an example of processing partsupp (a sharded table) and supplier (a cloned table) in parallel.

```

gSQL> \explain plan
SELECT s_name, ps_availqty
FROM supplier, partsupp
WHERE s_suppkey = ps_suppkey;
S_NAME          PS_AVAILQTY
-----
Supplier#1      8895
Supplier#4      4969
Supplier#5      3956
Supplier#2      4069
Supplier#1      4651

```

```

Supplier#4          4093
Supplier#3          3325
Supplier#2          8076
Supplier#3          8539
Supplier#5          3025

```

10 rows selected.

```
>>> start print plan
```

```
< Execution Plan >
```

```

=====
====
|  IDX  |  NODE DESCRIPTION          |
ROWS |
-----
----
|    0  |  SELECT STATEMENT          |
|
|    1  |  CLUSTER JOIN              |
10 |
|    2  |  HASH JOIN (INNER JOIN)    |
2 |
|    3  |  TABLE ACCESS ("PARTSUPP") [HASH SHARDING] |
2 |
|    4  |  HASH JOIN INSTANT ACCESS  |
2 |
|    5  |  TABLE ACCESS ("SUPPLIER") [CLONED]        |
5 |
=====
====
1 - SQL : SELECT /*+ KEEP_JOINED_TABLE FULL("_A1") USE_HASH("_A1") FULL("_A2")
USE_HASH("_A2") */ "_A2"."S_NAME", "_A1"."PS_AVAILQTY" FROM "PUBLIC"."PARTSUPP"@LOCAL "_A1"
INNER JOIN "PUBLIC"."SUPPLIER"@LOCAL "_A2" ON "_A2"."S_SUPPKEY" = "_A1"."PS_SUPPKEY"
2 - JOINED COLUMNS : SUPPLIER.S_NAME, PARTSUPP.PS_AVAILQTY
3 - READ COLUMNS : PS_SUPPKEY, PS_AVAILQTY
4 - INDEX COLUMNS : S_SUPPKEY
TABLE COLUMNS : S_NAME
READ COLUMNS : S_SUPPKEY, S_NAME
HASH FILTER : S_SUPPKEY = {PS_SUPPKEY}
5 - READ COLUMNS : S_SUPPKEY, S_NAME
<<< end print plan

```

In case when it is a cloned table and a cloned table, and if at least one node has both tables in it, then a p

parallel processing is available. If it is in a local server, then the cluster join is not used because accessing to a remote server is not required.

The following is an example of processing a query when 2 cloned tables (supplier, nation) are in a local server.

```

gSQL> \explain plan
SELECT s_name, n_name
  FROM supplier, nation
 WHERE s_nationkey = n_nationkey;
S_NAME          N_NAME
-----
Supplier#2      KOREA
Supplier#1      FRANCE
Supplier#3      GERMANY
Supplier#4      UNITED STATES
Supplier#5      CANADA
5 rows selected.
>>> start print plan
< Execution Plan >
=====
====
|  IDX  |  NODE DESCRIPTION          |
ROWS |
-----
----
|   0   |  SELECT STATEMENT          |
|
|   1   |  HASH JOIN (INNER JOIN)    |
5 |
|   2   |    TABLE ACCESS ("NATION") [CLONED] |
5 |
|   3   |    HASH JOIN INSTANT ACCESS |
5 |
|   4   |    TABLE ACCESS ("SUPPLIER") [CLONED] |
5 |
=====
====
1 - JOINED COLUMNS : SUPPLIER.S_NAME, NATION.N_NAME
2 - READ COLUMNS : N_NATIONKEY, N_NAME
3 - INDEX COLUMNS : S_NATIONKEY
  TABLE COLUMNS : S_NAME

```

```

          READ COLUMNS : S_NATIONKEY, S_NAME
          HASH FILTER : S_NATIONKEY = {N_NATIONKEY}
4 - READ COLUMNS : S_NAME, S_NATIONKEY
<<< end print plan

```

Cluster Domain

Cluster domain collects data from limited servers in a cluster environment. For example, to retrieve employees of a specific range in a sharded table configured per a salary interval, enquire it as follows by setting the corresponding cluster group as a cluster domain.

- Configure a sharded table per salary interval

```

gSQL> CREATE TABLE t1( name VARCHAR(128), salary INTEGER )
      SHARDING BY RANGE( salary )
          SHARD s1 VALUES LESS THAN ( 200 )      AT CLUSTER GROUP G1,
          SHARD s2 VALUES LESS THAN ( 400 )      AT CLUSTER GROUP G2,
          SHARD s3 VALUES LESS THAN ( MAXVALUE ) AT CLUSTER GROUP G3;

```

Table created.

```
gSQL> INSERT INTO t1 VALUES ( 'A', 500 );
```

1 row created.

```
gSQL> INSERT INTO t1 VALUES ( 'B', 100 );
```

1 row created.

```
gSQL> INSERT INTO t1 VALUES ( 'C', 300 );
```

1 row created.

- Retrieve employees in a specific salary range

```
gSQL> SELECT name, salary FROM t1@G2;
```

```
NAME SALARY
```

```
---- -
```

```
C      300
```

1 row selected.

Cluster domain is defined by targeting each table or view which is described in **from clause**, and by referring to . One of the followings can be selected.

- A cluster member performing a user query
- A cluster member performing a user query for an offline table
- All cluster groups
- A single cluster group
- A single cluster member

When a cluster member is selected as the cluster domain, it accesses to the server and collects the data. If the server does not have a data distribution for the table, then there is not any search result.

"@LOCAL_OFFLINE" cluster domain is supported to retrieve the offline table data on the server accessed by a user. If the table is online, then an error occurs.

When a cluster group is selected as the cluster domain, it accesses to a server which has a data distribution for the table and is able to communicate with, then collects the data. If there is not any accessible server, then there is not any search result.

When all cluster groups are selected as the cluster domain, then it collects the data from each cluster group, and transfers the result to a user.

The cluster domain can not be used to determine the target for the data update. In other words, <cluster domain> can not be applied to the table which is a DML target.

The cluster domain for the table which is a DML target causes a syntax error as follows.

```
gSQL> INSERT INTO T1@LOCAL VALUES ( 1 );
```

```
ERR-42000(16062): syntax error :
```

```
INSERT INTO T1@LOCAL VALUES ( 1 )
```

```
      *
```

```
ERROR at line 1:
```

```
gSQL> UPDATE T1@GLOBAL SET I1 = 1;
```

```
ERR-42000(40000): syntax error:
```

```
UPDATE T1@GLOBAL SET I1 = 1
```

```
.....^  ^
```

```
Error at line 1
```

```
gSQL> DELETE FROM T1@G1;
```

```
ERR-42000(40000): syntax error:
```

```
DELETE FROM T1@G1
```

```
.....^^
```

```
Error at line 1
```

The cluster domain for the table which is an alteration target of SELECT FOR UPDATE causes a syntax error as follows.

- The cluster domain for the target of data collection

```
gSQL> SELECT I1 FROM T1@LOCAL;
```

```
I1
```

```
--
```

```
1
```

```
1 row selected.
```

- The cluster domain for the target of data update

```
gSQL> SELECT I1 FROM T1@LOCAL FOR UPDATE;
ERR-42000(16062): syntax error :
SELECT I1 FROM T1@LOCAL FOR UPDATE
                *
ERROR at line 1:
```

Generated Query

The generated query is generated to refer to or to update the data in another server when processing a query given by a user.

```
SELECT c1 FROM t1;
```

When the query is given by a user as above, then the server to which the query is given generates a generated query to collect the t1 data from all related cluster groups as follows.

```
SELECT c1 FROM t1@LOCAL;
```

The following constructed table is used to describe a generated query.

```
CREATE TABLE t_shard_1( shard_key INTEGER, c1 INTEGER )
    SHARDING BY RANGE( shard_key )
        SHARD s1 VALUES LESS THAN ( 200 )      AT CLUSTER GROUP G1,
        SHARD s2 VALUES LESS THAN ( 400 )      AT CLUSTER GROUP G2,
        SHARD s3 VALUES LESS THAN ( MAXVALUE ) AT CLUSTER GROUP G3;
CREATE TABLE t_shard_2( shard_key INTEGER, c1 INTEGER )
    SHARDING BY RANGE( shard_key )
        SHARD s1 VALUES LESS THAN ( 300 )      AT CLUSTER GROUP G1,
        SHARD s2 VALUES LESS THAN ( MAXVALUE ) AT CLUSTER GROUP G3;
CREATE TABLE t_clone_1( c1 INTEGER ) CLONED AT CLUSTER WIDE;
CREATE TABLE t_clone_2( c1 INTEGER ) CLONED AT CLUSTER GROUP G2, G3;
```

Configuring Generated Query

The generated query reconfigures a query based on the plan node information. The following plan nodes can be configured as a generated query.

- Access node
 - Table access
 - Index access

- Rowid access
- Join node
 - Nested loops join
 - Hash join
 - Merge join (It is not currently supported.)
- Configuring a generated query for an access node

```

gSQL> \EXPLAIN PLAN ONLY
SELECT 1 FROM t_shard_1;
>>> start print plan
< Execution Plan >
=====
====
|  IDX  |  NODE DESCRIPTION          |
ROWS |
-----
|   0   |  SELECT STATEMENT          |
|       |                             |
|   1   |  CLUSTER ACCESS ("T_SHARD_1") [RANGE SHARDING] |
0 |
|   2   |  TABLE ACCESS ("T_SHARD_1") [RANGE SHARDING] |
0 |
=====
====
1 - SQL : SELECT /*+ FULL("_A1") */ NULL FROM "PUBLIC"."T_SHARD_1"@LOCAL "_A1"
2 - READ COLUMNS : NOTHING
<<< end print plan

```

- Configuring a generated query for a join node

```

gSQL> \EXPLAIN PLAN ONLY
SELECT * FROM t_shard_1, t_clone_1 WHERE t_shard_1.shard_key = t_clone_1.c1;
>>> start print plan
< Execution Plan >
=====
====
|  IDX  |  NODE DESCRIPTION          |
ROWS |
-----
-----

```

```

| 0 | SELECT STATEMENT |
|
| 1 | CLUSTER JOIN |
0 |
| 2 | HASH JOIN (INNER JOIN) |
0 |
| 3 | TABLE ACCESS ("T_CLONE_1") [CLONED] |
0 |
| 4 | HASH JOIN INSTANT ACCESS |
0 |
| 5 | TABLE ACCESS ("T_SHARD_1") [RANGE SHARDING] |
0 |
=====
====
1 - SQL : SELECT /*+ KEEP_JOINED_TABLE FULL("_A1") USE_HASH("_A1") FULL("_A2")
USE_HASH("_A2") */ "_A2"."SHARD_KEY", "_A2"."C1", "_A1"."C1" FROM "PUBLIC"."T_CLONE_1"@LOCAL
"_A1" INNER JOIN "PUBLIC"."T_SHARD_1"@LOCAL "_A2" ON "_A2"."SHARD_KEY" = "_A1"."C1"
2 - JOINED COLUMNS : T_SHARD_1.SHARD_KEY, T_SHARD_1.C1, T_CLONE_1.C1
3 - READ COLUMNS : C1
4 - INDEX COLUMNS : SHARD_KEY
TABLE COLUMNS : C1
READ COLUMNS : SHARD_KEY, C1
HASH FILTER : SHARD_KEY = {C1}
5 - READ COLUMNS : SHARD_KEY, C1
<<< end print plan

```

The generated query is configured based on the most appropriate plan among the available plan nodes by considering the cost.

When joining two tables as above, the generated query can be generated based on an access node for `t_shard_1` and `t_clone_1`. Or, the generated query can be generated based on a join mode for two tables.

In the former case, the generated query based on two access nodes should be performed to process SELECT. In the latter case, the generated query based on a join node should be performed. An optimizer will select the latter execution plan in an environment whose communication cost is more expensive than the record navigation time.

When a user requests the data update such as **Processing DML in Cluster**, then the generated query including the data update feature is generated

The following **Constraints of Generated Query Configuration** determines the range of the contents for configuring the generated query, or determines it is impossible to configure the generated query.

Constraints of Generated Query Configuration

The generated query configuration is constrained in the following cases.

- Grouping
- Ordering
- Offset & limit
- Using Non-deterministic Expression
- Joining Shard Tables Whose Sharding Strategies Are Different Each Other
- Joining Shard Tables without Equi-join Condition for shard_key
- When Unable to Unnest Subquery
- When Including a Subquery with Different Sharding Strategy

Grouping



The grouping information is not configured with a generated query.

- The generated query does not include the grouping information.

```
gSQL> \EXPLAIN PLAN ONLY
SELECT 1 FROM t_shard_1 GROUP BY shard_key;
>>> start print plan
< Execution Plan >
=====
====
|  IDX  |  NODE DESCRIPTION          |
ROWS |
-----
----
|   0   |  SELECT STATEMENT          |
|
|   1   |  GROUP HASH INSTANT ACCESS |
0 |
|   2   |  CLUSTER ACCESS ("T_SHARD_1") [RANGE SHARDING] |
0 |
|   3   |  TABLE ACCESS ("T_SHARD_1") [RANGE SHARDING] |
0 |
=====
====
1 - GROUPING COLUMNS : SHARD_KEY
2 - SQL : SELECT /*+ FULL("_A1") */ "_A1"."SHARD_KEY" FROM "PUBLIC"."T_SHARD_1"@LOCAL
```

```
"_A1"
      3 - READ COLUMNS : SHARD_KEY
<<< end print plan
```

- The generated query does not include the grouping information.

```
gSQL> \EXPLAIN PLAN ONLY
SELECT DISTINCT c1 FROM t_shard_1;
>>> start print plan
< Execution Plan >
=====
====
|  IDX  |  NODE DESCRIPTION          |
ROWS |
-----
|   0   |  SELECT STATEMENT          |
|       |                             |
|   1   |  GROUP HASH INSTANT ACCESS |
0 |
|   2   |  CLUSTER ACCESS ("T_SHARD_1") [RANGE SHARDING] |
0 |
|   3   |  TABLE ACCESS ("T_SHARD_1") [RANGE SHARDING] |
0 |
=====
====
      1 - GROUPING COLUMNS : C1
          READ COLUMNS : C1
      2 - SQL : SELECT /*+ FULL("_A1") */ "_A1"."C1" FROM "PUBLIC"."T_SHARD_1"@LOCAL "_A1"
      3 - READ COLUMNS : C1
<<< end print plan
```

Ordering



The ordering information is not configured with a generated query.

- The generated query does not include the ordering information.

```
gSQL> \EXPLAIN PLAN ONLY
SELECT 1 FROM t_shard_1 ORDER BY c1;
>>> start print plan
```

```
< Execution Plan >
```

```
=====
====
|  IDX  |  NODE DESCRIPTION                               |
ROWS |
-----
----
|   0   |  SELECT STATEMENT                               | |
|       |  |                                               |
|   1   |  SORT INSTANT ACCESS                           |
0 |
|   2   |  CLUSTER ACCESS ("T_SHARD_1") [RANGE SHARDING] |
0 |
|   3   |  TABLE ACCESS ("T_SHARD_1") [RANGE SHARDING] |
0 |
=====
====
1 - SORT KEY : "T_SHARD_1.C1 ASC NULLS LAST"
2 - SQL : SELECT /*+ FULL("_A1") */ "_A1"."C1" FROM "PUBLIC"."T_SHARD_1"@LOCAL "_A1"
3 - READ COLUMNS : C1
<<< end print plan
```

Offset & limit



The information about **offset limit clause** is not configured with a generated query.

- The generated query does not include the offset information.

```
gSQL> \EXPLAIN PLAN ONLY
```

```
SELECT c1 FROM t_shard_1 OFFSET 1;
```

```
>>> start print plan
```

```
< Execution Plan >
```

```
=====
====
|  IDX  |  NODE DESCRIPTION                               |
ROWS |
-----
----
|   0   |  SELECT STATEMENT                               | |
|       |  |                                               |
|   1   |  CLUSTER ACCESS ("T_SHARD_1") [RANGE SHARDING] |
```

```

0 |
| 2 | TABLE ACCESS ("T_SHARD_1") [RANGE SHARDING] |
0 |
=====
====
1 - SQL : SELECT /*+ FULL("_A1") */ "_A1"."C1" FROM "PUBLIC"."T_SHARD_1"@LOCAL "_A1"
2 - READ COLUMNS : C1
<<< end print plan

```

- The generated query does not include the limit information.

```

gSQL> \EXPLAIN PLAN ONLY
SELECT c1 FROM t_shard_1 LIMIT 1;
>>> start print plan
< Execution Plan >
=====
====
| IDX | NODE DESCRIPTION |
ROWS |
-----
| 0 | SELECT STATEMENT |
|
| 1 | CLUSTER ACCESS ("T_SHARD_1") [RANGE SHARDING] |
0 |
| 2 | TABLE ACCESS ("T_SHARD_1") [RANGE SHARDING] |
0 |
=====
====
1 - SQL : SELECT /*+ FULL("_A1") */ "_A1"."C1" FROM "PUBLIC"."T_SHARD_1"@LOCAL "_A1"
2 - READ COLUMNS : C1
<<< end print plan

```

Using Non-deterministic Expression



When using the non-deterministic expression, if non-deterministic expression can not be made into a constant, then it is not included in the generated query.

- The generated query does not include a sequence related expression.

```
gSQL> \EXPLAIN PLAN ONLY
SELECT seq.nextval FROM t_shard_1;
```

```
>>> start print plan
```

```
< Execution Plan >
```

```
=====
====
|  IDX  |  NODE DESCRIPTION          |
ROWS |
-----
|   0   |  SELECT STATEMENT          |
|       |                             |
|   1   |  CLUSTER ACCESS ("T_SHARD_1") [RANGE SHARDING] |
0 |
|   2   |  TABLE ACCESS ("T_SHARD_1") [RANGE SHARDING] |
0 |
=====
====
      1 - SQL : SELECT /*+ FULL("_A1") */ NULL FROM "PUBLIC"."T_SHARD_1"@LOCAL "_A1"
      2 - READ COLUMNS : NOTHING
```

```
<<< end print plan
```

- The non-deterministic expression is made into a constant by a FILTER node.
- The generated query includes the non-deterministic expression.

```
gSQL> \EXPLAIN PLAN ONLY
```

```
SELECT 1 FROM t_shard_1 WHERE shard_key = random( 1, 100 );
```

```
>>> start print plan
```

```
< Execution Plan >
```

```
=====
====
|  IDX  |  NODE DESCRIPTION          |
ROWS |
-----
|   0   |  SELECT STATEMENT          |
|       |                             |
|   1   |  FILTER                    |
0 |
|   2   |  CLUSTER ACCESS ("T_SHARD_1") [RANGE SHARDING] |
0 |
```

```

| 3 |          TABLE ACCESS ("T_SHARD_1") [RANGE SHARDING]          |
0 |
=====
====
1 -  READ COLUMNS : NOTHING
    NODE EXPR : RANDOM(1,100)
2 -  SQL : SELECT /*+ FULL("_A1") */ "_A1"."SHARD_KEY" FROM "PUBLIC"."T_SHARD_1"@LOCAL
"_A1" WHERE "_A1"."SHARD_KEY" = ?
    BIND PARAMS : {0} IN
3 -  READ COLUMNS : SHARD_KEY
    PHYSICAL FILTER : SHARD_KEY = ?
<<< end print plan

```

- The non-deterministic expression can not be made into a constant.
- The generated query does not include the non-deterministic expression.

```

gSQL> \EXPLAIN PLAN ONLY
SELECT 1 FROM t_shard_1 WHERE shard_key = random( c1, 100 );
>>> start print plan
< Execution Plan >
=====
====
| IDX | NODE DESCRIPTION          |
ROWS |
-----
| 0 | SELECT STATEMENT          |
|   |
| 1 | FILTER                    |
0 |
| 2 | CLUSTER ACCESS ("T_SHARD_1") [RANGE SHARDING] |
0 |
| 3 | TABLE ACCESS ("T_SHARD_1") [RANGE SHARDING] |
0 |
=====
====
1 -  READ COLUMNS : NOTHING
    FILTER : T_SHARD_1.SHARD_KEY = RANDOM(T_SHARD_1.C1,100)
2 -  SQL : SELECT /*+ FULL("_A1") */ "_A1"."SHARD_KEY", "_A1"."C1" FROM
"PUBLIC"."T_SHARD_1"@LOCAL "_A1"
3 -  READ COLUMNS : SHARD_KEY, C1

```

```
<<< end print plan
```

Joining Shard Tables Whose Sharding Strategies Are Different Each Other



The generated query can not be generated for shard tables whose sharding strategies are different each other.

- The generated query for the join can not be configured.
- The generated query related to an access is generated on the cluster access node.

```
gSQL> \EXPLAIN PLAN ONLY
```

```
SELECT 1 FROM t_shard_1, t_shard_2 WHERE t_shard_1.shard_key = t_shard_2.shard_key;
```

```
>>> start print plan
```

```
< Execution Plan >
```

```
=====
====
|  IDX  |  NODE DESCRIPTION          |
ROWS |
-----
----
|  0  |  SELECT STATEMENT          |
|
|  1  |  HASH JOIN (INNER JOIN)    |
0 |
|  2  |  CLUSTER ACCESS ("T_SHARD_1") [RANGE SHARDING] |
0 |
|  3  |  TABLE ACCESS ("T_SHARD_1") [RANGE SHARDING] |
0 |
|  4  |  HASH JOIN INSTANT ACCESS   |
0 |
|  5  |  CLUSTER ACCESS ("T_SHARD_2") [RANGE SHARDING] |
0 |
|  6  |  TABLE ACCESS ("T_SHARD_2") [RANGE SHARDING] |
0 |
=====
====
1 - JOINED COLUMNS : NOTHING
2 - SQL : SELECT /*+ FULL("_A1") */ "_A1"."SHARD_KEY" FROM "PUBLIC"."T_SHARD_1"@LOCAL
   "_A1"
3 - READ COLUMNS : SHARD_KEY
4 - INDEX COLUMNS : SHARD_KEY
```

```

        READ COLUMNS : SHARD_KEY
        HASH FILTER : {SHARD_KEY} = SHARD_KEY
5 - SQL : SELECT /*+ FULL("_A1") */ "_A1"."SHARD_KEY" FROM "PUBLIC"."T_SHARD_2"@LOCAL
"_A1"
6 - READ COLUMNS : SHARD_KEY
<<< end print plan

```

Joining Shard Tables without Equi-join Condition for shard_key



The generated query can not be generated for the shard table join without a equi-join condition for a shard_key.

- The generated query for the join can not be configured.
- The generated query related to an access is generated on the cluster access node.

```

gSQL> \EXPLAIN PLAN ONLY
SELECT 1 FROM t_shard_1, t_shard_1;
>>> start print plan
< Execution Plan >

=====
====
|  IDX  |  NODE DESCRIPTION          |
ROWS |
-----
----
|  0  |  SELECT STATEMENT          |
|
|  1  |  NESTED LOOP JOIN (INNER JOIN) |
0 |
|  2  |  CLUSTER ACCESS ("T_SHARD_1") [RANGE SHARDING] |
0 |
|  3  |  TABLE ACCESS ("T_SHARD_1") [RANGE SHARDING] |
0 |
|  4  |  CLUSTER ACCESS ("T_SHARD_1") [RANGE SHARDING] |
0 |
|  5  |  TABLE ACCESS ("T_SHARD_1") [RANGE SHARDING] |
0 |
=====
====
1 - JOINED COLUMNS : NOTHING
2 - SQL : SELECT /*+ FULL("_A1") */ NULL FROM "PUBLIC"."T_SHARD_1"@LOCAL "_A1"

```

```

3 - READ COLUMNS : NOTHING
4 - SQL : SELECT /*+ FULL("_A1") */ NULL FROM "PUBLIC"."T_SHARD_1"@LOCAL "_A1"
5 - READ COLUMNS : NOTHING
<<< end print plan

```

- The generated query for the join can not be configured.
- The generated query related to an access is generated on the cluster access node.

```
gSQL> \EXPLAIN PLAN ONLY
```

```
SELECT 1 FROM t_shard_1 A, t_shard_1 B WHERE A.c1 = B.c1;
```

```
>>> start print plan
```

```
< Execution Plan >
```

```

=====
====
|  IDX  |  NODE DESCRIPTION          |
ROWS |
-----
----
|   0   |  SELECT STATEMENT          |
|       |                             |
|   1   |  HASH JOIN (INNER JOIN)    |
0 |
|   2   |  CLUSTER ACCESS ("T_SHARD_1") [RANGE SHARDING] |
0 |
|   3   |  TABLE ACCESS ("T_SHARD_1" AS A) [RANGE SHARDING] |
0 |
|   4   |  HASH JOIN INSTANT ACCESS  |
0 |
|   5   |  CLUSTER ACCESS ("T_SHARD_1") [RANGE SHARDING] |
0 |
|   6   |  TABLE ACCESS ("T_SHARD_1" AS B) [RANGE SHARDING] |
0 |
=====
====

```

```

1 - JOINED COLUMNS : NOTHING
2 - SQL : SELECT /*+ FULL("_A1") */ "_A1"."C1" FROM "PUBLIC"."T_SHARD_1"@LOCAL "_A1"
3 - READ COLUMNS : C1
4 - INDEX COLUMNS : C1
   READ COLUMNS : C1
   HASH FILTER : {C1} = C1
5 - SQL : SELECT /*+ FULL("_A1") */ "_A1"."C1" FROM "PUBLIC"."T_SHARD_1"@LOCAL "_A1"

```

```
6 - READ COLUMNS : C1
```

```
<<< end print plan
```

- The generated query for the join can be configured.
- The generated query related to a join is generated on the cluster join node.

```
gSQL> \EXPLAIN PLAN ONLY
```

```
SELECT 1 FROM t_shard_1 A, t_shard_1 B WHERE A.shard_key = B.shard_key;
```

```
>>> start print plan
```

```
< Execution Plan >
```

```
=====
====
|  IDX  |  NODE DESCRIPTION          |
ROWS |
-----
----
|  0  |  SELECT STATEMENT          |
|
|  1  |  CLUSTER JOIN              |
0 |
|  2  |  HASH JOIN (INNER JOIN)    |
0 |
|  3  |  TABLE ACCESS ("T_SHARD_1" AS A) [RANGE SHARDING] |
0 |
|  4  |  HASH JOIN INSTANT ACCESS  |
0 |
|  5  |  TABLE ACCESS ("T_SHARD_1" AS B) [RANGE SHARDING] |
0 |
=====
====
1 - SQL : SELECT /*+ KEEP_JOINED_TABLE FULL("_A1") USE_HASH("_A1") FULL("_A2")
USE_HASH("_A2") */ NULL FROM "PUBLIC"."T_SHARD_1"@LOCAL "_A1" INNER JOIN
"PUBLIC"."T_SHARD_1"@LOCAL "_A2" ON "_A1"."SHARD_KEY" = "_A2"."SHARD_KEY"
2 - JOINED COLUMNS : NOTHING
3 - READ COLUMNS : SHARD_KEY
4 - INDEX COLUMNS : SHARD_KEY
   READ COLUMNS : SHARD_KEY
   HASH FILTER : {SHARD_KEY} = SHARD_KEY
5 - READ COLUMNS : SHARD_KEY
<<< end print plan
```

When Unable to Unnest Subquery



A subquery which can be made into a constant is included in the generated query in a bind parameter form.

A subquery which can not be made into a constant is not included in the generated query.

For more information about unnesting a subquery, refer to **Subquery**.

- The generated query for the join can not be configured.
- The generated query related to an access is generated on the cluster access node.

```
gSQL> \EXPLAIN PLAN ONLY
SELECT 1 FROM t_shard_1 WHERE shard_key IN ( SELECT /*+ NO_QUERY_TRANSFORMATION */ shard_key
FROM t_shard_1 );
>>> start print plan
< Execution Plan >

=====
====
|  IDX  |  NODE DESCRIPTION                               |
ROWS |
-----
----
|    0  |  SELECT STATEMENT                               |
|
|    1  |    FILTER                                       |
0 |
|    2  |      CLUSTER ACCESS ("T_SHARD_1") [RANGE SHARDING] |
0 |
|    3  |        TABLE ACCESS ("T_SHARD_1") [RANGE SHARDING] |
0 |
|    4  |          SUB QUERY LIST                         |
0 |
|    5  |            SUB QUERY FUNCTION (MATERIALIZED)    |
0 |
|    6  |              CLUSTER ACCESS ("T_SHARD_1") [RANGE SHARDING] |
0 |
|    7  |                TABLE ACCESS ("T_SHARD_1") [RANGE SHARDING] |
0 |
=====
====
1 - READ COLUMNS : NOTHING
```

```

                SUBQUERY FILTER : ( T_SHARD_1.SHARD_KEY ) IN ( T_SHARD_1.SHARD_KEY )
2 - SQL : SELECT /*+ FULL("_A1") */ "_A1"."SHARD_KEY" FROM "PUBLIC"."T_SHARD_1"@LOCAL
"_A1"
3 - READ COLUMNS : SHARD_KEY
5 - FUNCTION : ( SHARD_KEY ) IN ( SHARD_KEY )
6 - SQL : SELECT /*+ FULL("_A1") */ "_A1"."SHARD_KEY" FROM "PUBLIC"."T_SHARD_1"@LOCAL
"_A1"
7 - READ COLUMNS : SHARD_KEY
<<< end print plan

```

- The generated query can not include a subquery.

```
gSQL> \EXPLAIN PLAN ONLY
```

```
SELECT 1 FROM t_shard_1 WHERE shard_key = ( SELECT t_shard_1.c1 FROM dual );
```

```
>>> start print plan
```

```
< Execution Plan >
```

```

=====
====
|  IDX  |  NODE DESCRIPTION                               |
ROWS |
-----
----
|   0   |  SELECT STATEMENT                               |
|
|   1   |    FILTER                                       |
0 |
|   2   |      CLUSTER ACCESS ("T_SHARD_1") [RANGE SHARDING] |
0 |
|   3   |        TABLE ACCESS ("T_SHARD_1") [RANGE SHARDING] |
0 |
|   4   |          SUB QUERY LIST                         |
0 |
|   5   |            TABLE ACCESS ("DUAL") [CLONED]      |
0 |
=====
====
1 - READ COLUMNS : NOTHING
    SUBQUERY FILTER : T_SHARD_1.SHARD_KEY = {C1}
2 - SQL : SELECT /*+ FULL("_A1") */ "_A1"."SHARD_KEY","_A1"."C1" FROM
"PUBLIC"."T_SHARD_1"@LOCAL "_A1"
3 - READ COLUMNS : SHARD_KEY, C1

```



```

4 - READ COLUMNS : {C1}
5 - READ COLUMNS : NOTHING
<<< end print plan

```

- The generated query includes a subquery.

```

gSQL> \EXPLAIN PLAN ONLY
SELECT 1 FROM t_shard_1 WHERE shard_key = ( SELECT 1 FROM dual );
>>> start print plan
< Execution Plan >
=====
====
|  IDX  |  NODE DESCRIPTION                               |
ROWS |
-----
|   0   |  SELECT STATEMENT                               |
|
|   1   |  CLUSTER ACCESS ("T_SHARD_1") [RANGE SHARDING] |
0 |
|   2   |  TABLE ACCESS ("T_SHARD_1") [RANGE SHARDING] |
0 |
|   3   |  SUB QUERY LIST                                 |
0 |
|   4   |  TABLE ACCESS ("DUAL") [CLONED]               |
0 |
=====
====
1 - SQL : SELECT /*+ FULL("_A1") */ "_A1"."SHARD_KEY" FROM "PUBLIC"."T_SHARD_1"@LOCAL
"_A1" WHERE "_A1"."SHARD_KEY" = ?
      BIND PARAMS : {0} IN
2 - READ COLUMNS : SHARD_KEY
      PHYSICAL FILTER : SHARD_KEY = 1
3 - READ COLUMNS : 1
4 - READ COLUMNS : NOTHING
<<< end print plan

```

When Including a Subquery with Different Sharding Strategy



It is a similar situation with when joining shard tables whose sharding strategies are different each other, and it can not configure the generated query by using the join in a form of the unnested subquery.

For more information about unnesting a subquery, refer to **Subquery**.

- The generated query for the join can not be configured.
- The generated query related to an access is generated on the cluster access node.

```
gSQL> \EXPLAIN PLAN ONLY
SELECT 1 FROM t_shard_1 WHERE shard_key IN ( SELECT shard_key FROM t_shard_2 );
>>> start print plan
< Execution Plan >

=====
====
|  IDX  |  NODE DESCRIPTION                                     |
ROWS |
-----
----
|   0   |  SELECT STATEMENT                                     |
|
|   1   |  HASH JOIN (LEFT SEMI)                                |
0 |
|   2   |  CLUSTER ACCESS ("T_SHARD_1") [RANGE SHARDING]       |
0 |
|   3   |  TABLE ACCESS ("T_SHARD_1") [RANGE SHARDING]       |
0 |
|   4   |  HASH JOIN INSTANT ACCESS (UNIQUE)                   |
0 |
|   5   |  CLUSTER ACCESS ("T_SHARD_2") [RANGE SHARDING]       |
0 |
|   6   |  TABLE ACCESS ("T_SHARD_2") [RANGE SHARDING]       |
0 |
=====
====
1 - JOINED COLUMNS : NOTHING
2 - SQL : SELECT /*+ FULL("_A1") */ "_A1"."SHARD_KEY" FROM "PUBLIC"."T_SHARD_1"@LOCAL
"_A1"
3 - READ COLUMNS : SHARD_KEY
4 - INDEX COLUMNS : SHARD_KEY
```

```

        HASH FILTER : {SHARD_KEY} = SHARD_KEY
    5 - SQL : SELECT /*+ FULL("_A1") */ "_A1"."SHARD_KEY" FROM "PUBLIC"."T_SHARD_2"@LOCAL
    "_A1"
    6 - READ COLUMNS : SHARD_KEY
<<< end print plan

```

- The generated query for the join can be configured.
- The generated query related to a join is generated on the cluster join node.

```

gSQL> \EXPLAIN PLAN ONLY
SELECT 1 FROM t_shard_1 WHERE shard_key IN ( SELECT shard_key FROM t_shard_1 );
>>> start print plan
< Execution Plan >
=====
====
|  IDX  |  NODE DESCRIPTION          |
ROWS |
-----
----
|   0   |  SELECT STATEMENT          |
|       |                             |
|   1   |  CLUSTER JOIN              |
0 |
|   2   |  HASH JOIN (LEFT SEMI)     |
0 |
|   3   |  TABLE ACCESS ("T_SHARD_1") [RANGE SHARDING] |
0 |
|   4   |  HASH JOIN INSTANT ACCESS (UNIQUE) |
0 |
|   5   |  TABLE ACCESS ("T_SHARD_1") [RANGE SHARDING] |
0 |
=====
====
    1 - SQL : SELECT /*+ FULL("_A1") */ NULL FROM "PUBLIC"."T_SHARD_1"@LOCAL "_A1" WHERE
    EXISTS( SELECT /*+ HASH_SJ FULL("_A2") */ TRUE FROM "PUBLIC"."T_SHARD_1"@LOCAL "_A2" WHERE
    "_A1"."SHARD_KEY" = "_A2"."SHARD_KEY" )
    2 - JOINED COLUMNS : NOTHING
    3 - READ COLUMNS : SHARD_KEY
    4 - INDEX COLUMNS : SHARD_KEY
        HASH FILTER : {SHARD_KEY} = SHARD_KEY
    5 - READ COLUMNS : SHARD_KEY

```

```
||| <<< end print plan
```

Selecting a Target Server for Performing Generated Query

It analyzes the following information and selects a target to perform the generated query.

- The table replication arrangement policy
- **Cluster Domain**
- The condition to retrieve a sharding key

It analyzes the information above of tables included in the generated query, then selects their common server as a server for performing the generated query.

The following is a summary of the table replication arrangement policy defined to describe **Generated Query**.

```
||| t_shard_1 (shard table) : at cluster group G1, G2, G3
||| t_shard_2 (shard table) : at cluster group G1, G3
||| t_clone_1 (cloned table) : at cluster group G1, G2, G3 (cluster wide)
||| t_clone_2 (cloned table) : at cluster group G2, G3
```

The following is an example of selecting a target server for performing according to the table replication arrangement policy.

- The target server for performing: All servers in G1, G3

```
||| gSQL> SELECT c1 FROM t_shard_2;
```

- The target server for performing: All servers in G1, G2, G3

```
||| gSQL> SELECT c1 FROM t_clone_1;
```

- The target server for performing: All servers in G1, G3 (The common cluster group)

```
||| gSQL> SELECT c1 FROM t_shard_2, t_clone_1;
```

The following is an example of selecting the target server for performing according to description of the cluster domain.

- The target server for performing: All servers in G1, G2, G3

```
||| gSQL> SELECT c1 FROM t_shard_1@GLOBAL;
```

- The target server for performing: The server which received a request from a user

```
gSQL> SELECT c1 FROM t_shard_1@LOCAL;
```

- The target server for performing: All servers in G2

```
gSQL> SELECT c1 FROM t_shard_1@G2;
```

- The target server for performing: G3N1 server

```
gSQL> SELECT c1 FROM t_shard_1@G3N1;
```

- The target server for performing: There is not a target server.

```
gSQL> SELECT c1 FROM t_shard_1@G4;
```

The following is an example of selecting the target server for performing according to the retrieving condition for a sharding key.

- The target server for performing: All servers in G1, G2, G3

```
gSQL> SELECT c1 FROM t_shard_1;
```

- The target server for performing: All servers in G1, G2, G3

```
gSQL> SELECT c1 FROM t_shard_1 WHERE c1 = 1;
```

- The target server for performing: All servers in G3

```
gSQL> SELECT c1 FROM t_shard_1 WHERE shard_key = 500;
```

- The target server for performing: There is not a target server.

```
gSQL> SELECT c1 FROM t_shard_1 WHERE shard_key = 100 AND shard_key = 500;
```

Selecting the target server for performing the generated query on a query processing phase may vary depending on whether the data is updated when performing the generated query.

Selecting Target Server for Generated Query Updating the Data

When performing the generated query to update the data, the performing target cluster group is analyzed by the table replication arrangement policy and the condition for retrieving a sharding key. All servers in the performing target cluster group is selected as targets for performing generated query.

Cluster Domain can not be specified in a user query updating the data.

When performing the generated query to update the data, the performing target is divided into a master

server and a slave server. For more information, refer to **Data Update Using Generated Query**.

The following is an example of selecting the performing target server.

- Generated query performing target server: All servers in G2
- t_shard_1: All servers in G2
- The table replication arrangement policy: All servers in G1, G2, G3
- The condition for retrieving a sharding key: All servers in G2
- t_clone_1: All servers in G1, G2, G3
- The table replication arrangement policy: All servers in G1, G2, G3

```
gSQL> \EXPLAIN PLAN ONLY
SELECT * FROM t_shard_1, t_clone_1 WHERE t_shard_1.shard_key = 300 FOR UPDATE;
>>> start print plan
< Execution Plan >
=====
====
|  IDX  |  NODE DESCRIPTION          |
ROWS |
-----
|   0   |  SELECT STATEMENT          |
|       |                             |
|   1   |  CLUSTER JOIN              |
0 |
|   2   |  NESTED LOOP JOIN (INNER JOIN) |
0 |
|   3   |  TABLE ACCESS ("T_SHARD_1") [RANGE SHARDING] |
0 |
|   4   |  TABLE ACCESS ("T_CLONE_1") [CLONED] |
0 |
=====
====
1 - SQL : SELECT /*+ KEEP_JOINED_TABLE FULL("_A1") USE_NL("_A1") FULL("_A2")
USE_NL("_A2") */ "_A1"."SHARD_KEY", "_A1"."C1", "_A2"."C1", "_A1".ROWID, "_A2".ROWID FROM
"PUBLIC"."T_SHARD_1"@LOCAL "_A1" INNER JOIN "PUBLIC"."T_CLONE_1"@LOCAL "_A2" ON
"_A1"."SHARD_KEY" = ?
      BIND PARAMS : {0} IN
      REFERENCE SHARD KEY VALUE (T_SHARD_1) : (300)
2 - JOINED COLUMNS : T_SHARD_1.SHARD_KEY, T_SHARD_1.C1, T_CLONE_1.C1
3 - READ COLUMNS : SHARD_KEY, C1
      PHYSICAL FILTER : SHARD_KEY = 300
```

```
4 - READ COLUMNS : C1
```

```
<<< end print plan
```

Selecting Target Server for Generated Query Retrieving the Data

When performing the generated query to retrieve the data, it retrieves the common servers by using the table replication arrangement policy and the condition for retrieving a sharding key. When multiple servers in a same cluster group become the targets, then the generated query is performed only for a single accessible server per cluster group considering the network condition.

The following is an example of selecting the performing target server.

- Generated query performing target server: A server in G2
- t_shard_1: All servers in G2
- The table replication arrangement policy: All servers in G1, G2, G3
- Cluster domain: All servers in G2
- The condition for retrieving a sharding key: All servers in G2
- t_clone_1: All servers in G1, G2, G3
- The table replication arrangement policy: All servers in G1, G2, G3
- Cluster domain: All servers in G1, G2, G3

```
gSQL> \EXPLAIN PLAN ONLY
```

```
SELECT * FROM t_shard_1@G2, t_clone_1 WHERE t_shard_1.shard_key = 300;
```

```
>>> start print plan
```

```
< Execution Plan >
```

```
=====
====
|  IDX  |  NODE DESCRIPTION                               |
ROWS |
-----
----
|    0  |  SELECT STATEMENT                               |
|
|    1  |  CLUSTER JOIN                                   |
0 |
|    2  |  NESTED LOOP JOIN (INNER JOIN)                 |
0 |
|    3  |  TABLE ACCESS ("T_SHARD_1"@G2N1) [RANGE SHARDING] |
0 |
|    4  |  TABLE ACCESS ("T_CLONE_1") [CLONED]          |
0 |
=====
```

====

```

1 - SQL : SELECT /*+ KEEP_JOINED_TABLE FULL("_A1") USE_NL("_A1") FULL("_A2")
USE_NL("_A2") */ "_A1"."SHARD_KEY", "_A1"."C1", "_A2"."C1" FROM "PUBLIC"."T_SHARD_1"@LOCAL "_A1"
INNER JOIN "PUBLIC"."T_CLONE_1"@LOCAL "_A2" ON "_A1"."SHARD_KEY" = ?
      BIND PARAMS : {0} IN
      REFERENCE SHARD KEY VALUE (T_SHARD_1) : (300)
2 - JOINED COLUMNS : T_SHARD_1.SHARD_KEY, T_SHARD_1.C1, T_CLONE_1.C1
3 - READ COLUMNS : SHARD_KEY, C1
      PHYSICAL FILTER : SHARD_KEY = 300
4 - READ COLUMNS : C1
<<< end print plan

```

Processing DML in Cluster

In GOLDILOCKS, a user can perform DML for all cluster members configuring a cluster system.

Data update on a cluster environment updates the data of the cluster member containing the same data replication same.

The following constructed table is used to describe the data update.

```

CREATE TABLE t1( shard_key INTEGER, c1 INTEGER )
      SHARDING BY RANGE( shard_key )
      SHARD s1 VALUES LESS THAN ( 200 )      AT CLUSTER GROUP G1,
      SHARD s2 VALUES LESS THAN ( 400 )      AT CLUSTER GROUP G2,
      SHARD s3 VALUES LESS THAN ( MAXVALUE ) AT CLUSTER GROUP G3;

```

DML is performed as the figure below on a cluster environment.

Figure 3 Processing DML in cluster

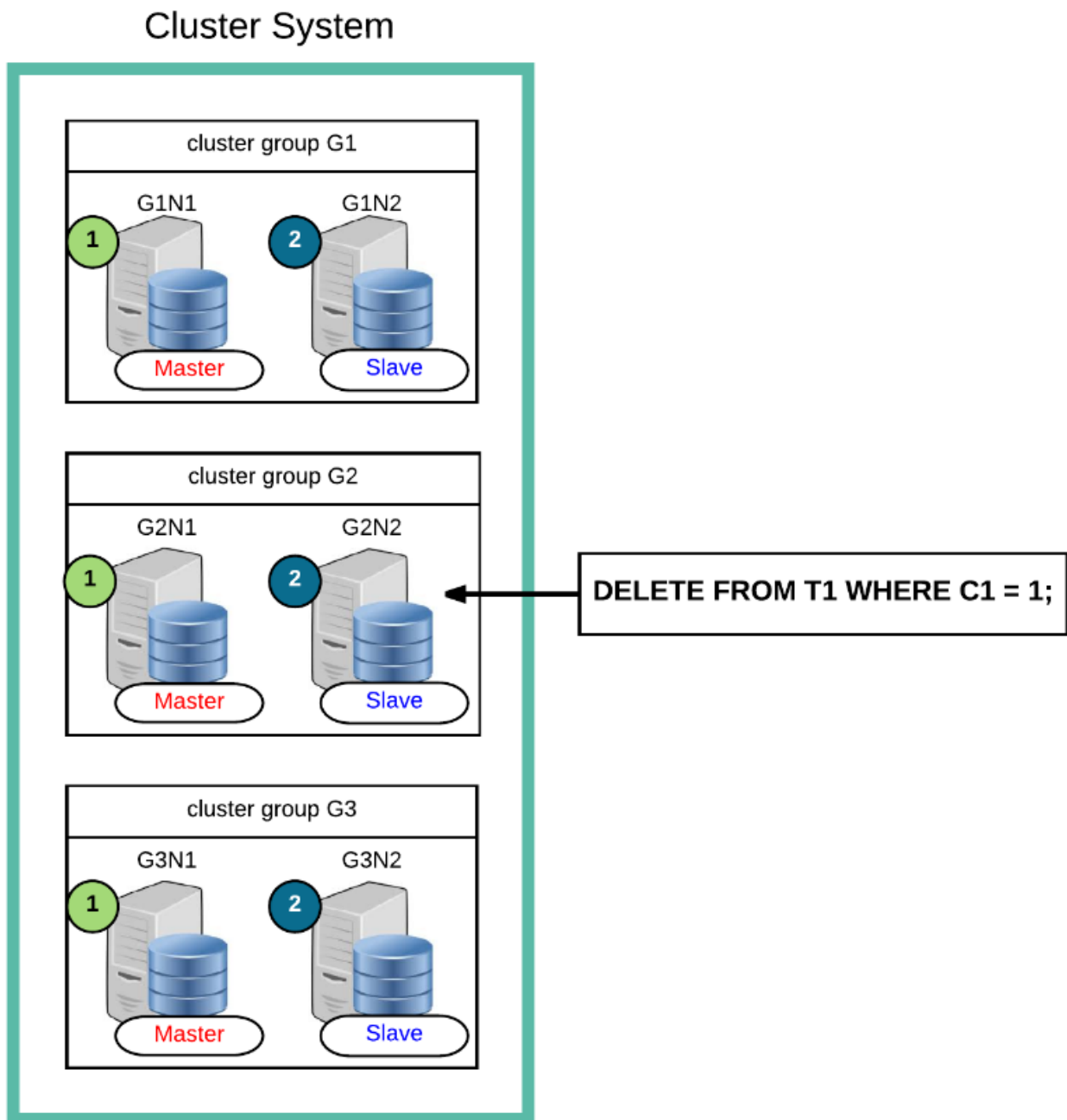

A master server and a slave server per each group are defined for the DML processing in cluster.

Selecting Master Server in Each Cluster Group

It is a single cluster member with the smallest member_id among accessible cluster members per each cluster group when updating data on a cluster environment.

Selecting Slave Server in Each Cluster Group

They are cluster members remained after excluding master servers from accessible cluster members per each cluster group when updating data on a cluster environment.

For more information about cluster group and cluster member configuration, refer to refer to **DBA_CLUSTER**.

```
gSQL> SELECT * FROM DBA_CLUSTER;
GROUP_ID GROUP_NAME MEMBER_ID MEMBER_NAME MEMBER_HOST MEMBER_PORT
-----
1 G1 1 G1N1 127.0.0.1 10110
1 G1 2 G1N2 127.0.0.1 10120
2 G2 3 G2N1 127.0.0.1 10210
2 G2 4 G2N2 127.0.0.1 10220
3 G3 5 G3N1 127.0.0.1 10310
3 G3 6 G3N2 127.0.0.1 10320
```

6 rows selected.

Performing DML

DML is sequentially performed by applying to a master server phase then applying to a slave server phase.

- Applying to a master server
 - It updates the data in the master server in each cluster group.
- Applying to a slave server
 - It updates the data in the slave server in the same way as they were applied in the master server in each cluster group.

In GOLDILOCKS, the following two methods are used to update data while synchronizing the master server and the slave server per each cluster group.

- **Data Update Using Generated Query**
- **Data Update Using Rowid (Rowid Pseudo Column)**

Data Update Using Generated Query

Data update using the generated query is a method to update records of each server by using the generated query. The generated query is internally generated by a server which was given a query from a user. It is supported only when the same result performed by a generated query from each server is guaranteed.

For more information, refer to **Generated Query**.

The generated query for a master server and the generated query for a slave server may be different each other depending on whether the updated record returns the result.

The data update using the generated query is performed as the figure below.

Figure 4 Updating data using generated query (Altering the entire cluster group)

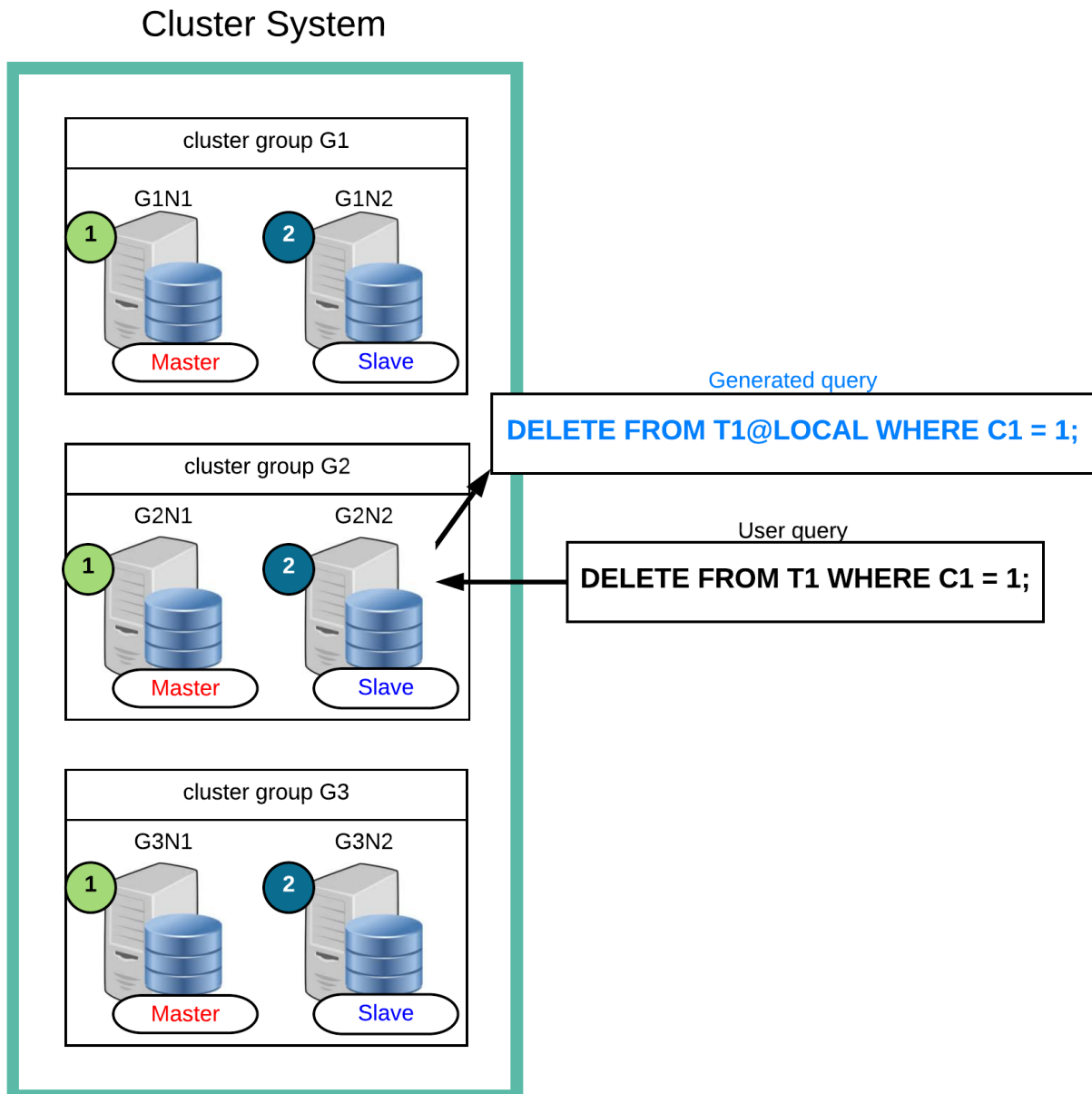

If there is not a condition to select an alteration target cluster group in a conditional clause as given above, then all cluster groups become the data update target by using the generated query.

The data update using the generated query is performed as follows.

1. The generated query is performed on each master server

- The generated query is performed on each slave server

If only a specific cluster group is selected as a data update target by a conditional clause, then it is performed as follows.

Figure 5 Updating data using generated query (Altering a specific cluster group)

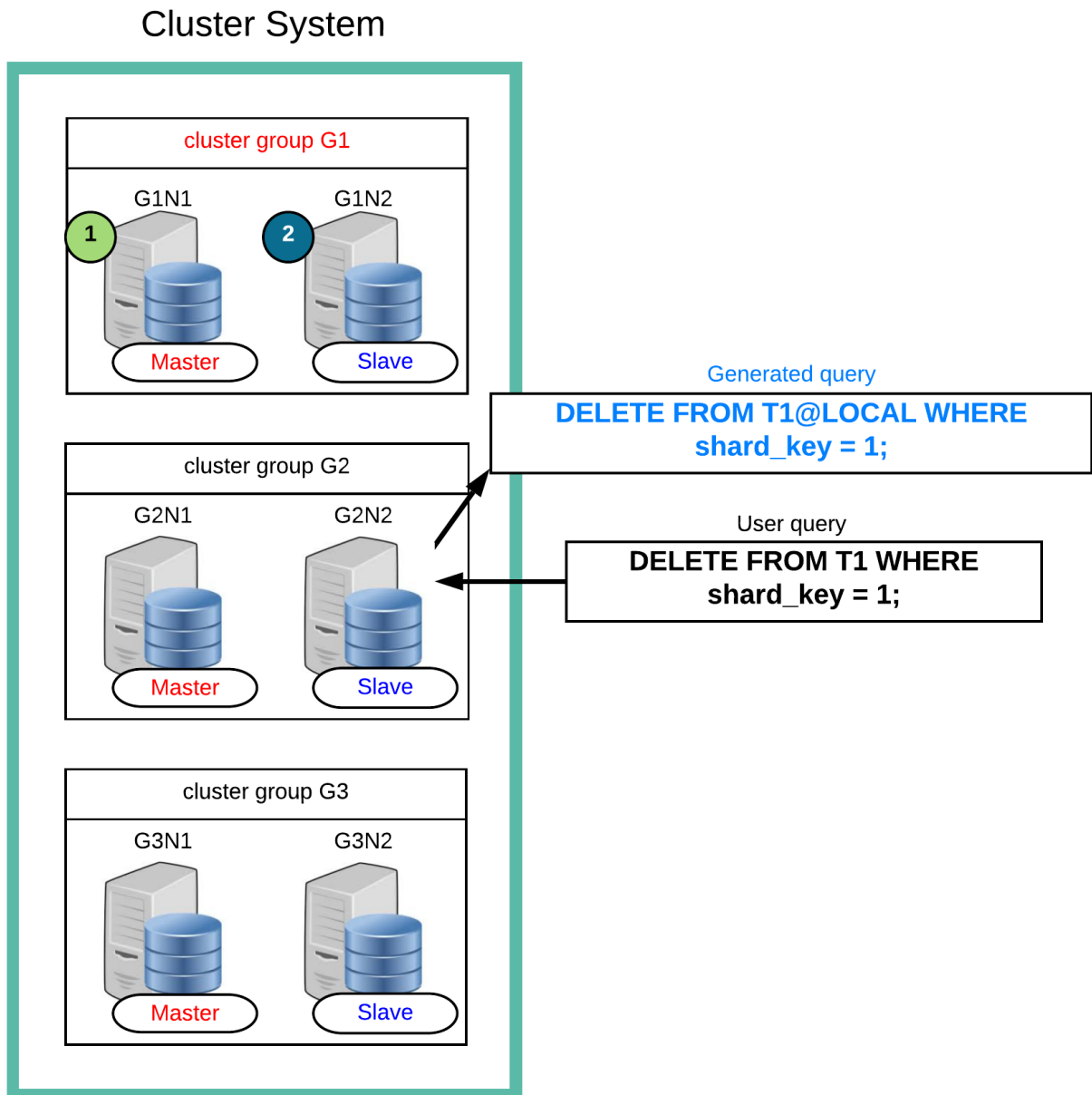

If the alteration target is determined by using the search condition (`shard_key = 1`) as given above, it is found that the record whose `shard_key` is 1 is in G1 cluster group by the sharding strategy. Therefore, only the record in G1 cluster group is deleted.

Updating the data in a specific cluster group is applied to a slave after it is applied to a master like as updating the data in the entire cluster group.

Data update using the generated query is supported only in the following cases.

- The generated query which guarantees the same result when performing the generated query on each cluster member of a cluster group can be generated.
 - This means that a deterministic statement or a function configures an unused generated query.
- Both of the data reference target server and the data update target server can be restricted to a same server when configuring the generated query.
 - This means that the server performing the generated query does not need to access another server while processing the query.

The following user queries support the data update using the generated query.

- **SELECT .. FOR UPDATE**
- **SELECT .. INTO .. FOR UPDATE**
- **DELETE FROM**
- **DELETE FROM name RETURNING**
- **DELETE FROM name RETURNING .. INTO**
- **UPDATE**
- **UPDATE name RETURNING**
- **UPDATE name RETURNING .. INTO**

The data update using the generated query is available even when the **14.6 Global Secondary Index** is not configured.

Data Update Using Rowid (Rowid Pseudo Column)

Data update using the rowid information is a method to update the same records stored in different cluster members by using the rowid. This method is used when adding a new record or when **Data Update Using Generated Query** is not available.

The rowid provided on a cluster environment is a logical identification information and it is a standard to determine whether the records are same. The rowid of all same records stored in different cluster members is same. Rowid information is provided when creating a record, or a new rowid information is provided when modifying the value of the sharding key column.

For more information about the rowid, refer to **ROWID Pseudo Column**.

Data update using the rowid information is divided into a rowid information collection phase and a data update phase. When updating two or more records, a rowid information collection phase and a data update phase are repeated per record.

- The rowid information collection phase
 - It collects the rowid information of records to be added or to be updated.
- The data update phase

- It updates records of a cluster group corresponding to the collected rowid.
- It sequentially updates records of a slave server after updating records of a master server.

Data update using the rowid information supports the following two methods depending on whether to use the **Global Secondary Index**.

- **Data Update Using Rowid Information without Global Secondary Index**
- **Data Update Using Rowid Information with Global Secondary Index**

Data Update Using Rowid Information without Global Secondary Index

Data update using the rowid information without the global secondary index is supported when the existing record is not updated like as INSERT.

Data update using the rowid information without the global secondary index is performed as follows.

Figure 6 Data update using the rowid information without the global secondary index

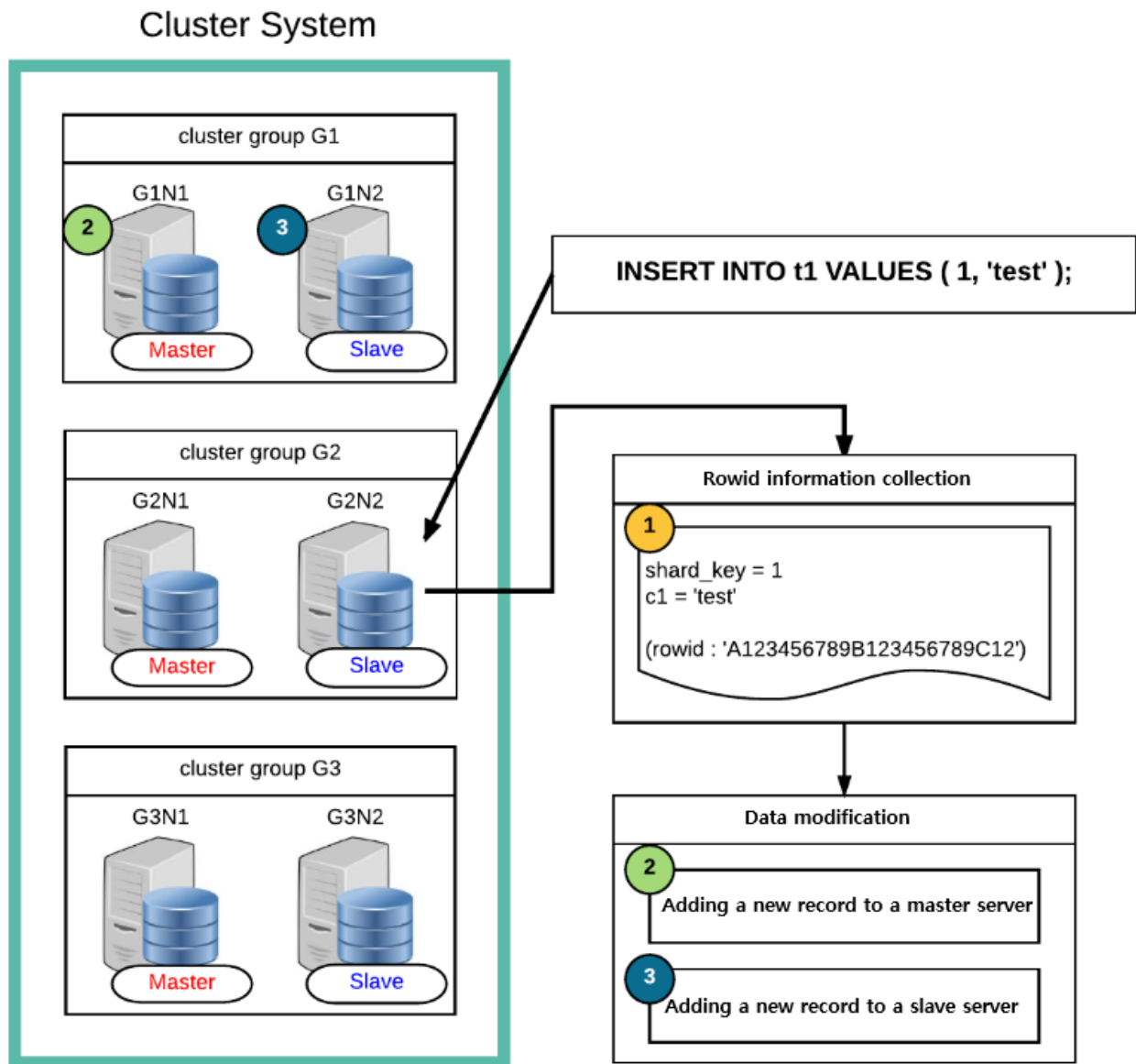

When adding a record, a rowid is provided to a new record and each record is stored at an appropriate position in a master server. All records are applied to a slave server after applying to a master server.

If the sharding key column is configured by using the value (`shard_key = 1`) as given above, it is found that the record whose `shard_key` is 1 is in G1 cluster group by the sharding strategy. Therefore, the record is added only to the G1 cluster group.

Data update using the rowid information without the global secondary index supports the following query types.

- `INSERT INTO`
- `INSERT INTO name RETURNING`
- `INSERT INTO name RETURNING .. INTO`

Data Update Using Rowid Information with Global Secondary Index

Data update using the rowid information with the global secondary index is supported when the existing record is updated.

To update the existing records, use the rowid information to guarantee the same update of the same data both in a master server and a slave server.

Data update using the rowid information with the global secondary index is performed as follows.

Figure 7 Data update using the rowid information with the global secondary index

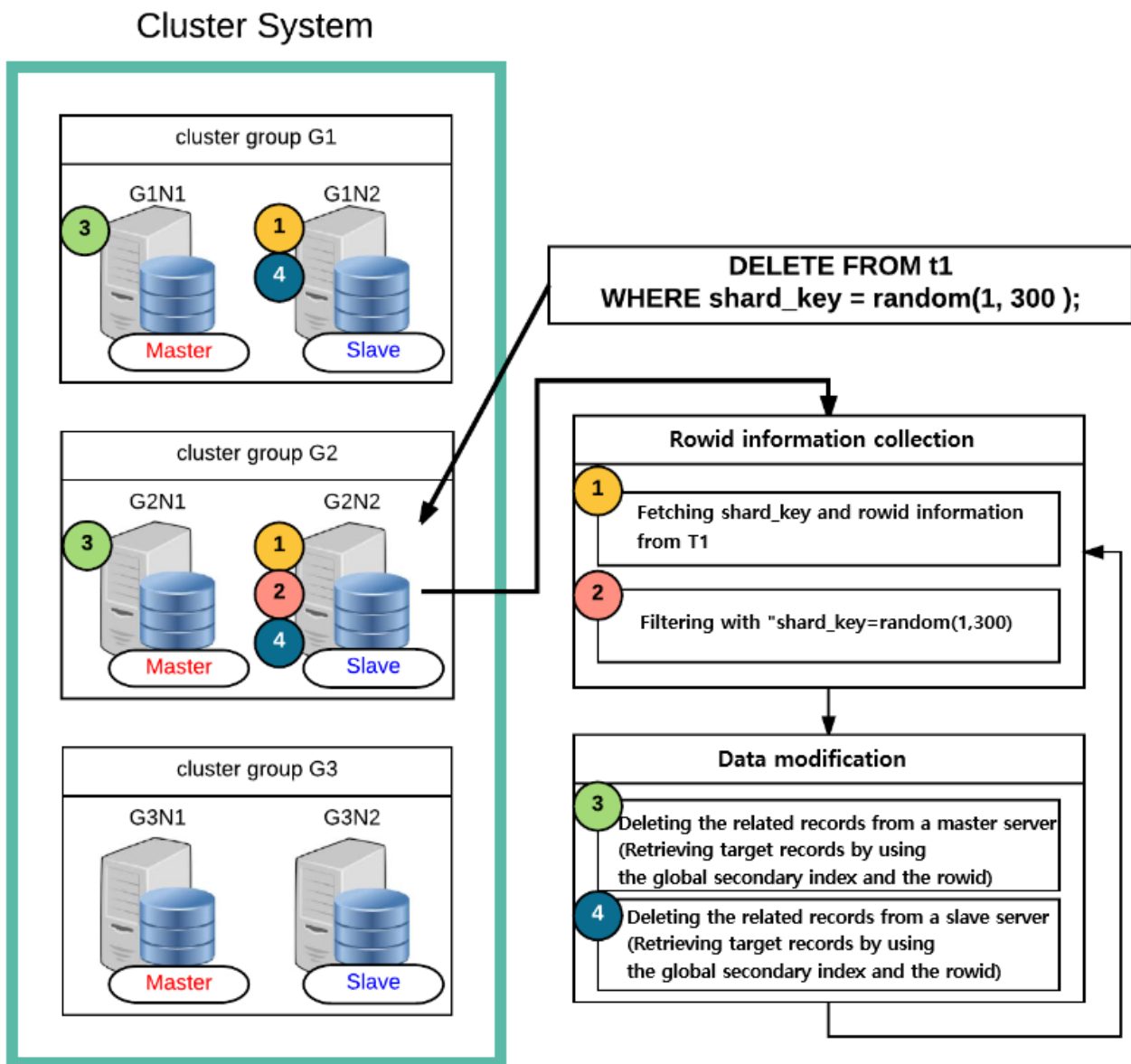

On the rowid information collection phase, the server received the user query collects the information of the target record to be updated. If the conditional clause whose result is updatable whenever it is evaluated, the server received the user query collects the rowid information and the column information being referenced from that conditional clause by using the condition excluding that conditional clause. The target

record to be updated is selected by filtering with a condition excluded before collecting the result.

On the data update phase, data in a master server and a slave server for a cluster group to which the records selected on the rowid information collection phase belong is sequentially updated. The `shard_key` is in the range from 1 to 300 by a condition ("`shard_key = random(1,300)`"), and it belongs to G1, G2 cluster group by the sharding strategy as the figure above. Therefore, only the records in G1, G2 cluster groups are deleted.

On the data update phase, the server which collected the rowid information, transfers it to a master server and a slave server, and requests the data modification. The servers received the request retrieve the target record and modify it by using the received rowid information and the existing global secondary index.

The rowid information collection phase and the data update phase are repeated until there is not any record to be updated.

The following cases require the identification among the records to be updated, and they are supported when data update using the generated query is not available.

- When using the non-deterministic expression
- When using the non-deterministic clause
- When unable to configure the generated query for the data update

The followings are query types supporting the data update using the rowid.

- **SELECT .. FOR UPDATE**
- **SELECT .. INTO .. FOR UPDATE**
- **DELETE FROM**
- **DELETE FROM name RETURNING**
- **DELETE FROM name RETURNING .. INTO**
- **DELETE FROM name WHERE CURRENT OF cursor_name**
- **UPDATE**
- **UPDATE name RETURNING**
- **UPDATE name RETURNING .. INTO**
- **UPDATE name WHERE CURRENT OF cursor_name**

When Using Non-deterministic Expression

The expression which can not guarantee the same result whenever performing the query described by using the expression is a non-deterministic expression.

If the generated query described by using the non-deterministic expression updates the data, then it can not guarantee that the query in a master server and the query in a slave server are updated same. Therefore, the data update using the rowid is supported when the non-deterministic expression is described.

- The non-deterministic expressions are as follows.

- Sequence
 - seq_name.currval, seq_name.nextval, next value for seq_name
 - currval(), nextval()
- The built-in function which should be evaluated in expression unit
 - random()
 - clock_date(), clock_time(), clock_timestamp(), clock_localtime(), clock_localtimestamp()
- psm
 - Schema level function

The following is an example of using the non-deterministic expression.

- Using the sequence

```
UPDATE t1 SET c1 = seq.nextval;
```

- The built-in function which should be evaluated in expression unit

```
DELETE FROM t1 WHERE c1 = random( 1, 100 );
```

- Schema level function

```
SELECT * FROM t1 WHERE shard_key = func( c1 );
```

When Using Non-deterministic Clause

The clause which can not guarantee the same result whenever performing the query described by using the clause is a non-deterministic clause.

If the generated query described by using the non-deterministic clause updates the data, then it can not guarantee that the query in a master server and the query in a slave server are updated same. Therefore, the data update using the rowid is supported when the non-deterministic clause is described.

The clause using **<offset limit clause>** is classified as a non-deterministic clause.

The following is an example of using the non-deterministic clause.

- Using the OFFSET clause

```
DELETE FROM t1 OFFSET 1;
```

- Using the LIMIT clause

```
UPDATE t1 SET c1 = c1 + 1 LIMIT 10;
```

When Unable to Configure Generated Query for the Data Update

The data update using the rowid is supported when unable to configure a generated query by using a data update query given by a user. For more information, refer to **Constraints of Generated Query Configuration**.

The following is an example of when unable to configure the generated query.

- Equi-join of tables with different sharding strategies each other

```
SELECT * FROM t1, t2 WHERE t1.shard_id = t2.shard_id FOR UPDATE;
```

- Accessing to another cluster group to retrieve the t2 record of a subquery while retrieving the t1 record belonging to a cluster group

```
DELETE FROM t1 WHERE t1.shard_id IN ( SELECT t2.shard_id FROM t2 );
```

13.

SQL Objects

This chapter describes the concepts and features of the following objects which configure the database.

- Authorization: User and privilege
- Schema
- Tablespace
- Table
- Index
- Sequence
- View
- Synonym
- Stored procedure
- Stored function

13.1 Database

Database-related Statements

For more information, refer to the followings.

- Starting up the database: **ALTER SYSTEM {MOUNT | OPEN} DATABASE**
- Backup and recovery
 - **ALTER DATABASE BACKUP**
 - **ALTER DATABASE DELETE BACKUP**
 - **ALTER DATABASE RECOVER**
 - **ALTER DATABASE REGISTER**
 - **ALTER DATABASE RESTORE**
- Creating, dropping, altering log files
 - **ALTER SYSTEM CHECKPOINT**
 - **ALTER SYSTEM SWITCH LOGFILE**
 - **ALTER DATABASE ARCHIVELOG**
 - **ALTER DATABASE ADD LOGFILE**
 - **ALTER DATABASE DROP LOGFILE**
 - **ALTER DATABASE RENAME LOGFILE**
- Comments on objects: **COMMENT ON name IS**
- System statistics information: **ANALYZE SYSTEM**

The information which is related to the database objects can be retrieved through the following views.

Table 13-1 Database object related information

Schema	View name	Description
DICTIONARY_SCHEMA	ALL_NONSCHEMA_COMMENTS	Comment information of user accessible non-schema objects
INFORMATION_SCHEMA	INFORMATION_SCHEMA_CATALOG_NAME	Database name information
	SQL_FEATURES	The SQL standard compatibility information of GOL DILOCKS
	SQL_IMPLEMENTATION_INFO	The SQL standard compatibility information of GOL DILOCKS
	SQL_PACKAGES	The SQL standard compatibility information of GOL

Schema	View name	Description
		DILOCKS
	SQL_PARTS	The SQL standard compatibility information of GOL DILOCKS
	SQL_SIZING	The SQL standard compatibility information of GOL DILOCKS

Database Configuration Objects

SQL Objects Which Configures Database

A database consists of multiple SQL objects.

SQL objects in database are classified as SQL schema objects and non-schema objects, depending on whether they are included in the SCHEMA.

Figure 1 SQL objects

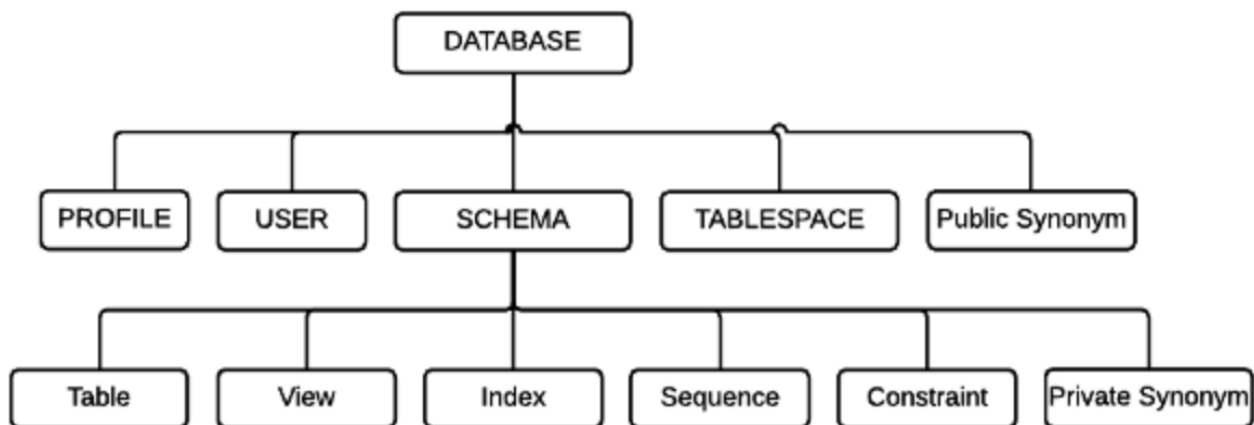

SQL schema objects are included in the SCHEMA, and they are as follows.

- TABLE: It is an object which stores the physical data, and it consists of columns and rows.
- VIEW: It is a logical object which provides a relation name for the query, and it is similar to a table.
- INDEX: It is an object to improve the query performance.
- SEQUENCE: It is an object to generate numbers.
- CONSTRAINT: It is an object to retain the integrity of tables.
- SYNONYM: It is an alias of TABLE, VIEW, SEQUENCE, and other synonym.
- STORED PROCEDURE: It is a persistent stored module in a procedure form.
- STORED FUNCTION: It is a persistent stored module in a function form.

SQL schema object can be used together with a schema name, or it can be used omitting a schema name. If schema name is omitted, the name is interpreted by the user's schema path.

The following is an example of when objects are created by specifying the schema name.

```
gSQL> CREATE TABLE my_schema.lineitem ( id INTEGER );
gSQL> CREATE INDEX my_schema.my_index ON my_schema.lineitem ( id );
```

Non-schema object is not included in the schema, and they are as follows.

- PROFILE: It is a password management policy.
- AUDIT POLICY: It is an audit policy.
- USER: It is a user.
- SCHEMA: It is the logical locations of the SQL schema objects.
- TABLESPACE: It is the physical spaces of the SQL schema objects.
- PUBLIC SYNONYM: It is an alias of TABLE, VIEW, SEQUENCE, and other synonym which does not have schema name

The SQL standard explicitly defines concepts and syntax for the SCHEMA objects. However, the concepts of USER and DATABASE are described only, and their syntaxes are not defined in SQL. The SQL standard does not deal with the TABLESPACE object. Namely, the SQL standard does not explicitly define the non-schema objects.

GOLDILOCKS defines USER, SCHEMA, TABLESPACE as separate descendant of a database. However, other DBMS vendors define the concepts of non-schema objects as follows.

- GOLDILOCKS
 - User and schema are separate objects.
 - User either does not have a schema, or has multiple schemas.
 - The relationship between user and schema is User : Schema = 1 : N.
- Oracle
 - User and schema is defined as similar concepts.
 - The relationship between user and schema is User : Schema = 1 : 1.
- DB2
 - User is not a descendant of DATABASE.
 - The relationship between user and schema is User : Schema = 1 : N.
- Postgres
 - User is not a descendant of DATABASE.
 - The relationship between user and schema is User : Schema = 1 : N.
- MySQL
 - User and schema is defined as similar concepts.
 - User is a descendant of DATABASE(SCHEMA).

Name Space of Objects

An object in the database has an identifiable name.

An SQL schema object has a unique name within a schema.

For example, the same lineitem table objects can be created in different schemas as follows.

```
gSQL> CREATE TABLE my_schema.lineitem ( id INTEGER );
gSQL> CREATE TABLE your_schema.lineitem ( name VARCHAR(128) );
```

SQL schema objects have the following name spaces in a single schema as follows.

- TABLE, VIEW, SEQUENCE, PRIVATE SYNONYM, STORED PROCEDURE, STORED FUNCTION
- INDEX
- CONSTRAINT

Table and view can not be created under the same name, but table and index can be created under the same name, as follows.

- Table and view can not be created under the same name.

```
gSQL> CREATE TABLE my_relation ( id INTEGER );
gSQL> CREATE VIEW my_relation ( name ) AS SELECT name FROM tmp_relation;
```

- Table and index can be created under the same name.

```
gSQL> CREATE TABLE my_object ( id INTEGER );
gSQL> CREATE INDEX my_object ON my_table ( name );
```

A non-schema object has an identifiable name within a database. Non-schema objects have the name spaces as follows.

- PROFILE
- AUDIT POLICY
- USER
- SCHEMA
- TABLESPACE

Namely, USERS can not be created under the same name, but USER and SCHEMA can be created under the same name.

- my_name USER object and my_name SCHEMA object are created.

```
gSQL> CREATE USER my_name IDENTIFIED BY my_name WITH SCHEMA my_name;
```

Built-in Objects

When creating database, GOLDILOCKS automatically creates objects such as user, schema, tablespace which are necessary for system operation.

Built-in User

When creating database, the following accounts are automatically created. The built-in accounts can not be removed except TEST user.

- `_SYSTEM` account
 - It is an account used by the internal system. When creating database, it is the owner of the built-in objects. When user creates an object, it becomes the grantor who grants the privilege to the object owner.
- `SYS` account
 - It is a user to manage the database.
- `TEST` account
 - It is a user for testing, and this object can be removed.
- `ADMIN` account
 - It is a role to manage the database.
- `SYSDBA` account
 - It is a role to start up/shut down the database.
- `PUBLIC` account
 - It is an account for all users. It is used to control the privileges for all users.

Built-in Schema

When creating database, the following schemas are automatically created. All built-in schemas can not be removed.

- `DEFINITION_SCHEMA`
 - It consists of the physical tables which store all objects information of the database.
- `FIXED_TABLE_SCHEMA`
 - It consists of the fixed tables which display the data structure information of system in a table form.
- `DICTIONARY_SCHEMA`
 - It consists of the user perspective views for querying object information of the database.

- INFORMATION_SCHEMA
 - It consists of the views defined in the SQL standard for querying the object information of the database.
- PERFORMANCE_VIEW_SCHEMA
 - It consists of the user perspective views for querying the state of the system.
- PUBLIC
 - It is the schema in which all users can create objects, and it differs from the PUBLIC account, which means all users.

Built-in Tablespace

When creating database, the following tablespaces are created automatically. All the built-in tablespaces can not be removed.

- DICTIONARY_TBS
 - It stores the dictionary tables to manage the SQL objects information.
- MEM_UNDO_TBS
 - It stores undo segments and transactions information.
- MEM_DATA_TBS
 - It is the first created data tablespace.
 - The user created tables are stored in data tablespace.
- MEM_TEMP_TBS
 - It is the first created temporary tablespace.
 - The temporary objects such as sort and hash which are created during query processing are stored in the temporary tablespace.
- MEM_AUX_TBS
 - It is a system auxiliary tablespace and it stores records which is automatically created such as an audit record.

Built-in Profile

When creating database, the "DEFAULT" profile is automatically created. Password parameter information of the "DEFAULT" profile is as follows.

Table 13-2 Configuration of DEFAULT profile

Parameter	Value
FAILED_LOGIN_ATTEMPTS	10
PASSWORD_LOCK_TIME	1
PASSWORD_LIFE_TIME	180
PASSWORD_GRACE_TIME	7
PASSWORD_REUSE_MAX	UNLIMITED

Parameter	Value
PASSWORD_REUSE_TIME	UNLIMITED
PASSWORD_VERIFY_FUNCTION	NULL

The followings are characteristics of the default values of "DEFAULT" profile.

- Account lockout
 - An account is locked for one day (PASSWORD_LOCK_TIME) after consecutive 10(FAILED_LOGIN_ATTEMPTS) times of failed login attempts.
- Password expiration
 - After 180 days (PASSWORD_LIFE_TIME) has elapsed, the password expires after seven days of grace period (PASSWORD_GRACE_TIME).
- Password reusable
 - The old password can be reused.
- Password complexity verification
 - The password complexity is not verified.

13.2 Profile

Profile-related Statements

For more information, refer to the followings.

- Creating a profile: **CREATE PROFILE**.
- Dropping a profile: **DROP PROFILE**.
- Altering a profile: **ALTER PROFILE**.
- Assigning a profile to the user: **CREATE USER, ALTER USER**
- Clearing a password history: **ALTER DATABASE CLEAR PASSWORD HISTORY**.

Table 13-3 Profile object related information

Schema	View	Description
DICTIONARY_SCHEMA	DBA_PROFILES	All profile information
	DBA_USERS	User profile information

Concepts of Profile

GOLDILOCKS performs user authentication for database security. The password management policy is required because the user authentication password is vulnerable to theft, forgery and misuse.

Profile includes information such as this password management policy. DBA or security managers assign the profile to a user, and apply the password management policy which is appropriate to the corresponding user.

Creating, Altering, Allocating Profile

A profile is created by using CREATE PROFILE statement.

```
CREATE PROFILE profile1 LIMIT
    FAILED_LOGIN_ATTEMPTS    10
    PASSWORD_LOCK_TIME       1
    PASSWORD_LIFE_TIME       180
    PASSWORD_GRACE_TIME      7
    PASSWORD_REUSE_MAX       UNLIMITED
    PASSWORD_REUSE_TIME      UNLIMITED
```

```
PASSWORD_VERIFY_FUNCTION NULL;
```

A profile is allocated by using CREATE USER, ALTER USER statements.

```
CREATE USER u1 IDENTIFIED BY u1 PROFILE profile1;
ALTER USER u2 PROFILE profile1;
```

The profile parameters are updated by using ALTER PROFILE statement.

```
ALTER PROFILE profile1 LIMIT
    PASSWORD_REUSE_MAX          3
    PASSWORD_REUSE_TIME        30;
```

If a profile is not allocated to a user, the user is not restricted on creating and using the password.

If the created profile or a DEFAULT profile is allocated to a user, the user complies with the profile's password policies when creating and using the password.

Setting Password of DEFAULT Profile

When the default profile is assigned to a user, the password is managed as follows.

Table 13-4 DEFAULT profile of password

Parameter	Default setting	Description
FAILED_LOGIN_ATTEMPS	10	The allowed number of consecutive login failure The account is locked after consecutive 10 times login attempt failures.
PASSWORD_LOCK_TIME	1	The account lockout duration If the consecutive login failures exceed the allowable value, the account is locked for one day.
PASSWORD_LIFE_TIME	180	The password life time The password is expired after 180 days.
PASSWORD_GRACE_TIME	7	The duration to change the password when the the password is expired. The password should be changed within seven days after first login since the password is expired. If a user does not change the password within the period, the user can not log in using the password.
PASSWORD_REUSE_MAX	UNLIMITED	The number of times of which passwords are not reusable. PASSWORD_REUSE_MAX should be set together with PASSWORD_REUSE_TIME. If both of the two values are UNLIMITED, the password can always be reused.
PASSWORD_REUSE_TIME	UNLIMITED	The duration which the password can not be reused.

Account Lockout

If the number of consecutive login attempt failures exceed the number of times specified in `FAILED_LOGIN_ATTEMPTS`, the account is locked during the period specified in `PASSWORD_LOCK_TIME`.

```
CREATE PROFILE profile1 LIMIT
    FAILED_LOGIN_ATTEMPTS    10
    PASSWORD_LOCK_TIME       1;
ALTER USER u1 PROFILE profile1;
```

When a user `u1`'s login attempts consecutively fails more than 10 times, the account is locked for one day. And after one day the account is automatically unlocked.

If the `PASSWORD_LOCK_TIME` value is not specified, it is regarded as the value which is specified in `PASSWORD_LIFE_TIME` of `DEFAULT` profile.

If the `PASSWORD_LOCK_TIME` value is `UNLIMITED` the locked accounts is not automatically released. Therefore, the following statement should be executed to unlock the account.

```
ALTER USER u1 ACCOUNT UNLOCK;
```

If login is successful, the number of failed login attempt is initialized to zero.

A security manager can explicitly lock the user accounts. In this case, the user accounts can not be automatically released so the security manager should unlock the user accounts.

```
ALTER USER u1 ACCOUNT LOCK;
ALTER USER u1 ACCOUNT UNLOCK;
```

Password Lifetime

`PASSWORD_LIFE_TIME` specifies the life time the password. After the life time, the password is expired. A user, DBA or security manager should change the password after a password is expired.

```
CREATE PROFILE profile1 LIMIT
    PASSWORD_LIFE_TIME       180
    PASSWORD_GRACE_TIME      7;
ALTER USER u1 PROFILE profile1;
```

The grace period starts since when the user `u1` has tried to log in for the first time after 180 days.

During seven days of the grace period, the user is reminded to enter a new password whenever accessing the account, until he changes the password.

If seven days of the grace period passed and the password is not changed, the user can not login until entering a new password.

A password can be expired by using CREATE USER or ALTER USER statements.

```
ALTER USER u1 PASSWORD EXPIRE;
```

When the password is expired, the error (ERR-28000(16312) the password has expired) occurs whenever logging in as follows, then a new password should be entered.

```
% gsql u1 u1
ERR-28000(16312): the password has expired
Changing password for u1
New password:
Retype new password:
Connected to GOLDILOCKS Database.
gSQL>
```

Reusing Password

The password can be reused after it is changed as many times as the specified value in PASSWORD_REUSE_MAX. Also, it should be after the specified time in PASSWORD_REUSE_TIME.

```
CREATE PROFILE profile1 LIMIT
    PASSWORD_REUSE_MAX          2
    PASSWORD_REUSE_TIME         1;
ALTER USER u1 PROFILE profile1;
```

The user u1 can reuse the current password after the password has been changed for two times, and 10 days elapsed.

```
ALTER USER u1 IDENTIFIED BY u1 REPLACE u1;
ALTER USER u1 IDENTIFIED BY u1 REPLACE u1
*
ERROR at line 1:
ORA-28007: the password cannot be reused
ALTER USER u1 IDENTIFIED BY u2 REPLACE u1;
User altered.
ALTER USER u1 IDENTIFIED BY u3 REPLACE u2;
User altered.
```

- 10 days elapsed.

```
ALTER USER u1 IDENTIFIED BY u1 REPLACE u3;
```

User altered.

The both conditions should be satisfied to reuse the old password. If only one of the value in PASSWORD_REUSE_MAX and PASSWORD_REUSE_TIME is UNLIMITED, the password can not be reused. If both of values are UNLIMITED, the password can always be reused.

Table 13-5 Password reuse

PASSWORD_REUSE_MAX	PASSWORD_REUSE_TIME	Password reusability
Integer value	Integer value	If both of the conditions are satisfied, it can be reused.
Integer value	UNLIMITED	It can not be reused.
UNLIMITED	Integer value	It can not be reused.
UNLIMITED	UNLIMITED	It can always be reused.

Password Complexity Verification

Password complexity verification checks if the password is complex enough to protect against breaking in to the system.

GOLDILOCKS supports the method of password complexity verification as follows.

Table 13-6 Password complexity verification

Method	Description
KISA_VERIFY_FUNCTION	<ul style="list-style-type: none"> 8 or more characters 1 or more letters 1 or more numbers 1 or more special characters
ORA12C_VERIFY_FUNCTION	<ul style="list-style-type: none"> 8 or more characters 1 or more letters 1 or more numbers Database name should not be included. Username or the reversed username should not be included. <i>goldilocks</i> should not be included. <i>oracle</i> should not be included. The following simple password can not be used. <ul style="list-style-type: none"> welcome1, database1, account1, user1234, password1, oracle123, computer1, abcdefg1, change_on_intall The new password should be different at least 3 characters from the old password.
	<ul style="list-style-type: none"> 9 or more characters 2 or more uppercases

Method	Description
ORA12C_STRONG_VERIFY_FUNCTION	<ul style="list-style-type: none"> • 2 or more lowercases • 2 or more numbers • 2 or more special characters • The new password should be different at least 4 characters from the old password.
VERIFY_FUNCTION_11G	<ul style="list-style-type: none"> • 8 or more characters • 1 or more letters • 1 or more numbers • Username should not be included. • The new password should be different at least 3 characters from the old password.
VERIFY_FUNCTION	<ul style="list-style-type: none"> • It should not be same as the username. • 4 or more characters • 1 or more letters • 1 or more numbers • 1 or more special characters • The following simple password can not be used. <ul style="list-style-type: none"> ◦ welcome, database, account, user, password, oracle, computer, abcd • The new password should be different at least 3 characters from the old password.

For more information about profile and user setting, refer to **CREATE PROFILE** , **CREATE USER** .

13.3 Audit Policy

Audit Policy-related Statement

For more information, refer to the followings.

- Creating audit policy: **CREATE AUDIT POLICY**
- Dropping audit policy: **DROP AUDIT POLICY**
- Altering audit policy: **ALTER AUDIT POLICY**
- Activating audit policy: **AUDIT POLICY**
- Deactivating audit policy: **NOAUDIT POLICY**
- Dropping audit trail: **ALTER DATABASE CLEAR AUDIT TRAIL**

Table 13-7 Audit policy object information

Schema	View	Description
DICTIONARY_SCHEMA	AUDIT_POLICIES	Information about all audit policies
	AUDIT_POLICY_OPTIONS	Information about audit policy option
	AUDIT_POLICY_ENABLED	Information about activating audit policy

Examples

AUDIT SYSTEM ON DATABASE privilege is required to perform the followings.

Creating Audit Policy

Perform **CREATE AUDIT POLICY** statement to create an audit policy object.

The following is an example of creating an audit_t1_dml object to audit the DML for a u1.t1 table.

```
CREATE AUDIT POLICY audit_t1_dml
  ACTIONS INSERT ON u1.t1
        , DELETE ON u1.t1
        , UPDATE ON u1.t1
;
```

Audit policy created.

Enquire the information about audit policy options by using **AUDIT_POLICY_OPTIONS** view.

```

SELECT policy_name
       , audit_option
       , object_schema
       , object_name
FROM   audit_policy_options
WHERE  policy_name = 'AUDIT_T1_DML'
ORDER BY audit_option
;
POLICY_NAME  AUDIT_OPTION  OBJECT_SCHEMA  OBJECT_NAME
-----
AUDIT_T1_DML DELETE        U1             T1
AUDIT_T1_DML INSERT         U1             T1
AUDIT_T1_DML UPDATE         U1             T1
3 rows selected.

```

Activating Audit Policy

Use **AUDIT POLICY** statement to activate the audit policy.

The following is an example of activating an audit policy to leave an audit record when a user except for u1, sys succeeded to perform DML for u1.t1 table.

```

AUDIT POLICY audit_t1_dml
  EXCEPT u1, sys
  WHENEVER SUCCESSFUL
;

```

The activated audit policy is applied to the newly created session, but it does not affect the existing sessions.

View the information about activated audit policy by using **AUDIT_POLICY_ENABLED**.

```

SELECT policy_name
       , enabled_opt
       , user_name
       , when_success
       , when_failure
FROM   audit_policy_enabled
WHERE  policy_name = 'AUDIT_T1_DML'
ORDER BY user_name
;
POLICY_NAME          ENABLED_OPT          USER_NAME  WHEN_SUCCESS  WHEN_FAILURE

```

```

-----
AUDIT_T1_DML      EXCEPT          SYS      YES      NO
AUDIT_T1_DML      EXCEPT          U1       YES      NO
2 rows selected.

```

After the audit policy is activated, the corresponding actions create audit records.

The following is an example of when u2 user successfully performs SQL statements.

```

SELECT COUNT(*) FROM u1.t1;
INSERT INTO u1.t1 VALUES ( 1 );
UPDATE u1.t1 SET id = id + 1 WHERE id = 1;
DELETE u1.t1 WHERE id = 2;
COMMIT;

```

In the example above, INSERT, UPDATE, DELETE are target actions of an audit, so it creates audit records, but SELECT and COMMIT are not a target action of an audit, so it does not create audit records.

Viewing Audit Trail

SELECT ON DICTIONARY_SCHEMA.AUDIT_TRAIL privilege for AUDIT_TRAIL view is required to view audit records.

The following is an example of viewing an audit trail created by an audit_t1_dml audit policy.

```

SELECT policy_name
       , logon_username
       , action_name
       , object_schema
       , object_name
       , sql_text
FROM audit_trail
WHERE policy_name = 'AUDIT_T1_DML'
;
POLICY_NAME  LOGON_USERNAME ACTION_NAME  OBJECT_SCHEMA OBJECT_NAME  SQL_TEXT
-----
-----
AUDIT_T1_DML U2              INSERT      U1           T1           INSERT INTO u1.t1 VALUES ( 1
)
AUDIT_T1_DML U2              UPDATE      U1           T1           UPDATE u1.t1 SET c1 = c1 + 1
WHERE c1 = 1
AUDIT_T1_DML U2              DELETE      U1           T1           DELETE u1.t1 WHERE c1 = 2
3 rows selected.

```

Dropping Audit Trail

When an audit policy is activated, the size of an audit trail keeps increasing. Execute the following statement to drop the audit trail.

```
ALTER DATABASE CLEAR AUDIT TRAIL;
```

Store it in the user table and drop it as follows to store the audit trail.

- Creating a user table

```
CREATE TABLE my_audit_trail  
AS SELECT *  
FROM audit_trail  
WITH NO DATA;
```

- Storing it in a user table, then dropping it.

```
INSERT INTO my_audit_trail SELECT * FROM audit_trail;  
ALTER DATABASE CLEAR AUDIT TRAIL;
```

Create and manage the view as follows to view both the stored audit trail and the current audit_trail.

```
CREATE VIEW unified_audit_trail  
AS  
SELECT * FROM my_audit_trail  
UNION ALL  
SELECT * FROM dictionary_schema.audit_trail  
;
```

Deactivating Audit Policy

Deactivate the audit policy by using the following statement.

```
NOAUDIT POLICY audit_t1_dml;
```

Deactivating audit policy affects the newly created session, but it does not affect the activated information about existing sessions.

Dropping Audit Policy

Execute the following statement to drop the audit policy object.

```
DROP AUDIT POLICY audit_t1_dml;
```

The audit policy object should be deactivated to be dropped, and dropping the object does not affect the existing sessions.

Concepts of Audit Policy

Audit Trail

Viewing Audit Trail

Audit record can be viewed by using `DICTIONARY_SCHEMA.AUDIT_TRAIL` view.

`SELECT` privilege is required to view `AUDIT_TRAIL` view.

```
GRANT SELECT ON DICTIONARY_SCHEMA.AUDIT_TRAIL TO user_name;
```

`AUDIT_TRAIL` view has the following information.

Table 13-8 Column information

Information	Column name	Description
Session information	MEMBER_NAME	Cluster member name
	SESSION_ID	Session identifier
	SESSION_SERIAL	Session serial number
	LOGON_USERNAME	Logon user name of the user whose actions were audited
	CURRENT_USERNAME	Effective user for the statement execution
	SERVER_PROCESS	Server process identifier for the session
Peer client information	CLIENT_PROGRAM_NAME	Client program used for session
	CLIENT_USERNAME	Client operating system user name for the session
	CLIENT_PROCESS	Client process identifier for the session
	CLIENT_HOST	Client host ip address for the session
	CLIENT_PORT	Client port number for the session
	CLIENT_TERMINAL	Client terminal name for the session
	TRANSACTION_ID	Transaction identifier
	SCN	System change number (SCN) string of the query at the time of the event

Information	Column name	Description
SQL information	GCN	Global change number (GCN) of the query at the time of the event
	DCN	Domain change number (DCN) of the query at the time of the event
	LCN	Local change number (LCN) of the query at the time of the event
	STMT_NO	Numeric number for each statement run in a session
	SQL_TEXT	SQL associated with the event
	SQL_BINDS	List of bind variables, if any, associated with SQL_TEXT
	RETURN_CODE	Error code generated by the action, zero if the action succeeded
	ERROR_MESSAGE	Error message generated by the action, null if the action succeeded
Event information	ENTRY_ID	Audit trail entry identifier in the session
	EVENT_TIMESTAMP	Timestamp of the creation of the audit trail entry in local time zone
	POLICY_NAME	Audit policy name that caused the current audit record
	PRIVILEGE_USED	Database privilege used to execute the action
	ACTION_NAME	Action name executed by the user
	OBJECT_TYPE	Object type of object affected by the action
	OBJECT_SCHEMA	Schema name of object affected by the action
	OBJECT_NAME	Object name of object affected by the action

Storing Audit Trail

AUDIT_TRAIL view consists of the following tables.

- AUDIT_TRAIL_SESSION
 - It records a record per a session.
 - Session information
 - Peer client information
- AUDIT_TRAIL_SQL
 - It records a record per SQL.
 - SQL information
- AUDIT_TRAIL_EVENT
 - It records a record per an audit option.
 - Audit event information

Audit records configuring an audit trail is divided into multiple tables then stored.

The schema of the tables is DEFINITION_SCHEMA, and it is stored in MEM_AUX_TBS tablespace.

- DEFINITION_SCHEMA
 - It is a schema storing dictionary tables.
- MEM_AUX_TBS
 - System auxiliary tablespace
 - It is a tablespace to store a record which automatically created by the database.
 - It is managed by a separate tablespace not to affect the service management by an automatically

created record.

Creating Audit Record

If an audit policy is activated, it creates an audit record when the corresponding action occurs. It creates one or more audit records when multiple corresponding actions occur.

- If similar audit options are listed as follows, it creates a single audit record.
 - Defining an audit policy

```
CREATE AUDIT POLICY p1
  PRIVILEGES INSERT ANY TABLE
  ACTIONS INSERT;
AUDIT POLICY p1;
```

- Performing an audit action

```
INSERT INTO other_user.t1 VALUES ( 1 );
```

- If different audit options are listed as follows, it creates two audit records.
 - Defining an audit policy

```
CREATE AUDIT POLICY p1
  ACTIONS SELECT ON u1.t1
           , SELECT ON u1.t2;
AUDIT POLICY p1;
```

- Performing an audit action

```
SELECT COUNT(*) FROM u1.t1 A, u1.t2 B WHERE A.id = B.id;
```

- If multiple audit policies are activated in the identical action as follows, it creates two audit records.
 - Defining an audit policy

```
CREATE AUDIT POLICY p1
  PRIVILEGES INSERT ANY TABLE;
AUDIT POLICY p1;
CREATE AUDIT POLICY p2
  ACTIONS INSERT;
AUDIT POLICY p2;
```

- Performing an audit action

```
INSERT INTO other.t1 VALUES (1);
```

Dropping Audit Trail (purge)

Execute the following statement to drop the audit trail.

```
ALTER DATABASE CLEAR AUDIT TRAIL;
```

Create a user table and store old audit record in it as follows.

```
CREATE TABLE my_audit_trail AS SELECT * FROM audit_trail WITH NO DATA;
```

Then, regularly store it by using INSERT .. SELECT statement before dropping the audit trail.

```
INSERT INTO my_audit_trail SELECT * FROM audit_trail;  
ALTER DATABASE CLEAR AUDIT TRAIL;
```

Execute DELETE statement by using EVENT_TIMESTAMP column to store the audit record of the specified period.

```
INSERT INTO my_audit_trail SELECT * FROM audit_trail;  
DELETE FROM my_audit_trail WHERE event_timestamp < ADD_MONTHS( sysdate, -3 );  
ALTER DATABASE CLEAR AUDIT TRAIL;
```

View the old audit record and the current audit record together by creating a view as follows.

```
CREATE VIEW audit_trail_view  
AS SELECT * FROM dictionary_schema.audit_trail  
UNION ALL  
SELECT * FROM my_audit_trail;  
SELECT * FROM audit_trail_view;
```

Configuring Audit Policy

Audit policy may include the following options.

- Privilege auditing
 - It audits SQL performance by using the database privilege.
- Object action auditing
 - It audits SQL performance for the specific object.
- System action auditing

- It audits SQL performance for all objects.

Multiple audit options can be managed by creating multiple audit policies, but it is recommended to manage multiple audit options by creating a small number of audit policies.

The activated audit policy information is constructed as a session information at logon time, so the less the number of audit policies, the less the load becomes.

Moreover, if multiple audit policies are activated, then it determines whether to create an audit record for an SQL statement, so a load creating multiple audit records may occur.

Audit policy information constructed in a session at logon time is not affected by dropping, altering, activating or deactivating an audit policy.

Altering an audit policy is applied only to a newly logon session.

Privilege Auditing

Privilege auditing is set to audit when SQL statement is successfully performed by using the database privilege.

It does not create an audit record which is based on the privilege auditing about sys user (the database owner).

The database privilege which can be listed for the privilege auditing can be viewed through **V\$AUDITABLE_DB_PRIVILEGES** view.

```
SELECT privilege_name FROM v$auditable_db_privileges;
PRIVILEGE_NAME
-----
ADMINISTRATION
ALTER DATABASE
ALTER SYSTEM
ACCESS CONTROL
CREATE USER
ALTER USER
DROP USER
CREATE TABLESPACE
ALTER TABLESPACE
DROP TABLESPACE
USAGE TABLESPACE
CREATE SCHEMA
DROP SCHEMA
ANALYZE ANY
CREATE ANY TABLE
```

```
ALTER ANY TABLE
DROP ANY TABLE
SELECT ANY TABLE
INSERT ANY TABLE
DELETE ANY TABLE
UPDATE ANY TABLE
LOCK ANY TABLE
CREATE ANY VIEW
DROP ANY VIEW
CREATE ANY SEQUENCE
ALTER ANY SEQUENCE
DROP ANY SEQUENCE
USAGE ANY SEQUENCE
CREATE ANY INDEX
ALTER ANY INDEX
DROP ANY INDEX
CREATE ANY SYNONYM
DROP ANY SYNONYM
CREATE PUBLIC SYNONYM
DROP PUBLIC SYNONYM
CREATE PROFILE
ALTER PROFILE
DROP PROFILE
CREATE ANY PROCEDURE
ALTER ANY PROCEDURE
DROP ANY PROCEDURE
EXECUTE ANY PROCEDURE
AUDIT SYSTEM
43 rows selected.
```

The following is an example of when a user u1 who has SELECT ANY TABLE privilege activates an audit policy for the privilege auditing.

```
CREATE AUDIT POLICY p1
    PRIVILEGES SELECT ANY TABLE;
AUDIT POLICY p1;
```

Whether the audit record is created when a user u1 performs the following two statements is as follows.

- SELECT * FROM u1.t1
 - It does not use SELECT ANY TABLE privilege because it is an owner of the object.
 - An audit record does not exist.

- `SELECT * FROM other.t1`
 - It succeeds with `SELECT ANY TABLE` privilege even though it does not have `SELECT ON other.t1` privilege.
 - It creates an audit record.

Use `AUDIT_POLICY_OPTIONS` view to view the privilege auditing information as follows.

```
SELECT audit_option
       , audit_option_type
       , object_schema
       , object_name
FROM audit_policy_options
WHERE policy_name = 'P1'
;
AUDIT_OPTION      AUDIT_OPTION_TYPE  OBJECT_SCHEMA      OBJECT_NAME
-----
SELECT ANY TABLE DATABASE PRIVILEGE null              null
```

Auditing Object Action

It audits SQL which is performed for a specific object.

Actions to be audited per each object type are as follows.

Table 13-9 Audit action per object type

Object type	Actions
Table	ALTER, COMMENT, DELETE, GRANT, INDEX, INSERT, LOCK, RENAME, SELECT, UPDATE
View	ALTER, COMMENT, GRANT, SELECT
Sequence	ALTER, COMMENT, GRANT, SELECT
Stored function/ procedure	ALTER, COMMENT, EXECUTE, GRANT

Create the audit policy as follows to audit DML for table `u1.t1`.

```
CREATE AUDIT POLICY audit_t1_dml
  ACTIONS INSERT ON u1.t1
         , DELETE ON u1.t1
         , UPDATE ON u1.t1
;
```

Execute `AUDIT_POLICY_OPTIONS` view as follows to view the information about object action auditing.

```

SELECT audit_option
       , audit_option_type
       , object_schema
       , object_name
FROM   audit_policy_options
WHERE  policy_name = 'AUDIT_T1_DML'
ORDER BY audit_option
;

```

AUDIT_OPTION	AUDIT_OPTION_TYPE	OBJECT_SCHEMA	OBJECT_NAME
DELETE	OBJECT ACTION	U1	T1
INSERT	OBJECT ACTION	U1	T1
UPDATE	OBJECT ACTION	U1	T1

3 rows selected.

ALL option such as ALL ON schema.object means all audit actions which can be defined for the corresponding object.

The following is an example of using ALL option together with other options.

```

CREATE AUDIT POLICY p1
      ACTIONS ALL ON u1.seq1
           , ALTER ON u1.seq1
;

```

Audit policy created.

```

SELECT audit_option
       , audit_option_type
       , object_schema
       , object_name
FROM   audit_policy_options
WHERE  policy_name = 'P1'
ORDER BY audit_option
;

```

AUDIT_OPTION	AUDIT_OPTION_TYPE	OBJECT_SCHEMA	OBJECT_NAME
ALL	OBJECT ACTION	U1	SEQ1
ALTER	OBJECT ACTION	U1	SEQ1

2 rows selected.

When dropping ALL option as follows, not every audit options are dropped, but only ALL option is dropped.

```

ALTER AUDIT POLICY p1
    DROP ACTIONS ALL ON u1.seq1;
Audit Policy altered.
SELECT audit_option
       , audit_option_type
       , object_schema
       , object_name
  FROM audit_policy_options
 WHERE policy_name = 'P1'
 ORDER BY audit_option;
AUDIT_OPTION AUDIT_OPTION_TYPE OBJECT_SCHEMA OBJECT_NAME
-----
ALTER        OBJECT ACTION      U1          SEQ1
1 row selected.

```

Auditing success or failure of EXECUTE a stored function or a stored procedure is determined based only on whether it is executable at the time of the execution.

- WHENEVER NOT SUCCESSFUL creates an audit record when it can not performs a stored function/ procedure.
- WHENEVER SUCCESSFUL creates an audit record even when an error occurs while performing an SQL statement in a stored function/ procedure.
- If an auditing the failure of an SQL statement in a stored function/ procedure, then that SQL statement should be included in an auditing target.

The following is an example of executing SELECT statement including a stored function.

```

SELECT others.func1( t1.c1 )
  FROM t1;

```

It corresponds to WHENEVER NOT SUCCESSFUL when it fails to call others.func1() due to an error such as a lack of privilege. It corresponds to WHENEVER SUCCESSFUL even though an error occurs while executing an SQL statement in a stored function when it succeeds to call others.func1().

Auditing System Action

It audits an SQL statement regardless of a specific object.

A valid system action enquires V\$AUDITABLE_SYSTEM_ACTIONS.

```

SELECT action_name FROM v$auditable_system_actions;
ACTION_NAME
-----
ALL

```

DDL
SELECT
INSERT
UPDATE
DELETE
EXECUTE
CREATE TABLE
DROP TABLE
ALTER TABLE
LOCK TABLE
TRUNCATE TABLE
ANALYZE TABLE
RENAME
CREATE INDEX
DROP INDEX
ALTER INDEX
CREATE SEQUENCE
DROP SEQUENCE
ALTER SEQUENCE
GRANT
REVOKE
CREATE SYNONYM
DROP SYNONYM
CREATE VIEW
DROP VIEW
ALTER VIEW
CREATE PROCEDURE
DROP PROCEDURE
ALTER PROCEDURE
CREATE FUNCTION
DROP FUNCTION
ALTER FUNCTION
COMMENT
ALTER DATABASE
CREATE PROFILE
DROP PROFILE
ALTER PROFILE
CREATE TABLESPACE
DROP TABLESPACE
ALTER TABLESPACE
CREATE USER

```

DROP USER
ALTER USER
CHANGE PASSWORD
CREATE SCHEMA
DROP SCHEMA
CREATE AUDIT POLICY
DROP AUDIT POLICY
ALTER AUDIT POLICY
AUDIT
NOAUDIT
ALTER SYSTEM
ALTER SESSION
ANALYZE SYSTEM
COMMIT
ROLLBACK
SAVEPOINT
LOGON
LOGOFF
SET SESSION
SET TRANSACTION
SET CONSTRAINTS
CREATE CLUSTER GROUP
DROP CLUSTER GROUP
ALTER CLUSTER GROUP
CREATE CLUSTER LOCATION
DROP CLUSTER LOCATION
ALTER CLUSTER LOCATION
69 rows selected.

```

A system action name corresponding to each SQL statement is viewed by executing `V$SQL_COMMAND_VIEW`.

```

SELECT command, audit_action FROM v$sql_command;
COMMAND                                AUDIT_ACTION
-----
ALTER AUDIT POLICY                      ALTER AUDIT POLICY
ALTER CLUSTER GROUP .. ADD CLUSTER MEMBER  ALTER CLUSTER GROUP
ALTER CLUSTER GROUP .. OFFLINE CLUSTER MEMBER  ALTER CLUSTER GROUP
ALTER DATABASE DROP INACTIVE CLUSTER MEMBERS  ALTER DATABASE
ALTER DATABASE OFFLINE INACTIVE CLUSTER MEMBERS  ALTER DATABASE
... Ellipsis ...

```

```

UPDATE
UPDATE .. RETURNING query
UPDATE .. RETURNING .. INTO
UPDATE .. WHERE CURRENT OF cursor
CREATE CLUSTER LOCATION
ALTER CLUSTER LOCATION
DROP CLUSTER LOCATION
170 rows selected.
UPDATE
UPDATE
UPDATE
UPDATE
CREATE CLUSTER LOCATION
ALTER CLUSTER LOCATION
DROP CLUSTER LOCATION

```

The following is an example of creating an audit policy including a system action, and enquiring an audit option.

```

CREATE AUDIT POLICY p1
  ACTIONS SELECT
    , DROP TABLE
    , DROP USER
;
Audit Policy created.
SELECT audit_option
  , audit_option_type
  , object_schema
  , object_name
FROM audit_policy_options
WHERE policy_name = 'P1'
ORDER BY audit_option
;
AUDIT_OPTION AUDIT_OPTION_TYPE OBJECT_SCHEMA OBJECT_NAME
-----
DROP TABLE   SYSTEM ACTION      null      null
DROP USER     SYSTEM ACTION      null      null
SELECT        SYSTEM ACTION      null      null
3 rows selected.

```

Useful Audit Policy

The following is an example of defining a useful audit policy.

- Auditing a logon failure

```

CREATE AUDIT POLICY AUDIT_LOGON_FAILURES
  ACTIONS LOGON
;

```

```
AUDIT POLICY AUDIT_LOGON_FAILURES
    WHENEVER NOT SUCCESSFUL
;
```

- Auditing a Data Definition Language (DDL) performance

```
CREATE AUDIT POLICY AUDIT_DDL
    ACTIONS DDL
;
AUDIT POLICY AUDIT_DDL
    WHENEVER SUCCESSFUL
;
```

- Auditing a parameter alteration

```
CREATE AUDIT POLICY AUDIT_DATABASE_PARAMETER
    ACTIONS ALTER DATABASE
        , ALTER SYSTEM
;
AUDIT POLICY AUDIT_DATABASE_PARAMETER
    WHENEVER SUCCESSFUL
;
```

- Auditing an account alteration

```
CREATE AUDIT POLICY AUDIT_ACCOUNT_MGMT
    ACTIONS CREATE USER
        , DROP USER
        , ALTER USER
        , CHANGE PASSWORD
        , GRANT
        , REVOKE
;
AUDIT POLICY AUDIT_ACCOUNT_MGMT
;
```

- Auditing the recommendations of Center for Internet Security (CIS)

```
CREATE AUDIT POLICY AUDIT_CIS_RECOMMENDATIONS
    PRIVILEGES ALTER SYSTEM
        , ALTER DATABASE
    ACTIONS CREATE USER
```

```

, DROP USER
, ALTER USER
, CHANGE PASSWORD
, GRANT
, REVOKE
, CREATE PROFILE
, ALTER PROFILE
, DROP PROFILE
, CREATE SYNONYM
, DROP SYNONYM
, CREATE PROCEDURE
, DROP PROCEDURE
, ALTER PROCEDURE
;
AUDIT POLICY AUDIT_CIS_RECOMMENDATIONS
    WHENEVER SUCCESSFUL
;

```

Operating Audit Policy

Activating Audit Policy

An audit policy object does not start auditing until it is activated.

An audit policy object should be activated by using AUDIT POLICY statement as follows to perform auditing.

```

CREATE AUDIT POLICY audit_t1_dml
    ACTIONS INSERT ON u1.t1
        , DELETE ON u1.t1
        , UPDATE ON u1.t1
;
Audit policy created.
AUDIT POLICY audit_t1_dml;
Audit succeeded.

```

When activating an audit policy, it audits new sessions only, but it does not affect the existing sessions.

When activating an audit policy by using AUDIT POLICY statement, it can specify a user which will audit using BY clause or EXCEPT clause, or it may audit success/ failure of an audit action by using WHENEVER clause.

- BY | EXCEPT
 - BY user_list: It specifies a user to audit.
 - EXCEPT user_list: It audits all users except for specified users.
 - When it is omitted, it audits all users.
- WHENEVER
 - WHENEVER SUCCESSFUL: It creates an audit record when an audit action succeeds.
 - WHENEVER NOT SUCCESSFUL: It creates an audit record when an audit action fails.
 - When it is omitted, it creates an audit record regardless of a success/ failure of an audit action.

The information about activated audit policy can be viewed by executing AUDIT_POLICY_ENABLED view.

```
SELECT policy_name
       , enabled_opt
       , user_name
       , when_success
       , when_failure
FROM   audit_policy_enabled
WHERE  policy_name = 'AUDIT_T1_DML'
;
POLICY_NAME  ENABLED_OPT  USER_NAME  WHEN_SUCCESS  WHEN_FAILURE
-----
AUDIT_T1_DML BY          ALL USERS  YES           YES
```

If the auditing target user is omitted as the example above, it outputs ALL USERS meaning all users.

Note the followings when using BY clause and EXCEPT clause.

- BY clause and EXCEPT clause can not be used together for the same audit policy.

```
AUDIT POLICY audit_t1_dml BY u1;
Audit succeeded.
AUDIT POLICY audit_t1_dml EXCEPT u2;
ERR-42000(16475): audit policy already applied with the BY clause
```

- If multiple AUDIT POLICY BY clauses are used in the same audit policy, it is activated for the user sets. In other words, the following examples have the same meaning.
 - Example 1

```
AUDIT POLICY audit_t1_dml BY u1;
Audit succeeded.
AUDIT POLICY audit_t1_dml BY u2;
Audit succeeded.
```

```

SELECT policy_name
       , enabled_opt
       , user_name
       , when_success
       , when_failure
FROM   audit_policy_enabled
WHERE  policy_name = 'AUDIT_T1_DML'
;
POLICY_NAME  ENABLED_OPT  USER_NAME  WHEN_SUCCESS  WHEN_FAILURE
-----
AUDIT_T1_DML BY          U1          YES           YES
AUDIT_T1_DML BY          U2          YES           YES
2 rows selected.

```

- Example 2

```

AUDIT POLICY audit_t1_dml BY u1, u2;
Audit succeeded.
SELECT policy_name
       , enabled_opt
       , user_name
       , when_success
       , when_failure
FROM   audit_policy_enabled
WHERE  policy_name = 'AUDIT_T1_DML'
;
POLICY_NAME  ENABLED_OPT  USER_NAME  WHEN_SUCCESS  WHEN_FAILURE
-----
AUDIT_T1_DML BY          U1          YES           YES
AUDIT_T1_DML BY          U2          YES           YES
2 rows selected.

```

- If multiple AUDIT POLICY EXCEPT clauses are used in the same audit policy, only the last AUDIT POLICY statement is valid. In other words, the following examples have different meanings.

- Example 1

```

AUDIT POLICY audit_t1_dml EXCEPT u1;
Audit succeeded.
AUDIT POLICY audit_t1_dml EXCEPT u2;
Audit succeeded.
SELECT policy_name

```

```

, enabled_opt
, user_name
, when_success
, when_failure
FROM audit_policy_enabled
WHERE policy_name = 'AUDIT_T1_DML'
;

```

POLICY_NAME	ENABLED_OPT	USER_NAME	WHEN_SUCCESS	WHEN_FAILURE
AUDIT_T1_DML	EXCEPT	U2	YES	YES

1 row selected.

- Example 2

```

AUDIT POLICY audit_t1_dml EXCEPT u1, u2;
Audit succeeded.
SELECT policy_name
, enabled_opt
, user_name
, when_success
, when_failure
FROM audit_policy_enabled
WHERE policy_name = 'AUDIT_T1_DML'
;

```

POLICY_NAME	ENABLED_OPT	USER_NAME	WHEN_SUCCESS	WHEN_FAILURE
AUDIT_T1_DML	EXCEPT	U1	YES	YES
AUDIT_T1_DML	EXCEPT	U2	YES	YES

2 rows selected.

- WHENEVER clause which is used together with BY clause is accumulated. In other words, the following examples have the same meaning.

- Example 1

```

AUDIT POLICY audit_t1_dml BY u1 WHENEVER SUCCESSFUL;
Audit succeeded.
SELECT policy_name
, enabled_opt
, user_name
, when_success
, when_failure

```

```

FROM audit_policy_enabled
WHERE policy_name = 'AUDIT_T1_DML'
;
POLICY_NAME  ENABLED_OPT  USER_NAME  WHEN_SUCCESS  WHEN_FAILURE
-----
AUDIT_T1_DML BY          U1          YES          NO
1 row selected.
AUDIT POLICY audit_t1_dml BY u1 WHENEVER NOT SUCCESSFUL;
Audit succeeded.
SELECT policy_name
      , enabled_opt
      , user_name
      , when_success
      , when_failure
FROM audit_policy_enabled
WHERE policy_name = 'AUDIT_T1_DML'
;
POLICY_NAME  ENABLED_OPT  USER_NAME  WHEN_SUCCESS  WHEN_FAILURE
-----
AUDIT_T1_DML BY          U1          YES          YES
1 row selected.

```

- Example 2

```

AUDIT POLICY audit_t1_dml BY u1;
Audit succeeded.
SELECT policy_name
      , enabled_opt
      , user_name
      , when_success
      , when_failure
FROM audit_policy_enabled
WHERE policy_name = 'AUDIT_T1_DML'
;
POLICY_NAME  ENABLED_OPT  USER_NAME  WHEN_SUCCESS  WHEN_FAILURE
-----
AUDIT_T1_DML BY          U1          YES          YES
1 row selected.

```

- If WHENEVER clause is used together with EXCEPT clause, then only the last part of it is valid. In other words, the following examples have different meanings.

- Example 1

```
AUDIT POLICY audit_t1_dml EXCEPT u1 WHENEVER SUCCESSFUL;
Audit succeeded.
AUDIT POLICY audit_t1_dml EXCEPT u1 WHENEVER NOT SUCCESSFUL;
Audit succeeded.
SELECT policy_name
       , enabled_opt
       , user_name
       , when_success
       , when_failure
FROM audit_policy_enabled
WHERE policy_name = 'AUDIT_T1_DML'
;
POLICY_NAME  ENABLED_OPT  USER_NAME  WHEN_SUCCESS  WHEN_FAILURE
-----
AUDIT_T1_DML EXCEPT      U1         NO          YES
1 row selected.
```

- Example 2

```
AUDIT POLICY audit_t1_dml EXCEPT u1;
Audit succeeded.
SELECT policy_name
       , enabled_opt
       , user_name
       , when_success
       , when_failure
FROM audit_policy_enabled
WHERE policy_name = 'AUDIT_T1_DML'
;
POLICY_NAME  ENABLED_OPT  USER_NAME  WHEN_SUCCESS  WHEN_FAILURE
-----
AUDIT_T1_DML EXCEPT      U1         YES         YES
1 row selected.
```

Deactivating Audit Policy

NOAUDIT POLICY statement should be executed to deactivate an audit policy.

NOAUDIT POLICY statement is applied only to a new session, and it does not affect to the existing session.

If all information is set to be deactivated by using the query below, then an audit policy is completely deactivated.

```
SELECT policy_name
       , enabled_opt
       , user_name
       , when_success
       , when_failure
FROM   audit_policy_enabled
WHERE  policy_name = 'AUDIT_T1_DML'
;
no rows selected.
```

NOAUDIT POLICY statement deletes each activated information which is created according to the specified AUDIT POLICY method.

The following is an example of deactivating only the auditing for u1 user of audit_t1_dml.

```
SELECT policy_name
       , enabled_opt
       , user_name
       , when_success
       , when_failure
FROM   audit_policy_enabled
WHERE  policy_name = 'AUDIT_T1_DML'
;
POLICY_NAME  ENABLED_OPT  USER_NAME  WHEN_SUCCESS  WHEN_FAILURE
-----
AUDIT_T1_DML BY          U1         YES           YES
AUDIT_T1_DML BY          SYS        YES           YES
2 rows selected.
NOAUDIT POLICY audit_t1_dml BY u1;
Noaudit succeeded.
SELECT policy_name
       , enabled_opt
       , user_name
       , when_success
       , when_failure
FROM   audit_policy_enabled
WHERE  policy_name = 'AUDIT_T1_DML'
;
POLICY_NAME  ENABLED_OPT  USER_NAME  WHEN_SUCCESS  WHEN_FAILURE
```

```
-----
AUDIT_T1_DML BY          SYS          YES          YES
```

1 row selected.

If AUDIT POLICY name BY clause is used it should be deactivated by using NOAUDIT POLICY name BY statement. If AUDIT POLICY name EXCEPT clause is used it should be deactivated by using NOAUDIT POLICY name statement without BY clause.

NOAUDIT POLICY statement should be used according to the usage as follows to deactivate each option of AUDIT POLICY statement.

Table 13-10 Activating/ deactivating audit policy

Type	AUDIT POLICY statement	NOAUDIT POLICY statement
All users	AUDIT POLICY p1	NOAUDIT POLICY p1
Using BY	AUDIT POLICY p1 BY u1	NOAUDIT POLICY p1 BY u1
Using EXCEPT	AUDIT POLICY p1 EXCEPT u1	NOAUDIT POLICY p1

If all users are activated as follows, NOAUDIT POLICY BY clause does not affect anything.

```
AUDIT POLICY audit_t1_dml;
Audit succeeded.
SELECT policy_name
       , enabled_opt
       , user_name
       , when_success
       , when_failure
FROM audit_policy_enabled
WHERE policy_name = 'AUDIT_T1_DML'
;
POLICY_NAME  ENABLED_OPT  USER_NAME  WHEN_SUCCESS  WHEN_FAILURE
-----
AUDIT_T1_DML BY          ALL USERS  YES          YES
1 row selected.
NOAUDIT POLICY audit_t1_dml BY u1;
Noaudit succeeded.
SELECT policy_name
       , enabled_opt
       , user_name
       , when_success
       , when_failure
FROM audit_policy_enabled
WHERE policy_name = 'AUDIT_T1_DML'
```

```

;
POLICY_NAME  ENABLED_OPT  USER_NAME  WHEN_SUCCESS  WHEN_FAILURE
-----
AUDIT_T1_DML BY          ALL USERS  YES           YES
1 row selected.

```

If one or more users are separately activated, NOAUDIT POLICY statement should be used according to the AUDIT POLICY configuration.

- When it is activated by using BY clause
 - The following is an example of activating by using BY clause.

```

AUDIT POLICY p1 WHENEVER NOT SUCCESSFUL;
AUDIT POLICY p1 BY u1;
AUDIT POLICY p1 BY u2;

```

- The information about activating is viewed as follows.

```

SELECT policy_name
       , enabled_opt
       , user_name
       , when_success
       , when_failure
FROM   audit_policy_enabled
WHERE  policy_name = 'P1';
POLICY_NAME  ENABLED_OPT  USER_NAME  WHEN_SUCCESS  WHEN_FAILURE
-----
P1           BY          ALL USERS  NO            YES
P1           BY          U1         YES           YES
P1           BY          U2         YES           YES
3 rows selected.

```

- The following is the information about activating when NOAUDIT statement is performed.

```

NOAUDIT POLICY p1;
Noaudit succeeded.
SELECT policy_name
       , enabled_opt
       , user_name
       , when_success
       , when_failure

```

```

FROM audit_policy_enabled
WHERE policy_name = 'P1';
POLICY_NAME ENABLED_OPT USER_NAME WHEN_SUCCESS WHEN_FAILURE
-----
P1          BY          U1          YES          YES
P1          BY          U2          YES          YES
2 rows selected.

```

In the example above, the auditing for ALL USERS is deactivated, but the auditing for user u1 and u2 are still activated.

If NOAUDIT POLICY statement is used again by using BY option as follows, then it completely deactivate the audit policy p1.

```

NOAUDIT POLICY p1 BY u1, u2;
Noaudit succeeded.
SELECT policy_name
       , enabled_opt
       , user_name
       , when_success
       , when_failure
FROM audit_policy_enabled
WHERE policy_name = 'P1';
no rows selected.

```

- When it is activated by using EXCEPT
 - The following is an example of activating by using the audit policy.

```
AUDIT POLICY p1 EXCEPT u1, sys;
```

- The information about activating is viewed as follows.

```

SELECT policy_name
       , enabled_opt
       , user_name
       , when_success
       , when_failure
FROM audit_policy_enabled
WHERE policy_name = 'P1';
POLICY_NAME ENABLED_OPT USER_NAME WHEN_SUCCESS WHEN_FAILURE
-----
P1          EXCEPT    U1          YES          YES

```

```
P1          EXCEPT    SYS          YES          YES
```

```
2 rows selected.
```

- Unlike AUDIT POLICY statement, NOAUDIT POLICY statement does not have an EXCEPT option, and it executes the statement without an option as follows.

```
NOAUDIT POLICY p1;
Noaudit succeeded.
SELECT policy_name
       , enabled_opt
       , user_name
       , when_success
       , when_failure
FROM   audit_policy_enabled
WHERE  policy_name = 'P1';
no rows selected.
```

In other words, if an audit policy is activated by using an EXCEPT option, then a separate user can not be re activated by using NOAUDIT POLICY statement.

13.4 Authorization

Authorization-related Statements

For more information, refer to the followings.

- Creating a user: **CREATE USER**
- Dropping a user: **DROP USER**
- Altering a user: **ALTER USER**

- Granting privileges: **GRANT privileges TO**
- Revoking privileges: **REVOKE privileges FROM**

Information related to a user object and the authorization can be retrieved through the following views.

Table 13-11 Authorization objects related information

Schema	View	Description
	ALL_COL_PRIVS	Privileges for the user-accessible column
	ALL_COL_PRIVS_MADE	Privileges for the column whose user is the grantor
	ALL_COL_PRIVS_RECD	Privileges for the column whose user is the grantee
	ALL_DB_PRIVS	DB privileges which is related to a user
	ALL_DB_PRIVS_MADE	Privileges for the DB whose user is the grantor
	ALL_DB_PRIVS_RECD	Privileges for the DB whose user is the grantee
	ALL_PROC_PRIVS	Stored procedure/function privileges which is related to a user
	ALL_PROC_PRIVS_MADE	Privileges for the stored procedure/function whose user is the grantor
	ALL_PROC_PRIVS_RECD	Privileges for the stored procedure/function whose user is the grantee
	ALL_SCHEMA_PRIVS	Privileges for the user-accessible schema
	ALL_SCHEMA_PRIVS_MADE	Privileges for the schema whose user is the grantor
	ALL_SCHEMA_PRIVS_RECD	Privileges for the schema whose user is the grantee
	ALL_SEQ_PRIVS	Privileges for the user-accessible sequence
	ALL_SEQ_PRIVS_MADE	Privileges for the sequence whose user is the grantor
	ALL_SEQ_PRIVS_RECD	Privileges for the sequence whose user is the grantee
	ALL_TAB_PRIVS	Privileges for the user-accessible table
	ALL_TAB_PRIVS_MADE	Privileges for the table whose user is the grantor
	ALL_TAB_PRIVS_RECD	Privileges for the table whose user is the grantee
	ALL_TBS_PRIVS	Privileges for the user-accessible tablespace

Schema	View	Description
DICTIONARY_SCHEMA	ALL_TBS_PRIVS_MADE	Privileges for the tablespace whose user is the grantor
	ALL_TBS_PRIVS_RECD	Privileges for the tablespace whose user is the grantee
	ALL_USERS	Information about the user-accessible user
	USER_COL_PRIVS	Privilege information about the user owned column
	USER_COL_PRIVS_MADE	Information of granting privileges about the user owned column
	USER_COL_PRIVS_RECD	Information of acquiring privilege about the user owned column
	USER_PROC_PRIVS	Privilege information about the user owned stored procedure/function
	USER_PROC_PRIVS_MADE	Information of granting privileges about the user owned stored procedure/function
	USER_PROC_PRIVS_RECD	Information of acquiring privilege about the user owned stored procedure/function
	USER_SCHEMA_PRIVS	Privilege information about the user owned schema
	USER_SCHEMA_PRIVS_MADE	Information of granting privileges about the user owned schema
	USER_SCHEMA_PRIVS_RECD	Information of acquiring privilege about the user owned schema
	USER_SEQ_PRIVS	Privilege information about the user owned sequence
	USER_SEQ_PRIVS_MADE	Information of granting privileges about the user owned sequence
	USER_SEQ_PRIVS_RECD	Information of acquiring privilege about the user owned sequence
	USER_TAB_PRIVS	Privileges information about the user owned table
	USER_TAB_PRIVS_MADE	Information of granting privileges about the user owned table
	USER_TAB_PRIVS_RECD	Information of acquiring privilege about the user owned table
	USER_USERS	Information about the current user
INFORMATION_SCHEMA	COLUMN_PRIVILEGES	Privilege information of user-accessible column
	ROUTINE_PRIVILEGES	Privilege information of user-accessible stored procedure/function
	TABLE_PRIVILEGES	Privilege information of user-accessible table
	USAGE_PRIVILEGES	Privilege information of user-accessible sequence

Concepts of User

A user object consists of the user's execution privilege set. The user should have the appropriate privilege to execute the SQL statements for the corresponding object.

For example, the user which is created by using **CREATE USER** statement is an object without any privileges. The user can not access the database nor does it execute any SQL statement. For access, the user should have **CREATE SESSION ON DATABASE** privilege which allows creating sessions in database object. The appropriate privilege should be granted after executing **CREATE USER** statement as follows.

```
CREATE USER u1 IDENTIFIED BY u1_password;  
GRANT CREATE SESSION ON DATABASE TO u1;  
COMMIT;
```

For more information about granting privilege after creating user object, refer to **Examples in CREATE USER and GRANT privileges TO**.

Creating Objects and Privileges

Creating SQL Schema Object

When creating an SQL schema object such as a table, the user should have the privileges for the superordinate non-schema object to which the table belongs in order to execute **CREATE TABLE** statements.

The following is an example of **CREATE TABLE** statements.

```
CREATE TABLE t1 ( id BIGINT, name VARCHAR(128) );
```

When it is interpreted as follows,

```
CREATE TABLE u1.t1 ( id BIGINT, name VARCHAR(128) ) TABLESPACE mem_data_tbs;
```

In the figure below, the owner of the table t1 is the account u1 who is the owner of the schema u1. The schema u1 is the logical location which includes the table, and the table space mem_data_tbs is the physical storage which stores the table.

Figure 2 CREATE TABLE and non-schema objects

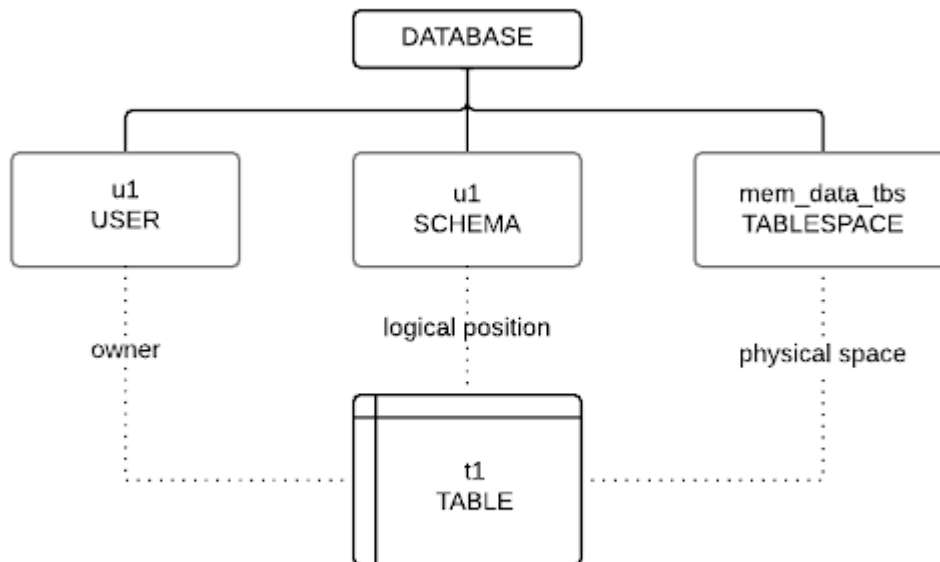

In this case, the user u1 who performed the statement needs the following privileges for the schema and tablespace to which the table t1 will belong.

One of the following privileges is required to create the table which will be stored on its logical location (schema u1).

- Privilege to create the table on the schema u1
 - CREATE TABLE ON SCHEMA ON u1
- Privilege to create any table on the database
 - CREATE ANY TABLE ON DATABASE
 - A table can be created when having privileges for the database which is superordinate object of the schema u1 even without the schema privilege.

One of the following privileges is required to create a table in tablespace mem_data_tbs which is the physical storage space of tables.

- Privilege to create an object on the tablespace mem_data_tbs
 - CREATE OBJECT ON TABLESPACE mem_data_tbs
- Privilege to use all tablespaces in the database
 - USAGE TABLESPACE ON DATABASE
 - A table can be created when having privileges for the database which is the superordinate object of mem_data_tbs tablespace even without the tablespace privilege.

The owner of the table object is determined as follows.

- The owner of the schema to which the table belongs
- If the owner of the schema to which the table belongs is PUBLIC, then it is the user who executed the statement.

The owner of the table object has the following privileges to change the table structure and manipulate data in the table.

- SELECT ON TABLE
 - The privilege to execute SELECT statement on the table
- INSERT ON TABLE
 - The privilege to execute INSERT statement on the table
- UPDATE ON TABLE
 - The privilege to execute UPDATE statement on the table
- DELETE ON TABLE
 - The privilege to execute DELETE statement on the table
- LOCK ON TABLE
 - The privilege to execute LOCK statement on the table
- INDEX ON TABLE
 - The privilege to execute CREATE/DROP/ALTER INDEX statement on the table
- ALTER ON TABLE
 - The privilege to execute ALTER TABLE statement on the table

The grantor of the given privilege is the `_SYSTEM` account which is internally used, and the grantee is the table owner. Therefore, any user including `SYS` account is not allowed to remove or change the owner privilege using **REVOKE privileges FROM**. The table owner's privileges are also removed when the table is removed.

Creating Non-schema Object

Like as creating the SQL schema object such as a table, the appropriate privileges for the database (a superordinate object) are required to create the non-schema objects such as user, schema, tablespace.

A user who executes the following statements should have the following privileges for the database object (a superordinate object) per each statement.

- CREATE USER statement
 - CREATE USER ON DATABASE
 - The privilege to execute CREATE USER statement on the database
- CREATE TABLESPACE statement
 - CREATE TABLESPACE ON DATABASE
 - The privilege to execute CREATE TABLESPACE statement on the database

- CREATE SCHEMA statement
 - CREATE SCHEMA ON DATABASE
 - The privilege to execute CREATE SCHEMA statement on the database
- CREATE PUBLIC SYNONYM statement
 - The privilege to execute CREATE PUBLIC SYNONYM statement on the database

Unlike creating the SQL schema object, the user who performed CREATE statement is not the owner of non-schema object. Each object has the following characteristics.

- User object
 - There is not an owner.
 - DROP USER ON DATABASE privilege is required to drop a user object.
- Tablespace object
 - There is not an owner.
 - DROP TABLESPACE ON DATABASE privilege is required to drop a tablespace object.
- Schema object
 - It is an owner which is specified in the CREATE SCHEMA statement.
 - The schema object owner can drop it.
- Public synonym object
 - There is not an owner.
 - DROP PUBLIC SYNONYM ON DATABASE privilege is required to drop a public synonym object.

Privileges

Granting Privileges

To INSERT, DELETE, UPDATE, or SELECT data when the user is not the owner of SQL schema object such as table, then the user should be granted the appropriate privileges by using **GRANT privileges TO** statement.

For example, a user who is not the owner of the table requires one of the following privileges to execute SELECT statement. As the figure below, the user can query the u1.t1 table if the user has SELECT privileges on the superordinate object u1 schema or the database even when the user does not have SELECT privilege on table t1.

- The test user executes the following.

```
SELECT id, name FROM u1.t1 WHERE id < 100;
```

Figure 3 Privilege to execute SELECT statement

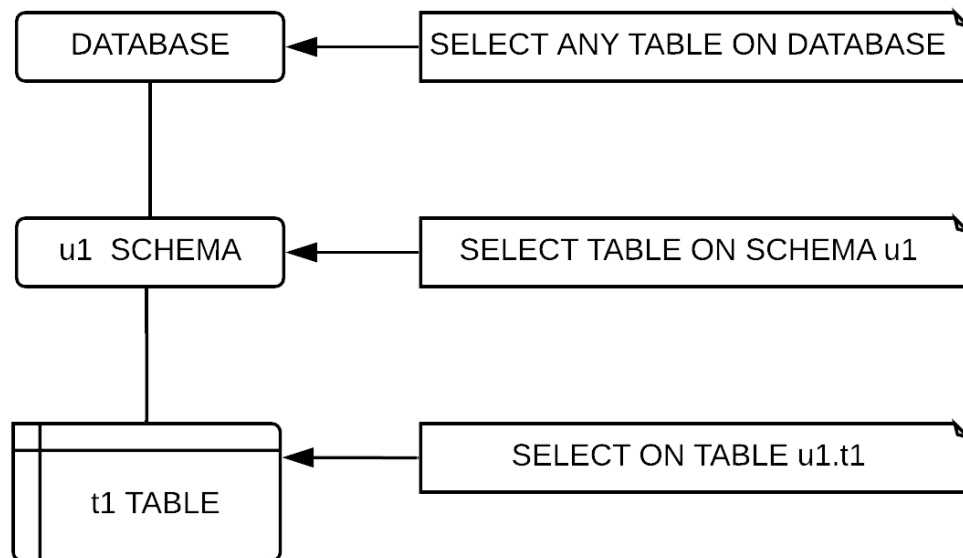

- SELECT ON TABLE u1.t1
 - SELECT privilege for the table u1.t1
- SELECT ON SCHEMA u1
 - SELECT privilege for the schema u1 which is the superordinate object
 - SELECT privilege for all tables of the schema u1
- SELECT ANY TABLE ON DATABASE
 - SELECT privilege for the database which is the second superordinate object
 - SELECT privilege for all tables of the database

The user who executed the GRANT statement should be one of the followings to grant the SELECT ON TABLE u1.t1 privileges to another user.

- Owner of the object u1.t1
 - The object owner has the privilege of SELECT ON TABLE u1.t1 WITH GRANT OPTION granted by the _SYSTEM account.
- User with SELECT ON TABLE u1.t1 WITH GRANT OPTION
 - WITH GRANT OPTION enables the grantee to grant the granted privileges to another user.
- User with the privilege of ACCESS CONTROL ON DATABASE
 - The user can control all privileges on all objects.

The following is an example that the object owner grants privileges to another user.

- The owner of the table u1.t1 executes GRANT statement.

```
GRANT SELECT ON TABLE u1.t1 TO test;
```

For more information about the privilege types, refer to **GRANT privileges TO**.

For more information about privileges executing each SQL statements, refer to the *Invocation and Access Rule* of each statement in **SQL References**.

Revoking Privileges

The granted privileges are revoked from a user by using **REVOKE privileges FROM**. The privileges of the object's owner can no be revoked until the object is removed.

For example, a user who can execute REVOKE statement to revoke the SELECT privilege from the test user are as follows. The user can not revoke privileges which were not granted by the user even when the user is the owner of the table.

```
REVOKE SELECT ON TABLE u1.t1 FROM test;
```

- User who grants privileges
 - The user grants the privilege of SELECT ON TABLE u1.t1 to the test1 user.
- User who has the privilege of ACCESS CONTROL ON DATABASE
 - The user can control all privileges on all objects.

When the test user is granted the same privileges from multiple users as follows, the test user can execute SELECT statement until all the privileges are revoked.

- The object owner u1 grants the privilege to the test user.

```
GRANT SELECT ON TABLE u1.t1 TO test;
```

- The object owner u1 grants the privilege of WITH GRANT OPTION to the user u2.

```
GRANT SELECT ON TABLE u1.t1 TO u2 WITH GRANT OPTION;
```

- The user u2 executes it.
- The u2 user with the privilege of WITH GRANT OPTION grants the privilege to the test user.

```
GRANT SELECT ON TABLE u1.t1 TO test;
```

In the example above, the test user has two SELECT ON TABLE u1.t1 privileges which were granted by user u1 and user u2. The privilege information consists of {grantor, grantee, object privileges}.

PUBLIC Account

PUBLIC account is a special account which means every user.

For example, if the SELECT privilege is granted to PUBLIC account as follows, every user can execute SELECT statements on the table, u1.t1.

```
GRANT SELECT ON TABLE u1.t1 TO PUBLIC;
```

Even a user without SELECT privilege can execute SELECT statements on the table u1.t1 using the SELECT privilege on PUBLIC account.

When a privilege is granted to PUBLIC account, it is granted not to the existing users but to PUBLIC account itself. Even the newly created user can also execute SELECT statements.

Likewise, the user can execute SELECT statements if the user has the SELECT privilege on the table u1.t1 because revoking a privilege from PUBLIC account does not mean revoking the privilege from every user.

- The privilege is granted to the test user.

```
GRANT SELECT ON TABLE u1.t1 TO test;
```

- The privilege is granted to PUBLIC account.

```
GRANT SELECT ON TABLE u1.t1 TO PUBLIC;
```

- The privilege is revoked from PUBLIC account, and the test user still has the privilege on SELECT ON TABLE u1.t1.

```
REVOKE SELECT ON TABLE u1.t1 FROM PUBLIC;
```

Column Privilege

By granting privileges only on specific columns of a table, it is possible to control the execution of DML or SELECT statements of other user.

The following is an example table.

```
CREATE TABLE u1.t1
(
  id      BIGINT,
  name    VARCHAR(128),
  addr    VARCHAR(1024),
  salary  NUMBER(20,0)
);
```

If SELECT privilege on the table u1.t1 excluding the salary column information is granted to another user, **GRANT privileges TO** statement is executed by listing the columns to be grantees of the privilege as follo

ws. The test user who is the grantees of the privilege can not query the salary column.

- The privilege on SELECT columns is granted to the test user.

```
GRANT SELECT( id, name, addr ) ON TABLE u1.t1 TO test;
```

If the privilege on a table is granted as follows, the privilege on every column in the table is automatically granted. If both table privilege and column privilege are granted, the privilege information for a column is duplicated and the information is not dually managed.

- SELECT privilege is granted to the test user.

```
GRANT SELECT ON TABLE u1.t1 TO test;
```

- Privileges on every column in the table u1.t1 are automatically granted.

```
GRANT SELECT(id) ON TABLE u1.t1 TO test;
GRANT SELECT(name) ON TABLE u1.t1 TO test;
GRANT SELECT(addr) ON TABLE u1.t1 TO test;
GRANT SELECT(salary) ON TABLE u1.t1 TO test;
```

The privilege on a column is revoked by using **REVOKE privileges FROM** as follows.

- The privilege on SELECT columns is revoked from the test user.

```
REVOKE SELECT( id, name, addr ) ON TABLE u1.t1 FROM test;
```

If the privilege on a table is revoked as follows, the privilege on every column in the table is automatically revoked. Even if the column privileges and table privileges are separately granted, the columns privileges are revoked when the table privileges are revoked.

- SELECT privilege is revoked from the test user.
- Privileges on every column in the table u1.t1 are revoked.

```
REVOKE SELECT ON TABLE u1.t1 FROM test;
```

When revoking only the column privilege and the table privilege still exists as follows, then the following statements can be executed by using the table privilege. Therefore, to grant the privilege only on a specific column, the table privilege should be revoked, and then each column privilege should be granted.

- SELECT table privilege is granted to the test user.

```
GRANT SELECT ON TABLE u1.t1 TO test;
```

- The SELECT(salary) column privilege is revoked from the test user.
- The test user can query the salary column in the table u1.t1 because the test user has the SELECT privilege on the table.

```
REVOKE SELECT(salary) ON TABLE u1.t1 FROM test;
```

For more information about the privileges on a table and columns, refer to **GRANT privileges TO** .

13.5 Schema

Schema-related Statements

For more information about creating and dropping a schema, refer to the followings.

- Creating a schema: **CREATE SCHEMA**.
- Dropping a schema: **DROP SCHEMA**.

Information which is related to a schema object can be retrieved through the following views.

Table 13-12 Schema object-related information

Schema	View	Description
DICTIONARY_SCHEMA	ALL_SCHEMAS	User accessible schema information
	ALL_SCHEMA_PATH	User accessible schema path
	USER_SCHEMAS	User owned schema information
	USER_SCHEMA_PATH	User's schema path information
INFORMATION_SCHEMA	SCHEMATA	User accessible schema information

Concepts of Schema

The database consists of one or more schemas. The schema consists of objects such as tables, indexes, views, which processes data. SQL schema object is an object which belongs to the schema.

Schema is similar to the directory in OS. The relationship between schema and tables is similar to the relationship between the directories and files in OS.

Schema is the logical position of the SQL schema object and it is criteria of distinguishing the name. Every SQL schema object should have a unique name and the naming space in the schema is as follows.

- Table, view, sequence, private synonym, stored procedure, stored function
- Index
- Constraint

The same name tables can be defined in the different schema. The different tables with same name are accessible and executed by specifying together with the schema name.

```
gSQL> SELECT u1.t1.id, u1.t1.name, u2.t1.addr
        FROM u1.t1, u2.t1
        WHERE u1.t1.id = u2.t1.id;
```

The name of SQL schema object is specified together with the schema name or without it. If the schema name is omitted, it is determined by the user's schema path. For more information about the schema path, refer to **Schema Path** clause.

- When the schema name is specified

```
gSQL> SELECT u1.t1.id, u1.t1.name FROM u1.t1;
```

- When the schema name is omitted

```
gSQL> SELECT t1.id, t1.name FROM t1;
```

User and Schema

In GOLDILOCKS, relationship between the user and the schema is 1:N. A user does not own a schema, or the user can have multiple schemas.

The SQL standard does not explicitly define the relationship of the non-schema objects such as user, schema, database. Each DBMS defines the relationship of the non-schema objects in different ways, and they are as follows.

- Oracle
 - The relationship between the user and the schema is 1:1.
- DB2
 - The relationship between the user and the schema is 1:N.
- Postgres
 - The relationship between the user and the schema is 1:N.
- MySQL
 - The relationship between the database and the schema is 1:1.
 - User is a subordinate object of the schema (database).

When establishing the database, GOLDILOCKS configures various relationships between the users and schemas in accordance with the characteristics of the client system as follows.

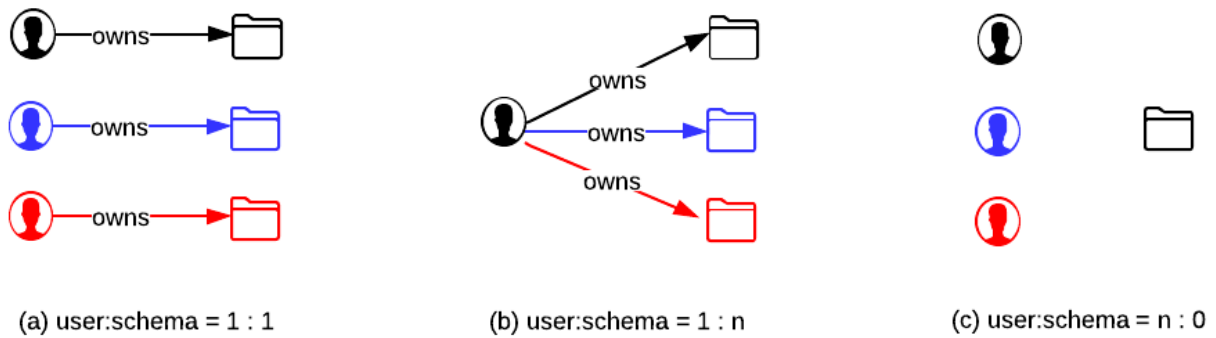
Figure 4 Relationship between user and schema

To configure the database in which each user has its own schema as shown in the figure (a), create the users and schemas as follows.

- Create a user and the schema u1 together so that the user owns the schema.

```
gSQL> CREATE USER u1 IDENTIFIED BY u1_password WITH SCHEMA;
```

- WITH SCHEMA statement is optional and a schema whose name is as same as the user is created.

```
gSQL> CREATE USER u2 IDENTIFIED BY u2_password;
gSQL> CREATE USER u3 IDENTIFIED BY u3_password;
```

To configure the database in which a single user has multiple schemas as shown in the figure (b), create the users and schemas as follows.

- Create the user u1 only without creating a schema.

```
gSQL> CREATE USER u1 IDENTIFIED BY u1_password WITHOUT SCHEMA;
```

- Create multiple schemas and specify the owner of each schema as a user u1.

```
gSQL> CREATE SCHEMA s1 AUTHORIZATION u1;
gSQL> CREATE SCHEMA s2 AUTHORIZATION u1;
gSQL> CREATE SCHEMA s3 AUTHORIZATION u1;
```

To configure the database in which multiple users share a single schema without creating a schema as shown in the figure (c), create users as follows.

All users share **PUBLIC Schema** in the following examples.

- Create users only without creating a schema.

```
gSQL> CREATE USER u1 IDENTIFIED BY u1_password WITHOUT SCHEMA;  
gSQL> CREATE USER u2 IDENTIFIED BY u2_password WITHOUT SCHEMA;  
gSQL> CREATE USER u3 IDENTIFIED BY u3_password WITHOUT SCHEMA;
```

For more information about creating user and schema, refer to **CREATE USER**, **CREATE SCHEMA**.

Schema Path

Schema path is a path to find the schema name when the SQL schema object name such as a table is used without the schema name. Schema path is similar to the PATH environment variable of Unix system. It is similar in searching for a command in the PATH in the specified order when executing commands on Unix system.

When a user has multiple schemas, then creates or queries the table without a schema name as follows, the schema path determines in which schema the table will be created.

- A table t1 is created in the schema s1.

```
gSQL> CREATE TABLE s1.t1 ( id INTEGER );
```

- A table t1 is created in the schema s2.

```
gSQL> CREATE TABLE s2.t1 ( name VARCHAR(128) );
```

- In which schema the table t1 will be created?

```
gSQL> CREATE TABLE t1 ( address VARCHAR(1024) );
```

- Which schema's table t1 is retrieved?

```
gSQL> SELECT * FROM t1;
```

The figure below illustrates an example of a schema path for user u1. The schema path of user u1 is designated in an order of {s1, s2, s3}. Schema s1 has a table t1, schema s2 has a table t2, and the schema s3 has tables t1 and t3.

Figure 5 Example of schema path

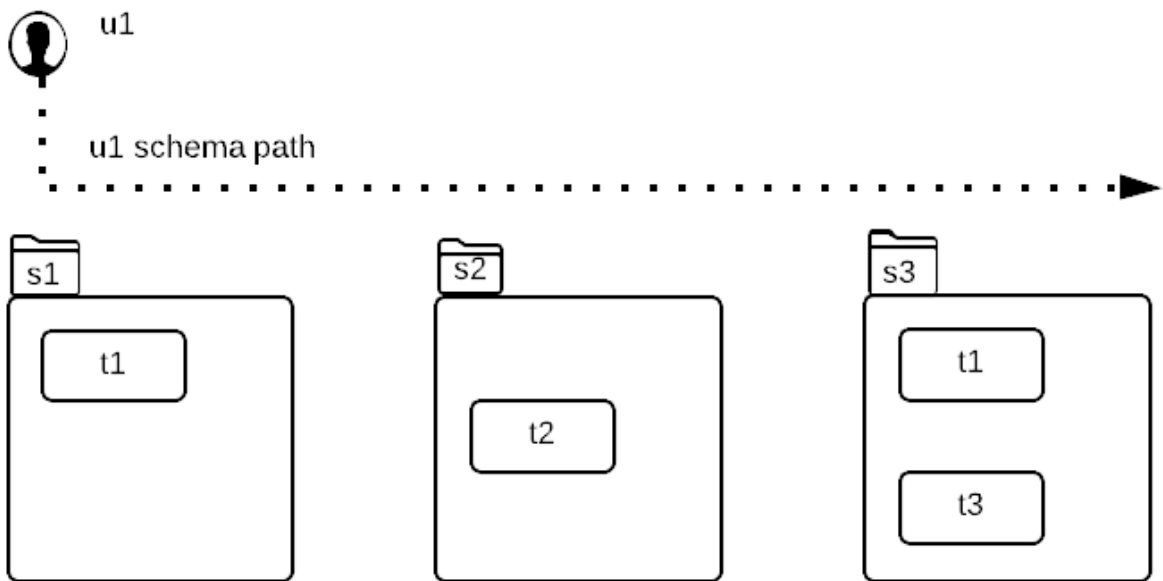

In the SELECT statement without the schema name, the schema name is construed by the schema path as follows.

- It is construed as table s1.t1 by the schema path.

```
gSQL> SELECT * FROM t1;
gSQL> SELECT * FROM s1.t1;
```

- It is construed as table s2.t2 by the schema path.

```
gSQL> SELECT * FROM t2;
gSQL> SELECT * FROM s2.t2;
```

- It is construed as table s3.t3 by the schema path.

```
gSQL> SELECT * FROM t3;
gSQL> SELECT * FROM s3.t3;
```

When omitting the schema name to retrieve the table s3.t1 as the example above, the table s3.t1 is determined by schema path, so the schema name should be specified as follows.

- It retrieves the table s1.t1 by the schema path.

```
gSQL> SELECT * FROM t1;
```

- The schema s3 should be specified to retrieve the table s3.t1.

```
gSQL> SELECT * FROM s3.t1;
```

The following CREATE TABLE statement in which the schema name is omitted creates a table in the first schema s1 of the schema path.

- An error occurs because the identical table s1.t1 exists.

```
gSQL> CREATE TABLE t1 ( id INTEGER );
gSQL> CREATE TABLE s1.t1 ( id INTEGER );
```

- The table s2.t2 exists, but the table s1.t2 is created in different schemas.

```
gSQL> CREATE TABLE t2 ( name VARCHAR(128) );
gSQL> CREATE TABLE s1.t2 ( name VARCHAR(128) );
```

- The table s3.t3 exists, but the table s1.t3 is created in different schemas.

```
gSQL> CREATE TABLE t3 ( name VARCHAR(128) );
gSQL> CREATE TABLE s1.t3 ( name VARCHAR(128) );
```

If the current user omits the schema name when creating an object, the schema name to be used can be retrieved by using **CURRENT_SCHEMA** which is the SQL standard function.

```
gSQL> SELECT current_schema FROM dual;
CURRENT_SCHEMA
-----
S1
1 row selected.
```

The schema path information of the current user can be retrieved by using ALL SCHEMA PATH view in DICTIONARY_SCHEMA schema.

```
gSQL> SELECT * FROM all_schema_path;
AUTH_NAME  SCHEMA_NAME          SEARCH_ORDER
-----
U1         S1                   1
U1         S2                   2
U1         S3                   3
U1         PUBLIC               4
PUBLIC     DICTIONARY_SCHEMA    5
PUBLIC     INFORMATION_SCHEMA   6
PUBLIC     DEFINITION_SCHEMA    7
```

```

PUBLIC     PERFORMANCE_VIEW_SCHEMA      8
PUBLIC     FIXED_TABLE_SCHEMA          9
9 rows selected.

```

In the example above, the schema path of the user u1 is in an order of {s1, s2, s3, public}, and the schema path of PUBLIC account is in an order of {DICTIONARY_SCHEMA, INFORMATION_SCHEMA, DEFINITION_SCHEMA, PERFORMANCE_VIEW_SCHEMA, FIXED_TABLE_SCHEMA}.

If omitting the schema name and retrieving a table t1, then it searches for the schema path for the current user u1. If the schema path does not exist in it, then it searches for the schema path of PUBLIC account.

Schema path of a specific user can be altered by using **ALTER USER** statement as follows. The schema path of PUBLIC account can be altered by using ALTER USER PUBLIC SCHEMA PATH statement.

CURRENT PATH clause is used to additionally alter other schemas together with the user's current schema.

- The schema path of user u1 is altered.

```

gSQL> ALTER USER u1 SCHEMA PATH ( s3, s2, s1 );
User altered.

```

- The schema path of PUBLIC account is altered.

```

gSQL> ALTER USER PUBLIC SCHEMA PATH ( s1, s2, s3 );
User altered.

```

- The schema path which includes the current schema path is altered by using CURRENT PATH.

```

gSQL> ALTER USER u1 SCHEMA PATH ( s4, CURRENT PATH );
User altered.

```

The schema path is automatically determined when a user is created by using **CREATE USER** statement. And if the user schema is created by using **CREATE SCHEMA** statement later, then it is not automatically included in the user's schema path, so, if necessary, it should be included in the schema path by using **ALTER USER** statement. For more information, refer to each statement.

PUBLIC Schema

PUBLIC schema is a shared schema in which any user can create objects. As shown in the example below, if the user who does not have the schema creates the table whose schema name is not specified, then the table's schema is PUBLIC.

- A user u1 who does not have the schema is created.

```
gSQL> CREATE USER u1 IDENTIFIED BY u1_password WITHOUT SCHEMA;
gSQL> GRANT CREATE SESSION TO u1;
gSQL> GRANT CREATE OBJECT ON TABLESPACE mem_data_tbs TO u1;
```

- The user u1 creates a table.

```
% gsql u1 u1_password
gSQL> CREATE TABLE t1 ( id INTEGER );
```

- The statements above have the same meaning as the following.

```
gSQL> CREATE TABLE public.t1 ( id INTEGER );
```

In the example above, the table t1's schema which is created by user u1, is PUBLIC. PUBLIC schema is a built-in schema which is automatically created when creating the database.

It is granted the privilege of the same meaning as the following statement so that any user can create an object in the schema.

```
gSQL> GRANT CREATE TABLE, CREATE VIEW, CREATE INDEX, CREATE SEQUENCE, ADD CONSTRAINT
      ON SCHEMA PUBLIC
      TO PUBLIC;
```

PUBLIC schema, shared schema, is different from PUBLIC account which means all users. In the statement above, the privilege of creating objects in the PUBLIC schema (ON SCHEMA PUBLIC) is granted to PUBLIC account (TO PUBLIC) which means all users.

Any user can create or manage tables, but an appropriate privilege is required for retrieving the table created in PUBLIC schema by another user.

The followings are examples of GRANT statements using PUBLIC account and PUBLIC schema.

- SELECT privilege on table u1.t1 is granted to PUBLIC account.
- Any user can retrieve the table u1.t1.

```
gSQL> GRANT SELECT ON TABLE u1.t1 TO PUBLIC;
```

- SELECT privilege on all tables in PUBLIC schema is granted to user u1.
- The user u1 can retrieve all tables in PUBLIC schema.

```
gSQL> GRANT SELECT TABLE ON SCHEMA PUBLIC TO u1;
```

User and Examples of Using Schema

For example, if a single administrator and multiple developers use a single schema, the schema can be controlled by using the following SQL statement.

The following examples describe how to create a `mgr_usr` user who manages our_schema schema, and a number of users such as `app_user1`, `app_user2`, `app_user3` who develops applications using our_schema.

A `mgr_user` user and a `our_schema` schema are created as follows.

- `mgr_user` and `our_schema` are created.
- `mgr_user` owns `our_schema`.

```
gSQL> CREATE USER mgr_user IDENTIFIED BY mgr_user WITH SCHEMA our_schema;  
User created.
```

- An appropriate privilege is granted to `mgr_user`.

```
gSQL> GRANT ALL PRIVILEGES ON DATABASE TO mgr_user;  
Grant succeeded.  
gSQL> COMMIT;  
Commit complete.
```

Multiple `app_user` users are created as follows.

The `app_user` users are allowed to execute only `SELECT` and `DML` statements on `our_schema`.

- Multiple `app_user` users who do not own the schema are created as follows.

```
gSQL> CREATE USER app_user1 IDENTIFIED BY app_user1 WITHOUT SCHEMA;  
User created.  
gSQL> CREATE USER app_user2 IDENTIFIED BY app_user2 WITHOUT SCHEMA;  
User created.  
gSQL> CREATE USER app_user3 IDENTIFIED BY app_user3 WITHOUT SCHEMA;  
User created.  
gSQL> COMMIT;  
Commit complete.
```

- The access privileges are granted to multiple `app_user` users.

```
gSQL> GRANT CREATE SESSION ON DATABASE TO app_user1, app_user2, app_user3;  
Grant succeeded.  
gSQL> COMMIT;
```

Commit complete.

- Only read/write privileges on our_schema are granted to multiple app_user users.

```
gSQL> GRANT SELECT TABLE, INSERT TABLE, UPDATE TABLE, DELETE TABLE ON SCHEMA our_schema TO
app_user1, app_user2, app_user3;
Grant succeeded.
gSQL> COMMIT;
Commit complete.
```

- SCHEMA_PATH of multiple app_user users are specified as our_schema.

```
gSQL> ALTER USER app_user1 SCHEMA PATH ( our_schema );
User altered.
gSQL> ALTER USER app_user2 SCHEMA PATH ( our_schema );
User altered.
gSQL> ALTER USER app_user3 SCHEMA PATH ( our_schema );
User altered.
gSQL> COMMIT;
Commit complete.
```

Through the operations above, mgr_user has DDL privileges of creating/ dropping/ altering an object in our_schema, but multiple app_user can only read/write operations on the tables in our_schema.

mgr_user can perform management tasks such as creating a table as follows.

```
gSQL> \connect mgr_user mgr_user
gSQL> CREATE TABLE t1 ( c1 INTEGER );
Table created.
gSQL> INSERT INTO t1 VALUES ( 1 );
1 row created.
gSQL> INSERT INTO t1 VALUES ( 2), ( 3);
2 rows created.
gSQL> COMMIT;
Commit complete.
```

Multiple app_user can read/write operation for the table in our_schema without specifying the schema name, but they are not allowed to create or drop an object as follows.

```
gSQL> \connect app_user1 app_user1
gSQL> SELECT * FROM t1;
C1
--
```

1

2

3

3 rows selected.

```
gSQL> INSERT INTO t1 VALUES (4);
```

1 row created.

```
gSQL> COMMIT;
```

Commit complete.

```
gSQL> DROP TABLE t1;
```

ERR-42000(16208): insufficient privileges

13.6 Tablespace

Tablespace-related Statements

For more information, refer to the followings.

- Creating tablespace
 - CREATE TABLESPACE
 - CREATE MEMORY DATA TABLESPACE
 - CREATE MEMORY TEMPORARY TABLESPACE
- Dropping tablespace: DROP TABLESPACE
- Altering tablespace
 - ALTER TABLESPACE
 - ALTER TABLESPACE name RENAME TO
 - ALTER TABLESPACE name BACKUP
 - ALTER TABLESPACE name [ONLINE|OFFLINE]
- Adding, dropping, altering the datafile which configures the tablespace
 - ALTER TABLESPACE name ADD [DATAFILE|MEMORY]
 - ALTER TABLESPACE name DROP [DATAFILE|MEMORY]
 - ALTER TABLESPACE name RENAME DATAFILE

Information which is related to a tablespace object can be retrieved through the following views.

Table 13-13 Tablespace object related information

Schema	View	Description
DICTIONARY_SCHEMA	USER_TABLESPACES	Information of user accessible tablespaces

Concepts of Tablespace

A tablespace is a logical concept and it consists of one or more physical shared memory. It is a space to store data, such as tables, indexes.

Physical objects such as tables, indexes which are stored in a tablespace can be spanned multiple shared memories as shown below.

A tablespace can be extended by adding the shared memory.

Figure 6 Concept of tablespace

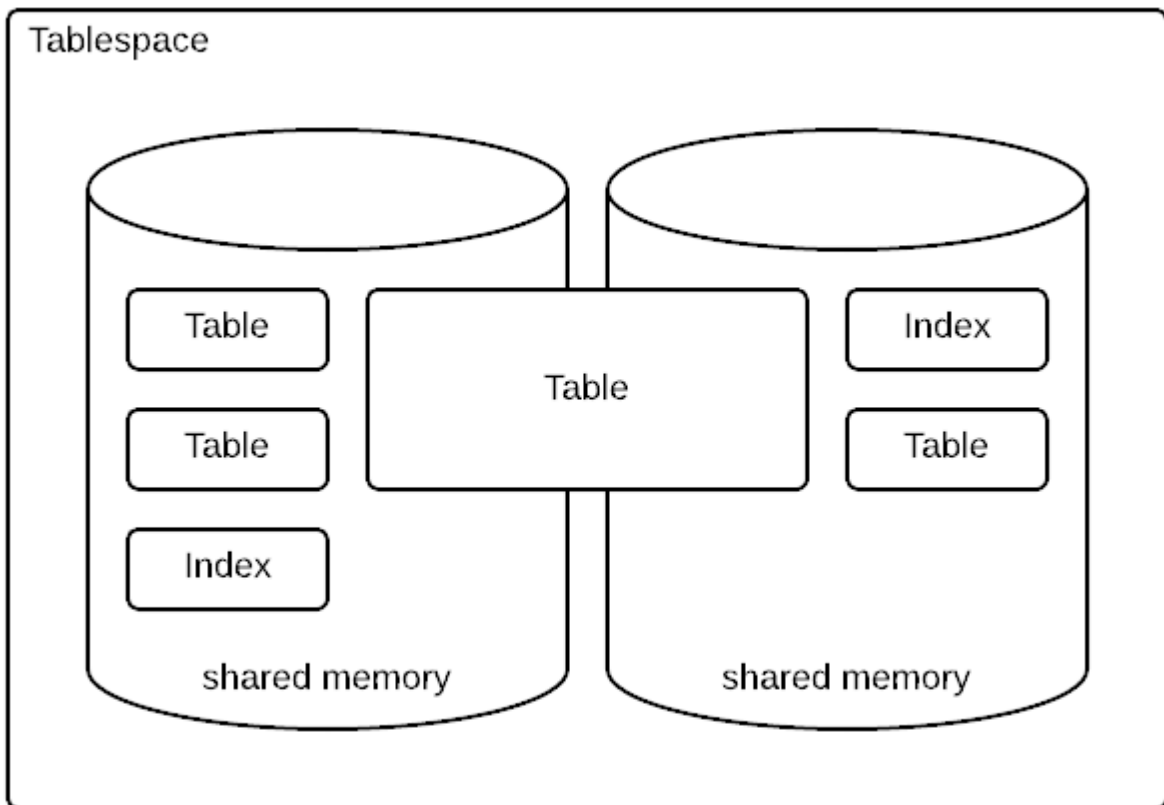

Tablespaces are classified into three types depending on the stored data type as follows.

- DATA TABLESPACE
 - It is tablespace to store and manage permanent data such as tables, logging indexes.
- TEMPORARY TABLESPACE
 - It is tablespace to store and manage volatile data such as the indexes without logging, the hash which is generated during query execution and the sort.
- UNDO TABLESPACE
 - It is tablespace to store and manage the data change information for rollback the transaction.

Tables, indexes (LOGGING) stored in DATA tablespace create redo logs to permanently manage data. However, indexes without logging stored in TEMPORARY tablespace does not create redo logs. The index without logging does not log the changes. When restarting the system, it is rebuilt based on the table data, and the index facility is retained.

A tablespace is a physical storage in which SQL schema objects are stored. A particular tablespace can be specified when creating a table and index. A table, the index which is related to the table, and the indexes which is created for the constraint condition of the table can be stored in different tablespaces.

For more information about specifying the tablespace when creating an object, refer to the followings.

- CREATE TABLE
- CREATE INDEX
- ALTER TABLE name ADD CONSTRAINT

If a tablespace is not specified when creating an object such as a table or index, the default tablespace is used.

For more information about the user's default tablespace, refer to the followings.

- CREATE USER
- ALTER USER

For more information about tablespace, refer to **Managing Tablespace**.

13.7 Table

Table-related Statements

Statements for creating, dropping, altering a table are as follows.

- Creating table
 - **CREATE TABLE**
 - **CREATE TABLE AS SELECT**
 - **CREATE GLOBAL TEMPORARY TABLE**
- Dropping table
 - **DROP TABLE**
 - **TRUNCATE TABLE**
- Altering table
 - **ALTER TABLE**
 - **ALTER TABLE name RENAME TO**
 - **ALTER TABLE name STORAGE**
- Adding, dropping, alerting a column of the table
 - **ALTER TABLE name ADD COLUMN**
 - **ALTER TABLE name SET UNUSED COLUMN**
 - **ALTER TABLE name ALTER COLUMN**
 - **ALTER TABLE name RENAME COLUMN**
- Adding, dropping, alerting a constraint of the table
 - **ALTER TABLE name ADD CONSTRAINT**
 - **ALTER TABLE name DROP CONSTRAINT**
 - **ALTER TABLE name ALTER CONSTRAINT**
- Adding, dropping additional log of the table
 - **ALTER TABLE name ADD SUPPLEMENTAL LOG**
 - **ALTER TABLE name DROP SUPPLEMENTAL LOG**
- Table statistics information: **ANALYZE TABLE**.

Information which is related to a table object can be retrieved through the following views.

Table 13-14 Table object related information

Schema	View	Description
DICTIONARY_SCHEMA	ALL_ALL_TABLES	Information about user accessible tables
	ALL_COL_COMMENTS	Information about comments of user accessible column
	ALL_CONSTRAINTS	Information about user accessible constraints
	ALL_CONS_COLUMNS	Column information about user accessible constraints
	ALL_TABLES	Information about user accessible tables
	ALL_TAB_COLS	Information about user accessible columns
	ALL_TAB_COLUMNS	Information about user accessible columns
	ALL_TAB_COMMENTS	Information about comments of user accessible tables
	ALL_TAB_IDENTITY_COLS	Identity column information about user accessible tables
	USER_ALL_TABLES	Information about user owned tables
	USER_COL_COMMENTS	Information about comments of user owned columns
	USER_CONSTRAINTS	Information about user owned constraints
	USER_CONS_COLUMNS	Column information about user owned constraints
	USER_TABLES	Information about user owned tables
	USER_TAB_COLS	Information about user owned columns
	USER_TAB_COLUMNS	Information about user owned columns
	USER_TAB_COMMENTS	Information about comments of user owned tables
	USER_TAB_IDENTITY_COLS	Identity column information about user owned tables
INFORMATION_SCHEMA	COLUMNS	Information about user accessible columns
	CONSTRAINT_COLUMN_USAGE	Column information about user accessible constraints
	CONSTRAINT_TABLE_USAGE	Table information about user accessible constraints
	KEY_COLUMN_USAGE	Column information about user accessible key constraints
	TABLES	Information about user accessible tables
	TABLE_CONSTRAINTS	Information about user accessible constraints

Concepts of Table

Table is an underlying object which configures the database. In the SQL standard, the table is called as a base table, and the view is called as a viewed table.

The table consists of columns and rows. The table consists of multiple rows, the number and order of columns in each row is same.

The table consists of one or more columns, and each column has a name but a row does not have a name. The order of the row is not always as same as the order in which data is added.

The value is the data in intersection of a column and a row. Column is the set of value which have the same data type.

Each column of a table has a unique name to be distinguished from other columns in the table. It has a data type which corresponds to the characteristics of the value. For more information about data type, refer to **Data Type** section.

The constraints can be added to the table for data integrity. For more information about constraint, refer to **CREATE TABLE, ALTER TABLE name ADD CONSTRAINT**.

The table index can be created to improve performance of queries. For more information about index, refer to **Index** section.

The following is an example of creating a lineitem table using **CREATE TABLE** statement.

```
CREATE TABLE lineitem
(
  l_orderkey      INTEGER      NOT NULL
, l_partkey      INTEGER      NOT NULL
, l_suppkey      INTEGER      NOT NULL
, l_linenumber   INTEGER      NOT NULL
, l_quantity     NUMERIC(12,2)
, l_extendedprice NUMERIC(12,2)
, l_discount     NUMERIC(12,2)
, l_tax          NUMERIC(12,2)
, l_returnflag   CHAR(1)      NOT NULL  DEFAULT 'F'
, l_linestatus   CHAR(1)
, l_shipdate     DATE
, l_commitdate   DATE
, l_receiptdate  DATE
, PRIMARY KEY (l_orderkey, l_linenumber) INDEX lineitem_pk_idx TABLESPACE mem_temp_tbs
) TABLESPACE mem_data_tbs;
```

In the example above, multiple columns and constraints are defined in the lineitem table. When using constraints to define columns, NOT NULL constraints are defined for the columns l_orderkey, l_partkey, l_suppkey, l_linenumber.

PRIMARY KEY constraint is defined by combining columns of l_orderkey, l_linenumber.

In-line constraint is described together with the column definitions. Out-line constraint is described separately from the column definitions.

Using DEFAULT clause in the column l_returnflag, the value 'F' is declared as a default value for the column. The index which is created when creating PRIMARY KEY constraints is named separately as lineitem_pk_idx. The tablespace in which the index will be stored is named as mem_temp_tbs. The table is physically stored in the tablespace mem_data_tbs.

The following is an example of adding a constraint to a table using **ALTER TABLE name ADD CONSTRAINT** statement.

```
ALTER TABLE lineitem
  ADD CONSTRAINT lineitem_unique_all_key
  UNIQUE( l_orderkey ASC, l_partkey DESC, l_suppkey DESC, l_linenum ASC);
```

In the example above, UNIQUE constraint is added to the lineitem table, and the column sort order ASC/DESC is specified for the automatically created index of constraints.

The following is an example of adding columns to the table using **ALTER TABLE name ADD COLUMN** statement.

```
ALTER TABLE lineitem ADD COLUMN
(
  l_shipinstruct CHAR(25)
, l_shipmode     CHAR(10)
, l_comment      VARCHAR(44)
);
```

In the example above, multiple columns are added to a table. The in-line constraints or default values can be specified when adding columns.

The following is an example of creating an index in the table using **CREATE INDEX** statement.

```
CREATE INDEX lineitem_idx_shipdate ON lineitem( l_shipdate ASC NULLS LAST );
```

The example above describes the index which is created for the column l_shipdate which is often used as the query conditions. The column sort order is ascending (ASC), and if NULL value exists, it is specified to be located at the end.

For more information about DML statements of inserting/deleting/updating data to a table, refer to **Data Manipulation Language** clause.

For more information about SELECT statements of querying data in a table, refer to **Data Query Language** clause, **SELECT** statement.

Global Temporary Table

Global temporary table is a kind of temporary table and the table definition is shared by all users, but the data is separated per session.

The table definition is created when executing **CREATE GLOBAL TEMPORARY TABLE**, but the physical se

gment is created in a state which is dependent on a session when executing INSERT to that table for the first time. The segments which are allocated to all global temporary tables created in the session are released when the session is terminated. An option defined at the time of creating a global temporary table determines whether to truncate the data left after committing or rolling back.

It supports all DDL and DML provided by a table except for cluster-related statements. A DDL statement returns an error to the global temporary table which is used by the current session. However, TRUNCATE TABLE statement for a global temporary table is applied only to the current session, so it does not return an error even when it is used by another session.

A global temporary table can be defined only in a temporary tablespace, so it does not record a redo log for restart recovery. However, it records the undo log for MVCC and rollback, and the space on which the undo log is recorded can be selected to system undo tablespace or system temp tablespace by using **TEMP_UNDO_ENABLED**.

If TEMP_UNDO_ENABLED is 1, it records undo logs in a temp undo relation of the session separately from the undo relation of the transaction. If the transaction performs only DML for a global temporary table, then it does not record the transaction record nor the commit log, so it improves the DML performance.

When releasing the segment used in the session, it is returned to the corresponding tablespace, and it is allocated again from the tablespace when allocating again. The process allocating and returning segments in a tablespace costs a lot to keep concurrency with other sessions and to allocate and release segments. Therefore, the segment which was released after used in a session can be reused without returning it by using **TEMP_SEGMENT_CACHE_SIZE**.

In other words, if TEMP_SEGMENT_CACHE_SIZE is set to 0 (default value), then it immediately returns the segment which is released after used to the tablespace. If TEMP_SEGMENT_CACHE_SIZE is set to the value bigger than 1 (maximum 4294967295), then it reuses as many segments as set in a session when returning the segment.

When a global temporary table is not used in a session any more, then cleanup segments in a segment cache at once by using **ALTER SESSION CLEANUP GLOBAL TEMPORARY SEGMENT POOL**;

The following is an example of creating a global temporary table by using **CREATE GLOBAL TEMPORARY TABLE**.

```
CREATE GLOBAL TEMPORARY TABLE SESSION_TABLE1(
    COL1 CHAR(10)
    ,COL2 VARCHAR2(20)
    ,COL3 NUMBER(10)
) ON COMMIT DELETE ROWS;
```

The information about the created global temporary table can be viewed in DICTIONARY tables or views in the same way as viewing the information of an ordinary table.

Table in Cluster

For more information about a table in the cluster environment, refer to **Cluster Table and Shard**.

13.8 Index

Index-related Statements

Statements for creating, dropping, altering an index are as follows.

- Creating an index: **CREATE INDEX**.
- Dropping an index: **DROP INDEX**.
- Updating an index: **ALTER INDEX**.

Information which is related to an index object can be retrieved through the following views.

Table 13-15 Index object related information

Schema	View	Description
DICTIONARY_SCHEMA	ALL_INDEXES	Information about user accessible indexes
	ALL_IND_COLUMNS	Column information about user accessible index
	USER_INDEXES	Information about user owned indexes
	USER_IND_COLUMNS	Column information about user owned index

Concepts of Index

Index is a table related object, and it is used to improve data access performance when retrieving the table. Each index consists of key values using the data in one or more columns of the table. It is an object which is separate from a table.

Database automatically builds the key data of the index when creating the index, and the index key data is automatically managed when adding/deleting/ updating the table data.

The following is an example of a query.

```
SELECT data FROM t1 WHERE id = 12345;
```

If an index does not exist, the results which satisfy the condition are found by checking all rows in the table. If the table consists of multiple rows while the number of results to satisfy the condition is relatively small, the query above has a very inefficient response time.

When creating an index in id column by using the **CREATE INDEX** statement as follows, the optimizer evaluates the costs between the full scan and index scan of a table, and selects the index scan to improve query performance.

```
CREATE INDEX t1_idx_id ON t1(id);
```

When creating an index, two or more columns can be used as an index key, and the index which consists of two or more keys is called as a composite index. The composite Index is sorted by the first key, or sorted by the second key if the first key value is same. It is sorted as many as the number of the keys in this way.

When creating indexes, the column sort order can be specified in ascending (ASC) or descending (DESC). The sort order of NULL value can be specified as NULLS FIRST or NULLS LAST. Refer to the following example.

```
gSQL> CREATE TABLE t1 ( value INTEGER );
Table created.
gSQL> INSERT INTO t1 VALUES (1), (NULL), (3), (2), (NULL);
5 rows created.
gSQL> CREATE INDEX idx1 ON t1 ( value ASC NULLS LAST );
Index created.
gSQL> CREATE INDEX idx2 ON t1 ( value DESC NULLS FIRST );
Index created.
gSQL> SELECT /*+ INDEX(t1, idx1) */ * FROM t1;
VALUE
-----
    1
    2
    3
  null
  null
5 rows selected.
gSQL> SELECT /*+ INDEX(t1, idx2) */ * FROM t1;
VALUE
-----
  null
  null
    3
    2
    1
5 rows selected.
```

In the example above, the index idx1 is specified in the ascending order (ASC), which is NULLS LAST, and the index idx2 is specified in the descending order (DESC), which is NULLS FIRST.

It uses the different index hints when retrieving the table with the same query, so all rows are retrieved by using each index. Results using the index idx1 is sorted in ascending order, and NULL value is located at t

he end. However, the results using the index idx2 is sorted in descending order and NULL value is located in the first.

Concepts of UNIQUE

Index can be created as UNIQUE index or non-unique index. If the key values is not UNIQUE when creating UNIQUE index, then an error occurs.

NULL value is allowed as a key value in UNIQUE index and UNIQUE constraint.

If NULL value is included, the truth table for UNIQUE is as follows. In other words, if the key is one, then it can have multiple null value.

Table 13-16 Truth table for UNIQUE in two values

Value1	Value2	UNIQUE
1	1	false
1	2	true
1	null	true
null	null	true

The UNIQUE index or UNIQUE constraint consisting of two or more keys can have null as the whole value or partial value. If NULL is included in the composite key, the truth table for UNIQUE is as follows.

Table 13-17 Truth table for UNIQUE in composite key

Row1	Row2	UNIQUE
(1, 1)	(1, 1)	false
(1, 1)	(1, 2)	true
(1, null)	(1, null)	false
(1, null)	(2, null)	true
(null, null)	(null, null)	true

Note that the definition of the UNIQUE has been changed in the SQL standard as follows.



- UNIQUE definition until SQL1999

If there are no two rows in T such that the value of each column in one row is non-null and **is equal to** the value of the corresponding column in the other row according to Subclause 8.2, “<comparison predicate>”, then the result of the <unique predicate> is true; otherwise, the result of the <unique predicate> is false.

- UNIQUE definition after SQL2003

If there are no two rows in T such that the value of each column in one row is non-null and **is not distinct from** the value of the corresponding column in the other row, then the result of the <unique predicate> is True; otherwise, the result of the <unique predicate> is False.

GOLDILOCKS follows the SQL2011 standards which is the standard after SQL2003, and the SQL standard UNIQUE is defined by whether or not UNIQUE of composite key exists as shown in the following table.

Table 13-18 Truth table for UNIQUE of the SQL standard composite key

Row1	Row2	Until SQL1999	After SQL2003
(1, 1)	(1, 1)	false	false
(1, 1)	(1, 2)	true	true
(1, null)	(1, null)	true	false
(1, null)	(2, null)	true	true
(null, null)	(null, null)	true	true

Each DBMS vendor follows the SQL standard for UNIQUE definition as follows.

- DBMS which follows the UNIQUE definition after SQL2003: Oracle, SQL server
- DBMS which follows the UNIQUE definition until SQL1999: Postgres, MySQL

13.9 View

View-related Statements

Statements for creating, dropping, altering a view are as follows.

- Creating a view: Refer to **CREATE VIEW**.
- Dropping a view: Refer to **DROP VIEW**.
- Altering a view: Refer to **ALTER VIEW**.

Information which is related to a view object can be retrieved through the following views.

Table 13-19 View object related information

Schema	View	Description
DICTIONARY_SCHEMA	ALL_VIEWS	Information about user accessible views
	ALL_DEPENDENCIES	Information about objects related to user accessible views
	USER_VIEWS	Information about user owned views
	USER_DEPENDENCIES	Information about objects related to user owned views
INFORMATION_SCHEMA	VIEWS	Information about user accessible views
	VIEW_TABLE_USAGE	Information about the table used when creating a view
	VIEW_ROUTINE_USAGE	Information about the stored function used when creating a view

Concepts of View

While a table is a physical relation of storing data, a view is a logical relation consisting of queries. In the SQL standard, it is called as the viewed table. Queries about view can be used as same as the table.

A view has the following advantages.

- Data access can be restricted to allow querying only part of the information in the table.
- The complex and frequent queries can be written in a single view to decrease query's complexity.
- Data can be presented in a perspective different from the table perspective by changing the column names or data of the view.
- Creating applications of views is not affected by the changes in table structures.

The view which is created by a **CREATE VIEW** statement is replaced with in-line view when executing queries as follows.

- Creating a view

```
CREATE VIEW v1 ( v_id, v_sum )
AS
SELECT l_partkey, SUM( l_quantity )
FROM lineitem
GROUP BY l_partkey;
```

- Querying the view

```
SELECT v_id, v_sum
FROM v1
WHERE v_sum > 1000;
```

- Translating the view

```
SELECT v_id, v_sum
FROM ( SELECT l_partkey, SUM( l_quantity )
FROM lineitem
GROUP BY l_partkey
) v1 ( v_id, v_sum )
WHERE v_sum > 1000;
```

In the following example, the asterisk (*) is used in SELECT statement when creating a view v1, and the asterisk means all columns.

In this case, as follows, all the columns including the added column can be retrieved by executing query of view v1 even after a new column addr is added to the table t1 of which the view is approaching.

```
gSQL> CREATE TABLE t1 ( id INTEGER, name VARCHAR(128) );
Table created.
gSQL> INSERT INTO t1 VALUES ( 1, 'leekmo' );
1 row created.
```

- Creating a view by using an asterisk (*)

```
gSQL> CREATE VIEW v1 AS SELECT * FROM t1;
View created.
```

- Querying the view

```
gSQL> SELECT * FROM v1;
ID NAME
```

```
-- -----  
1 leekmo  
1 row selected.
```

- Adding a column to the table which is referenced by the view

```
gSQL> ALTER TABLE t1 ADD COLUMN addr VARCHAR(1024) DEFAULT 'N/A';  
Table altered.
```

- Querying the view after adding the column

```
gSQL> SELECT * FROM v1;  
ID NAME  ADDR  
-- -----  
1 leekmo N/A  
1 row selected.
```

However, creating a view using the asterisk (*) is not recommended because it can cause changes in the application when changing the table structure.

13.10 Sequence

Sequence-related Statements

Statements for creating, dropping, altering, using a sequence are as follows.

- Creating a sequence: Refer to **CREATE SEQUENCE**.
- Dropping a sequence: Refer to **DROP SEQUENCE**.
- Altering a sequence: Refer to **ALTER SEQUENCE**.
- Using a sequence: Refer to **NEXTVAL, CURRVAL**.

Information which is related to a sequence object can be retrieved through the following views.

Table 13-20 Sequence object related information

Schema	View	Description
DICTIONARY_SCHEMA	ALL_SEQUENCES	Information about user accessible sequences
	USER_SEQUENCES	Information about user owned sequences
INFORMATION_SCHEMA	SEQUENCES	Information about user accessible sequences

Concepts of Sequence

Sequence is an object which automatically creates a sequential number, and it is called as sequence generator in the SQL standard. Sequence is a useful object to automatically manage the unique key or primary key. A sequence can be spanned multiple tables.

The following is an example of using a single sequence object to automatically generate the id column value, and using it across multiple tables.

```
gSQL> CREATE SEQUENCE seq;
Sequence created.
gSQL> INSERT INTO t1 (id, name) VALUES ( seq.NEXTVAL, 'leekmo' );
1 row created.
gSQL> INSERT INTO t2 (id, addr) VALUES ( seq.CURRVAL, 'Seoul, Korea' );
1 row created.
gSQL> SELECT * FROM t1;
ID NAME
-- -----
1 leekmo
1 row selected.
```

```
gSQL> SELECT * FROM t2;
ID ADDR
-- -----
1 Seoul, Korea
1 row selected.
```

In the example above, the next number of the id column in table t1 is automatically created by using the seq.NEXTVAL function. The same value is used for id column in table t2 by using the seq.CURRVAL function.

When creating the sequence, the starting value, incremental value, minimum value, maximum value, cycle or no cycle and cached value of the automatically generated number can be specified.

For more information, refer to **CREATE SEQUENCE** statement.

An identity column is similar to a sequence, and it automatically generates numbers in a table. It can be used as follows.

```
gSQL> CREATE TABLE t1 ( id INTEGER GENERATED ALWAYS AS IDENTITY, name VARCHAR(128) );
Table created.
gSQL> INSERT INTO t1 (name) VALUES ( 'leekmo' );
1 row created.
gSQL> INSERT INTO t1 (name) VALUES ( 'mkkim' );
1 row created.
gSQL> INSERT INTO t1 (name) VALUES ( 'xcom73' );
1 row created.
gSQL> SELECT * FROM t1;
ID NAME
-- -----
1 leekmo
2 mkkim
3 xcom73
3 rows selected.
```

In the example above, the id column is created as an identity column when creating table t1. The identity column automatically generated id column values, and the values are inserted when executing INSERT statement.

For more information, refer to **<identity column specification>** clause of **CREATE TABLE** statement.

The sequence and the identity column are functionally similar because they create the sequential numbers. However, they are different in the following aspects.

- Sequence is an SQL schema object but identity column is a column of the table.
- Sequence can be spanned multiple tables but identity column can be used only in one table.

After creating a sequence, the sequence values can be used by using **NEXTVAL** or **CURRVAL** function. The sequence value is created independently from the transaction, and it is not affected by COMMIT or ROLLBACK of the transaction.

```
gSQL> INSERT INTO t1(id) VALUES( seq.NEXTVAL );
1 row created.
gSQL> SELECT id FROM t1;
ID
--
 1
1 row selected.
gSQL> ROLLBACK;
Rollback complete.
gSQL> INSERT INTO t1(id) VALUES( seq.NEXTVAL );
1 row created.
gSQL> SELECT id FROM t1;
ID
--
 2
1 row selected.
```

In the example above, seq.NEXTVAL function generates a value of 1 in the first INSERT statement. Then, the seq.NEXTVAL value 2 is generated after the transaction ROLLBACK by increasing the value since the next value, independently from the transaction.

The sequence value can be used only in the following statements.

- The select list value of the top-level SELECT statement
 - SELECT seq.NEXTVAL FROM dual;
- The select list value of INSERT .. SELECT statement
 - INSERT INTO t1(id) SELECT seq.NEXTVAL FROM dual;
- Input value of INSERT .. VALUES statement
 - INSERT INTO t1(id) VALUES (seq.NEXTVAL);
- SET value of UPDATE statement
 - UPDATE t1 SET id = seq.NEXTVAL;

The sequence value can be used only in the location as specified above. It can not be used in subquery, a aggregation function argument, or clauses such as WHERE, DISTINCT, GROUP BY, HAVING, ORDER BY.

Cluster Sequence

When using GOLDLOCKS by configuring the cluster system, the global sequence object is internally used. The global sequence object sets the pool of sequence values to be commonly used over all cluster system, and allocates it as much as the cache size when each member node calls NEXTVAL. In other words, if values of 20 sequences are allocated to a specific node, then the value allocated to other nodes starts from the next value. A member node loads sequence values allocated by the global sequence object in its local cache, then returns them as a result of NEXTVAL call until all of them are run out.

The global sequence object has the following features and constraints comparing to the sequence for the standalone database.

- The sign can not be modified by using the INCREMENT BY option in the ALTER SEQUENCE statement. (The size can be modified.)
- When using the CYCLE option, a duplicated value can be returned to member nodes due to the size of the entire sequence pool. Therefore, if the CYCLE option is required, then the sequence pool should be set big enough considering INCREMENT BY, CACHE SIZE, and the number of cluster member nodes.
- Even when there is not an error, the sequence values returned by a specific member node may not be sequential. However, a sequential sequence value is obtained when only a single member node calls NEXTVAL.
- If it is NOCACHE, then the CACHE SIZE is 1, so the additional sequence values are not loaded on a local cache. In this case, the global sequence object allocates a single sequence whenever calling NEXTVAL, then it increases the networking cost and may cause the poor performance.
- It is generally operated as AUTO COMMIT when creating, altering and deleting the sequence.
- When modifying the size of CACHE and INCREMENT by using the ALTER statement, then all sequence values loaded on local caches of all nodes are reset. In other words, the new sequence set should be allocated again by the global sequence object when calling NEXTVAL later.

13.11 Synonym

Synonym-related Statements

Statements for creating and dropping a synonym are as follows.

- Creating a synonym: Refer to **CREATE SYNONYM**.
- Dropping a synonym: Refer to **DROP SYNONYM**.

Information which is related to a synonym object can be retrieved through the following views.

Table 13-21 Synonym object related information

Schema	View	Description
DICTIONARY_SCHEMA	ALL_SYNONYMS	All synonym information
	USER_SYNONYMS	Information about user owned synonym

Concepts of Synonym

Synonym is an alias for the following objects.

- Table
- View
- Sequence
- Stored procedure
- Stored function
- Other synonyms

Synonyms can be used as an alias in SELECT, INSERT, UPDATE, DELETE, LOCK TABLE, GRANT, REVOKE, COMMENT statements.

Using synonym is very convenient. It is because only the synonym should be redefined without modifying the application even when the schema of underlying objects is changed.

The database security can be improved by hiding the object's real name and its owner. Moreover, the database usability is enhanced by changing the long object name to a short name.

Synonyms are classified as private synonym and public synonym. Private synonym is a schema object and public synonym is a non-schema object.

The following examples of creating and using the private synonym and the public synonym indicated by t

The table below describes the concepts of them.

```
gSQL> \CONNECT u1 u1
gSQL> CREATE TABLE u1.t1 (col1 INTEGER );
gSQL> INSERT INTO u1.t1 VALUES(1);
gSQL> COMMIT;
```

Private Synonym

Private synonym is a schema object. If a synonym is created without the schema name, the default schema name of the user performing the statement is used.

```
gSQL> \CONNECT u2 u2
gSQL> CREATE SYNONYM u2.syn1 FOR u1.t1;
Synonym created.
gSQL> SELECT * FROM u2.syn1;
ERR-42000(16254): lacks privilege (SELECT ON TABLE "U1"."T1")
```

Synonym is only an alias. Therefore, if a user does not have the appropriate privileges on the underlying object u1.t1, then the user can not use it even when the user created the synonym.

```
gSQL> \CONNECT u1 u1
gSQL> GRANT SELECT ON TABLE u2.syn1 TO u2;
gSQL> \CONNECT u2 u2
gSQL> SELECT * FROM u2.syn1;
COL1
----
  1
1 row selected.
gSQL> SELECT * FROM u1.t1;
COL1
----
  1
1 row selected.
gSQL> DROP SYNONYM u2.syn1;
Synonym dropped.
```

In the example above, the SELECT privilege of u2.syn1 is granted to u2. This is the same as the SELECT privilege of u1.t1 is granted to u2. Therefore, be cautious when granting privileges to synonyms.

Public Synonym

Public Synonym is a non schema object. It is not allowed to specify the schema name when it is created or dropped.

```
gSQL> \CONNECT u2 u2
gSQL> CREATE PUBLIC SYNONYM pubSyn1 FOR u1.t1;
Synonym created.
gSQL> SELECT * FROM pubSyn1;
ERR-42000(16254): lacks privilege (SELECT ON TABLE "U1"."T1")
```

Public synonym does not have an owner, and it is accessible for all users. However, a user without an appropriate privilege on the underlying objects can not access the underlying objects.

```
gSQL> \CONNECT u1 u1
gSQL> GRANT SELECT ON TABLE pubSyn1 TO u2;
gSQL> \CONNECT u2 u2
gSQL> SELECT * FROM pubSyn1;
COL1
----
  1
1 row selected.
gSQL> SELECT * FROM u1.t1;
COL1
----
  1
1 row selected.
gSQL> DROP SYNONYM pubSyn1;
Synonym dropped.
```

13.12 Stored Procedure

Stored Procedure-related Statements

Statements for creating, dropping and altering a stored procedure are as follows.

- Creating a stored procedure: Refer to **CREATE PROCEDURE**.
- Dropping a stored procedure: Refer to **DROP PROCEDURE**.
- Altering a stored procedure: Refer to **ALTER PROCEDURE**.

Information which is related to a stored procedure can be retrieved through the following views.

Table 13-22 Stored procedure object related information

Schema	View	Description
DICTIONARY_SCHEMA	ALL_ARGUMENTS	Argument information of user accessible procedure and function
	ALL_DEPENDENCIES	Information of an object related to user accessible procedure and function
	ALL_PROCEDURES	Object information of user accessible procedure and function
	ALL_SOURCE	Source text information of user accessible procedure and function
	USER_ARGUMENTS	Argument information of user owned procedure and function
	USER_DEPENDENCIES	Information of an object related to user owned procedure and function
	USER_PROCEDURES	Object information of user owned procedure and function
	USER_SOURCE	Source text information of user accessible procedure and function
INFORMATION_SCHEMA	PARAMETERS	Argument information of user accessible procedure and function
	ROUTINES	Object information of user accessible procedure and function
	ROUTINE_ROUTINE_USAGE	Information of procedure and function which is referenced by user accessible procedure and function
	ROUTINE_SEQUENCE_USAGE	Information of sequence which is referenced by user accessible procedure and function
	ROUTINE_TABLE_USAGE	Information of table and view which is referenced by user accessible procedure and function

Concepts of Stored Procedure

A stored procedure is a kind of a persistent stored module in procedure form and it is defined and managed in schema unit like as other schema-level database objects. The return value is not defined because it is in procedure form. It is used by directly calling it in CALL statement, another stored procedure, or stored

function.

For more information about a stored procedure, refer to **Schema-level Procedure**.

A store procedure is used as follows.

```
CREATE OR REPLACE PROCEDURE PROC1( A1 INTEGER, A2 INTEGER )
IS
  V1 INTEGER;
BEGIN
  SELECT COUNT(*)
  INTO V1
  FROM T1
  WHERE T1.I1 >= A1 AND T1.I1 <= A2;
  DBMS_OUTPUT.PUT_LINE( 'V1 = ' || V1 );
END;
/
BEGIN
  PROC1( 2, 4 ); -- call schema-level procedure
END;
/
V1 = 3
Anonymous PL block executed.
```

13.13 Stored Function

Stored Function-related Statements

Statements for creating, dropping and altering a stored function are as follows.

- Creating a stored function: Refer to **CREATE FUNCTION**.
- Dropping a stored function: Refer to **DROP FUNCTION**.
- Altering a stored function: Refer to **ALTER FUNCTION**.

Information which is related to a stored function can be retrieved through the following views.

Table 13-23 Stored function object related information

Schema	View	Description
DICTIONARY_SCHEMA	ALL_ARGUMENTS	Argument information of user accessible procedure and function
	ALL_DEPENDENCIES	Information of an object related to user accessible procedure and function
	ALL_PROCEDURES	Object information of user accessible procedure and function
	ALL_SOURCE	Source text information of user accessible procedure and function
	USER_ARGUMENTS	Argument information of user owned procedure and function
	USER_DEPENDENCIES	Information of an object related to user owned procedure and function
	USER_PROCEDURES	Object information of user owned procedure and function
	USER_SOURCE	Source text information of user accessible procedure and function
INFORMATION_SCHEMA	PARAMETERS	Argument information of user accessible procedure and function
	ROUTINES	Object information of user accessible procedure and function
	ROUTINE_ROUTINE_USAGE	Information of procedure and function which is referenced by user accessible procedure and function
	ROUTINE_SEQUENCE_USAGE	Information of sequence which is referenced by user accessible procedure and function
	ROUTINE_TABLE_USAGE	Information of table and view which is referenced by user accessible procedure and function

Concepts of Stored Function

A stored function is a kind of a persistent stored module in function form and it is defined and managed in schema unit like as other schema-level database objects. The return value should be defined because it is in function form. It is used by directly calling it in CALL statement, another stored procedure, or stored f

unction. Or, it is use by calling it in a general SQL internal expression.

For more information about a stored function, refer to **schema-level function**.

A store function is used as follows.

```
gSQL> CREATE OR REPLACE FUNCTION FUNC1( A1 INTEGER, A2 INTEGER )
RETURN INTEGER
IS
  V1 INTEGER;
BEGIN
  SELECT COUNT(*)
  INTO V1
  FROM T1
  WHERE T1.I1 >= A1 AND T1.I1 <= A2;
  RETURN V1;
END;
/
Function created.
gSQL> SELECT FUNC1( 2, 4 ) FROM DUAL;
FUNC1( 2, 4 )
-----
                3
1 row selected.
```

14.

Cluster Objects

14.1 Cluster System

Cluster System Related Statements

For more information, refer to the followings.

- Expanding a cluster system
 - **CREATE CLUSTER GROUP**
 - **ALTER CLUSTER GROUP name ADD MEMBER**
- Controlling an inactive cluster member
 - **ALTER DATABASE DROP INACTIVE CLUSTER MEMBERS**
 - **ALTER SYSTEM JOIN DATABASE**
- Rebalancing data
 - **ALTER DATABASE REBALANCE**
 - **ALTER TABLE name REBALANCE**

Information which is related to a cluster system can be retrieved through the following views.

Table 14-1 Cluster system related information

Schema	View	Description
DICTIONARY_SCHEMA	DBA_CLUSTER	Object information of a cluster group and a cluster member which configure a cluster
	DBA_CLUSTER_COMMENTS	Comment information of a cluster group and a cluster member
PERFORMANCE_VIEW_SCHEMA	V\$CLUSTER_MEMBER	Status information of a cluster member

Concepts of Cluster System

GOLDILOCKS cluster system manages data of a single database by sharding or duplicating the data into several servers. Applications can be run on every server configuring a cluster system, and run in the same way as using a single database system regardless of a system configuration or a connected server.

GOLDILOCKS cluster system consists of one or more cluster groups, and a cluster group consists of one or more cluster members. It does not require a separate application server or a meta server, but applications are connected to a cluster member corresponding to a data server, and run.

Figure 1 3 x 2 cluster system

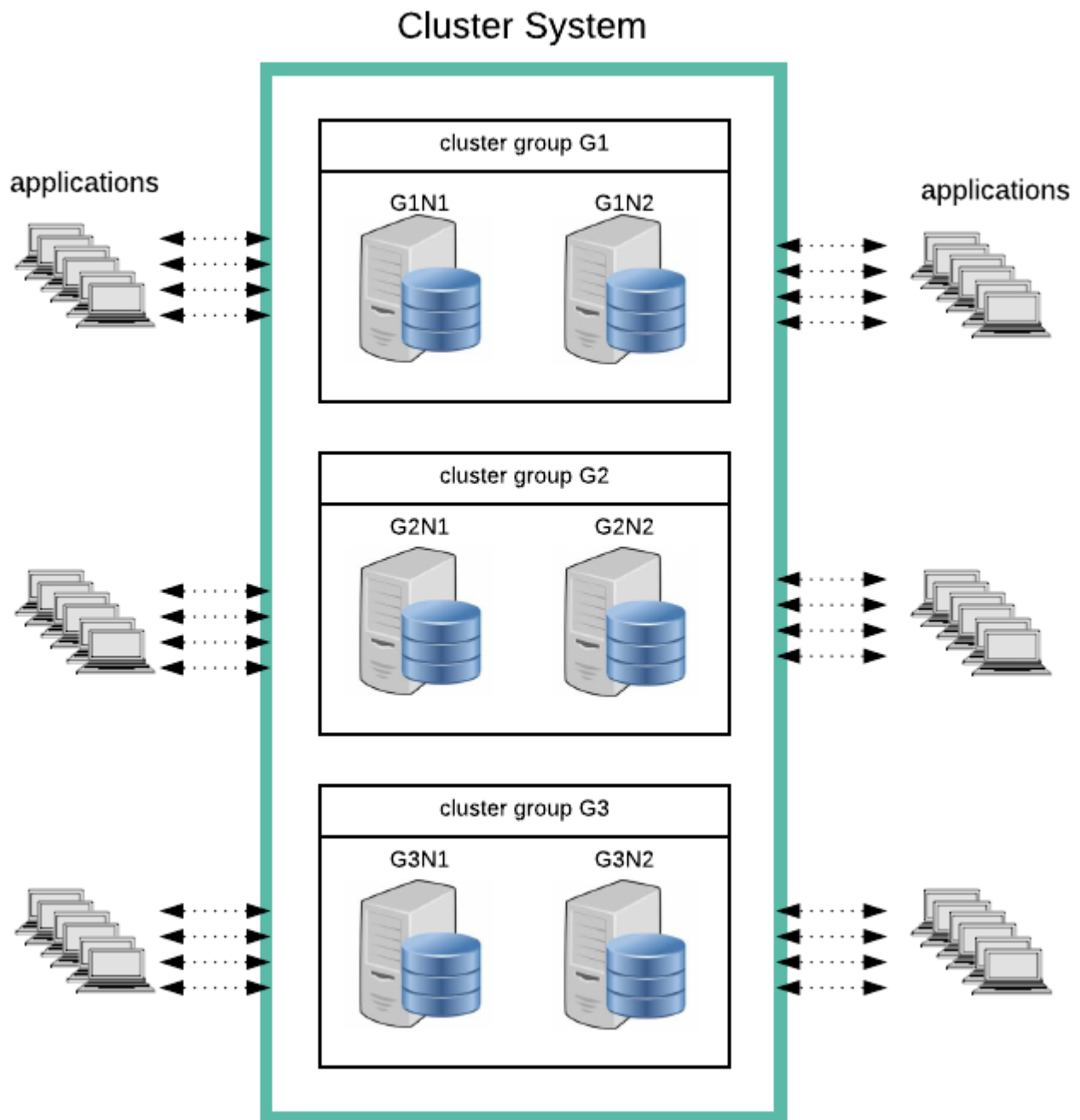

The figure above is a 3x2 cluster system which consists of two cluster members consisting of three cluster groups and a single cluster group. In the figure above, the cluster system consists of cluster groups (G1, G2, G3), and the cluster group G1 consists of cluster members (G1N1, G1N2), the cluster group G2 consists of cluster members (G2N1 and G2N2), and the cluster group G3 consists of cluster members (G3N1, G3N2). Applications can access any of those six cluster members and it is run as same as using a single database.

The table data is sharded and placed in each cluster group, and cluster members in a cluster group maintain the replications same. The figure below describes the concepts of the table data placement in a 3x2 cluster.

Figure 2 Concepts of sharding and duplicating by the cluster

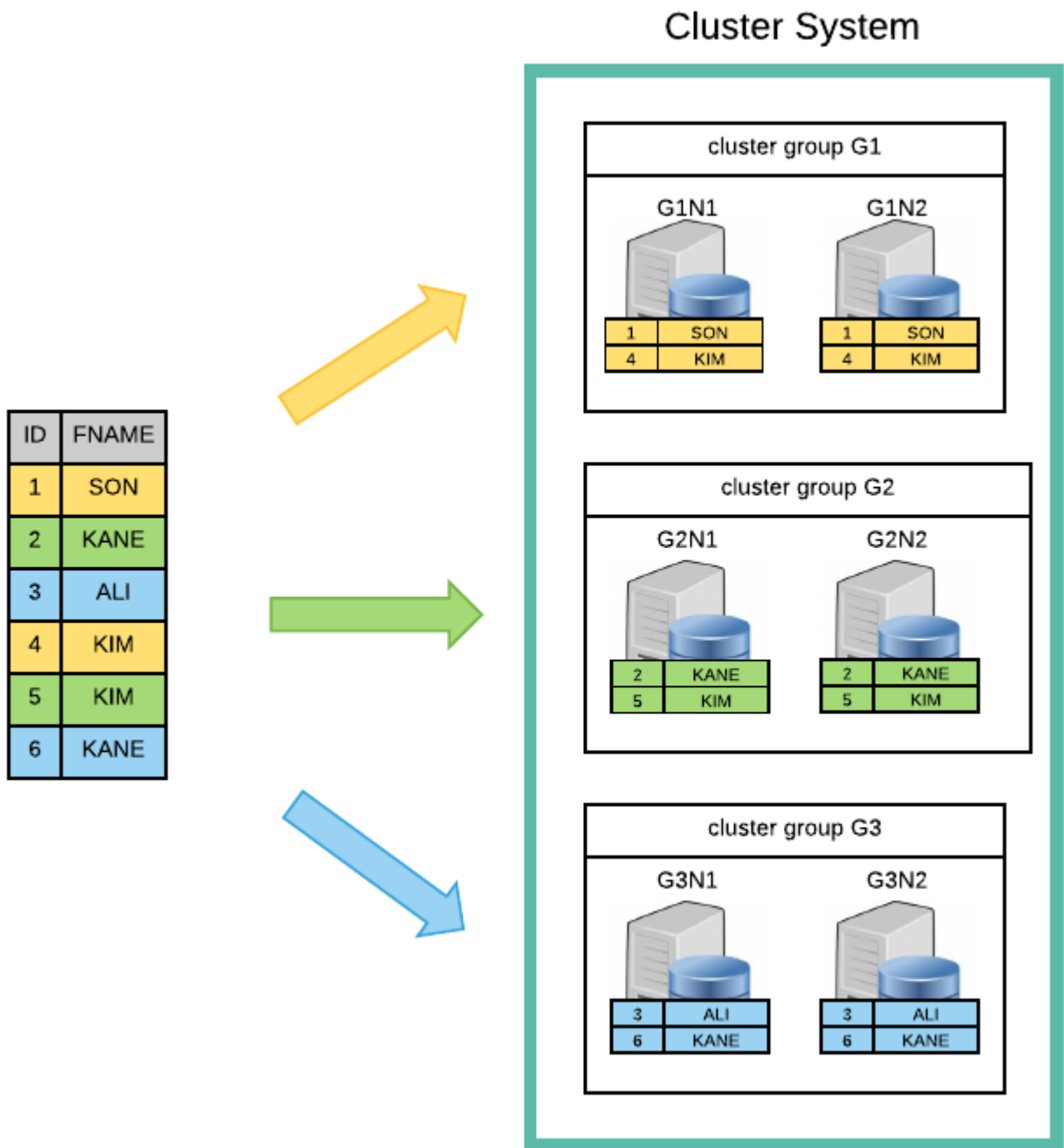

The table data is sharded and placed in each cluster group according to the sharding strategy defined by a user. (According to the ID column in the figure above) The placed data in a cluster group maintains the replication of a cluster member in a cluster group.

Availability of Cluster System

Cluster continues to provide service even when a specific server is broken or the network is cut. Cluster members configuring each cluster group maintain the same data replications, so the service does not stop even when a single cluster member is broken. In other words, unless the data is lost due to the malfunction of all cluster members in a cluster group, the service continues to be provided.

The cluster continues to provide service even when three devices are broken in the 3x2 cluster as follows.

Figure 3 Cluster availability

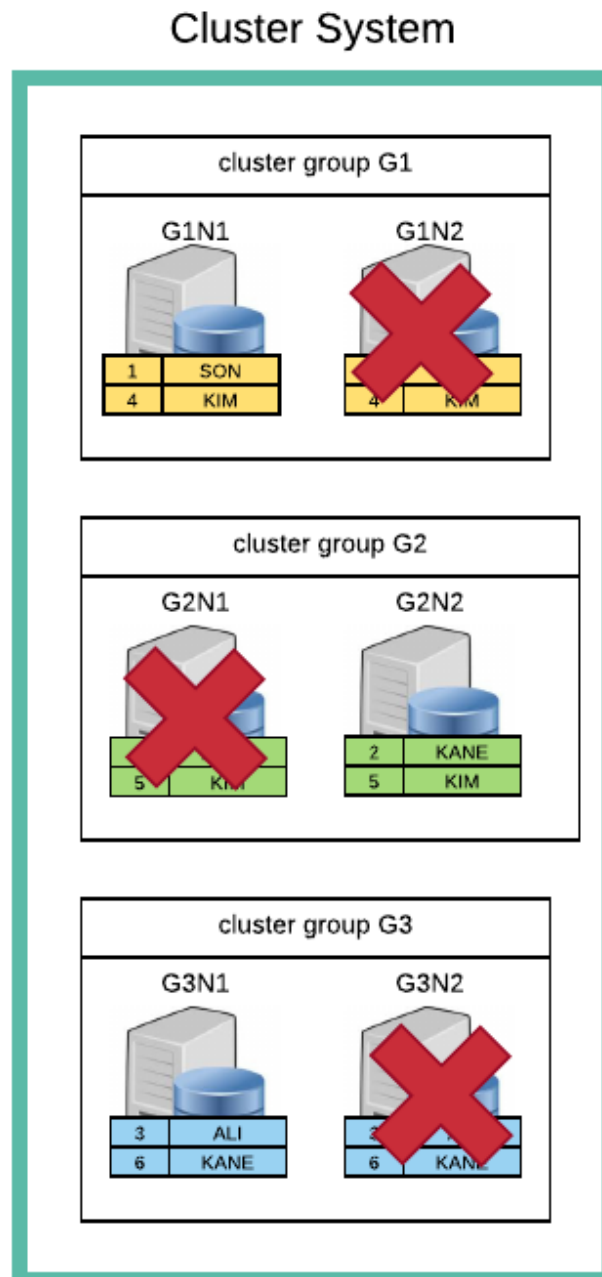

If an additional errors occur in G1N1, G2N2, G3N1 in the situation above, then the data loss occurs and t

he service can not be provided any more. Therefore, a user should make the broken device to participate in a cluster system, or add a new cluster member before an additional error occurs.

- **ALTER SYSTEM JOIN DATABASE** statement is used to make the broken cluster member to participate in a cluster system again.
- **ALTER DATABASE DROP INACTIVE CLUSTER MEMBERS** statement is used to drop the broken cluster member from the cluster system.
- **ALTER CLUSTER GROUP name ADD MEMBER** statement is used to add a cluster member to a cluster group for the high availability.
- **ALTER DATABASE REBALANCE** statement and **ALTER TABLE name REBALANCE** statement are used to rebalance data to a newly added cluster member.

Expanding Cluster System

The cluster can be expanded by adding a new server without stopping the service.

Cluster is expanded by adding a cluster member or a cluster group and by rebalancing the data to a created server.

The following is an example of expanding a 2x1 cluster to a 3x2 cluster.

Figure 4 Expanding cluster system

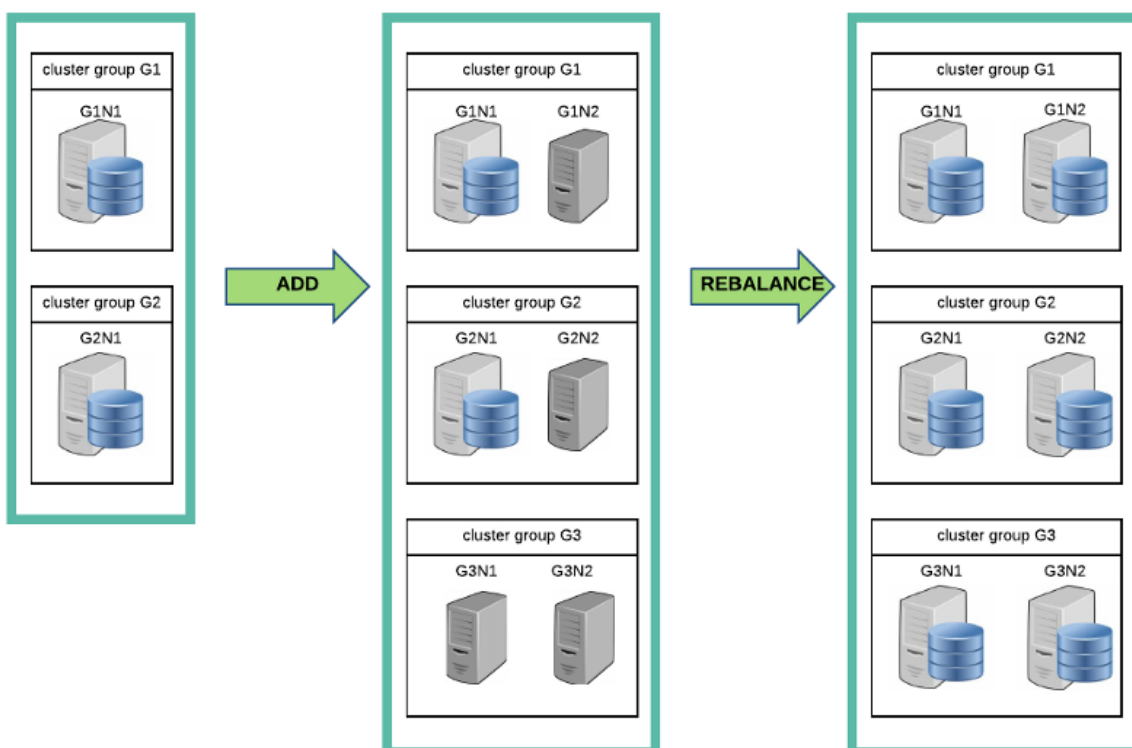

Add a cluster group and a cluster member by using the following statements to expand a cluster.

- **ALTER CLUSTER GROUP name ADD MEMBER**
- **CREATE CLUSTER GROUP**

To add a new cluster member to the cluster system, tablespaces in the cluster member and those in the cluster system should be same. In other words, tablespaces as same as all tablespaces in the cluster system should be created in the cluster member.

The following is an example of adding a cluster group and a cluster member of the 3x2 cluster to the 2x1 cluster. Add the member G1N2 to the group G1, and add the member G2N2 to the group G2. Then, create the group G3 including the members (G3N1, G3N2).

- Add the member G1N2 to the group G1.

```
gSQL>
ALTER CLUSTER GROUP G1
      ADD CLUSTER MEMBER G1N2 HOST '192.168.0.12' PORT 10120;
Cluster Group altered.
```

- Add the member G2N2 to the group G2.

```
gSQL>
ALTER CLUSTER GROUP G2
      ADD CLUSTER MEMBER G2N2 HOST '192.168.0.22' PORT 10220;
Cluster Group altered.
```

- Create the group G3.

```
gSQL>
CREATE CLUSTER GROUP G3
      CLUSTER MEMBER G3N1 HOST '192.168.0.31' PORT 10310,
      CLUSTER MEMBER G3N2 HOST '192.168.0.32' PORT 10320;
Cluster Group created.
```

The cluster group and the cluster member which are newly added to the cluster system can provide the service by synchronizing the dictionary information of the SQL object. However, the data is not yet placed in the added cluster member, so the availability can not be increased nor can the load balancing be expected. Therefore, the data should be rebalanced to the created cluster member for the high availability and the load balancing.

Use the following statements sequentially to rebalance the data.

- **ALTER DATABASE REBALANCE**

- **ALTER TABLE name REBALANCE**

The following is an example of rebalancing data to all tables in the database.

```
gSQL> ALTER DATABASE REBALANCE;  
Database altered.
```

14.2 Cluster Group

Cluster Group Related Statements

For more information about creating, dropping, and altering a cluster group, refer to the followings.

- Creating a cluster group: **CREATE CLUSTER GROUP**
- Dropping a cluster group: **DROP CLUSTER GROUP**
- Altering a cluster group: **ALTER CLUSTER GROUP name ADD MEMBER**

Information which is related to a cluster group can be retrieved through the following views.

Table 14-2 Cluster group related information

Schema	View	Description
DICTIONARY_SCH EMA	DBA_CLUSTER	Object information of a cluster group and a cluster member which c onfigure the cluster
	DBA_CLUSTER_COM MENTS	Comment information of a cluster group and a cluster member

Concepts of Cluster Group

At least one cluster group should be created to run the cluster system.

Creating Cluster Group

The first created cluster group should include itself as a cluster member. For more information about crea
ting a cluster group, refer to **CREATE CLUSTER GROUP**.

A cluster member is a physical concept meaning the data server, but a cluster group is a logical concept c
onsisting of one or more cluster members.

The availability and load balancing of the cluser system depends on the configuration of the cluster group.
The more cluster member the cluster group includes the higher the availability. The more the number of t
he cluster groups the bigger the throughput of the cluster system because the data is distributed.

All cluster members in a cluster group maintain the same data replications, so it can continuously provide
s the service unless an error occurs in all cluster members configuring a cluster group. It is recommended
to configure the cluster group with two or more cluster members to maintain the availability of the cluste

r system.

The table data is sharded according to the sharding strategy, and it is stored and managed in each different cluster group according to the shard placement strategy. An appropriate table sharding strategy and the placement strategy according to the service feature determines the entire system performance. Each transaction and query is processed focusing on a cluster group in which the data is stored, so the performance is improved if the referenced data exist in the same cluster group.

Dropping Cluster Group

The cluster group participating in a cluster system and providing a service can be dropped for various reasons. For more information about dropping the cluster group, refer to **DROP CLUSTER GROUP**.

To drop the cluster group, all shards in a sharded table which is created in that cluster group should be transferred to another cluster group. It should be transferred separately according to cluster-wide, group-specific table.

14.3 Cluster Member

Cluster Member Related Statements

For more information, refer to the followings.

- Adding a cluster member: **ALTER CLUSTER GROUP name ADD MEMBER**
- Dropping a cluster member: **ALTER DATABASE DROP INACTIVE CLUSTER MEMBERS**
- Controlling a cluster member
 - **ALTER SYSTEM JOIN DATABASE**
 - **ALTER CLUSTER GROUP name OFFLINE MEMBER**
 - **ALTER DATABASE RESET LOCAL CLUSTER MEMBER**

Information which is related to a cluster member can be retrieved through the following views.

Table 14-3 Cluster member related information

Schema	View	Description
DICTIONARY_SCHEMA	DBA_CLUSTER	Object information of a cluster group and a cluster member which configure a cluster
	DBA_CLUSTER_COMMENTS	Comment information of a cluster group and a cluster member
PERFORMANCE_VIEW_SCHEMA	V\$CLUSTER_MEMBER	Status information of a cluster member

Concepts of Cluster Member

The cluster member is a server configuring a cluster system, and it maintains the replications as same as those of cluster member in a cluster group.

The cluster member is a data server storing a part of the cluster database data, and it is also an application server processing the connection and request of an application. Moreover, it is a meta server duplicating and managing the meta information. In other words, GOLDILOCKS cluster does not require any data server, application server, or meta server.

Cluster members which belong to the same cluster group have the same data replications. Therefore, an error in a specific cluster member does not cause an error in the entire system. It is recommended to include two or more cluster members in each cluster group for the high availability of the system. A single cluster group can be configured with maximum 32 cluster members.

Perform **ALTER CLUSTER GROUP name ADD MEMBER** statement to add a new cluster member to a cluster group.

The added cluster member maintains the meta information of the SQL object as same as that in the cluster system, so it can process the connection and request of the application. However, the data is not placed, so adding a cluster member does not guarantee the high availability of the cluster group.

Perform the following statements to place the data after adding a cluster member.

- The placement of the entire data: Refer to **ALTER DATABASE REBALANCE**.
- The placement of only a part of the table: **ALTER TABLE name REBALANCE**.

When an error occurs on a cluster member, service is continuously provided but DDL can not be performed. For a normal service operation, an appropriate action should be taken for the cluster member with an error.

To make the cluster member with an error to participate in the cluster system again, then perform **ALTER SYSTEM JOIN DATABASE** statement after connecting to the cluster member and driving up to the LOCAL OPEN phase.

Even when a part of cluster members are not driven or the cluster system is driven while the network is disconnected, perform **ALTER SYSTEM JOIN DATABASE** statement after driving up the cluster member to the LOCAL OPEN phase.

If the cluster member device with an error can not be restored, then drop that cluster member by performing **ALTER DATABASE DROP INACTIVE CLUSTER MEMBERS** statement in the cluster system.

The cluster member dropped from the cluster system still includes the previous information, and it can not participate in the cluster system again. Perform **ALTER DATABASE RESET LOCAL CLUSTER MEMBER** statement to reset the cluster member to when it is before participating in the cluster system.

The statement above is different from newly creating the database of the cluster member because it maintains the tablespace information. Therefore, it can shorten the time to create the tablespace when adding a new cluster member to the cluster system.

14.4 Cluster Location

Cluster Location Related Statements

For more information about creating, dropping, and altering a cluster location, refer to the followings.

- Creating a cluster location: **CREATE CLUSTER LOCATION**
- Dropping a cluster location: **DROP CLUSTER LOCATION**
- Altering a cluster location: **ALTER CLUSTER LOCATION**

Information which is related to a cluster location can be retrieved through the following views.

Table 14-4 Cluster location related information

Schema	View	Description
PERFORMANCE_VIEW_SCHEMA	V\$CLUSTER_LOCATION	Information of cluster location

Concepts of Cluster Location

Cluster location is a connection information to connect the internal cluster networks of each cluster member registered on the cluster system. Each cluster members use the cluster-exclusive tcp network to transfer and receive various protocols such as the transaction processing and the exchanging the management information. In this case, the member name, host ip address, and port are used for the connection and they are called as a cluster location by the lump.

A unique cluster location information should be specified for each member, and if the information is duplicate, then the cluster network connection fails and the cluster system does not operate normally.

Cluster location information is automatically added or deleted when adding or dropping a cluster member, so a user rarely need to directly and solely add or delete the location information. However, DDL statement related to the cluster location can be used in the following case.

- When the cluster location information is lost due to the deleted location control file: **CREATE CLUSTER LOCATION**
- When the previously registered connection information of the cluster member is altered, which means that the hardware or the connected ip and port is altered: **ALTER CLUSTER LOCATION**

14.5 Cluster Table and Shard

Shard Related Statements

For more information about definition and rebalance of the shard, refer to the followings.

- Definition of a shard: <table sharding strategy> clause of **CREATE TABLE**.
- Rebalancing a shard: **ALTER TABLE name REBALANCE**

Information which is related to a shard in a cluster table can be retrieved through the following views.

Table 14-5 Shard in a cluster table related information

Schema	View	Description
DICTIONARY_SCHEMA	ALL_CLUSTER_TABLES	Information of user accessible cluster table
	ALL_SHARD_KEY_COLUMNS	Shard key column information of user accessible cluster table
	ALL_TAB_PLACE	Placement information of user accessible cluster table
	ALL_TAB_SHARDS	Shard information of user accessible cluster table
	USER_CLUSTER_TABLES	Information of user owned cluster table
	USER_SHARD_KEY_COLUMNS	Shard key column information of user owned cluster table
	USER_TAB_PLACE	Placement information of user owned cluster table
	USER_TAB_SHARDS	Shard information of user owned cluster table

Cluster Table Type

A table which is created by a user in a cluster environment is one of the followings.

- Cloned table: Equally duplicating the table data and managing it
- Sharded table: Horizontally sharding the table data and managing it

A cloned table is appropriate for a table such as a product list or a provider list whose data is relatively small and is not often altered, because a cloned table duplicates all table data and manages it. When inserting, deleting, updating data to the cloned table, they are applied same to all cluster members to which the cloned table is placed.

A sharded table is appropriate for a table such as a transaction history or a call history whose data is big so required to be sharded. They are classified according to three sharding strategies as follows.

- Hash sharded table
 - It divides the table data into several shards based on the hash value of a sharding key, then places them in the cluster system.
- Range sharded table
 - It divides the table data into several shards based on the range value of a sharding key, then places them in the cluster system.
- List sharded table
 - It divides the table data into several shards based on the list value of a sharding key, then places them in the cluster system.

A sharded table horizontally divides rows and manages them in shard unit, the sharding strategy is defined by using the SHARDING BY clause in **CREATE TABLE** statement. The row set classified by the sharding strategy is called as shard.

Each shard is placed in a cluster group according to the placement strategy defined by a user. A shard can automatically be placed by using AT CLUSTER WIDE of **CREATE TABLE**, or a cluster group to place a shard can be specified by using AT CLUSTER GROUP clause. When a shard is automatically placed by using AT CLUSTER WIDE, **ALTER TABLE name REBALANCE** is performed after creating the cluster group by using **CREATE CLUSTER GROUP**. However, when specifying a cluster group to allocate a shard, the shard is not placed in the newly created cluster group.

The following is an example of creating a table according to the cluster table type and placing the data in the 3x2 cluster environment.

Cloned Table

A cloned table equally duplicates the table data and manages it.

The following is an example of creating a cluster-wide cloned table. All table data is equally duplicated and placed in 3x2 cluster members.

```
CREATE TABLE t1 ( id INTEGER )
  CLONED
  AT CLUSTER WIDE
;
```

Figure 5 Cluster-wide cloned table

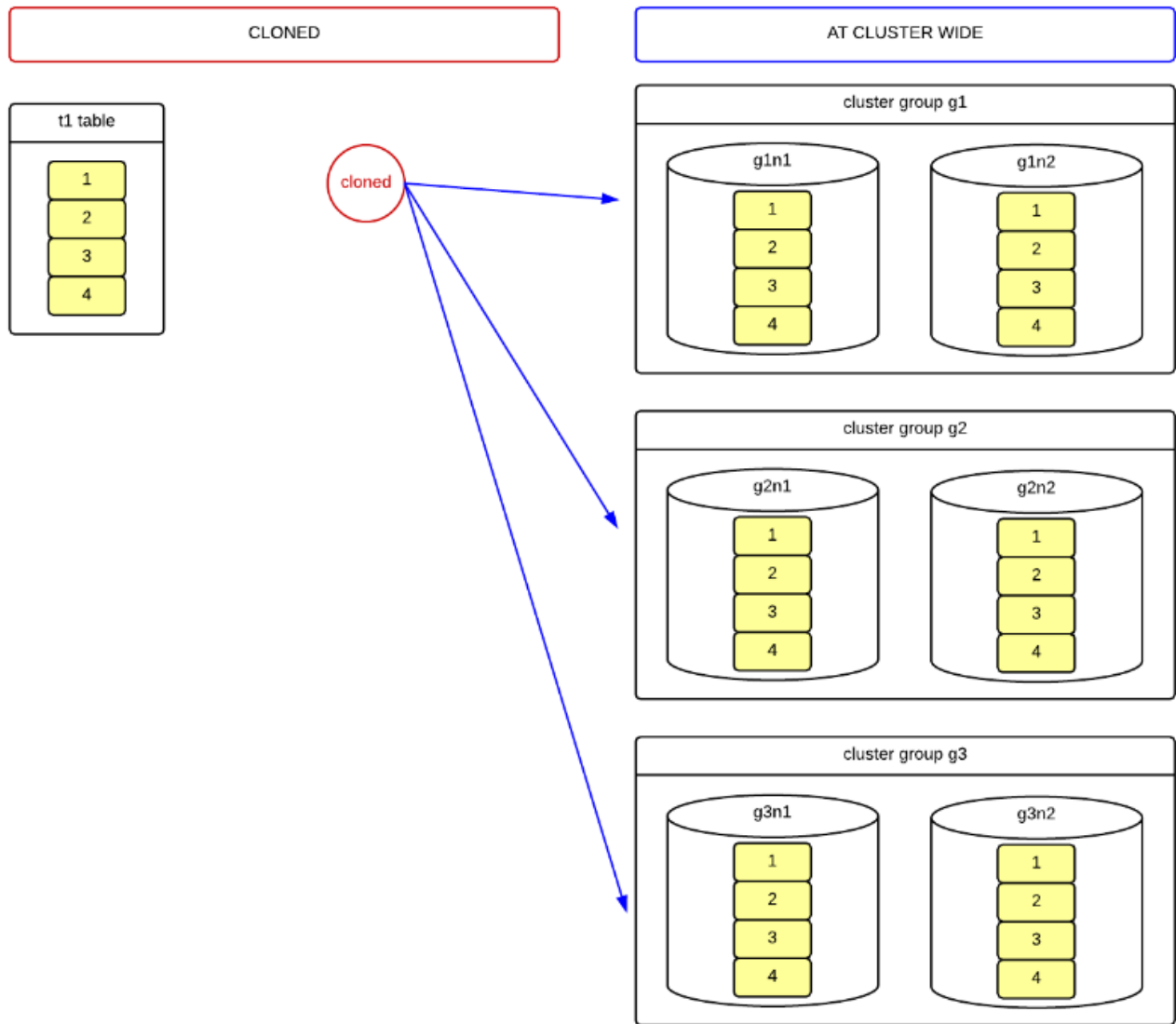

The following is an example of creating a group-specific cloned table. All table data is equally duplicated and managed, but the duplicated table data exists only in cluster members of group g1 and g2 which are specified by a user, but it does not exist in a group g3.

```
CREATE TABLE t1 ( id INTEGER )
  CLONED
  AT CLUSTER GROUP g1, g2
;
```

Figure 6 Group-specific cloned table

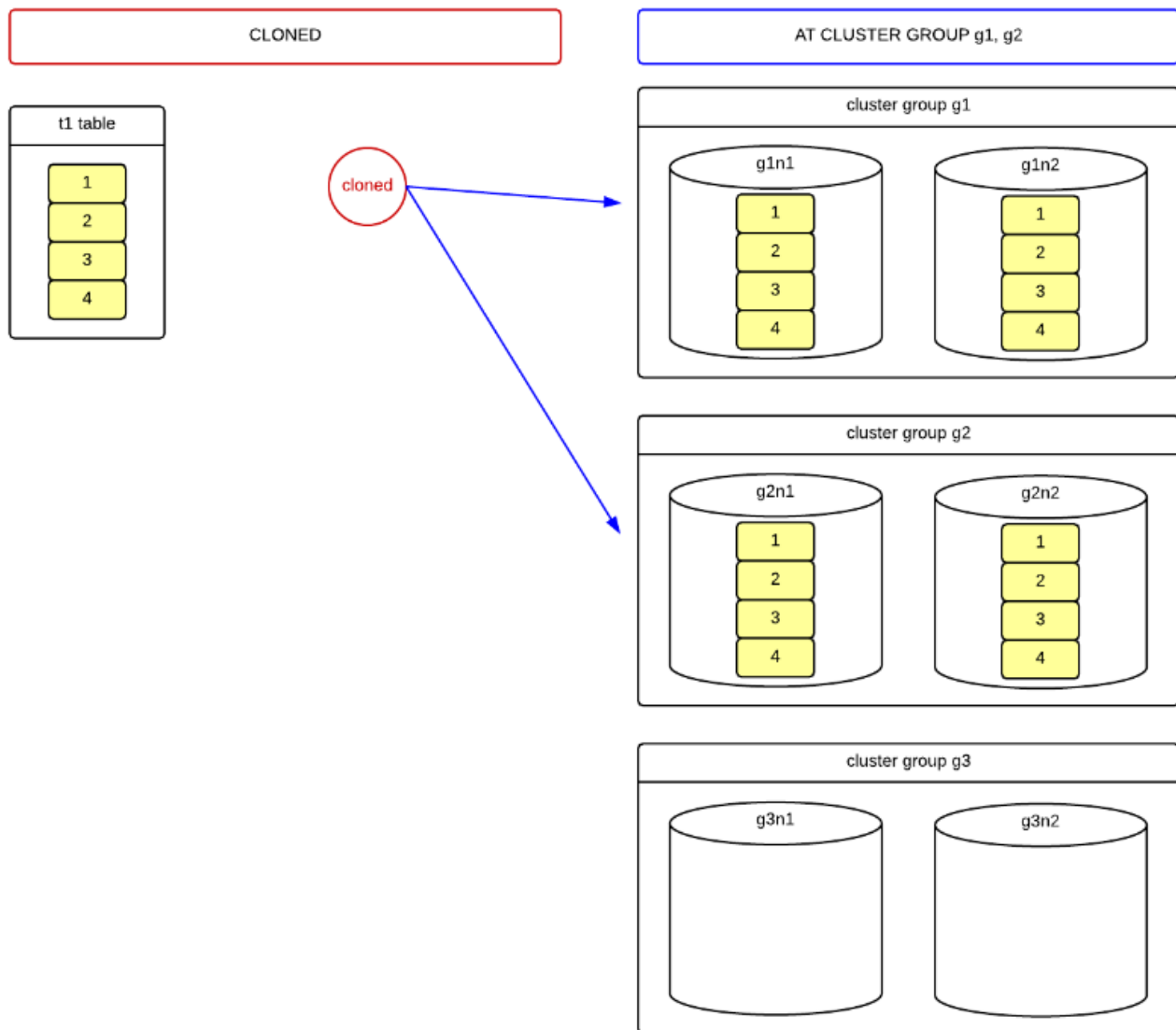

Hash-sharded table

A hash-sharded table divides the table data into several shards based on the hash value of a sharding key, then places them in the cluster system.

The following is an example of creating the cluster-wide hash-sharded table. When adding data to a table, the hash value is created based on the ID column value, and the shard to place row is selected among five shards by using the hash value. Each shard is automatically placed. All rows with the same ID column value are included in the same shard, and placed in the same cluster group.

```
CREATE TABLE t1 ( id INTEGER )
  SHARDING BY HASH(id)
  SHARD COUNT 5
```

```
AT CLUSTER WIDE
```

```
;
```

Figure 7 Cluster-wide hash-sharded table

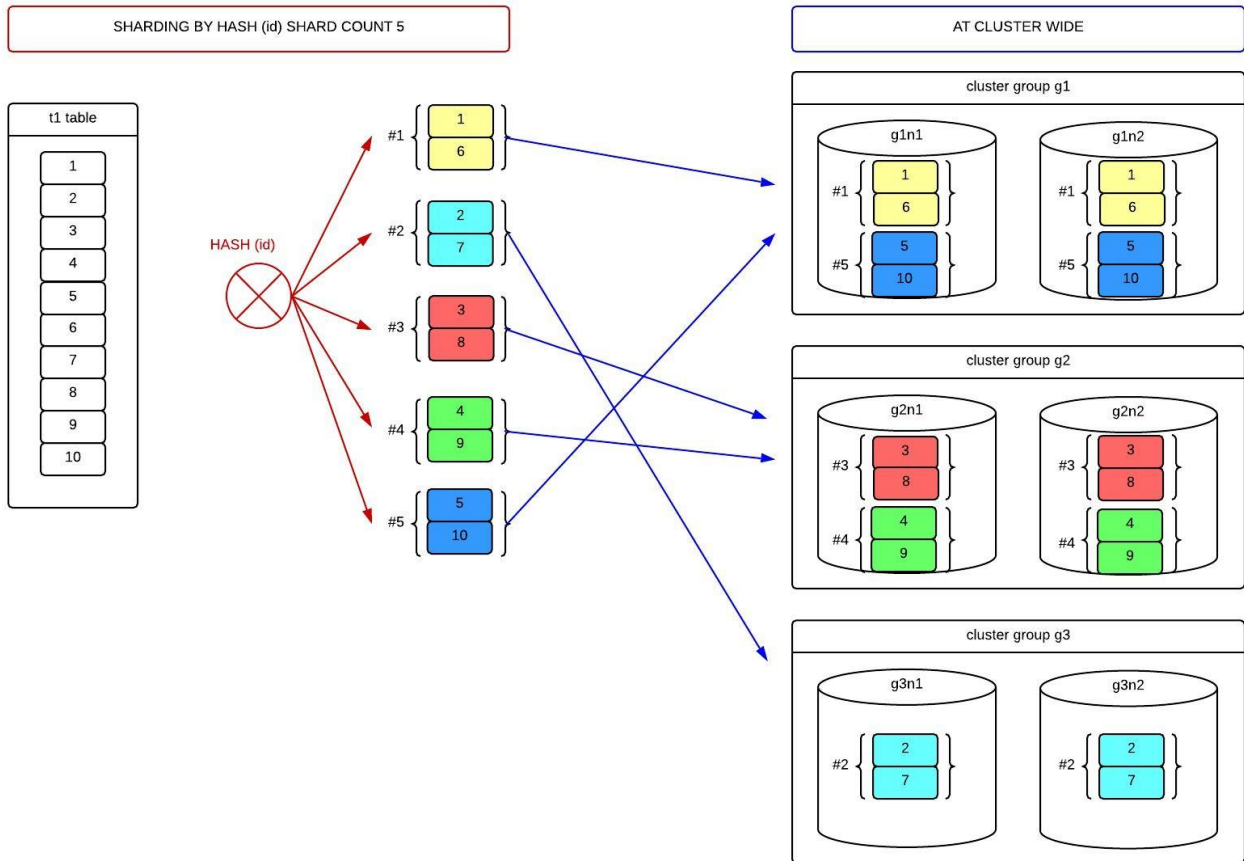

The following is an example of creating the group-specific hash-sharded table. The hash value of an ID column determines the shard, but each shard is placed only in the cluster group g1 and g2 which are specified by a user.

```
CREATE TABLE t1 ( id INTEGER )
  SHARDING BY HASH(id)
  SHARD COUNT 5
  AT CLUSTER GROUP g1, g2
;
```

Figure 8 Group-specific hash-sharded table

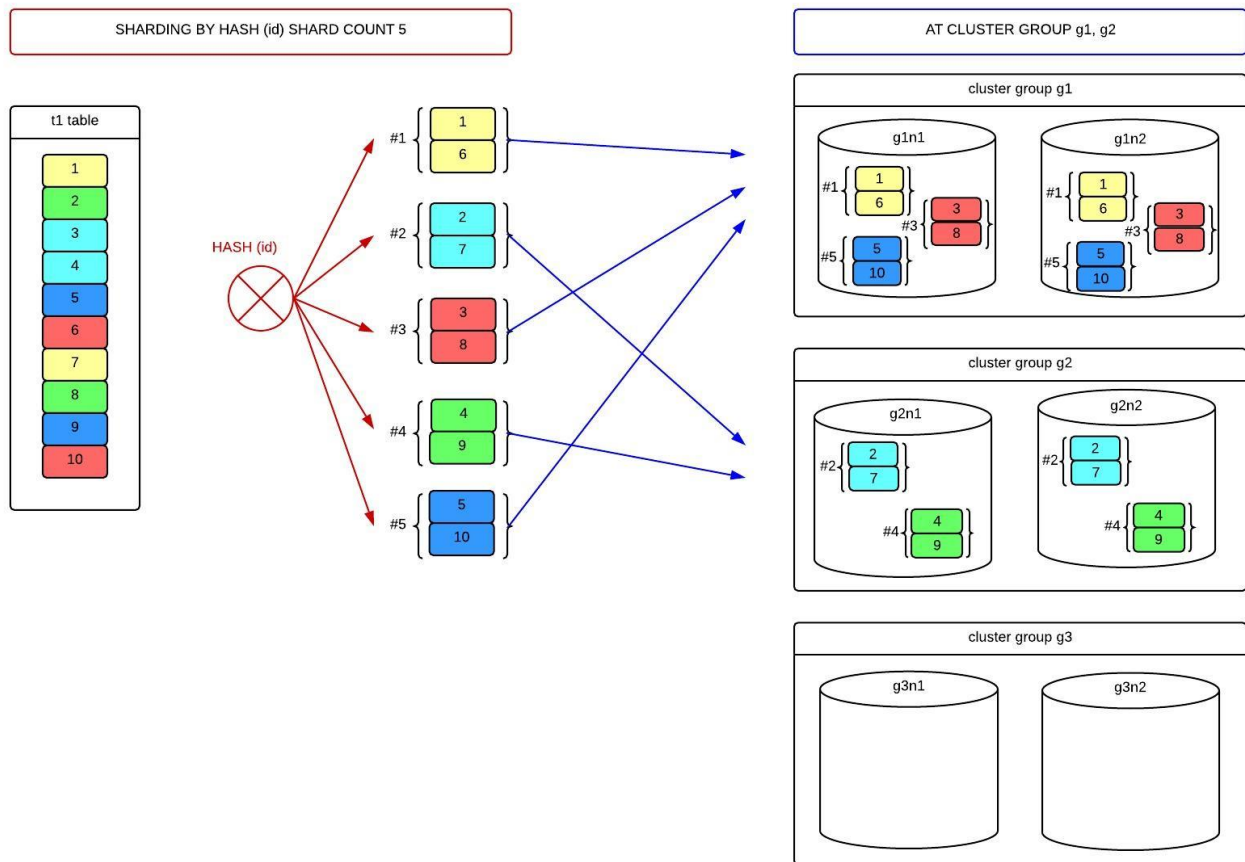

Range-sharded Table

A range-sharded table divides the table data into several shards based on the range value of a sharding key, then places them in the cluster system.

The following is an example of creating the cluster-wide range-sharded table. When adding data to a table, the shard to place row is selected among five shards based on the range value of the ID column. Each shard is automatically placed. All rows of the ID column within the same range are included in the same shard, and placed in the same cluster group.

```
CREATE TABLE t1 ( id INTEGER )
  SHARDING BY RANGE(id)
  AT CLUSTER WIDE
    SHARD s1 VALUES LESS THAN ( 20 ),
    SHARD s2 VALUES LESS THAN ( 40 ),
    SHARD s3 VALUES LESS THAN ( 60 ),
    SHARD s4 VALUES LESS THAN ( 80 ),
    SHARD s5 VALUES LESS THAN ( MAXVALUE )
```

;

Figure 9 Cluster-wide range-sharded table

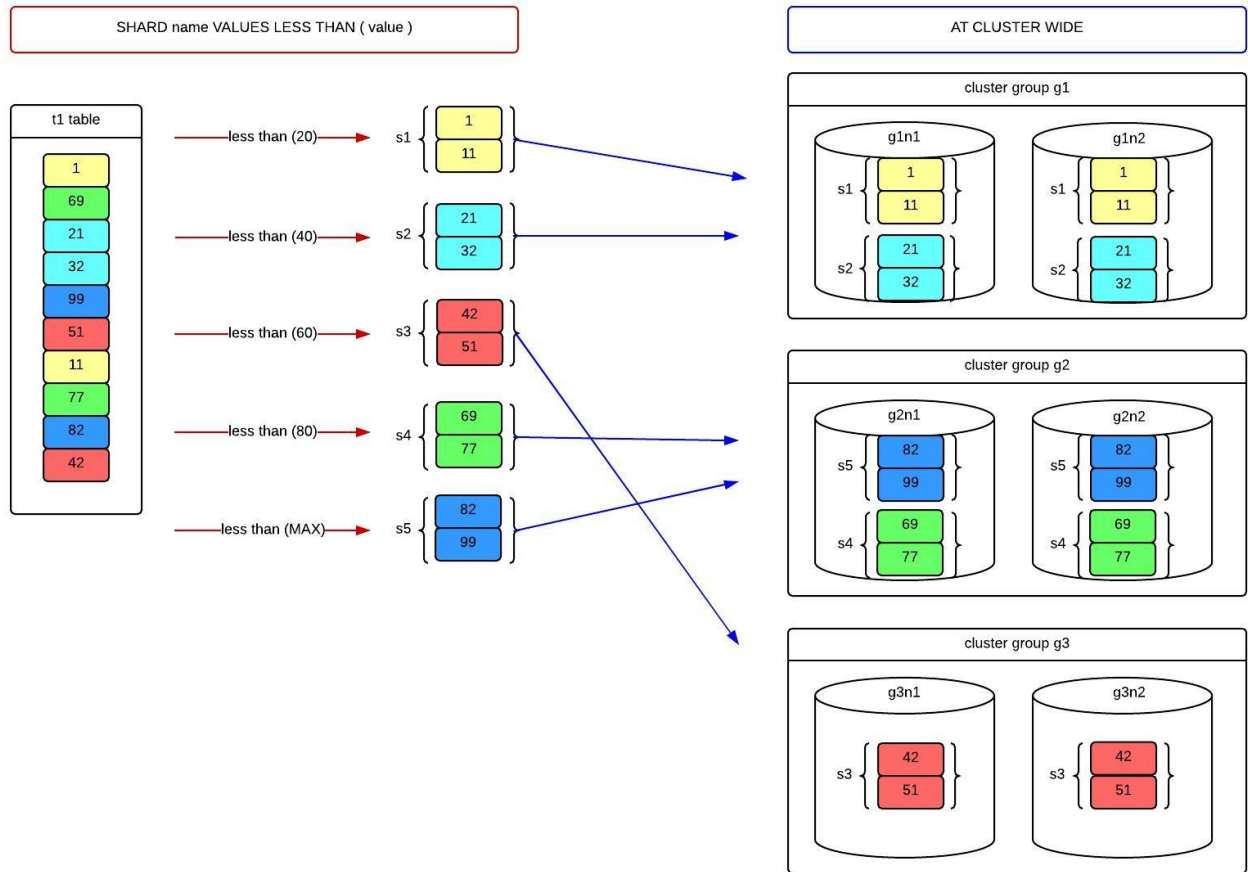

The following is an example of creating the group-specific range-sharded table. The range value of the ID column defines the shard, but each shard is placed in a cluster group specified by a user.

```
CREATE TABLE t1 ( id INTEGER )
SHARDING BY RANGE(id)
  SHARD s1 VALUES LESS THAN ( 20 )      AT CLUSTER GROUP g1,
  SHARD s2 VALUES LESS THAN ( 40 )      AT CLUSTER GROUP g2,
  SHARD s3 VALUES LESS THAN ( 60 )      AT CLUSTER GROUP g1,
  SHARD s4 VALUES LESS THAN ( 80 )      AT CLUSTER GROUP g2,
  SHARD s5 VALUES LESS THAN ( MAXVALUE ) AT CLUSTER GROUP g3
;
```

Figure 10 Group-specific range-sharded table

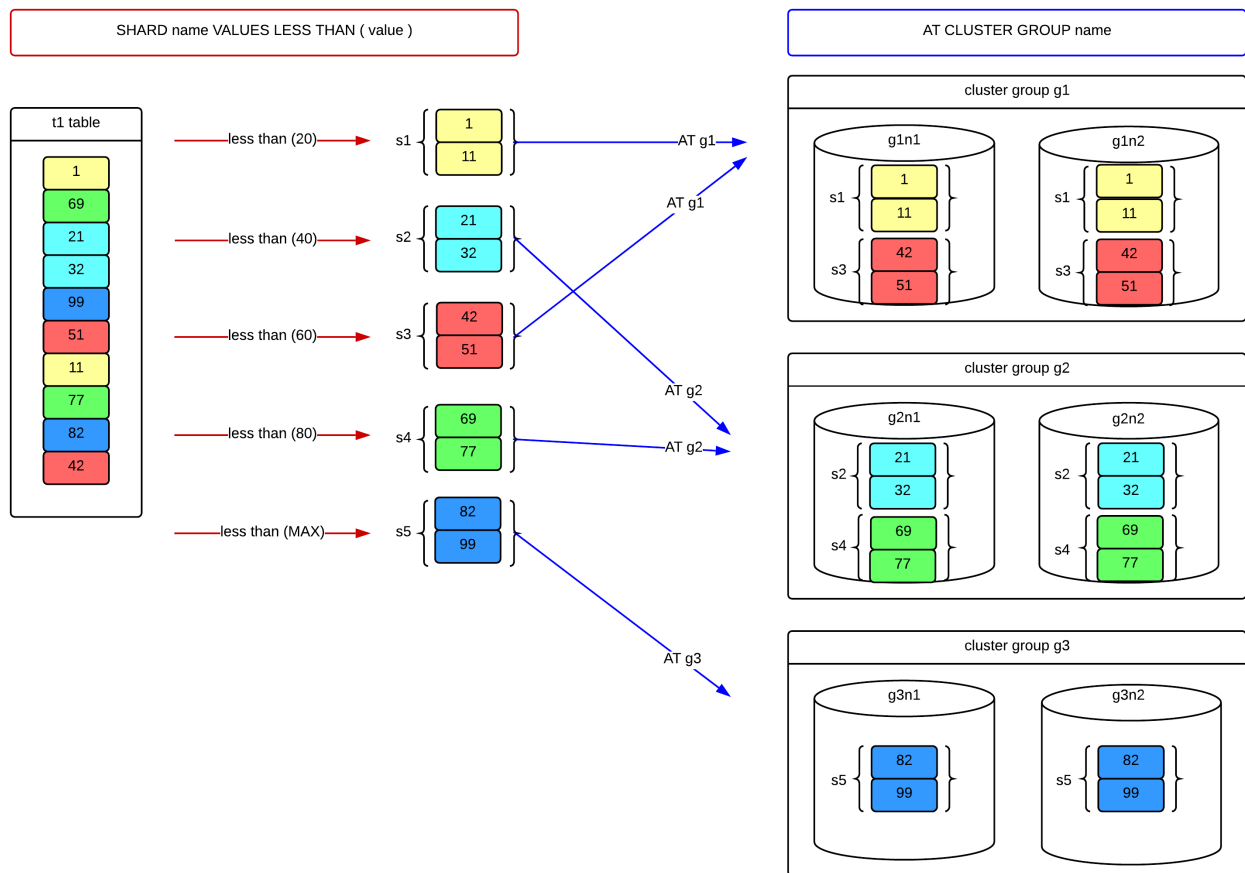

List-sharded Table

A list-sharded table divides the table data into several shards based on the list value of a sharding key, then places them in the cluster system.

The following is an example of creating the cluster-wide list-sharded table. When adding data to a table, rows are placed in a shard with the list value as same as the CITY column value. Each shard is automatically placed.

```
CREATE TABLE t1 ( city VARCHAR(128) )
  SHARDING BY LIST (city)
  AT CLUSTER WIDE
  SHARD s1 VALUES IN ( 'seoul' ),
  SHARD s2 VALUES IN ( 'busan', 'ulsan' ),
  SHARD s3 VALUES IN ( 'suwon', 'ansan', 'osan' ),
  SHARD s4 VALUES IN ( 'goyang', 'paju', 'guri' ),
  SHARD s5 VALUES IN ( DEFAULT )
```

Figure 11 Cluster-wide list-sharded table

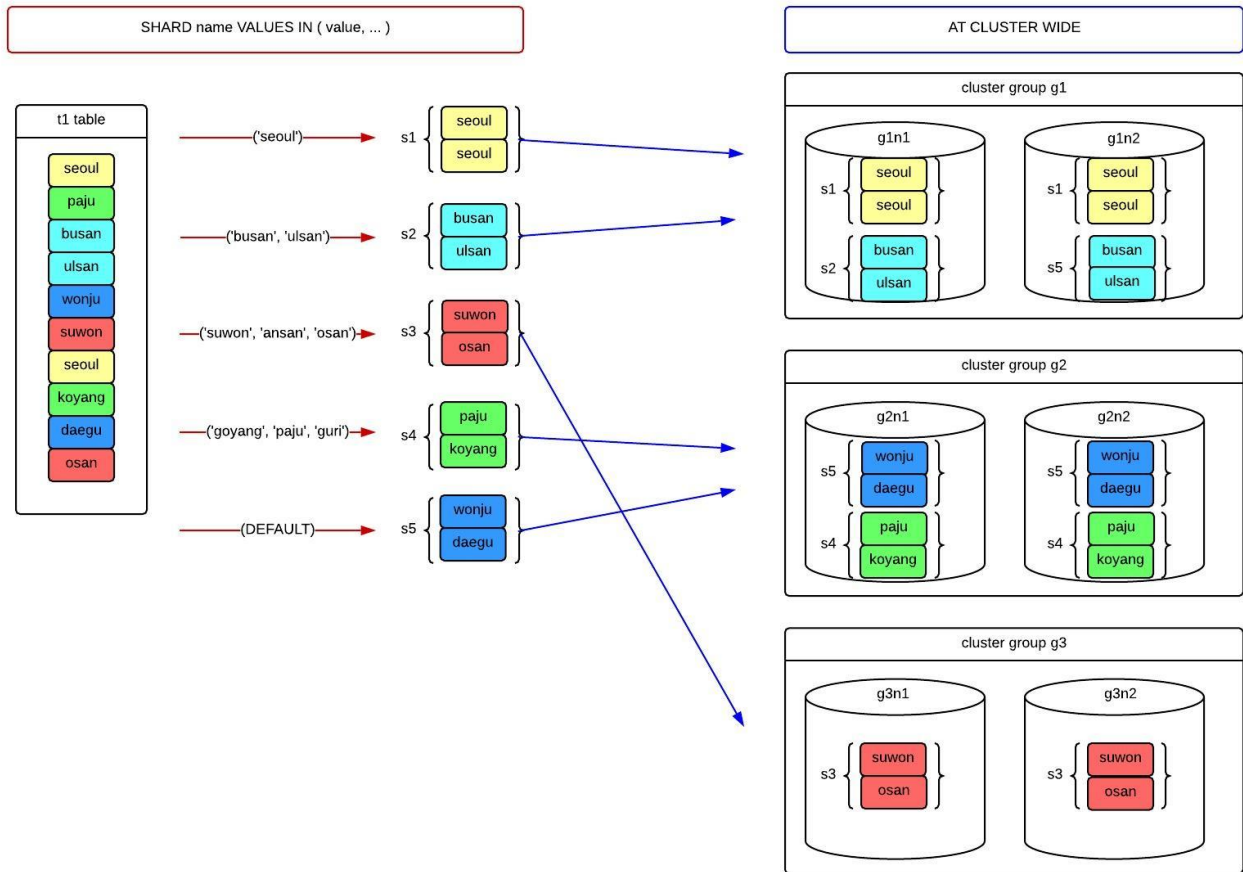

The following is an example of creating the group-specific list-sharded table. The shard is selected by the 1st value of the CITY column, but each shard is placed in the cluster group specified by a user.

```

CREATE TABLE t1 ( city VARCHAR(128) )
SHARDING BY LIST (city)
  SHARD s1 VALUES IN ( 'seoul' )           AT CLUSTER GROUP g1,
  SHARD s2 VALUES IN ( 'busan', 'ulsan' )  AT CLUSTER GROUP g2,
  SHARD s3 VALUES IN ( 'suwon', 'ansan', 'osan' ) AT CLUSTER GROUP g1,
  SHARD s4 VALUES IN ( 'goyang', 'paju', 'guri' ) AT CLUSTER GROUP g2,
  SHARD s5 VALUES IN ( DEFAULT )          AT CLUSTER GROUP g3
;

```

Figure 12 Group-specific list-sharded table

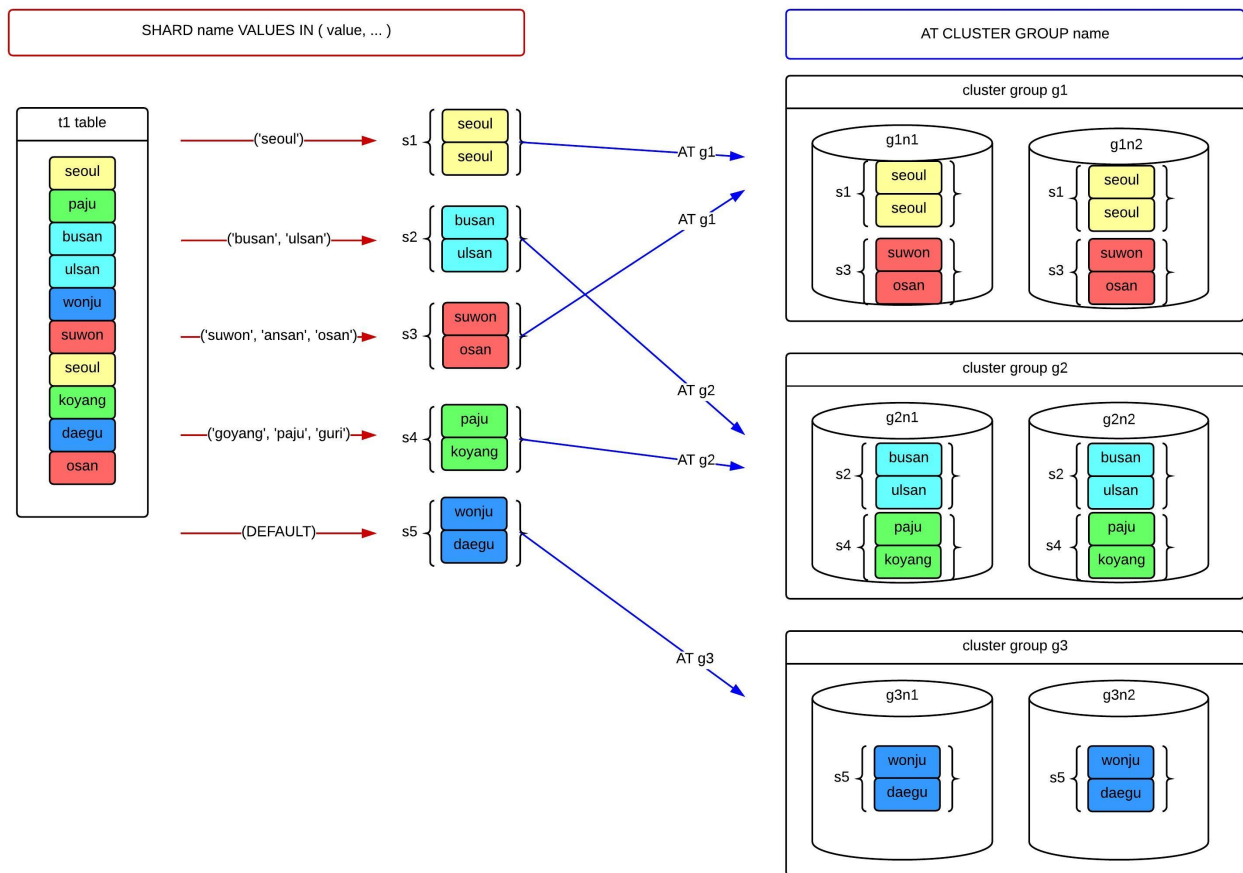

Rebalancing Cluster Table

Rebalance the data of the cluster table by using **ALTER TABLE name REBALANCE** statement.

Data of the cluster table is rebalanced in the following unit.

- Cloned table: The entire table
- Sharded table: shard unit

If the table is specified as **AT CLUSTER WIDE**, the shard is automatically rebalanced to the created cluster group, but if the cluster group to place the shard is specified by **AT CLUSTER GROUP**, the shard is not rebalanced to the created cluster group.

- When automatically rebalancing by using **AT CLUSTER WIDE**, then the data can be rebalanced to a new cluster group and a new cluster member.

```
CREATE TABLE region
(
  r_regionkey  INTEGER
, r_name      CHAR(25)
, r_comment   VARCHAR(152)
)
CLONED
AT CLUSTER WIDE;
```

Figure 13 Rebalancing the region table defined by AT CLUSTER WIDE

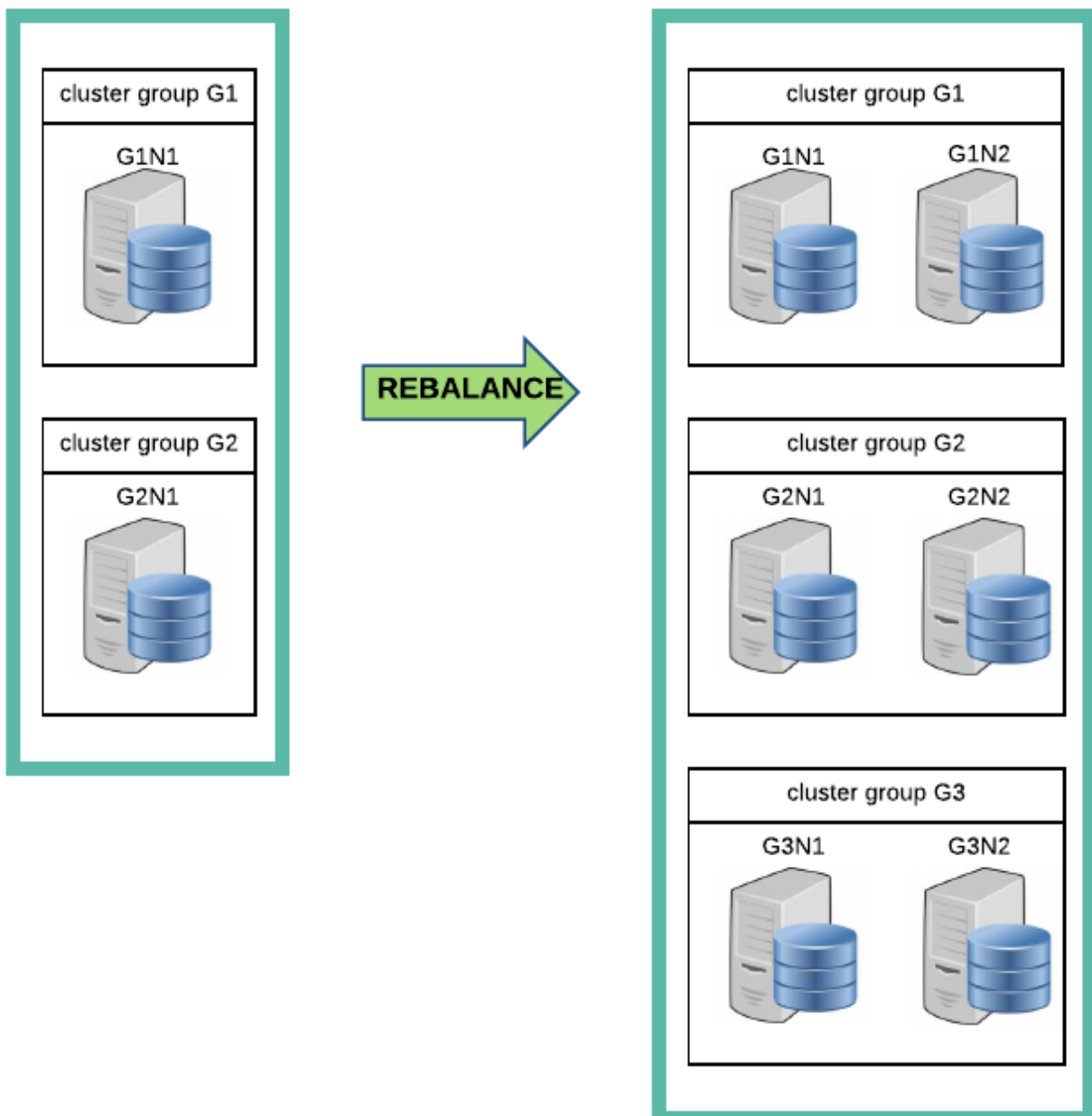

- When specifying the location to place the shard by using AT CLUSTER GROUP

- The data is not rebalanced on the new cluster group.
- The data can be rebalanced on the new cluster member which is added to the specified cluster group.

```
CREATE TABLE nation
(
  n_nationkey  INTEGER
, n_name      CHAR(25)
, n_regionkey INTEGER
, n_comment   VARCHAR(152)
)
CLONED
AT CLUSTER GROUP g1, g2;
```

Figure 14 Rebalancing the nation table defined by AT CLUSTER GROUP

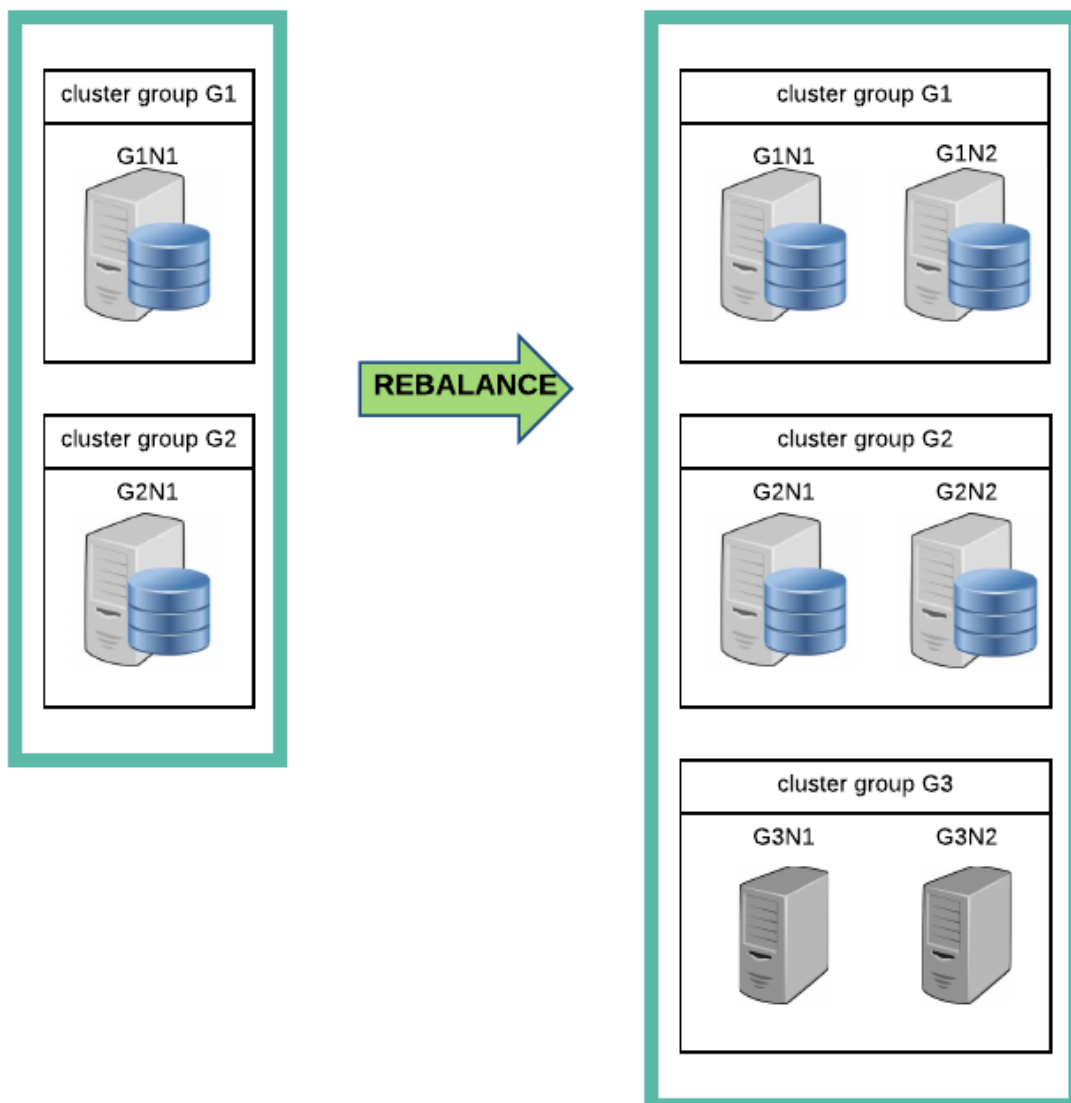

Information about the table placement can be retrieved through the following views.

- `USER_TAB_PLACE`
- `ALL_TAB_PLACE`

```
gSQL>
SELECT group_name, member_name
   FROM user_tab_place
  WHERE table_name = 'REGION';
GROUP_NAME MEMBER_NAME
-----
G1          G1N1
G1          G1N2
G2          G2N1
G2          G2N2
G3          G3N1
G3          G3N2
6 rows selected.
```

The sharded table is rebalanced in shard unit, and rebalancing shards due to the increase of groups is as follows.

```
CREATE TABLE orders
(
  o_orderkey    INTEGER
, o_custkey    INTEGER
, o_orderstatus CHAR(1)
, o_totalprice  NUMERIC(12,2)
, o_orderdate   DATE
, o_orderpriority CHAR(15)
, o_clerk       CHAR(15)
, o_shippriority INTEGER
, o_comment     VARCHAR(79)
)
SHARDING BY HASH( o_orderkey )
SHARD COUNT 24
AT CLUSTER WIDE
;
```

Figure 15 Rebalancing shards due to the increase of groups

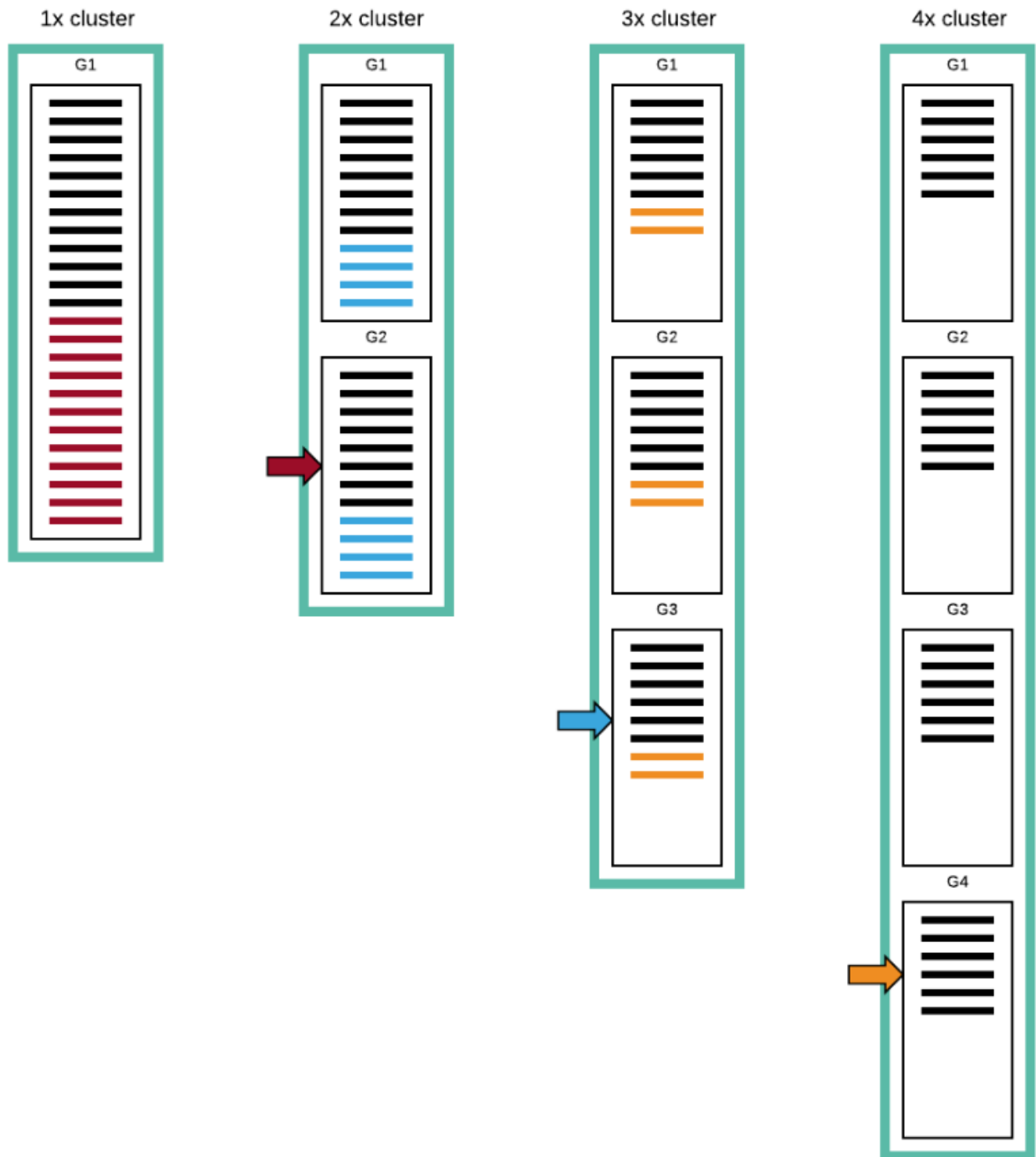

In the example above, the data of orders table is divided into 24 shards and placed. All shards are placed in a single group of 1x cluster which has only one group. 12 shards are placed in each group of 2x cluster which has two groups.

When expanding 2x cluster to 3x cluster, shards are transferred from an old group to the new group, but the number of shards in each group is same (8). When expanding 3x cluster to 4x cluster, then each G1, G2, G3 rebalances two shards to the newly created group G4.

In other words, the shard rebalancing minimize the movement when shards are transferred from an old g

roup to the new group, then data is equally rebalanced maintaining the same number of shards in each group.

Information about the shard placement of the sharded table can be retrieved through the following views.

- **USER_TAB_SHARDS**
- **ALL_TAB_SHARDS**

```
gSQL>
SELECT shard_name, group_name
   FROM user_tab_shards
  WHERE table_name = 'ORDERS';
SHARD_NAME  GROUP_NAME
-----
SHARD_000000 G1
SHARD_000001 G1
SHARD_000002 G1
SHARD_000003 G1
SHARD_000004 G1
SHARD_000005 G1
SHARD_000006 G1
SHARD_000007 G1
SHARD_000008 G3
SHARD_000009 G3
SHARD_000010 G3
SHARD_000011 G3
SHARD_000012 G2
SHARD_000013 G2
SHARD_000014 G2
SHARD_000015 G2
SHARD_000016 G2
SHARD_000017 G2
SHARD_000018 G2
SHARD_000019 G2
SHARD_000020 G3
SHARD_000021 G3
SHARD_000022 G3
SHARD_000023 G3
24 rows selected.
```

When tables which have the same <sharding strategy> are completely rebalanced as follows, then the sha

rd placement result is same. Rows with the same shard key is guaranteed to be placed in the same shard and the same group even when the tables are different.

- Table t1
 - It is created in the 2x cluster.
 - CREATE TABLE t1 (c1 INTEGER) SHARDING BY (c1);
 - It is rebalanced in the 4x cluster.
 - ALTER TABLE t1 REBALANCE:
- Table t2
 - It is created in the 3x cluster.
 - CREATE TABLE t2 (a1 INTEGER) SHARDING BY (a1);
 - It is rebalanced in the 4x cluster.
 - ALTER TABLE t2 REBALANCE:
- Table t3
 - It is created in the 4x cluster.
 - CREATE TABLE t3 (i1 INTEGER) SHARDING BY (i1);

In other words, the following query can access only to a single cluster member and process it.

```
SELECT COUNT(*)  
  FROM t1, t2, t3  
 WHERE t1.c1 = t2.a1  
       AND t2.a1 = t3.i1  
       AND t1.c1 = 1;
```

14.6 Global Secondary Index

Global Secondary Index Related Statements

For more information about creating, dropping, and altering a global secondary index, refer to the following.

- Creating a global secondary index: **ALTER TABLE name ADD GLOBAL SECONDARY INDEX**
- Dropping a global secondary index: **ALTER TABLE name DROP GLOBAL SECONDARY INDEX**
- Altering a global secondary index: **ALTER TABLE name ALTER GLOBAL SECONDARY INDEX**

Information related to a global secondary index can be retrieved through the following views.

Table 14-6 Global secondary index related information

Schema	View	Description
DICTIONARY_SCHEMA	ALL_CLUSTER_TABLES	Existence of a global secondary index in user accessible table
	ALL_GLOBAL_SECONDARY_INDEXES	Object information of user accessible global secondary index
	ALL_GSI_PLACE	Placement information of user accessible global secondary index
	USER_CLUSTER_TABLES	Existence of a global secondary index in user owned table
	USER_GLOBAL_SECONDARY_INDEXES	Object information of user owned global secondary index
	USER_GSI_PLACE	Placement information of user owned global secondary index

Concepts of Global Secondary Index

A global secondary index is a B-Tree index which configures the GRID (global row identifier) value as a key in each cluster member of the cluster environment.

Tables in the cluster environment is duplicated to all members in a group and the same records are applied and retrieved when performing DML or select. GRID is a unique value identifying the same records in cluster members, and it is allocated when the record is inserted for the first time, and it is spreaded over all members in a group, then stored together with the record.

The GRID value of the record is not altered even when the record is update, and it is not altered even wh

en the shard key is altered and transferred to another shard.

When creating a table in a cluster environment, a global secondary index may or may not be created, and it can be separately created or deleted after the table is created. A table may not have a global secondary index, or it may have maximum one global secondary index.

Figure 16 Structure of a global secondary index

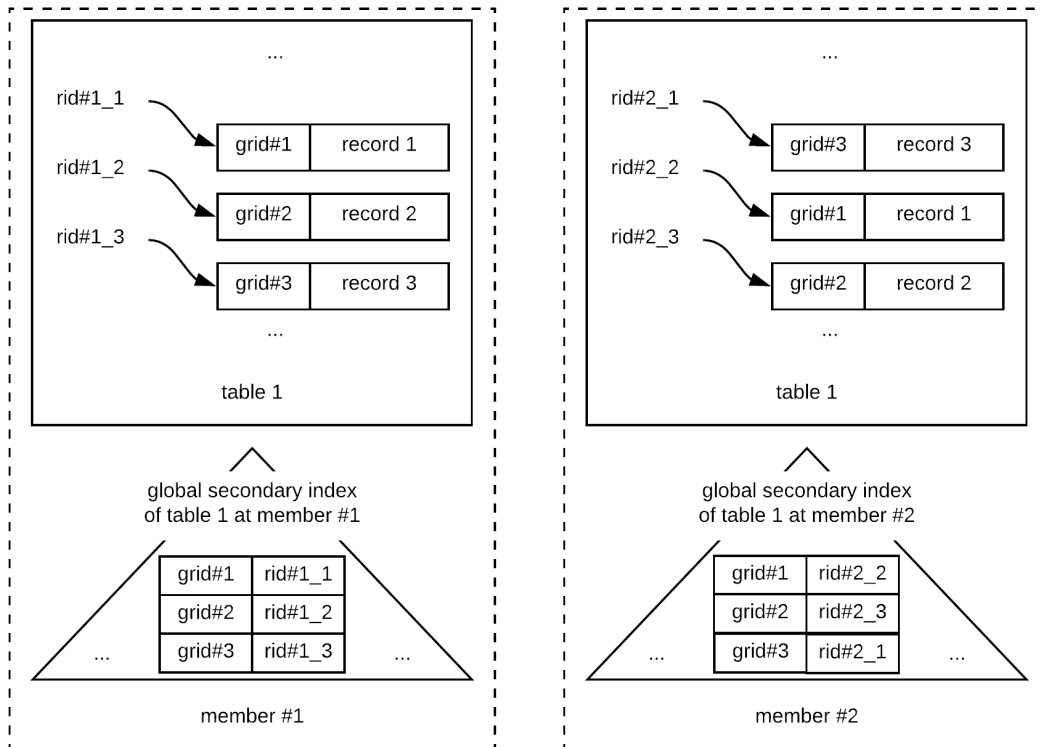

A global secondary index is required to perform a non-deterministic query for a table. If the table does not have a global secondary index, then the non-deterministic query fails as follows.

```
gSQL> DELETE FROM T1 LIMIT 1;
```

```
ERR-42000(16423): does not support non-deterministic DML in the cluster system : global secondary index expected
```

Refer to the dictionary such as ALL_GSI_PLACE, DBA_GSI_PLACE, and USER_GSI_PLACE to check if a table has a global secondary index.

15.

SQL Tuning

15.1 Overview

SQL tuning describes a comprehensive overview on how to improve the query performance in the SQL statements. GOLDILOCKS provides hint, plan Cache, SQL execution plan output for SQL tuning.

SQL tuning aims to minimize query response time and to improve query throughput, so it describes how to find and solve the problem.

The knowledge about database, database structure, SQL syntax and optimizer is required to understand SQL tuning. This chapter is described under the assumption that the reader knows all prerequisite knowledge.

15.2 SQL Processing

The overall SQL processing of GOLDILOCKS has phases such as SQL parser, plan cache check, SQL validation, optimization, plan generation, execution as follows.

If an execution plan for the same query is stored in plan cache, then the plan cache check executes the plan.

Figure 1 SQL processing phases

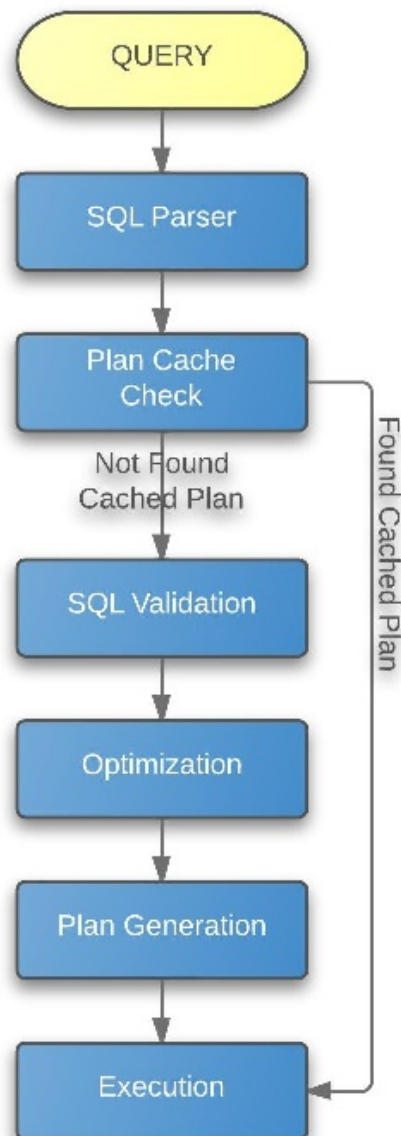

SQL Parser

SQL parser is the first phase of SQL processing, and it checks grammatical correctness of SQL statement input by a user. If the SQL statement is not grammatically correct, it is regarded as an error.

The following is an example of the grammatically incorrect SQL statement.

```
gSQL> SELECT * FORM t1;
ERR-42000(40000): syntax error
SELECT * FORM t1
.....^ ^
Error at line 1
```

In SQL parser phase, the necessary information for parsing is collected and stored. The parsing result derives the parsed SQL structure. The parsed SQL structure and other information are stored and managed in each session area.

Plan Cache Check

After the SQL parser phase is completed, it checks if the same query as the submitted query is stored in the plan cache, and this is the plan cache check phase.

In the plan cache check phase, it searches for a plan which is matched with **Plan cache parameters** from the plan cache of the parsed query statement.

In case when the plan is stored in the plan cache, the plan checks the validity of the objects such as tables and columns to which the plan accesses. If all objects are valid the process moves on to the execution phase using the plan. If any object is invalid the process moves on to SQL validation phase.

All plans which are generated by different sessions are shared in plan cache, and plans stored by other sessions can be referenced.

By using the plan stored in the plan cache at plan cache check phase, the process from SQL validation phase to plan generation phase can be omitted, so the performance is improved.

SQL Validation

The syntactic correctness of a query is checked in the SQL validation phase. In this phase, it checks syntactic errors such as whether the tables and columns of the submitted query statement exist, or whether the columns can be referenced.

The following is an example of the syntactically incorrect SQL statement.

```
gSQL> SELECT * FROM t1;
ERR-42000(16040): table or view does not exist :
SELECT * FROM t1
          *
ERROR at line 1:
```

Optimization

In the optimization phase, various execution plan for the SQL statement is set up, and the best plan is selected. In the optimization phase, the cost of the optimization methods such as an access method for a table, a join order, a join method is calculated. Then, it creates various plans and selects the best plan among them.

For more information, refer to [Query Optimizer](#).

Plan Generation

In the plan generation phase, the execution plan which is selected in optimization phase is generated in executable form for execution phase. The execution plan consists of a combination of nodes in multiple phases, and the nodes of each phase returns a result set to the superordinate node. The final phase nodes send the final result of the SQL statement to the user.

The execution plan consists of the nodes in a tree form, and it includes the following information.

- An access method for each table
- An order of the referencing tables
- A join method of the table join operation
- Information about the data filter
- Information about data grouping and aggregation
- Information about data sorting

The following is an example of the SQL execution plan generated in the plan generation phase.

```
gSQL>
\EXPLAIN PLAN
SELECT t1.i1, t1.i2, t2.i1, t2.i2
   FROM t1, t2
 WHERE t1.i1 = t2.i1
```

```

AND t1.i2 = 1
ORDER BY t1.i1;
no rows selected.
>>> start print plan
< Execution Plan >
=====
|  IDX  |  NODE DESCRIPTION          |  ROWS  |
=====
|   0   |  SELECT STATEMENT          |         |
|   1   |    SORT INSTANT ACCESS     |        0 |
|   2   |      HASH JOIN (INNER JOIN) |        0 |
|   3   |        TABLE ACCESS ("T2") |        0 |
|   4   |      HASH JOIN INSTANT ACCESS |        0 |
|   5   |        TABLE ACCESS ("T1") |        0 |
=====

1 - SORT KEY : "T1.I1 ASC NULLS LAST"
   RECORD COLUMNS : I2, I1, I2
   READ COLUMNS : I1, I2, I1, I2
2 - JOINED COLUMNS : T1.I1, T1.I2, T2.I1, T2.I2
3 - READ COLUMNS : I1, I2
4 - INDEX COLUMNS : I1
   TABLE COLUMNS : I2
   READ COLUMNS : I1, I2
   HASH FILTER : I1 = {I1}
5 - READ COLUMNS : I1, I2
   PHYSICAL FILTER : I2 = 1
<<< end print plan

```

Plan Cache Registration

When using the plan cache, the plan generated in **Plan Generation** phase is registered in plan cache. The plans in a cache are distinguished by whether it matches with the **Plan cache parameters** value.

Table 15-1 Plan cache parameters

Parameter	Description
Query text	Case sensitive query text
User information	User id
Cursor property	The cursor property of the query which requires fetch

Parameter	Description
Bind parameter	The number of bind parameters, and the IN/OUT property of each bind parameter
Enable atomic	Whether to use atomic insertion
Enable hint error	Whether validation error occurs for the hint

The followings are examples of queries which have different query text values.

```
"select i1 from t1"
"Select i1 from t1"
"select i1 from t1"
"SELECT I1 FROM T1"
```



If the schema objects (tables, indexes, views, sequences) referenced by the plan are not committed, the plan is not registered.

Execution

In execution phase, the execution plan which is generated in plan generation phase or selected in plan cache check phase is executed, and the result is returned. The execution plan in tree structure is executed from the left and the lowest node to the superordinate node.

```
gSQL>
\EXPLAIN PLAN
SELECT t1.i1, t1.i2, t2.c1, t2.c2
  FROM t1, t2
 WHERE t1.i1 = t2.c1
    AND t1.i2 = 1
 ORDER BY t1.i1;
no rows selected.
>>> start print plan
< Execution Plan >
=====
|  IDX  |  NODE DESCRIPTION  |  ROWS  |
-----|-----|-----|
|   0   |  SELECT STATEMENT  |         |
|   1   |  SORT INSTANT ACCESS |         0 |
|   2   |  HASH JOIN (INNER JOIN) |         0 |
|   3   |  TABLE ACCESS ("T2") |         0 |
```

```

| 4 |          HASH JOIN INSTANT ACCESS          |          0 |
| 5 |          TABLE ACCESS ("T1")              |          0 |
=====
1 - SORT KEY : "T1.I1 ASC NULLS LAST"
   RECORD COLUMNS : I2, C1, C2
   READ COLUMNS : I1, I2, C1, C2
2 - JOINED COLUMNS : T1.I1, T1.I2, T2.C1, T2.C2
3 - READ COLUMNS : C1, C2
4 - INDEX COLUMNS : I1
   TABLE COLUMNS : I2
   READ COLUMNS : I1, I2
   HASH FILTER : I1 = {C1}
5 - READ COLUMNS : I1, I2
   PHYSICAL FILTER : I2 = 1
<<< end print plan

```

The execution process using the plan generation example above is as follows.

1. The result is returned from IDX3 by using table access for the table T2. The result rows include the columns C1, C2.
2. The result is returned from IDX5 by using table access for the table T1. "I2 = 1" is processed by using physical filter, and the result is returned. The result rows include the columns I1, I2.
3. Hash join instant access for the result returned from IDX5 is created in IDX4, and "I1 = {I1}" is performed as hash filter. The rows of the result include the columns I1, I2.
4. Hash join is performed in IDX2 by using hash filter in IDX4 for the result of IDX3, and the result rows include the columns I1, I2 of the table T1, and the columns C1, C2 of the table T2.
5. Sort instant access for the result of IDX2 is generated in IDX1, and it is sorted by using the column I1 of the table T1. The result includes the columns I1, I2 of the table T1, and the columns I1, I2 of the table T2.
6. The result of IDX1 is finally returned to the user from IDX 0.

For more information about the SQL execution plan, refer to **SQL Execution Plan**.

15.3 Query Optimizer

Overview

An query optimizer determines the most effective execution plan for the SQL statement. In order to do so, the query optimizer generates various types of candidate plans for the SQL statement and calculates the cost for each plan. Then, it selects the final execution plan with the lowest cost among the candidate plans.

The process to find an effective plan by calculating the cost is cost-based optimization. During the process, the query optimizer uses information such as the number of rows which are returned by nodes, the access paths, and the join methods.

The query optimizer produces the candidate plans for the SQL statement returned from parsing and validation phases by calculating the cost based on query transformations and statistics. Then it selects the most efficient (the lowest cost) plan among the candidate plans, then produces the final execution plan.

The query transformations push the conditional clause to a view, or they convert the subQuery to the join form.

There are a heuristic query transformation and a cost-based query transformation.

The heuristic query transformation performs transformation only when transforming the queries is more efficient than the original query.

When transformation is not always efficient, the cost-based query transformation determines the cost effective form by comparing the original query with the transformed query.

Generally, the cost is calculated by using the selectivity and the cardinality. The selectivity is the rows ratio of the result to be returned to the result set after applying conditions. The cardinality is the number of the rows returned to the result from each node.

The query optimizer calculates the cost based on the selectivity and the cardinality. It also uses the access paths method (table access, index access), the join method (nested loops join, hash join), and the join ordering method.

The final execution plan selected by the query optimizer can be retrieved through the explain plan statement. For more information about the translating the execution plan output through the explain plan statement, refer to **SQL Execution Plan**.

Query Transformations

To perform the SQL statement more efficiently, the query transformations transform an SQL statement by pushing the filter or by unnesting the subQuery. For these query transformations, GOLDILOCKS supports the following methods.

- Simple view merging
- Filter push down
- SubQuery unnesting
- Single table min/max aggregation conversion
- Rewrite target on exists

Simple View Merging

It merges a simple view to the superordinate query block.

Merging the simple view enables applying more number of cases when determining a join ordering, a join operation and an access path, so it can generate more optimized plan.

The following is an example of a query.

```
gSQL> \explain plan
      select *
      from  ( select t1.col1 col1, t2.col1 col2
             from  t1, t2
             where t1.col1 = t2.col1 )v1, t3
      where v1.col1 = t3.col1;
```

It is assumed that the table t1, t2 are big and the table t3 is small.

If the simple view is not merged, the query above performs t3 after performing the join in the view. In this case, the intermediate result is big and it is not filtered enough.

< Execution Plan >

IDX	NODE DESCRIPTION	ROWS
0	SELECT STATEMENT	
1	NESTED LOOP JOIN (INNER JOIN)	1
2	VIEW (INLINE_VIEW AS V1)	5
3	NESTED LOOP JOIN (INNER JOIN)	5
4	INDEX ACCESS ("T2", "T2_COL1")	(5)

```

| 5 | INDEX ACCESS ("T1", "T1_COL1") | ( 5) | 5 |
| 6 | INDEX ACCESS ("T3", "T3_COL3") | ( 1) | 1 |
=====

```

However, if the simple view is merged, then t2 is performed after performing t1 and t3. In this case, the intermediate result is filtered enough so it improves the performance.

< Execution Plan >

```

=====
| IDX | NODE DESCRIPTION | | ROWS |
=====
| 0 | SELECT STATEMENT | | |
| 1 | NESTED LOOP JOIN (INNER JOIN) | | 1 |
| 2 | NESTED LOOP JOIN (INNER JOIN) | | 1 |
| 3 | TABLE ACCESS ("T3") | | 1 |
| 4 | INDEX ACCESS ("T1", "T1_COL1") | ( 1) | 1 |
| 5 | INDEX ACCESS ("T2", "T2_COL1") | ( 1) | 1 |
=====

```

The view conditions to merge the simple view are as follows.

- A set operator should not exist within the view.
- DISTINCT should not exist within the view.
- GROUP BY, HAVING, aggregate function should not exist within the view.
- The full outer join should not exist within the view.
- The natural join should not exist within the view.
- The SELECT list within the view should not include a subquery.
- LIMIT, OFFSET statement should not exist within the view.
- The view should not participate in the full outer join.
- When the view is participating in the right side of the left outer join, then only one table should exist in the *from* clause within the view.
- The view should not exist on the right side of the semi join.

Filter Push Down

The filter push down feature pushes the pushable filters among the filters of WHERE clause to the subQuery (view) of FROM clause. The filter push down feature pushes the filter to subQuery (view), and the pushed filter is used for index access in the subQuery (view). Or the pushed filter is used as the first executed filter. It improves the query processing performance.

The following is an example of a query.

```

SELECT l_linenum, l_quantity
FROM ( SELECT *
      FROM lineitem
      WHERE l_shipdate >= date '1996-01-01'
            AND l_shipdate <= date '1996-12-31' )
WHERE l_shipmode = 'AIR';

```

In the example above, the filter `l_shipmode = 'AIR'` which exists in the top-level node (WHERE clause) is pushed to the subQuery in FROM clause. It is as same as the example below.

```

SELECT l_linenum, l_quantity
FROM ( SELECT *
      FROM lineitem
      WHERE l_shipdate >= date '1996-01-01'
            AND l_shipdate <= date '1996-12-31'
            AND l_shipmode = 'AIR' );

```

The transformed query as above improves the performance by using index access when an index exists for `l_shipmode` in the `lineitem` table.

SubQuery Unnesting

The subQuery unnesting feature releases the subQuery in a conditional clause into join form. The subQuery unnesting feature transforms operators (IN, NOT IN, EXISTS, NOT EXISTS) and a quantify operator of ANY and ALL into the semi join operation or anti-semi join operation. The transformed query efficiently processes the join, and it improves the query processing performance.

The following is an example of a query.

```

SELECT ps_availqty
FROM partsupp
WHERE ps_partkey IN ( SELECT p_partkey
                    FROM part
                    WHERE p_type = 'STEEL' );

```

In the example above, IN operator can be transformed into semi join of `ps_partkey = p_partkey` condition. This transformed query can be retrieved by outputting the execution plan as follows.

```

gSQL>
\EXPLAIN PLAN
SELECT ps_availqty
FROM partsupp

```

```
WHERE ps_partkey IN ( SELECT p_partkey
                      FROM part
                      WHERE p_type = 'STEEL' );
```

```
PS_AVAILQTY
```

```
-----
      8895
      4969
      4651
      4093
```

```
4 rows selected.
```

```
>>> start print plan
```

```
< Execution Plan >
```

```
=====
|  IDX  |  NODE DESCRIPTION                                |  ROWS  |
|-----|-----|-----|
|   0   |  SELECT STATEMENT                                |         |
|   1   |  NESTED LOOP JOIN (INVERTED LEFT SEMI)           |    4    |
|   2   |    SORT INSTANT ACCESS (UNIQUE)                  |    2    |
|   3   |      TABLE ACCESS ("PART")                      |    2    |
|   4   |        INDEX ACCESS ("PARTSUPP, PARTSUPP_PK_INDEX") |    4    |
|-----|-----|-----|
1 - JOINED COLUMNS : PARTSUPP.PS_AVAILQTY
2 - SORT KEY : "PART.P_PARTKEY ASC NULLS LAST"
   READ COLUMNS : P_PARTKEY
3 - READ COLUMNS : P_PARTKEY, P_TYPE
   PHYSICAL FILTER : P_TYPE = 'STEEL'
4 - READ INDEX COLUMNS : PS_PARTKEY
   READ TABLE COLUMNS : PS_AVAILQTY
   MIN RANGE : PS_PARTKEY = {P_PARTKEY}
   MAX RANGE : PS_PARTKEY = {P_PARTKEY}
```

```
<<< end print plan
```

In the execution plan output above, the IN operation is transformed into the inverted left semi join by using the nested loop join.

Single Table Min/Max Aggregation Conversion

When a query has a min (or max) aggregate function in a select list, and has a single table in from clause, then an optimizer returns the result by using the index whose first key column is an argument column of the aggregation.

In order to do so, the following conditions should be satisfied.

- It should be a query for a single table. Only one of the MIN or MAX should exist on the target.
- OFFSET/LIMIT clause should not be in a query.
- A single column in a table should be the only aggregation argument.
- The index whose first key is the target column for aggregation should exist.
- The user should not provide a hint such as table access or rowid access.

The single table min/max aggregation conversion improves the query processing performance by reading a single data of the beginning or end of the Index instead of reading all the rows.

The following is an example of a query.

```
SELECT p_name, p_brand, p_type
FROM part
WHERE p_size = ( SELECT MAX( p_size )
                FROM part );
```

The query above returns p_name, p_brand, p_type of the largest p_size value from part table. The query has MAX aggregation in the SubQuery of the conditional clause.

The query above can be transformed to the query of returning only the last p_size data among data sorted in an ascending order by using the index access for p_size.

This transformed query can be retrieved by outputting the execution plan as follows.

```
gSQL>
\EXPLAIN PLAN
SELECT p_name, p_brand, p_type
FROM part
WHERE p_size = ( SELECT MAX( p_size )
                FROM part );
P_NAME P_BRAND P_TYPE
-----
Part#3 Brand#2 STEEL
1 row selected.
>>> start print plan
< Execution Plan >
=====
|  IDX  |  NODE DESCRIPTION                               |  ROWS  |
-----
|   0   |  SELECT STATEMENT                               |        |
|   1   |  TABLE ACCESS ("PART")                         |        1 |
|   2   |  SUB QUERY LIST                                 |        1 |
|   3   |  INDEX ACCESS ("PART, PART_SIZE")               |        1 |
```

```

=====
1 - READ COLUMNS : P_NAME, P_BRAND, P_TYPE, P_SIZE
    PHYSICAL FILTER : P_SIZE = P_SIZE
2 - READ COLUMNS : P_SIZE
3 - READ INDEX COLUMNS : P_SIZE
    MAX RANGE : P_SIZE IS NOT NULL
<<< end print plan

```

In the execution plan output above, the max range value is retrieved by using index access for subQuery in the conditional clause.

Rewrite Target on Exists

The rewrite target on exists feature transforms the target clause into the constant value in a subQuery which is located in exists or not exists operation. Exists or not exists operation determines whether the subQuery result row exists or not.

The result is same even when transforming target clause into the constant value because the number of targets or the result of the target expression does not affect the results of the operator.

The rewrite target on exists feature improves query processing performance by reducing an unnecessary expression processing in the target clause.

The following is an example of a query.

```

SELECT p_name, p_brand, p_type
  FROM part
 WHERE EXISTS( SELECT /*+ NO_QUERY_TRANSFORMATION */
                l_quantity, l_extendedprice * (1 - l_discount)
              FROM lineitem
              WHERE l_partkey = p_partkey
                AND l_quantity > 30 );

```

The query above returns the result rows of part table for the p_partkey when a row whose l_quantity is bigger than 30 exists among rows whose l_partkey and p_partkey are same in lineitem table.

Exists operator in conditional clause has two targets, which are l_quantity and l_extendedprice * (1 - l_discount). They can be transformed to a constant value (TRUE), and the transformed query can be retrieved by outputting the execution plan as follows.

However, **NO_QUERY_TRANSFORMATION** hint prevents query transformation.

```

gSQL>
\EXPLAIN PLAN
  SELECT p_name, p_brand, p_type

```

```

FROM part
WHERE EXISTS( SELECT /*+ NO_QUERY_TRANSFORMATION */
              l_quantity, l_extendedprice * (1 - l_discount)
              FROM lineitem
              WHERE l_partkey = p_partkey
              AND l_quantity > 30 );
P_NAME P_BRAND  P_TYPE
-----
Part#1 Brand#1  COPPER
Part#3 Brand#2  STEEL
Part#4 Brand#3  NICKEL
Part#5 Brand#3  STEEL
4 rows selected.
>>> start print plan
< Execution Plan >
=====
|  IDX  |  NODE DESCRIPTION                               |  ROWS  |
=====
|   0   |  SELECT STATEMENT                               |         |
|   1   |    SUB QUERY FILTER                             |         4 |
|   2   |      TABLE ACCESS ("PART")                     |         5 |
|   3   |        SUB QUERY LIST                           |         5 |
|   4   |          SUB QUERY FUNCTION                       |         5 |
|   5   |            TABLE ACCESS ("LINEITEM")            |         4 |
=====
1 - FILTER : EXISTS( ( TRUE ) )
2 - READ COLUMNS : P_PARTKEY, P_NAME, P_BRAND, P_TYPE
4 - FUNCTION : EXISTS( ( TRUE ) )
5 - READ COLUMNS : L_PARTKEY, L_QUANTITY
   PHYSICAL FILTER : L_PARTKEY = {P_PARTKEY} AND L_QUANTITY > 30
<<< end print plan

```

In the execution plan output above, target for subQuery in exists is transformed into TRUE.

Access Paths

An access path is a method to access a single table. Access paths are classified into table access, index access, rowid access, index concat.

An query optimizer calculates the cost of each access method, then selects the access method with the lowest cost as the execution plan.

Table Access

A table access is a method which scans a stored table when retrieving a table instead of using index or rowid. In general, a query optimizer selects table access method only when other methods can not be used or the user specifies table access hint because table access cost more than any other access method.

The table access is used in the following cases.

- Index does not exist.
- The function exists on the column side at the filter for the column in an index. (e.g. $i1 + 1 = 10$)
- Table access cost is small because the condition for the index's first column does not exist. (e.g. $i2 = 3$ condition is given to an index whose index keys are $i1$ and $i2$)
- The table is small so table access is less expensive than index access.
- A user specifies the table access hint (e.g. FULL(t1) hint)
- Though the condition for the index exists, but table access is needed. Therefore, the table access cost turns out to be low when calculating the cost.

The following is an example of using the table access when an index with filter column does not exist.

```
gSQL>
\EXPLAIN PLAN
SELECT p_name, p_brand, p_type
  FROM part
  WHERE p_size > 20;
P_NAME P_BRAND  P_TYPE
-----
Part#3 Brand#2  STEEL
1 row selected.
>>> start print plan
< Execution Plan >
=====
|  IDX  |  NODE DESCRIPTION                                |  ROWS  |
-----|-----|-----|
|    0  |  SELECT STATEMENT                                |         |
|    1  |  TABLE ACCESS ("PART")                          |         1 |
=====
1 - READ COLUMNS : P_NAME, P_BRAND, P_TYPE, P_SIZE
    PHYSICAL FILTER : P_SIZE > 20
<<< end print plan
```

The following is an example of specifying table access hint by a user, even when the index with filter column exists.

```

gSQL>
\EXPLAIN PLAN
SELECT /*+ FULL(part) */
      p_name, p_brand, p_type
FROM part
WHERE p_partkey > 1;
P_NAME P_BRAND  P_TYPE
-----
Part#2 Brand#1  NICKEL
Part#3 Brand#2  STEEL
Part#4 Brand#3  NICKEL
Part#5 Brand#3  STEEL
4 rows selected.
>>> start print plan
< Execution Plan >
=====
|  IDX  |  NODE DESCRIPTION                                |  ROWS  |
-----
|   0   |  SELECT STATEMENT                                |        |
|   1   |  TABLE ACCESS ("PART")                          |        4 |
=====
      1 - READ COLUMNS : P_PARTKEY, P_NAME, P_BRAND, P_TYPE
          PHYSICAL FILTER : P_PARTKEY > 1
<<< end print plan

```

Index Access

An index access performs table scan using an index. In general, when an index is usable in the filter, the index access is more efficient than others. When the index access is available, a query optimizer calculates the cost, and selects the index access with the lowest cost. When a user specifies the index access hint, then a query optimizer calculates the cost of the user defined indexes, and selects the index access with the lowest cost.

However, the index access is not selected in the following cases.

- The index exists in a filter, but it costs more than another access method, such as the table access when calculating the cost.
- The user specifies another access hint except for an index access, and it can be used. (e.g. FULL(t1) hint)
- There is a condition to select another access method. (Refer to the case when using the **Table Access**.)

The following is an example of using the index access selected by a query optimizer.

```

gSQL>
\EXPLAIN PLAN
SELECT p_name, p_brand, p_type
  FROM part
 WHERE p_partkey = 1;
P_NAME P_BRAND  P_TYPE
-----
Part#1 Brand#1  COPPER
1 row selected.
>>> start print plan
< Execution Plan >
=====
|  IDX  |  NODE DESCRIPTION                               |  ROWS  |
-----|-----|-----|
|   0   |  SELECT STATEMENT                               |         |
|   1   |  INDEX ACCESS ("PART, PART_PK_INDEX")          |        1 |
=====
1 - READ INDEX COLUMNS : P_PARTKEY
   READ TABLE COLUMNS : P_NAME, P_BRAND, P_TYPE
   MIN RANGE : P_PARTKEY = 1
   MAX RANGE : P_PARTKEY = 1
<<< end print plan

```

The following is an example of the case when the index access hint is specified.

```

gSQL>
\EXPLAIN PLAN
SELECT /*+ INDEX(part, part_size) */
  p_name, p_brand, p_type
  FROM part
 WHERE p_size > 10;
P_NAME P_BRAND  P_TYPE
-----
Part#4 Brand#3  NICKEL
Part#5 Brand#3  STEEL
Part#3 Brand#2  STEEL
3 rows selected.
>>> start print plan
< Execution Plan >

```

```

=====
|  IDX  |  NODE DESCRIPTION                               |  ROWS  |
=====
|   0   |  SELECT STATEMENT                               |        |
|   1   |  INDEX ACCESS ("PART, PART_SIZE")              |       3 |
=====

1 - READ INDEX COLUMNS : P_SIZE
    READ TABLE COLUMNS : P_NAME, P_BRAND, P_TYPE
    MIN RANGE : P_SIZE > 10
    MAX RANGE : P_SIZE IS NOT NULL
<<< end print plan

```

Rowid Access

Rowid access directly accesses the page by using the rowid when retrieving the table. To use the rowid access, the filter for the rowid should exist. A query optimizer selects the rowid access prior to other accesses when the condition for the rowid access exists.

The following is an example of using the rowid access.

```

gSQL>
\EXPLAIN PLAN
SELECT p_name, p_brand, p_type
FROM part
WHERE ROWID = 'AAAAAAAAADiACAAACCjAAA';
P_NAME P_BRAND  P_TYPE
-----
Part#1 Brand#1  COPPER
1 row selected.
>>> start print plan
< Execution Plan >

=====
|  IDX  |  NODE DESCRIPTION                               |  ROWS  |
=====
|   0   |  SELECT STATEMENT                               |        |
|   1   |  USER ROWID ACCESS ("PART")                    |       1 |
=====

1 - READ COLUMNS : P_NAME, P_BRAND, P_TYPE
    ROWID ACCESS EXPR : ROWID = 'AAAAAAAAADiACAAACCjAAA'
<<< end print plan

```

Index Concat

If an *or* statement exists in a filter and the index access can be executed on each filter divided by the *or* operator, then the index concat returns the result by combining the results of each index access.

The index concat is a concat node which has multiple index access on the subordinate nodes. If the *or* statement exists in a filter, a query optimizer calculates the cost of the index concat and selects the index concat when it has lower cost than other accesses.

The index concat cost is calculated as follows.

1. The filters are created which are newly adjusted based on *or*.
2. The most appropriate index is selected among indexes which are applicable to filters classified based on *or*.
3. The concat cost is calculated to remove the duplicate when collecting the results of the selected indexes.
4. The cost of the previously selected concat is added, then the final index concat cost is determined.

The index concat node is executed as follows.

1. The first node among the subordinate nodes of the index concat node is executed.
2. Among the execution results, the data for removing the duplicates are stored in concat node. The result is transferred to the superordinate node.
3. From the second node, the duplicates are checked in the concat node, and the data for removing the duplicates in the non-duplicate rows are stored in the concat node. Then, the result is transferred to the superordinate node.

The following is an example of using the index concat.

```
gSQL>
\EXPLAIN PLAN
SELECT /*+ INDEX_COMBINE(part, part_size) */
      p_name, p_brand, p_type
FROM part
WHERE p_size = 1
      OR p_size = 21;
P_NAME P_BRAND  P_TYPE
-----
Part#2 Brand#1  NICKEL
Part#3 Brand#2  STEEL
2 rows selected.
>>> start print plan
< Execution Plan >
=====
```

```

|  IDX  |  NODE DESCRIPTION                                |  ROWS  |
-----|-----|-----|
|   0   |  SELECT STATEMENT                                |        |
|   1   |    CONCAT                                        |        2 |
|   2   |      INDEX ACCESS ("PART, PART_SIZE")           |        1 |
|   3   |      INDEX ACCESS ("PART, PART_SIZE")           |        1 |
=====|=====|=====|
      2 - READ INDEX COLUMNS : P_SIZE
          READ TABLE COLUMNS : P_NAME, P_BRAND, P_TYPE
          MIN RANGE : P_SIZE = 1
          MAX RANGE : P_SIZE = 1
      3 - READ INDEX COLUMNS : P_SIZE
          READ TABLE COLUMNS : P_NAME, P_BRAND, P_TYPE
          MIN RANGE : P_SIZE = 21
          MAX RANGE : P_SIZE = 21
<<< end print plan

```

Join

Join combines result rows from two tables (or views) into a single result row. Join condition specifies the condition for combining rows from two tables (or views). Join without join condition returns the results which each rows of one table is combined with all rows of the other table.

The join process is generally expressed in a tree form. The left table in the join tree is an outer node and the right table is an inner node. In general, join is executed by reading a row of the outer node then combining it with the inner node rows which satisfy the join condition.

If there are three or more tables (or views) in FROM clause, two tables are joined first, and then the result is joined with the third table.

In this case, if join node exists only on the outer node, it is called as left deep join tree. If join node exists only on the inner node, it is called as right deep join tree. If join node exists on both outer and inner node, it is called as hybrid join tree.

The figure below describes the join tree type.

Figure 2 Join tree type

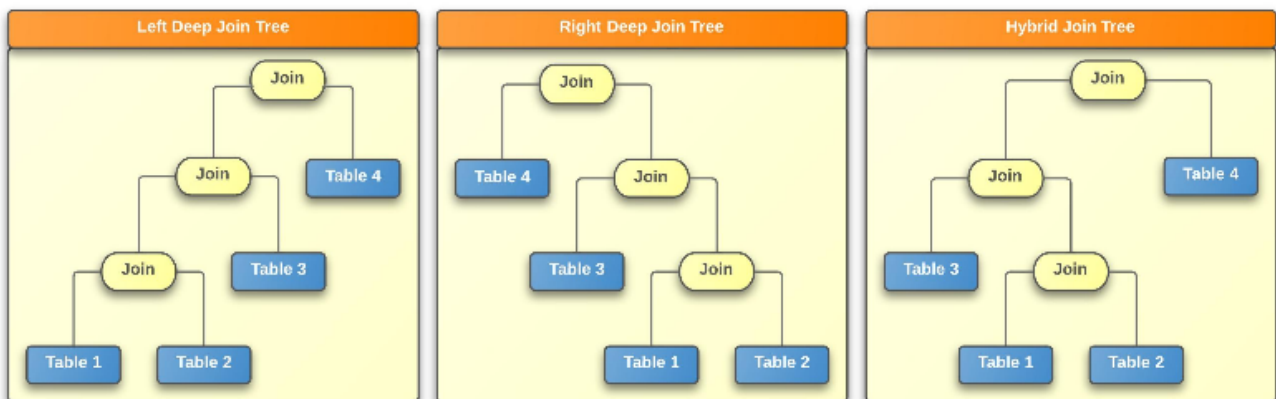

In the figure above, all three types of join tree are performed in an order of table 1, table 2, table 3, table 4. If all data in each table is same and all the join conditions are same as well, then the three types of join tree return the same result. The order of the result rows can be different from each other.

A query optimizer considers the following four items when calculating the join cost.

- The access paths cost to each table which participates in join
- The cost according to join type (inner, outer etc.)
- The cost of available join methods
- The cost according to the order of the two tables which participates in join

The cost differs according to the 4 items above, and a query optimizer selects the plan with lowest cost among them.

Join Type

Cross Join

A cross join does not have a join condition. Therefore, all inner node rows are combined to each outer node row, then they are returned as the join result row.

The following is an example of the cross join.

```
gSQL>
\EXPLAIN PLAN
SELECT s_name, c_name FROM supplier, customer;
S_NAME          C_NAME
-----
Supplier#1      Customer#1
Supplier#1      Customer#2
Supplier#1      Customer#3
```

```

Supplier#1      Customer#4
Supplier#1      Customer#5
Supplier#2      Customer#1
Supplier#2      Customer#2
Supplier#2      Customer#3
Supplier#2      Customer#4
Supplier#2      Customer#5
Supplier#3      Customer#1
Supplier#3      Customer#2
Supplier#3      Customer#3
Supplier#3      Customer#4
Supplier#3      Customer#5
Supplier#4      Customer#1
Supplier#4      Customer#2
Supplier#4      Customer#3
Supplier#4      Customer#4
Supplier#4      Customer#5
S_NAME         C_NAME

```

```

-----
Supplier#5      Customer#1
Supplier#5      Customer#2
Supplier#5      Customer#3
Supplier#5      Customer#4
Supplier#5      Customer#5

```

25 rows selected.

>>> start print plan

< Execution Plan >

```

=====
|  IDX  |  NODE DESCRIPTION                                |  ROWS  |
=====
|   0   |  SELECT STATEMENT                                |         |
|   1   |  NESTED LOOP JOIN (INNER JOIN)                   |        25 |
|   2   |    TABLE ACCESS ("SUPPLIER")                     |         5 |
|   3   |    TABLE ACCESS ("CUSTOMER")                     |         5 |
=====

```

- 1 - JOINED COLUMNS : SUPPLIER.S_NAME, CUSTOMER.C_NAME
- 2 - READ COLUMNS : S_NAME
- 3 - READ COLUMNS : C_NAME

<<< end print plan

Inner Join

An inner join has a join condition. Therefore, only the inner node rows which satisfy the join condition are combined to each row of outer node, then they are returned to the join result row.

A join condition consists of operators between columns of two tables (or views). If the operator of the Join condition is =(equal), then it is called equi-join. Otherwise it is called non-equi-join.

The following is an example of an equi-join in the inner join.

```
gSQL>
\EXPLAIN PLAN
SELECT p_name, ps_availqty
   FROM part, partsupp
  WHERE p_partkey = ps_partkey;
P_NAME PS_AVAILQTY
-----
Part#1      3325
Part#1      8076
Part#2      3956
Part#2      4069
Part#3      8895
Part#3      4969
Part#4      8539
Part#4      3025
Part#5      4651
Part#5      4093
10 rows selected.
>>> start print plan
< Execution Plan >
=====
|  IDX  |  NODE DESCRIPTION                               |  ROWS  |
-----
|   0   |  SELECT STATEMENT                               |         |
|   1   |    HASH JOIN (INNER JOIN)                       |    10  |
|   2   |      TABLE ACCESS ("PARTSUPP")                 |    10  |
|   3   |        HASH JOIN INSTANT ACCESS                 |    10  |
|   4   |          TABLE ACCESS ("PART")                 |     5  |
=====
1 - JOINED COLUMNS : PART.P_NAME, PARTSUPP.PS_AVAILQTY
2 - READ COLUMNS  : PS_PARTKEY, PS_AVAILQTY
3 - INDEX COLUMNS : P_PARTKEY
  TABLE COLUMNS : P_NAME
```

```

        READ COLUMNS : P_PARTKEY, P_NAME
        HASH FILTER : P_PARTKEY = {PS_PARTKEY}
4 - READ COLUMNS : P_PARTKEY, P_NAME
<<< end print plan

```

The following is an example of a non-equi-join in the inner join.

```

gSQL>
\EXPLAIN PLAN
SELECT o_totalprice, l_extendedprice, l_discount
FROM orders, lineitem
WHERE o_orderkey = 1
AND l_shipdate > o_orderdate;
O_TOTALPRICE L_EXTENDEDPRICE L_DISCOUNT
-----
173665.47      21168.23      .04
173665.47      45983.16      .09
173665.47      13309.6       .1
173665.47      28955.64      .09
173665.47      22824.48      .1
5 rows selected.
>>> start print plan
< Execution Plan >
=====
|  IDX  |  NODE DESCRIPTION                               |  ROWS  |
=====
|   0   |  SELECT STATEMENT                               |        |
|   1   |  NESTED LOOP JOIN (INNER JOIN)                  |   5    |
|   2   |    INDEX ACCESS ("ORDERS, ORDERS_PK_INDEX")     |   1    |
|   3   |    TABLE ACCESS ("LINEITEM")                   |   5    |
=====
1 - JOINED COLUMNS : ORDERS.O_TOTALPRICE, LINEITEM.L_EXTENDEDPRICE, LINEITEM.L_DISCOUNT
2 - READ INDEX COLUMNS : O_ORDERKEY
   READ TABLE COLUMNS : O_TOTALPRICE, O_ORDERDATE
   MIN RANGE : O_ORDERKEY = 1
   MAX RANGE : O_ORDERKEY = 1
3 - READ COLUMNS : L_EXTENDEDPRICE, L_DISCOUNT, L_SHIPDATE
   PHYSICAL FILTER : L_SHIPDATE > {O_ORDERDATE}
<<< end print plan

```

Outer Join

Outer join have a join condition. If any inner join row satisfies the join condition, outer node rows are combined with inner node rows which satisfies the join condition, then return the results. If there is not any inner join row to satisfy the join condition, outer node rows are combined rows which have NULL data on ly, and return the results.

Outer join is differentiated from other joins by having direction such as left, right and full.

Outer node of left outer join is the left table of a join, and outer node of right outer join is the right table of a join.

Full outer join is the union of left outer join and right outer join. It combines rows which satisfy the join condition, the left and right node rows which do not satisfy the condition and the rows which have NULL data only. Then it returns the result.

The right outer join result is equivalent to the left outer join result when executing it after exchanging the tables' position which are located at each end. Namely, "A LEFT OUTER JOIN B" and "B RIGHT OUTER JOIN A" are equivalent in an aspect of the result. Therefore, query optimizer generates the plan by replacing all the right outer join with left outer join.

The following is an example of the left outer join.

```
gSQL>
```

```
\EXPLAIN PLAN
```

```
SELECT p_name, p_brand, ps_availqty
FROM part LEFT OUTER JOIN partsupp
ON p_partkey = ps_partkey
AND ps_availqty > 5000;
```

```
P_NAME P_BRAND PS_AVAILQTY
```

```
-----
```

```
Part#1 Brand#1      8076
```

```
Part#2 Brand#1      null
```

```
Part#3 Brand#2      8895
```

```
Part#4 Brand#3      8539
```

```
Part#5 Brand#3      null
```

```
5 rows selected.
```

```
>>> start print plan
```

```
< Execution Plan >
```

```
=====
```

IDX	NODE DESCRIPTION	ROWS
0	SELECT STATEMENT	
1	HASH JOIN (LEFT OUTER JOIN)	5
2	TABLE ACCESS ("PART")	5

```
=====
```

```

| 3 | HASH JOIN INSTANT ACCESS | 5 |
| 4 | TABLE ACCESS ("PARTSUPP") | 3 |
=====
1 - JOINED COLUMNS : PART.P_NAME, PART.P_BRAND, PARTSUPP.PS_AVAILQTY
2 - READ COLUMNS : P_PARTKEY, P_NAME, P_BRAND
3 - INDEX COLUMNS : PS_PARTKEY
   TABLE COLUMNS : PS_AVAILQTY
   READ COLUMNS : PS_PARTKEY, PS_AVAILQTY
   HASH FILTER : {P_PARTKEY} = PS_PARTKEY
4 - READ COLUMNS : PS_PARTKEY, PS_AVAILQTY
   PHYSICAL FILTER : PS_AVAILQTY > 5000
<<< end print plan

```

The following is an example of the full outer join.

```

gSQL>
\EXPLAIN PLAN
SELECT p_name, p_brand, ps_availqty
FROM part FULL OUTER JOIN partsupp
ON p_partkey = ps_partkey
AND ps_availqty > 3000
AND p_size < 20;
P_NAME P_BRAND PS_AVAILQTY
-----
Part#1 Brand#1 8076
Part#1 Brand#1 3325
Part#2 Brand#1 4069
Part#2 Brand#1 3956
Part#3 Brand#2 null
Part#4 Brand#3 3025
Part#4 Brand#3 8539
Part#5 Brand#3 4093
Part#5 Brand#3 4651
null null 4969
null null 8895
11 rows selected.
>>> start print plan
< Execution Plan >
=====
| IDX | NODE DESCRIPTION | ROWS |
=====

```

```

| 0 | SELECT STATEMENT | |
| 1 | HASH JOIN (FULL OUTER JOIN) | 11 |
| 2 | TABLE ACCESS ("PART") | 5 |
| 3 | HASH JOIN INSTANT ACCESS | 11 |
| 4 | TABLE ACCESS ("PARTSUPP") | 10 |
=====

```

```

1 - JOINED COLUMNS : PART.P_NAME, PART.P_BRAND, PARTSUPP.PS_AVAILQTY

```

```

    JOIN FILTER : {PS_AVAILQTY} > 3000 AND {P_SIZE} < 20

```

```

2 - READ COLUMNS : P_PARTKEY, P_NAME, P_BRAND, P_SIZE

```

```

3 - INDEX COLUMNS : PS_PARTKEY

```

```

    TABLE COLUMNS : PS_AVAILQTY

```

```

    READ COLUMNS : PS_PARTKEY, PS_AVAILQTY

```

```

    HASH FILTER : {P_PARTKEY} = PS_PARTKEY

```

```

4 - READ COLUMNS : PS_PARTKEY, PS_AVAILQTY

```

```

<<< end print plan

```

Semi Join

A semi join returns only the outer node rows which satisfy the join condition, so it should have a join condition. The semi join returns only the outer node rows whose inner node rows satisfy the join condition.

The semi join can not be explicitly specified in the SQL statement, but query optimizer transforms the operators (IN, EXIST) and ANY type quantify operators (= ANY) to the semi join.

A nested loops join and a hash join support the semi join in the inverted form.

An inverted semi join in the nested loops join has an index for the join condition of the outer node. Therefore, it reads inner node rows in the way of ensuring its uniqueness, and returns the result which satisfy the join condition from the outer node.

This method is used when there are many rows in the outer node, there is a join condition index, and there are small number of rows in the inner node. The uniqueness of inner node rows should be ensured, so the sort instance is used for it. The inverted semi join using the nested loops join has better performance than the semi join using the general nested loops join. For example, it reduces the cost of generating the hash instance. It is because the inverted semi join using the nested loops join performs the index access to the outer node with many rows by using a small number of inner node rows, and returns the join result.

The inverted semi join using the hash join generates outer node as a hash instant, and reads inner node rows. Then it returns the unreturned rows among the rows which satisfy the join condition from the hash instant.

This method is used when there are small number of rows in the outer node, and there many rows in the inner node.

The inverted semi join using the hash join makes a small number of outer node rows into the hash instant,

and returns the result by reading many inner node rows and scanning the hash instant. Therefore, it improves the performance than the semi join which generates the hash instant in the inner node by using the hash join. For example, it reduces the cost of generating the hash instance.

The following is an example of the semi join.

```
gSQL>
\EXPLAIN PLAN
SELECT p_name, p_brand
  FROM part
 WHERE p_partkey IN ( SELECT ps_partkey
                      FROM partsupp
                      WHERE ps_availqty > 5000 );
P_NAME P_BRAND
-----
Part#1 Brand#1
Part#3 Brand#2
Part#4 Brand#3
3 rows selected.
>>> start print plan
< Execution Plan >
=====
|  IDX  |  NODE DESCRIPTION                                |  ROWS  |
=====
|   0   |  SELECT STATEMENT                                |         |
|   1   |    HASH JOIN (INVERTED LEFT SEMI)                |        3 |
|   2   |      TABLE ACCESS ("PARTSUPP")                  |        3 |
|   3   |        HASH JOIN INSTANT ACCESS                  |        3 |
|   4   |          TABLE ACCESS ("PART")                  |        5 |
=====
1 - JOINED COLUMNS : PART.P_NAME, PART.P_BRAND
2 - READ COLUMNS : PS_PARTKEY, PS_AVAILQTY
   PHYSICAL FILTER : PS_AVAILQTY > 5000
3 - INDEX COLUMNS : P_PARTKEY
   TABLE COLUMNS : P_NAME, P_BRAND
   READ COLUMNS : P_PARTKEY, P_NAME, P_BRAND
   HASH FILTER : P_PARTKEY = {PS_PARTKEY}
4 - READ COLUMNS : P_PARTKEY, P_NAME, P_BRAND
<<< end print plan
```

Anti-semi Join

An anti-semi join returns only the outer node rows whose inner node rows do not satisfy the join condition. Therefore, the anti-semi join should have a join condition.

The anti-semi join can not be explicitly specified in the SQL statement, but query optimizer transforms the operators (NOT IN, NOT EXISTS) and ALL type quantify operators (= ALL) to anti-semi join.

The anti-semi join separately processes NULL data, unlike semi-join, if NULL data exists. It is because the comparison operation of NULL data returns UNKNOWN instead of TRUE/FALSE.

A query optimizer performs the anti-semi join if the anti-semi join condition guarantees the absence of NULL. If not, it performs the null-aware anti-semi join.

The following is an example of the anti-semi join which guarantees the absence of NULL data in the join condition.

```
gSQL>
\EXPLAIN PLAN
SELECT p_name, p_brand
  FROM part
 WHERE p_partkey NOT IN ( SELECT ps_partkey
                          FROM partsupp
                          WHERE ps_availqty > 5000 );

P_NAME P_BRAND
-----
Part#2 Brand#1
Part#5 Brand#3
2 rows selected.
>>> start print plan
< Execution Plan >

=====
|  IDX  |  NODE DESCRIPTION                               |  ROWS  |
=====
|   0   |  SELECT STATEMENT                               |         |
|   1   |    HASH JOIN (LEFT ANTI SEMI)                   |        2 |
|   2   |      TABLE ACCESS ("PART")                     |         5 |
|   3   |        HASH JOIN INSTANT ACCESS (UNIQUE)        |         2 |
|   4   |          TABLE ACCESS ("PARTSUPP")             |         3 |
=====

1 - JOINED COLUMNS : PART.P_NAME, PART.P_BRAND
2 - READ COLUMNS  : P_PARTKEY, P_NAME, P_BRAND
3 - INDEX COLUMNS : PS_PARTKEY
   HASH FILTER    : {P_PARTKEY} = PS_PARTKEY
```

```

4 - READ COLUMNS : PS_PARTKEY, PS_AVAILQTY
    PHYSICAL FILTER : PS_AVAILQTY > 5000

```

```
<<< end print plan
```

The following is an example of anti-semi join which does not guarantee the absence of NULL data in the join condition.

```
gSQL>
```

```
\EXPLAIN PLAN
```

```
SELECT p_name, p_brand
```

```
FROM part
```

```
WHERE p_partkey NOT IN ( SELECT l_partkey
                        FROM lineitem
                        WHERE l_quantity > 30 );
```

```
P_NAME P_BRAND
```

```
-----
```

```
Part#2 Brand#1
```

```
1 row selected.
```

```
>>> start print plan
```

```
< Execution Plan >
```

```
=====
```

IDX	NODE DESCRIPTION	ROWS
0	SELECT STATEMENT	
1	HASH JOIN (LEFT ANTI SEMI NA)	1
2	TABLE ACCESS ("PART")	5
3	HASH JOIN INSTANT ACCESS (UNIQUE)	1
4	TABLE ACCESS ("LINEITEM")	5

```
=====
```

```
1 - JOINED COLUMNS : PART.P_NAME, PART.P_BRAND
```

```
2 - READ COLUMNS : P_PARTKEY, P_NAME, P_BRAND
```

```
3 - INDEX COLUMNS : L_PARTKEY
```

```
    HASH FILTER : {P_PARTKEY} = L_PARTKEY
```

```
4 - READ COLUMNS : L_PARTKEY, L_QUANTITY
```

```
    PHYSICAL FILTER : L_QUANTITY > 30
```

```
<<< end print plan
```

Join Method

Join methods are join operation methods for two tables (or views). They are classified into a nested loops join, a sort merge join, and a hash join.

A query optimizer calculates cost for these three join methods, then selects the join method of the lowest cost.

Nested Loops Join

A nested loops join is the basic join and it does not generate a separate instance in the outer node or the inner node when performing the join. A query optimizer performs the nested loops join in the following cases.

- The join condition does not exist.
- The equi-join condition does not exist in join condition.
- An effective access method such as index exists in inner node.
- USE_NL hint is specified.

The nested loops join usually has a good performance when the inner node uses an index access by the join condition. A query optimizer selects the nested loops join when it is considered as best by calculating the cost.

The nested loops join can be extended by using instances. The extended nested loops join generates a sort instance in the inner node for a similar effects like as index access in join condition.

It is used when the cost of generating the sort instance is added but the cost of searching the inner node rows satisfying the join condition is decreased, so the entire join cost is decreased.

The following is an example of the nested loops join.

```
gSQL>
\EXPLAIN PLAN
SELECT /*+ USE_NL(part, partsupp) */
      p_name, p_brand, p_type
FROM part, partsupp
WHERE p_partkey = ps_partkey
      AND ps_availqty > 5000;
P_NAME P_BRAND  P_TYPE
-----
Part#1 Brand#1  COPPER
Part#3 Brand#2  STEEL
Part#4 Brand#3  NICKEL
3 rows selected.
>>> start print plan
< Execution Plan >
```

```
=====
```

```

|  IDX  |  NODE DESCRIPTION                                |  ROWS  |
-----|-----|-----|
|   0   |  SELECT STATEMENT                                |         |
|   1   |  NESTED LOOP JOIN (INNER JOIN)                   |        3 |
|   2   |    TABLE ACCESS ("PART")                        |        5 |
|   3   |    INDEX ACCESS ("PARTSUPP, PARTSUPP_PK_INDEX")  |        3 |
=====
1  -  JOINED COLUMNS : PART.P_NAME, PART.P_BRAND, PART.P_TYPE
2  -  READ COLUMNS  : P_PARTKEY, P_NAME, P_BRAND, P_TYPE
3  -  READ INDEX COLUMNS : PS_PARTKEY
    READ TABLE COLUMNS : PS_AVAILQTY
    MIN RANGE : PS_PARTKEY = {P_PARTKEY}
    MAX RANGE : PS_PARTKEY = {P_PARTKEY}
    PHYSICAL TABLE FILTER : PS_AVAILQTY > 5000
<<< end print plan

```

The following is an example of the extended nested loops join using the sort instant in the inner node.

```

gSQL>
\EXPLAIN PLAN
SELECT /*+ USE_INL(part, lineitem) */
      p_name, p_brand, p_type
FROM part, lineitem
WHERE p_partkey = l_partkey
      AND l_quantity > 30;
P_NAME P_BRAND  P_TYPE
-----
Part#4 Brand#3  NICKEL
Part#5 Brand#3  STEEL
Part#1 Brand#1  COPPER
Part#4 Brand#3  NICKEL
Part#3 Brand#2  STEEL
5 rows selected.
>>> start print plan
< Execution Plan >
=====
|  IDX  |  NODE DESCRIPTION                                |  ROWS  |
-----|-----|-----|
|   0   |  SELECT STATEMENT                                |         |
|   1   |  NESTED LOOP JOIN (INNER JOIN)                   |        5 |
|   2   |    TABLE ACCESS ("LINEITEM")                    |        5 |

```

```

| 3 |          SORT INSTANT ACCESS          |      5 |
| 4 |          TABLE ACCESS ("PART")      |      5 |
=====
1 - JOINED COLUMNS : PART.P_NAME, PART.P_BRAND, PART.P_TYPE
2 - READ COLUMNS : L_PARTKEY, L_QUANTITY
   PHYSICAL FILTER : L_QUANTITY > 30
3 - SORT KEY : "PART.P_PARTKEY ASC NULLS LAST"
   RECORD COLUMNS : P_NAME, P_BRAND, P_TYPE
   READ COLUMNS : P_PARTKEY, P_NAME, P_BRAND, P_TYPE
   MIN RANGE : P_PARTKEY = {L_PARTKEY}
   MAX RANGE : P_PARTKEY = {L_PARTKEY}
4 - READ COLUMNS : P_PARTKEY, P_NAME, P_BRAND, P_TYPE
<<< end print plan

```

Sort Merge Join

A sort merge join sorts the outer node rows and the inner node rows by column satisfying the join condition, then sequentially compares them, and returns the result of join. If there is an index in the outer node and in the inner node for the column which satisfies the join condition, and it is available, then that index is used. Otherwise, it sorts the rows by using the sort instant.

The sort merge join has the better performance than the nested loops join. It is because the sort merge join sequentially reads the sorted data in the outer node and the inner node, and compares the join condition. On the other hand, the nested loops join searches for rows which satisfy the join condition from all inner node rows for each outer node row.

However, if the cost of generating the sort instant in the outer node and the inner node, and sorting rows are big, then the performance is degraded. Therefore, a query optimizer calculates the cost, and selects the sort merge join when its cost is low.

When performing the sort merge join, at least one equi-join should be included in the join condition, and rows are sorted by columns of equi-join conditions.

If there is an index which includes all equi-join conditioned columns, it is used only when the order (ascending, descending) of each column in index key is usable in sort merge join.

For example, if the column I1, I2 is used for sort merge join, and I1 is sorted in ascending order and I2 is sorted in descending order in an index, then the index can not be used.

The following is an example of the sort merge join.

```

gSQL>
\EXPLAIN PLAN
SELECT /*+ USE_MERGE(part, partsupp) */
       p_name, p_brand, p_type

```

```

FROM part, partsupp
WHERE p_partkey = ps_partkey
      AND ps_availqty > 5000;

```

```

P_NAME P_BRAND  P_TYPE
-----

```

```

Part#1 Brand#1  COPPER

```

```

Part#3 Brand#2  STEEL

```

```

Part#4 Brand#3  NICKEL

```

```

3 rows selected.

```

```

>>> start print plan

```

```

< Execution Plan >

```

```

=====
|  IDX  |  NODE DESCRIPTION                                |  ROWS  |
-----
|   0   |  SELECT STATEMENT                                |         |
|   1   |  SORT MERGE JOIN (INNER JOIN) : EQUAL            |        3 |
|   2   |    INDEX ACCESS ("PART, PART_PK_INDEX")          |        5 |
|   3   |    SORT JOIN INSTANT ACCESS                      |        3 |
|   4   |    TABLE ACCESS ("PARTSUPP")                   |        3 |
=====

```

```

1 - JOINED COLUMNS : PART.P_NAME, PART.P_BRAND, PART.P_TYPE

```

```

      MERGE FILTER : PART.P_PARTKEY = PARTSUPP.PS_PARTKEY

```

```

2 - READ INDEX COLUMNS : P_PARTKEY

```

```

      READ TABLE COLUMNS : P_NAME, P_BRAND, P_TYPE

```

```

3 - SORT KEY : "PARTSUPP.PS_PARTKEY ASC NULLS LAST"

```

```

      READ COLUMNS : PS_PARTKEY

```

```

4 - READ COLUMNS : PS_PARTKEY, PS_AVAILQTY

```

```

      PHYSICAL FILTER : PS_AVAILQTY > 5000

```

```

<<< end print plan

```

Hash Join

A hash join performs join by generating the hash instance in the inner node. It has a good performance because hash instance is generated only in the inner node and a join condition is compared by using the hash.

When performing hash join, at least one equi-join should be included in a join condition, and it costs for generating the hash instance whose hash key is columns in the equi-join condition.

However, the hash join has a better performance than other join methods, when the index for the join condition does not exist in the inner node. It is because the hash key can quickly read each outer node row when performing the join condition.

The following is an example of the hash join.

```

gSQL>
\EXPLAIN PLAN
SELECT /*+ USE_HASH(part, partsupp) */
      p_name, p_brand, p_type
FROM part, partsupp
WHERE p_partkey = ps_partkey
      AND ps_availqty > 5000;
P_NAME P_BRAND  P_TYPE
-----
Part#1 Brand#1  COPPER
Part#3 Brand#2  STEEL
Part#4 Brand#3  NICKEL
3 rows selected.
>>> start print plan
< Execution Plan >
=====
|  IDX  |  NODE DESCRIPTION                                |  ROWS  |
=====
|   0   |  SELECT STATEMENT                                |         |
|   1   |    HASH JOIN (INNER JOIN)                        |         |
|   2   |      TABLE ACCESS ("PARTSUPP")                  |         |
|   3   |        HASH JOIN INSTANT ACCESS                  |         |
|   4   |          TABLE ACCESS ("PART")                  |         |
=====
1 - JOINED COLUMNS : PART.P_NAME, PART.P_BRAND, PART.P_TYPE
2 - READ COLUMNS : PS_PARTKEY, PS_AVAILQTY
   PHYSICAL FILTER : PS_AVAILQTY > 5000
3 - INDEX COLUMNS : P_PARTKEY
   TABLE COLUMNS : P_NAME, P_BRAND, P_TYPE
   READ COLUMNS : P_PARTKEY, P_NAME, P_BRAND, P_TYPE
   HASH FILTER : P_PARTKEY = {PS_PARTKEY}
4 - READ COLUMNS : P_PARTKEY, P_NAME, P_BRAND, P_TYPE
<<< end print plan

```

Join Concat

The join condition for the join concat has an *or* statement, and the join conditions which are separated by an *or* statement is processed as a separate join, then they are combined into one result. The join concat selects the best plan for each join condition which is separated by the *or* condition, and removes the dupl

icates, then returns the result.

The join concat is similar to the index concat except that the join concat has a join node as a subordinate node.

The following is an example the index concat.

```
gSQL>
\EXPLAIN PLAN
SELECT p_name, p_brand, p_type
  FROM part, partsupp
 WHERE ( p_partkey = ps_partkey AND ps_availqty > 5000 )
       OR ( p_partkey = ps_partkey AND ps_supplycost > 900 );
P_NAME P_BRAND  P_TYPE
-----
Part#1 Brand#1  COPPER
Part#3 Brand#2  STEEL
Part#4 Brand#3  NICKEL
Part#3 Brand#2  STEEL
Part#5 Brand#3  STEEL
5 rows selected.
>>> start print plan
< Execution Plan >
```

IDX	NODE DESCRIPTION	ROWS
0	SELECT STATEMENT	
1	CONCAT	5
2	HASH JOIN (INNER JOIN)	3
3	TABLE ACCESS ("PARTSUPP")	3
4	HASH JOIN INSTANT ACCESS	3
5	TABLE ACCESS ("PART")	5
6	HASH JOIN (INNER JOIN)	3
7	TABLE ACCESS ("PARTSUPP")	3
8	HASH JOIN INSTANT ACCESS	3
9	TABLE ACCESS ("PART")	5

```

=====
2 - JOINED COLUMNS : PART.P_NAME, PART.P_BRAND, PART.P_TYPE
3 - READ COLUMNS : PS_PARTKEY, PS_AVAILQTY
   PHYSICAL FILTER : PS_AVAILQTY > 5000
4 - INDEX COLUMNS : P_PARTKEY
   TABLE COLUMNS : P_NAME, P_BRAND, P_TYPE
=====

```

```

        READ COLUMNS : P_PARTKEY, P_NAME, P_BRAND, P_TYPE
        HASH FILTER : P_PARTKEY = {PS_PARTKEY}
5 - READ COLUMNS : P_PARTKEY, P_NAME, P_BRAND, P_TYPE
6 - JOINED COLUMNS : PART.P_NAME, PART.P_BRAND, PART.P_TYPE
7 - READ COLUMNS : PS_PARTKEY, PS_SUPPLYCOST
        PHYSICAL FILTER : PS_SUPPLYCOST > 900
8 - INDEX COLUMNS : P_PARTKEY
        TABLE COLUMNS : P_NAME, P_BRAND, P_TYPE
        READ COLUMNS : P_PARTKEY, P_NAME, P_BRAND, P_TYPE
        HASH FILTER : P_PARTKEY = {PS_PARTKEY}
9 - READ COLUMNS : P_PARTKEY, P_NAME, P_BRAND, P_TYPE
<<< end print plan

```

Cluster

A cluster collects data in a local server and a remote server, then combines them into a result set. The clusters are classified into a cluster access and a cluster join. The cluster access collects data of a single table, and the cluster join collects the data of joining two or more tables.

Cluster Access

The cluster access retrieves the table data in a local server and a remote server in a cluster environment. The cluster access collects a single table data and one of accesses corresponding to the **Access Paths** above can be in its subordinate.

The cluster access is required only when the data should be retrieved from the remote server. Therefore, the cluster access does not occur in a stand alone, nor does it occur when the data should be retrieved only from the local server in a cluster environment.

The following is an example of using the cluster access.

```

gSQL>
\EXPLAIN PLAN
SELECT p_name, p_brand, p_type
  FROM part
 WHERE p_size > 20;
P_NAME P_BRAND   P_TYPE
-----
Part#3 Brand#2   STEEL
1 row selected.

```

```

>>> start print plan
< Execution Plan >
=====
====
|  IDX  |  NODE DESCRIPTION          |
ROWS |
-----
----
|   0   |  SELECT STATEMENT          |
|       |                             |
|   1   |  CLUSTER ACCESS ("PART") [HASH SHARDING] |
1 |
|   2   |  TABLE ACCESS ("PART") [HASH SHARDING] |
1 |
=====
====
1 - SQL : SELECT /*+ FULL("_A1") */
"A1"."P_NAME", "A1"."P_BRAND", "A1"."P_TYPE", "A1"."P_SIZE" FROM "PUBLIC"."PART"@LOCAL "A1"
WHERE "A1"."P_SIZE" > ?
      BIND PARAMS : {0} IN
2 - READ COLUMNS : P_NAME, P_BRAND, P_TYPE, P_SIZE
      PHYSICAL FILTER : P_SIZE > 20
<<< end print plan

```

Cluster Join

The cluster join retrieves the join result data in a local server and a remote server in a cluster environment. The cluster join collects the result data of joining two or more tables and one of methods corresponding to the **Join Method** above can be in its subordinate.

The cluster join is required only when the data should be retrieved from the remote server. Therefore, the cluster join does not occur in a stand alone, nor does it occur when the data should be retrieved only from the local server in a cluster environment.

The following is an example of using the cluster join.

```

gSQL>
\EXPLAIN PLAN
SELECT c_name, o_totalprice
FROM orders, customer
WHERE o_custkey = c_custkey
AND c_nation = 'KOREA';

```



```
C_NAME      O_TOTALPRICE
```

```
-----
```

```
Customer#1   173665.47
```

```
Customer#3   32151.78
```

```
2 rows selected.
```

```
>>> start print plan
```

```
< Execution Plan >
```

```
=====
```

```
=====
```

```
|  IDX  |  NODE DESCRIPTION                               |
ROWS |
-----
```

IDX	NODE DESCRIPTION	ROWS
0	SELECT STATEMENT	
1	CLUSTER JOIN	
2	NESTED LOOP JOIN (INNER JOIN)	
3	TABLE ACCESS ("CUSTOMER") [CLONED]	
4	INDEX ACCESS ("ORDERS", "ORDERS_CUSTKEY_FK") [HASH SHARDING]	(2)

```
=====
```

```
=====
```

```
1 - SQL : SELECT /*+ KEEP_JOINED_TABLE FULL("_A1") USE_NL("_A1") INDEX_ASC("_A2",
"ORDERS_CUSTKEY_FK") USE_NL("_A2") */ "_A1"."C_NAME", "_A2"."O_TOTALPRICE" FROM
"PUBLIC"."CUSTOMER"@LOCAL "_A1" INNER JOIN "PUBLIC"."ORDERS"@LOCAL "_A2" ON "_A1"."C_NATION" =
? AND "_A2"."O_CUSTKEY" = "_A1"."C_CUSTKEY"
```

```
    BIND PARAMS : {0} IN
```

```
2 - JOINED COLUMNS : CUSTOMER.C_NAME, ORDERS.O_TOTALPRICE
```

```
3 - READ COLUMNS : C_CUSTKEY, C_NAME, C_NATION
```

```
    PHYSICAL FILTER : C_NATION = 'KOREA'
```

```
4 - READ INDEX COLUMNS : O_CUSTKEY
```

```
    READ TABLE COLUMNS : O_TOTALPRICE
```

```
    MIN RANGE : O_CUSTKEY = {C_CUSTKEY}
```

```
    MAX RANGE : O_CUSTKEY = {C_CUSTKEY}
```

```
<<< end print plan
```

Statistics Information

A query optimizer uses statistics information to calculate the cost. Statistics information used by the query optimizer includes the information about table statistics, column statistics, and index statistics.

- Table statistics
 - The number of rows.
- Column statistics
 - The number of non-identical values
 - The number of the NULL values
 - The average length of a value
 - The minimum value
 - The maximum value
- Index statistics
 - The number of non-identical keys

ANALYZE TABLE statement is performed to construct the statistics. The constructed statistics is stored in the database and that statistics is used until the new statistics is constructed.

In case when a statistics is not constructed in a table, then use it after constructing the statistics by using the catalog information and page information at the time of query execution.

Adjusting Optimizer

Generally, a query optimizer selects the most efficient plan by using the given statistics information. However, a better plan than the selected plan may exist. If a query optimizer does not select the best plan, the user can adjust the plan to be selected.

Currently in GOLDILOCKS, a query optimizer provides a hint. If the hint is described and applicable, then the hint which is described by a user is preferentially applied regardless of the calculated cost. Therefore, when a better plan exists, the user can change the plan by using the hint.

For more information about hint, refer to **hint clause**.

15.4 SQL Execution Plan

Overview

SQL execution constructs the plan which is selected as the best among many candidate plans by a query optimizer into a form to be executed. SQL execution plan is separated by execution node unit and each node has an filter to be executed.

The top nodes of an SQL execution plan are classified as INSERT, DELETE, UPDATE and SELECT statements. Each node consists in a tree form which starts from the top node, and it is actually performed from the left bottom node.

The SQL execution plan tree includes the following information.

- The order of the tables referenced by the statement
- Access paths to each table
- Join method of node which processes the join
- Information of the sorting, grouping, aggregation, filter, etc

The identical SQL statements have SQL execution plans in same form, but they can have SQL execution plans in other form in the following cases.

- The tables in different schemas have the same name and the queries are performed for the different schemas.
- After the previous query execution, the schema change occurs such as adding/deleting index.
- After the previous query execution, the statistical information changed by adding/deleting the data, and query optimizer selects and performs the other plan which is better using the change.

Output

Syntax

```

<explain plan> ::=
    \explain plan [ on | only ] <sql statement>
<sql statement> ::=
    <query expression>
    | <select for update statement>
    | <select statement: single row>
    | <insert statement>
  
```

```
| <update statement: searched>
```

```
| <delete statement: searched>
```

Invocation and Access Rules

To execute <explain plan>, the access privilege on <sql statement> is required.

Syntax Rules and Parameters

<explain plan>

- \explain plan on
 - <sql statement> is executed and the query result is output together.
- \explain plan only
 - <sql statement> is not executed.
- \explain plan
 - It is as same as \explain plan on.

<sql statement>

<sql statement> is a target query to output the execution plan.

Description

It outputs the execution plan of SELECT and DML statements specified in <sql statement>.

Examples

When used together with ON as follows, it performs SQL statement and outputs the query result together with the execution plan.

```
gSQL> \explain plan on SELECT id, name FROM t1 ORDER BY 1;
```

```
ID NAME
```

```
-- -----
```

```
1 leekmo
```

```
2 jhkim
```

```
3 bsyu
```

```
3 rows selected.
```

```
>>> start print plan
```

```
< Execution Plan >
```

```
=====
```

```

|  IDX  |  NODE DESCRIPTION          |  ROWS  |
-----|-----|-----|
|   0   |  SELECT STATEMENT         |         |
|   1   |    SORT INSTANT ACCESS    |        3 |
|   2   |     TABLE ACCESS ("T1")  |        3 |
=====
      1 - SORT KEY : "T1.ID ASC NULLS LAST"
          RECORD COLUMNS : NAME
          READ COLUMNS : ID, NAME
      2 - READ COLUMNS : ID, NAME
<<< end print plan

```

When ON or ONLY is omitted as follows, it performs SQL statement and outputs the query result together with the execution plan.

```

gSQL> \explain plan on SELECT id, name FROM t1 ORDER BY 1;
ID NAME
-- -----
 1 leekmo
 2 jhkim
 3 bsyoun
3 rows selected.
>>> start print plan
< Execution Plan >
=====
|  IDX  |  NODE DESCRIPTION          |  ROWS  |
-----|-----|-----|
|   0   |  SELECT STATEMENT         |         |
|   1   |    SORT INSTANT ACCESS    |        3 |
|   2   |     TABLE ACCESS ("T1")  |        3 |
=====
      1 - SORT KEY : "T1.ID ASC NULLS LAST"
          RECORD COLUMNS : NAME
          READ COLUMNS : ID, NAME
      2 - READ COLUMNS : ID, NAME
<<< end print plan

```

When used together with ONLY as follows, it does not perform SQL statement but outputs the execution plan without the query result.

```

gSQL> \explain plan only SELECT id, name FROM t1 ORDER BY 1;
>>> start print plan
< Execution Plan >
=====
|  IDX  |  NODE DESCRIPTION          |  ROWS  |
-----|-----|-----|
|   0   |  SELECT STATEMENT          |         |
|   1   |    SORT INSTANT ACCESS     |        0 |
|   2   |     TABLE ACCESS ("T1")   |        0 |
=====
      1 - SORT KEY : "T1.ID ASC NULLS LAST"
          RECORD COLUMNS : NAME
          READ COLUMNS  : ID, NAME
      2 - READ COLUMNS : ID, NAME
<<< end print plan

```

Reading

Configuring SQL Execution Plan

An SQL execution plan is determined by a query optimizer, and it consists of nodes for actual query processing. The SQL execution plan is output by using EXPLAIN PLAN as follows.

```

gSQL> \explain plan SELECT id, name FROM t1;
ID NAME
-- -----
 1 leekmo
 2 jhkim
 3 bsyu
3 rows selected.
>>> start print plan
< Execution Plan >
=====
|  IDX  |  NODE DESCRIPTION          |  ROWS  |
-----|-----|-----|
|   0   |  SELECT STATEMENT          |         |
|   1   |    TABLE ACCESS ("T1")   |        3 |
=====
      1 - READ COLUMNS : ID, NAME
<<< end print plan

```

In the example above, `\explain plan` is specified before the SQL statement to output the SQL execution plan. As a result, the execution plan is output between `>>> start print plan` and `<<< end print plan`, which is between the start and end of the execution result.

The output of SQL execution plans are classified as execution plan node table and node information. Execution plan node outputs the node name and the number of performed rows in a table form. Node Information outputs the detailed information of each execution plan node.

Execution Plan Node Table

An execution plan node table in **Configuring SQL Execution Plan** which is about the query to retrieve id and name of the table t1 is as follows.

```
< Execution Plan >
=====
|  IDX  |  NODE DESCRIPTION          |  ROWS  |
-----|-----|-----|
|   0   |  SELECT STATEMENT          |         |
|   1   |  TABLE ACCESS ("T1")     |        3 |
=====
```

In the example above, the execution plan node table consists of columns of `IDX`, `NODE DESCRIPTION`, `ROWS`. Each node has a unique id number starting from zero. The tree form structure of each node is distinguished by a white space before the node name. In the example above, `SELECT STATEMENT` has `TABLE ACCESS` as a subordinate node.

Information for each column in execution plan node table is as follows.

- `IDX`
 - The identifier assigned to each plan node
- `NODE DESCRIPTION`
 - plan node name
 - Additional information in parentheses distinguishes the plan node.
 - Plan node indicated by the indentation means the subordinate plan node.
 - Starting from the subordinate plan node, and the result is transferred to the superordinate plan node.
- `ROWS`
 - The number of the result records by performing plan node.

The execution plan node table above is interpreted as follows.

- The execution plan node table above obtained 3 results by performing `TABLE ACCESS` for the table T1, and it is transferred by inputting `SELECT STATEMENT`.

Node Information

Node information in **Configuring SQL Execution Plan** which is about the query to retrieve id and name of the table t1 is as follows.

```
1 - READ COLUMNS : ID, NAME
```

The node information is output when there are information to be output. The IDX of execution plan node table is output in front of the node to distinguish nodes. The classified name and information is output at the end of the node.

Each information is output within a single line per information when it is needed to output various kinds of information.

The node information above is interpreted as follows.

- ID and NAME are the targets of read column when performing *TABLE ACCESS* for the table T1.

Classification of Execution Plan Node

The execution plan nodes are classified as <statement node>, <access node>, <join node>, <instant node>, <aggregation node>, <SET operator node>, <subQuery node>, <filter node>, <cluster node> and <other node>.

Each node is described in the following table.

Table 15-2 Classification of the execution plan node

Node	Refer to
Statement node	DELETE STATEMENT
	INSERT STATEMENT
	SELECT STATEMENT
	UPDATE STATEMENT
Access node	INDEX ACCESS (table_name [AS alias], index_name)
	TABLE ACCESS (table_name [AS alias])
	USER ROWID ACCESS (table_name [AS alias])
Join node	HASH JOIN (join_method)
	NESTED LOOP JOIN (join_method)
	SORT MERGE JOIN (join_method) : EQUAL
Instant node	GROUP HASH INSTANT ACCESS
	HASH JOIN INSTANT ACCESS
	HASH JOIN INSTANT ACCESS (UNIQUE)
	SORT INSTANT ACCESS
	SORT INSTANT ACCESS (UNIQUE)
	SORT JOIN INSTANT ACCESS

Node	Refer to
	SORT JOIN INSTANT ACCESS (UNIQUE)
Aggregation node	HASH AGGREGATION
SET operator node	EXCEPT ALL
	EXCEPT DISTINCT
	INTERSECT ALL
	INTERSECT DISTINCT
	UNION ALL
	UNION DISTINCT
SubQuery node	SUB QUERY FUNCTION
	SUB QUERY FUNCTION (MATERIALIZED)
	SUB QUERY LIST
Filter node	FILTER
Cluster node	CLUSTER ACCESS (table_name) [sharding_strategy]
	CLUSTER JOIN
Other node	CONCAT
	DELETE (table_name)
	INSERT (table_name)
	UPDATE (table_name)
	VIEW
	VIEW (view_name)
	GROUP

Classification of Node Information

Node information is classified as <Column Information>, <Filter Information> and <Aggregation Information>.

Each node information is described in the following table.

Table 15-3 Classification of node information

Node information	Name	Description
Column information	READ COLUMNS COLUMNS	The column list which will be transferred from current node to the result
	INDEX COLUMNS READ INDEX COLUMNS	The column list which the index will refer to
	TABLE COLUMNS READ TABLE COLUMNS	The column list which the table will refer to

Node information	Name	Description
	JOINED COLUMNS	The column list which will be transferred to the join result
	SORT KEY	The column list to be used as sort key in sort instance
	RECORD COLUMNS	The column list excluding sort keys in sort instance
	GROUPING COLUMNS	The column list to be used as grouping key
Filter information	PHYSICAL FILTER	AND-filter of comparison operation which does not need type casting
	LOGICAL FILTER	AND-filter which excludes physical filter
	JOIN FILTER	Filter about join condition
	WHERE FILTER	Filter to apply to rows consisting of join operation
	HASH FILTER	Filter which is processed by using hash key
	PHYSICAL TABLE FILTER	AND-filter about comparison operation which does not need type casting among table filters
	LOGICAL TABLE FILTER	AND-filter which excludes physical filter among table filters
	MIN RANGE	Min key range of index
	MAX RANGE	Max key range of index
	PHYSICAL KEY FILTER	AND-filter about comparison operation which does not need type casting among index filters
	LOGICAL KEY FILTER	AND-filter which excludes physical filter among index filters
	MERGE FILTER	Filter which is used for merge join in sort merge join
	SUBQUERY FILTER	SubQuery AND filter to process a subQuery
	FUNCTION	Function expression to process a subQuery
	ROWID ACCESS EXP	Filter related to a rowid
	NODE FILTER	Filter evaluating only once at the first execution
FILTER	Filter evaluating every rowid	
Aggregation information	AGGREGATIONS	General aggregation list
	NESTED AGGREGATIONS	Nested aggregation list
Other information	NODE EXPR	Expression executing only once at the first execution
	SQL	SQL query statement to be transferred to a remote server
	BIND PARAMS	Bind parameter used in the SQL query statement above
	REFERENCE SHARD KEY VALUE	Value of '=' filter for a column which is specified as a shard key in a table

Execution Plan Node References

CLUSTER ACCESS (table_name) [sharding_strategy]

- It collects results of the access node in a local server and a remote server in a cluster environment.
- It is created only when the data should be retrieved from the remote server.
- Node Information
 - SQL: The SQL query statement to be transferred to a remote server
 - BIND PARAMS: A bind parameter used in the SQL query statement above
 - REFERENCE SHARD KEY VALUE: Value of '=' filter for a column which is specified as a shard key in a table

The following is an example.

```

gSQL> \explain plan only
      SELECT l_orderkey
      FROM lineitem
      WHERE l_orderkey = 1
            AND l_linenumber = 2;
>>> start print plan
< Execution Plan >
=====
=====
|  IDX  |  NODE DESCRIPTION                                     |
ROWS |
-----
|   0   |  SELECT STATEMENT                                     |
|       |  |
|   1   |  CLUSTER ACCESS ("LINEITEM") [HASH SHARDING]       |
0 |
|   2   |  INDEX ACCESS ("LINEITEM", "LINEITEM_PK_INDEX") [HASH SHARDING] |
0 |
=====
=====
1 - SQL : SELECT /*+ INDEX_ASC("_A1", "LINEITEM_PK_INDEX") */
"_A1"."L_ORDERKEY", "_A1"."L_LINENUMBER" FROM "PUBLIC"."LINEITEM"@LOCAL "_A1" WHERE
"_A1"."L_ORDERKEY" = ? AND "_A1"."L_LINENUMBER" = ?
      BIND PARAMS : {0} IN {1} IN
      REFERENCE SHARD KEY VALUE : (1, 2)
2 - READ INDEX COLUMNS : L_ORDERKEY, L_LINENUMBER
      MIN RANGE : L_ORDERKEY = 1 AND L_LINENUMBER = 2

```

```
MAX RANGE : L_ORDERKEY = 1 AND L_LINENUMBER = 2
```

```
<<< end print plan
```

CLUSTER JOIN

- It collects results of the join node in a local server and a remote server in a cluster environment.
- It is created only when the data should be retrieved from the remote server.
- Node Information
 - SQL: The SQL query statement to be transferred to a remote server
 - BIND PARAMS: A bind parameter used in the SQL query statement above
 - REFERENCE SHARD KEY VALUE: Value of '=' filter for a column which is specified as a shard key in a table

The following is an example.

```
gSQL> \explain plan only
      SELECT c_name, o_totalprice
      FROM orders, customer
      WHERE o_custkey = c_custkey
            AND o_orderkey = 1;
      2      3      4      5
```

```
>>> start print plan
```

```
< Execution Plan >
```

```
=====
=====
|  IDX  |  NODE DESCRIPTION                                     |
|-----|-----|
|  ROWS |
|-----|-----|
-----
|   0   |  SELECT STATEMENT                                     |
|       |  |
|   1   |  CLUSTER JOIN                                       |
| 0 |
|   2   |  NESTED LOOP JOIN (INNER JOIN)                       |
| 0 |
|   3   |  INDEX ACCESS ("ORDERS", "ORDERS_PK_INDEX") [HASH SHARDING] |
| 0 |
|   4   |  INDEX ACCESS ("CUSTOMER", "CUSTOMER_PK_INDEX") [CLONED] |
| 0 |
=====
=====
1 - SQL : SELECT /*+ KEEP_JOINED_TABLE INDEX_ASC("_A1", "ORDERS_PK_INDEX")
```

```
USE_NL("_A1") INDEX_ASC("_A2", "CUSTOMER_PK_INDEX") USE_NL("_A2") */
"A2"."C_NAME", "A1"."O_TOTALPRICE" FROM "PUBLIC"."ORDERS"@LOCAL "_A1" INNER JOIN
"PUBLIC"."CUSTOMER"@LOCAL "_A2" ON "A1"."O_ORDERKEY" = ? AND "A2"."C_CUSTKEY" =
"A1"."O_CUSTKEY"
```

```
    BIND PARAMS : {0} IN
```

```
    REFERENCE SHARD KEY VALUE (ORDERS) : (1)
```

```
  2 - JOINED COLUMNS : CUSTOMER.C_NAME, ORDERS.O_TOTALPRICE
```

```
  3 - READ INDEX COLUMNS : O_ORDERKEY
```

```
    READ TABLE COLUMNS : O_CUSTKEY, O_TOTALPRICE
```

```
    MIN RANGE : O_ORDERKEY = 1
```

```
    MAX RANGE : O_ORDERKEY = 1
```

```
  4 - READ INDEX COLUMNS : C_CUSTKEY
```

```
    READ TABLE COLUMNS : C_NAME
```

```
    MIN RANGE : C_CUSTKEY = {O_CUSTKEY}
```

```
    MAX RANGE : C_CUSTKEY = {O_CUSTKEY}
```

```
<<< end print plan
```

CONCAT

- It concatenate the results for the subordinate nodes.
- It is generated when OR operation exists in the WHERE clause for index access or join.

The following is an example.

```
gSQL> \explain plan only
```

```
    SELECT s_suppkey FROM supplier WHERE s_suppkey = 1 or s_suppkey = 2;
```

```
>>> start print plan
```

```
< Execution Plan >
```

```
=====
|  IDX  |  NODE DESCRIPTION                                |  ROWS  |
-----|-----|-----|
|   0   |  SELECT STATEMENT                                |         |
|   1   |    CONCAT                                       |         0 |
|   2   |      INDEX ACCESS ("SUPPLIER, SUPPLIER_PK_INDEX") |         0 |
|   3   |      INDEX ACCESS ("SUPPLIER, SUPPLIER_PK_INDEX") |         0 |
=====
```

```
  2 - READ INDEX COLUMNS : S_SUPPKEY
```

```
    MIN RANGE : S_SUPPKEY = 1
```

```
    MAX RANGE : S_SUPPKEY = 1
```

```
  3 - READ INDEX COLUMNS : S_SUPPKEY
```

```
    MIN RANGE : S_SUPPKEY = 2
```

```
    MAX RANGE : S_SUPPKEY = 2
```

```
<<< end print plan
```

DELETE STATEMENT

- It performs the DELETE statement.
- It has the subordinate node, **DELETE (table_name)**

The following is an example.

```
gSQL> \explain plan only DELETE FROM supplier;
>>> start print plan
< Execution Plan >
=====
|  IDX  |  NODE DESCRIPTION                               |  ROWS  |
-----|-----|-----|
|   0   |  DELETE STATEMENT                             |         |
|   1   |  DELETE ("SUPPLIER")                           |        0 |
|   2   |  INDEX ACCESS ("SUPPLIER, SUPPLIER_PK_INDEX") |        0 |
=====
      2 - READ INDEX COLUMNS : S_SUPPKEY
<<< end print plan
```

DELETE (table_name)

It performs the DELETE statement on the specified table.

The following is an example.

```
gSQL> \explain plan only DELETE FROM supplier;
>>> start print plan
< Execution Plan >
=====
|  IDX  |  NODE DESCRIPTION                               |  ROWS  |
-----|-----|-----|
|   0   |  DELETE STATEMENT                             |         |
|   1   |  DELETE ("SUPPLIER")                           |        0 |
|   2   |  INDEX ACCESS ("SUPPLIER, SUPPLIER_PK_INDEX") |        0 |
=====
      2 - READ INDEX COLUMNS : S_SUPPKEY
<<< end print plan
```

EXCEPT ALL

It performs the EXCEPT ALL operation for the subordinate nodes in an order of IDX.

The following is an example.

```
gSQL> \explain plan only
      SELECT s_suppkey FROM supplier
      EXCEPT ALL
      SELECT /*+ FULL( lineitem) */ l_suppkey FROM lineitem
      EXCEPT ALL
      SELECT ps_suppkey FROM partsupp;
>>> start print plan
< Execution Plan >
=====
|  IDX  |  NODE DESCRIPTION                               |  ROWS  |
-----|-----|-----|
|   0   |  SELECT STATEMENT                               |         |
|   1   |    EXCEPT-ALL                               |    0   |
|   2   |      INDEX ACCESS ("SUPPLIER, SUPPLIER_PK_INDEX") |    0   |
|   3   |      TABLE ACCESS ("LINEITEM")                 |    0   |
|   4   |      INDEX ACCESS ("PARTSUPP, PARTSUPP_PK_INDEX") |    0   |
=====
      2 - READ INDEX COLUMNS : S_SUPPKEY
      3 - READ COLUMNS : L_SUPPKEY
      4 - READ INDEX COLUMNS : PS_SUPPKEY
<<< end print plan
```

EXCEPT DISTINCT

It performs EXCEPT DISTINCT operation for the subordinate nodes in an order of IDX.

The following is an example.

```
gSQL> \explain plan only
      SELECT s_suppkey FROM supplier
      EXCEPT DISTINCT
      SELECT /*+ FULL( lineitem) */ l_suppkey FROM lineitem
      EXCEPT DISTINCT
      SELECT ps_suppkey FROM partsupp;
>>> start print plan
< Execution Plan >
```



```

| 2 | TABLE ACCESS ("LINEITEM") | 0 |
| 3 | SUB QUERY LIST | 0 |
| 4 | SUB QUERY FUNCTION (MATERIALIZED) | 0 |
| 5 | INDEX ACCESS ("ORDERS", "ORDERS_PK_INDEX") | 0 |
=====
1 - READ COLUMNS : LINEITEM.L_ORDERKEY
   NODE EXPR : 1 + RANDOM(1,1)
   NODE FILTER : 1 = 1
   FILTER : ( LINEITEM.L_QUANTITY * LINEITEM.L_DISCOUNT ) >= ( 10 + RANDOM(1,1) )
   SUBQUERY FILTER : ( LINEITEM.L_ORDERKEY ) IN ( ORDERS.O_ORDERKEY )
2 - READ COLUMNS : L_ORDERKEY, L_LINENUMBER
   PHYSICAL FILTER : L_LINENUMBER = ?
4 - FUNCTION : ( L_ORDERKEY ) IN ( O_ORDERKEY )
5 - READ INDEX COLUMNS : O_ORDERKEY
<<< end print plan

```

GROUP

- It performs a grouping operation which does not require materialization.
- It is generated when GROUP BY clause or DISTINCT clause is in SELECT statement.
 - However, it is supported only when the uniqueness or sort order is ensured for the grouping key.
 - For other cases, the grouping is supported through GROUP HASH INSTANT ACCESS.
- Node information
 - AGGREGATIONS
 - An unnested aggregation list which is to be processed during grouping
 - Executing the grouping
 - GROUPING COLUMNS: A column list consisting of a grouping key
 - RECORD COLUMNS: A column list which is not a grouping key but is added for reference
 - READ COLUMNS: A column list to be read as the grouping results
 - LOGICAL FILTER: The entire AND-filter

The following is an example.

```

gSQL> \explain plan only SELECT /*+ INDEX( lineitem ) */ max( sum( l_quantity ) )
FROM lineitem
GROUP BY l_orderkey
HAVING sum( l_quantity ) > 10 and mod( sum( l_quantity ), 10 ) = 1;2 3 4
>>> start print plan
< Execution Plan >

```

```

=====
| IDX | NODE DESCRIPTION | ROWS |
=====

```

```

| 0 | SELECT STATEMENT | | |
| 1 | HASH AGGREGATION | | 0 |
| 2 | GROUP | | 0 |
| 3 | INDEX ACCESS("LINEITEM, LINEITEM_PK_INDEX") | | 0 |
=====
1 - AGGREGATIONS : MAX( SUM( L_QUANTITY ) )
2 - AGGREGATIONS : SUM( L_QUANTITY )
   GROUPING COLUMNS : L_ORDERKEY
   RECORD COLUMNS : SUM( L_QUANTITY )
   READ COLUMNS : SUM( L_QUANTITY )
   LOGICAL FILTER : MOD(SUM( L_QUANTITY ),10) = 1 AND SUM( L_QUANTITY ) > 10
3 - READ INDEX COLUMNS : L_ORDERKEY
   READ TABLE COLUMNS : L_QUANTITY
<<< end print plan

```

GROUP HASH INSTANT ACCESS

- It performs grouping operation.
- It is generated when GROUP BY clause or DISTINCT clause is in SELECT statement.
- Node information
 - AGGREGATIONS: An unnested aggregation list which is to be processed during grouping
 - NESTED AGGREGATIONS
 - A nested aggregation list which is to be processed during grouping
 - Executing the grouping
 - GROUPING COLUMNS: A column list of instance consisting of a grouping key
 - RECORD COLUMNS: A column list of instance which is not a grouping key but is added for reference
 - READ COLUMNS: A column list to be read from an instant
 - PHYSICAL FILTER: An AND-filter for comparison operation which does not require the type casting
 - LOGICAL FILTER: An AND-filter which excludes PHYSICAL FILTER from the entire FILTER

The following is an example.

```

gSQL> \explain plan only SELECT /*+ FULL( lineitem ) */ max( sum( l_quantity ) )
FROM lineitem
GROUP BY l_orderkey
HAVING sum( l_quantity ) > 10 and mod( sum( l_quantity ), 10 ) = 1;
>>> start print plan
< Execution Plan >
=====
| IDX | NODE DESCRIPTION | | ROWS |

```

```

-----
|  0 | SELECT STATEMENT          |          | |
|  1 |   GROUP HASH INSTANT ACCESS |          | 0 |
|  2 |     TABLE ACCESS ("LINEITEM") |          | 0 |
-----
1 - AGGREGATIONS : SUM( L_QUANTITY )
   NESTED AGGREGATIONS : MAX( SUM( L_QUANTITY ) )
   GROUPING COLUMNS : L_ORDERKEY
   RECORD COLUMNS : SUM( L_QUANTITY )
   READ COLUMNS : SUM( L_QUANTITY )
   PHYSICAL FILTER : SUM( L_QUANTITY ) > 10
   LOGICAL FILTER : MOD(SUM( L_QUANTITY ),10) = 1
2 - READ COLUMNS : L_ORDERKEY, L_QUANTITY
<<< end print plan

```

HASH AGGREGATION

- It performs the aggregation for the result of the subordinate node.
- If aggregation can not be processed in the subordinate node, a separated HASH AGGREGATION node is generated.
- Node information
 - AGGREGATIONS: An unnested aggregation list which is to be processed in a node

The following is an example.

```

gSQL> \explain plan only SELECT sum( l_quantity ) FROM orders, lineitem;
>>> start print plan
< Execution Plan >
-----
|  IDX | NODE DESCRIPTION          |          |
-----
|  0 | SELECT STATEMENT          |          | |
|  1 |   HASH AGGREGATION        |          | 0 |
|  2 |     NESTED LOOP JOIN (INNER JOIN) |          | 0 |
|  3 |       TABLE ACCESS ("LINEITEM") |          | 0 |
|  4 |       INDEX ACCESS ("ORDERS, ORDERS_PK_INDEX") |          | 0 |
-----
1 - AGGREGATIONS : SUM( L_QUANTITY )
2 - JOINED COLUMNS : LINEITEM.L_QUANTITY
3 - READ COLUMNS : L_QUANTITY
4 - READ INDEX COLUMNS : NOTHING
<<< end print plan

```

HASH JOIN (join_method)

- It performs a hash join for the two subordinate nodes.
- Inner node of a subordinate node consists of hash instants.
- IDX of the outer node is smaller than IDX of the inner node. (The outer node is displayed on top.)
- join_method
 - INNER JOIN
 - LEFT OUTER JOIN
 - FULL OUTER JOIN
 - LEFT SEMI JOIN
 - LEFT SEMI JOIN NA
 - INVERTED LEFT SEMI JOIN
 - LEFT ANTI SEMI JOIN
- Node information
 - JOINED COLUMNS: A column list which is to be a join result
 - JOIN FILTER: A filter which is to be applied as a join condition
 - WHERE FILTER: A filter which is to be applied after join operation

The following is an example.

```
gSQL> \explain plan only
      SELECT l_quantity
      FROM orders FULL OUTER JOIN lineitem
           ON o_orderkey = l_orderkey and o_orderdate <> l_shipdate
      WHERE o_orderkey > 1;
>>> start print plan
< Execution Plan >
```

IDX	NODE DESCRIPTION	ROWS
0	SELECT STATEMENT	
1	HASH JOIN (FULL OUTER JOIN)	0
2	TABLE ACCESS ("ORDERS")	0
3	HASH JOIN INSTANT ACCESS	0
4	TABLE ACCESS ("LINEITEM")	0

```

1 - JOINED COLUMNS : ORDERS.O_ORDERKEY, LINEITEM.L_QUANTITY
   JOIN FILTER : {O_ORDERDATE} <> {L_SHIPDATE}
   WHERE FILTER : ORDERS.O_ORDERKEY > 1
2 - READ COLUMNS : O_ORDERKEY, O_ORDERDATE
3 - INDEX COLUMNS : L_ORDERKEY
   TABLE COLUMNS : L_SHIPDATE, L_QUANTITY

```

```

        READ COLUMNS : L_ORDERKEY, L_SHIPDATE, L_QUANTITY
        HASH FILTER : {O_ORDERKEY} = L_ORDERKEY
4 - READ COLUMNS : L_ORDERKEY, L_QUANTITY, L_SHIPDATE
<<< end print plan

```

HASH JOIN INSTANT ACCESS

- It is the inner node of the hash join.
- It configures the hash instance for the result of the subordinate node based on the column expression which is used as a hash join condition(equi-join).
- Node information
 - INDEX COLUMNS: A column list of the hash instant which is to be a hash column
 - TABLE COLUMNS: A column list of the hash instant which excludes hash columns
 - READ COLUMNS: A column list which is to be read from the hash instant
 - HASH FILTER: An equi-join condition for the hash join
 - PHYSICAL TABLE FILTER: An AND-filter for the comparison operation which does not require the type casting and does not include INDEX COLUMNS
 - LOGICAL TABLE FILTER: An AND-filter which excludes PHYSICAL TABLE FILTER from the entire TABLE FILTER

The following is an example.

```

gSQL> \explain plan only
      SELECT /*+ USE_HASH( orders, lineitem )
            ORDERING( orders, lineitem ) */ l_quantity
      FROM orders INNER JOIN lineitem
            ON o_orderkey = l_orderkey and l_suppkey > o_orderkey
            and l_quantity * 20 > o_totalprice;

```

```
>>> start print plan
```

```
< Execution Plan >
```

IDX	NODE DESCRIPTION	ROWS
0	SELECT STATEMENT	
1	HASH JOIN (INNER JOIN)	0
2	TABLE ACCESS ("ORDERS")	0
3	HASH JOIN INSTANT ACCESS	0
4	TABLE ACCESS ("LINEITEM")	0

```

1 - JOINED COLUMNS : LINEITEM.L_QUANTITY
2 - READ COLUMNS : O_ORDERKEY, O_TOTALPRICE
3 - INDEX COLUMNS : L_ORDERKEY

```

```

TABLE COLUMNS : L_SUPPKEY, L_QUANTITY
READ COLUMNS : L_ORDERKEY, L_SUPPKEY, L_QUANTITY
HASH FILTER : {O_ORDERKEY} = L_ORDERKEY
PHYSICAL TABLE FILTER : L_SUPPKEY > {O_ORDERKEY}
LOGICAL TABLE FILTER : ( L_QUANTITY * 20 ) > {O_TOTALPRICE}
4 - READ COLUMNS : L_ORDERKEY, L_SUPPKEY, L_QUANTITY
<<< end print plan

```

HASH JOIN INSTANT ACCESS (UNIQUE)

- It configures the hash instance for the result of the subordinate node based on the column expression which is used as hash join condition(equi-join).
 - However, it configures the hash instance by excluding the duplicates based on the entire hash column list.
- It is generated when the hash join method is semi join or anti semi join.
- Node information
 - INDEX COLUMNS: A column list of the hash instant which is to be a hash column
 - TABLE COLUMNS: A column list of the hash instance which excludes the hash column
 - READ COLUMNS: A column list which is to be read from hash instant
 - HASH FILTER: An equi-join condition for the hash join
 - PHYSICAL TABLE FILTER: An AND-filter for the comparison operation which does not require the type casting and includes columns which is not INDEX COLUMNS.
 - LOGICAL TABLE FILTER: An AND-filter which excludes PHYSICAL TABLE FILTER from the entire TABLE FILTER

The following is an example.

```

gSQL> \explain plan only
SELECT o_custkey
FROM orders
WHERE o_orderkey in
( SELECT l_orderkey
FROM lineitem );
>>> start print plan
< Execution Plan >
=====
|  IDX  |  NODE DESCRIPTION                               |  ROWS  |
-----|-----|-----|
|   0   |  SELECT STATEMENT                               |         |
|   1   |  HASH JOIN (LEFT SEMI)                          |        0 |
|   2   |  TABLE ACCESS ("ORDERS")                       |        0 |
|   3   |  HASH JOIN INSTANT ACCESS (UNIQUE)              |        0 |

```

```

| 4 | TABLE ACCESS ("LINEITEM") | 0 |
=====
1 - JOINED COLUMNS : ORDERS.O_CUSTKEY
2 - READ COLUMNS : O_ORDERKEY, O_CUSTKEY
3 - INDEX COLUMNS : L_ORDERKEY
   HASH FILTER : {O_ORDERKEY} = L_ORDERKEY
4 - READ COLUMNS : L_ORDERKEY
<<< end print plan

```

INDEX ACCESS (table_name [AS alias], index_name)

- It searches for records in table_name using the index in index_name.
- Node information
 - READ INDEX COLUMNS: A referencing column list which is the index key column
 - READ TABLE COLUMNS: A referencing column list excluding the index key column
 - AGGREGATIONS: An unnested aggregation list which is to be processed in a node
 - MIN RANGE: A min key range of an index
 - MAX RANGE: A max key range of an index
 - PHYSICAL KEY FILTER: An AND-filter for the comparison which does not requires type casting and whose only target is the key column
 - LOGICAL KEY FILTER: An AND-filter in the entire KEY FILTER, except for PHYSICAL KEY FILTER
 - PHYSICAL TABLE FILTER: An AND-filter for the comparison which does not require the type casting and includes columns which are not index key columns
 - LOGICAL TABLE FILTER: An AND-filter which excludes PHYSICAL TABLE FILTER from the entire TABLE FILTER

The following is an example.

```

gSQL> \explain plan only
      SELECT /*+ INDEX( lineitem ) */ count( l_orderkey )
      FROM lineitem
      WHERE l_orderkey > 100 and l_linenumber > 0
            and mod( l_orderkey, 2 ) = 0 and l_quantity > 0
            and l_discount * l_tax > 100;
>>> start print plan
< Execution Plan >
=====
| IDX | NODE DESCRIPTION | ROWS |
=====
| 0 | SELECT STATEMENT | |
| 1 | INDEX ACCESS ("LINEITEM, LINEITEM_PK_INDEX") | 0 |
=====

```



```

-----
|  0 | INSERT STATEMENT          |          |
|  1 |   INSERT ("SUPPLIER")     |          | 0 |
=====
<<< end print plan

```

INTERSECT ALL

It performs the INTERSECT ALL operation for subordinate nodes.

The following is an example.

```

gSQL> \explain plan only
      SELECT s_suppkey FROM supplier
      INTERSECT ALL
      SELECT /*+ FULL( lineitem) */ l_suppkey FROM lineitem
      INTERSECT ALL
      SELECT ps_suppkey FROM partsupp;
>>> start print plan
< Execution Plan >
=====
|  IDX  | NODE DESCRIPTION          |          |
-----
|  0  | SELECT STATEMENT          |          | |
|  1  |   INTERSECT-ALL           |          | 0 |
|  2  |     INDEX ACCESS ("SUPPLIER, SUPPLIER_PK_INDEX") |          | 0 |
|  3  |     TABLE ACCESS ("LINEITEM") |          | 0 |
|  4  |     INDEX ACCESS ("PARTSUPP, PARTSUPP_PK_INDEX") |          | 0 |
=====
      2 - READ INDEX COLUMNS : S_SUPPKEY
      3 - READ COLUMNS : L_SUPPKEY
      4 - READ INDEX COLUMNS : PS_SUPPKEY
<<< end print plan

```

INTERSECT DISTINCT

It performs the INTERSECT DISTINCT operation for subordinate nodes.

The following is an example.

```

gSQL> \explain plan only
      SELECT s_suppkey FROM supplier

```

```

INTERSECT DISTINCT
SELECT /*+ FULL( lineitem) */ l_suppkey FROM lineitem
INTERSECT DISTINCT
SELECT ps_suppkey FROM partsupp;
>>> start print plan
< Execution Plan >
=====
|  IDX  |  NODE DESCRIPTION                               |  ROWS  |
-----|-----|-----|
|   0   |  SELECT STATEMENT                               |         |
|   1   |    INTERSECT-DISTINCT                          |         0 |
|   2   |      INDEX ACCESS ("SUPPLIER, SUPPLIER_PK_INDEX") |         0 |
|   3   |      TABLE ACCESS ("LINEITEM")                  |         0 |
|   4   |      INDEX ACCESS ("PARTSUPP, PARTSUPP_PK_INDEX") |         0 |
=====
      2 - READ INDEX COLUMNS : S_SUPPKEY
      3 - READ COLUMNS : L_SUPPKEY
      4 - READ INDEX COLUMNS : PS_SUPPKEY
<<< end print plan

```

NESTED LOOP JOIN (join_method)

- It performs a nested loop join for the two subordinate nodes.
- IDX of the outer node is smaller than IDX of the inner node. (The outer node is displayed on top.)
- join_method
 - CROSS JOIN
 - INNER JOIN
 - LEFT OUTER JOIN
 - FULL OUTER JOIN
 - LEFT SEMI JOIN
 - INVERTED LEFT SEMI JOIN
 - LEFT ANTI SEMI JOIN
- Node information
 - JOINED COLUMNS: A column list which is to be a join result
 - JOIN FILTER: A filter which is to be applied as a join condition
 - WHERE FILTER: A filter which is to be applied after join operation

The following is an example.

```

gSQL> \explain plan only
      SELECT /*+ USE_NL( orders, lineitem )
            ORDERING( orders, lineitem ) */ l_quantity

```

```

FROM orders FULL OUTER JOIN lineitem
  ON o_orderkey = l_orderkey
WHERE l_quantity > 10;
>>> start print plan
< Execution Plan >
=====
|  IDX  |  NODE DESCRIPTION                               |  ROWS  |
-----|-----|-----|
|   0   |  SELECT STATEMENT                               |         |
|   1   |  NESTED LOOP JOIN (FULL OUTER JOIN)            |         0 |
|   2   |  TABLE ACCESS ("ORDERS")                      |         0 |
|   3   |  TABLE ACCESS ("LINEITEM")                   |         0 |
=====
1 - JOINED COLUMNS : LINEITEM.L_QUANTITY
   JOIN FILTER : {O_ORDERKEY} = {L_ORDERKEY}
   WHERE FILTER : LINEITEM.L_QUANTITY > 10
2 - READ COLUMNS : O_ORDERKEY, O_TOTALPRICE
3 - READ COLUMNS : L_ORDERKEY, L_SUPPKEY, L_QUANTITY
<<< end print plan

```

SELECT STATEMENT

It performs the SELECT statement.

The following is an example.

```

gSQL> \explain plan only SELECT s_suppkey FROM supplier;
>>> start print plan
< Execution Plan >
=====
|  IDX  |  NODE DESCRIPTION                               |  ROWS  |
-----|-----|-----|
|   0   |  SELECT STATEMENT                               |         |
|   1   |  INDEX ACCESS ("SUPPLIER, SUPPLIER_PK_INDEX")  |         0 |
=====
1 - READ INDEX COLUMNS : S_SUPPKEY
<<< end print plan

```

SORT INSTANT ACCESS

- It configures the sort instance for the result of the subordinate node based on the sort key column.
- It is generated when using the ORDER BY clause or materializing the subquery in SELECT statement.

- Node information
 - SORT KEY: A column list of the sort instance to be a sort key column
 - RECORD COLUMNS: A column list of the sort instance which excludes the sort key column
 - READ COLUMNS: A column list which is read from the sort instant
 - MIN RANGE: A min key range of an index
 - MAX RANGE: A max key range of an index
 - PHYSICAL KEY FILTER: An AND-filter for the comparison which does not require type casting and whose only target is the key column
 - LOGICAL KEY FILTER: An AND-filter in the entire KEY FILTER, except for PHYSICAL KEY FILTER
 - PHYSICAL TABLE FILTER: An AND-filter for the comparison which does not require the type casting and includes columns which is not index key column
 - LOGICAL TABLE FILTER: An AND-filter which excludes PHYSICAL TABLE FILTER from the entire TABLE FILTER

The following is an example.

```
gSQL> \explain plan only
      SELECT /*+ USE_NL( lineitem, partsupp )
            ORDERING( lineitem, partsupp )*/ l_orderkey
      FROM lineitem INNER JOIN
            ( SELECT /*+ NO_QUERY_TRANSFORMATION */
              ps_partkey, ps_suppkkey, ps_availqty
            FROM partsupp OFFSET 1 )
      ON l_partkey = ps_partkey and l_suppkkey = ps_suppkkey
         and ps_suppkkey > l_suppkkey and ps_partkey + 1 > l_partkey
         and ps_availqty < l_quantity and ps_availqty * 10 > l_quantity;
>>> start print plan
< Execution Plan >
=====
|  IDX  |  NODE DESCRIPTION                               |  ROWS  |
-----|-----|-----|-----|
|   0   |  SELECT STATEMENT                               |         |
|   1   |  NESTED LOOP JOIN (INNER JOIN)                 |         0 |
|   2   |  TABLE ACCESS ("LINEITEM")                   |         0 |
|   3   |  SORT INSTANT ACCESS                         |         0 |
|   4   |  VIEW                                           |         0 |
|   5   |  TABLE ACCESS ("PARTSUPP")                   |         0 |
=====
1 - JOINED COLUMNS : LINEITEM.L_ORDERKEY
2 - READ COLUMNS : L_ORDERKEY, L_PARTKEY, L_SUPPKKEY, L_QUANTITY
3 - SORT KEY : "PARTSUPP.PS_SUPPKKEY ASC NULLS LAST",
              "PARTSUPP.PS_PARTKEY ASC NULLS LAST"
```

```

RECORD COLUMNS : PS_AVAILQTY
READ COLUMNS : PS_SUPPKEY, PS_PARTKEY, PS_AVAILQTY
  MIN RANGE : PS_SUPPKEY = {L_SUPPKEY}
              AND PS_SUPPKEY > {L_SUPPKEY}
  MAX RANGE : PS_SUPPKEY = {L_SUPPKEY}
  PHYSICAL KEY FILTER : PS_PARTKEY = {L_PARTKEY}
  LOGICAL KEY FILTER : ( PS_PARTKEY + 1 ) > {L_PARTKEY}
  PHYSICAL TABLE FILTER : PS_AVAILQTY < {L_QUANTITY}
  LOGICAL TABLE FILTER : ( PS_AVAILQTY * 10 ) > {L_QUANTITY}
4 - COLUMNS : PS_PARTKEY, PS_SUPPKEY, PS_AVAILQTY
5 - READ COLUMNS : PS_PARTKEY, PS_SUPPKEY, PS_AVAILQTY
<<< end print plan

```

SORT INSTANT ACCESS (UNIQUE)

- It configures the sort instance for the result of the subordinate node based on the sort key column.
 - However, it configures the sort instance by excluding the duplicates based on the entire sort key column list.
- The node is created when subquery result is materialized as a outer node of join.
- Node information
 - SORT KEY: A column list of the sort instance which is a sort key column
 - READ COLUMNS: A column list which is read from the sort instant

The following is an example.

```

gSQL> \explain plan only
      SELECT l_orderkey
      FROM lineitem
      WHERE EXISTS( SELECT /*+ NL_ISJ */ o_orderkey
                   FROM orders WHERE o_orderkey = l_orderkey );
>>> start print plan
< Execution Plan >
=====
|  IDX  |  NODE DESCRIPTION                               |  ROWS  |
=====
|   0   |  SELECT STATEMENT                               |         |
|   1   |  NESTED LOOP JOIN (INVERTED LEFT SEMI)         |   0    |
|   2   |  SORT INSTANT ACCESS (UNIQUE)                 |   0    |
|   3   |  INDEX ACCESS ("ORDERS, ORDERS_PK_INDEX")     |   0    |
|   4   |  INDEX ACCESS ("LINEITEM, LINEITEM_PK_INDEX") |   0    |
=====
1 - JOINED COLUMNS : LINEITEM,L_ORDERKEY

```

```

2 - SORT KEY : "ORDERS.O_ORDERKEY ASC NULLS LAST"
   READ COLUMNS : O_ORDERKEY
3 - READ INDEX COLUMNS : O_ORDERKEY
4 - READ INDEX COLUMNS : L_ORDERKEY
   MIN RANGE : L_ORDERKEY = {O_ORDERKEY}
   MAX RANGE : L_ORDERKEY = {O_ORDERKEY}

```

```
<<< end print plan
```

SORT JOIN INSTANT ACCESS

- It is the inner node of sort merge join.
- It configures the sort instance for the result of the subordinate node based on the column expression which is used as sort merge join condition (equi-join).
- Node information
 - SORT KEY: A column list of the sort instance which is a sort key column
 - RECORD COLUMNS: A column list of the sort instance which excludes the sort key column
 - READ COLUMNS: A column list which is read from the sort instant
 - MIN RANGE: The min key range of the sort instant
 - MAX RANGE: The max key range of the sort instant

The following is an example.

```

gSQL> \explain plan only
      SELECT /*+ USE_MERGE( orders, lineitem )
              ORDERING( orders, lineitem ) */ l_quantity
      FROM orders INNER JOIN lineitem
              ON o_orderkey = l_orderkey
              and l_quantity * 20 > o_totalprice;
>>> start print plan
< Execution Plan >
=====
|  IDX  |  NODE DESCRIPTION                               |  ROWS  |
-----|-----|-----|
|   0   |  SELECT STATEMENT                               |         |
|   1   |  SORT MERGE JOIN (INNER JOIN) : EQUAL           |         0 |
|   2   |  INDEX ACCESS ("ORDERS, ORDERS_PK_INDEX")       |         0 |
|   3   |  SORT JOIN INSTANT ACCESS                     |         0 |
|   4   |  TABLE ACCESS ("LINEITEM")                    |         0 |
=====
1 - JOINED COLUMNS : LINEITEM.L_QUANTITY
   MERGE FILTER : ORDERS.O_ORDERKEY = LINEITEM.L_ORDERKEY
   JOIN FILTER : ( {L_QUANTITY} * 20 ) > {O_TOTALPRICE}

```

```

2 - READ INDEX COLUMNS : O_ORDERKEY
   READ TABLE COLUMNS : O_TOTALPRICE
3 - SORT KEY : "LINEITEM.L_ORDERKEY ASC NULLS LAST"
   RECORD COLUMNS : L_QUANTITY
   READ COLUMNS : L_ORDERKEY, L_QUANTITY
   MIN RANGE : L_ORDERKEY >= {O_ORDERKEY}
   MAX RANGE : L_ORDERKEY IS NOT NULL
4 - READ COLUMNS : L_ORDERKEY, L_QUANTITY
<<< end print plan

```

SORT JOIN INSTANT ACCESS (UNIQUE)

- It configures the sort instance for the result of the subordinate node based on the column expression which is used as sort merge join condition (equi-join).
 - However, it configures the sort instance by excluding the duplicates based on the entire sort key column list.
- Node information
 - SORT KEY: A column list of the sort instance which is a sort key column
 - RECORD COLUMNS: A column list to be read from a sort instance
 - MIN RANGE: The min key range of the sort instant
 - MAX RANGE: The max key range of the sort instant

The following is an example.

```

gSQL> \explain plan only
      SELECT o_custkey
      FROM orders
      WHERE o_orderkey in
            ( SELECT /*+ MERGE_SJ FULL( lineitem ) */ l_orderkey FROM lineitem );
>>> start print plan
< Execution Plan >
=====
|  IDX  |  NODE DESCRIPTION                               |  ROWS  |
-----|-----|-----|
|   0   |  SELECT STATEMENT                               |         |
|   1   |  SORT MERGE JOIN (LEFT SEMI) : EQUAL             |         0 |
|   2   |  INDEX ACCESS ("ORDERS, ORDERS_PK_INDEX")       |         0 |
|   3   |  SORT JOIN INSTANT ACCESS (UNIQUE)           |         0 |
|   4   |  TABLE ACCESS ("LINEITEM")                     |         0 |
=====
1 - JOINED COLUMNS : ORDERS.O_CUSTKEY
   MERGE FILTER : ORDERS.O_ORDERKEY = LINEITEM.L_ORDERKEY

```

```

2 - READ INDEX COLUMNS : O_ORDERKEY
   READ TABLE COLUMNS : O_CUSTKEY
3 - SORT KEY : "LINEITEM.L_ORDERKEY ASC NULLS LAST"
   READ COLUMNS : L_ORDERKEY
   MIN RANGE : L_ORDERKEY >= {O_ORDERKEY}
   MAX RANGE : L_ORDERKEY IS NOT NULL
4 - READ COLUMNS : L_ORDERKEY

```

```
<<< end print plan
```

SORT MERGE JOIN (join_method) : EQUAL

- It performs a sort merge join for the two subordinate nodes.
- Inner node of the subordinate node consists of a sort instant.
- IDX of the outer node is smaller than IDX of the inner node. (The outer node is displayed on top.)
- join_method
 - INNER JOIN
 - LEFT OUTER JOIN
 - FULL OUTER JOIN
 - LEFT SEMI JOIN
 - LEFT ANTI SEMI JOIN
- Node information
 - JOINED COLUMNS: A column list which is to be a join result
 - MERGE FILTER: A filter which is to be used as a equi-join condition
 - JOIN FILTER: A filter which is to be applied to the join condition
 - WHERE FILTER: A filter which is to be applied after join operation

The following is an example.

```

gSQL> \explain plan only
      SELECT /*+ USE_MERGE( orders, lineitem ) */ l_quantity
      FROM orders FULL OUTER JOIN lineitem
           ON o_orderkey = l_orderkey and o_orderdate <> l_shipdate
      WHERE o_orderkey > 1;

```

```
>>> start print plan
```

```
< Execution Plan >
```

```

=====
|  IDX  |  NODE DESCRIPTION                                |  ROWS  |
-----|-----|-----|
|   0   |  SELECT STATEMENT                                |         |
|   1   |  SORT MERGE JOIN (FULL OUTER JOIN) : EQUAL      |   0    |
|   2   |  INDEX ACCESS ("ORDERS, ORDERS_PK_INDEX")       |   0    |
|   3   |  SORT JOIN INSTANT ACCESS                        |   0    |

```



```

| 4 | TABLE ACCESS ("LINEITEM") | 0 |
=====
1 - JOINED COLUMNS : ORDERS.O_ORDERKEY, LINEITEM.L_QUANTITY
   MERGE FILTER : ORDERS.O_ORDERKEY = LINEITEM.L_ORDERKEY
   JOIN FILTER : {O_ORDERDATE} <> {L_SHIPDATE}
   WHERE FILTER : ORDERS.O_ORDERKEY > 1
2 - READ INDEX COLUMNS : O_ORDERKEY
   READ TABLE COLUMNS : O_ORDERDATE
3 - SORT KEY : "LINEITEM.L_ORDERKEY ASC NULLS LAST"
   RECORD COLUMNS : L_SHIPDATE, L_QUANTITY
   READ COLUMNS : L_ORDERKEY, L_SHIPDATE, L_QUANTITY
4 - READ COLUMNS : L_ORDERKEY, L_QUANTITY, L_SHIPDATE
<<< end print plan

```

SUB QUERY FUNCTION

- It processes the function which includes a subquery.
- Node information
 - FUNCTION: A function expression

The following is an example.

```

gSQL> \explain plan only
      SELECT exists ( SELECT /*+ FULL( lineitem ) */ l_orderkey
      FROM lineitem
      WHERE o_orderkey = l_orderkey ) FROM orders;
>>> start print plan
< Execution Plan >
=====
|  IDX  |  NODE DESCRIPTION                               |  ROWS  |
-----|-----|-----|
|  0  |  SELECT STATEMENT                               |         |
|  1  |  INDEX ACCESS ("ORDERS, ORDERS_PK_INDEX")       |         0 |
|  2  |  SUB QUERY LIST                                 |         0 |
|  3  |  SUB QUERY FUNCTION                             |         0 |
|  4  |  TABLE ACCESS ("LINEITEM")                     |         0 |
=====
1 - READ INDEX COLUMNS : O_ORDERKEY
3 - FUNCTION : EXISTS( ( L_ORDERKEY ) )
4 - READ COLUMNS : L_ORDERKEY
   PHYSICAL FILTER : {O_ORDERKEY} = L_ORDERKEY
<<< end print plan

```

SUB QUERY FUNCTION (MATERIALIZED)

- It processes the function after materializing the subquery result.
- Node information
 - FUNCTION: A function expression

The following is an example.

```
gSQL> \explain plan only
      SELECT o_orderkey in
          ( SELECT /*+ FULL( lineitem ) */ l_orderkey FROM lineitem )
      FROM orders;
>>> start print plan
< Execution Plan >
=====
|  IDX  |  NODE DESCRIPTION                               |  ROWS  |
-----|-----|-----|
|   0   |  SELECT STATEMENT                               |         |
|   1   |  INDEX ACCESS ("ORDERS, ORDERS_PK_INDEX")       |         0 |
|   2   |  SUB QUERY LIST                                 |         0 |
|   3   |  SUB QUERY FUNCTION (MATERIALIZED)           |         0 |
|   4   |  TABLE ACCESS ("LINEITEM")                   |         0 |
=====
      1 - READ INDEX COLUMNS : O_ORDERKEY
      3 - FUNCTION : ( O_ORDERKEY ) IN ( L_ORDERKEY )
      4 - READ COLUMNS : L_ORDERKEY
<<< end print plan
```

SUB QUERY LIST

- It executes subqueries and transfers the results to the superordinate node.
- It makes an outer column, if exists, a constant, and transfers it to the superordinate node.
 - The subordinate node column which is referenced by the superordinate node is the outer column.
- Node information
 - READ COLUMNS: A column list consists of an outer column.

The following is an example.

```
gSQL> \explain plan only
      SELECT ( SELECT count(*) FROM lineitem ) = count(*) FROM orders;
>>> start print plan
< Execution Plan >
```

```

=====
|  IDX  |  NODE DESCRIPTION                               |  ROWS  |
=====
|   0   |  SELECT STATEMENT                               |         |
|   1   |  INDEX ACCESS ("ORDERS, ORDERS_PK_INDEX")       |        0 |
|   2   |  SUB QUERY LIST                               |        0 |
|   3   |  INDEX ACCESS ("LINEITEM, LINEITEM_PK_INDEX")  |        0 |
=====

1 - READ INDEX COLUMNS : NOTHING
   AGGREGATIONS : COUNT(*)
2 - READ COLUMNS : COUNT(*)
3 - READ INDEX COLUMNS : NOTHING
   AGGREGATIONS : COUNT(*)
<<< end print plan

```

TABLE ACCESS (table_name [AS alias])

- It searches for records in table_name.
- Node information
 - READ COLUMNS: A referencing column list
 - AGGREGATIONS: An unnested aggregation list which is to be processed in a node
 - PHYSICAL FILTER: An AND-filter for the comparison operation which does not require type casting
 - LOGICAL FILTER: An AND-filter in the entire TABLE FILTER, except for PHYSICAL FILTER

The following is an example.

```

gSQL> \explain plan only
      SELECT /*+ FULL( lineitem ) */ count( l_orderkey )
      FROM lineitem
      WHERE l_orderkey > 0
             and l_quantity * l_extendedprice > 100;
>>> start print plan
< Execution Plan >

=====
|  IDX  |  NODE DESCRIPTION                               |  ROWS  |
=====
|   0   |  SELECT STATEMENT                               |         |
|   1   |  TABLE ACCESS ("LINEITEM")                     |        0 |
=====

1 - READ COLUMNS : L_ORDERKEY, L_QUANTITY, L_EXTENDEDPRICE
   AGGREGATIONS : COUNT( L_ORDERKEY )

```

```
PHYSICAL FILTER : L_ORDERKEY > 0
```

```
LOGICAL FILTER : ( L_QUANTITY * L_EXTENDEDPRICE ) > 100
```

```
<<< end print plan
```

UNION ALL

It performs the UNION ALL operation for the subordinate nodes.

The following is an example.

```
gSQL> \explain plan only
      SELECT s_suppkey FROM supplier
      UNION ALL
      SELECT /*+ FULL( lineitem) */ l_suppkey FROM lineitem
      UNION ALL
      SELECT ps_suppkey FROM partsupp;
>>> start print plan
< Execution Plan >
=====
|  IDX  |  NODE DESCRIPTION                               |  ROWS  |
-----|-----|-----|
|   0   |  SELECT STATEMENT                               |         |
|   1   |    UNION-ALL                                   |         0 |
|   2   |      INDEX ACCESS ("SUPPLIER, SUPPLIER_PK_INDEX") |         0 |
|   3   |      TABLE ACCESS ("LINEITEM")                 |         0 |
|   4   |      INDEX ACCESS ("PARTSUPP, PARTSUPP_PK_INDEX") |         0 |
=====
      2 - READ INDEX COLUMNS : S_SUPPKEY
      3 - READ COLUMNS : L_SUPPKEY
      4 - READ INDEX COLUMNS : PS_SUPPKEY
<<< end print plan
```

UNION DISTINCT

It performs the UNION DISTINCT operation for the subordinate nodes.

The following is an example.

```
gSQL> \explain plan only
      SELECT s_suppkey FROM supplier
      UNION DISTINCT
      SELECT /*+ FULL( lineitem) */ l_suppkey FROM lineitem
```

```

UNION DISTINCT
SELECT ps_suppkey FROM partsupp;
>>> start print plan
< Execution Plan >
=====
|  IDX  |  NODE DESCRIPTION                               |  ROWS  |
=====
|   0   |  SELECT STATEMENT                               |         |
|   1   |    UNION-DISTINCT                             |         0 |
|   2   |      INDEX ACCESS ("SUPPLIER, SUPPLIER_PK_INDEX") |         0 |
|   3   |      TABLE ACCESS ("LINEITEM")                 |         0 |
|   4   |      INDEX ACCESS ("PARTSUPP, PARTSUPP_PK_INDEX") |         0 |
=====
      2 - READ INDEX COLUMNS : S_SUPPKEY
      3 - READ COLUMNS : L_SUPPKEY
      4 - READ INDEX COLUMNS : PS_SUPPKEY
<<< end print plan

```

UPDATE STATEMENT

- It performs the UPDATE statement.
- It has the subordinate node, **UPDATE (table_name)**.

The following is an example.

```

gSQL> \explain plan only UPDATE lineitem SET l_quantity = l_quantity + 1;
>>> start print plan
< Execution Plan >
=====
|  IDX  |  NODE DESCRIPTION                               |  ROWS  |
=====
|   0   |  UPDATE STATEMENT                             |         |
|   1   |    UPDATE ("LINEITEM")                         |         0 |
|   2   |      TABLE ACCESS ("LINEITEM")                 |         0 |
=====
      2 - READ COLUMNS : L_QUANTITY
<<< end print plan

```

UPDATE (table_name)

It performs the UPDATE operation for the specified table.

The following is an example.

```
gSQL> \explain plan only UPDATE lineitem SET l_quantity = l_quantity + 1;
>>> start print plan
< Execution Plan >
=====
|  IDX  |  NODE DESCRIPTION                               |  ROWS  |
-----|-----|-----|
|   0   |  UPDATE STATEMENT                               |         |
|   1   |  UPDATE ("LINEITEM")                           |    0    |
|   2   |  TABLE ACCESS ("LINEITEM")                     |    0    |
=====
      2 - READ COLUMNS : L_QUANTITY
<<< end print plan
```

USER ROWID ACCESS (table_name [AS alias])

- It searches for a single record which matches the given rowid.
- Node information
 - READ COLUMNS: A referencing column list
 - AGGREGATIONS: An unnested aggregation list which is to be processed in a node
 - ROWID ACCESS EXPR: A rowid expression to be searched
 - PHYSICAL FILTER: An AND-filter for the comparison operation which does not require type casting
 - LOGICAL FILTER: An AND-filter in the entire TABLE FILTER, except for PHYSICAL FILTER

The following is an example.

```
gSQL> \explain plan only
      SELECT /*+ ROWID( T1 ) */ COUNT( l_orderkey )
      FROM lineitem
      WHERE rowid = null and l_orderkey > 0
             and l_quantity * l_extendedprice > 100;
>>> start print plan
< Execution Plan >
=====
|  IDX  |  NODE DESCRIPTION                               |  ROWS  |
-----|-----|-----|
|   0   |  SELECT STATEMENT                               |         |
|   1   |  USER ROWID ACCESS ("LINEITEM")                 |    0    |
=====
```

```

=====
1 - READ COLUMNS : L_ORDERKEY, L_QUANTITY, L_EXTENDEDPRICE
  AGGREGATIONS : COUNT( L_ORDERKEY )
  ROWID ACCESS EXPR : ROWID = NULL
  PHYSICAL FILTER : L_ORDERKEY > 0
  LOGICAL FILTER : ( L_QUANTITY * L_EXTENDEDPRICE ) > 100

```

```
<<< end print plan
```

VIEW

- It performs a subordinate node which consists of inline view.
- Node information
 - COLUMNS: A referencing column list
 - FILTER: An AND-filter for the result of a view query

The following is an example.

```

gSQL> \explain plan only
SELECT /*+ ORDERED FULL( T1 ) */ count(*)
FROM lineitem AS T1,
     ( SELECT /*+ FULL( lineitem ) */ l_orderkey key FROM lineitem
       UNION ALL
       SELECT /*+ FULL( orders ) */ o_orderkey FROM orders )
WHERE key = 1 or key = 2;

```

```
>>> start print plan
```

```
< Execution Plan >
```

```

=====
|  IDX  |  NODE DESCRIPTION                               |  ROWS  |
=====
|  0  |  SELECT STATEMENT                               |        |
|  1  |  HASH AGGREGATION                               |    0   |
|  2  |  NESTED LOOP JOIN (INNER JOIN)                 |    0   |
|  3  |  TABLE ACCESS ("LINEITEM AS T1")              |    0   |
|  4  |  VIEW                                           |    0   |
|  5  |  UNION-ALL                                       |    0   |
|  6  |  TABLE ACCESS ("LINEITEM")                    |    0   |
|  7  |  TABLE ACCESS ("ORDERS")                      |    0   |
=====

```

```

1 - AGGREGATIONS : COUNT(*)
2 - JOINED COLUMNS : NOTHING
3 - READ COLUMNS : NOTHING
4 - COLUMNS : L_ORDERKEY

```

```

          FILTER : LINEITEM.L_ORDERKEY = 1 OR LINEITEM.L_ORDERKEY = 2
6  -  READ COLUMNS : L_ORDERKEY
7  -  READ COLUMNS : O_ORDERKEY
<<< end print plan

```

VIEW (view_name)

- It performs inline view, or a view with the view name.
- Node information
 - COLUMNS: A referencing column list
 - FILTER: An AND-filter for the result of querying a view

The following is an example.

```

gSQL> \explain plan only
      SELECT /*+ ORDERING( T1, V1 ) FULL( T1 ) */ count(*)
      FROM ( SELECT /*+ FULL( lineitem ) */ l_orderkey key FROM lineitem
            UNION ALL
            SELECT /*+ FULL( orders ) */ o_orderkey FROM orders ) V1,
            lineitem AS T1
      WHERE V1.key = 1 or V1.key = 2;
>>> start print plan
< Execution Plan >
=====
|  IDX  |  NODE DESCRIPTION                                |  ROWS  |
-----|-----|-----|
|   0   |  SELECT STATEMENT                                |         |
|   1   |    HASH AGGREGATION                              |         0 |
|   2   |      NESTED LOOP JOIN (INNER JOIN)                |         0 |
|   3   |        TABLE ACCESS ("LINEITEM AS T1")          |         0 |
|   4   |          VIEW ("V1")                              |         0 |
|   5   |            UNION-ALL                              |         0 |
|   6   |              TABLE ACCESS ("LINEITEM")          |         0 |
|   7   |                TABLE ACCESS ("ORDERS")          |         0 |
=====
1  -  AGGREGATIONS : COUNT(*)
2  -  JOINED COLUMNS : NOTHING
3  -  READ COLUMNS : NOTHING
4  -  COLUMNS : L_ORDERKEY
          FILTER : LINEITEM.L_ORDERKEY = 1 OR LINEITEM.L_ORDERKEY = 2
6  -  READ COLUMNS : L_ORDERKEY
7  -  READ COLUMNS : O_ORDERKEY

```

|| <<< end print plan

15.5 SQL Trace Log

Overview

An SQL trace log is a log which records the analizable information of a user's query execution. SQL trace log is created in `$GOLDILOCKS_DATA/trc` directory. They are classified as a process ID and a session ID, and each of them is separately created. SQL trace log consists of the several information such as the user query, SQL execution plan, SQL processing time of each procedure, and they are output to the file.

Output

To output the SQL trace log, the `TRACE_LOG_ID` property value should be set by using the `ALTER SESSION` or the `ALTER SYSTEM` statement. For more information about the set value, refer to **TRACE_LOG_ID** of the server property.

A trace log can record both a successful SQL query and a failed SQL query, and this is set by combining the flag value of the `TRACE_LOG_ID`.



A failed SQL query is the query which is failed during the execution (The execution phase of **SQL Processing**) after a execution plan is determined through parsing, validation, optimization of an SQL statement. Therefore, the query which failed before the determination of the query execution plan does not record the trace log.

The following is an example of output the SQL trace log by using the `TRACE_LOG_ID` property.

- It outputs a successful SQL query and a failed SQL query.

```
gSQL> ALTER SESSION SET TRACE_LOG_ID = 110000;  
Session altered.
```

- It outputs a successful SQL query and a bind value.

```
gSQL> ALTER SYSTEM SET TRACE_LOG_ID = 100010;  
System altered.
```

`TRACE_LOG_ID` is a property which is used to output SQL trace log. If `TRACE_LOG_ID` is set to `ALTER SESSION`, then it is applied only to the corresponding session. If `TRACE_LOG_ID` is set to `ALTER SYSTEM`, the

n it is applied to all sessions of all processes which are connected to the server. Therefore, ALTER SESSION is used to retrieve SQL trace log of the current session. ALTER SYSTEM is used to retrieve SQL trace log of other processes or sessions in progress.



Note that if many processes and sessions are connected to the server when ALTER SYSTEM is set, then SQL trace log files are generated as many as that. Therefore, be cautious when using ALTER SYSTEM.

The SQL trace log file is created under *trc* directory. The rule for the file name is as follows.

```
opt_p[processID]_s[sessionID].trc
```

opt is added to the front of the file name, and it is followed by *p* identifier along with process ID, and the *s* identifier with session ID follows it. The delimiter is - and the file extension is *trc*.

If the amount of information generated in the same session of the same process exceeds the maximum size of the SQL trace log file, the old information changes the file name by adding current time to the end of the file name. Then it keeps recording by making a new file with current file name.

The following is an example of the SQL trace log file name.

```
opt_p17104_s12.trc
```

Output Format

SQL trace logs are classified as <SQL query string>, <execution plan>, <execution type>, <bind param value>, and <time info>.

<SQL Query String>

It outputs queries which are input by the user together with the current time, its success or failure, and the query processing time.

```
[The current time] [success or failure][the query processing time] SQL statement
```

[The current time] is an output of the data and the time up to us unit, [success or failure] is output an S (success) or a F (failure). The query processing time is output in us unit, and the SQL statement is a statement input by a user.

By the way, if the **TRACE_LOG_TIME_DETAIL** property is not set to *ON*, then the query processing time is measured in 10 ms unit. Be cautious when setting this property to *ON* because it may degrade the query

processing performance.

<Execution Plan>

It outputs the execution plan for the SQL statement. It is almost as same as **SQL Execution Plan**, and the total time column is additionally output on the execution plan node table.

The total time which is output on the statement is the time to perform all queries. The total time which is output on each other node is the time to respectively perform the query in each node, and the total time is output in 10 ms units.

The `TRACE_LOG_TIME_DETAIL` property is used to output more detailed output time. Be cautious when setting this property to `ON` because it may degrade the query processing performance.

<Execution Type>

It is the execution form of the SQL statement. It outputs `DIRECT EXECUTE`, if the query is directly executed, and outputs `PREPARE EXECUTE`, if the query is executed by using `prepare`.

<Bind Param Value>

It outputs the information of bind param value when bind param value is used in the SQL statement. It outputs `No Bind Param` when bind param value is not used in the SQL statement.

<Time Info>

It outputs the execution time for each phase of SQL process. The time info is separately output into module, time, rate, and call. Module outputs the phase name such as parse, validate. Time outputs the actual execution time and rate outputs the ratio of the each step's execution time to the total execution time. Call outputs the number of times which each phase is called.

Module is divided to the seven phases and the total. The seven phases are parse, validate, code opt, optimizer, data opt, execute, and fetch.

Parse is a step of parsing the query, and validate is a step of validating the parsed query. Code opt is a pre processing step for performing SQL optimizer, and optimizer is a step of performing the actual SQL optimizer. Data opt is a step of preparing for the actual SQL execution plan, and execute is a step of executing SQL execution plan. Fetch is a step of collecting and returning the results of queries such as `SELECT` statements.

If the plan cache is used, then validate, code opt, optimizer may not be called. Time which is less than 10 ms outputs zero because time outputs in 10 ms units. Rate is the ratio of the execution time of each step to the total execution time, so the total is 100 %, and it outputs the ratio of dividing each step's execution

n time by total. If each step's execution time is zero, the rate outputs 0 %.

The `TRACE_LOG_TIME_DETAIL` property can be used to output more detailed time. Be cautious when setting this property to `ON` because it may degrade the query processing performance.

Examples

The following is an SQL statement without the bind param value.

```
SELECT O_TOTALPRICE, O_ORDERDATE, L_QUANTITY
FROM ORDERS, LINEITEM
WHERE O_ORDERKEY = L_ORDERKEY
AND O_ORDERDATE >= DATE '1996-01-01'
AND L_SHIPMODE = 'AIR';
```

The following is an SQL trace log which is output when performing the SQL statement above after set the `TRACE_LOG_ID` to 101111.

```
[2017-05-25 12:27:59.199657] [S][0.000000] SELECT O_TOTALPRICE, O_ORDERDATE, L_QUANTITY
FROM ORDERS, LINEITEM
WHERE O_ORDERKEY = L_ORDERKEY
AND O_ORDERDATE >= DATE '1996-01-01'
AND L_SHIPMODE = 'AIR'
```

< Execution Plan >

```
=====
|  IDX  |  NODE DESCRIPTION                               |  ROWS  | Total Time |
=====
|   0   |  SELECT STATEMENT                               |         | 0:00:00.00 |
|   1   |  NESTED LOOP JOIN (INNER JOIN)                 |         | 0:00:00.00 |
|   2   |  TABLE ACCESS ("LINEITEM")                   |         | 0:00:00.00 |
|   3   |  INDEX ACCESS ("ORDERS, ORDERS_PK_INDEX")     |         | 0:00:00.00 |
=====

1 - JOINED COLUMNS : ORDERS.O_TOTALPRICE, ORDERS.O_ORDERDATE, LINEITEM.L_QUANTITY
2 - READ COLUMNS : L_ORDERKEY, L_QUANTITY, L_SHIPMODE
   PHYSICAL FILTER : L_SHIPMODE = 'AIR'
3 - READ INDEX COLUMNS : O_ORDERKEY
   READ TABLE COLUMNS : O_TOTALPRICE, O_ORDERDATE
   MIN RANGE : O_ORDERKEY = {L_ORDERKEY}
   MAX RANGE : O_ORDERKEY = {L_ORDERKEY}
   PHYSICAL TABLE FILTER : O_ORDERDATE >= CAST( '1996-01-01' AS DATE )
```

```

< Execution Type >
-----
DIRECT EXECUTE
< Bind Param Value >
-----
No Bind Param.
< Time Info >
=====
| Module      | Time          | Rate          | Call |
-----
| Parse       | 0:00:00.00   | 0.00 %       | 1 |
| Validate    | 0:00:00.00   | 0.00 %       | 1 |
| Code Opt    | 0:00:00.00   | 0.00 %       | 1 |
| Optimizer   | 0:00:00.00   | 0.00 %       | 1 |
| Data Opt    | 0:00:00.00   | 0.00 %       | 1 |
| Execute     | 0:00:00.00   | 0.00 %       | 1 |
| Fetch       | 0:00:00.00   | 0.00 %       | 1 |
| Total       | 0:00:00.00   | 100.00 %    |    |
=====

```

The following is an SQL statement with the bind param value.

```

SELECT L_QUANTITY
FROM LINEITEM
WHERE L_SHIPMODE = :V1;

```

The following is an SQL trace log which is output when performing the SQL statement above after setting the TRACE_LOG_ID to 101111.

```

[2017-05-25 12:27:59.200204] [S][0.000000] SELECT L_QUANTITY
FROM LINEITEM
WHERE L_SHIPMODE = :V1
< Execution Plan >
=====
|  IDX  |  NODE DESCRIPTION                               |  ROWS  | Total Time |
-----
|   0   |  SELECT STATEMENT                               |         | 0:00:00.00 |
|   1   |  TABLE ACCESS ("LINEITEM")                     |   0    | 0:00:00.00 |
=====
1 - READ COLUMNS : L_QUANTITY, L_SHIPMODE
   PHYSICAL FILTER : L_SHIPMODE = :V1
< Execution Type >

```

DIRECT EXECUTE

< Bind Param Value >

1 - :V1(IN, "AIR")

< Time Info >

```
=====
| Module      | Time          | Rate          | Call |
|-----|-----|-----|-----|
| Parse       | 0:00:00.00   | 0.00 %       | 1 |
| Validate    | 0:00:00.00   | 0.00 %       | 1 |
| Code Opt    | 0:00:00.00   | 0.00 %       | 1 |
| Optimizer   | 0:00:00.00   | 0.00 %       | 1 |
| Data Opt    | 0:00:00.00   | 0.00 %       | 1 |
| Execute     | 0:00:00.00   | 0.00 %       | 1 |
| Fetch       | 0:00:00.00   | 0.00 %       | 1 |
| Total       | 0:00:00.00   | 100.00 %    |    |
=====
```

16.

SQL References

16.1 ALTER AUDIT POLICY

Function

It adds an auditing target to an audit policy object, or drops an auditing target from an audit policy object.

Syntax

```

<alter audit policy statement> ::=
    ALTER AUDIT POLICY policy_name
    { <add_audit_option> | <drop_audit_option> }
    ;
<add_audit_option> ::=
    ADD { <privilege_audit_clause> | <action_audit_clause> | <privilege_audit_clause>
<action_audit_clause> }
<drop_audit_option> ::=
    DROP { <privilege_audit_clause> | <action_audit_clause> | <privilege_audit_clause>
<action_audit_clause> }
<privilege_audit_clause> ::=
    PRIVILEGES <database_privilege> [, ...]
<action_audit_clause> ::=
    ACTIONS { <object_action_audit> | <system_action_audit> } [, ...]
<object_action_audit> ::=
    ALL ON [schema_name.]object_name
    | <object_action> ON [schema_name.]object_name
<system_action_audit> ::=
    ALL
    | <system_action>

```

Invocation and Access Rules

AUDIT SYSTEM ON DATABASE privilege is required to perform <alter audit policy statement>.

Syntax Rules and Parameters

policy_name

It is the name of an audit policy object to be altered.

<add_audit_option>

It adds an auditing target to an audit policy.

<drop_audit_option>

It drops an auditing target from an audit policy.

<privilege_audit_clause>

For more information, refer to **CREATE AUDIT POLICY**.

<action_audit_clause>

For more information, refer to **CREATE AUDIT POLICY**.

Description

It can alter an audit policy which is already activated, and it does not effect the existing session but it effects only the newly created session.



When dropping ALL option as follows, not all actions are dropped, but only the corresponding ALL option is dropped.

```
CREATE AUDIT POLICY p1
  ACTIONS ALL ON u1.t1,
  SELECT ON u1.t1;
ALTER AUDIT POLICY p1 DROP
  ACTIONS ALL ON u1.t1;
```

Examples

The following is an example of adding a new audit option to an audit policy.

```
ALTER AUDIT POLICY policy_dml  
    ADD ACTIONS SELECT ON u1.t1;
```

The following is an example of dropping an audit option from an audit policy.

```
ALTER AUDIT POLICY policy_dml  
    DROP ACTIONS SELECT ON u1.t1;
```

Compatibility

The SQL standard does not have the audit policy.

For More Information

Refer to the followings.

- Managing audit policy object
 - **CREATE AUDIT POLICY**
 - **DROP AUDIT POLICY**
 - **ALTER AUDIT POLICY**
- Activating/ deactivating audit policy
 - **AUDIT POLICY**
 - **NOAUDIT POLICY**
- Enquiring audit trail: **AUDIT_TRAIL**
- Dropping audit trail: **ALTER DATABASE CLEAR AUDIT TRAIL**

16.2 ALTER CLUSTER GROUP name ADD MEMBER

Function

It adds a cluster member to a cluster group.

Syntax

```
<alter cluster group add member statement> ::=  
    ALTER CLUSTER GROUP group_name ADD  
        <cluster member definition> [, ...]  
    ;  
<cluster member definition> ::=  
    CLUSTER MEMBER member_name <connection attribute>  
<connection attribute> ::  
    HOST 'address' PORT port_no
```

Invocation and Access Rules

It can be performed in a cluster system.

ADMINISTRATION ON DATABASE privilege is required to perform <alter cluster group add member statement>.

Syntax Rules and Parameters

group_name

It is the cluster group name.

⟨cluster member definition⟩

It defines a cluster member to be included in a cluster group.
A cluster group may include maximum 32 cluster members.

member_name

It is the name of a cluster member.

The cluster member name should be as same as the member name which was defined when the database of that cluster member was created.

There should not be the same cluster group, nor the same cluster member.

The length of the name should be shorter than 128 bytes.

The start-up phase for the cluster member should be OPEN.

⟨connection attribute⟩

It defines the connection information for the communication between the cluster members.

⟨connection attribute⟩ should be as same as the HOST and PORT which were defined when the database of that cluster member was created.

The combination of HOST and PORT should be unique in the cluster system.

- HOST 'address' uses ip v4 type.
- PORT port_no should be in the range between 1024 ~ 49151.

Description

⟨alter cluster group add member statement⟩ statement does not rebalance shards in the tables.

The following statement should be performed to rebalance shards on the added cluster member.

- ALTER DATABASE REBALANCE
- ALTER TABLE name REBALANCE

Examples

The following is an example of adding two cluster members to a cluster group.

```
gSQL>  
ALTER CLUSTER GROUP g1 ADD  
    CLUSTER MEMBER g1n3 HOST '192.168.0.13' PORT 10130,  
    CLUSTER MEMBER g1n4 HOST '192.168.0.14' PORT 10140  
;  
Cluster Group altered.
```

Compatibility

The SQL standard does not define the concepts of the cluster.

For More Information

Refer to the followings.

- **CREATE CLUSTER GROUP**
- **DROP CLUSTER GROUP**
- **ALTER DATABASE REBALANCE**
- **ALTER TABLE name REBALANCE**

16.3 ALTER CLUSTER GROUP name OFFLINE MEMBER

Function

It sets a cluster member of the cluster group to offline.

Syntax

```
<alter cluster group offline member statement> ::=  
    ALTER CLUSTER GROUP group_name OFFLINE  
        <cluster member definition>  
    ;  
<cluster member definition> ::=  
    CLUSTER MEMBER member_name  
    ;
```

Invocation and Access Rules

It can be performed in a cluster system.

ADMINISTRATION ON DATABASE privilege is required to perform <alter cluster group offline member statement>.

Syntax Rules and Parameters

group_name

It is the cluster group name.

<cluster member definition>

It defines a cluster member to be included in a cluster group.
A cluster group may include maximum 32 cluster members.

member_name

It is the name of a cluster member.

The cluster member name should be as same as the member name which was defined when the database of that cluster member was created.

There should not be the same cluster group, nor the same cluster member.

The length of the name should be shorter than 128 bytes.

The start-up phase for the cluster member should be OPEN.

Description

<alter cluster group offline member statement> statement does not rebalance shards in the tables.

Examples

The following is an example of setting a specific cluster member to offline.

```
gSQL>  
ALTER CLUSTER GROUP g1 OFFLINE  
    CLUSTER MEMBER g1n3  
;  
Cluster Group altered.
```

Compatibility

The SQL standard does not define the concepts of the cluster.

For More Information

Refer to the followings.

- `CREATE CLUSTER GROUP`
- `DROP CLUSTER GROUP`
- `ALTER DATABASE REBALANCE`
- `ALTER TABLE name REBALANCE`

16.4 ALTER CLUSTER LOCATION

Function

It alters a cluster location information.

Syntax

```
<alter cluster location statement> ::=  
    ALTER CLUSTER LOCATION member_name  
    <cluster connection attribute>  
    ;  
<cluster connection attribute> ::  
    HOST 'address' PORT port_no
```

Invocation and Access Rules

It can be performed in a cluster system.

ADMINISTRATION ON DATABASE privilege is required to perform <alter cluster location statement>.

Syntax Rules and Parameters

member_name

It is the name of a cluster member.

The same cluster member name should exist in the registered cluster location information.

The length of the name should be shorter than 128 bytes.

<cluster connection attribute>

It defines the connection information for the communication between the cluster members.

The combination of HOST and PORT should be unique in the cluster system.

- HOST 'address' uses ip v4 type.
- PORT port_no should be in the range between 1024 ~ 49151.

Description

If the connection information of the cluster location is altered, the cluster member does not need to be dropped or recreated, but the connection information can be altered by using **ALTER CLUSTER LOCATION**.

Examples

```
gSQL>  
ALTER CLUSTER LOCATION g1n2  
    HOST '192.168.0.12' PORT 10120,  
;  
Created
```

Compatibility

The SQL standard does not define the concepts of the cluster.

For More Information

Refer to the followings.

- **CREATE CLUSTER LOCATION**
- **DROP CLUSTER LOCATION**

16.5 ALTER DATABASE ADD LOGFILE

Function

It adds log file groups or log file members to the database.

Syntax

```

<alter database add logfile statement> ::=
    <add logfile member statement>
  | <add logfile group statement>
  ;

<add logfile member statement> ::=
    ALTER DATABASE ADD LOGFILE MEMBER <add logfile clause> [, ...] TO
      <group clause>

<add logfile group statement> ::=
    ALTER DATABASE ADD LOGFILE <group clause> ( 'logfile_name' [, ...] )
      <size clause> [ REUSE ]

<group clause> ::=
    GROUP integer

<add logfile clause> ::=
    'logfile_name' [ REUSE ]

<size clause> ::=
    integer [ M | G ]

```

Invocation and Access Rules

ALTER DATABASE ON DATABASE privilege is required to perform <alter database add logfile statement>.

Syntax Rules and Parameters

⟨alter database add logfile statement⟩

The database should be in MOUNT phase.

⟨add logfile member statement⟩

The log member is added to an existing log file group.

- ⟨add logfile clause⟩
 - 'logfile_name' is the file name of logfile member to be added to the log file group.
 - If the file does not exist, a new file is created.
 - The length of the logfile_name should be shorter than 1024 bytes.
- ⟨group clause⟩
 - It specifies the identifier of the logfile group to be added to the database.
 - Integer should be an identifier of the existing logfile group.
 - If an identifier for the integer does not exist, an error occurs.

⟨add logfile group statement⟩

It adds a new log file group.

- It is added as the next group of the CURRENT log file group.
- ⟨group clause⟩
 - It specifies the identifier of the logfile group to be added to the database.
 - Integer should be an identifier of the unexisting logfile group.
 - If an identifier for the integer exists, an error occurs.
- ⟨size clause⟩
 - The file size can be specified minimum of 10 MB to maximum of 10 GB.
 - The file size should be bigger than the sum of redo log buffer size and pending log buffer size.
- When 'logfile_name' already exists, and the REUSE option is used, if the file size is as same as another group member, then the existing log file is reused.

Description

It is recommended to back up the control file just in case for the file damage because the newly added log file groups and log members are stored in the control file.

Examples

The following is an example of adding two log file members to an existing log file group 3.

```
ALTER DATABASE ADD LOGFILE MEMBER 'logfile1.log', 'logfile2.log' TO GROUP 3;
```

The following is an example of adding a new log file group 4 to database. The size of log file group 4 is 100 M, and the log file name is 'logfile1.log'.

```
ALTER DATABASE ADD LOGFILE GROUP 4 ( 'logfile1.log' ) SIZE 100M;
```



When adding a log group, a single log file should be used, and multiple log files can be added to an existing group as a member.

Compatibility

The SQL standard does not define ALTER DATABASE statement.

For More Information

Refer to the followings.

- ALTER DATABASE ADD LOGFILE
- ALTER DATABASE DROP LOGFILE
- ALTER DATABASE RENAME LOGFILE

16.6 ALTER DATABASE ARCHIVELOG

Function

It alters an archive setting of the online log file in the database.

Syntax

```
<alter database archivelog statement> ::=  
    ALTER DATABASE { ARCHIVELOG | NOARCHIVELOG }  
    ;
```

Invocation and Access Rules

ALTER DATABASE ON DATABASE privilege is required to perform <alter database archivelog statement>.

Syntax Rules and Parameters

<alter database archivelog statement>

- The database should be in MOUNT phase.
- ARCHIVELOG
 - It archives the online log file.
- NOARCHIVELOG
 - It does not archive the online log file.

Description

For the database backup and the media recovery using the backup, the system should be operated in ARCHIVELOG mode.

Example

The following is an example of how to set up a database to archive mode.

```
ALTER DATABASE ARCHIVELOG;
```

Compatibility

The SQL standard does not define ALTER DATABASE statement.

For More Information

Refer to the followings.

- ALTER DATABASE BACKUP
- ALTER TABLESPACE name BACKUP

16.7 ALTER DATABASE BACKUP

Function

The backup state is set to ACTIVE or INACTIVE to perform a full backup of the database. Then, the incremental database backup and control file backup are performed.

Syntax

```

<alter database backup statement> ::=
    <database begin backup statement>
  | <database end backup statement>
  | <database incremental backup statement>
  | <database controlfile backup statement>
  ;

<database begin backup statement> ::=
    ALTER DATABASE BEGIN BACKUP [ AT <domain name> ]
  ;

<database end backup statement> ::=
    ALTER DATABASE END BACKUP [ AT <domain name> ]
  ;

<database incremental backup statement> ::=
    ALTER DATABASE BACKUP INCREMENTAL
      <incremental backup option> [ AT <domain name> ]    ;

<incremental backup option> ::=
    LEVEL integer [ CUMULATIVE | DIFFERENTIAL ]

<database controlfile backup statement> ::=
    ALTER DATABASE BACKUP CONTROLFILE TO 'target_name'
      [ AT <domain name> ]    ;

```

Invocation and Access Rules

ALTER DATABASE ON DATABASE privilege is required to perform <alter database backup statement>.

Syntax Rules and Parameters

⟨database begin backup clause⟩

The database is set to the state which the full backup is available.

- All tablespaces in ONLINE state, which is created and used in the database, are set to the state of which the full backup is available.
- The database should be OPEN state and operated in ARCHIVELOG mode.
- After starting BEGIN BACKUP, the following operations which require writing to the data file can not be performed.
 - SHUTDOWN NORMAL
 - OFFLINE / DROP TABLESPACE
 - ADD / DROP DATAFILE
- It may require media recovery on restart when a full backup is ACTIVE state and the instance is abnormally terminated.

⟨database end backup clause⟩

The database is set to the state which the full backup is not available.

- All tablespaces in ONLINE state, which is created and used in the database, are set to the state which the full backup is not available.
- The database should be in OPEN phase and operated in ARCHIVELOG mode.

⟨database incremental backup statement⟩

- An incremental backup is performed for the database.
- The database should be in OPEN phase and operated in ARCHIVELOG mode.

⟨incremental backup option⟩

- 'integer' can be specified from 0 to 4.
- LEVEL 0 can not specify CUMULATIVE or DIFFERENTIAL.
- CUMULATIVE | DIFFERENTIAL
 - CUMULATIVE
 - If 'integer' is n, it backs up all pages which are altered after the most recent backups of LEVEL 0 ~ LEVEL n-1.
 - DIFFERENTIAL
 - If 'integer' is n, it backs up all pages which are altered after the most recent backups of LEVEL 0 ~ LEVEL n.

- If it is omitted, DIFFERENTIAL is specified by default.

<database controlfile backup statement>

- The control file is backed up.
 - The length of 'target_name' should be shorter than 1024 bytes.
 - If 'target_name' already exists, the operation fails.
- The database should be in OPEN phase and operated in ARCHIVELOG mode.



The maximum length of the 'target_name' managed by GOLDILOCKS is 1024 bytes. However, the maximum lengths of the file name varies depending on the OS, so the actual length of 'target_name' which is available to be created can be shorter than 1024 bytes.

<domain name>

- It is a name of a member or a group for which the statement is performed.
- If it is omitted, it is performed for all groups.

Description

It backs up data files and control files in the database. A full backup of the database begins with BEGIN BACKUP, and copies the datafiles using OS file copy, then ends with END BACKUP. The incremental backup file is created in the path set by the BACKUP_DIR 1 property using a single statement.

Examples

The following is an example to set the entire backup state to ACTIVE.

```
ALTER SYSTEM BEGIN BACKUP;
```

The following is an example to set the entire backup state to INACTIVE.

```
ALTER SYSTEM END BACKUP;
```

The following is an example to create the incremental backup of LEVEL 1 by using DIFFERENTIAL.

```
ALTER DATABASE BACKUP INCREMENTAL LEVEL 1 DIFFERENTIAL;
```

The following is an example to create the 'controlfile.bak' backup file for the control file. If the absolute path is not included, a backup file is created in the path set by the LOG_DIR property.

```
ALTER DATABASE BACKUP CONTROLFILE TO 'controlfile.bak';
```

Compatibility

The SQL standard does not define ALTER DATABASE statement.

For More Information

Refer to the followings.

- ALTER TABLESPACE name BACKUP
- ALTER DATABASE RECOVER

16.8 ALTER DATABASE CLEAR AUDIT TRAIL

Function

It purges audit records which are accumulated when applying an audit policy.

Syntax

```
<clear audit trail statement> ::=  
    ALTER DATABASE CLEAR AUDIT TRAIL  
    ;
```

Invocation and Access Rules

AUDIT SYSTEM ON DATABASE privilege is required to perform <clear audit trail statement>.

Description

If an audit policy is activated, an audit trails is getting longer as time goes by.

Tables configuring an audit trail are stored in MEM_AUX_TBS tablespace, and a user should be cautious not to let the audit trail keep increasing.

Storing Audit Trail

A user should purge an audit trail after storing it according to the following procedure to store an audit trail when it is necessary.

- When performing it for the first time

```
CREATE TABLE backup_audit_trail AS SELECT * FROM AUDIT_TRAIL;  
COMMIT;
```

- When repeatedly performing it

```
INSERT INTO backup_audit_trail SELECT * FROM AUDIT_TRAIL;  
COMMIT;
```

- When purging an audit trail

```
ALTER DATABASE CLEAR AUDIT TRAIL;
```

Examples

Purge an audit trail by using the following statement.

```
ALTER DATABASE CLEAR AUDIT TRAIL;
```

Compatibility

The SQL standard does not have the audit policy.

For More Information

Refer to the followings.

- Managing audit policy object
 - **CREATE AUDIT POLICY**
 - **DROP AUDIT POLICY**
 - **ALTER AUDIT POLICY**
- Activating/ deactivating audit policy
 - **AUDIT POLICY**
 - **NOAUDIT POLICY**
- Enquiring audit trail: **AUDIT_TRAIL**
- Dropping audit trail: **ALTER DATABASE CLEAR AUDIT TRAIL**

16.9 ALTER DATABASE CLEAR PASSWORD HISTORY

Function

It deletes the user's password change history which is accumulated due by applying the profile.

Syntax

```
<clear password history statement> ::=
    ALTER DATABASE CLEAR PASSWORD HISTORY
    ;
```

Invocation and Access Rules

ALTER DATABASE ON DATABASE privilege is required to perform <clear password history statement>.

Description

When a profile is applied to a user, the user's password change history is accumulated according to the PASSWORD_REUSE_MAX, PASSWORD_REUSE_TIME policy.

Table 16-1 Managing the change history

PASSWORD_REUSE_MAX	PASSWORD_REUSE_TIME	Managing the change history
value	value	It manages only the change history within the value range, and the change history out of the value range is automatically deleted.
value	UNLIMITED	It accumulates all change history and it does not delete any change history because all change history should be checked.
UNLIMITED	value	It accumulates all change history and it does not delete any change history because all change history should be checked.
UNLIMITED	UNLIMITED	It does not manage the change history because the change history is not checked.

<Clear password history statement> deletes the accumulated user's password change history.

Examples

The following is an example of executing <clear password history statement> statement.

```
gSQL> ALTER DATABASE CLEAR PASSWORD HISTORY;  
Database altered.  
gSQL> COMMIT;  
Commit complete.
```

Compatibility

The SQL standard does not define ALTER DATABASE statement.

For More Information

Refer to the followings.

- CREATE PROFILE
- CREATE USER

16.10 ALTER DATABASE DELETE BACKUP

Function

It deletes the backup file and the backup information of incremental backup. It can delete all incremental backup of the database or no longer usable obsolete backup.

Syntax

```
<alter database delete backup statement> ::=  
    ALTER DATABASE DELETE <delete backup list option>  
        BACKUP LIST [ <including backup file option> ]  
    ;  
<delete backup list option> ::=  
    OBSOLETE  
    | ALL  
<including backup file option> ::=  
    INCLUDING BACKUP FILES
```

Invocation and Access Rules

ALTER DATABASE ON DATABASE privilege is required to perform <alter database delete backup statement>.

Syntax Rules and Parameters

<alter database delete backup statement>

The database should be in MOUNT or OPEN phase.

<delete backup list option>

It selects the backups to be deleted among the existing incremental backups.

- **OBSOLETE:** It selects backups of database or tablespaces to be deleted, which was backed up before the most recent database LEVEL 0 backup.
- **ALL:** It selects all incremental backups to be deleted.

<including backup file option>

- If it is omitted, it deletes only the backup information from the control file.
- It also deletes not only backup information but also the backup files.

Description

Deletion of the OBSOLETE incremental backup deletes the incremental backup of which is before the most recent LEVEL 0 database backup. When non-LEVEL 0 incremental backup is performed, it is not deleted even if it includes the previously performed incremental backup. It is because it can be used when performing the incomplete recovery by using the incremental backups.



Be cautious of deleting the backup file together when an incremental backup is deleted. It can not be recovered even by using the control file which has incremental backup information.

Example

The following is an example to delete the backup information and backup files of all existing incremental backups.

```
ALTER DATABASE DELETE ALL BACKUP LIST INCLUDING BACKUP FILES;
```

Compatibility

The SQL standard does not define ALTER DATABASE statement.

For More Information

Refer to the followings.

- `ALTER TABLESPACE name BACKUP`
- `ALTER DATABASE RECOVER`

16.11 ALTER DATABASE DROP INACTIVE CLUSTER MEMBERS

Function

It drops the entire inactive cluster member.

Syntax

```
<alter database drop inactive members statement> ::=  
    ALTER DATABASE DROP INACTIVE CLUSTER MEMBERS  
    ;
```

Invocation and Access Rules

It can be performed in a cluster system.

ADMINISTRATION ON DATABASE privilege is required to perform <alter database drop inactive cluster members statement>.

Description

It drops the entire inactive cluster member.

The inactive state of a cluster member means that it is not connected to the cluster system, and it occurs in the following cases.

- An error occurs on a cluster member in an operating cluster system.
- Trying to start-up the cluster system without driving the cluster member.

However, if the table shard is lost while dropping the cluster member, then an inactive cluster member cannot be dropped.

It is recommended to use <alter database drop inactive members statement> when an inactive cluster member

member can not be included in the cluster system any more.

Examples

The following is an example of executing <alter database drop inactive members statement>.

```
gSQL> ALTER DATABASE DROP INACTIVE CLUSTER MEMBERS;  
Database altered.
```

Compatibility

The SQL standard does not define the concepts of the cluster.

For More Information

Refer to **ALTER SYSTEM JOIN DATABASE**.

16.12 ALTER DATABASE DROP LOGFILE

Function

It drops a log file group or a member which exists in the database.

Syntax

```

<alter database drop logfile statement> ::=
    <drop logfile group statement>
  | <drop logfile member statement>
  ;
<drop logfile group statement> ::=
    ALTER DATABASE DROP LOGFILE <group clause>
<group clause> ::=
    GROUP integer
<drop logfile member statement> ::=
    ALTER DATABASE DROP LOGFILE MEMBER <logfile_list>
<logfile_list> ::=
    'logfile_name'
  | <logfile_list> , 'logfile_name'

```

Invocation and Access Rules

ALTER DATABASE ON DATABASE privilege is required to perform <alter database drop logfile statement>.

Syntax Rules and Parameters

<alter database drop logfile statement>

The database should be in MOUNT phase.

An error occurs when the log file to be deleted is in CURRENT or ACTIVE stage.

At least four log file groups should be remained after dropping.

⟨drop logfile group statement⟩

It drops the existing log file group.

- ⟨group clause⟩
 - It specifies the log file group to be dropped.
 - An integer should be an identifier of the existing log file.
 - An error occurs if the integer does not exist.

⟨drop logfile member statement⟩

It drops the existing log file members.

- ⟨logfile_list⟩
 - It is the list of the log file members to be dropped.
 - 'logfile_name' should be an existing name.
 - An error occurs if 'logfile_name' does not exist.

Description

For more information, refer to the rules for each syntax.

Examples

The following is an example of dropping the existing log file GROUP 3.

```
ALTER DATABASE DROP LOGFILE GROUP 3;
```

The following is an example of dropping logfile1.log and logfile2.log from the existing logfile GROUP 3.

```
ALTER DATABASE DROP LOGFILE MEMBER 'logfile1.log', 'logfile2.log';
```

Compatibility

The SQL standard does not define ALTER DATABASE statement.

For More Information

Refer to the respective syntax rules, and the followings.

- ALTER DATABASE ADD LOGFILE
- ALTER DATABASE RENAME LOGFILE

16.13 ALTER DATABASE MOVE SHARD

Function

It rebalances shard of all tables in a specific cluster group to another cluster group.

Syntax

```
<alter database move shard statement> ::=  
    ALTER DATABASE MOVE SHARD FROM CLUSTER GROUP src_cluster_group  
    TO CLUSTER GROUP dest_cluster_group [ ONLINE | OFFLINE ];
```

Invocation and Access Rules

It can be performed in a cluster system.

ALTER DATABASE ON DATABASE privilege is required to perform <alter database move shard statement>.

Syntax Rules and Parameters

src_cluster_group

It is a cluster group to which the table shard is moved.

dest_cluster_group

It is a target cluster group to which the table shard is moved.

[ONLINE | OFFLINE]

It determines whether to allow DML when rebalancing table shard.

- ONLINE
 - It allows INSERT, UPDATE, and DELETE.

- OFFLINE
 - It does not allow INSERT, UPDATE, DELETE.
- When it is omitted, the default value is ONLINE.

Description

When adding a cluster member and a cluster group using the following statements, the table shard is not rebalanced.

- CREATE CLUSTER GROUP
- ALTER CLUSTER GROUP name ADD MEMBER

Perform <alter database rebalance statement> to rebalance the shard of the entire table which was not rebalanced when adding a cluster group and a cluster member.

<alter database move shard statement> is performed as the following concepts for tables which did not rebalance the shard.

```
ALTER TABLE t1 MOVE SHARD FROM CLUSTER GROUP src_group TO CLUSTER GROUP dest_group;
COMMIT;
ALTER TABLE t2 MOVE SHARD FROM CLUSTER GROUP src_group TO CLUSTER GROUP dest_group;
COMMIT;
ALTER TABLE t3 MOVE SHARD FROM CLUSTER GROUP src_group TO CLUSTER GROUP dest_group;
COMMIT;
...
...
ALTER TABLE t_n MOVE SHARD FROM CLUSTER GROUP src_group TO CLUSTER GROUP dest_group;
COMMIT;
```

The <alter database move shard statement> is proceeded even when the rebalancing the shard of a specific table fails. It does not rollback the table which succeeded in rebalancing the shard.

Therefore, when performing <alter database move shard statement> again after appropriately processed an error, then it rebalances only the shard for the table requiring the rebalancing. In this case, the table which succeeded in rebalancing the shard is not included in a target of the rebalancing.

Examples

The following is an example of performing <alter database move shard statement>.

```
gSQL> ALTER DATABASE MOVE SHARD FROM CLUSTER GROUP G1 TO CLUSTER GROUP G2;  
Database altered.
```

Compatibility

The SQL standard does not define the concepts of the cluster.

For More Information

Refer to the followings.

- **ALTER TABLE name MOVE SHARD**
- **CREATE CLUSTER GROUP**
- **ALTER CLUSTER GROUP name ADD MEMBER**

16.14 ALTER DATABASE OFFLINE INACTIVE CLUSTER MEMBERS

Function

It sets the entire inactive cluster member to offline. In other words, it sets the shard map for the cluster member to offline.

Syntax

```
⟨alter database offline inactive cluster members statement⟩ ::=  
    ALTER DATABASE OFFLINE INACTIVE CLUSTER MEMBERS  
    ;
```

Invocation and Access Rules

It can be performed in a cluster system.

ADMINISTRATION ON DATABASE privilege is required to perform ⟨alter database offline inactive cluster members statement⟩.

Syntax Rules and Parameters

It sets the entire inactive cluster member to offline.

The inactive state of a cluster member means that it is not connected to the cluster system, and it occurs in the following cases.

- An error occurs on a cluster member in an operating cluster system.
- Trying to start-up the cluster system without driving the cluster member.

Description

It is recommended to use `<alter database offline inactive members statement>` when an inactive cluster member can not be included in the cluster system any more.

If an inactive cluster member can participate in a cluster system, then perform **ALTER SYSTEM JOIN DATABASE** to include it in a cluster system.

The cluster member which is set to offline can be shifted to online again by using the following statements after the join.

- **ALTER DATABASE REBALANCE**
- **ALTER TABLE name REBALANCE**

Examples

```
gSQL> ALTER DATABASE OFFLINE INACTIVE CLUSTER MEMBERS;
```

Compatibility

The SQL standard does not define the concepts of the cluster.

For More Information

Refer to the followings.

- **ALTER SYSTEM JOIN DATABASE**
- **ALTER DATABASE REBALANCE**
- **ALTER TABLE name REBALANCE**

16.15 ALTER DATABASE REBALANCE

Function

It rebalances shard of all tables.

Syntax

```
<alter database rebalance statement> ::=  
    ALTER DATABASE REBALANCE [ ONLINE | OFFLINE ];
```

Invocation and Access Rules

It can be performed in a cluster system.

ALTER DATABASE ON DATABASE privilege is required to perform <alter database rebalance statement>.

Syntax Rules and Parameters

[ONLINE | OFFLINE]

It determines whether to allow DML when rebalancing table shard.

- ONLINE
 - It allows INSERT, UPDATE, and DELETE.
- OFFLINE
 - It does not allow INSERT, UPDATE, DELETE.
- When it is omitted, the default value is ONLINE.

Description

When adding a cluster member and a cluster group using the following statements, the table shard is not rebalanced.

- **CREATE CLUSTER GROUP**
- **ALTER CLUSTER GROUP name ADD MEMBER**

Perform `<alter database rebalance statement>` to rebalance the shard of the entire table which was not rebalanced when adding a cluster group and a cluster member.

`<alter database rebalance statement>` is performed as the following concepts for tables which did not rebalance the shard.

```
ALTER TABLE t1 REBALANCE;  
COMMIT;  
ALTER TABLE t2 REBALANCE;  
COMMIT;  
ALTER TABLE t3 REBALANCE;  
COMMIT;  
...  
...  
ALTER TABLE t_n REBALANCE;  
COMMIT;
```

The `<alter database rebalance statement>` is proceeded even when the rebalancing the shard of a specific table fails. It does not rollback the table which succeeded in rebalancing the shard.

Therefore, when performing `<alter database rebalance statement>` again after appropriately processed an error, then it rebalances only the shard for the table requiring the rebalancing. In this case, the table which succeeded in rebalancing the shard is not included in a target of the rebalancing.

Examples

The following is an example of performing `<alter database rebalance statement>`.

```
gSQL> ALTER DATABASE REBALANCE;  
Database altered.
```

Compatibility

The SQL standard does not define the concepts of the cluster.

For More Information

Refer to `ALTER TABLE name REBALANCE`.

16.16 ALTER DATABASE REBALANCE EXCLUDE CLUSTER GROUP

Function

It rebalances shard of all tables excluding shards of a specific cluster group.

Syntax

```
<alter database rebalance exclude cluster group statement> ::=  
    ALTER DATABASE REBALANCE EXCLUDE CLUSTER GROUP cluster_group_name [ ONLINE | OFFLINE ];
```

Invocation and Access Rules

It can be performed in a cluster system.

ALTER DATABASE ON DATABASE privilege is required to perform <alter database rebalance exclude cluster group statement>.

Syntax Rules and Parameters

cluster_group_name

It is a name of the cluster group excluding a shard of the table.

If the specified cluster group is the only cluster group, then the statement can not be performed.

[ONLINE | OFFLINE]

It determines whether to allow DML when rebalancing table shard.

- ONLINE
 - It allows INSERT, UPDATE, and DELETE.
- OFFLINE

- It does not allow INSERT, UPDATE, DELETE.
- When it is omitted, the default value is ONLINE.

Description

To drop a cluster group by using **DROP CLUSTER GROUP**, there should not be a shard in the cluster group.

Perform `<alter database rebalance exclude cluster group statement>` to exclude a shard from the cluster group. `<alter database rebalance exclude cluster group statement>` is performed as the following concepts for tables which include a shard in the cluster group.

```
ALTER TABLE t1 REBALANCE EXCLUDE CLUSTER GROUP g3;  
COMMIT;  
ALTER TABLE t2 REBALANCE EXCLUDE CLUSTER GROUP g3;  
COMMIT;  
ALTER TABLE t3 REBALANCE EXCLUDE CLUSTER GROUP g3;  
COMMIT;  
...  
...  
ALTER TABLE t_n REBALANCE EXCLUDE CLUSTER GROUP g3;  
COMMIT;
```

If the `<alter database rebalance exclude cluster group statement>` fails due to the lack of storage space, it does not rollback the table which succeed in excluding a shard.

Therefore, when performing `<alter database rebalance exclude cluster group statement>` again after appropriately processed an error, then it excludes and rebalances only the shard for the table requiring the rebalancing. In this case, the table which succeeded in excluding the shard is not included in a target of the rebalancing.

Examples

The following is an example of performing `<alter database rebalance exclude cluster group statement>`.

```
gSQL> ALTER DATABASE REBALANCE EXCLUDE CLUSTER GROUP g3;  
Database altered.
```

Compatibility

The SQL standard does not define the concepts of the cluster.

For More Information

Refer to the followings.

- **DROP CLUSTER GROUP**
- **ALTER TABLE name REBALANCE EXCLUDE CLUSTER GROUP cluster_group_list**

16.17 ALTER DATABASE RENAME LOGFILE

Function

It renames the logfile in the database.

Syntax

```
<alter database rename logfile statement> ::=  
    ALTER DATABASE RENAME LOGFILE <logfile_list> TO <logfile_list>  
    ;  
<logfile_list> ::=  
    'logfile_name'  
    | <logfile_list> , 'logfile_name'
```

Invocation and Access Rules

ALTER DATABASE ON DATABASE privilege is required for performing <alter database rename logfile statement>.

Syntax Rules and Parameters

<alter database rename logfile statement>

- The database should be in MOUNT phase.
- FROM <logfile_list>
 - The name list of the logfiles to modify in the database.
- TO <logfile_list>
 - The name list of the logfiles to be modified in the database.
 - <logfile_list> should be an existing file.
 - An error occurs if the file does not exist.

Description

For more information, refer to the rules for each syntax.

Example

The following is an example of modifying the existing 'logfile.log' logfile to 'newlogfile.log'.

```
ALTER DATABASE RENAME LOGFILE 'logfile.log' TO 'newlogfile.log';
```

Compatibility

The SQL standard does not define ALTER DATABASE statement.

For More Information

Refer to the followings.

- ALTER DATABASE ADD LOGFILE
- ALTER DATABASE DROP LOGFILE

16.18 ALTER DATABASE RECOVER

Function

It recovers the entire data file or part of the data files in the database by using the online and archive log files.

Syntax

```

<alter database recover statement> ::=
    <complete database recover statement>
  | <datafile recover statement>
  | <complete tablespace recover statement>
  | <incomplete database recover statement>
  ;

<complete database recover statement> ::=
    ALTER DATABASE RECOVER

<datafile recover statement> ::=
    ALTER DATABASE RECOVER DATAFILE <datafile recovery clause>

<datafile recovery clause> ::=
    <datafile recovery object> [, ...]

<datafile recovery object> ::=
    'datafile_name' [<recovery using backup option>] [recovery corruption option]

<recovery using backup option> ::=
    USING BACKUP 'backup_datafile_name'

<recovery corruption option> ::=
    CORRUPTION

<complete tablespace recover statement> ::=
    ALTER DATABASE RECOVER TABLESPACE tablespace_name

<incomplete database recover statement> ::=
    <batch incomplete recovery statement>
  | <interactive incomplete recovery statement>
  ;

<batch incomplete recovery statement> ::=
    ALTER DATABASE RECOVER <until clause> [<using backup controlfile option>]

<until clause> ::=

```

```

        UNTIL CHANGE integer
<using backup controlfile option> ::=
        USING BACKUP CONTROLFILE
<interactive incomplete recovery statement> ::=
        ALTER DATABASE <incomplete recovery option> [<using backup controlfile option>]
<incomplete recovery option> ::=
        BEGIN INCOMPLETE RECOVERY
        | END INCOMPLETE RECOVERY
        | RECOVER 'logfile name'
        | RECOVER AUTOMATICALLY
        | RECOVER SUGGESTION
        ;

```

Invocation and Access Rules

ALTER DATABASE ON DATABASE privilege is required to perform <alter database recover statement>.

Syntax Rules and Parameters

<complete database recover statement>

The data files of the database are recovered up to date by using the online and archive log files.

- The recovery is performed for all tablespaces in the ONLINE state.
- The database should be in MOUNT phase and in ARCHIVELOG mode.
- If the required archived log file does not exist, it fails.

<datafile recover statement>

It recovers the backedup datafile, the datafile of the tablespace which requires the recovery by using the archive logfile due to an error during the backup, or the datafile of the tablespace which was set to offline by an immediate option, to the latest status.

- Datafile can be recovered on MOUNT phase or OPEN phase.
- The datafile of the tablespace which is in OFFLINE state can be recovered on OPEN phase, and datafile which is either in ONLINE/OFFLINE state can be recovered in MOUNT phase.
- If the required archive logfile does not exist, then the recovery fails.
- <datafile recovery clause>
 - It specifies one or more datafile object list which is a target of the recovery.

- <datafile recovery object>
 - It sets the name of datafile which is a target of the recovery, and the recovery option.
- <recovery using backup option>
 - It sets the name of backup datafile of the datafile which is a target of the recovery.
- <recovery corruption option>
 - It determines whether to recover only the pages corrupted from the datafile which is a target of the recovery.

<complete tablespace recover statement>

The data files of the tablespace is recovered up to date.

- Tablespace recovery should be performed when the database is in MOUNT or OPEN phase.
- The recovery in the OPEN phase can only be performed when the tablespaces is in the OFFLINE stage, and the recovery in MOUNT phase can be performed when the tablespace is either in ONLINE/ OFFLINE stage.
- If the required archive log file does not exist, it fails.
- The following is the case which requires the tablespace recovery operation.
 - The tablespace became OFFLINE by IMMEDIATE.
 - The backed up data file is used.
 - A failure occurred during the entire backup.

<incomplete database recover statement>

<batch incomplete database recover statement>

The datafiles in the database are recovered in a batch up to a specific point of time by using the online and archive logfile.

- The recovery is performed for all tablespaces in the ONLINE stage.
- The database should be in MOUNT phase and in ARCHIVELOG mode.
- It fails if using the data file containing data which is after the time of the incomplete recovery.
- The database should be OPEN by using RESETLOGS after completion of incomplete recovery.
- <until clause>
 - A specific point of time for incomplete recovery
 - UNTIL CHANGE: The point of time is specified for incomplete recovery in log units
- <using backup controlfile>
 - Deprecated

⟨interactive incomplete database recover statement⟩

The data files in the database are interactively recovered with a user up to a specific point of time by using online and archive log file.

- The recovery is performed for all tablespaces in the ONLINE stage.
- The database should be in MOUNT phase and in ARCHIVELOG mode.
- It fails if using the data file containing data which is after the time of the incomplete recovery.
- The database should be OPEN by using RESETLOGS after completion of incomplete recovery.
- ⟨incomplete recovery option⟩
 - It is an option to perform an interactive incomplete recovery in log units.
 - BEGIN INCOMPLETE RECOVERY: It starts an incomplete recovery.
 - END INCOMPLETE RECOVERY: It ends an incomplete recovery.
 - RECOVER 'logfile name': A user directly specifies the log file performing the recovery.
 - RECOVER AUTOMATICALLY: All recoverable archive log files are recovered.
 - RECOVER SUGGESTION: It recovers archive log files which are required for the recovery and recommended by the system.
- ⟨using backup controlfile⟩
 - Deprecated.

Description

Incomplete recovery of the database is not easy to find a recovery completion point at a time. Therefore, the desired recovery point is found by performing it several times.

However, it becomes a new database if the database is started up with RESETLOGS option after an incomplete recovery. Therefore, the incomplete recovery should be performed several times after creating a copy of the archived log files and online redo log files.

Examples

The following is an example of a complete recovery for entire database.

```
ALTER DATABASE RECOVER;
```

The following is an example of a datafile recovery.

```
ALTER DATABASE RECOVER DATAFILE 'test.dbf';
```

The following is an example of a tablespace recovery.

```
ALTER DATABASE RECOVER TABLESPACE test_tbs;
```

The following is an example of incomplete recovery for the entire database until LSN is 11123.

```
ALTER DATABASE RECOVER UNTIL CHANGE 11123;
```

The following is an example of interactive incomplete recovery until the recoverable archive log files.

```
ALTER DATABASE BEGIN INCOMPLETE RECOVERY;  
ALTER DATABASE RECOVER AUTOMATICALLY;  
ALTER DATABASE END INCOMPLETE RECOVERY;
```

Compatibility

The SQL standard does not define ALTER DATABASE statement.

For More Information

Refer to the followings.

- ALTER DATABASE BACKUP
- ALTER TABLESPACE name BACKUP
- ALTER SYSTEM {MOUNT | OPEN} DATABASE

16.19 ALTER DATABASE REGISTER

Function

It registers unrecoverable segments in the database.

Syntax

```
<alter database register statement> ::=  
    ALTER DATABASE REGISTER IRRECOVERALBE SEGMENT  
        <segment physical identifier list>  
    ;  
<segment physical identifier list> ::=  
    integer  
    | <segment physical identifier list> , integer
```

Invocation and Access Rules

ALTER DATABASE ON DATABASE privilege is required to perform <alter database register statement>.

Syntax Rules and Parameters

<alter database register statement>

It registers the unrecoverable segments in the database. The statement can be used on the assumption that the segment is not used any more, when the database is not recoverable and the backup does not exist.

- The database should be in MOUNT phase.
- The registered segment identifier list is initialized at restart.
- If a server restart is successful, the registered segment becomes 'UNUSABLE' state, and that segments should be deleted.

<segment physical identifier list>

The list of unrecoverable segment identifier

- Integer: 8 bytes integer segment identifier

Description

When a server restarts after abnormal termination, the database performs the recovery process. During this process, it executes pages again by using the REDO log to recover pages which was not reflected in the disk in the previous service stage.

If an unexpected failure occurs during execution of the REDO operation, that statement can be used to ignore the failure and to execute the recovery.

Example

The following is an example of giving up the recovery of the segment whose identifier is 4028679323648.

```
ALTER DATABASE REGISTER IRRECOVERABLE SEGMENT 4028679323648;
```

Compatibility

The SQL standard does not define ALTER DATABASE statement.

For More Information

Refer to the followings.

- ALTER TABLESPACE name BACKUP
- ALTER DATABASE RECOVER

16.20 ALTER DATABASE RESET LOCAL CLUSTER MEMBER

Function

It resets the local cluster member except for the tablespace object to the time of creating the database.

Syntax

```
<alter database reset local cluster member statement> ::=  
    ALTER DATABASE RESET LOCAL CLUSTER MEMBER  
    ;
```

Invocation and Access Rules

It can be performed in a cluster system.

The start-up phase should be LOCAL OPEN.

ADMINISTRATION ON DATABASE privilege is required to perform <alter database reset local cluster member statement>.

Description

It resets the local cluster member except for the tablespace object to the time of creating the database. It drops all objects created by a user except for the tablespace object.

<alter database reset local cluster member statement> statement resets an inactive cluster member, and makes the new cluster member to participate in a cluster system.

An inactive cluster member which is disconnected from the cluster system is processed as follows.

- If it can join in a cluster system again, then use JOIN statement to make it join.
 - **ALTER SYSTEM JOIN DATABASE**
- If it can not join in a cluster system again, then use DROP statement to exclude it.

- **ALTER DATABASE DROP INACTIVE CLUSTER MEMBERS**

In this case, the device corresponding to the cluster member which is excluded from a cluster system can be used again by using the following two methods.

- Method 1: Recreate the database of the local cluster member.
- Method 2: Reset the local cluster member by using `<alter database reset local cluster member statement>`.

The method 2 reduces the cost of recreating the tablespace comparing to the method 1.

Examples

The following is an example of a reset by using `<alter database reset local cluster member statement>` after driving the local cluster member, which is excluded from the cluster system, up to LOCAL OPEN phase.

```
gSQL> \startup nomount
Startup success
gSQL> ALTER SYSTEM MOUNT DATABASE;
System altered.
gSQL> ALTER SYSTEM OPEN LOCAL DATABASE;
System altered.
gSQL> ALTER DATABASE RESET LOCAL CLUSTER MEMBER;
Database altered.
```

Compatibility

The SQL standard does not define the concepts of the cluster.

For More Information

Refer to the followings.

- **ALTER SYSTEM JOIN DATABASE**
- **ALTER DATABASE DROP INACTIVE CLUSTER MEMBERS**

16.21 ALTER DATABASE RESTORE

Function

It restores the data files in the database or tablespace by using the incremental backup.

Syntax

```

<alter database restore statement> ::=
    <database restore statement>
  | <tablespace restore statement>
  | <controlfile restore statement>
  ;
<database restore statement> ::=
    ALTER DATABASE RESTORE [ <until clause> ]
<until clause> ::=
    UNTIL CHANGE integer
<tablespace restore statement> ::=
    ALTER DATABASE RESTORE TABLESPACE tablespace_name
<controlfile restore statement> ::=
    ALTER DATABASE RESTORE CONTROLFILE FROM 'file_name'

```

Invocation and Access Rules

ALTER DATABASE ON DATABASE privilege is required to perform <alter database restore statement>.

Syntax Rules and Parameters

<database restore statement>

It restores the data files in the database by using the incremental backup.
The database should be in MOUNT phase.

⟨tablespace restore statement⟩

It restores the data files in the tablespace by using the incremental backup.

- The database should be in MOUNT or OPEN phase.
- The recovery in OPEN state can be performed only for the tablespaces in OFFLINE state. The recovery in MOUNT phase can be performed for the tablespace is either in ONLINE state or OFFLINE state.

⟨controlfile restore statement⟩

The control file is recovered using 'file_name'.

- The database should be in NOMOUNT phase.
- The absolute path is recommended for 'file_name' but if relative path is described, then ⟨GOLDILOC KS_HOME⟩/wal/'file_name' is used.

Description

The data recovery using full backup uses OS copy command to directly copy the backup file to the data file path. The data recovery using incremental restores only the deleted data files or old data files.

Examples

The following is an example of recovering the database by using the incremental backup.

```
ALTER DATABASE RESTORE;
```

The following is an example of recovering the tablespace by using the incremental backup.

```
ALTER DATABASE RESTORE TABLESPACE test_tbs;
```

The following is an example of recovering the database by using only the incremental backup whose LSN is smaller than 11123.

```
ALTER DATABASE RESTORE UNTIL CHANGE 11123;
```

The following is an example of recovering the control file by using controlfile.bak.

`ALTER DATABASE RESTORE CONTROLFILE FROM 'controlfile.bak'`

Compatibility

The SQL standard does not define ALTER DATABASE statement.

For More Information

Refer to the followings.

- ALTER DATABASE BACKUP
- ALTER TABLESPACE name BACKUP
- ALTER DATABASE RECOVER

16.22 ALTER INDEX

Function

It alters the index definition.

Syntax

```
<alter index statement> ::=  
    <alter index physical attribute statement>  
    | <rename index statement>  
    | <aging index statement>  
    ;
```

Invocation and Access Rules

One of the following privileges is required to perform <alter index statement>.

- The owner of that index
- The owner of the table to which the index belongs
- CONTROL TABLE ON TABLE for the table to which the index belongs.
- (ALTER INDEX or CONTROL SCHEMA) ON SCHEMA for the schema to which the index belongs
- ALTER ANY INDEX ON DATABASE

Syntax Rules and Parameters

<alter index physical attribute statement>

It alters physical attributes of the index.

For more information, refer to **ALTER INDEX name STORAGE**.

⟨rename index statement⟩

It alters the index name.

For more information, refer to **ALTER INDEX name RENAME TO**.

⟨aging statement⟩

It deletes the empty page of the index.

For more information, refer to **ALTER INDEX name AGING**.

Description

Refer to the descriptions of each detailed statement.

Examples

Refer to the examples of each detailed statement.

Compatibility

The SQL standard does not define the concepts of the index.

16.23 ALTER INDEX name AGING

Function

It deletes an empty page of the index.

Syntax

```
<aging index statement> ::=  
    ALTER INDEX index_name AGING  
    ;
```

Invocation and Access Rules

One of the following privileges is required to perform <aging index statement>.

- The owner of that index
- The owner of the table to which the index belongs
- CONTROL TABLE ON TABLE for the table to which the index belongs.
- (ALTER INDEX or CONTROL SCHEMA) ON SCHEMA for the schema to which the index belongs
- ALTER ANY INDEX ON DATABASE

Syntax Rules and Parameters

index_name

It is the name of the target index.

Description

This syntax returns pages whose all keys are deleted among index pages to a segment. Aging is processed in two steps which are logical deletion and physical deletion. A logical deletion is disconnection of inde

x page, and it is performed when SCN of when deleting the last key of a page is smaller than the agable S CN of the system. Then the physical deletion is performed when the SCN of the logical deletion is smaller than the agable SCN of the system.



If the agable SCN of the system does not increase, then the empty page may not be deleted even though the index AGING statement succeeded.

Examples

The following is an example of aging the index.

```
gSQL> select index_name, empty_blocks from user_indexes where index_name = 'T1X';
INDEX_NAME EMPTY_BLOCKS
-----
T1X          2
1 row selected.
gSQL> alter index t1x aging;
Index altered.
gSQL> select index_name, empty_blocks from user_indexes where index_name = 'T1X';
INDEX_NAME EMPTY_BLOCKS
-----
T1X          0
1 row selected.
```

Compatibility

The SQL standard does not define the concepts of the index.

For More Information

Refer to the followings.

- CREATE INDEX
- ALTER INDEX
- DROP INDEX

16.24 ALTER INDEX name STORAGE

Function

It alters the physical attributes of the index.

Syntax

```

<alter index physical attribute statement> ::=
    ALTER INDEX index_name
    | <physical attribute clause>
    | [ STORAGE ( <segment attr clause> [...] ) ]
    ;
<physical attribute clause> ::=
    PCTFREE integer
    | INITTRANS integer
    | MAXTRANS integer
<segment attr clause> ::=
    INITIAL <size_clause>
    | NEXT <size_clause>
    | MINSIZE <size_clause>
    | MAXSIZE <size_clause>
<size clause> ::=
    integer [ K | M | G | T ]

```

Invocation and Access Rules

One of the following privileges is required to perform <alter index physical attribute statement>.

- The owner of that index
- The owner of the table to which the index belongs
- CONTROL TABLE ON TABLE for the table to which the index belongs.
- (ALTER INDEX or CONTROL SCHEMA) ON SCHEMA for the schema to which the index belongs
- ALTER ANY INDEX ON DATABASE

Syntax Rules and Parameters

index_name

It is the target index name.

<physical attribute clause>

It defines the physical attribute information of the index.

- PCTFREE integer
 - Definition
 - The reserved space to adjust the frequency of page splits caused by inserting the key in the page.
 - It is applied only when the index bottom-up build.
 - It can use of the value from 0 to 99.
 - If it is omitted, the value set in DEFAULT_INDEX_PCTFREE property is used by default.
- INITRANS integer
 - Definition
 - The initial number of transactions simultaneously accessing the page.
 - If the number of users accessing the index is small, then INITRANS is set low. If the number of users simultaneously accessing the index is big, then INITRANS is set high.
 - If necessary, it is automatically increased to the specified MAXTRANS.
 - It can use the value from 1 to 32.
 - If it is omitted, the default value is 4.
- MAXTRANS integer
 - Definition
 - It specifies the maximum number of transaction simultaneously accessing the page.
 - It can use the value from 1 to 32.
 - If it is omitted, the default value is 8.

<segment attr clause>

It specifies the information for the index storage space.

- INITIAL integer
 - Definition
 - It specifies the size of physical storage space which is initially allocated when creating the index.

- This size is aligned to the EXTENT size of the TABLESPACE to which the table belongs. (e.g. If the EXT size is 8192 bytes, 'INITIAL 100' is actually operated as 8192 bytes.)
 - The size (aligned to the EXTENT size of TABLESPACE) should be equal to or bigger than MIN EXTENTS, or it should be equal to or less than MAXEXTENTS.
 - It is applied only when the index bottom-up build.
 - The minimum value is 1, and the maximum value depends on the system environment.
 - If it is omitted, the default value is one EXTENT size of TABLESPACE to which the table belongs.
- NEXT integer
 - Definition
 - It specifies the physical space size to be allocated when adding the space to the table.
 - This size is aligned to the EXTENT size of the TABLESPACE to which the table belongs. (e.g. If the EXT size is 8192 bytes, 'NEXT 100' is actually operated as 8192 bytes.)
 - NEXT operates as follows depending on the remaining space size of the currently available in dex. (Obtained by subtracting the amount of currently used space from the MAXEXTENTS size)
 - If the remaining space size is 0, then it can not extend the space.
 - If the remaining space size is bigger than 0, but smaller than NEXT, then it allocates the space as big as the remaining space.
 - If the remaining space size is bigger than NEXT, then it allocates the space as big as the NEXT.
 - The minimum value is 1 and the maximum value depends on the system environment.
 - If it is omitted, the default value is one EXTENT size of TABLESPACE to which the index belongs.
- MINSIZE integer
 - Definition
 - It is the minimum space size of the index.
 - The value should be equal to or smaller than MAXSIZE.
 - This size is aligned to the EXTENT size of the TABLESPACE to which the index belongs.
 - The minimum value is 1 and the maximum value depends on the system environment.
 - If it is smaller than the size of two EXTENT, it is specified to the size of two EXTENT.
 - If it is omitted, the default value is the size of two EXTENT.
- MAXSIZE integer
 - Definition
 - It is the maximum space size of the index.
 - The value should be equal to or bigger than MINSIZE.
 - This size is aligned to the EXTENT size of the TABLESPACE to which the index belongs.
 - The minimum value is 1 and the maximum value depends on the system environment.
 - If it is omitted, the default value is EXTENT size * 2147483647(The maximum positive integer of INT32).

<size clause>

It specifies the file size in byte. (If it is omitted, the default unit is bytes.)

- K: Kilobytes
- M: Megabytes
- G: Gigabytes
- T: Terabytes

Description

Refer to the syntax rules of each statement.

Examples

The following is an example of altering the physical attributes of the index.

```
gSQL> ALTER INDEX idx_t1_id PCTFREE 10 INITRANS 4 MAXTRANS 8;  
Index altered.
```

Compatibility

The SQL standard does not define the concepts of the index.

For More Information

Refer to the followings.

- CREATE INDEX
- ALTER INDEX
- DROP INDEX

16.25 ALTER INDEX name RENAME TO

Function

It alters the index name.

Syntax

```
<rename index statement> ::=  
    ALTER INDEX index_name  
        RENAME TO new_index_name  
    ;
```

Invocation and Access Rules

One of the following privileges is required to perform <rename index statement>.

- The owner of that index
- The owner of the table to which the index belongs
- CONTROL TABLE ON TABLE for the table to which the index belongs
- (ALTER INDEX or CONTROL SCHEMA) ON SCHEMA for the schema to which the index belongs
- ALTER ANY INDEX ON DATABASE

Syntax Rules and Parameters

index_name

It is the name of the target index.

The schema name can not be described and it has the same schema name as same as that of the existing index.

new_index_name

It is the name of the new index, and it should be a unique index name within the schema.

Description

Refer to the syntax rules of each statement.

Examples

The following is an example of altering the index name.

```
gSQL> ALTER INDEX t1_idx1 RENAME TO idx_t1_id;  
Index altered.
```

Compatibility

The SQL standard does not define the concepts of the index.

For More Information

Refer to the followings.

- CREATE INDEX
- ALTER INDEX
- DROP INDEX

16.26 ALTER PROFILE

Function

It alters the password management method.

Syntax

```

<alter profile statement> ::=
    ALTER PROFILE profile_name LIMIT
    { <password_parameters>, ... }
    ;

<password parameters> ::=
    FAILED_LOGIN_ATTEMPTS { integer | UNLIMITED | DEFAULT }
    | PASSWORD_LOCK_TIME { password_parameter_number_interval | UNLIMITED | DEFAULT }
    | PASSWORD_LIFE_TIME { password_parameter_number_interval | UNLIMITED | DEFAULT }
    | PASSWORD_GRACE_TIME { password_parameter_number_interval | UNLIMITED | DEFAULT }
    | PASSWORD_REUSE_MAX { integer | UNLIMITED | DEFAULT }
    | PASSWORD_REUSE_TIME { password_parameter_number_interval | UNLIMITED | DEFAULT }
    | PASSWORD_VERIFY_FUNCTION { <verify_policy> | NULL | DEFAULT }

<verify_policy> ::=
    KISA_VERIFY_FUNCTION
    | ORA12C_VERIFY_FUNCTION
    | ORA12C_STRONG_VERIFY_FUNCTION
    | VERIFY_FUNCTION_11G
    | VERIFY_FUNCTION

<password_parameter_number_interval> ::=
    integer
    | integer / integer

```

Invocation and Access Rules

ALTER PROFILE ON DATABASE privilege is required to perform <alter profile statement>.

Syntax Rules and Parameters

profile_name

It is a profile name to be altered.

FAILED_LOGIN_ATTEMPTS

It sets the number of consecutive login attempts allowed to fail.

For more information, refer to **CREATE PROFILE**.

PASSWORD_LOCK_TIME

It sets an account lockout duration (day) after the consecutive login failures.

For more information, refer to **CREATE PROFILE**.

PASSWORD_LIFE_TIME

It sets the password lifetime (day).

For more information, refer to **CREATE PROFILE**.

PASSWORD_GRACE_TIME

It sets a password expiration grace period when log in after **PASSWORD_LIFE_TIME**.

For more information, refer to **CREATE PROFILE**.

PASSWORD_REUSE_MAX

It specifies the number of the recent passwords which can not be reused when a user wants to reuse the old password.

For more information, refer to **CREATE PROFILE**.

PASSWORD_REUSE_TIME

It specifies the duration which the password can not be reused when a user wants to reuse the old password.

For more information, refer to **CREATE PROFILE**.

PASSWORD_VERIFY_FUNCTION

It set the password complexity verification method.
For more information, refer to [CREATE PROFILE](#).

Examples

The following is an example of changing the profile to control the account lockout.

```
gSQL> ALTER PROFILE prof1 LIMIT
        FAILED_LOGIN_ATTEMPTS 3
        PASSWORD_LOCK_TIME 3;
Profile altered.
gSQL> COMMIT;
Commit complete.
```

The following is an example of changing the profile to control the password lifetime.

```
gSQL> ALTER PROFILE prof1 LIMIT
        PASSWORD_LIFE_TIME 90
        PASSWORD_GRACE_TIME 7;
Profile altered.
gSQL> COMMIT;
Commit complete.
```

The following is an example of changing the profile to control the password reusability.

```
gSQL> ALTER PROFILE prof1 LIMIT
        PASSWORD_REUSE_MAX DEFAULT
        PASSWORD_REUSE_TIME DEFAULT;
Profile altered.
gSQL> COMMIT;
Commit complete.
```

The following is an example of changing the profile to control the password complexity verification.

```
gSQL> ALTER PROFILE prof1 LIMIT
        PASSWORD_VERIFY_FUNCTION KISA_VERIFY_FUNCTION;
Profile altered.
gSQL> COMMIT;
```

Commit complete.

Compatibility

The SQL standard does not define the concepts of the profile.

For More Information

Refer to `DROP PROFILE`.

16.27 ALTER SEQUENCE

Function

It alters the sequence.

Syntax

```

<alter sequence generator statement> ::=
    ALTER SEQUENCE sequence_name <alter sequence generator options>
    ;
<alter sequence generator options> ::=
    <alter sequence generator option> [, ...]
<alter sequence generator option> ::=
    <alter sequence generator restart option>
    | <basic sequence generator option>
<alter sequence generator restart option> ::=
    RESTART [ WITH integer ]
<basic sequence generator option> ::=
    <sequence generator increment by option>
    | <sequence generator maxvalue option>
    | <sequence generator minvalue option>
    | <sequence generator cycle option>
    | <sequence generator cache option>
<sequence generator increment by option> ::=
    INCREMENT BY integer
<sequence generator maxvalue option> ::=
    MAXVALUE integer
    | (NO MAXVALUE | NOMAXVALUE)
<sequence generator minvalue option> ::=
    MINVALUE integer
    | (NO MINVALUE | NOMINVALUE)
<sequence generator cycle option> ::=
    CYCLE
    | (NO CYCLE | NOCYCLE)
<sequence generator cache option> ::=
    CACHE integer

```

Invocation and Access Rules

One of the following privileges is required to perform `<alter sequence generator statement>`.

- The owner of that sequence
- (ALTER SEQUENCE or CONTROL SCHEMA) ON SCHEMA for the schema to which the sequence belongs
- ALTER ANY SEQUENCE ON DATABASE

Syntax Rules and Parameters

`sequence_name`

It is the sequence name to be altered.

It can define schema to which the sequence belongs such as `schema_name.sequence_name` and if `schema_name` is omitted, the default schema name of the user performing the statement is used.

`<alter sequence generator restart option>`

It sets NEXT VALUE of the sequence.

However, it does not change the value of START WITH which is defined in `CREATE SEQUENCE` statement.

- RESTART
 - If the value is not specified, the value of START WITH defined in `<sequence generator definition>` is set as the next value of the sequence.
- RESTART WITH integer
 - It sets an integer value as the next value of the sequence.
 - The integer value should be between MINVALUE and MAXVALUE.

If `<alter sequence generator restart option>` clause is not specified, it changes the sequence attributes based on the current sequence value.

`<sequence generator increment by option>`

It changes the interval of the sequence number.

The constraints and characteristics are as follows.

- A positive or negative value can be used, but 0 can not be used.
- The absolute value of the interval should be smaller than the difference between MINVALUE and MAXVALUE.
- If it is a positive value, it is an ascending sequence. If it is a negative value, it is a descending sequence.

⟨sequence generator maxvalue option⟩

It changes the maximum value which the sequence can generate.

However, the MAXVALUE should not be smaller than the current sequence value.

- MAXVALUE integer
 - The maximum value is in the range between the minimum (-9,223,372,036,854,775,808) and the maximum (+9,223,372,036,854,775,807) of 64 bit integer.
 - It should be equal to or bigger than the value of START WITH, and bigger than the value of MINVALUE.
- NO MAXVALUE | NOMAXVALUE
 - It changes the maximum value as follows.
 - If it is an ascending sequence, it is the maximum value (+9,223,372,036,854,775,807) of the 64 bit integer.
 - If it is a descending sequence, the value is -1.
 - NO MAXVALUE (SQL standard) and NOMAXVALUE are the reserved words with the same meaning, and either of them can be used.

⟨sequence generator minvalue option⟩

It changes the minimum value which the sequence can generate.

However, the MINVALUE should not be bigger than the current sequence value.

- MINVALUE integer
 - The minimum value is in the range between the minimum (-9,223,372,036,854,775,808) and the maximum (+9,223,372,036,854,775,807) of 64bit integer.
 - It should be equal to or smaller than the value of START WITH, and smaller than the value of MAXVALUE.
- NO MINVALUE | NOMINVALUE
 - It changes the minimum value as follows.
 - If it is an ascending sequence, the value is 1.
 - If it is a descending sequence, it is the minimum value (-9,223,372,036,854,775,808) of the 64bit integer.
 - NO MINVALUE (SQL standard) and NOMINVALUE are the reserved words with the same meaning.

g, and either of them can be used.

⟨sequence generator cycle option⟩

It changes whether to continue generating a value when the sequence value becomes the maximum or minimum value.

- **CYCLE**
 - If an ascending sequence becomes the maximum value, it generates the value again from the minimum value.
 - If a descending sequence becomes the minimum value, it generates the value again from the maximum value.
- **NO CYCLE | NOCYCLE**
 - It can not generate the value sequence when it becomes the maximum value or the minimum value.
 - **NO CYCLE** (SQL standard) and **NOCYCLE** are the reserved words with the same meaning, and either of them can be used.

⟨sequence generator cache option⟩

For quick access of a sequence, it defines the number of sequence values to be pre-loaded on the memory.

When restarting the database, the sequence value loaded on the memory is lost, and it starts from the value after loading.

- **CACHE integer**
 - The **CACHE** value should be equal to or bigger than 2.
 - If **CYCLE** exists, the **CACHE** value should not be bigger than the length of **CYCLE**.
 - The length of **CYCLE**: $\text{CEIL}(\text{MAXVALUE} - \text{MINVALUE}) / \text{ABS}(\text{INCREMENT})$
- **NO CACHE | NOCACHE**
 - It does not pre-load the sequence value in memory.

Description

It can not change **START WITH** which is one of the sequence attributes defined in **CREATE SEQUENCE** statement. To change **START WITH** attribute, it should be re-created by performing **CREATE SEQUENCE** statement after performing **DROP SEQUENCE** statement.

Examples

The following is an example of restating the sequence value by using RESTART option, then assigning a new ID.

```
gSQL> SELECT id, name FROM t1 ORDER BY 1;
ID NAME
----
10 leekmo
42 mkkim
51 jhkim
172 ehpark
4 rows selected.
gSQL> ALTER SEQUENCE seq1 RESTART;
Sequence altered.
gSQL> UPDATE t1 SET id = seq1.NEXTVAL;
4 rows updated.
gSQL> SELECT id, name FROM t1 ORDER BY 1;
ID NAME
--
1 leekmo
2 mkkim
3 jhkim
4 ehpark
4 rows selected.
```

Compatibility

The SQL standard does not define CACHE/ NO CACHE statement.

Table 16-2 SQL standard compatibility

Feature ID	Description	Compatibility
T176	Sequence generator support	O
T177	Sequence generator support: simple restart option	O

For More Information

Refer to the followings.

- `CREATE SEQUENCE`
- `DROP SEQUENCE`

16.28 ALTER SESSION CLEANUP GLOBAL TEMPORARY SEGMENT POOL;

Function

It returns all segments which were caught to be reused in a session to tablespaces.

Syntax

```
<alter session cleanup global temporary segment pool statement> ::=  
    ALTER SESSION CLEANUP GLOBAL TEMPORARY SEGMENT POOL  
    ;
```

Description

It cleans up only the segments of a segment cache in the performed session.

Examples

The following is an example of cleaning up the segment cache of the session.

```
gSQL> ALTER SESSION CLEANUP GLOBAL TEMPORARY SEGMENT POOL;  
Session altered.
```

Compatibility

The SQL standard does not define the concepts of the segment cache of a global temporary table and a global temporary index.

For More Information

Refer to [Global Temporary Table](#).

16.29 ALTER SESSION SET property_name

Function

It sets the property value of the session.

Syntax

```
<alter session set statement> ::=  
    ALTER SESSION SET <property name> { = <property value> | TO DEFAULT }  
    ;
```

Syntax Rules and Parameters

<property name>

It is the property name to be set.

For more information, refer to **Server Property** in an administration manual.

<property value>

It is the property value to be set.

TO DEFAULT

It sets the session property value as a system property value.

Description

For more information about property, refer to **Server Property** in an administration manual.

Examples

The following is an example of an error when setting ERROR HINT property so the hint clause includes an error.

```
gSQL> ALTER SESSION SET HINT_ERROR = ON;
Session altered.
gSQL> SELECT /*+ INDEX( t1, invalid_index ) */ name FROM t1 WHERE id = 1;
ERR-42000(16058): not applicable hint :
SELECT /*+ INDEX( t1, invalid_index ) */ name FROM t1 WHERE id = 1
          *
ERROR at line 1:
```

The following is an example of setting the session property value as the system property value.

```
gSQL> ALTER SESSION SET HINT_ERROR TO DEFAULT;
Session altered.
```

Compatibility

The SQL standard does not define the concepts of the session property.

For More Information

Refer to `ALTER SESSION SET property_name`.

16.30 ALTER SYSTEM CHECKPOINT

Function

It performs CHECKPOINT.

Syntax

```
<alter system checkpoint statement> ::=  
    ALTER SYSTEM CHECKPOINT  
    [ AT <domain name> ]  
    ;
```

Invocation and Access Rules

ALTER SYSTEM ON DATABASE privilege is required to perform <alter system checkpoint statement>.

Syntax Rules and Parameters

<alter system checkpoint statement>

CHECKPOINT is an operation to ensure that all altered data by the committed transactions are written to disk.

- The database should be in OPEN phase.
- The database should be in TDS mode.
- When a full backup is in progress, the altered pages are not recorded in the data file, but only the REDO logs and control files are written to the disk. If the server is abnormally terminated in this situation, a media recovery should be performed.

<domain name>

- It is a name of a member or a group for which the statement is performed.
- If it is omitted, it is performed for all groups.

Description

The checkpoint operation records all changes by the committed transactions to disk, so it enables a rapid recovery at system error.

Example

The following is an example of performing CHECKPOINT.

```
ALTER SYSTEM CHECKPOINT;
```

Compatibility

The SQL standard does not define the concepts of CHECKPOINT.

16.31 ALTER SYSTEM CLEANUP PLAN

Function

It cleans up all SQL plans.

Syntax

```
<alter system cleanup plan statement> ::=  
    ALTER SYSTEM CLEANUP PLAN  
    [ AT <domain name> ]  
    ;
```

Invocation and Access Rules

ALTER SYSTEM ON DATABASE privilege is required to perform <alter system cleanup plan statement>.

Syntax Rules and Parameters

<alter system cleanup plan statement>

There is not any syntax rules or parameters for <alter system cleanup plan statement>.

<domain name>

It is a name of a member or a group for which the statement is performed.

If it is omitted, it is performed for all groups.

Description

It cleans up all of the cached SQL plan. However, the plan whose V\$SQL CACHE.REF COUNT is bigger than 0 (the plan referenced by the prepared statement) is excluded from cleanup.

Examples

The following is an example of executing CLEANUP PLAN.

```
ALTER SYSTEM CLEANUP PLAN;
```

Compatibility

The SQL standard does not define the concepts of CLEANUP PLAN.

16.32 ALTER SYSTEM IRRECOVERABLE CLUSTER MEMBER

Function

It specifies an irrecoverable cluster member.

Syntax

```
<alter system irrecoverable cluster member statement> ::=  
    ALTER SYSTEM IRRECOVERABLE CLUSTER MEMBER <domain name>  
    ;
```

Invocation and Access Rules

ALTER SYSTEM ON DATABASE privilege is required to perform <alter system irrecoverable cluster member statement>.

Syntax Rules and Parameters

<alter system irrecoverable cluster member statement>

There is not any syntax rules or parameters for <alter system irrecoverable cluster member statement>.

<domain name>

It is a name of an irrecoverable member.

it is not allowed to specify all members in a group as an irrecoverable member.

Description

It is used to restart the system excluding the corresponding member if the cluster failed to restart due to an irrecoverable member. The corresponding member should be dropped by using **ALTER DATABASE DROP INACTIVE CLUSTER MEMBERS** after the system succeeded to restart.

Examples

The following is an example of executing **IRRECOVERABLE CLUSTER MEMBER**.

```
gSQL> ALTER SYSTEM IRRECOVERABLE CLUSTER MEMBER g1n1;
```

Compatibility

The SQL standard does not define the concepts of **IRRECOVERABLE CLUSTER MEMBER**.

16.33 ALTER SYSTEM JOIN DATABASE

Function

It includes a specific inactive cluster member in a cluster system again.

Syntax

```
<alter system join database statement> ::=  
    ALTER SYSTEM JOIN DATABASE  
    ;
```

Invocation and Access Rules

It can be performed in a cluster system.

ADMINISTRATION ON DATABASE privilege is required to perform <alter system join database statement>.

Description

The inactive state of a cluster member means that it is not connected to the cluster system, and it occurs in the following cases.

- An error occurs on a cluster member in an operating cluster system.
- Trying to start-up the cluster system without driving the cluster member included in the cluster system.

If a specific cluster member is inactive, then the member can be included in a cluster system again according to the following procedure.

- Start-up the unstarted cluster member to the local open phase.

```
$ gsql sys gliese --as sysdba --dsn=G3N2  
gSQL> \startup
```

- Include it in a cluster system by using `<alter system join database statement>`.

```
$ gsql sys gliese --as sysdba --dsn=G3N2
gSQL> ALTER SYSTEM JOIN DATABASE;
```

Use `<alter system join database statement>` to make an inactive cluster member which is started up to the local open phase to participate in the cluster system without shutting it down.

To make the inactive cluster member to participate in the cluster system again, the database state of the cluster system and that of the inactive cluster member should be same.

The inactive cluster member can not participate in the cluster system again after the transaction altering the database in the cluster system completed.

To operate the cluster system normally the inactive cluster members should be dropped according to the following procedure when multiple inactive cluster members exist.

1. JOIN inactive cluster members which can participate in the cluster system.

```
gSQL> ALTER SYSTEM JOIN DATABASE;
```

2. DROP inactive cluster members which can not participate in the cluster system.

```
gSQL> ALTER DATABASE DROP INACTIVE CLUSTER MEMBERS;
```

All inactive cluster members which can participate in the cluster system should be included in the cluster system before dropping because all inactive cluster members are dropped from the cluster system when performing `<alter database drop inactive cluster member statement>`.

Examples

```
gSQL> ALTER SYSTEM JOIN DATABASE;
```

Compatibility

The SQL standard does not define the concepts of the cluster.

For More Information

Refer to [ALTER DATABASE DROP INACTIVE CLUSTER MEMBERS](#).

16.34 ALTER SYSTEM {MOUNT | OPEN} DATABASE

E

Function

It mounts the database on system, or alters the database to the state which is available for the service.

Syntax

```
<alter system database statement> ::=  
    ALTER SYSTEM <alter system database clause>  
    ;  
<alter system database clause> ::=  
    MOUNT DATABASE  
    | OPEN [ <database_scope> ] DATABASE [ <open_database_option> ]  
<open_database_option> ::=  
    READ WRITE [ NORESETLOGS | RESETLOGS ]  
    | READ ONLY  
<database_scope> ::=  
    LOCAL  
    | GLOBAL
```

Invocation and Access Rules

ADMINISTRATION ON DATABASE privilege is required to perform <alter system database statement>.

Syntax Rules and Parameters

<alter system database clause>

- MOUNT DATABASE
 - It mounts the database on the system.
- OPEN DATABASE

- It changes the database to the state which is available for the service.

<open database option>

- READ ONLY / READ WRITE
 - It specifies the read/write mode and drives the database.
 - If it is omitted, it is driven in READ WRITE.
- RESETLOGS / NORESETLOGS
 - It determines whether to keep the online redo logs after recovering the database.
 - NORESETLOGS maintains the existing redo log, but RESETLOGS initializes it.
 - RESETLOGS should be specified when the database is incompletely recovered.
 - If it is omitted, NORESETLOGS is specified by default.

<database_scope>

- LOCAL
 - It starts up the LOCAL server to the OPEN phase.
- GLOBAL
 - It starts up the GLOBAL server, the entire server, to the OPEN phase.
- If it is omitted in a cluster environment, it starts up the GLOBAL server.

Examples

The following is an example of driving the database in read only.

```
ALTER SYSTEM OPEN DATABASE READ ONLY;
```

The following is an example of driving the database in read/write, and initializing the online redo logs.

```
ALTER SYSTEM OPEN DATABASE READ WRITE RESETLOGS;
```

Compatibility

The SQL standard does not define the concepts of MOUNT or OPEN in the database.

For More Information

Refer to `ALTER DATABASE RECOVER`.

16.35 ALTER SYSTEM [KILL | DISCONNECT] SESSION

Function

It terminates a session.

Syntax

```
<alter system end session statement> ::=
    ALTER SYSTEM DISCONNECT SESSION [<member_position>,<session_id>,<serial#> [<disconnect_option>] [AT <domain name>]
    | ALTER SYSTEM KILL SESSION [<member_position>,<session_id>,<serial#> [AT <domain name>]
    ;
<disconnect_option> ::=
    POST_TRANSACTION
    | IMMEDIATE
```

Invocation and Access Rules

ALTER SYSTEM ON DATABASE privilege is required to perform <alter system end session statement>.

Syntax Rules and Parameters

<member_position>

It is a member position of a session which is a disconnect/kill target in a cluster environment.

<session_id>

It is the session ID.

<serial#>

It is the SERIAL NUMBER of the session.

<disconnect_option>

- POST_TRANSACTION: The session is terminated after completion of the transaction.
- IMMEDIATE: The session is immediately terminated without waiting for the completion of the transaction.

If <disconnect_option> is not used, then it is operated in IMMEDIATE.

<domain name>

It is a name of a member or a group for which the statement is performed.

If it is omitted, it is performed for all groups.

Description

DISCONNECT SESSION can specify the options such as POST TRANSACTION and IMMEDIATE.

POST TRANSACTION terminates the session after the currently running transaction is completed. IMMEDIATE terminates the session after immediately cleaning up the currently running transaction.

KILL SESSION terminates the abnormal session which remains on the system without its process.

Example

```
gSQL> SELECT USER_NAME, SESSION_ID, SERIAL_NO, SESSION_STATUS, PROGRAM_NAME FROM V$SESSION
WHERE USER_NAME = 'TEST';
```

USER_NAME	SESSION_ID	SERIAL_NO	SESSION_STATUS	PROGRAM_NAME
TEST	62	49	CONNECTED	gsq1
TEST	65	109	CONNECTED	gsq1net
TEST	66	130	CONNECTED	gsq1

3 rows selected.

```
gSQL> ALTER SYSTEM DISCONNECT SESSION 65, 109;
```

System altered.

Compatibility

The SQL standard does not define it.

16.36 ALTER SYSTEM RECONNECT GLOBAL CONNECTION

Function

It determines whether to reconnect to the session which is connected in GLOBAL CONNECTION form.

Syntax

```
<alter system reconnect global connection statement> ::=  
    ALTER SYSTEM RECONNECT GLOBAL CONNECTION  
    ;
```

Invocation and Access Rules

ALTER SYSTEM ON DATABASE privilege is required to perform <alter system reconnect global connection statement>.

Description

Whether the GLOBAL CONNECTION client reconnects is determined by comparing SCN of a system object acquired from a server at the first connection and SCN of current server system object. This statement leads the client to reconnect by increasing SCN of the system object.

The client does not necessarily reconnect immediately after this statement is performed. The client reconnects by comparing SCN when the client executes a command in a server, and it does not try to reconnect if connections to all members from a client are valid.

Examples

The following is an example of executing the statement.

```
gSQL> ALTER SYSTEM RECONNECT GLOBAL CONNECTION;  
System altered.
```

Compatibility

The SQL standard does not define the concepts of GLOBAL CONNECTION.

16.37 ALTER SYSTEM RESET property_name

Function

It removes a property value from the property file.

Syntax

```
<alter system reset statement> ::=  
    ALTER SYSTEM { RESET | UNSET } <property name>  
        [ SCOPE = { FILE | SPFILE } ]  
        [ AT <domain name> ]  
    ;
```

Invocation and Access Rules

ALTER SYSTEM ON DATABASE privilege is required to perform <alter system reset statement>.

Syntax Rules and Parameters

{ RESET | UNSET }

RESET and UNSET are the reserved words with the same meaning, so either of them can be used.

<property name>

It is the property name to be removed.

For more information, refer to **Server Property** in an administration manual.

[SCOPE = { FILE | SPFILE }]

It removes the property from a property file, so only SCOPE=FILE/SPFILE can be used.

- SCOPE = FILE

- FILE and SPFILE are the reserved words with the same meaning, so either of them can be used.
- A property is removed from FILE, and is not applied to the current state.
- When restarting the database, the changes are applied.

If SCOPE clause is not specified, the default value is SCOPE = FILE.

<domain name>

It is a name of a member or a group for which the statement is performed.

If it is omitted, it is performed for all groups.

Description

If a property is altered by using SCOPE=FILE/SPFILE, the updated property value is stored in the property file, and it is applied when restarting the database.

When executing RESET, the updated property value is removed from the property file and the default value is used when restarting the database.

Examples

The following is an example of altering the property by using SCOPE=FILE.

```
gSQL> ALTER SYSTEM SET PROCESS_MAX_COUNT=128 SCOPE=FILE;
System altered.
gSQL> alter system set DEFAULT_INDEX_LOGGING=YES scope=FILE;
System altered.
```

The following is an example of removing the property altered above.

```
gSQL> ALTER SYSTEM RESET PROCESS_MAX_COUNT SCOPE=FILE;
System altered.
gSQL> ALTER SYSTEM RESET PROCESS_MAX_COUNT SCOPE=SPFILE;
System altered.
gSQL> ALTER SYSTEM RESET PROCESS_MAX_COUNT;
System altered.
gSQL> ALTER SYSTEM RESET DEFAULT_INDEX_LOGGING;
System altered.
```

```
gSQL> ALTER SYSTEM UNSET DEFAULT_INDEX_LOGGING;  
System altered.
```

Compatibility

The SQL standard does not define the concepts of the system property.

For More Information

Refer to `ALTER SYSTEM SET property_name`.

16.38 ALTER SYSTEM SET property_name

Function

It sets the system property value.

Syntax

```
<alter system set statement> ::=  
    ALTER SYSTEM SET <property name> { = <property value> | TO DEFAULT }  
        [ DEFERRED ]  
        [ SCOPE = [ MEMORY | { FILE | SPFILE } | BOTH ] ]  
    [AT <domain name>]  
    ;
```

Invocation and Access Rules

ALTER SYSTEM ON DATABASE privilege is required to perform <alter system set statement>.

Syntax Rules and Parameters

<property name>

It is the property name to be set.

For more information, refer to **10. Server Property** in an administration manual.

<property value>

It is the property value to be set.

TO DEFAULT

It sets the system property value as the initial value of system driving.

[DEFERRED]

It defines the point of time to apply the altered property.

- DEFERRED
 - It does not effect the current SESSION, but it is applied to the newly generated SESSION.
 - It can be applied when ISSYS_MODIFIABL property value is IMMEDIATE/DEFERRED. It should be explicitly specified.
 - It is not applicable when the ISSYS_MODIFIABLE property value is FALSE.

If ISSYS_MODIFIABLE property value is IMMEDIATE, and DEFERRED is not explicitly specified, then it is immediately applied to all sessions.

[SCOPE = [MEMORY | { FILE | SPFILE } | BOTH]]

It specifies the range which is affected by the property changes of the system.

- SCOPE = MEMORY
 - The changes are applied only to the current state, and the value is lost when restarting the database.
- SCOPE = FILE
 - FILE and SPFILE are the reserved words with the same meaning, so either of them can be used.
 - The changes are stored in FILE, and not applied to the current state.
 - The changes are applied when restarting the database.
- SCOPE = BOTH
 - The changes are stored in FILE, and applied to the current state.

If SCOPE clause is omitted, the default value is SCOPE = MEMORY.

If ISSYS_MODIFIABLE property value is FALSE, it should be specified as SCOPE=FILE/SPFILE.

<domain name>

It is a name of a member or a group for which the statement is performed.

If it is omitted, it is performed for all groups.

Description

For more information, refer to **Server Property** in an administration manual.

Examples

The following is an example of changing the property whose ISSYS_MODIFIABLE property is DEFERRED.

```
gSQL> ALTER SYSTEM SET SPIN_COUNT=1000;  
ERR-22000(13019): Specified property cannot be modified.(SPIN_COUNT)  
gSQL> ALTER SYSTEM SET SPIN_COUNT=1000 DEFERRED;  
System altered.
```

The following is an example of changing the property whose ISSYS_MODIFIABLE property is FALSE.

```
gSQL> ALTER SYSTEM SET PROCESS_MAX_COUNT=128;  
ERR-22000(13018): Specified property cannot be modified with this SCOPE  
option.(PROCESS_MAX_COUNT)  
gSQL> ALTER SYSTEM SET PROCESS_MAX_COUNT=128 SCOPE=FILE;  
System altered.
```

The following is an example of changing the altered property to the default value of when the session was connected.

```
gSQL> ALTER SYSTEM SET TRANSACTION_COMMIT_WRITE_MODE=0;  
System altered.  
gSQL> ALTER SYSTEM SET TRANSACTION_COMMIT_WRITE_MODE TO DEFAULT;  
System altered.  
gSQL> ALTER SYSTEM SET TRANSACTION_COMMIT_WRITE_MODE TO DEFAULT DEFERRED;  
System altered.
```

Compatibility

The SQL standard does not define the concepts of the system property.

For More Information

Refer to `ALTER SYSTEM RESET property_name`.

16.39 ALTER SYSTEM SWITCH LOGFILE

Function

It alters the log files in CURRENT state to ACTIVE state in database.

Syntax

```
<alter system switch logfile statement> ::=  
    ALTER SYSTEM SWITCH LOGFILE  
    [ AT <domain name> ]  
    ;
```

Invocation and Access Rules

ALTER SYSTEM ON DATABASE privilege is required to perform <alter system switch logfile statement>.

Syntax Rules and Parameters

<alter system switch logfile statement>

The database should be in MOUNT or OPEN phase.

<domain name>

It is a name of a member or a group for which the statement is performed.
If it is omitted, it is performed for all groups.

Description

Basically, if the log file in CURRENT state is filled, the log switch automatically occurs. That statement is used to forcibly execute log switch in special circumstances.

Example

```
ALTER SYSTEM SWITCH LOGFILE;
```

Compatibility

The SQL standard does not define the concepts of the LOGFILE.

For More Information

Refer to `ALTER SYSTEM {MOUNT | OPEN} DATABASE.`

16.40 ALTER TABLE

Function

It alters the table definition.

Syntax

```
<alter table statement> ::=  
    <alter table physical attribute statement>  
  | <rename table statement>  
  | <add column definition>  
  | <drop column definition>  
  | <alter column definition>  
  | <rename column statement>  
  | <add table constraint definition>  
  | <drop table constraint definition>  
  | <alter table constraint definition>  
  | <add table supplemental log statement>  
  | <drop table supplemental log statement>  
  | <rebalance statement>  
  | <move shard statement>  
  | <split shard statement>  
  ;
```

Invocation and Access Rules

One of the following privileges is required to perform <alter table statement>.

- (ALTER or CONTROL TABLE) ON TABLE for the table
- (ALTER TABLE or CONTROL SCHEMA) ON SCHEMA for the schema to which the table belongs
- ALTER ANY TABLE ON DATABASE

Syntax Rules and Parameters

⟨alter table physical attribute statement⟩

It alters physical attributes of a table.

For more information, refer to **ALTER TABLE name STORAGE**.

⟨rename table statement⟩

It renames the table.

For more information, refer to **ALTER TABLE name RENAME TO**.

⟨add column definition⟩

It adds columns to the table.

For more information, refer to **ALTER TABLE name ADD COLUMN**.

⟨drop column definition⟩

It drops a column from the table.

For more information, refer to **ALTER TABLE name SET UNUSED COLUMN**.

⟨alter column definition⟩

It alters the column definition in the table.

For more information, refer to **ALTER TABLE name ALTER COLUMN**.

⟨rename column statement⟩

It renames the column in the table.

For more information, refer to **ALTER TABLE name RENAME COLUMN**.

⟨add table constraint definition⟩

It adds constraints to the table.

For more information, refer to **ALTER TABLE name ADD CONSTRAINT**.

⟨drop table constraint definition⟩

It drops the constraints of the table.

For more information, refer to **ALTER TABLE name DROP CONSTRAINT**.

⟨alter table constraint definition⟩

It alters the constraints of the table.

For more information, refer to **ALTER TABLE name ALTER CONSTRAINT**.

⟨rename table constraint statement⟩

It renames the constraints of the table.

For more information, refer to **ALTER TABLE name RENAME CONSTRAINT**.

⟨add table supplemental log statement⟩

It sets to add information to the redo log when the data is altered in the table.

For more information, refer to **ALTER TABLE name ADD SUPPLEMENTAL LOG**.

⟨drop table supplemental log statement⟩

It sets not to add information to the redo log when the data is altered in the table.

For more information, refer to **ALTER TABLE name DROP SUPPLEMENTAL LOG**.

⟨rebalance statement⟩

It restores the data file matching by rebalancing the shard of the table or by synchronizing the broken shard in a cluster environment.

For more information, refer to **ALTER TABLE name REBALANCE**.

⟨move shard statement⟩

It rebalances a specific shard of a table on a specific cluster group in a cluster environment.

For more information, refer to **ALTER TABLE name MOVE SHARD**.

⟨split shard statement⟩

It rebalances a specific shard of a table on a specific cluster group by splitting the shard in a cluster environment.

For more information, refer to **ALTER TABLE name SPLIT SHARD**.

⟨rename shard statement⟩

It renames a specific shard of a table in cluster environment.

For more information, refer to **ALTER TABLE name RENAME SHARD**.

⟨read { only | write } statement⟩

It sets READ (only | write) to a table.

For more information, refer to **ALTER TABLE name READ { ONLY | WRITE }**.

Description

For more information, refer to the description of each detailed statement.

Example

Refer to the examples of each detailed statement.

Compatibility

The SQL standard does not define the following statements.

- ⟨alter table physical attribute statement⟩
- ⟨rename table statement⟩
- ⟨rename column statement⟩
- ⟨rename table constraint statement⟩
- ⟨add table supplemental log statement⟩
- ⟨drop table supplemental log statement⟩
- ⟨rebalance statement⟩
- ⟨move shard statement⟩

- <split shard statement>
- <rename shard statement>
- <read { only | write } statement>

16.41 ALTER TABLE name ADD COLUMN

Function

It adds a column to the table.

Syntax

```
<add column definition> ::=  
    ALTER TABLE table_name ADD [ COLUMN ] <column definition>  
    | ALTER TABLE table_name ADD [ COLUMN ] ( <column definition> [, ...] )  
    ;
```

Invocation and Access Rules

The user should satisfy the following conditions to perform <add column definition>.

- At least one of the following privileges is required to alter the table.
 - (ALTER or CONTROL TABLE) ON TABLE for that table
 - (ALTER TABLE or CONTROL SCHEMA) ON SCHEMA for the schema to which the table belongs
 - ALTER ANY TABLE ON DATABASE
- If the constraints are specified with the added columns, the conditions should be satisfied to generate the constraints as follows.
 - One of the following privileges is required for the schema in which constraints are to be generated.
 - (ADD CONSTRAINT or CONTROL SCHEMA) ON SCHEMA for the schema
 - ALTER ANY TABLE ON DATABASE
 - If the key constraint is to be generated, one of the following privileges is required for the tablespace in which an index is to be created.
 - CREATE OBJECT ON TABLESPACE for the tablespace
 - USAGE TABLESPACE ON DATABASE
- The table owner has the following privileges for the added columns.
 - Privileges on all added columns
 - SELECT(columns) ON TABLE WITH GRANT OPTION

- INSERT(columns) ON TABLE WITH GRANT OPTION
- UPDATE(columns) ON TABLE WITH GRANT OPTION
- REFERENCES(columns) ON TABLE WITH GRANT OPTION
- Privilege on the constraint generated together
 - The owner of that constraint
 - The index owner generated together with the constraint

Syntax Rules and Parameters

table_name

It is the table name to be altered.

It can define the schema to which the table belongs, such as schema_name.table_name. If schema_name is omitted, the default schema name of the user performing the statement is used.

ADD [COLUMN]

The reserved word COLUMN can be omitted.

<column definition>

It defines the column to be added. For more information, refer to <column definition> clause of CREATE TABLE statement.

There should not be columns with the same name in a table.

If DEFAULT clause is specified when defining the column, the default value of all rows are stored in the added column.

If <identity column specification> clause is specified when defining the column, each automatically generated value of all rows is stored in the added column.

If NOT NULL constraint is specified when defining the column, the table should be empty or it should be specified together with DEFAULT or <identity column specification> clause.

(<column definition> [, ...])

It adds multiple columns.

It lists multiple <column definition> inside the parentheses.

Description

The added column is positioned at the end of the existing columns.

When specifying DEFAULT or <identity column specification> clause, the processing time is increased in proportion to the number of the rows in the table.

Examples

The following is an example of adding a column.

```
gSQL> ALTER TABLE region ADD COLUMN r_new_comment VARCHAR(152);
Table altered.
```

The following is an example of adding multiple columns.

```
gSQL> ALTER TABLE partsupp ADD COLUMN (
  ps_retailprice NUMERIC(12,2),
  ps_acctbal NUMERIC(12,2), ps_mktsegment CHAR(10) );
Table altered.
```

The following is an example of adding the identity column and the column including DEFAULT clause.

```
gSQL> ALTER TABLE region ADD COLUMN (
  r_regionkey INTEGER GENERATED BY DEFAULT AS IDENTITY PRIMARY KEY,
  r_comment VARCHAR(152) DEFAULT 'N/A' );
```

Table altered.

```
gSQL> SELECT r_regionkey, r_name, r_comment FROM region;
```

R_REGIONKEY	R_NAME	R_COMMENT
1	AFRICA	N/A
2	AMERICA	N/A
3	ASIA	N/A
4	EUROPE	N/A
5	MIDDLE EAST	N/A

5 rows selected.

The following is an example of adding the column including the deferrable constraint.

```
gSQL> ALTER TABLE t1 ADD COLUMN ( id INTEGER CONSTRAINT t1_uk UNIQUE DEFERRABLE );  
Table altered.  
gSQL> COMMIT;  
Commit complete.
```

Compatibility

The SQL standard does not define of adding multiple column definitions.

For More Information

Refer to the followings.

- ALTER TABLE
- ALTER TABLE name SET UNUSED COLUMN
- ALTER TABLE name ALTER COLUMN
- ALTER TABLE name RENAME COLUMN

16.42 ALTER TABLE name SET UNUSED COLUMN

Function

It drops a table column.

Syntax

```
<drop column definition> ::=
    ALTER TABLE table_name <drop column clause>
    ;
<drop column clause> ::=
    SET UNUSED [ COLUMN ] <column_name_list> [ <drop behavior> ]
<column name list> ::=
    column_name
    | ( column_name [, ...] )
<drop behavior> ::=
    RESTRICT
    | CASCADE
    | CASCADE CONSTRAINTS
```

Invocation and Access Rules

One of the following privileges is required to perform <drop column definition>.

- (ALTER or CONTROL TABLE) ON TABLE for that table
- (ALTER TABLE or CONTROL SCHEMA) ON SCHEMA for the schema to which the table belongs
- ALTER ANY TABLE ON DATABASE

Syntax Rules and Parameters

table_name

It is the table name to be altered.

It can define the schema to which the table belongs, such as schema_name.table_name. If schema_name is omitted, the default schema name of the user performing the statement is used.

SET UNUSED [COLUMN]

It sets the column not to be used.

column_name_list

One or more column names to be dropped.

- e.g. ALTER TABLE t1 SET UNUSED COLUMN c1
- e.g. ALTER TABLE t1 SET UNUSED COLUMN (c1, c2)

column_name

It is the column name to be dropped.

It also drops the constraints and indexes which use the column.

drop behavior

When it is omitted, the default value is RESTRICT.

Currently, RESTRICT/CASCADE is operated in the same way.

Description

SET UNUSED COLUMN does not delete the data physically, so it ensures consistent performance regardless of the number of the rows.

Example

The following is an example of setting the column not to be used.

```
gSQL> ALTER TABLE t1 SET UNUSED COLUMN ( addr );  
Table altered.
```

Compatibility

The SQL standard does not define the following clauses.

- SET UNUSED
- CASCADE CONSTRAINTS
- Listing multiple columns

Table 16-3 SQL standard compatibility

Feature ID	Description	Compatibility
F033	ALTER TABLE statement: DROP COLUMN clause	X

For More Information

Refer to the followings.

- ALTER TABLE
- ALTER TABLE name ADD COLUMN
- ALTER TABLE name ALTER COLUMN
- ALTER TABLE name RENAME COLUMN

16.43 ALTER TABLE name ALTER COLUMN

Function

It alters the column definition.

Syntax

```

<alter column definition> ::=
    ALTER TABLE table_name
        ALTER [ COLUMN ] column_name <alter column action>
<alter column action> ::=
    <set column default clause>
  | <drop column default clause>
  | <set column not null clause>
  | <drop column not null clause>
  | <alter column data type clause>
  | <alter identity column specification>
  | <drop identity property clause>
  ;
<set column default clause> ::=
    SET DEFAULT <default option>
<drop column default clause> ::=
    DROP DEFAULT
<set column not null clause> ::=
    SET [ CONSTRAINT constraint_name ] NOT NULL [ <constraint characteristics> ]
<constraint characteristics> ::=
    [ NOT ] DEFERRABLE [ <constraint check time> ]
  | <constraint check time> [ [ NOT ] DEFERRABLE ]
<constraint check time> ::=
    INITIALLY DEFERRED
  | INITIALLY IMMEDIATE
<drop column not null clause> ::=
    DROP NOT NULL
<alter column data type clause> ::=
    SET DATA TYPE <data type>
<alter identity column specification> ::=

```

```

    <set identity column generation clause> [ <alter identity column option> ... ]
  | <alter identity column option> ...
<set identity column generation clause> ::=
    SET GENERATED { ALWAYS | BY DEFAULT }
<alter identity column option> ::=
    <alter sequence generator restart option>
  | [ SET ] <basic sequence generator option>
<alter sequence generator restart option> ::=
    RESTART [ WITH integer ]
<basic sequence generator option> ::=
    <sequence generator increment by option>
  | <sequence generator maxvalue option>
  | <sequence generator minvalue option>
  | <sequence generator cycle option>
  | <sequence generator cache option>
<drop identity property clause> ::=
    DROP IDENTITY

```

Invocation and Access Rules

One of the following privileges is required to performing <alter column definition>.

- (ALTER or CONTROL TABLE) ON TABLE for that table
- (ALTER TABLE or CONTROL SCHEMA) ON SCHEMA for the schema to which the table belongs
- ALTER ANY TABLE ON DATABASE

Syntax Rules and Parameters

table_name

It is the table name to be altered.

It can define the schema to which the table belongs, such as schema_name.table_name. If schema_name is omitted, the default schema name of the user performing the statement is used.

ALTER [COLUMN]

The reserved word COLUMN can be omitted.

column_name

It is the column name to be altered.

⟨set column default clause⟩

It sets the default value of the column.

It should not be an identity column.

The default value set when using the DEFAULT clause is used in INSERT statement later.

The data type of DEFAULT expression should be compatible with the data type of the column.

If there is insufficient space or the data type is not compatible, an error occurs when using DEFAULT in INSERT, UPDATE statements.

For more information, refer to ⟨default clause⟩ of CREATE TABLE statement.

⟨drop column default clause⟩

It drops the default value of the column.

It should not be an identity column.

If the default value is dropped, NULL is set when using DEFAULT clause in INSERT statement.

⟨set column not null clause⟩

- SET [CONSTRAINT constraint_name] NOT NULL [⟨constraint characteristics⟩]
 - It sets NOT NULL constraint on the column.
 - NULL is not allowed as the column value.
 - NULL should not exist in the column.
- If [CONSTRAINT constraint_name] is omitted, the constraint name is automatically given.
- If ⟨constraint characteristics⟩ is omitted, it has NOT DEFERRABLE INITIALLY IMMEDIATE property.
- The Identity column can not have DEFERRABLE property.

For more information about the DEFERRABLE constraint, refer to SET CONSTRAINTS.

<drop column not null clause>

- DROP NOT NULL
 - It drops NOT NULL constraint from the column.

<alter column data type clause>

- SET DATA TYPE <data type>
 - It changes the data type of the column.



SET DATA TYPE is a DDL statement which is automatically committed.

The type conversion can be executed among the same family, and it should satisfy the following conditions.

Table 16-4 Conversion of character string type

from \mathbb{W} to	CHAR(n)	VARHCHAR(n)	LONG VARCHAR
CHAR(m)	X	X	X
VARCHAR(m)	X	$n \geq m$	X
LONG VARCHAR	X	X	O

The conversion of char length unit should satisfy the following condition.

Table 16-5 Conversion of character length unit

from \mathbb{W} to	OCTETS	CHARACTERS
OCTETS	O	O
CHARACTERS	X	O

Table 16-6 Conversion of binary string type

from \mathbb{W} to	BINARY(n)	VARBINARY(n)	LONG VARBINARY
BINARY(m)	X	X	X
VARBINARY(m)	X	$n \geq m$	X
LONG VARBINARY	X	X	O

Table 16-7 Conversion of numeric type

from W to	SM ALLI NT	INTEGER	BIGINT	NUM ER IC	NUM ER IC(q)	NUM ER IC(q, t)	NUM BE R(q)	NUMBER (q,t)	REA L	DOU BLE P RECIS ION	FLO AT	FLOAT (q)	NUM BE R
SMAL LINT	O	O	O	O	q >= 5	q >= 5 t >= 0 (q-t) >= 5	q >= 5	q >= 5 t >= 0 (q-t) >= 5	O	O	O	ddc(q) >= 5	O
INTE GER	X	O	O	O	q >= 10	q >= 10 t >= 0 (q-t) >= 10	q >= 10	q >= 10 t >= 0 (q-t) >= 10	X	O	O	ddc(q) >= 10	O
BIGIN T	X	X	O	O	q >= 19	q >= 19 t >= 0 (q-t) >= 19	q >= 19	q >= 19 t >= 0 (q-t) >= 19	X	X	O	ddc(q) >= 19	O
NUM ERIC	X	X	X	O	q == 38	q == 38 t == 0	q == 38	q == 38 t == 0	X	X	O	ddc(q) == 38	O
NUM ERIC (p)	5 >= p	10 >= p	19 >= p	O	q >= p	q >= p t >= 0 (q-t) >= p	q >= p	q >= p t >= 0 (q-t) >= p	8 >= p	16 >= p	O	ddc(q) >= p	O
NUM ERIC (p,s)	5 >= p 0 >= s 5 >= (p-s)	10 >= p 0 >= s 10 >= (p-s)	19 >= p 0 >= s 9 >= (p-s)	38 >= p 0 >= s 38 >= (p-s)	q >= p 0 >= s q >= (p-s)	q >= p t >= s (q-t) >= (p-s)	q >= p 0 >= s q >= (p-s)	q >= p t >= s (q-t) >= (p-s)	8 >= p	16 >= p	O	ddc(q) >= p	O
NUM	5 >=				q >=	q >=	q >=	q >= p	8 >=	16 >=		ddc(q)	

from W to	SM ALLI NT	INTEGER	BIGINT	NUMERIC	NUMERIC(q)	NUMERIC(q, t)	NUMBER(q)	NUMBER (q,t)	REAL	DOUBLE PRECISION	FLOAT	FLOAT (q)	NUMBER
BER(p)	p	10 >= p	19 >= p	0	p	0 (q-t) >= p	p	t >= 0 (q-t) >= p	p	p	0	>= p	0
NUMBER(p, s)	5 >= p 0 >= s 5 >= (p-s)	10 >= p 0 >= s 10 >= (p-s)	19 >= p 0 >= s 19 >= (p-s)	38 >= p 0 >= s 3 >= (p-s)	q >= p 0 >= s q >= (p-s)	q >= p t >= s (q-t) >= (p-s)	q >= p 0 >= s q >= (p-s)	q >= p t >= s (q-t) >= (p-s)	8 >= p	16 >= p	0	ddc(q) >= p	0
REAL	X	X	X	X	X	X	X	X	0	0	0	ddc(q) >= 8	0
DOUBLE PRECISION	X	X	X	X	X	X	X	X	X	0	0	ddc(q) >= 16	0
FLOAT	X	X	X	X	X	X	X	X	X	X	0	ddc(q) == 38	0
FLOAT(p)	X	X	X	X	X	X	X	X	8 >= ddc(p)	16 >= ddc(p)	0	ddc(q) >= ddc(p)	0
NUMBER	X	X	X	X	X	X	X	X	X	-	0	ddc(q) == 38	0

Decimal digit count (ddc) value for the FLOAT (p) is as follows.

Table 16-8 Decimal digit count (ddc) value

FLOAT(p)	ddc(p)
1 ~ 3	1
4 ~ 6	2
7 ~ 9	3
10 ~ 13	4
14 ~ 16	5
17 ~ 19	6
20 ~ 23	7
24 ~ 26	8
27 ~ 29	9

FLOAT(p)	ddc(p)
30 ~ 33	10
34 ~ 36	11
37 ~ 39	12
40 ~ 43	13
44 ~ 46	14
47 ~ 49	15
50 ~ 53	16
54 ~ 56	17
57 ~ 59	18
60 ~ 63	19
64 ~ 66	20
67 ~ 69	21
70 ~ 73	22
74 ~ 76	23
77 ~ 79	24
80 ~ 83	25
84 ~ 86	26
87 ~ 89	27
90 ~ 93	28
94 ~ 96	29
97 ~ 99	30
100 ~ 103	31
104 ~ 106	32
107 ~ 109	33
110 ~ 113	34
114 ~ 116	35
117 ~ 119	36
120 ~ 123	37
124 ~ 126	38

All numeric types are managed in the same structure, and each numeric type is as same as the following NUMBER (p, s) expression.

Table 16-9 NUMBER expressions of the numeric types

Numeric type	NUMBER(p,s) expression
SMALLINT	NUMBER(5,0)
INTEGER	NUMBER(10,0)
BIGINT	NUMBER(19,0)
NUMERIC	NUMBER(38,0)
NUMERIC(p)	NUMBER(p,0)

Numeric type	NUMBER(p,s) expression
NUMERIC(p,s)	NUMBER(p,s)
NUMBER(p)	NUMBER(p,0)
NUMBER(p,s)	NUMBER(p,s)
REAL	NUMBER(8,N/A) <= FLOAT(24)
DOUBLE PRECISION	NUMBER(16,N/A) <= FLOAT(53)
FLOAT	NUMBER(38,N/A) <= FLOAT(126)
FLOAT(p)	NUMBER(ddc(p), N/A)
NUMBER	NUMBER(38, N/A)

Native numeric type is as same with as C language numeric type, and it can not be converted to another type.

Table 16-10 Conversion of native numeric type

from W to	NATIVE_SMALLINT	NATIVE_INTEGER	NATIVE_BIGINT	NATIVE_REAL	NATIVE_DOUBLE
NATIVE_SMALLINT	O	X	X	X	X
NATIVE_INTEGER	X	O	X	X	X
NATIVE_BIGINT	X	X	O	X	X
NATIVE_REAL	X	X	X	O	X
NATIVE_DOUBLE	X	X	X	X	O

Table 16-11 Conversion of boolean type

from W to	BOOLEAN
BOOLEAN	O

Table 16-12 Conversion of date/time type (TZ: WITH TIME ZONE)

from W to	DATE	TIME	TIME(g)	TIME T Z	TIME(g) TZ	TIMESTAMP	TIMESTAMP P(g)	TIMESTAMP P TZ	TIMESTAMP (g) TZ
DATE	O	X	X	X	X	X	X	X	X
TIME	X	O	g >= 6	X	X	X	X	X	X
TIME(f)	X	6 >= f	g >= f	X	X	X	X	X	X
TIME TZ	X	X	X	O	g >= 6	X	X	X	X
TIME(f) TZ	X	X	X	6 >= f	g >= f	X	X	X	X
TIMESTAMP	X	X	X	X	X	O	g >= 6	X	X
TIMESTAMP (f)	X	X	X	X	X	6 >= f	g >= f	X	X
TIMESTAMP	X	X	X	X	X	X	X	O	g >= 6

from \mathbb{W} to	DATE	TIME	TIME(g)	TIME TZ	TIME(g) TZ	TIMESTAMP	TIMESTAMP(g)	TIMESTAMP TZ	TIMESTAMP(g) TZ
TZ									
TIMESTAMP(f) TZ	X	X	X	X	X	X	X	6 \geq f	g \geq f

Table 16-13 Type conversion of INTERVAL YEAR TO MONTH family (If p,q are omitted, then it is 2.)

from \mathbb{W} to	YEAR(q)	MONTH(q)	YEAR(q) TO MONTH
YEAR(p)	q \geq p	X	X
MONTH(p)	X	q \geq p	X
YEAR(p) TO MONTH	X	X	q \geq p

Table 16-14 Type conversion of INTERVAL DAY TO TIME family (If p,q are omitted, then it is 2.) (If f,g are omitted, then it is 6.)

from \mathbb{W} to	DAY(q)	HOUR(q)	MINUTE(q)	SECOND(q, g)	DAY(q) TO HOUR	DAY(q) TO MINUTE	DAY(q) TO SECOND(g)	HOUR(q) TO MINUTE	HOUR(q) TO SECOND(g)	MINUTE(q) TO SECOND(g)
DAY(p)	q \geq p	X	X	X	X	X	X	X	X	X
HOUR(p)	X	q \geq p	X	X	X	X	X	X	X	X
MINUTE(p)	X	X	q \geq p	X	X	X	X	X	X	X
SECOND(p, f)	X	X	X	q \geq p g \geq f	X	X	X	X	X	X
DAY(p) TO HOUR	X	X	X	X	q \geq p	X	X	X	X	X
DAY(p) TO MINUTE	X	X	X	X	X	q \geq p	X	X	X	X
DAY(p) TO SECOND(f)	X	X	X	X	X	X	q \geq p g \geq f	X	X	X
HOUR(p) TO MINUTE	X	X	X	X	X	X	X	q \geq p	X	X
HOUR(p) TO SECOND(f)	X	X	X	X	X	X	X	X	q \geq p g \geq f	X
MINUTE(p)	X	X	X	X	X	X	X	X	X	q \geq p

from \mathbb{W} to	DAY (q)	HO UR (q)	MIN UTE (q)	SECO ND(q, g)	DAY(q) TO HOU R	DAY(q) T O MINUT E	DAY(q) T O SECON D(g)	HOUR(q) TO MINU TE	HOUR(q) T O SECOND (g)	MINUTE(q) TO SECOND (g)
TO SECOND (f)										g >= f

Table 16-15 Conversion of ROWID type

from \mathbb{W} to	ROWID
ROWID	O

⟨alter identity column specification⟩

It alters the identity property of the column.

The column should be an identity column.

- SET GENERATED [ALWAYS | BY DEFAULT]
 - It changes the method of generating the identity column.
 - For more information, refer to ⟨identity column specification⟩ of CREATE TABLE statement.
- ⟨alter sequence generator restart option⟩
 - It changes NEXT VALUE of the identity column.
 - For more information, refer to ⟨alter sequence generator restart option⟩ clause of ALTER SEQUENCE statement.
- ⟨basic sequence generator option⟩
 - It changes the property of the identity column.
 - In SQL standard, it is defined to be described in the form of SET ⟨basic sequence generator option⟩, but it can be omitted.
 - For more information, refer to ALTER SEQUENCE statement.

⟨drop identity property clause⟩

It drops the identity property of the column.

The column should be the identity column.

Description

SET NOT NULL clause requires the time for checking null in proportion to the number of table rows.

The following columns do not allow NULL values. In other words, even if DROP NOT NULL clause is performed, NULL is not allowed in the following cases.

- A column which includes NOT NULL constraint
- A column which is included in primary key constraint
- An identity column

The change of the default value using SET DEFAULT clause and the change of the identity property using <alter identity column specification> clause, is applied to INSERT or UPDATE statement which is performed later.

Examples

The following is an example of setting DEFAULT property to the column.

```
gSQL> ALTER TABLE region ALTER COLUMN r_comment SET DEFAULT 'N/A';  
Table altered.
```

The following is an example of dropping DEFAULT property from the column.

```
gSQL> ALTER TABLE region ALTER COLUMN r_comment DROP DEFAULT;  
Table altered.
```

The following is an example of setting NOT NULL constraint to the column.

```
gSQL> ALTER TABLE region ALTER COLUMN r_regionkey SET NOT NULL;  
Table altered.
```

The following is an example of dropping the NOT NULL constraint from the column.

```
gSQL> ALTER TABLE region ALTER COLUMN r_regionkey DROP NOT NULL;  
Table altered.
```

The following is an example of extending the data type size of the column.

```
gSQL> ALTER TABLE region ALTER COLUMN r_comment SET DATA TYPE VARCHAR(512);  
Table altered.
```

The following is an example of restarting the next value of the identity column.

```
gSQL> ALTER TABLE region ALTER COLUMN r_regionkey RESTART;
Table altered.
```

The following is an example of dropping the identity property from the column.

```
gSQL> ALTER TABLE region ALTER COLUMN r_regionkey DROP IDENTITY;
Table altered.
```

Compatibility

Table 16-16 The SQL standards compatibility

Feature ID	Description	Compatibility
F381	Extended schema manipulation	X
F382	Alter column data type	O
F383	Set column not null clause	O
F384	Drop identity property value	O
F385	Drop column generation expression clause	X
F386	Set identity column generation clause	O
S043	Enhanced reference types	X
T174	Identity columns	O
T178	Identity columns: simple restart option	O

For More Information

Refer to the followings.

- **ALTER TABLE**
- **ALTER TABLE name ADD COLUMN**
- **ALTER TABLE name SET UNUSED COLUMN**
- **ALTER TABLE name RENAME COLUMN**

16.44 ALTER TABLE name RENAME COLUMN

Function

It renames the table column.

Syntax

```
<rename column statement> ::=  
    ALTER TABLE table_name  
        RENAME COLUMN old_column_name TO new_column_name  
    ;
```

Invocation and Access Rules

One of the following privileges is required to perform <rename column statement>.

- (ALTER or CONTROL TABLE) ON TABLE for that table
- (ALTER TABLE or CONTROL SCHEMA) ON SCHEMA for the schema to which the table belongs
- ALTER ANY TABLE ON DATABASE

Syntax Rules and Parameters

table_name

It is the table name to be altered.

It can define the schema to which the table belongs, such as schema_name.table_name. If schema_name is omitted, the default schema name of the user performing the statement is used.

old_column_name

It is the old column name to be altered.

new_column_name

It is the new column name to be altered.

The same column name should not exist in a table.

Description

Even when the column name is altered it does not require the object change such as index, constraint which is generated based on the previous column.

Example

The following is an example of exchanging the names of two columns, col_1 and col_2.

```
gSQL> ALTER TABLE t1 RENAME COLUMN col_1 TO col_temp;
Table altered.
gSQL> ALTER TABLE t1 RENAME COLUMN col_2 TO col_1;
Table altered.
gSQL> ALTER TABLE t1 RENAME COLUMN col_temp TO col_2;
Table altered.
gSQL> COMMIT;
Commit complete.
```

Compatibility

The SQL standard does not define <rename column statement>.

For More Information

Refer to the followings.

- ALTER TABLE
- ALTER TABLE name ADD COLUMN
- ALTER TABLE name SET UNUSED COLUMN
- ALTER TABLE name ALTER COLUMN

16.45 ALTER TABLE name ADD CONSTRAINT

Function

It adds a table constraint.

Syntax

```
<add table constraint definition> ::=  
    ALTER TABLE table_name  
        ADD <table constraint definition>  
    ;
```

Invocation and Access Rules

The user should satisfy the following conditions to perform <add table constraint definition> clause.

- One of the following privileges is required on the table to create the constraint.
 - (ALTER or CONTROL TABLE) ON TABLE for that table
 - (ALTER TABLE or CONTROL SCHEMA) ON SCHEMA for the schema to which the table belongs
 - ALTER ANY TABLE ON DATABASE
- One of the following privileges is required on the schema to create the constraint.
 - (ADD CONSTRAINT or CONTROL SCHEMA) ON SCHEMA for the schema
 - ALTER ANY TABLE ON DATABASE
- One of the following privileges is required for the tablespace in which the index is to be created to create the key constraint
 - CREATE OBJECT ON TABLESPACE for the tablespace
 - USAGE TABLESPACE ON DATABASE
- The owner of the created constraint is determined as follow.
 - The owner of the schema to which the constraint belongs.
 - If the schema to which the constraint belongs is PUBLIC, then it is the user who executed the statement.



Constraints of PRIMARY KEY, UNIQUE in a cluster system should include all sharding keys.

Syntax Rules and Parameters

table_name

It is the table name to be altered.

It can define the schema to which the table belongs, such as schema_name.table_name. If schema_name is omitted, the default schema name of the user performing the statement is used.

<table constraint definition>

It defines the constraint to be added.

NOT NULL constraint can not be added by using ALTER TABLE .. ADD CONSTRAINT statement, and it can be defined by using ALTER TABLE name ALTER COLUMN statement as follows.

```
ALTER TABLE t1 ALTER COLUMN c1 SET NOT NULL;
```

For more information, refer to <table constraint definition> clause of CREATE TABLE statement.

Description

When adding the key constraints such as primary key, unique key, the index is automatically created for them.

Examples

The following is an example of adding the primary key constraint to the table.

```
gSQL> ALTER TABLE t1 ADD PRIMARY KEY ( id );  
Table altered.
```

The following is an example of specifying the constraint name when adding a primary key constraint to the table.

```
gSQL> ALTER TABLE t1 ADD CONSTRAINT t1_pk PRIMARY KEY ( id );  
Table altered.
```

The following is an example of adding a DEFERRABLE constraint.

```
gSQL> ALTER TABLE t1 ADD CONSTRAINT t1_uk UNIQUE ( id ) DEFERRABLE INITIALLY DEFERRED;  
Table altered.  
gSQL> COMMIT;  
Commit complete.
```

Compatibility

Table 16-17 SQL standard compatibility

Feature ID	Description	Compatibility
F381	Extended schema manipulation	O

For More Information

Refer to the followings.

- CREATE TABLE
- CREATE INDEX
- ALTER TABLE
- ALTER TABLE name DROP CONSTRAINT

16.46 ALTER TABLE name DROP CONSTRAINT

Function

It drops a table constraint.

Syntax

```
<drop table constraint definition> ::=  
    ALTER TABLE table_name  
        DROP <constraint object>  
        [ <drop behavior> ]  
    ;  
<constraint object> ::=  
    CONSTRAINT constraint_name  
    | PRIMARY KEY  
    | UNIQUE ( column_name [, ...] )  
<drop behavior> ::=  
    RESTRICT  
    | CASCADE  
    | CASCADE CONSTRAINTS
```

Invocation and Access Rules

One of the following privileges is required to perform <drop table constraint definition>.

- The owner of that constraint
- (ALTER or CONTROL TABLE) ON TABLE for that table
- (ALTER TABLE or CONTROL SCHEMA) ON SCHEMA for the schema to which the table belongs
- ALTER ANY TABLE ON DATABASE

Syntax Rules and Parameters

table_name

It is the table name to be altered.

It can define the schema to which the table belongs, such as schema_name.table_name. If schema_name is omitted, the default schema name of the user performing the statement is used.

CONSTRAINT constraint_name

It is the constraint name to be dropped.

PRIMARY KEY

It is the primary key constraint for the table.

UNIQUE(column_name [, ...])

It is the unique constraint for the columns.

<drop behavior>

When it is omitted, the default value is RESTRICT.

Currently, RESTRICT/CASCADE is operated in the same way.

Description

<drop column not null clause> of ALTER TABLE name ALTER COLUMN is used to drop NOT NULL constraint without using the constraint name.

Examples

The following is an example of dropping a primary key constraint from the table.

```
gSQL> ALTER TABLE t1 DROP PRIMARY KEY;
```

```
Table altered.
```

The following is an example of dropping the table constraint by specifying the constraint name.

```
gSQL> ALTER TABLE t1 DROP CONSTRAINT t1_pk;  
Table altered.
```

Compatibility

The SQL standard does not define the following clauses.

- DROP PRIMARY KEY
- DROP UNIQUE (column_name [, ...])
- CASCADE CONSTRAINTS

Table 16-18 SQL standard compatibility

Feature ID	Description	Compatibility
F381	Extended schema manipulation	O

For More Information

Refer to the followings.

- ALTER TABLE
- ALTER TABLE name ADD CONSTRAINT
- DROP INDEX

16.47 ALTER TABLE name ALTER CONSTRAINT

Function

It alters the characteristics of the table constraint.

Syntax

```

<alter table constraint definition> ::=
    ALTER TABLE table_name
        ALTER <constraint object> <constraint characteristics>
    ;
<constraint object> ::=
    CONSTRAINT constraint_name
    | PRIMARY KEY
    | UNIQUE ( column_name [, ...] )
<constraint characteristics> ::=
    [ NOT ] DEFERRABLE [ <constraint check time> ]
    | <constraint check time> [ [ NOT ] DEFERRABLE ]
<constraint check time> ::=
    INITIALLY DEFERRED
    | INITIALLY IMMEDIATE
  
```

Invocation and Access Rules

One of the following privileges is required to perform <alter table constraint definition>.

- (ALTER or CONTROL TABLE) ON TABLE for that table
- (ALTER TABLE or CONTROL SCHEMA) ON SCHEMA for the schema to which the table belongs
- ALTER ANY TABLE ON DATABASE



Cluster does not support the deferrable constraints.

Syntax Rules and Parameters

table_name

It is the table name to be altered.

It can define the schema to which the table belongs, such as schema_name.table_name. If schema_name is omitted, the default schema name of the user performing the statement is used.

<constraint object>

The constraint to be altered is specified as follows.

- CONSTRAINT constraint_name
 - The constraint name to be altered.
- PRIMARY KEY
 - PRIMARY KEY constraint of the table
- UNIQUE(column [,...])
 - UNIQUE constraint which satisfies the column list.

DEFERRABLE | NOT DEFERRABLE

It alters whether the constraint state is deferrable.

- DEFERRABLE
 - The constraint is altered to be deferrable.
- NOT DEFERRABLE
 - The constraint is altered not to be deferrable.

INITIALLY IMMEDIATE | INITIALLY DEFERRED

It alters an initial value of the check point for the constraint.

- INITIALLY IMMEDIATE
 - It checks the constraints at the time of DML.
- INITIALLY DEFERRED
 - It checks the constraints at the time of COMMIT.

The constraints defined as NOT DEFERRABLE can not be altered to INITIALLY DEFERRED.

Description

For more information about the deferrable constraints, refer to **SET CONSTRAINTS**.

Example

The following is an example that the constraint t1_uk is set as deferrable and its checking time is set as DEFERRED.

```
gSQL> ALTER TABLE t1 ALTER CONSTRAINT t1_uk DEFERRABLE INITIALLY DEFERRED;  
Table altered.  
gSQL> COMMIT;  
Commit complete.
```

Compatibility

The SQL standard does not define the following clauses.

- ALTER PRIMARY KEY clause
- ALTER UNIQUE(column [...]) clause

Table 16-19 SQL standard compatibility

Feature ID	Description	Compatibility
F492	Optional table constraint enforcement	X

16.48 ALTER TABLE name RENAME CONSTRAINT

Function

It renames the table constraints.

Syntax

```
<rename table constraint statement> ::=  
    ALTER TABLE table_name  
        RENAME <constraint object> TO new_constraint_name  
    ;  
<constraint object> ::=  
    CONSTRAINT constraint_name  
    | PRIMARY KEY  
    | UNIQUE ( column_name [, ...] )
```

Invocation and Access Rules

One of the following privileges is required to perform <rename table constraint statement>.

- (ALTER or CONTROL TABLE) ON TABLE for that table
- (ALTER TABLE or CONTROL SCHEMA) ON SCHEMA for the schema to which the table belongs
- ALTER ANY TABLE ON DATABASE

Syntax Rules and Parameters

table_name

It is the table name to be altered.

It can define the schema to which the table belongs, such as schema_name.table_name. If schema_name is omitted, the default schema name of the user performing the statement is used.

<constraint object>

The existing name of the constraint to be altered is specified as follows.

- CONSTRAINT constraint_name
 - The constraint name to be altered
- PRIMARY KEY
 - PRIMARY KEY constraint of the table
- UNIQUE(column [,...])
 - UNIQUE constraint which satisfies the column list

new_column_name

It is the new name of a constraint to be altered.

Description

The index name which was automatically created with a key constraint such as primary key, unique key is not altered. Use **ALTER INDEX name RENAME TO** statement to rename the index.

Examples

The following is an example of renaming the primary key constraint of the table.

```
gSQL> ALTER TABLE t1 RENAME PRIMARY KEY TO pk_t1;  
Table altered.
```

The following is an example of renaming the table constraint by specifying the constraint name.

```
gSQL> ALTER TABLE t1 RENAME CONSTRAINT pk_t1 TO t1_pk;  
Table altered.
```

Compatibility

The SQL standard does not define the <rename table constraint statement> statement.

For More Information

Refer to the followings.

- ALTER TABLE
- ALTER TABLE name ADD CONSTRAINT
- ALTER TABLE name DROP CONSTRAINT
- ALTER TABLE name ALTER CONSTRAINT

16.49 ALTER TABLE name ADD GLOBAL SECONDARY INDEX

Function

It creates a global secondary index in a table.

Syntax

```

<alter table add global secondary index definition> ::=
    ALTER TABLE table_name
        ADD GLOBAL SECONDARY INDEX
            [ <index attributes> [...] ] [ TABLESPACE tablespace_name ]
    ;
<index attributes> ::=
    <physical attribute clause>
    | STORAGE ( <segment attr clause> [...] )
    | <logging clause>
    | <parallel clause>
<physical attribute clause> ::=
    PCTFREE integer
    | INITTRANS integer
    | MAXTRANS integer
<segment attr clause> ::=
    INITIAL <size_clause>
    | NEXT <size_clause>
    | MINSIZE <size_clause>
    | MAXSIZE <size_clause>
<size clause> ::=
    integer [ K | M | G | T ]
<logging clause> ::=
    LOGGING
    | NOLOGGING
<parallel clause> ::=
    NOPARALLEL
    | PARALLEL [ integer ]

```

Invocation and Access Rules

⟨alter table add global secondary index definition⟩ can be defined in a cluster system, and a user should satisfy the following conditions.

- At least one of the following privileges for a table in which the index is to be created is required.
 - (ALTER or CONTROL TABLE) ON TABLE for that table
 - (ALTER TABLE or CONTROL SCHEMA) ON SCHEMA for the schema to which the table belongs.
 - ALTER ANY TABLE ON DATABASE
- At least one of the following privileges for a tablespace in which the index is to be created is required.
 - CREATE OBJECT ON TABLESPACE for that tablespace
 - USAGE TABLESPACE ON DATABASE

Syntax Rules and Parameters

table_name

It is the name of a table in which the index is to be created.

It can define a schema to which the table belongs such as schema_name.table_name.

If schema_name is omitted, the default schema name of the user performing the statement is used.

⟨physical attribute clause⟩

It defines the physical attribute information of the index.

- PCTFREE integer
 - Definition
 - The reserved space to adjust the frequency of page splits caused by inserting the key in the page.
 - It is applied only when the index bottom-up build.
 - It can use of the value from 0 to 99.
 - If it is omitted, the value set in DEFAULT_INDEX_PCTFREE property is used by default.
- INITRANS integer
 - Definition
 - The initial number of transactions simultaneously accessing the page.
 - If the number of users accessing the index is small, then INITRANS is set low. If the number of users simultaneously accessing the index is big, then INITRANS is set high.
 - If necessary, it is automatically increased to the specified MAXTRANS.

- It can use the value from 1 to 32.
- If it is omitted, the default value is 4.
- MAXTRANS integer
 - Definition
 - It specifies the maximum number of transaction simultaneously accessing the page.
 - It can use the value from 1 to 32.
 - If it is omitted, the default value is 8.

⟨segment attr clause⟩

It specifies the information for the index storage space.

- INITIAL integer
 - Definition
 - It specifies the size of physical storage space which is initially allocated when creating the index.
 - This size is aligned to the EXTENT size of the TABLESPACE to which the table belongs. (e.g. If the EXT size is 8192 bytes, 'INITIAL 100' is actually operated as 8192 bytes.)
 - The size (aligned to the EXTENT size of TABLESPACE) should be equal to or bigger than MIN EXTENTS, or it should be equal to or less than MAXEXTENTS.
 - The minimum value is 1, and the maximum value depends on the system environment.
 - If it is omitted, the default value is one EXTENT size of TABLESPACE to which the table belongs.
- NEXT integer
 - Definition
 - It specifies the physical space size to be allocated when adding the space to the index.
 - This size is aligned to the EXTENT size of the TABLESPACE to which the table belongs. (e.g. If the EXT size is 8192 bytes, 'NEXT 100' is actually operated as 8192 bytes.)
 - NEXT operates as follows, depending on the remaining space size of the index available currently. (Obtained by subtracting the amount of currently used space from the MAXEXTENTS size)
 - If the remaining space size is 0, then it can not extend the space.
 - If the remaining space size is bigger than 0, but smaller than NEXT, then it allocates the space as big as the remaining space.
 - If the remaining space size is bigger than NEXT, then it allocates the space as big as the NEXT.
 - The minimum value is 1 and the maximum value depends on the system environment.
 - If it is omitted, the default value is one EXTENT size of TABLESPACE to which the index belongs.
- MINSIZE integer
 - Definition
 - It is the minimum space size of the index.
 - The value should be equal to or smaller than MAXSIZE.

- This size is aligned to the EXTENT size of the TABLESPACE to which the index belongs.
- The minimum value is 1 and the maximum value depends on the system environment.
- If it is smaller than the size of two EXTENT, it is specified to the size of two EXTENT.
- If it is omitted, the default value is the size of two EXTENT.
- MAXSIZE integer
 - Definition
 - It is the maximum space size of the index.
 - The value should be equal to or bigger than MINSIZE.
 - This size is aligned to the EXTENT size of the TABLESPACE to which the index belongs.
 - The minimum value is 1 and the maximum value depends on the system environment.
 - If it is omitted, the default value is EXTENT size * 2147483647(The maximum positive integer of INT32).

⟨size clause⟩

It specifies the file size in byte. (If it is omitted, the default unit is bytes.)

- K: Kilobytes
- M: Megabytes
- G: Gigabytes
- T: Terabytes

LOGGING | NOLOGGING

It specifies whether to redo log the index.

If it is omitted, the default value is NOLOGGING.

NOPARALLEL | PARALLEL [integer]

It specifies the number of threads to be used when building an index.

- NOPARALLEL
 - It does not build an index in parallel.
- PARALLEL [integer]
 - It builds an index in parallel.
 - If an integer is omitted or set as 0, then it follows the property (INDEX_BUILD_PARALLEL_FACTOR).
 - The minimum value of an integer is 0 and the maximum value is 16.
 - If the property value is 0, then the system determines the optimal value.
- If it is omitted, the default value is PARALLEL.

TABLESPACE tablespace_name

It specifies the name of the tablespace in which the index is to be stored.

- If it specifies tablespace_name
 - The tablespace_name of LOGGING index should be a data tablespace.
 - The tablespace_name of NOLOGGING index should be a temporary tablespace or a nologging tablespace.
- If it omits TABLESPACE clause
 - If INDEX TABLESPACE tablespace_name of USER is specified
 - The defined tablespace is used.
 - If INDEX TABLESPACE of USER is NULL
 - LOGGING index uses the user's default data tablespace.
 - NOLOGGING index uses the user's default temporary tablespace.

Description

A non-deterministic query requires the global secondary index. LOGGING index and NOLOGGING index have the following trade-offs.

- LOGGING index
 - Advantage: It does not separately build an index because the index is automatically restored by using the log when starting up the system.
 - Disadvantage: A disk I/O occurs because the changes on the index are recorded on the log when altering the row.
- NOLOGGING index
 - Advantage: A disk I/O does not occur for the changes on the index when altering the row.
 - Disadvantage: It automatically rebuilds the index when starting up the system because the log information of the index does not exist.

Examples

The following is an example of adding a global secondary index to the table T1.

```
gSQL> ALTER TABLE T1 ADD GLOBAL SECONDARY INDEX;  
Table altered.  
gSQL> COMMIT;  
Commit complete.
```

The following is an example of creating a global secondary index with a logging option on the tablespace USER_DATA_TBS of table T1.

```
gSQL> ALTER TABLE T1 ADD GLOBAL SECONDARY INDEX LOGGING TABLESPACE USER_DATA_TBS;  
Table altered.  
gSQL> COMMIT;  
Commit complete.
```

The following is an example of creating a global secondary index with a nologging option on the tablespace USER_TEMP_TBS of table T1.

```
gSQL> ALTER TABLE T1 ADD GLOBAL SECONDARY INDEX NOLOGGING TABLESPACE USER_TEMP_TBS;  
Table altered.  
gSQL> COMMIT;  
Commit complete.
```

Compatibility

The SQL standard does not define the concepts of the global secondary index.

For More Information

Refer to the followings.

- ALTER TABLE name DROP GLOBAL SECONDARY INDEX
- ALTER TABLE name ALTER GLOBAL SECONDARY INDEX
- CREATE TABLE

16.50 ALTER TABLE name DROP GLOBAL SECONDARY INDEX

Function

It drops a global secondary index from the table.

Syntax

```
<alter table drop global secondary index definition> ::=  
    ALTER TABLE table_name  
        DROP GLOBAL SECONDARY INDEX  
    ;
```

Invocation and Access Rules

<alter table drop global secondary index definition> statement can be defined in a cluster system, and the user should satisfy the following conditions.

- The following privilege for the table from which the index is to be dropped is required
 - (ALTER or CONTROL TABLE) ON TABLE for that table
 - (ALTER TABLE or CONTROL SCHEMA) ON SCHEMA for the schema to which the table belongs
 - ALTER ANY TABLE ON DATABASE

Syntax Rules and Parameters

table_name

It is the name of a table from which the index is to be dropped.

Description

A global secondary index is required to enquire a non-deterministic query.

Examples

It drops a global secondary index from the table T1.

```
gSQL> ALTER TABLE T1 DROP GLOBAL SECONDARY INDEX;  
Table altered.  
gSQL> COMMIT;  
Commit complete.
```

Compatibility

The SQL standard does not define the concepts of the global secondary index.

For More Information

Refer to the followings.

- ALTER TABLE name ADD GLOBAL SECONDARY INDEX
- ALTER TABLE name ALTER GLOBAL SECONDARY INDEX

16.51 ALTER TABLE name ALTER GLOBAL SECONDARY INDEX

Function

It alters the physical attributes of the global secondary index in the table.

Syntax

```

<alter table alter global secondary index storage statement> ::=
    ALTER TABLE table_name ALTER GLOBAL SECONDARY INDEX
        <physical attribute clause>
        | [ STORAGE ( <segment attr clause> [...] ) ]
    ;
<physical attribute clause> ::=
    PCTFREE integer
    | INITTRANS integer
    | MAXTRANS integer
<segment attr clause> ::=
    INITIAL <size_clause>
    | NEXT <size_clause>
    | MINSIZE <size_clause>
    | MAXSIZE <size_clause>
<size clause> ::=
    integer [ K | M | G | T ]

```

Invocation and Access Rules

One of the following privileges is required to perform <alter table alter global secondary index storage statement>.

- (ALTER or CONTROL TABLE) ON TABLE for that table
- (ALTER TABLE or CONTROL SCHEMA) ON SCHEMA for the schema to which the table belongs
- ALTER ANY TABLE ON DATABASE

Syntax Rules and Parameters

table_name

It is the name of a table in which the index is to be created.

It can define a schema to which the table belongs such as schema_name.table_name.

If schema_name is omitted, the default schema name of the user performing the statement is used.

<physical attribute clause>

It defines the physical attribute information of the index.

- PCTFREE integer
 - Definition
 - The reserved space to adjust the frequency of page splits caused by inserting the key in the page.
 - It is applied only when the index bottom-up build.
 - It can use of the value from 0 to 99.
 - If it is omitted, the value set in DEFAULT_INDEX_PCTFREE property is used by default.
- INITRANS integer
 - Definition
 - The initial number of transactions simultaneously accessing the page.
 - If the number of users accessing the index is small, then INITRANS is set low. If the number of users simultaneously accessing the index is big, then INITRANS is set high.
 - If necessary, it is automatically increased to the specified MAXTRANS.
 - It can use the value from 1 to 32.
 - If it is omitted, the default value is 4.
- MAXTRANS integer
 - Definition
 - It specifies the maximum number of transaction simultaneously accessing the page.
 - It can use the value from 1 to 32.
 - If it is omitted, the default value is 8.

<segment attr clause>

It specifies the information for the index storage space.

- INITIAL integer
 - Definition

- It specifies the size of physical storage space which is initially allocated when creating the index.
 - This size is aligned to the EXTENT size of the TABLESPACE to which the table belongs. (e.g. If the EXT size is 8192 bytes, 'INITIAL 100' is actually operated as 8192 bytes.)
 - The size (aligned to the EXTENT size of TABLESPACE) should be equal to or bigger than MIN EXTENTS, or it should be equal to or less than MAXEXTENTS.
 - The minimum value is 1, and the maximum value depends on the system environment.
 - If it is omitted, the default value is one EXTENT size of TABLESPACE to which the table belongs.
- NEXT integer
 - Definition
 - It specifies the physical space size to be allocated when adding the space to the table.
 - This size is aligned to the EXTENT size of the TABLESPACE to which the table belongs. (e.g. If the EXT size is 8192 bytes, 'NEXT 100' is actually operated as 8192 bytes.)
 - NEXT operates as follows, depending on the remaining space size of the index available currently. (Obtained by subtracting the amount of currently used space from the MAXEXTENTS size)
 - If the remaining space size is 0, then it can not extend the space.
 - If the remaining space size is bigger than 0, but smaller than NEXT, then it allocates the space as big as the remaining space.
 - If the remaining space size is bigger than NEXT, then it allocates the space as big as the NEXT.
 - The minimum value is 1 and the maximum value depends on the system environment.
 - If it is omitted, the default value is one EXTENT size of TABLESPACE to which the index belongs.
- MINSIZE integer
 - Definition
 - It is the minimum space size of the index.
 - The value should be equal to or smaller than MAXSIZE.
 - This size is aligned to the EXTENT size of the TABLESPACE to which the index belongs.
 - The minimum value is 1 and the maximum value depends on the system environment.
 - If it is smaller than the size of two EXTENT, it is specified to the size of two EXTENT.
 - If it is omitted, the default value is the size of two EXTENT.
- MAXSIZE integer
 - Definition
 - It is the maximum space size of the index.
 - The value should be equal to or bigger than MINSIZE.
 - This size is aligned to the EXTENT size of the TABLESPACE to which the index belongs.
 - The minimum value is 1 and the maximum value depends on the system environment.
 - If it is omitted, the default value is EXTENT size * 2147483647(The maximum positive integer of INT32).

<size clause>

It specifies the file size in byte. (If it is omitted, the default unit is bytes.)

- K: Kilobytes
- M: Megabytes
- G: Gigabytes
- T: Terabytes

Description

A global secondary index is required to enquire a non-deterministic query.

Examples

It alters the maximum available size to be used by a global secondary index in the table T1 to 100 MBytes.

```
gSQL> ALTER TABLE T1 ALTER GLOBAL SECONDARY INDEX STORAGE( MAXSIZE 100M );  
Table altered.  
gSQL> COMMIT;  
Commit complete.
```

It alters the INITRANS value and the MAXTRANS value to 2 and 4 each which are to be used by a global secondary index in the table T1

```
gSQL> ALTER TABLE T1 ALTER GLOBAL SECONDARY INDEX INITRANS 2 MAXTRANS 4;  
Table altered.  
gSQL> COMMIT;  
Commit complete.
```

Compatibility

The SQL standard does not define the concepts of the global secondary index.

For More Information

Refer to the followings.

- ALTER TABLE name ADD GLOBAL SECONDARY INDEX
- ALTER TABLE name DROP GLOBAL SECONDARY INDEX

16.52 ALTER TABLE name MOVE SHARD

Function

It rebalances a specific shard of a table, or the entire shard in a specific cluster group to a specific cluster group.

Syntax

```
<alter table move shard statement> ::=  
    ALTER TABLE table_name MOVE SHARD  
        { shard_name_list | FROM CLUSTER GROUP src_cluster_group }  
        TO CLUSTER GROUP dest_cluster_group [ ONLINE | OFFLINE ]  
    ;
```

Invocation and Access Rules

It can be performed in a cluster system.

One of the following privileges is required to perform <alter table move shard statement>.

- (ALTER or CONTROL TABLE) ON TABLE for that table
- (ALTER TABLE or CONTROL SCHEMA) ON SCHEMA for the schema to which the table belongs
- ALTER ANY TABLE ON DATABASE

Syntax Rules and Parameters

table_name

It is the table name.

It can define a schema to which the table belongs such as schema_name.table_name.

If schema_name is omitted, the default schema name of the user performing the statement is used.

The statement can be performed only when that table is a cluster group specific table.

shard_name_list

It is the shard name list to be rebalanced.

If the shard does not exist in that table, then the statement can not be performed.

src_cluster_group

It is the name of a specific cluster group to be rebalanced.

dest_cluster_group

It is the name of a target cluster group on which the shard of the table is to be rebalanced.

If the cluster group specified by the shard of that table already exists then the statement can not be performed.

[ONLINE | OFFLINE]

It determines whether to allow DML when rebalancing table shard.

- ONLINE
 - It allows INSERT, UPDATE, and DELETE.
- OFFLINE
 - It does not allow INSERT, UPDATE, DELETE.
- When it is omitted, the default value is ONLINE.

Description

It rebalances a specific shard of the table from a specific cluster group to another cluster group.

To drop a specific cluster group, rebalance the shard of the table then perform the **DROP CLUSTER GROUP** statement.

To move shards of all tables from a specific cluster group to another cluster group, then perform the **ALTER DATABASE MOVE SHARD FROM CLUSTER GROUP TO CLUSTER GROUP** statement.

Examples

The following is an example of executing the `<alter table move shard statement>` statement.

```
gSQL> ALTER TABLE t1 MOVE SHARD shard1, shard2 TO CLUSTER GROUP g3;
```

```
Table altered.
```

```
gSQL> ALTER TABLE t1 MOVE SHARD FROM CLUSTER GROUP g1 TO CLUSTER GROUP g3;
```

```
Table altered.
```

Compatibility

The SQL standard does not define the concepts of the cluster.

For More Information

Refer to `ALTER DATABASE MOVE SHARD`.

16.53 ALTER TABLE name REBALANCE

Function

It rebalances the shard in a table.

Syntax

```
<alter table rebalance statement> ::=  
    ALTER TABLE table_name REBALANCE [ ONLINE | OFFLINE ]  
    ;
```

Invocation and Access Rules

It can be performed in a cluster system.

One of the following privileges is required to perform <alter table rebalance statement>.

- (ALTER or CONTROL TABLE) ON TABLE for that table
- (ALTER TABLE or CONTROL SCHEMA) ON SCHEMA for the schema to which the table belongs
- ALTER ANY TABLE ON DATABASE

Syntax Rules and Parameters

table_name

It is the table name.

It can define the schema to which the table belongs, such as schema_name.table_name. If schema_name is omitted, the default schema name of the user performing the statement is used.

[ONLINE | OFFLINE]

It determines whether to allow DML when rebalancing table shard.

- ONLINE
 - It allows INSERT, UPDATE, and DELETE.
- OFFLINE
 - It does not allow INSERT, UPDATE, DELETE.
- When it is omitted, the default value is ONLINE.

Description

It does not rebalance shards in a table when adding a cluster member or a cluster group by using the following statements.

- **CREATE CLUSTER GROUP**
- **ALTER CLUSTER GROUP name ADD MEMBER**

To rebalance the shards of a table in the added cluster group and the cluster member, perform the `<alter table rebalance statement>` statement. The operation succeeds without a separate rebalancing if the shard of the table is already rebalanced.

To rebalance shards in all tables, perform the **ALTER DATABASE REBALANCE** statement.

Examples

The following is an example of executing the `<alter table rebalance statement>` statement.

```
gSQL> ALTER TABLE t1 REBALANCE;  
Table altered.
```

Compatibility

The SQL standard does not define the concepts of the cluster.

16.54 ALTER TABLE name REBALANCE EXCLUDE CLUSTER GROUP cluster_group_list

Function

It rebalances the shard of the table not to include a shard in a specific cluster group.

Syntax

```
<alter table rebalance exclude cluster group statement> ::=  
    ALTER TABLE table_name REBALANCE  
        EXCLUDE CLUSTER GROUP cluster_group_list [ ONLINE | OFFLINE ]  
    ;
```

Invocation and Access Rules

It can be performed in a cluster system.

One of the following privileges is required to perform <alter table rebalance exclude cluster group statement>.

- (ALTER or CONTROL TABLE) ON TABLE for that table
- (ALTER TABLE or CONTROL SCHEMA) ON SCHEMA for the schema to which the table belongs
- ALTER ANY TABLE ON DATABASE

Syntax Rules and Parameters

table_name

It is the table name.

It can define a schema to which the table belongs such as schema_name.table_name.

If schema_name is omitted, the default schema name of the user performing the statement is used.

The statement can be performed only when that table is a cluster-wide table.

cluster_group_list

It is a list of the cluster group which does not include a shard of a table.

If the cluster group to be excluded from the rebalancing is the entire group, the statement can not be performed.

[ONLINE | OFFLINE]

It determines whether to allow DML when rebalancing table shard.

- ONLINE
 - It allows INSERT, UPDATE, and DELETE.
- OFFLINE
 - It does not allow INSERT, UPDATE, DELETE.
- When it is omitted, the default value is ONLINE.

Description

It excludes a specific cluster group and rebalances the shard of the table.

If the shard of the table does not exist in that cluster group, the operation succeeds without a separate rebalancing.

It rebalances the shard based on the cluster group in which the shard of the table is located.

To drop a specific cluster group, rebalance the shard of the table and perform **DROP CLUSTER GROUP** statement.

To rebalance the shard excluding a cluster group from all tables, perform the **ALTER DATABASE REBALANCE EXCLUDE CLUSTER GROUP** statement.

Examples

The following is an example of executing the <alter table rebalance exclude cluster group statement> statement.

```
gSQL> ALTER TABLE t1 REBALANCE EXCLUDE CLUSTER GROUP g3;  
Table altered.
```

Compatibility

The SQL standard does not define the concepts of the cluster.

16.55 ALTER TABLE name SPLIT SHARD

Function

It rebalances a specific shard of a table by splitting it in a cluster environment.

Syntax

```

<alter table split shard statement> ::=
    ALTER TABLE table_name SPLIT SHARD source_shard_name
        INTO ( <split shard placement> [, ...] )
    ;
<split shard placement> ::=
    <split shard bound def> AT CLUSTER GROUP dest_group_name
<split shard bound def> ::=
    <split list shard def>
    | <split range shard def>
<split list shard def> :=
    SHARD dest_shard_name VALUES IN ( <split list value clause> )
<split list value clause> :=
    <split list value> [, ...]
<split list value> :=
    constant
    | NULL
<split range shard def> :=
    SHARD dest_shard_name VALUES LESS THAN ( <split range value clause> )
<split range value clause> :=
    <split range value> [, ...]
<split range value> :=
    constant
  
```

Invocation and Access Rules

It can be performed in a cluster system.

One of the following privileges is required to perform <alter table split shard statement>.

- (ALTER or CONTROL TABLE) ON TABLE for that table
- (ALTER TABLE or CONTROL SCHEMA) ON SCHEMA for the schema to which the table belongs
- ALTER ANY TABLE ON DATABASE

Syntax Rules and Parameters

table_name

It is the table name.

It can define a schema to which the table belongs such as schema_name.table_name.

If schema_name is omitted, the default schema name of the user performing the statement is used.

The statement can be performed only when that table is a cluster group specific table, and when the shard is a list shard or a range shard.

source_shard_name

It is the name of an original shard to be splitted.

If the shard does not exist in that table, the statement can not be performed.

<split shard placement>

It defines the target shard to which the original shard is rebalanced by splitting.

<split shard bound def>

It defines the bound of a target shard to be splitted.

It can be defined as one of two following bound defs.

- <split list shard def>
- <split range shard def>

<split list shard def>

It defines a split shard bound for a list shard.

- dest_shard_name
 - It is the name of a target shard.

- `<split list value clause>`
 - `<split list value>` should be an integer.
 - `<split list value>` can not be NULL.
 - `<split list value>` can not be DEFAULT.
 - `S1 : (1, 11, 21, 31, NULL) SPLIT SHARD S1 INTO (<split list value clause> ..)`
 - (O) SHARD S11 VALUES IN (1)
 - (O) SHARD S11 VALUES IN (1, NULL)
 - (O) SHARD S11 VALUES IN (1, 11, 21, 31)
 - (X) SHARD S11 VALUES IN (2)
 - (X) SHARD S11 VALUES IN (DEFAULT)
 - (X) SHARD S11 VALUES IN (1, 11, 21, 31, NULL)

`<split range shard def>`

It defines a split shard bound for a range shard.

- `<split range value clause>`
 - `<split list value>` should be an integer.
 - `<split list value>` can not be NULL.
 - `<split list value>` can not be MAXVALUE.
 - `S1 : (100, 100), S2 : (50, 50) SPLIT SHARD S1 INTO (<split range value clause> ..)`
 - (O) SHARD S11 VALUES IN (50, 100)
 - (O) SHARD S11 VALUES IN (100, 50)
 - (O) SHARD S11 VALUES IN (60, 60)
 - (X) SHARD S11 VALUES IN (50, NULL)
 - (X) SHARD S11 VALUES IN (50, 50)
 - (X) SHARD S11 VALUES IN (100, 100)
 - (X) SHARD S11 VALUES IN (100, 110)
 - (X) SHARD S11 VALUES IN (MAXVALUE, 100)

`dest_group_name`

It is the name of a cluster group in which the splitted shard is to be rebalanced.

Description

It splits a specific shard of a specific table and rebalances it to a random cluster group.

This is used to distribute records and loads by splitting the shards when records corresponding to a specific shard is too much or when a specific group member is overloaded.

Examples

The following is an example of executing the <alter table split shard statement> statement.

```
gSQL> ALTER TABLE t1 SPLIT SHARD shard1 INTO ( SHARD shard11 VALUES IN ( 11 ) AT CLUSTER GROUP G2 );
```

Table altered.

```
gSQL> ALTER TABLE t1 SPLIT SHARD shard1 INTO ( SHARD shard11 VALUES LESS THAN ( 11 ) AT CLUSTER GROUP G2 );
```

Table altered.

Compatibility

The SQL standard does not define the concepts of the cluster.

For More Information

Refer to the followings.

- ALTER TABLE name REBALANCE
- ALTER TABLE name REBALANCE EXCLUDE CLUSTER GROUP cluster_group_list
- ALTER TABLE name MOVE SHARD

16.56 ALTER TABLE name RENAME SHARD

Function

It renames a specific shard of a table in cluster environment.

Syntax

```
<alter table rename shard statement> ::=  
    ALTER TABLE table_name  
        RENAME SHARD shard_name TO new_shard_name  
    ;
```

Invocation and Access Rules

It can be performed in a cluster system.

One of the following privileges is required to perform <alter table rename shard statement>.

- (ALTER or CONTROL TABLE) ON TABLE for that table
- (ALTER TABLE or CONTROL SCHEMA) ON SCHEMA for the schema to which the table belongs
- ALTER ANY TABLE ON DATABASE

Syntax Rules and Parameters

table_name

It is the table name to be altered.

It can define a schema to which the table belongs such as schema_name.table_name.

If schema_name is omitted, the default schema name of the user performing the statement is used.

shard_name

It is the existing name of a shard to be altered.

If the shard does not exist in that table, then the statement can not be performed.

new_shard_name

It is the new name of a shard to be altered.

The same shard name should not exist in the table.

Description

It alters the name of a specific shard of a hash, a range, or a list table. This statement can not be performed for a cloned table.

Examples

The following is an example of executing <alter table rename shard statement> statement.

```
gSQL> ALTER TABLE t_range RENAME SHARD r_01 TO r_new_01;
Table altered.
gSQL> ALTER TABLE t_list RENAME SHARD l_01 TO l_new_01;
Table altered.
gSQL> ALTER TABLE t_hash RENAME SHARD shard_000000 TO h_new_00;
Table altered.
gSQL> COMMIT;
Commit complete.
```

Compatibility

The SQL standard does not define the concepts of the cluster.

For More Information

Refer to the followings.

- ALTER TABLE
- ALTER TABLE name MOVE SHARD
- ALTER TABLE name SPLIT SHARD
- ALTER TABLE name REBALANCE

16.57 ALTER TABLE name READ { ONLY | WRITE }

Function

It sets READ { ONLY | WRITE } in a table.

Syntax

```
<alter table read { only | write } statement> ::=  
    ALTER TABLE table_name  
        READ { ONLY | WRITE }  
    ;
```

Invocation and Access Rules

One of the following privileges is required to perform <alter table read { only | write } statement>.

- (ALTER or CONTROL TABLE) ON TABLE for that table
- (ALTER TABLE or CONTROL SCHEMA) ON SCHEMA for the schema to which the table belongs
- ALTER ANY TABLE ON DATABASE

Syntax Rules and Parameters

table_name

It is the table name.

It can define a schema to which the table belongs such as schema_name.table_name.

If schema_name is omitted, the default schema name of the user performing the statement is used.

Description

It sets table property to READ { ONLY | WRITE }.

If it is set to READ ONLY, neither SELECT .. FOR UPDATE statement, nor DML/ DDL statement which updates table data can be used. However, DDL statement which does not update the table data is allowed.



Disallowed SQL statements when it is set to READ ONLY

- INSERT, UPDATE, DELETE
- TRUNCATE
- SELECT .. FOR UPDATE
- ALTER TABLE RENAME/DROP COLUMN
- ALTER TABLE SET COLUMN UNUSED

Allowed SQL statements when it is set to READ ONLY

- SELECT
- CREATE/ALTER/DROP INDEX
- ALTER TABLE ADD/ALTER COLUMN
- ALTER TABLE ADD/ALTER/RENAME/DROP CONSTRAINT
- ALTER TABLE for physical property changes
- ALTER TABLE DROP UNUSED COLUMNS
- ALTER TABLE RENAME TO
- DROP TABLE
- ALTER TABLE ADD/DROP SUPPLEMENTAL LOG
- LOCK TABLE

Examples

The following is an example of executing <alter table read { only | write } statement>.

```
gSQL> ALTER TABLE t1 READ ONLY;
Table altered.
gSQL> ALTER TABLE t1 READ WRITE;
Table altered.
```

Compatibility

The SQL standard does not define <alter table read { only | write } statement>.

For More Information

Refer to ALTER TABLE.

16.58 ALTER TABLE name RENAME TO

Function

It renames the table.

Syntax

```
<rename table statement> ::=  
    ALTER TABLE table_name  
        RENAME TO new_table_name  
    ;
```

Invocation and Access Rules

One of the following privileges is required to perform <rename table statement>.

- (ALTER or CONTROL TABLE) ON TABLE for that table
- (ALTER TABLE or CONTROL SCHEMA) ON SCHEMA for the schema to which the table belongs
- ALTER ANY TABLE ON DATABASE

Syntax Rules and Parameters

table_name

It is the existing name of the table.

It can define the schema to which the table belongs, such as schema_name.table_name. If schema_name is omitted, the default schema name of the user performing the statement is used.

new_table_name

It is a new name of the table.

The same table name should not exist in the schema.

Description

Even when the table is renamed, the object referring to the table such as index, constraint does not need to be renamed.

Example

The following is an example of exchanging the name of the two tables t1, t2.

```
gSQL> ALTER TABLE t1 RENAME TO t_temp;
Table altered.
gSQL> ALTER TABLE t2 RENAME TO t1;
Table altered.
gSQL> ALTER TABLE t_temp RENAME TO t2;
Table altered.
gSQL> COMMIT;
Commit complete.
```

Compatibility

The SQL standard does not define <rename table statement>.

For More Information

Refer to **ALTER TABLE**.

16.59 ALTER TABLE name STORAGE

Function

It alters physical attributes of a table.

Syntax

```

<alter table physical attribute statement> ::=
    ALTER TABLE table_name
        [ <physical attribute clause> ]
        | [ STORAGE ( <segment attr clause> [...] ) ]
        ;
<physical attribute clause> ::=
    PCTFREE integer
    | PCTUSED integer
    | INITRANS integer
    | MAXTRANS integer
<segment attr clause> ::=
    NEXT <size_clause>
    | MINSIZE <size_clause>
    | MAXSIZE <size_clause>
<size clause> ::=
    integer [ K | M | G | T ]
  
```

Invocation and Access Rules

One of the following privileges is required to perform <alter table physical attribute statement>.

- (ALTER or CONTROL TABLE) ON TABLE for that table
- (ALTER TABLE or CONTROL SCHEMA) ON SCHEMA for the schema to which the table belongs
- ALTER ANY TABLE ON DATABASE

Syntax Rules and Parameters

table_name

It is the table name to be altered.

It can define the schema to which the table belongs, such as schema_name.table_name. If schema_name is omitted, the default schema name of the user performing the statement is used.

⟨physical attribute clause⟩

It alters the physical attribute of a page which configures the table.

It is not applied to the already allocated page, but is applied to the newly allocated page.

For more information, refer to ⟨table physical attribute clause⟩ of CREATE TABLE.

⟨segment attr clause⟩

It alters the physical attribute of the extent configuring the segment. It is not applied to the already allocated extent but is applied to the newly allocated extent.

- MAXSIZE integer
 - It alters the space size of the segment which can be allocated.
 - If the newly allocated space is smaller than the already allocated space, the MAXSIZE is altered to the currently allocated space size.

Description

For more information, refer to the rules for each syntax.

Example

The following is an example of changing the physical attribute of the table.

```
gSQL> ALTER TABLE t1 PCTFREE 10 PCTUSED 40 STORAGE ( NEXT 10M MAXSIZE 100M );  
Table altered.
```

Compatibility

The SQL standard does not define the physical attribute of a table.

For More Information

Refer to **ALTER TABLE**.

16.60 ALTER TABLE name ADD SUPPLEMENTAL LOG

Function

If the primary key exists in the table when table data is altered, it sets to add the primary key value to redo log.

Syntax

```
<add table supplemental log statement> ::=  
    ALTER TABLE table_name  
        ADD SUPPLEMENTAL LOG DATA ( PRIMARY KEY ) COLUMNS  
    ;
```

Invocation and Access Rules

One of the following privileges is required to perform <add table supplemental log statement>.

- (ALTER or CONTROL TABLE) ON TABLE for that table
- (ALTER TABLE or CONTROL SCHEMA) ON SCHEMA for the schema to which the table belongs
- ALTER ANY TABLE ON DATABASE

Syntax Rules and Parameters

table_name

It is the table name to be altered.

It can define the schema to which the table belongs, such as schema_name.table_name. If schema_name is omitted, the default schema name of the user performing the statement is used.

Even when the primary key does not exist in the table, the statement can be executed.

Description

It additionally records SUPPLEMENTAL LOG when executing UPDATE/DELETE on the corresponding TABLE. The recorded SUPPLEMENTAL LOG is used to analyze logs or tools such as CDC.

To record SUPPLEMENTAL LOG of every TABLE, set the property as *SUPPLEMENTAL_LOG_DATA_PRIMARY_KEY = YES*.

Example

The following is an example of setting to additionally add a primary key value to the redo log when changing the data in the table.

```
gSQL> ALTER TABLE t1 ADD SUPPLEMENTAL LOG DATA ( PRIMARY KEY ) COLUMNS;  
Table altered.
```

Compatibility

The SQL standard does not cover <add table supplemental log statement>.

For More Information

Refer to **ALTER TABLE name DROP SUPPLEMENTAL LOG**.

16.61 ALTER TABLE name DROP SUPPLEMENTAL LOG

Function

It sets not to leave the primary key information on the redo log when changing the data in the table.

Syntax

```
<add table supplemental log statement> ::=  
ALTER TABLE table_name  
    DROP SUPPLEMENTAL LOG DATA ( PRIMARY KEY ) COLUMNS  
;
```

Invocation and Access Rules

One of the following privileges is required to perform <drop table supplemental log statement>.

- (ALTER or CONTROL TABLE) ON TABLE for that table
- (ALTER TABLE or CONTROL SCHEMA) ON SCHEMA for the schema to which the table belongs
- ALTER ANY TABLE ON DATABASE

Syntax Rules and Parameters

table_name

It is the table name to be altered.

It can define the schema to which the table belongs, such as schema_name.table_name. If schema_name is omitted, the default schema name of the user performing the statement is used.

It should have been set by using **ALTER TABLE name ADD SUPPLEMENTAL LOG** statement.

Description

For more information, refer to the rules for each syntax.

Example

The following is an example of setting not to leave the primary key information on the redo log when changing the data in the table.

```
gSQL> ALTER TABLE t1 DROP SUPPLEMENTAL LOG DATA ( PRIMARY KEY ) COLUMNS;  
Table altered.
```

Compatibility

The SQL standard does not cover <drop table supplemental log statement>.

16.62 ALTER TABLESPACE

Function

It alters the tablespace definition.

Syntax

```
<alter tablespace statement> ::=  
    <rename tablespace statement>  
  | <backup tablespace statement>  
  | <on/offline tablespace statement>  
  | <add file statement>  
  | <drop file statement>  
  | <rename datafile statement>  
  ;
```

Invocation and Access Rules

ALTER TABLESPACE privilege is required to perform <alter tablespace statement>.

Syntax Rules and Parameters

<rename tablespace statement>

It renames the tablespace.

For more information, refer to **ALTER TABLESPACE name RENAME TO** statement.

<backup tablespace statement>

It backs up the tablespace.

For more information, refer to **ALTER TABLESPACE name BACKUP** statement.

⟨on-offline tablespace statement⟩

It changes all files in the tablespace to the online state or offline state.

For more information, refer to **ALTER TABLESPACE name [ONLINE|OFFLINE]** statement.

⟨add file statement⟩

It adds a file to the tablespace.

For more information, refer to **ALTER TABLESPACE name ADD [DATAFILE|MEMORY]** statement.

⟨drop file statement⟩

It drops a file from the tablespace.

For more information, refer to **ALTER TABLESPACE name DROP [DATAFILE|MEMORY]** statement.

⟨rename datafile statement⟩

It renames the datafile in the data tablespace.

For more information, refer to **ALTER TABLESPACE name RENAME DATAFILE** statement.

Description

Unlike other Data Definition Language (DDL), **ALTER TABLESPACE** statement is not allowed to **ROLLBACK**, and its transaction is automatically committed after executing the statement.

Example

Refer to the examples of each detailed statement.

Compatibility

The SQL standard does not define the concepts of the tablespace.

For More Information

Refer to the followings.

- [CREATE TABLESPACE](#)
- [DROP TABLESPACE](#)

16.63 ALTER TABLESPACE name RENAME TO

Function

It renames the tablespace.

Syntax

```
<rename tablespace statement> ::=  
    ALTER TABLESPACE tablespace_name RENAME TO <new_tablespace_name>  
    ;
```

Invocation and Access Rules

ALTER TABLESPACE ON DATABASE privilege required to perform <rename space statement>.

Syntax Rules and Parameters

tablespace_name

It is a name of the old tablespace.

- The built-in tablespace can not be renamed.
- The OFFLINE tablespace can not be renamed.

new_tablespace_name

It is a name of the new tablespace.

Description

Even when the tablespace is renamed, the table or index which was already created in the existing tablespace does not need to be renamed.

Example

The following is an example of renaming the tablespace.

```
gSQL> ALTER TABLESPACE space1 RENAME TO space2;  
Tablespace altered.
```

Compatibility

The SQL standard does not define the concepts of the tablespace.

For More Information

Refer to **ALTER TABLESPACE**.

16.64 ALTER TABLESPACE name BACKUP

Function

It switches the tablespace to backup enabled state and backup disabled state to perform backup.

Syntax

```

<backup tablespace statement> ::=
    <tablespace begin backup statement>
  | <tablespace end backup statement>
  | <tablespace incremental backup statement>
  ;

<tablespace begin backup statement> ::=
    ALTER TABLESPACE tablespace_name BEGIN BACKUP [AT <domain_name>]
  ;

<tablespace end backup statement> ::=
    ALTER TABLESPACE tablespace_name END BACKUP [AT <domain_name>]
  ;

<tablespace incremental backup statement> ::=
    ALTER TABLESPACE tablespace_name
      BACKUP INCREMENTAL <incremental backup option> [AT <domain_name>]  ;

<incremental backup option> ::=
    LEVEL integer [ CUMULATIVE | DIFFERENTIAL ]

```

Invocation and Access Rules

ALTER TABLESPACE ON DATABASE privilege is required to perform <backup space statement>.

Syntax Rules and Parameters

⟨tablespace begin backup statement⟩

It sets the tablespace to the backup enabled state.

- The tablespace being used is set to the backup enabled state.
- The backup state of the tablespace such as OFFLINE/ temporary can not be switched.

tablespace_name

It is the tablespace name whose backup state is to be switched.

⟨tablespace end backup statement⟩

It sets the tablespace to the backup disabled state.

⟨tablespace incremental backup statement⟩

It performs the incremental backup of the tablespace.

The database is in OPEN phase and it should be operated in ARCHIVELOG mode.

⟨incremental backup option⟩

- An 'Integer' can be specified from 0 to 4.
- 'LEVEL 0' can not specify CUMULATIVE or DIFFERENTIAL.
- CUMULATIVE | DIFFERENTIAL
 - CUMULATIVE
 - If 'integer' is n, it backs up all pages which are altered after the most recent backups of LEVEL 0 ~ LEVEL n-1.
 - DIFFERENTIAL
 - If 'integer' is n, it backs up all pages which are altered after the most recent backups of LEVEL 0 ~ LEVEL n.
 - If it is omitted, DIFFERENTIAL is specified by default.

⟨domain name⟩

It is a name of a member or a group for which the statement is performed.

If it is omitted, it is performed for all groups.

Description

It backs up the datafiles which are created in the tablespace. A full backup of the tablespace begins with `BEGIN BACKUP`, and copies the datafiles by OS file copy and ends with `END BACKUP`. The incremental backup file is created in the path set by `BACKUP_DIR` 1 property using a single statement.

Examples

The following is an example of setting the full backup state to 'ACTIVE' for the tablespace `DICTIONARY_TBS`.

```
ALTER TABLESPACE DICTIONARY_TBS BEGIN BACKUP;
```

The following is an example of setting the full backup state to 'INACTIVE' for the tablespace `DICTIONARY_TBS`.

```
ALTER TABLESPACE DICTIONARY_TBS END BACKUP;
```

The following is an example of generating the LEVEL 0 incremental backup of the tablespace `DICTIONARY_TBS`.

```
ALTER TABLESPACE DICTIONARY_TBS BACKUP INCREMENTAL LEVEL 0;
```

Compatibility

The SQL standard does not define the concepts of the tablespace.

For More Information

Refer to the followings.

- `ALTER TABLESPACE`
- `ALTER TABLESPACE name [ONLINE|OFFLINE]`

16.65 ALTER TABLESPACE name [ONLINE|OFFLINE]

Function

It alters the tablespace status.

Syntax

```
<on/off tablespace statement> ::=  
    ALTER TABLESPACE tablespace_name { ONLINE | OFFLINE [ NORMAL | IMMEDIATE ] }  
    [ AT <domain name> ]  
    ;
```

Invocation and Access Rules

ALTER TABLESPACE ON DATABASE privilege is required to perform <on/off tablespace statement>.

Syntax Rules and Parameters

ONLINE

It alters the tablespace status in OFFLINE state to ONLINE state.

OFFLINE NORMAL

It alters the tablespace status in ONLINE state to OFFLINE state.

The media recovery is not required in ONLINE state because the tablespace which was altered to OFFLINE state is in consistent state.



OFFLINE NORMAL is not allowed in MOUNT phase.
(However, if the previous instance is terminated by \SHUTDOWN NORMAL, OFFLINE NORMAL is allowed.)

OFFLINE IMMEDIATE

It alters the tablespace status in ONLINE state to OFFLINE state.

The media recovery is required in ONLINE state because the tablespace which was altered to OFFLINE state is in inconsistent state.



The SYSTEM tablespace can not be altered to OFFLINE state.
OFFLINE IMMEDIATE requires the media recovery, so it can be performed only in ARCHIVELOG mode.

<domain name>

It is a name of a member or a group for which the statement is performed.

If it is omitted, it is performed for all groups.

Description

For more information, refer to the rules for each syntax.

Examples

The following is an example of setting the tablespace to OFFLINE.

```
gSQL> ALTER TABLESPACE space1 OFFLINE;
Tablespace altered.
```

The following is an example of that OFFLINE NORMAL for the tablespace fails in MOUNT phase.

```
gSQL> ALTER TABLESPACE space1 OFFLINE;
ERR-42000(16290): OFFLINE NORMAL is only allowed if the database is in OPEN phase :
```

```
ALTER TABLESPACE space1 OFFLINE
```

```
*
```

```
ERROR at line 1:
```

```
gSQL> ALTER TABLESPACE space1 OFFLINE NORMAL;
```

```
ERR-42000(16290): OFFLINE NORMAL is only allowed if the database is in OPEN phase :
```

```
ALTER TABLESPACE space1 OFFLINE NORMAL
```

```
*
```

```
ERROR at line 1:
```

Compatibility

The SQL standard does not define the concepts of the tablespace.

For More Information

Refer to the followings.

- ALTER TABLESPACE
- ALTER TABLESPACE name BACKUP

16.66 ALTER TABLESPACE name ADD [DATAFILE] MEMORY]

Function

It extends the space of the tablespace.

Syntax

```

<add space statement> ::=
    ALTER TABLESPACE tablespace_name ADD <space specification>
        [AT <domain name>]
    ;
<space specification> ::=
    MEMORY <memory clause> [, ...]
    | DATAFILE <add datafile clause> [, ...]
<size clause> ::=
    integer [ K | M | G | T ]
<memory clause>
    'memory_name' { SIZE <size clause> }
<add datafile clause> ::=
    'filename'
        { SIZE <size clause> | REUSE | SIZE <size clause> REUSE }

```

Invocation and Access Rules

ALTER TABLESPACE ON DATABASE privilege is required to perform <add space statement>.

Syntax Rules and Parameters

tablespace_name

It is the tablespace name to be altered.

<file specification>

The following syntax should be used according to the tablespace type.

- Memory data tablespace
 - DATAFILE <add datafile clause>
- Memory temporary tablespace
 - MEMORY <memory clause>

<add datafile clause>

It defines the memory datafile to be added.

- 'filename'
 - It is the file name to store and manage the data.
 - It is the space to store the checkpoint image for the memory data.
 - The filename can be either the new file or existing file.
 - The length of filename should be shorter than 1024 bytes.
- SIZE <size clause>
 - For the new file, the initial size is specified by using SIZE clause.
 - An error occurs if the file exists.
 - The file size can be specified from 1M to 30G.
- REUSE
 - If the file exists, it uses REUSE clause.
 - If the file does not exist, a new file is created.
 - The size of newly created file
 - For the data tablespace, it is determined by MEMORY_DATA_TABLESPACE_SIZE property.
 - For the temporary table space, it is determined by MEMORY_TEMP_TABLESPACE_SIZE property.
- SIZE <size clause> REUSE
 - If both of SIZE clause and REUSE clause are specified, it is operated as follows based on the presence of the filename.
 - For the new filename, the initial file size is specified by using SIZE clause.
 - For the existing filename, it is adjusted to the SIZE clause value by using the existing file.

⟨memory clause⟩

- ⟨size clause⟩
 - It defines the memory to be added.

For more information, refer to ⟨memory clause⟩ of CREATE MEMORY TEMPORARY TABLESPACE statement.

⟨domain name⟩

It is a name of a member or a group for which the statement is performed.
If it is omitted, it is performed for all groups.

Description

For more information, refer to the rules for each syntax.

Example

The following is an example of adding datafile to the tablespace.

```
gSQL> ALTER TABLESPACE space1 ADD DATAFILE 'test_file_a2.dbf' SIZE 10M REUSE;  
Tablespace altered.
```

Compatibility

The SQL standard does not define the concepts of the tablespace.

For More Information

Refer to the followings.

- CREATE MEMORY DATA TABLESPACE
- CREATE MEMORY TEMPORARY TABLESPACE
- ALTER TABLESPACE

16.67 ALTER TABLESPACE name DROP [DATAFILE|MEMORY]

Function

It reduces the space of the tablespace.

Syntax

```
<drop space statement> ::=  
    ALTER TABLESPACE tablespace_name DROP <file specification>  
    [ AT <domain name> ]  
    ;  
<file specification> ::=  
    DATAFILE 'filename'  
    | MEMORY 'memory_name'
```

Invocation and Access Rules

ALTER TABLESPACE ON DATABASE privilege is required to perform <drop space statement>.

Syntax Rules and Parameters

tablespace_name

It is the tablespace name to be altered.

<file specification>

The following syntax should be used according to the tablespace type.

- Memory data tablespace
 - DATAFILE 'filename'

- Memory temporary tablespace
 - MEMORY 'memory_name'



The file of OFFLINE tablespace can not be dropped.
The first file of the tablespace can not be dropped.
The data file which has been used once can not be dropped.

<domain name>

It is a name of a member or a group for which the statement is performed.
If it is omitted, it is performed for all groups.

Description

For more information, refer to the rules for each syntax.

Example

The following is an example of dropping the file from the tablespace.

```
gSQL> ALTER TABLESPACE space1 DROP DATAFILE 'test_file_f2.dbf';  
Tablespace altered.
```

Compatibility

The SQL standard does not define the concepts of the tablespace.

For More Information

Refer to the followings.

- ALTER TABLESPACE
- ALTER TABLESPACE name ADD [DATAFILE|MEMORY]
- ALTER TABLESPACE name RENAME DATAFILE

16.68 ALTER TABLESPACE name RENAME DATAFILE

Function

It renames the datafiles which configures the tablespace.

Syntax

```
<rename datafile statement> ::=  
    ALTER TABLESPACE tablespace_name RENAME DATAFILE <filename_list> TO <filename_list>  
    ;  
    <filename_list> ::=  
        'filename' [, ...]
```

Invocation and Access Rules

ALTER TABLESPACE ON DATABASE privilege is required to perform <rename datafile statement>.



ONLINE tablespace file can not be altered when it is in TDS mode and the database is in OPEN phase. (Except for the temporary memory tablespace.)
The file should exist even after the alteration.

Syntax Rules and Parameters

tablespace_name

It is the tablespace name to be altered.

'filename'

The memory temporary tablespace is 'memory_name' and the other kinds of tablespace is 'filename'.

<domain name>

It is a name of a member or a group for which the statement is performed.

If it is omitted, it is performed for all groups.

Description

The tablespace status determines whether the operation can be performed.

- OFFLINE: It can be performed in MOUNT or OPEN phase.
- ONLINE: It can be performed only in MOUNT phase.

Example

The following is an example of renaming 'test.dbf' to 'test1.dbf'.

```
gSQL> ALTER TABLESPACE TEST_TBS RENAME DATAFILE 'test.dbf' TO 'test1.dbf';  
Tablespace altered.
```

Compatibility

The SQL standard does not define the concepts of the tablespace.

For More Information

Refer to the followings.

- ALTER TABLESPACE
- ALTER TABLESPACE name ADD [DATAFILE|MEMORY]
- ALTER TABLESPACE name DROP [DATAFILE|MEMORY]

16.69 ALTER USER

Function

It alters the user definition of the database.

Syntax

```

<alter user statement> ::=
    ALTER USER user_identifier <alter user action>
    | ALTER USER PUBLIC <alter schema path>
    ;

<alter user action> ::=
    <alter password>
    | <alter profile>
    | <password expire>
    | <account lock>
    | <alter default tablespace>
    | <alter temporary tablespace>
    | <alter schema path>

<alter password> ::=
    IDENTIFIED BY new_password [ REPLACE old_password ]

<alter profile> ::=
    PROFILE { profile_name | DEFAULT | NULL }

<password expire> ::=
    PASSWORD EXPIRE

<account lock> ::=
    ACCOUNT { LOCK | UNLOCK }

<alter default tablespace> ::=
    DEFAULT TABLESPACE tablespace_name

<alter temporary tablespace> ::=
    TEMPORARY TABLESPACE tablespace_name

<alter schema path> ::=
    SCHEMA PATH ( { schema_name | CURRENT PATH } [, ...] )

```

Invocation and Access Rules

ALTER USER ON DATABASE privilege is required to perform <alter user statement>.

However, <alter password> can be performed without any privilege, when the user and the user identifier are identical.

Syntax Rules and Parameters

user_identifier

It is the username to be altered.

<alter password>

It alters the user's password.

- IDENTIFIED BY new_password
 - The new password is encrypted and stored.
 - The length of the password should be shorter than 128 byte.
 - The password is case sensitive.
- REPLACE old_password
 - It can be omitted when ALTER USER ON DATABASE privilege is given.
 - It can not be omitted when ALTER USER ON DATABASE privilege is not given.
 - The user and the user identifier should be identical.

<alter profile>

It alters the profile for the password management policy.

- PROFILE profile_name
 - It allocates profile_name which is created by a user.
- PROFILE DEFAULT
 - It allocates "DEFAULT" which is the default profile.
- PROFILE NULL
 - It does not allocate the profile.

⟨password expire⟩

It expires the user's password.

⟨account lock⟩

- ACCOUNT LOCK
 - It locks the user account.
- ACCOUNT UNLOCK
 - It unlocks the user account.

⟨alter default tablespace⟩

It alters the user's default tablespace.

The tablespace_name should be a data tablespace.

⟨alter temporary tablespace⟩

It alters the user's temporary tablespace.

The tablespace_name should be a temporary tablespace.

⟨alter index tablespace⟩

It alters an index tablespace of the user.

- It specifies INDEX TABLESPACE tablespace_name.
 - If the data tablespace is specified, then it should be a LOGGING index.
 - If the temporary tablespace is specified, then it should be a NOLOGGING index.
- INDEX TABLESPACE NULL
 - It does not specify an index tablespace.

⟨alter schema path⟩

It alters the user's schema access path.

If the schema is not specified in user's SQL statement, the schema access path is determined in the schema order for the naming resolution of the object.

If the schema name is as same as another schema which is previously listed, it is not applied.

The following is an example of objects existing in a schema when performing *ALTER USER u1 SCHEMA PATH (u1, s2, public);* statement.

Schema name	u1	s2	public
-	t1	-	t1
-	-	t2	-
-	-	-	t3

The object name whose schema name is not specified when the user u1 executes the schema is interpreted by the SCHEMA PATH as follows.

- CREATE statement
 - CREATE TABLE t1 (c1 INTEGER);
 - Error: CREATE TABLE u1.t1 (c1 INTEGER);
 - CREATE TABLE t2 (c1 INTEGER);
 - Execution: CREATE TABLE u1.t2 (c1 INTEGER);
- SELECT statement
 - SELECT * FROM t1;
 - Execution: SELECT * FROM u1.t1;
 - SELECT * FROM t2;
 - Execution: SELECT * FROM s2.t2;
 - SELECT * FROM t3;
 - Execution: SELECT * FROM public.t3;

CURRENT PATH

It is the current user's schema path.

A new schema path can be added using CURRENT PATH maintaining the existing schema path as follows.

- The u1's current schema path
 - (u1, public)
- The statement execution
 - ALTER USER u1 SCHEMA PATH (s1, CURRENT PATH, s2);
- The u1's schema path is altered as follows.
 - (s1, u1, public, s2)

ALTER USER PUBLIC <alter schema path>

It alters the schema path of PUBLIC account.

The schema path of PUBLIC account is included in every user's the schema path.

The initial schema path which is allocated to PUBLIC account is as follows.

- DICTIONARY_SCHEMA
- INFORMATION_SCHEMA
- DEFINITION_SCHEMA
- PERFORMANCE_VIEW_SCHEMA
- FIXED_TABLE_SCHEMA

Description

For more information, refer to the rules for each syntax.

Examples

The following is an example of altering the user's password.

```
gSQL> ALTER USER u1 IDENTIFIED BY new_password;  
User altered.
```

The following is an example of allocating the profile to the user.

```
gSQL> ALTER USER u1 PROFILE prof1;  
User altered.  
gSQL> COMMIT;  
Commit complete.
```

The following is an example of dropping the user's profile.

```
gSQL> ALTER USER u1 PROFILE NULL;  
User altered.  
gSQL> COMMIT;  
Commit complete.
```

The following is an example of expiring the user's password.

```
gSQL> ALTER USER u1 PASSWORD EXPIRE;  
User altered.  
gSQL> COMMIT;  
Commit complete.
```

The following is an example of unlocking the user's account.

```
gSQL> ALTER USER u1 ACCOUNT UNLOCK;  
User altered.  
gSQL> COMMIT;  
Commit complete.
```

The following is an example of altering the user's DEFAULT TABLESPACE.

```
gSQL> ALTER USER u1 DEFAULT TABLESPACE mem_data_tbs;  
User altered.
```

The following is an example of altering the user's TEMPORARY TABLESPACE.

```
gSQL> ALTER USER u1 TEMPORARY TABLESPACE mem_temp_tbs;  
User altered.
```

The following is an example of altering the user's INDEX TABLESPACE.

```
gSQL> ALTER USER u1 INDEX TABLESPACE mem_temp_tbs;  
User altered.
```

The following is an example of altering the user's schema path.

```
gSQL> ALTER USER u1 SCHEMA PATH ( s1, CURRENT PATH );  
User altered.
```

Compatibility

SQL standard covers the concepts of a user, but it does not define the SQL statements associated with creating, altering, dropping a user.

For More Information

Refer to the followings.

- [CREATE USER](#)
- [DROP USER](#)

16.70 ALTER VIEW

Function

It alters the view definition.

Syntax

```
<alter view statement> ::=  
    ALTER VIEW view_name <alter view action>  
    ;  
<alter view action> ::=  
    COMPILE
```

Invocation and Access Rules

One of the following privileges is required to perform <alter view statement>.

- (ALTER or CONTROL TABLE) ON TABLE for the view
- (ALTER TABLE or CONTROL SCHEMA) ON SCHEMA for the schema to which the view belongs
- ALTER ANY TABLE ON DATABASE

Syntax Rules and Parameters

view_name

It is the view name to be altered.

It can define the schema to which the view belongs, such as schema_name.view_name. If schema_name is omitted, the default schema name of the user performing the statement is used.

COMPILE

It compiles the view again.

COMMENT which is given to the view column is initialized.

Description

When the table or the view which is referenced by the view is altered or dropped, then it affects that view.

This information can be retrieved from INFORMATION_SCHEMA.VIEWS.

- IS_COMPILED column
 - TRUE: The view was successfully created.
 - FALSE: The view was created with FORCE option when an error exists.
- IS_AFFECTED column
 - TRUE: The table and the view which was referenced by the view was altered.
 - FALSE: After creation and compilation of a view, the table and the view which was referenced by the view was not altered.

Example

The following is an example of compiling the view which is affected by the table change referenced by that view.

```
gSQL> SELECT TABLE_NAME, IS_AFFECTED
        FROM INFORMATION_SCHEMA.VIEWS
        WHERE TABLE_SCHEMA = 'PUBLIC'
          AND TABLE_NAME = 'V1';
TABLE_NAME IS_AFFECTED
-----
V1          TRUE
1 row selected.
gSQL> ALTER VIEW v1 COMPILE;
View altered.
COMMIT;
Commit complete.
gSQL> SELECT TABLE_NAME, IS_AFFECTED
```

```
FROM INFORMATION_SCHEMA.VIEWS
WHERE TABLE_SCHEMA = 'PUBLIC'
AND TABLE_NAME = 'V1';
TABLE_NAME IS_AFFECTED
-----
V1          FALSE
1 row selected.
```

Compatibility

The SQL standard does not define <alter view statement>.

For More Information

Refer to the followings.

- [CREATE VIEW](#)
- [DROP VIEW](#)

16.71 ANALYZE SYSTEM

Function

It controls the statistics information of the system.

Syntax

```
<analyze system statement> ::=  
    ANALYZE SYSTEM [ <analyze action> ]  
    ;  
<analyze action> ::=  
    COMPUTE STATISTICS  
    | DELETE STATISTICS
```

Invocation and Access Rules

ANALYZE ANY ON DATABASE privilege is required to perform <analyze system statement>.

Syntax Rules and Parameters

<analyze action>

When it is omitted, the default value is COMPUTE STATISTICS.

COMPUTE STATISTICS

It builds the following statistics information related to the system.

- CPU_OPS (Operations Per Second)
 - It is the number of operations of which the CPU can process per second.
- NETWORK_IOPS (I/O operations Per Second)
 - It is valid for the cluster.

- It is the number of the network I/O which can be processed per second.

DELETE STATISTICS

It deletes the statistics information of the system.

Description

The built statistics information of the system is used to calculate the cost of optimization for the query process.

Examples

The following is an example of building the statistics information of the system by using the `<analyze system statement>` statement.

```
gSQL> ANALYZE SYSTEM COMPUTE STATISTICS;  
analyzed.
```

The following is an example of retrieving the built statistics information of the system.

```
gSQL>  
SELECT * FROM DBA_STAT_SYSTEM;  
CPU_OPS NETWORK_IOPS NETWORK_BUFSIZE LAST_ANALYZED  
-----  
53000412          2914          65536 2017-03-30 16:49:42.200000  
1 row selected.
```

Compatibility

The SQL standard does not define the concepts of the statistics information.

For More Information

Refer to ANALYZE TABLE.

16.72 ANALYZE TABLE

Function

It controls the statistics information of the table.

Syntax

```
<analyze table statement> ::=
    ANALYZE TABLE table_name
    [ <parallel clause> ]
    [ <analyze action> ]
    ;
<parallel clause> ::=
    NOPARALLEL
    | PARALLEL [thread_count]
<analyze action> ::=
    COMPUTE STATISTICS [ <for_clause> ]
    | ESTIMATE STATISTICS <sample_clause> [ <for_clause> ]
    | DELETE STATISTICS
<sample_clause>
    SAMPLE row_count ROWS
    | SAMPLE percentage PERCENT
<for_clause>
    FOR ALL COLUMNS
    | FOR ALL INDEXED COLUMNS
    | FOR COLUMNS column_name [, ...]
    | FOR ALL INDEXES
    | FOR INDEXES index_name [, ...]
```

Invocation and Access Rules

ANALYZE ANY ON DATABASE privilege is required to perform <analyze table statement>.

Syntax Rules and Parameters

table_name

It is the table name.

It can define the schema to which the table belongs, such as schema_name.table_name. If schema_name is omitted, the default schema name of the user performing the statement is used.

<parallel clause>

It specifies the number of threads to be used in a analyzing process.

If it is not specified, the default value is PARALLEL.

- NOPARALLEL
 - It does not analyze in parallel.
- PARALLEL [thread_count]
 - It analyzes in parallel.
 - The minimum value of the thread_count is 0, and the maximum value is 64.
 - If the thread_count value is 0 or it is omitted, then it is determined by the number of CPUs in the system.

<analyze action>

When it is omitted, the default value is COMPUTE STATISTICS.

COMPUTE STATISTICS

It builds the following statistics information related to the table through the all inspection.

- The table statistics information
 - Row count
- The statistics information of each column
 - The number of different values
 - The number of NULL values
 - The average length of the value
 - The minimum value
 - The maximum value
- The statistics information of an index
 - The number of different keys

The statistics information which is built according to the data type of the column is as follows.

Table 16-20 Statistics information built according to the data type

Data type	NUM_DISTINCT	NUM_NULLS	AVG_LENGTH	MIN/MAX
BOOLEAN	O	O	O	X
NATIVE_SMALLINT	O	O	O	O
NATIVE_INTEGER	O	O	O	O
NATIVE_BIGINT	O	O	O	O
NATIVE_REAL	O	O	O	O
NATIVE_DOUBLE	O	O	O	O
NUMBER	O	O	O	O
NUMERIC	O	O	O	O
FLOAT	O	O	O	O
CHAR(n)	O	O	O	It is built when it is 64 bytes or smaller.
VARCHAR(n)	O	O	O	It is built when it is 64 bytes or smaller.
LONG VARCHAR	X	X	X	X
BINARY	O	O	O	X
VARBINARY	O	O	O	X
LONG VARBINARY	X	X	X	X
DATE	O	O	O	O
TIME	O	O	O	O
TIMESTAMP	O	O	O	O
INTERVAL	O	O	O	O
ROWID	O	O	O	X

ESTIMATE STATISTICS <sample_clause>

It builds the statistics information of the column and the index by using as many samples as the specified <sample_clause>.

- SAMPLE row_count ROWS
 - It uses as many samples as the specified number of rows.
 - row_count is a positive integer bigger than 0.
- SAMPLE percentage PERCENT
 - It uses as many samples as the specified ratio.
 - The percentage is a positive integer in the range between 1 and 99.

If the number of the sampling rows are smaller than the value of **MIN_SAMPLE_ROW_COUNT** property, then it follows the property value.

<for_clause>

If it is omitted, it builds the statistics information of all possible columns and indexes.

FOR ALL COLUMNS

It builds the statistics information of all possible columns.

It does not build the statistics information of an index.

FOR ALL INDEXED COLUMNS

It builds the statistics information of all columns included in an index.

It does not build the statistics information of other columns.

It does not build the statistics information of an index.

FOR COLUMNS *column_name* [, ...]

It builds the statistics information of the listed columns.

It does not build the statistics information of unlisted columns.

It does not build the statistics information of an index.

FOR ALL INDEXES

It builds the statistics information of all indexes.

It does not build the statistics information of columns.

FOR INDEXES *index_name* [, ...]

It builds the statistics information of the listed indexes.

It does not build the statistics information of unlisted indexes.

It does not build the statistics information of a column.

DELETE STATISTICS

It deletes the statistics information of the table.

Description

The statistics information of the table affects the query optimization, so it is very important information.

The time to build the statistics information is increased in proportion to the data volumes in a table. Therefore, when the data volume is big, then it is recommended to build the statistics information by using the sampling or to build only the statistics of major information which affects the query.

- The following is an example of building the statistics information by using the sampling.

```
ANALYZE TABLE lineitem ESTIMATE STATISTICS SAMPLE 10 PERCENT;
```

- The following is an example of building the statistics information only of major columns and the index.

```
ANALYZE TABLE lineitem COMPUTE STATISTICS FOR ALL INDEXED COLUMNS;
ANALYZE TABLE lineitem COMPUTE STATISTICS FOR ALL INDEXES;
```

Examples

The following is an example of building the statistics information through the all inspection.

```
gSQL> ANALYZE TABLE orders;
Table analyzed.
```

The following is an example of retrieving the built statistics information of the table.

```
gSQL>
SELECT
    TABLE_NAME
    , NUM_ROWS
FROM
    DICTIONARY_SCHEMA.USER_TABLES
WHERE
    TABLE_SCHEMA = 'PUBLIC'
    AND TABLE_NAME = 'ORDERS'
;
TABLE_NAME NUM_ROWS
-----
ORDERS      1500000
```

1 row selected.

gSQL>

SELECT

```

    TABLE_NAME
  , COLUMN_NAME
  , NUM_DISTINCT
  , NUM_NULLS
  , LOW_VALUE
  , HIGH_VALUE

```

FROM

```
DICTIONARY_SCHEMA.USER_TAB_COLUMNS
```

WHERE

```

    TABLE_SCHEMA = 'PUBLIC'
  AND TABLE_NAME = 'ORDERS'

```

;

TABLE_NAME	COLUMN_NAME	NUM_DISTINCT	NUM_NULLS	LOW_VALUE	HIGH_VALUE
ORDERS	O_ORDERKEY	1500000	0	1	6000000
ORDERS	O_CUSTKEY	99996	0	1	149999
ORDERS	O_ORDERSTATUS	3	0	F	P
ORDERS	O_TOTALPRICE	1464556	0	857.71	555285.16
ORDERS	O_ORDERDATE	2406	0	1992-01-01 00:00:00	1998-08-02 00:00:00
ORDERS	O_ORDERPRIORITY	5	0	1-URGENT	5-LOW
ORDERS	O_CLERK	1000	0	Clerk#000000001	Clerk#000001000
ORDERS	O_SHIPPRIORITY	1	0	0	0
ORDERS	O_COMMENT	1482071	0	null	null

9 rows selected.

gSQL>

SELECT

```

    TABLE_NAME
  , INDEX_NAME
  , DISTINCT_KEYS

```

FROM

```
DICTIONARY_SCHEMA.USER_INDEXES
```

WHERE

```

    TABLE_SCHEMA = 'PUBLIC'
  AND TABLE_NAME = 'ORDERS'

```

;

TABLE_NAME	INDEX_NAME	DISTINCT_KEYS
ORDERS	ORDERS_PK_INDEX	1500000

ORDERS ORDERS_CUSTKEY_FK 99996
2 rows selected.

Compatibility

The SQL standard does not define the concepts of the statistics information.

For More Information

Refer to **ANALYZE SYSTEM**.

16.73 AUDIT POLICY

Function

It activates the audit policy.

Syntax

```
<audit policy statement> ::=
    AUDIT POLICY policy_name
    [ <specified_user_option> ]
    [ <specified_success_option> ]
    ;
<specified_user_option> ::=
    BY user_name [, ...]
    | EXCEPT user_name [, ...]
<specified_success_option> ::=
    WHENEVER SUCCESSFUL
    | WHENEVER NOT SUCCESSFUL
```

Invocation and Access Rules

AUDIT SYSTEM ON DATABASE privilege is required to perform <audit policy statement>.

Syntax Rules and Parameters

policy_name

It is the name of the audit policy object to be activated.

The activated audit policy does not effect on the existing session, and it effects only on the newly created session.

<specified_user_option>

It specifies the user to be audited.

If omitted, all users are audited.

BY clause and EXCEPT clause can not be used together for the same audit policy.

- BY user_list: If the user to be audited is specified, then use BY clause.
- EXCEPT user_list: If other users excluding a specific user is to be audited, use EXCEPT clause.

<specified_success_option>

- WHENEVER SUCCESSFUL
 - If an action succeeds, then the audit record is created.
- WHENEVER NOT SUCCESSFUL
 - If an action fails, then the audit record is created.
- If omitted, both when an action succeeds and fails, the audit record is created.

Description

Activating the audit policy does not affect the existing session, but it starts to audit the newly created session.

Retrieving Audit Record

The audit record is created when it corresponds to the audit policy, and it can be retrieved through DICTIONARY_SCHEMA.AUDIT_TRAIL view as follows.

```
SELECT logon_user
       , event_timestamp
       , action_name
       , object_name
       , sql_text
FROM   audit_trail
WHERE  policy_name = 'P1'
;
```

SELECT privilege should be given to an ordinary user to retrieve AUDIT_TRAIL.

```
GRANT SELECT ON DICTIONARY_SCHEMA.AUDITrail TO user_name;
```

Retrieving Audit Policy Information

The information about the audit policy object can be retrieved through `DICTIONARY_SCHEMA.AUDIT_POLICY_OPTIONS` view.

```
SELECT policy_name
       , audit_option
       , object_schema
       , object_name
FROM audit_policy_options
;
```

The information about whether the audit policy object is activated can be retrieved through `DICTIONARY_SCHEMA.AUDIT_POLICY_ENABLED` view.

```
SELECT policy_name
       , enabled_opt
       , user_name
       , when_success
       , when_failure
FROM audit_policy_enabled
;
```

Cautions When Using BY and EXCEPT Clauses

Activate the users group if multiple `AUDIT POLICY BY` clauses are used for the same audit policy. In other words, the following two examples have the same meaning.

- Example 1: It activates the p1 audit policy for u1 and u2.

```
AUDIT POLICY p1 BY u1;
AUDIT POLICY p1 BY u2;
```

- Example 2: It activates the p1 audit policy for u1 and u2.

```
AUDIT POLICY p1 BY u1, u2;
```

If multiple `AUDIT POLICY EXCEPT` clauses are used for the same audit policy, only the last `AUDIT POLICY` clause is valid.

In other words, the following two examples have different meanings.

- Example 1: Only the last clause is valid, and activates the p1 audit policy excluding u2.

```
AUDIT POLICY p1 EXCEPT u1;  
AUDIT POLICY p1 EXCEPT u2;
```

- Example 2: It activates the p1 audit policy excluding u1 and u2.

```
AUDIT POLICY p1 EXCEPT u1, u2;
```

BY and EXCEPT can not be used together for the same policy.

- If the audit policy is activated with BY clause, then only BY clause can be used afterwards.

```
AUDIT POLICY p1 BY u1;
```

- Error

```
AUDIT POLICY p1 EXCEPT u2;
```

- If the audit policy is activated with EXCEPT clause, then only EXCEPT clause can be used afterwards.

```
AUDIT POLICY p1 EXCEPT u1;
```

- Error: It corresponds to *by all users*.

```
AUDIT POLICY p1;
```

If a user wants to convert the audit policy activated with BY to EXCEPT or to convert the audit policy activated with EXCEPT to BY, the activated audit policy should be deactivated first, then it can be converted.

Deactivate the audit policy with NOAUDIT POLICY statement as follows.

- AUDIT POLICY p1 BY u1, u2;
 - NOAUDIT POLICY p1 BY u1, u2;
- AUDIT POLICY p1;
 - NOAUDIT POLICY p1;
- AUDIT POLICY p1 EXCEPT u1, u2;
 - NOAUDIT POLICY p1;
 - NOAUDIT POLICY statement does not have an EXCEPT option.

WHENEVER clause which is used together with BY clause is accumulated.

The following two examples have the same meaning.

- Example 1: It creates the audit record regardless of success/ failure.

```
AUDIT POLICY p1 BY u1 WHENEVER SUCCESSFUL;
AUDIT POLICY p1 BY u1 WHENEVER NOT SUCCESSFUL;
```

- Example 2: It creates the audit record regardless of success/ failure.

```
AUDIT POLICY p1 BY u1;
```

If WHENEVER clauses are used together with EXCEPT clause, only the last WHENEVER clause is valid.

The following two examples have different meanings.

- Example 1: It creates the audit record when it fails.

```
AUDIT POLICY p1 EXCEPT u1 WHENEVER SUCCESSFUL;
AUDIT POLICY p1 EXCEPT u1 WHENEVER NOT SUCCESSFUL;
```

- Example 2: It creates the audit record regardless of success/ failure.

```
AUDIT POLICY p1 EXCEPT u1;
```

Examples

The following is an example of activating the audit policy for all users.

```
AUDIT POLICY table_pol;
```

The information about activation can be viewed through the following query.

```
SELECT policy_name
       , enabled_opt
       , user_name
FROM   audit_policy_enabled
WHERE  policy_name = 'TABLE_POL';
```

POLICY_NAME	ENABLED_OPT	USER_NAME
TABLE_POL	BY	ALL USERS

The following is an example of activating the audit policy by defining specific users.

```
AUDIT POLICY dml_pol BY u1, u2;
```

The following is an example of activating the audit policy by excluding a specific user.

```
AUDIT POLICY read_seq_pol EXCEPT sys;
```

The following is an example of auditing the failure of SQL statement by a specific user.

```
AUDIT POLICY delete_pol BY u1 WHENEVER NOT SUCCESSFUL;
```

Compatibility

The SQL standard does not have the audit policy.

For More Information

Refer to the followings.

- Managing audit policy object
 - **CREATE AUDIT POLICY**
 - **DROP AUDIT POLICY**
 - **ALTER AUDIT POLICY**
- Activating/ deactivating audit policy
 - **AUDIT POLICY**
 - **NOAUDIT POLICY**
- Viewing audit trail: **AUDIT_TRAIL**
- Clearing audit trail: **ALTER DATABASE CLEAR AUDIT TRAIL**

16.74 CLOSE cursor_name

Function

It closes a cursor.

Syntax

```
<close statement> ::=  
    CLOSE cursor_name  
    ;
```

Syntax Rules and Parameters

cursor_name

The cursor should be open.

The cursor should be declared with **DECLARE cursor_name** statement in the session.

Description

The cursor is an object which exists in the session and it does not affect the cursor in a different session.

Example

The following is an example of DECLARE, OPEN, FETCH, and CLOSE the cursor by using gsql (interactive SQL tool).

```
gSQL> DECLARE cur1 CURSOR FOR SELECT id, data FROM t1;  
Cursor declared.  
gSQL> OPEN cur1;  
Cursor is open.
```

```

gSQL> \var v_id  INTEGER
gSQL> \var v_data VARCHAR(128)
gSQL> FETCH cur1 INTO :v_id, :v_data;
V_ID V_DATA
-----
      1 data_1
1 row fetched.
gSQL> FETCH cur1 INTO :v_id, :v_data;
V_ID V_DATA
-----
      2 data_2
1 row fetched.
gSQL> FETCH cur1 INTO :v_id, :v_data;
no rows fetched.
gSQL> CLOSE cur1;
Cursor closed.

```

Compatibility

Table 16-21 SQL standard compatibility

Feature ID	Description	Compatibility
B031	Basic dynamic SQL	O

For More Information

Refer to the followings.

- **DECLARE** cursor_name
- **OPEN** cursor_name
- **FETCH** cursor_name

16.75 COMMENT ON name IS

Function

It stores the comments about the object in the dictionary.

Syntax

```
<comment statement> ::=
    COMMENT ON <comment object> IS 'comment string'
    ;
<comment object> ::=
    CLUSTER GROUP group_name
    | CLUSTER MEMBER member_name
    | DATABASE
    | PROFILE profile_name
    | AUTHORIZATION user_name
    | TABLESPACE tablespace_name
    | SCHEMA schema_name
    | TABLE [schema_name].table_name
    | COLUMN [schema_name].table_name.column_name
    | INDEX [schema_name].index_name
    | SEQUENCE [schema_name].sequence_name
    | CONSTRAINT [schema_name].constraint_name
    | PROCEDURE [schema_name].procedure_name
```

Invocation and Access Rules

The altering privileges on each object are required to perform <comment statement> as follows.

- CLUSTER GROUP
 - ALTER SYSTEM ON DATABASE
- CLUSTER MEMBER
 - ALTER SYSTEM ON DATABASE
- DATABASE

- ALTER DATABASE ON DATABASE
- PROFILE
 - ALTER PROFILE ON DATABASE
- AUDIT POLICY
 - AUDIT SYSTEM ON DATABASE
- AUTHORIZATION (user)
 - ALTER USER ON DATABASE
- AUTHORIZATION (role)
 - ALTER ROLE ON DATABASE
- TABLESPACE
 - ALTER TABLESPACE ON DATABASE
- SCHEMA: One of the following privileges is required.
 - The owner of the schema
 - CONTROL SCHEMA ON SCHEMA for the schema
 - ALTER SCHEMA ON DATABASE
- TABLE: One of the following privileges is required.
 - The owner of the table
 - CONTROL TABLE ON TABLE for the table
 - CONTROL SCHEMA ON SCHEMA for the schema to which the table belongs
 - ALTER ANY TABLE ON DATABASE
- COLUMN: One of the following privileges is required.
 - The owner of the table to which the column belongs
 - CONTROL TABLE ON TABLE for the table to which the column belongs
 - CONTROL SCHEMA ON SCHEMA for the schema of the table to which the column belongs
 - ALTER ANY TABLE ON DATABASE
- INDEX: One of the following privileges is required.
 - The owner of the index
 - CONTROL SCHEMA ON SCHEMA for the schema to which the index belongs
 - ALTER ANY INDEX ON DATABASE
- SEQUENCE
 - The owner of the sequence
 - CONTROL SCHEMA ON SCHEMA for the schema to which the sequence belongs
 - ALTER ANY SEQUENCE ON DATABASE
- CONSTRAINT
 - The owner of that constraint
 - CONTROL SCHEMA ON SCHEMA for the schema to which the constraint belongs
 - ALTER ANY TABLE ON DATABASE
- PROCEDURE
 - The owner of the stored procedure/function
 - CONTROL SCHEMA ON SCHEMA for the schema to which the stored procedure/function belong

- ALTER ANY PROCEDURE ON DATABASE

Syntax Rules and Parameters

<comment object>

It is an object in which the comments are to be stored. The comments for the following database objects are stored.

- Cluster object
 - CLUSTER GROUP
 - CLUSTER MEMBER
- Non-schema object
 - DATABASE
 - PROFILE
 - AUDIT POLICY
 - AUTHORIZATION (User or role)
 - TABLESPACE
 - SCHEMA
- Schema object
 - TABLE or VIEW
 - COLUMN
 - INDEX
 - SEQUENCE
 - CONSTRAINT
 - PROCEDURE or FUNCTION

If schema_name for the schema object is not specified, the schema name is determined by **Schema Path** of the user performing the statement.

```
COMMENT ON TABLE test_table IS 'test comment';  
→ COMMENT ON TABLE user_default_schema.test_table IS 'test comment';
```

'comment string'

It describes the comments to be stored.

Use the empty string ('') to delete the comments as follows.

```
COMMENT ON TABLE test_table IS '';
```

The length of the comment string can not exceed 1024 bytes.

Description

The information can be retrieved from the COMMENTS column of the following dictionary view per each object type.

- Cluster objects
 - CLUSTER GROUP & CLUSTER MEMBER
 - DICTIONARY_SCHEMA.DBA_CLUSTER_COMMENTS view
- Non-schema objects
 - DATABASE
 - DICTIONARY_SCHEMA.ALL_NONSCHEMA_COMMENTS view
 - DICTIONARY_SCHEMA.DBA_NONSCHEMA_COMMENTS view
 - PROFILE
 - DICTIONARY_SCHEMA.DBA_NONSCHEMA_COMMENTS view
 - AUDIT POLICY
 - DICTIONARY_SCHEMA.AUDIT_POLICIES view
 - USER
 - DICTIONARY_SCHEMA.ALL_NONSCHEMA_COMMENTS view
 - DICTIONARY_SCHEMA.DBA_NONSCHEMA_COMMENTS view
 - TABLESPACE
 - DICTIONARY_SCHEMA.ALL_NONSCHEMA_COMMENTS view
 - DICTIONARY_SCHEMA.DBA_NONSCHEMA_COMMENTS view
 - SCHEMA
 - DICTIONARY_SCHEMA.ALL_NONSCHEMA_COMMENTS view
 - DICTIONARY_SCHEMA.DBA_NONSCHEMA_COMMENTS view
- SQL schema objects
 - TABLE
 - DICTIONARY_SCHEMA.USER_TAB_COMMENTS view
 - DICTIONARY_SCHEMA.ALL_TAB_COMMENTS view
 - DICTIONARY_SCHEMA.DBA_TAB_COMMENTS view
 - VIEW
 - DICTIONARY_SCHEMA.USER_TAB_COMMENTS view
 - DICTIONARY_SCHEMA.ALL_TAB_COMMENTS view
 - DICTIONARY_SCHEMA.DBA_TAB_COMMENTS view
 - COLUMN
 - DICTIONARY_SCHEMA.USER_COL_COMMENTS view

- `DICTIONARY_SCHEMA.ALL_COL_COMMENTS` view
- `DICTIONARY_SCHEMA.DBA_COL_COMMENTS` view
- INDEX
 - `DICTIONARY_SCHEMA.USER_INDEXES` view
 - `DICTIONARY_SCHEMA.ALL_INDEXES` view
 - `DICTIONARY_SCHEMA.DBA_INDEXES` view
- SEQUENCE
 - `DICTIONARY_SCHEMA.USER_SEQUENCES` view
 - `DICTIONARY_SCHEMA.ALL_SEQUENCES` view
 - `DICTIONARY_SCHEMA.DBA_SEQUENCES` view
- CONSTRAINT
 - `DICTIONARY_SCHEMA.USER_CONSTRAINTS` view
 - `DICTIONARY_SCHEMA.ALL_CONSTRAINTS` view
 - `DICTIONARY_SCHEMA.DBA_CONSTRAINTS` view
- PROCEDURE & FUNCTION
 - `DICTIONARY_SCHEMA.USER_PROCEDURES` view
 - `DICTIONARY_SCHEMA.ALL_PROCEDURES` view
 - `DICTIONARY_SCHEMA.DBA_PROCEDURES` view

For more information about the detailed description of each view, refer to `DICTIONARY_SCHEMA`.

Examples

The following is an example of creating the comment on the table.

```
gSQL> COMMENT ON TABLE t1 IS 'test comment on table t1';  
Comment created.
```

The following is an example of creating the comment on the column.

```
gSQL> COMMENT ON COLUMN t1.id IS 'test comment on column t1.id';  
Comment created.
```

The following is an example of creating the comment on the schema.

```
gSQL> COMMENT ON SCHEMA s1 IS 'test comment on schema s1';  
Comment created.
```

Compatibility

<comment statement> does not exist in SQL standard.

16.76 COMMIT

Function

It terminates the current transaction and makes all changes permanent.

Syntax

```
<commit statement> ::=
    COMMIT [ WORK ]
        [ [ <commit comment clause> ] [ <commit write clause> ] ]
        [ <commit force clause> ] [ <commit comment clause> ] ]
    ;
<commit comment clause> ::=
    COMMENT 'comment_string'
<commit write clause> ::=
    WRITE [ WAIT | NOWAIT ]
<commit force clause> ::=
    FORCE 'xid_string'
```

Syntax Rules and Parameters

WORK

It is the reserved word which does not affect the operation.

<commit comment clause>

- COMMENT 'comment_string'
 - It specifies the comment to the transaction when committing the transaction.

<commit write clause>

It determines whether to wait until the redo logs generated by the commit operation are written on the redo log file.

- WAIT
 - It waits until the redo logs generated by the commit operation are written to the redo log file, and then the operation is terminated.
- NOWAIT
 - The operation is terminated when the redo logs generated by the commit operation are written to the redo log buffer.
- If it is not specified, it follows the property.

⟨commit force clause⟩

It is used to manually commit a distributed transaction.

- FORCE 'xid_string'
 - It commits the distributed transaction 'xid_string'.
 - 'xid_string' consists of '*format_id.transaction_id.branch_id*'.

Description

COMMIT statement completes the following statements which were executed in a transaction.

- Data Manipulation Language (DML) statement
 - It is the statement which changes data, such as INSERT, UPDATE, DELETE.
- Data Definition Language (DDL) statement
 - It is the statement which changes the structure and definition of the objects, such as CREATE, DROP, ALTER, TRUNCATE, GRANT, REVOKE.

Exceptionally, the following DDL statements which manage the OS resources or change the DATA TYPE are automatically committed.

- CREATE TABLESPACE
- DROP TABLESPACE
- ALTER TABLESPACE
- ALTER TABLE .. ALTER COLUMN .. SET DATA TYPE: ⟨alter column data type clause⟩

When performing COMMIT, the cursor opened by WITHOUT HOLD option is automatically closed. For more information about cursors, refer to the following cursor related statements.

- DECLARE cursor_name
- OPEN cursor_name

If the transaction violates the DEFERRED constraint, the COMMIT statement fails and the transaction is rolled back.

led back. For more information about DEFERRED constraint, refer to **SET CONSTRAINTS**.

Example

The following is an example of performing COMMIT after executing INSERT statement.

```
gSQL> INSERT INTO t1 VALUES ( 1, 'anonymous' );  
1 row created.  
gSQL> COMMIT WORK COMMENT 'INSERT T1';  
Commit complete.
```

Compatibility

Table 16-22 SQL standard compatibility

Feature ID	Description	Compatibility
T261	Chained transactions	X

For More Information

Refer to the followings.

- **ROLLBACK**
- **SAVEPOINT** `savepoint_specifier`

16.77 CREATE AUDIT POLICY

Function

It creates an audit policy object.

AUDIT POLICY should be performed to activate the created audit policy object.

Syntax

```
<audit policy definition> ::=
    CREATE AUDIT POLICY policy_name
    { <privilege_audit_clause> | <action_audit_clause> | <privilege_audit_clause>
<action_audit_clause> }
    ;
<privilege_audit_clause> ::=
    PRIVILEGES <database_privilege> [, ...]
<action_audit_clause> ::=
    ACTIONS { <object_action_audit> | <system_action_audit> } [, ...]
<object_action_audit> ::=
    ALL ON [schema_name.]object_name
    | <object_action> ON [schema_name.]object_name
<system_action_audit> ::=
    ALL
    | DDL
    | <system_action>
```

Invocation and Access Rules

AUDIT SYSTEM ON DATABASE privilege is required to perform <audit policy definition>.

Syntax Rules and Parameters

policy_name

It is the name of the audit policy to be created.

<privilege_audit_clause>

The privilege audit is auditing when the SQL statement is successfully performed by using the database privilege.

It can audit a specific user performing SQL statement by using the database privilege, and it does not record the privilege audit for SYS user who is the owner of the database.

The following is an example of granting SELECT ANY TABLE privilege to user u1 and activating the audit policy.

```
CREATE AUDIT POLICY p1
    PRIVILEGES SELECT ANY TABLE;
AUDIT POLICY p1;
```

If the user u1 performs the following SQL statement, the privilege audit differently operates.

- SELECT * FROM u1.t1;
 - It does not create the audit record by performing SQL statement with the privilege as an owner of table u1.t1.
- SELECT * FROM u2.t1;
 - It creates the audit record by performing SQL statement with SELECT ANY TABLE privilege.

<database_privilege> which can be described in the privilege audit can be viewed with the following query.

```
SELECT PRIVILEGE_NAME FROM V$AUDITABLE_DB_PRIVILEGES;
```

<action_audit_clause>

It audits an action for a specific object and an action for the entire database.

<object_action_audit>

ALL ON object_name

It means all actions which can list objects corresponding to object_name.

The following table describes audit actions of which each object type can audit.

Table 16-23 Audit action per object type

Object type	Action
Table	ALTER, COMMENT, DELETE, GRANT, INDEX, INSERT, LOCK, RENAME, SELECT, UPDATE
View	ALTER, COMMENT, GRANT, SELECT
Sequence	ALTER, COMMENT, GRANT, SELECT
Stored Function/Procedure	ALTER, COMMENT, EXECUTE, GRANT

<object_action> ON object_name

Each separate action per a specific object should be listed by specifying ON clause as follows.

```
CREATE AUDIT POLICY p1
  ACTIONS INSERT ON u1.t1
        , DELETE ON u1.t1
        , UPDATE ON u1.t1
;
```

Caution of EXECUTE action

Auditing the success or the failure of stored function or stored procedure is determined only based on whether it is executable at the time of execution.

- WHENEVER NOT SUCCESSFUL creates the audit record when neither the stored function nor procedure is executable.
- WHENEVER SUCCESSFUL creates the audit record even though an error occurs while executing SQL statement within the stored function or the procedure
- If an auditing for the failure of SQL statement within the stored function or the procedure is required, then the audit target should include the corresponding SQL statement.

<system_action_audit>

It audits the system action which occurs in the database regardless of a specific object.

- <system_action>

The valid system action can be retrieved by using the following query.

```
SELECT ACTION_NAME FROM V$AUDITABLE_SYSTEM_ACTIONS;
```

- ALL

It means all system actions.

- DDL

It means all Data Definition Language (DDL).

Description

An audit policy object is an object which defines auditing targets.

Perform AUDIT POLICY statement to activate an audit policy.

Though it is possible to define and activate multiple audit policies, but it is recommended to maintain certain numbers of audit policies.

It is also recommended to bind multiple small pieces of policies into a small number of groups.

The information about an option of the created audit policy object can be retrieved through AUDIT_POLICY_OPTIONS view as follows.

```
SELECT audit_option
       , audit_option_type
       , object_schema
       , object_name
FROM   audit_policy_options
WHERE  policy_name = 'P1'
;
```

AUDIT_OPTION	AUDIT_OPTION_TYPE	OBJECT_SCHEMA	OBJECT_NAME
DELETE	OBJECT ACTION	U1	T1
INSERT	OBJECT ACTION	U1	T1
UPDATE	OBJECT ACTION	U1	T1

Creating Audit Record

If an action corresponding to multiple audit policies occurs, then one or more audit records are created.

If similar audit options are listed as follows, then one audit record is created.

- Defining an audit policy

```
CREATE AUDIT POLICY p1
  PRIVILEGES SELECT ANY TABLE
  ACTIONS SELECT;
AUDIT POLICY p1;
```

- Performing an audit action

```
SELECT * FROM other_user.t1;
```

If two different audit options are listed as follows, then two audit records are created.

- Defining an audit policy

```
CREATE AUDIT POLICY p1
  ACTIONS SELECT ON u1.t1
    , SELECT ON u2.t2;
AUDIT POLICY p1;
```

- Performing an audit action

```
SELECT COUNT(*) FROM u1.t1 A, u2.t2 B WHERE A.id = B.id;
```

If multiple audit policies are activated for the same action as follows, then two audit records are created.

- Defining an audit policy

```
CREATE AUDIT POLICY p1
  PRIVILEGES SELECT ANY TABLE;
AUDIT POLICY p1;
CREATE AUDIT POLICY p2
  ACTIONS SELECT;
AUDIT POLICY p2;
```

- Performing an audit action

```
SELECT * FROM other.t1;
```

Examples

The following is an example of defining an audit policy which audits an privilege.

```
CREATE AUDIT POLICY policy_table
  PRIVILEGES CREATE ANY TABLE
            , DROP ANY TABLE
;
```

The following is an example of defining an audit policy which audits an action for an object.

```
CREATE AUDIT POLICY policy_dml
  ACTIONS INSERT ON u1.t1
            , DELETE ON u1.t1
            , UPDATE ON u1.t1
            , ALL ON u1.t2
;
```

The following is an example of defining an audit policy which audits the system action.

```
CREATE AUDIT POLICY policy_drop
  ACTIONS DROP TABLE, TRUNCATE TABLE
;
```

The following is an example of defining an audit policy which combines all examples above.

```
CREATE AUDIT POLICY policy_group
  PRIVILEGES CREATE ANY TABLE
            , DROP ANY TABLE
  ACTIONS INSERT ON u1.t1
            , DELETE ON u1.t1
            , UPDATE ON u1.t1
            , ALL ON u1.t2
            , DROP TABLE
            , TRUNCATE TABLE
;
```

Compatibility

The audit policy does not exist in SQL standard.

For More Information

Refer to the followings.

- Managing audit policy object
 - **CREATE AUDIT POLICY**
 - **DROP AUDIT POLICY**
 - **ALTER AUDIT POLICY**
- Activating/ deactivating audit policy
 - **AUDIT POLICY**
 - **NOAUDIT POLICY**
- Retrieving audit trail: **AUDIT_TRAIL**
- Clearing audit trail: **ALTER DATABASE CLEAR AUDIT TRAIL**

16.78 CREATE CLUSTER GROUP

Function

It creates a cluster group which is to participate in a cluster system.

Syntax

```
<cluster group definition> ::=
    CREATE CLUSTER GROUP group_name
        <cluster member definition> [, ...]
    ;
<cluster member definition> ::=
    CLUSTER MEMBER member_name <connection attribute>
<connection attribute> ::=
    HOST 'address' PORT port_no
```

Invocation and Access Rules

It can be performed in a cluster system.

ADMINISTRATION ON DATABASE privilege is required to perform <cluster group definition>.

Syntax Rules and Parameters

group_name

It is the name of a cluster group.

An identical cluster group name or a cluster member name should not exist.

The name length should be shorter than 128 bytes.

<cluster member definition>

It defines a cluster member to be included in a cluster group.

A cluster group can include maximum 32 cluster members.

A cluster group which is created first in a cluster system can define only one cluster member, and should include itself as a cluster member.

member_name

It is the name of a cluster member.

The name of a cluster member should be same as the name of the member which was defines when creating the database of that member.

An identical cluster group name or a cluster member name should not exist.

The name length should be shorter than 128 bytes.

The start-up phase of the cluster member should be the OPEN phase.

<connection attribute>

It defines the connection information for the communication between the cluster members.

<connection attribute> should be as same as the HOST and PORT which were defined when the database of that cluster member was created.

The combination of HOST and PORT should be unique in the cluster system.

- HOST address uses ip v4 type.
- PORT port_no should be in the range between 1024 ~ 49151.

Description

<cluster group definition> statement does not rebalance the shard of tables.

Perform the following statements to rebalance the shard to an added cluster group.

- ALTER DATABASE REBALANCE
- ALTER TABLE name REBALANCE

Examples

The following is an example of creating a cluster group which consists of two cluster members.

```
gSQL>
CREATE CLUSTER GROUP g1
    CLUSTER MEMBER g1n1 HOST '192.168.0.11' PORT 10110
;
Cluster Group created.
gSQL>
ALTER CLUSTER GROUP g1
    ADD CLUSTER MEMBER g1n2 HOST '192.168.0.12' PORT 10120
;
Cluster Group altered.
gSQL>
CREATE CLUSTER GROUP g2
    CLUSTER MEMBER g2n1 HOST '192.168.0.21' PORT 10210,
    CLUSTER MEMBER g2n2 HOST '192.168.0.22' PORT 10220
;
Cluster Group created.
```

Compatibility

The SQL standard does not define the concepts of the cluster.

For More Information

Refer to the followings.

- **DROP CLUSTER GROUP**
- **ALTER CLUSTER GROUP name ADD MEMBER**

16.79 CREATE CLUSTER LOCATION

Function

It creates the connection information of a cluster member.

Syntax

```
<cluster location definition> ::=  
    CREATE CLUSTER LOCATION member_name  
    <cluster connection attribute>  
    ;  
<cluster connection attribute> ::  
    HOST 'address' PORT port_no
```

Invocation and Access Rules

It can be performed in a cluster system.

ADMINISTRATION ON DATABASE privilege is required to perform <cluster location definition>.

Syntax Rules and Parameters

member_name

It is the name of a cluster member.

The same cluster member name should not exist in the registered cluster location information.

The length of the name should be shorter than 128 bytes.

<cluster connection attribute>

It defines the connection information for the communication between the cluster members.

The combination of HOST and PORT should be unique in the cluster system.

- HOST address uses ip v4 type.
- PORT port_no should be in the range between 1024 ~ 49151.

Description

Generally, the information of the cluster location is automatically created by using the connection information provided when creating the cluster group or adding the cluster member. The created information is deleted together when deleting the cluster member and the cluster group.

If the information of the cluster location is modified, then the connection information can be modified by using **ALTER CLUSTER LOCATION** without deleting or recreating the cluster member.

Examples

```
gSQL>  
CREATE CLUSTER LOCATION g1n2  
    HOST '192.168.0.12' PORT 10120,  
;  
Created
```

Compatibility

The SQL standard does not define the concepts of the cluster.

For More Information

Refer to **DROP CLUSTER LOCATION**.

16.80 CREATE INDEX

Function

It creates an index.

Syntax

```

<index definition> ::=
    CREATE [ UNIQUE ] INDEX index_name
        ON table_name ( <index column element> [, ...] )
        [ <index attributes> [...] ]
        [ TABLESPACE tablespace_name ]
    ;
<index column element> ::=
    column_name [ ASC | DESC ] [ NULLS FIRST | NULLS LAST ]
<index attributes> ::=
    <physical attribute clause>
    | STORAGE ( <segment attr clause> [...] )
    | <logging clause>
    | <parallel clause>
<physical attribute clause> ::=
    PCTFREE integer
    | INITTRANS integer
    | MAXTRANS integer
<segment attr clause> ::=
    INITIAL <size_clause>
    | NEXT <size_clause>
    | MINSIZE <size_clause>
    | MAXSIZE <size_clause>
<size clause> ::=
    integer [ K | M | G | T ]
<logging clause> ::=
    LOGGING
    | NOLOGGING
<parallel clause> ::=
    NOPARALLEL

```

| PARALLEL [integer]

Invocation and Access Rules

The user should satisfy the following conditions to perform <index definition>.

- One of the following privileges is required to create an index on the table.
 - (INDEX or CONTROL TABLE ON) TABLE for that table
 - CONTROL SCHEMA ON SCHEMA for the schema to which the table belongs
 - CREATE ANY INDEX ON DATABASE
- One of the following privileges is required for the schema on which the index to be created.
 - (CREATE INDEX or CONTROL SCHEMA) ON SCHEMA for the schema
 - CREATE ANY INDEX ON DATABASE
- One of the following privileges is required for the tablespace on which the index to be created.
 - CREATE OBJECT ON TABLESPACE for that tablespace
 - USAGE TABLESPACE ON DATABASE
- The owner of the index is determined as follow.
 - The owner of the schema to which the index belongs.
 - If the schema to which the index belongs is PUBLIC, then it is the user who executed the statement.



Unique indexes in a cluster system should include all sharding keys.

Syntax Rules and Parameters

UNIQUE

It does not allow duplicate values for the columns of the index.

index_name

It is the index name to be created and it should be a unique name within the schema.

If the schema name is omitted, the index is created in the schema to which the referring table belongs.

The length of the index name should be shorter than 128 bytes.

table_name

It is the table name which creates the index.

The schema to which a table belongs, such as `schema_name.table_name`, can be defined. If `schema_name` is omitted, the default schema name of the user performing the statement is used.

column_name

It is the column name to be used as an index key.

One or more columns should be defined, and maximum 32 columns can be used as an index key.

The following constraints can occur depending on the implementation.

- If the column data type included in an index is `LONG CHARACTER VARYING`, `LONG BINARY VARYING`, an index can not be created.
- An index is created only when the sum of the column precisions is less than half of the page size.

ASC | DESC

It specifies the sort order of a column.

- `ASC`: It is sorted in ascending order.
- `DESC`: It is sorted in descending order.
- If not specified, the default value is `ASC`.

NULLS FIRST | NULLS LAST

It specifies the sort order of the `NULL` value.

- `NULLS FIRST`: It precedes the non-`NULL` values.
- `NULLS LAST`: It is behind the non-`NULL` values.
- If not specified, the default value is `NULLS LAST`.

<physical attribute clause>

It defines the physical attribute of the index.

- `PCTFREE` integer
 - Definition
 - It is the reserved space for adjusting the page split frequency caused by the key inserted in the page.
 - It applies only to the index bottom-up build.

- It can use the value from 0 to 99.
- If it is omitted, the default value is the value set in DEFAULT_INDEX_PCTFREE property.
- INITRANS integer
 - Definition
 - It specifies the initial number of transactions which can simultaneously access the page.
 - If the number of users who access the index is small, INITRANS is set to low, and if the number of users who simultaneously access the index is big, INITRANS is set to high.
 - If necessary, it is automatically increased to the specified MAXTRANS.
 - It can use the value from 1 to 32.
 - If it is omitted, the default value is 4.
- MAXTRANS integer
 - Definition
 - It specifies the maximum number of transactions which can simultaneously access the page.
 - It can use the value from 1 to 32.
 - If it is omitted, the default value is 8.

⟨segment attr clause⟩

It specifies the information for the index storage space.

- INITIAL integer
 - Definition
 - It specifies the size of physical storage space which is initially allocated when creating the index.
 - This size is aligned to the EXTENT size of the TABLESPACE to which the table belongs. (e.g. If the EXT size is 8192 bytes, 'INITIAL 100' is actually operated as 8192 bytes.)
 - The size (aligned to the EXTENT size of TABLESPACE) should be equal to or bigger than MIN EXTENTS, or it should be equal to or less than MAXEXTENTS.
 - The minimum value is 1, and the maximum value depends on the system environment.
 - If it is omitted, the default value is one EXTENT size of TABLESPACE to which the table belongs.
- NEXT integer
 - Definition
 - It specifies the physical space size to be allocated when adding the space to the table.
 - This size is aligned to the EXTENT size of the TABLESPACE to which the table belongs. (e.g. If the EXT size is 8192 bytes, 'NEXT 100' is actually operated as 8192 bytes.)
 - NEXT operates as follows, depending on the remaining space size of the index available currently. (Obtained by subtracting the amount of currently used space from the MAXEXTENTS size)
 - If the remaining space size is 0, then it can not extend the space.
 - If the remaining space size is bigger than 0, but smaller than NEXT, then it allocates the

space as big as the remaining space.

- If the remaining space size is bigger than NEXT, then it allocates the space as big as the NEXT.

- The minimum value is 1 and the maximum value depends on the system environment.
 - If it is omitted, the default value is one EXTENT size of TABLESPACE to which the index belongs.
- MINSIZE integer
 - Definition
 - It is the minimum space size of the index.
 - The value should be equal to or smaller than MAXSIZE.
 - This size is aligned to the EXTENT size of the TABLESPACE to which the index belongs.
 - The minimum value is 1 and the maximum value depends on the system environment.
 - If it is smaller than the size of two EXTENT, it is specified to the size of two EXTENT.
 - If it is omitted, the default value is the size of two EXTENT.
 - MAXSIZE integer
 - Definition
 - It is the maximum space size of the index.
 - The value should be equal to or bigger than MINSIZE.
 - This size is aligned to the EXTENT size of the TABLESPACE to which the index belongs.
 - The minimum value is 1 and the maximum value depends on the system environment.
 - If it is omitted, the default value is EXTENT size * 2147483647 (The maximum positive integer of INT32).

<size clause>

It specifies the file size in bytes. (If the unit is omitted, the default value is bytes.)

- K: Kilobytes
- M: Megabytes
- G: Gigabytes
- T: Terabytes

LOGGING | NOLOGGING

It specifies whether the index performs redo logging.

If not specified, the default value is NOLOGGING.

NOPARALLEL | PARALLEL [integer]

It specifies the number of threads to be used when building an index.

- NOPARALLEL

- It does not build an index in parallel.
- PARALLEL [integer]
 - It builds an index in parallel.
 - If an integer is omitted or set as 0, then it follows the property (INDEX_BUILD_PARALLEL_FACTOR).
 - The minimum value of an integer is 0 and the maximum value is 16.
 - If the property value is 0, then the system determines the optimal value.
- If it is omitted, the default value is PARALLEL.

TABLESPACE `tablespace_name`

It specifies the name of the tablespace in which the index is to be stored.

- If it specifies `tablespace_name`
 - The `tablespace_name` of LOGGING index should be a data tablespace.
 - The `tablespace_name` of NOLOGGING index should be a temporary tablespace or a nologging tablespace.
- If it omits TABLESPACE clause
 - If INDEX TABLESPACE `tablespace_name` of USER is specified
 - The defined tablespace is used.
 - If INDEX TABLESPACE of USER is NULL
 - LOGGING index uses the user's default data tablespace.
 - NOLOGGING index uses the user's default temporary tablespace.

Description

LOGGING index and NOLOGGING index have the following trade-offs.

- LOGGING index
 - Advantage: It does not separately build an index because the index is automatically restored by using the log when starting up the system.
 - Disadvantage: A disk I/O occurs because the changes on the index are recorded on the log when altering the row.
- NOLOGGING index
 - Advantage: A disk I/O does not occur for the changes on the index when altering the row.
 - Disadvantage: It automatically rebuilds the index when starting up the system because the log information of the index does not exist.

Examples

The following is an example of creating the unique index.

```
gSQL> CREATE UNIQUE INDEX idx_t1_id ON t1( id );  
Index created.
```

The following is an example of creating an index for multiple columns.

```
gSQL> CREATE INDEX idx_t1_id_name ON t1( id, name );  
Index created.
```

The following is an example of specifying the sort order of the index column.

```
gSQL> CREATE INDEX idx_t1_dept_id ON t1( dept_id DESC );  
Index created.
```

The following is an example of specifying the sort order of NULL value of the index column.

```
gSQL> CREATE INDEX idx_t1_name ON t1( name NULLS FIRST );  
Index created.
```

The following is an example of setting information about the space in which index is stored.

```
gSQL> CREATE INDEX idx_t1_id ON t1( id )  
          STORAGE ( INITIAL 10M NEXT 1M MINSIZE 10M MAXSIZE 100M );  
Index created.
```

The following is an example of creating the redo logging for the index.

```
gSQL> CREATE INDEX idx_t1_id ON t1( id ) LOGGING;  
Index created.
```

The following is an example of creating the index with parallel option.

```
gSQL> CREATE INDEX idx_t1_name ON t1( name ) PARALLEL;  
Index created.
```

The following is an example of specifying the tablespace when creating an index.

```
gSQL> CREATE INDEX idx_t1_name ON t1( name ) NOLOGGING TABLESPACE mem_temp_tbs;  
Index created.
```

Compatibility

The SQL standard does not cover the concepts of the index.

For more information

Refer to **DROP INDEX**.

16.81 CREATE PROFILE

Function

It is the statement which creates the profile, and it sets the password management method. When a profile is allocated to a user, the user's password is managed in the way defined in the profile.

Syntax

```

<profile definition> ::=
    CREATE PROFILE profile_name LIMIT
    { <password_parameters>, ... }
    ;

<password parameters> ::=
    FAILED_LOGIN_ATTEMPTS { integer | UNLIMITED | DEFAULT }
    | PASSWORD_LOCK_TIME { password_parameter_number_interval | UNLIMITED | DEFAULT }
    | PASSWORD_LIFE_TIME { password_parameter_number_interval | UNLIMITED | DEFAULT }
    | PASSWORD_GRACE_TIME { password_parameter_number_interval | UNLIMITED | DEFAULT }
    | PASSWORD_REUSE_MAX { integer | UNLIMITED | DEFAULT }
    | PASSWORD_REUSE_TIME { password_parameter_number_interval | UNLIMITED | DEFAULT }
    | PASSWORD_VERIFY_FUNCTION { <verify_policy> | NULL | DEFAULT }

<verify_policy> ::=
    KISA_VERIFY_FUNCTION
    | ORA12C_VERIFY_FUNCTION
    | ORA12C_STRONG_VERIFY_FUNCTION
    | VERIFY_FUNCTION_11G
    | VERIFY_FUNCTION

<password_parameter_number_interval> ::=
    integer
    | integer / integer
  
```

Invocation and Access Rules

CREATE PROFILE ON DATABASE privilege is required to perform <profile definition>.

Syntax Rules and Parameters

profile_name

It specifies the profile name to be created.

password_parameters

It sets the parameters for password management.

- The following parameters are to be set.
 - FAILED_LOGIN_ATTEMPTS
 - PASSWORD_LOCK_TIME
 - PASSWORD_LIFE_TIME
 - PASSWORD_GRACE_TIME
 - PASSWORD_REUSE_MAX
 - PASSWORD_REUSE_TIME
 - PASSWORD_VERIFY_FUNCTION

The omitted parameters follows the "DEFAULT" profile policy.

FAILED_LOGIN_ATTEMPTS

It sets the number of consecutive login attempts allowed to fail.

If the failed attempts exceed the specified number, the account is locked.

- FAILED_LOGIN_ATTEMPTS integer
 - The value range should be a positive integer bigger than 0.
- FAILED_LOGIN_ATTEMPTS UNLIMITED
 - Account lockout which is due to a login failure does not occur.
- FAILED_LOGIN_ATTEMPTS DEFAULT
 - It follows the "DEFAULT" profile policy.

PASSWORD_LOCK_TIME

It sets the period (days) which the account is locked after consecutive login failure.

- PASSWORD_LOCK_TIME constant_expression
 - It is the lock duration (day).
 - The default unit is a day.
 - Hours(n/24), minutes (n/1440), seconds (n/86400) can be specified for testing.

- The value range is from one second (1/86400) to 100,000 days.
- PASSWORD_LOCK_TIME UNLIMITED
 - If an account lockout occurs, the lock is not release until performing ALTER USER user_name ACCOUNT UNLOCK statement.
- PASSWORD_LOCK_TIME DEFAULT
 - It follows the "DEFAULT" profile policy.

PASSWORD_LIFE_TIME

It sets the life time of the password (day).

- PASSWORD_LIFE_TIME constant_expression
 - It is the life time of the password (day).
 - The default unit is a day.
 - Hours(n/24), minutes (n/1440), seconds (n/86400) can be specified for testing.
 - The value range is from one second (1/86400) to 100,000 days.
- PASSWORD_LIFE_TIME UNLIMITED
 - The password does not have the expiration date.
- PASSWORD_LIFE_TIME DEFAULT
 - It follows the "DEFAULT" profile policy.

PASSWORD_GRACE_TIME

It sets the grace period of password expiration when logging in after PASSWORD_LIFE_TIME.

- PASSWORD_GRACE_TIME constant_expression
 - The grace period for password expiration (day)
 - The default unit is a day.
 - Hours (n/24), minutes (n/1440), seconds (n/86400) can be specified for testing.
 - The value range is from one second (1/86400) to 100,000 days.
- PASSWORD_GRACE_TIME UNLIMITED
 - It continues to defer the password expiration.
- PASSWORD_GRACE_TIME DEFAULT
 - It follows the "DEFAULT" profile policy.

PASSWORD_GRACE_TIME starts at first login trial after the password life time. If the password is not altered during the grace period, the password expires.

PASSWORD_REUSE_MAX

It sets the number of the recent passwords which can not be reused when the user wants to reuse the old password.

PASSWORD_REUSE_MAX should be used together with PASSWORD_REUSE_TIME.

- PASSWORD_REUSE_MAX integer
 - The value range should be a positive integer bigger than 0.
- PASSWORD_REUSE_MAX UNLIMITED
 - If PASSWORD_REUSE_TIME is UNLIMITED, all old passwords can be reused.
 - If PASSWORD_REUSE_TIME is not UNLIMITED, any old password can not be reused.
- PASSWORD_REUSE_MAX DEFAULT
 - It follows the "DEFAULT" profile policy.

PASSWORD_REUSE_TIME

It sets the duration which the password can not be reused when the user wants to reuse the old password.

PASSWORD_REUSE_TIME should be used together with PASSWORD_REUSE_MAX.

- PASSWORD_REUSE_TIME constant_expression
 - It is the duration which the password can not be reused. (day)
 - The default unit is a day.
 - Hours(n/24), minutes (n/1440), seconds (n/86400) can be specified for testing.
 - The value range is from one second (1/86400) to 100,000 days.
- PASSWORD_REUSE_TIME UNLIMITED
 - If PASSWORD_REUSE_MAX is UNLIMITED, all old passwords can be reused.
 - If PASSWORD_REUSE_MAX is not UNLIMITED, any old password can not be reused.
- PASSWORD_REUSE_TIME DEFAULT
 - It follows the "DEFAULT" profile policy.

PASSWORD_VERIFY_FUNCTION

It sets the password complexity verification methods.

- PASSWORD_VERIFY_FUNCTION null
 - The password complexity verification is not performed.
- PASSWORD_VERIFY_FUNCTION DEFAULT
 - It follows the "DEFAULT" profile policy.
- PASSWORD_VERIFY_FUNCTION <verify policy>
 - The password complexity verification methods can be specified as follows.

- KISA_VERIFY_FUNCTION
- ORA12C_VERIFY_FUNCTION
- ORA12C_STRONG_VERIFY_FUNCTION
- VERIFY_FUNCTION_11G
- VERIFY_FUNCTION

KISA_VERIFY_FUNCTION

It is the password verification method of KISA (Korea Internet & Security Agency).

- 8 or more letters
- One or more characters
- One or more numbers
- One or more special characters

ORA12C_VERIFY_FUNCTION

It is the password verification method of Oracle, ORA 12C VERIFY_FUNCTION.

- 8 or more letters
- 1 or more characters
- 1 or more numbers
- The database name should not be included.
- The username or the reversed username should not be included.
- *goldilocks* should not be included.
- *oracle* should not be included.
- The following simple passwords are not allowed.
 - welcome1, database1, account1, user1234, password1, oracle123, computer1, abcdefg1, change_on_intall
- At least 3 characters of the new password should be different from the old password.

ORA12C_STRONG_VERIFY_FUNCTION

It is the password verification method of Oracle, ORA12C_STRONG_VERIFY_FUNCTION.

- 9 or more letters
- 2 or more uppercases
- 2 or more lowercases
- 2 or more numbers
- 2 or more special characters
- At least 4 characters of the new password should be different from the old password.

VERIFY_FUNCTION_11G

It is the password verification method of Oracle, VERIFY_FUNCTION_11G.

- 8 or more letters
- 1 or more characters
- 1 or more numbers
- The username should not be included.
- At least 3 characters of the new password should be different from the old password.

VERIFY_FUNCTION

It is the password verification method of Oracle, VERIFY_FUNCTION.

- It should not be as same as the username.
- 4 or more letters
- 1 or more characters
- 1 or more numbers
- 1 or more special characters
- The following simple passwords are not allowed.
 - welcome, database, account, user, password, oracle, computer, abcd
- At least 3 characters of the new password should be different from the old password.

Description

Account Lockout

The followings are the parameters affecting the account lockout.

- FAILED_LOGIN_ATTEMPTS
- PASSWORD_LOCK_TIME

For example, when a user and a profile are created as follows

```
CREATE PROFILE prof LIMIT
  FAILED_LOGIN_ATTEMPTS 4
  PASSWORD_LOCK_TIME 30;
ALTER USER u1 PROFILE prof;
```

If the user u1 fails to log in more than four times, the account is locked for 30 days. Then the account lockout is released after 30 days.

If `PASSWORD_LOCK_TIME` is `UNLIMITED`, the account lockout should be explicitly released by using `ALTER USER` statement.

```
ALTER USER user1 ACCOUNT UNLOCK;
```

Password Expiration

The followings are the parameters affecting the password expiration.

- `PASSWORD_LIFE_TIME`
- `PASSWORD_GRACE_TIME`

The password is expired in the following order.

1. The password is set.
 - The time of the password expiration is set to the time elapsed as much as `PASSWORD_LIFE_TIME` since when a password is altered.
 - The password expiration status is `OPEN`, and it allows a normal login.
2. When a user logs in after the password expiration
 - The login succeeds but the password expiration status becomes `EXPIRED (GRACE)` and the following warnings occur.
 - `ERR-28000(16310)`: The password will expire in n days
 - `ERR-28000(16311)`: The password will expire soon
 - The SQL standard does not cover the concepts of password expiration.
 - 28000 is the authentication warning or SQL standard status code of an error. 16310, 16311 are the `GOLDILOCKS` error code.
 - The time of the password expiration is reset to the time elapsed as much as `PASSWORD_GRACE_TIME` since when a user logged in.
3. When a user logs in after the grace time
 - The password expiration status becomes `EXPIRED`, the user can not log in, and the following error occurs.
 - `ERR-28000(16312)`: The password has expired
 - The SQL standard does not cover the concepts of password expiration.
 - 28000 is the authentication warning or SQL standard status code of an error. 16312 is the `GOLDILOCKS` error code.
 - `GOLDILOCKS` internal error code of 16312 should be used to control password reentering using program.

Table 16-24 Password expiration status transition

Step	Point of time	login	Status
1	The password is changed.	Success	OPEN

Step	Point of time	login	Status
2	PASSWORD_LIFE_TIME is elapsed.	Success with warning	EXPIRED(GRACE)
3	PASSWORD_GRACE_TIME is elapsed.	Error	EXPIRED

The following is another example.

```
CREATE PROFILE prof LIMIT
  PASSWORD_LIFE_TIME 90
  PASSWORD_GRACE_TIME 3;
ALTER USER u1 PROFILE prof;
```

The example above describes that the user u1 succeeds in login after 90 days of password expiration. However, the user receives a warning that the password expires in three days.

If the password is not changed within three days, the password expires.

Once the password expires, it reminds that the new password should be entered when logging in, and the account access is denied.

Password Reusability

The followings are the parameters affecting the password reusability.

- PASSWORD_REUSE_MAX
- PASSWORD_REUSE_TIME

The password reusability of the two parameters above are determined according to the following table.

Table 16-25 Conditions for the password reusability

PASSWORD_REUSE_MAX	PASSWORD_REUSE_TIME	Reusable condition
value	value	It can be reused when both conditions of PASSWORD_REUSE_TIME and PASSWORD_REUSE_MAX are satisfied.
value	UNLIMITED	It can not be reused.
UNLIMITED	value	It can not be reused.
UNLIMITED	UNLIMITED	It can always be reused.

If a profile is created as follows,

```
CREATE PROFILE prof LIMIT
  PASSWORD_REUSE_MAX 5
  PASSWORD_REUSE_TIME 3;
```

the password can not be reused if it is the five recent passwords or the password changed within three d

ays.

The following is an example of the user u1's password change history. If the current password is P # _000 007 and the current date is 2015-08-08, the reusability of existing passwords is as follows.

Table 16-26 Examples of password reusability

Password	Password_date	Password reusability
P#_000001	2015-08-01	It can be reused.
P#_000002	2015-08-02	It can be reused.
P#_000003	2015-08-03	It violates REUSE_MAX.
P#_000004	2015-08-04	It violates REUSE_MAX.
P#_000005	2015-08-05	It violates REUSE_MAX, REUSE_TIME.
P#_000006	2015-08-06	It violates REUSE_MAX, REUSE_TIME.
P#_000007	2015-08-07	It violates REUSE_MAX, REUSE_TIME.

The password change history accumulated for checking the password reusability can be deleted by using the following statement.

```
ALTER DATABASE CLEAR PASSWORD HISTORY;
```

DEFAULT profile

When creating the database, the following "DEFAULT" profile is automatically created. The password parameters of the "DEFAULT" profile are as follows.

Table 16-27 Configuration of DEFAULT profile

Parameter	Value
FAILED_LOGIN_ATTEMPTS	10
PASSWORD_LOCK_TIME	1
PASSWORD_LIFE_TIME	180
PASSWORD_GRACE_TIME	7
PASSWORD_REUSE_MAX	UNLIMITED
PASSWORD_REUSE_TIME	UNLIMITED
PASSWORD_VERIFY_FUNCTION	NULL

The default values of "DEFAULT" profile have the following characteristics.

- Account lockout
 - The account is locked for one day (PASSWORD_LOCK_TIME) after ten consecutive login failure (FAILED_LOGIN_ATTEMPTS).
- Password expiration
 - The password expires after the grace period of seven days (PASSWORD_GRACE_TIME) after 180

days (PASSWORD_LIFE_TIME) are exceeded.

- Password reusability
 - The old password can be reused.
- Password complexity verification
 - It is not performed.

DEFAULT profile can not be dropped but it can be altered as follows.

```
ALTER PROFILE DEFAULT LIMIT ...
```

Examples

The following is an example of creating the profile to control the account lockout. The account is locked for three days after three consecutive login failures.

```
gSQL> CREATE PROFILE prof1 LIMIT
      FAILED_LOGIN_ATTEMPTS 3
      PASSWORD_LOCK_TIME 3;
```

Profile created.

```
gSQL> COMMIT;
```

Commit complete.

The following is an example of creating the profile to control the password expiration. The life time of the password is 90 days, and the grace time of the password is seven days.

```
gSQL> CREATE PROFILE prof1 LIMIT
      PASSWORD_LIFE_TIME 90
      PASSWORD_GRACE_TIME 7;
```

Profile created.

```
gSQL> COMMIT;
```

Commit complete.

The following is an example of creating the profile to control whether the password is reusable. The following example does not verify the old password when changing the password.

```
gSQL> CREATE PROFILE prof1 LIMIT
      PASSWORD_REUSE_MAX DEFAULT
      PASSWORD_REUSE_TIME DEFAULT;
```

Profile created.

```
gSQL> COMMIT;
```

Commit complete.

The following is an example of creating the profile to control the password complexity check.

```
gSQL> CREATE PROFILE prof1 LIMIT
        PASSWORD_VERIFY_FUNCTION KISA_VERIFY_FUNCTION;
Profile created.
gSQL> COMMIT;
Commit complete.
```

The following is an example of creating the profile by setting all parameter.

```
gSQL> CREATE PROFILE prof1 LIMIT
        FAILED_LOGIN_ATTEMPTS 3
        PASSWORD_LOCK_TIME 3
        PASSWORD_LIFE_TIME 90
        PASSWORD_GRACE_TIME 7
        PASSWORD_REUSE_MAX DEFAULT
        PASSWORD_REUSE_TIME DEFAULT
        PASSWORD_VERIFY_FUNCTION KISA_VERIFY_FUNCTION;
Profile created.
gSQL> COMMIT;
Commit complete.
```

Compatibility

The SQL standard does not cover the concepts of the profile.

For More Information

Refer to the followings.

- DROP PROFILE
- ALTER PROFILE
- CREATE USER
- ALTER USER
- ALTER DATABASE CLEAR PASSWORD HISTORY

16.82 CREATE SCHEMA

Function

It defines the schema.

Syntax

```

<schema definition> ::=
    CREATE SCHEMA <schema name clause>
        [ <schema element> [...] ]
    ;
<schema name clause> ::=
    schema_name
    | AUTHORIZATION user_identifier
    | schema_name AUTHORIZATION user_identifier
<schema element> ::=
    <table definition>
    | <view definition>
    | <index definition>
    | <sequence generator definition>
    | <grant privilege statement>
    | <comment statement>

```

Invocation and Access Rules

The user should satisfy the following conditions to perform <schema definition>.

- CREATE SCHEMA ON DATABASE privilege is required to create the schema.
- If <schema element> exists, the privilege to perform each <schema element> is required. For more information about the access privilege, refer to *invocation and access rules* in the following statements.
 - CREATE TABLE
 - CREATE VIEW
 - CREATE INDEX

- **CREATE SEQUENCE**
 - **GRANT privileges TO**
 - **COMMENT ON name IS**
- The user who is `user_identifier` has the following privileges for the created schema.
 - The owner of the created schema, which is `schema_name`
 - The owner of the object which is created by `<schema element>` clause
 - An appropriate privilege for the schema is required to create an object because a separate privilege on the created schema is not granted.
 For more information about schema privilege types, refer to `<schema privilege>` of GRANT privileges TO statement.
 For more information about usage example, refer to **Examples** of CREATE USER statement.

Syntax Rules and Parameters

`schema_name`

It is the schema name to be created.

An identical schema name should not exist in the database.

The length of the schema name should be shorter than 128 bytes.

AUTHORIZATION user_identifier

If the schema name is omitted, a schema with the same name as the `user_identifier` is created.

If the **AUTHORIZATION** is not specified, the `user_identifier` of the user performing the statement is used.

`schema_name AUTHORIZATION user_identifier`

It specifies the schema name and schema owner to be created.

The owner can not be a role or PUBLIC.

`<schema element>`

It defines the objects to be created in the schema along with the schema creation.

The `schema_element` is executed in the listed order, and they are separated by a white space without a comma (,).

The object can not be defined in a schema which has different name from the schema to be created.

- The <grant privilege statement> can be specified only for the following privileges.
 - <schema privilege>
 - <table privilege>
 - <sequence privilege>
- The <comment statement> can be specified only for the following objects.
 - SCHEMA schema_name
 - TABLE [schema_name].table_name
 - COLUMN [schema_name].table_name.column_name
 - INDEX [schema_name].index_name
 - SEQUENCE [schema_name].sequence_name
 - CONSTRAINT [schema_name].constraint_name

Description

A schema is an object which logically classifies SQL schema objects such as table, view, index, sequence and constraint.

In GOLDILOCKS, the relationship between the user and the schema is 1 : N. In other words, the schema owned by a user may not exist, or the user may own multiple schemas.

The SQL standard does not explicitly define the relationship of the non-schema objects such as user, schema, database, but each DBMS defines the relationship between the non-schema objects as a different concept. Refer to the following note.



The relationship between user and schema in other DBMS

- Oracle
 - User : schema = 1 : 1
- DB2
 - User : schema = 1 : N
- Postgres
 - User : schema = 1 : N

- MySQL
 - Database : schema = 1 : 1
 - User is a subordinate object of a database (schema).

Examples

The following is an example of creating a schema.

```
gSQL> CREATE SCHEMA s1;
Schema created.
```

The following is an example of creating a schema and assigning the schema owner.

```
gSQL> CREATE SCHEMA s1 AUTHORIZATION test;
Schema created.
```

The following is an example of creating a schema together with the objects which belong to the schema.

```
gSQL> CREATE SCHEMA s1
      CREATE TABLE t1 ( id INTEGER, name VARCHAR(128) )
      CREATE INDEX idx_t1_id ON t1 ( id )
      COMMENT ON TABLE t1 IS 'comment on s1.t1'
;
Schema created.
```

Compatibility

Table 16-28 SQL standard compatibility

Feature ID	Description	Compatibility
S071	SQL paths in function and type name resolution	X
F461	Named character sets	X
F171	Multiple schemas per user	O
T332	Extended roles	X

For More Information

Refer to the followings.

- DROP SCHEMA
- CREATE USER
- CREATE TABLE
- CREATE VIEW
- CREATE INDEX
- CREATE SEQUENCE
- GRANT privileges TO
- COMMENT ON name IS

16.83 CREATE SEQUENCE

Function

It creates a sequence.

Syntax

```

<sequence generator definition> ::=
    CREATE SEQUENCE [schema_name.] sequence_name
        [ <sequence generator option> [, ...] ]
    ;
<sequence generator option> ::=
    <sequence generator start with option>
    | <basic sequence generator option>
<sequence generator start with option> ::=
    START WITH integer
<basic sequence generator option> ::=
    <sequence generator increment by option>
    | <sequence generator maxvalue option>
    | <sequence generator minvalue option>
    | <sequence generator cycle option>
    | <sequence generator cache option>
<sequence generator increment by option> ::=
    INCREMENT BY integer
<sequence generator maxvalue option> ::=
    MAXVALUE integer
    | (NO MAXVALUE | NOMAXVALUE)
<sequence generator minvalue option> ::=
    MINVALUE integer
    | (NO MINVALUE | NOMINVALUE)
<sequence generator cycle option> ::=
    CYCLE
    | (NO CYCLE | NOCYCLE)
<sequence generator cache option> ::=
    CACHE integer
    | (NO CACHE | NOCACHE)

```

Invocation and Access Rules

The user should have one of the following privileges to perform `<sequence generator definition>` statement.

- (CREATE SEQUENCE or CONTROL SCHEMA) ON SCHEMA for the schema to which the sequence belongs
- CREATE ANY SEQUENCE ON DATABASE

The sequence owner is determined as follows.

- The owner of the schema to which the sequence belongs
- If the schema to which the sequence belongs is PUBLIC, then it is the user who executed the statement.

The sequence owner has USAGE ON SEQUENCE WITH GRANT OPTION privilege.

One of the following privileges is required to use the created sequence.

- USAGE ON SEQUENCE for the sequence
- (USAGE SEQUENCE or CONTROL SCHEMA) ON SCHEMA for the schema to which the sequence belongs
- USAGE ANY SEQUENCE ON DATABASE

Syntax Rules and Parameters

`sequence_name`

It is the sequence name to be created, and it should be a unique name within the schema.

The schema to which the sequence belongs, such as `schema_name.sequence_name`, can be defined. If `schema_name` is omitted, the default schema name of the user performing the statement is used.

The length of the sequence name should be shorter than 128 bytes.

`<sequence generator option>`

If any of `<sequence generator option>` is not used, the following two statements have the same meaning.

- CREATE SEQUENCE test_seq;
- CREATE SEQUENCE test_seq START WITH 1 INCREMENT BY 1 NO MINVALUE NO MAXVALUE NO CYCLE CACHE 20;

⟨sequence generator start with option⟩

It defines the first sequence number to be generated.

Depending on the ascending or the descending order, it has the following features.

- Ascending sequence (INCREMENT BY a positive number)
 - It is used when starting the sequence with bigger sequence value than the minimum value.
 - If START WITH clause is omitted, the default value is the minimum value (MINVALUE value).
- Descending sequence (INCREMENT BY a negative number)
 - It is used when starting the sequence with smaller sequence value than the maximum value.
 - If START WITH clause is omitted, the default value is the maximum value (MAXVALUE value).

⟨sequence generator increment by option⟩

It defines the interval of sequence numbers.

The constraints and features are as follows.

- A positive number or a negative number is allowed, but 0 is not allowed.
- The absolute value of the interval should be smaller than the difference between MINVALUE and MAXVALUE.
- The ascending sequence is generated if it is a positive number, and the descending sequence is generated if it is a negative number.
- If INCREMENT BY clause is omitted, the default is a positive number 1.

⟨sequence generator maxvalue option⟩

It defines the maximum value of which the sequence can generate.

- MAXVALUE integer
 - The maximum value range is between the minimum (-9,223,372,036,854,775,808) and the maximum (+9,223,372,036,854,775,807) of the 64 bit integer.
 - It should be equal to or bigger than START WITH value, and bigger than MINVALUE value.
- NO MAXVALUE | NOMAXVALUE
 - The maximum value is defined as follows.
 - If it is an ascending sequence, it is the maximum value (+9,223,372,036,854,775,807) of the 64 bit integer.
 - If it is a descending sequence, it is -1.
 - NO MAXVALUE (SQL standard) and NOMAXVALUE are the reserved words with the same meaning, so either of them can be used.
- If MAXVALUE and NO MAXVALUE are not specified, the default value is NO MAXVALUE.

⟨sequence generator minvalue option⟩

It defines the minimum value of which the sequence can generate.

- MINVALUE integer
 - The minimum value range is between the minimum (-9,223,372,036,854,775,808) and the maximum (+9,223,372,036,854,775,807) of the 64 bit integer.
 - It should be equal to or smaller than START WITH value, and smaller than MAXVALUE.
- NO MINVALUE | NOMINVALUE
 - The minimum value is defined as follows.
 - If it is an ascending sequence, it is 1.
 - If it is a descending sequence, it is the minimum value (-9,223,372,036,854,775,808) of the 64 bit integer.
 - NO MINVALUE(SQL standard) and NOMINVALUE are the reserved words with the same meaning, so either of them can be used.
- If MINVALUE and NO MINVALUE are not specified, the default value is NO MINVALUE.

⟨sequence generator cycle option⟩

It specifies whether to continue generating a value when the sequence value becomes the maximum value or the minimum value.

- CYCLE
 - When the ascending sequence becomes the maximum value, it generates the value again from the minimum value.
 - When the descending sequence becomes the minimum value, it generates the value again from the maximum value.
- NO CYCLE | NOCYCLE
 - When the sequence value becomes the maximum value or the minimum value, it does not generate a sequence value.
 - NO CYCLE(SQL standard) and NOCYCLE are the reserved words with the same meaning, so either of them can be used.
- If CYCLE and NO CYCLE are not specified, the default value is NO CYCLE.

⟨sequence generator cache option⟩

For quick access of a sequence, it defines the number of the sequence values to be preloaded in memory. When restarting database, the sequence values loaded in memory are lost, and it starts from the value since being loaded.

- CACHE integer
 - CACHE value should be equal to or bigger than 2.

- CACHE value should not be bigger than CYCLE length, if CYCLE exists.
 - CYCLE length: $\text{CEIL}(\text{MAXVALUE} - \text{MINVALUE}) / \text{ABS}(\text{INCREMENT})$
- NO CACHE | NOCACHE
 - The sequence values are not preloaded in memory.
- If CACHE and NO CACHE are not specified, the default value is CACHE 20.

Description

The sequence values of the created sequence objects are used by using **NEXTVAL** and **CURRVAL** functions.

The sequence value does not have a transaction property. The sequence value maintains the most recent value, even when an error occurs in the SQL statement in which the sequence function is used or when an explicit ROLLBACK is performed.

CURRVAL function returns NEXTVAL value from the most recent call by a session.

Therefore, using this feature, the sequence value obtained by NEXTVAL can still be usable in the other SQL statements. However, when the session does not call NEXTVAL, using CURRVAL function generates an error.

Examples

The object seq1 without the defined sequence options is an ascending sequence of the same meanings as the object seq2 in the following example.

```
gSQL> CREATE SEQUENCE seq1;  
Sequence created.  
gSQL> CREATE SEQUENCE seq2 START WITH 1 INCREMENT BY 1 NO MINVALUE NO MAXVALUE NO CYCLE CACHE  
20;  
Sequence created.
```

The following is an example of a sequence which generates an odd value.

```
gSQL> CREATE SEQUENCE seq1 START WITH 1 INCREMENT BY 2;  
Sequence created.
```

The following is an example of generating sequence which repeatedly generates an even number starting from 0 to 1000.

```
gSQL> CREATE SEQUENCE seq1 START WITH 0 MINVALUE 0 MAXVALUE 1000 INCREMENT BY 2 CYCLE;  
Sequence created.
```

The following is an example of generating a descending sequence starting from -1.

```
gSQL> CREATE SEQUENCE seq1 INCREMENT BY -1;  
Sequence created.
```

Compatibility

The SQL standard does not define <sequence generator cache option> clause.

Table 16-29 SQL standard compatibility

Feature ID	Description	Compatibility
T176	Sequence generator support	O

For More Information

Refer to the followings.

- DROP SEQUENCE
- ALTER SEQUENCE
- NEXTVAL
- CURRVAL

16.84 CREATE SYNONYM

Function

It creates a synonym. A synonym is an alternative name for a table, view, sequence, or another synonym, and it can be used in the following statements.

- DML: SELECT, INSERT, UPDATE, DELETE, LOCK TABLE, CALL
- DDL: GRANT, REVOKE, COMMENT

Syntax

```
<table definition> ::=  
    CREATE [OR REPLACE] [PUBLIC] SYNONYM [schema_name.]synonym_name  
    FOR [schema_name.]object_name  
    ;
```

Invocation and Access Rules

The user should satisfy the following conditions to perform <synonym definition> statement.

- CREATE PUBLIC SYNONYM ON DATABASE privilege is required to create public synonym by explicitly specifying PUBLIC.
- The owner of public synonym is PUBLIC. The user who created the synonym does not have any privilege.
- One of the following privileges is required to create the private synonym.
 - (CREATE SYNONYM or CONTROL SCHEMA) ON SCHEMA for that schema
 - CREATE ANY SYNONYM ON DATABASE
- The private synonym owner is determined as follows.
 - The owner of the schema to which the private synonym belongs
 - If the schema to which the private synonym belongs is PUBLIC, then it is the user who executed the statement.
- If the user does not have privilege on the base object, the user is not allowed to execute the statement.

nt using its synonym even when the user created the synonym.

- Be cautious when allowing the privilege on the synonym because it means allowing privilege on the base object to which the synonym indicates.

Syntax Rules and Parameters

[OR REPLACE]

It replaces the existing synonym If the synonym already exists.

[PUBLIC]

It is specified when creating public synonym.

If it is omitted, private synonym is created.

synonym_name

It is the synonym name to be created, and it should be a unique name within the schema.

The schema to which the synonym belongs, such as schema_name.synonym_name, can be defined. If schema_name is omitted, default schema name of the user performing the statement is used.

The length of the synonym name should be shorter than 128 bytes.

Public synonym is a non-schema object. Therefore, a schema name can not be specified when creating public synonym by explicitly specifying PUBLIC.

object_name

The schema to which the object belongs, such as schema_name.object_name, can be defined. If schema_name is omitted, default schema name of the user performing the statement is used.

The object types which can specify the object_name are as follows.

- Table
- View
- Sequence
- Another synonym

Existence of the target object, cycle check and privilege check are performed when executing the statement using the synonym.

Description

A synonym is an alternative name for a table, view, sequence, or another synonym.

If a synonym is created, the applications does not need to be modified even when the base object is changed instead only the synonyms should be redefined. Therefore, it is convenient.

Also, the database security is improved by hiding the objects' real names and their schemas, and the usability is enhanced by changing the object's long name to a shorter name.

The synonym is literally an alternative name so creating the synonym does not mean that the synonym can be used to access the object. The proper privilege is required to access the object.

When executing the statement using the synonym, the object access procedure is as follows.

1. Find a table of the corresponding name.
2. If the table does not exist, find the private synonym of the corresponding name.
3. If the private synonym does not exist, find the public synonym of the corresponding name.

```
gSQL> CREATE PUBLIC SYNONYM syn1 FOR u1.t1;
Synonym created.
gSQL> CREATE PUBLIC SYNONYM syn2 FOR syn1;
Synonym created.
gSQL> SELECT * FROM syn2;
```

The example above is the object access procedure in SELECT statement.

1. It searched for the table syn2, but it does not exist.
2. It searched for the private synonym syn2, but it does not exist.
3. It searched for the public synonym syn2, and it exists.
 - I. It searched for the table syn1, but it does not exist.
 - II. It searched for the private synonym syn1, but it does not exist.
 - III. It searched for the public synonym syn2, and it exists.
 - i. It searched for the table u1.t1, and it exists.

Examples

The following is an example of creating a private synonym.

```
gSQL> CREATE SYNONYM MyEmp FOR branch.Employee;
Synonym created.
```

```
gSQL> SELECT * FROM MyEmp;
```

The following is an example of creating a public synonym.

```
gSQL> CREATE PUBLIC SYNONYM MainEmp FOR main.Employee;  
Synonym created.  
gSQL> SELECT * FROM MainEmp;
```

Compatibility

The SQL standard does not define the CREATE SYNONYM statement.

For More Information

Refer to [DROP SYNONYM](#).

16.85 CREATE TABLE

Function

It defines a table.

Syntax

```

<table definition> ::=
    CREATE TABLE table_name
        ( <table element> [, ...] )
        [ <table sharding strategy> ]
        [ <table attribute clause> [...] ]
        [ TABLESPACE tablespace_name ]
        [ <table global secondary index clause> ]
    ;
<table element> ::=
    <column definition>
    | <table constraint definition>
<column definition> ::=
    column_name <data type>
        [ <default clause> | <identity column specification> ]
        [ <column constraint definition> ]
<data type> ::=
    <character string type>
    | <binary string type>
    | <numeric type>
    | <boolean type>
    | <datetime type>
    | <interval type>
<character string type> ::=
    CHARACTER [ ( integer [ <character length units> ] ) ]
    | CHAR [ ( integer [ <character length units> ] ) ]
    | CHARACTER VARYING ( integer [ <character length units> ] )
    | CHAR VARYING ( integer [ <character length units> ] )
    | VARCHAR ( integer [ <character length units> ] )
    | CHARACTER LONG VARYING

```



```
| LONG VARCHAR
```

```
<character length units> ::=
```

```
    CHARACTERS
```

```
    | CHAR
```

```
    | OCTETS
```

```
    | BYTE
```

```
<binary string type> ::=
```

```
    BINARY [ ( length ) ]
```

```
    | BINARY VARYING ( length )
```

```
    | VARBINARY ( length )
```

```
    | LONG BINARY VARYING
```

```
    | LONG VARBINARY
```

```
<numeric type> ::=
```

```
    <exact numeric type>
```

```
    | <approximate numeric type>
```

```
    | <native numeric type>
```

```
<exact numeric type> ::=
```

```
    NUMERIC [ ( precision [ , scale ] ) ]
```

```
    | SMALLINT
```

```
    | INTEGER
```

```
    | INT
```

```
    | BIGINT
```

```
<approximate numeric type> ::=
```

```
    | FLOAT [ ( precision ) ]
```

```
    | REAL
```

```
    | DOUBLE PRECISION
```

```
<native numeric type> ::=
```

```
    NATIVE_SMALLINT
```

```
    | NATIVE_INTEGER
```

```
    | NATIVE_BIGINT
```

```
    | NATIVE_REAL
```

```
    | NATIVE_DOUBLE
```

```
<boolean type> ::=
```

```
    BOOLEAN
```

```
<datetime type> ::=
```

```
    DATE
```

```
    | TIME [ ( time_precision ) ] [ WITH TIME ZONE | WITHOUT TIME ZONE ]
```

```
    | TIMESTAMP [ ( timestamp_precision ) ] [ WITH TIME ZONE | WITHOUT TIME ZONE ]
```

```
<interval type> ::=
```

```
    INTERVAL <interval qualifier>
```

```

<interval qualifier> ::=
    <non-second primary datetime field> [ ( interval_leading_field_precision ) ]
        TO { <non-second primary datetime field> | SECOND [ (
interval_fractional_seconds_precision ) ] }
    | <non-second primary datetime field> [ ( interval_leading_field_precision ) ]
        | SECOND [ ( interval_leading_field_precision [, interval_fractional_seconds_precision ] )
]
<non-second primary datetime field> ::=
    YEAR
    | MONTH
    | DAY
    | HOUR
    | MINUTE
<default clause> ::=
    DEFAULT <default option>
<default option> ::=
    constant
    | NULL
    | expression
<identity column specification> ::=
    GENERATED { ALWAYS | BY DEFAULT } AS IDENTITY
    [ ( <common sequence generator option> [, ...] ) ]
<common sequence generator option> ::=
    START WITH integer_constant
    | <basic sequence generator option>
<basic sequence generator option> ::=
    INCREMENT BY integer_constant
    | { MAXVALUE integer_constant | NO MAXVALUE }
    | { MINVALUE integer_constant | NO MINVALUE }
    | { CYCLE | NO CYCLE }
    | { CACHE integer_constant | NO CACHE }
<column constraint definition> ::=
    [ CONSTRAINT constraint_name ] <column constraint> [ <constraint characteristics> ]
<column constraint> ::=
    NOT NULL
    | { UNIQUE | PRIMARY KEY } [ <index name clause> [ <index attributes> ] [ TABLESPACE
index_tablespace_name ] ]
<index name clause> ::=
    INDEX index_name
<index attributes> ::=
    <index physical attribute clause>

```

```

    | STORAGE ( <segment attr clause> [...] )
    | <logging clause>
<table constraint definition> ::=
    [ CONSTRAINT constraint_name ] <table constraint> [ <constraint characteristics> ]
<table constraint> ::=
    <unique constraint definition> [ <index name clause> [ <index attributes> ] [ TABLESPACE
index_tablespace_name ] ]
<unique constraint definition> ::=
    { UNIQUE | PRIMARY KEY } ( <key column element> [, ...] )
<key column element> ::=
    column_name [ ASC | DESC ] [ NULLS FIRST | NULLS LAST ]
<table sharding strategy> ::=
    <cloned strategy>
    | <hash sharding strategy>
    | <range sharding strategy>
    | <list sharding strategy>
<cloned strategy> ::=
    CLONED [ <clone placement> ]
<clone placement> ::=
    AT CLUSTER WIDE
    | AT CLUSTER GROUP group_list
<hash sharding strategy> ::=
    SHARDING BY [HASH] ( column_list )
    [ <hash shard count> ]
    [ <hash shard placement> ]
<hash shard count> ::=
    SHARD COUNT integer
<hash shard placement> ::=
    AT CLUSTER WIDE
    | AT CLUSTER GROUP group_list
<range sharding strategy> ::=
    SHARDING BY RANGE ( column_list )
    { <cluster-wide range shard placement> | <group-specific range shard placement> }
<cluster-wide range shard placement> ::=
    AT CLUSTER WIDE
    <range shard definition> [, ...]
<group-specific range shard placement> ::=
    <group-specific range shard definition> [, ...]
<group-specific range shard definition> ::=
    <range shard definition> AT CLUSTER GROUP group_name
<range shard definition> ::=

```

```

    SHARD range_name VALUES LESS THAN ( <range value clause> )
<range value clause> ::=
    <range value> [, ...]
<range value> ::=
    constant
    | MAXVALUE
<list sharding strategy> ::=
    SHARDING BY LIST ( column_name )
    { <cluster-wide list shard placement> | <group-specific list shard placement> }
<cluster-wide list shard placement> ::=
    AT CLUSTER WIDE
    <list shard definition> [, ...]
<group-specific list shard placement> ::=
    <group-specific list shard definition> [, ...]
<group-specific list shard definition> ::=
    <list shard definition> AT CLUSTER GROUP group_name
<list shard definition> ::=
    SHARD shard_name VALUES IN ( <list value clause> )
<list value clause> ::=
    <list value> [, ...]
<list value> ::=
    constant
    | NULL
    | DEFAULT
<table attribute clause> ::=
    [ <table physical attribute clause> ]
    | [ STORAGE ( <segment attr clause> [...] ) ]
<table physical attribute clause> ::=
    PCTFREE integer
    | PCTUSED integer
    | INITRANS integer
    | MAXTRANS integer
<index physical attribute clause> ::=
    PCTFREE integer
    | INITRANS integer
    | MAXTRANS integer
<segment attr clause> ::=
    INITIAL <size_clause>
    | NEXT <size_clause>
    | MINSIZE <size_clause>
    | MAXSIZE <size_clause>

```

```

<size clause> ::=
    integer [ K | M | G | T ]
<logging clause> ::=
    LOGGING
    | NOLOGGING
<constraint characteristics> ::=
    [ NOT ] DEFERRABLE [ <constraint check time> ]
    | <constraint check time> [ [ NOT ] DEFERRABLE ]
<constraint check time> ::=
    INITIALLY DEFERRED
    | INITIALLY IMMEDIATE
<table global secondary index clause> ::=
    WITH GLOBAL SECONDARY INDEX [ <index attributes> [...] ] [ TABLESPACE tablespace_name ]
    | WITHOUT GLOBAL SECONDARY INDEX

```

Invocation and Access Rules

The differences between the stand-alone database and the cluster database are as follows.

- Stand-alone
 - It can not define <table sharding strategy>.
 - It can not define <table global secondary index clause>.
- Cluster
 - Constraints of PRIMARY KEY, UNIQUE should include all sharding keys.
 - It can not define the deferrable constraints.

The user should satisfy the following conditions to perform <table definition> statement.

- One of the following privileges is required for the schema in which a table is to be created.
 - (CREATE TABLE or CONTROL SCHEMA) ON SCHEMA for that schema
 - CREATE ANY TABLE ON DATABASE
- One of the following privileges is required for the tablespace in which a table is to be created.
 - CREATE OBJECT ON TABLESPACE for that tablespace
 - USAGE TABLESPACE ON DATABASE
- One of the following privileges is required for the schema in which the constraints are to be created when the constraints exists which were created together.
 - (ADD CONSTRAINT or CONTROL SCHEMA) ON SCHEMA for that schema
 - ALTER ANY TABLE ON DATABASE

- One of the following privileges is required for the tablespace in which the index is to be created when the key constraint is created together.
 - CREATE OBJECT ON TABLESPACE for that tablespace
 - USAGE TABLESPACE ON DATABASE
- The owner of the table is determined as follows.
 - The owner of the schema to which the table belongs
 - If the schema to which the table belongs is PUBLIC, then it is the user who executed the statement.
- The table owner has the following privileges for the created table.
 - The privilege for the table
 - SELECT ON TABLE WITH GRANT OPTION
 - INSERT ON TABLE WITH GRANT OPTION
 - UPDATE ON TABLE WITH GRANT OPTION
 - DELETE ON TABLE WITH GRANT OPTION
 - TRIGGER ON TABLE WITH GRANT OPTION
 - REFERENCES ON TABLE WITH GRANT OPTION
 - LOCK ON TABLE WITH GRANT OPTION
 - INDEX ON TABLE WITH GRANT OPTION
 - ALTER ON TABLE WITH GRANT OPTION
 - The privilege for all columns in the table.
 - SELECT(columns) ON TABLE WITH GRANT OPTION
 - INSERT(columns) ON TABLE WITH GRANT OPTION
 - UPDATE(columns) ON TABLE WITH GRANT OPTION
 - REFERENCES(columns) ON TABLE WITH GRANT OPTION
 - The privilege for the constraint which was generated together
 - The owner of that constraint
 - The owner of the index which was generated together with the constraint

<table sharding strategy> statement can be used in a cluster system.

Syntax Rules and Parameters

table_name

It is the table name to be created and it should be a unique name within the schema.

The schema to which the table belongs, such as schema_name.table_name, can be defined. If schema_name is omitted, The default schema name of the user performing the statement is used.

The length of the table name should be shorter than 128 bytes.

⟨column definition⟩

It defines the columns which configure the table.

The table should include one or more column definitions.

It can specify the column data type, default value, automatically generated value, and constraints.

column_name

It is name of the column which configure a table and each column should have a unique name within the table.

The length of the column name should be shorter than 128 bytes.

⟨data type⟩

- ⟨character string type⟩
- ⟨binary string type⟩
- ⟨numeric type⟩
- ⟨exact numeric type⟩
- ⟨approximate numeric type⟩
- ⟨boolean type⟩
- ⟨datetime type⟩
- ⟨interval type⟩
- ⟨interval qualifier⟩
- ⟨non-second primary datetime field⟩

It defines the data type of the column.

When defining the column including automatically generated values(⟨identity column specification⟩), its data type should be one of SMALLINT, INTEGER or BIGINT.

For more information about data types, refer to **Data Type**.

⟨character length units⟩

It specifies the length unit of a single character for the character type.

- CHARACTERS/ CHAR assigns the maximum bytes of a single character as the length of a single character. Therefore, the length of multi-bytes single character such as Hangul is 1.
- OCTETS/ BYTE assigns one byte for the length of a single character. Therefore, the length of multi-bytes single character such as Hangul is multi-bytes.
- If it is omitted, it follows CHAR_LENGTH UNITS property which is used when creating the database.

SQL standard define CHARACTERS as a default value.



The default value of the char length unit in other DBMS are as follows.

- Oracle, DB2: OCTETS
- MS-SQL, MySQL, PostgreSQL: CHARACTERS

[<default clause> | <identity column specification>]

It specifies the default value of a column.

<default clause> and <identity column specification> can not be used together.

When both of them are omitted, the default value is NULL.

<default clause>

The DEFAULT clause defines the default value to be used when DEFAULT is specified in INSERT, UPDATE statements or the corresponding column name is omitted.

- When DEFAULT clause is used
 - e.g. CREATE TABLE t1 (id INTEGER, name VARCHAR(32) DEFAULT 'anonymous');
 - When the column is omitted
 - INSERT INTO t1(id) VALUES (1);
 - INSERT INTO t1(id) SELECT id FROM other_table;
 - When the DEFAULT is specified
 - INSERT INTO t1 DEFAULT VALUES;
 - INSERT INTO t1 VALUES (2, DEFAULT);
 - UPDATE t1 SET name = DEFAULT;

The data type of DEFAULT expression should be compatible with the data type of the column.

If the data type is not compatible or the space is insufficient, an error occurs when using DEFAULT in INSERT, UPDATE statements.

- CREATE TABLE t1 (user_name VARCHAR(1) DEFAULT CURRENT_USER);
- e.g. error: INSERT INTO t1 VALUES (DEFAULT);
- e.g. error: UPDATE t1 SET user_name = DEFAULT;

DEFAULT expression can use any built-in functions but it can not use the followings.

- Logical operators (AND, OR, NOT), comparison operators (=, >, ...)
- Stored function
- Column name
- Subquery expression

<identity column specification>

It defines a column which has automatically generated values.

The table can have only one identity column.

The identity column becomes *not nullable* column even though NOT NULL constraint is not specified.

<identity column specification> clause can not be specified together with DEFAULT clause.

<identity column specification> clause, like as DEFAULT clause, specifies DEFAULT in INSERT, UPDATE statements or it defines the default value to be used when the column name is omitted.

The generation method is defined as follows.

- GENERATED BY DEFAULT AS IDENTITY

A user defined value is applied if defined, but the value is automatically generated, like as DEFAULT clause, when the default value should be used.

- CREATE TABLE t1 (id INTEGER GENERATED BY DEFAULT AS IDENTITY, name VARCHAR(32));
- (O) INSERT INTO t1 VALUES (12345, 'GOLDILOCKS');
 - It inserts the user defined value (12345).
- (O) INSERT INTO t1(name) VALUES ('GOLDILOCKS');
 - It inserts the automatically generated value in an id column.
- (O) INSERT INTO t1(id, name) SELECT other_id, other_name FROM other_table;
 - It inserts the user defined value.
- (O) INSERT INTO t1(name) SELECT other_name FROM other_table;
 - It inserts the automatically generated value in an id column.
- (O) UPDATE t1 SET id = 10000 WHERE id = 12345;
 - It inserts the user defined value
- (O) UPDATE t1 SET id = DEFAULT WHERE id = 12345;
 - It inserts the automatically generated value in an id column.

- GENERATED ALWAYS AS IDENTITY

A user can not define the value and the default value should be generated like as DEFAULT clause.

- CREATE TABLE t1 (id INTEGER GENERATED ALWAYS AS IDENTITY, name VARCHAR(32));
- (X) INSERT INTO t1 VALUES (12345, 'GOLDILOCKS');
 - Error, a user can not define the value.
- (O) INSERT INTO t1(name) VALUES ('GOLDILOCKS');
 - It inserts the automatically generated value in an id column.
- (X) INSERT INTO t1(id, name) SELECT other_id, other_name FROM other_table;
 - Error, a user can not define the value.
- (O) INSERT INTO t1(name) SELECT other_name FROM other_table;
 - It inserts the automatically generated value in an id column.
- (X) UPDATE t1 SET id = 10000 WHERE id = 12345;

- Error, a user can not define the value.
- (O) UPDATE t1 SET id = DEFAULT WHERE id = 12345;
 - It inserts the automatically generated value in an id column.

For more information about <common sequence generator option> and <basic sequence generator option>, which is an option to create an identity column, refer to **CREATE SEQUENCE**.

<column constraint definition>

It defines the following constraints for a column.

- NOT NULL constraints
- UNIQUE constraints
- PRIMARY KEY constraints

constraint_name

It is the constraint name and it can be omitted.

If the constraint_name is omitted, it is automatically set as follows.

If the automatically generated name is duplicated, the constraint_name should be explicitly specified.

- NOT NULL constraints
 - "table_name" + "_" + "NOT_NULL" + "_" + "column_name"
- UNIQUE constraints
 - "table_name" + "_" + "UNIQUE" + "_" + "column_name"
- PRIMARY KEY constraints
 - "table_name" + "_" + "PRIMARY_KEY"

The length of the constraint name should be shorter than 128 bytes.

NOT NULL Constraint

NULL is not allowed for the column value.

UNIQUE Constraint

The identical value is not allowed for the column value, but NULL is allowed.

PRIMARY KEY Constraint

NULL or the identical value is not allowed as the column value. A single PRIMARY KEY constraint can be defined on a single table.

⟨index name clause⟩

It defines the index name to be created when defining UNIQUE constraint and PRIMARY KEY constraint.

- INDEX index_name
 - It defines the index name for the constraint.
 - It can not be used together with a schema name and it is created in the same schema where the constraint is created.

When defining UNIQUE constraint and PRIMARY KEY constraint, if INDEX clause is omitted, an index which satisfies the constraints is automatically created.

"constraint_name" + "INDEX" is added to the name of index which is automatically generated.

- ⟨index attributes⟩
 - It specifies the physical attributes of the index to be created.
 - For more information, refer to **CREATE INDEX**.
- TABLESPACE index_tablespace_name
 - It specifies the tablespace where the index is to be created.
 - For more information, refer to **CREATE INDEX**.

⟨table constraint definition⟩

⟨unique constraint definition⟩

- When defining a table, the constraints can be classified in two ways depending on the location in the statement.
 - When defining a column, column constraints can be specified by using ⟨column constraint definition⟩.
 - On the other hand, the table constraint definition clause, ⟨table constraint definition⟩, can be specified separately from the column definition and the constraints on one or more columns can be specified.

The table constraint definition has the following syntactic difference compared to the column constraint definition.

- NOT NULL constraint
 - It can not be specified by using the table constraint definition.
- It should explicitly specify the column unlike the column constraint definition.

- UNIQUE constraint <unique constraint definition>
 - UNIQUE (column_name [, ...])
- PRIMARY KEY CONSTRAINT <unique constraint definition>
 - PRIMARY KEY (column_name [, ...])

key column element

It specifies the column to be a target of the key.

- column name
 - It is name of the column which creates the key.
- ASC | DESC
 - ASC: It is sorted in an ascending order.
 - DESC: It is sorted in a descending order.
 - If not specified, the default value is ASC.
- NULLS FIRST | NULLS LAST
 - NULLS FIRST: It is located before non-NULL values.
 - NULLS LAST: It is located after non-NULL values.
 - If not specified, the default value is NULLS LAST.

<table sharding strategy>

It defines the sharding strategy of a table.

It can be defined as one of the four following strategies.

- <cloned strategy>
- <hash sharding strategy>
- <range sharding strategy>
- <list sharding strategy>

If it is omitted, it is determined by **DEFAULT_SHARDING** property value.

- If **DEFAULT_SHARDING** value is 0
 - <cloned strategy>
- If **DEFAULT_SHARDING** value is 1
 - <hash sharding strategy>

<cloned strategy>

It clones all data in a table.

<clone placement>

It defines the placement strategy of a clone.

- AT CLUSTER WIDE
 - It places clones in all cluster members of all cluster groups in a cluster system.
 - A clone can be relocated by using **ALTER TABLE name REBALANCE** statement when adding a cluster group and a cluster member.
- AT CLUSTER GROUP group_list
 - It places clones in all cluster members of a specified cluster groups.
 - A clone can be relocated by using **ALTER TABLE name REBALANCE** statement when adding a cluster member in a specified cluster group.
 - Adding a cluster group does not affect the relocation of the clone.
- When it is omitted, the default value is AT CLUSTER WIDE.

<hash sharding strategy>

It shards the table data according to the hash value of the sharding key.

SHARDING BY [HASH] (column_list)

It defines a sharding key for a hash sharding.

- It can list maximum 32 columns.
- It can not use a duplicate column.
- It can not use a LONG VARCHAR type column or a LONG VARBINARY type column.

<hash shard count>

It defines the number of the hash shards to be sharded.

The number of shards can be defined from 1 to 512.

If it is omitted, the default value is 24.

<hash shard placement>

It defines the placement strategy of a hash shard.

- AT CLUSTER WIDE
 - It places shards in all cluster members of all cluster groups in a cluster system.
 - A shard can be relocated by using **ALTER TABLE name REBALANCE** statement when adding a cluster group and a cluster member.
- AT CLUSTER GROUP group_list

- It places hash shards in all cluster members of a specified cluster groups.
- The number of group_list should be equal to or smaller than the value of <hash shard count>.
- Unlike a range shard and a list shard, the cluster group on which the specific hash shard is to be located can not be specified, but the system automatically determines a cluster group on which the shard is to be located.
- A shard can be relocated by using **ALTER TABLE name REBALANCE** statement when adding a cluster member in a specified cluster group.
- Adding a cluster group does not affect the relocation of the hash shard.
- When it is omitted, the default value is AT CLUSTER WIDE.

<range sharding strategy>

It shards the table data according to the range value of the sharding key.

SHARDING BY RANGE (column_list)

It defines a sharding key for the range sharding.

- It can list maximum 32 columns.
- It can not use a duplicate column.
- It can not use a LONG VARCHAR type column or a LONG VARBINARY type column.

<cluster-wide range shard placement>

It automatically places range shards in all cluster groups of a cluster system.

AT CLUSTER WIDE statement is described before describing <range shard definition>.

Shards can be relocated by using **ALTER TABLE name REBALANCE** statement when adding a cluster group and a cluster member.

- Create a range sharded table.
- Place six shards in the existing cluster groups (g1, g2, g3).

```
CREATE TABLE t1
(
  id INTEGER,
  name VARCHAR(32)
)
SHARDING BY RANGE (id)
  AT CLUSTER WIDE
  SHARD s1 VALUES LESS THAN ( 200000 ),
  SHARD s2 VALUES LESS THAN ( 400000 ),
```

```

SHARD s3 VALUES LESS THAN ( 500000 ),
SHARD s4 VALUES LESS THAN ( 600000 ),
SHARD s5 VALUES LESS THAN ( 800000 ),
SHARD s6 VALUES LESS THAN ( MAXVALUE )
;

```

- Add a cluster group.

```

CREATE CLUSTER GROUP g4
    CLUSTER MEMBER g4n1 HOST '192.168.0.41' PORT 10401
;

```

- Relocate the range shard.
- Place six shards in the cluster groups (g1, g2, g3, g4) including the added g4.

```
ALTER TABLE t1 REBALANCE;
```

<group-specific range shard placement>

It places range shards in a specified cluster group.

It describes AT CLUSTER GROUP group_name statement which places that shard together with <range shard definition>.

Shards can be automatically relocated by using **ALTER TABLE name REBALANCE** statement when adding a cluster member to a specified cluster group.

Adding a cluster group does not affect the relocation of the range shard.

- Create a range sharded table.
- Place each range shard in a specified cluster group.

```

CREATE TABLE t1
(
    id INTEGER,
    name VARCHAR(32)
)
SHARDING BY RANGE (id)
    SHARD s1 VALUES LESS THAN ( 200000 ) AT CLUSTER GROUP g1,
    SHARD s2 VALUES LESS THAN ( 400000 ) AT CLUSTER GROUP g2,
    SHARD s3 VALUES LESS THAN ( 500000 ) AT CLUSTER GROUP g3,
    SHARD s4 VALUES LESS THAN ( 600000 ) AT CLUSTER GROUP g2,
    SHARD s5 VALUES LESS THAN ( 800000 ) AT CLUSTER GROUP g3,
    SHARD s6 VALUES LESS THAN ( MAXVALUE ) AT CLUSTER GROUP g1

```

;

- Add a cluster group.

```
CREATE CLUSTER GROUP g4
    CLUSTER MEMBER g4n1 HOST '192.168.0.41' PORT 10401
;
```

- Relocate a range shard.
- The shard is not placed in a newly created cluster group g4.

```
ALTER TABLE t1 REBALANCE;
```

⟨range shard definition⟩

SHARD range_name should be unique in a table.

It can define maximum 512 of ⟨range shard definition⟩.

The listed ⟨range shard definition⟩ is sorted in an order of ⟨range value clause⟩, and it should use each different ⟨range value clause⟩.

The ⟨range shard definition⟩ whose all values are define as MAXVALUE is a MAX shard. MAX shard should exist, and it should be a single one.

- It should include a MAX shard.

```
gSQL>
CREATE TABLE t1
(
    id INTEGER,
    name VARCHAR(32)
)
SHARDING BY RANGE (id)
    AT CLUSTER WIDE
    SHARD s1 VALUES LESS THAN ( 100000 ),
    SHARD s2 VALUES LESS THAN ( 200000 ),
    SHARD s3 VALUES LESS THAN ( MAXVALUE )
;
```

Table created.

- If it does not include a MAX shard, then an error occurs.

```

gSQL>
CREATE TABLE t1
(
  id INTEGER,
  name VARCHAR(32)
)
SHARDING BY RANGE (id)
  AT CLUSTER WIDE
  SHARD s1 VALUES LESS THAN ( 100000 ),
  SHARD s2 VALUES LESS THAN ( 200000 ),
  SHARD s3 VALUES LESS THAN ( 300000 )
;
ERR-42000(16377): MAX shard not defined :
  SHARD s3 VALUES LESS THAN ( 300000 )
  *
ERROR at line 10:

```

<range value clause>

<range value> should be a constant or a MAXVALUE (a maximum value).

NULL can not be used as <range value>.

- (O) SHARD s1 VALUES LESS THAN (1)
- (O) SHARD s2 VALUES LESS THAN (1 + 1)
- (O) SHARD s3 VALUES LESS THAN (MAXVALUE)
- (X) SHARD s4 VALUES LESS THAN (SYSDATE)
- (X) SHARD s5 VALUES LESS THAN (NULL)

MAXVALUE is always bigger than any other value, and it includes null.

If there are multiple sharding keys, only a MAXVALUE can be specified after the MAXVALUE.

- (O) SHARD s1 VALUES LESS THAN (100, MAXVALUE)
- (X) SHARD s2 VALUES LESS THAN (MAXVALUE, 100)
- (O) SHARD s3 VALUES LESS THAN (MAXVALUE, MAXVALUE)

If a sharding key is defined by using multiple columns, a MAX shard which is listed with MAXVALUE for it s all values like as the SHARD s3 below should exist.

```

CREATE TABLE t1
(
  id INTEGER,

```

```

    name VARCHAR(32)
)
SHARDING BY RANGE (id, name)
    AT CLUSTER WIDE
    SHARD s1 VALUES LESS THAN ( 100000, MAXVALUE ),
    SHARD s2 VALUES LESS THAN ( 200000, 200000 ),
    SHARD s3 VALUES LESS THAN ( MAXVALUE, MAXVALUE )
;

```

<list sharding strategy>

It shards the table data according to the listed value of the sharding key.

SHARDING BY LIST (column_name)

It defines a sharding key for a list sharding.

- It can use only one column.
- It can not use a LONG VARCHAR type column or a LONG VARBINARY type column.

<cluster-wide list shard placement>

It automatically places list shards in all cluster groups of a cluster system.

AT CLUSTER WIDE statement is described before describing <range shard definition>.

Shards can be relocated by using **ALTER TABLE name REBALANCE** statement when adding a cluster group and a cluster member.

- Create a list sharded table.
- Place five shards in the existing cluster groups (g1, g2, g3).

```

CREATE TABLE city
(
    id    INTEGER,
    name  VARCHAR(32)
)
SHARDING BY LIST (name)
    AT CLUSTER WIDE
    SHARD s1 VALUES IN ( 'SEOUL' ),
    SHARD s2 VALUES IN ( 'PUSAN', 'ULSAN', 'DAEGU' ),
    SHARD s3 VALUES IN ( 'DAEJEON', 'GWANGJU' ),
    SHARD s4 VALUES IN ( 'ANSAN', 'GOYANG' ),

```

```
SHARD s5 VALUES IN ( DEFAULT )
;
```

- Add a cluster group.

```
CREATE CLUSTER GROUP g4
    CLUSTER MEMBER g4n1 HOST '192.168.0.41' PORT 10401
;
```

- Relocate a list shard.
- Place five shards in the cluster groups (g1, g2, g3, g4) including the added g4.

```
ALTER TABLE t1 REBALANCE;
```

⟨group-specific list shard placement⟩

It places list shards in a specified cluster group.

It describes AT CLUSTER GROUP group_name statement which places that shard together with ⟨list shard definition⟩.

Shards can be automatically relocated by using **ALTER TABLE name REBALANCE** statement when adding a cluster member to a specified cluster group.

Adding a cluster group does not affect the relocation of the list shard.

- Create a list sharded table.
- Place each list shard in a specified cluster group.

```
CREATE TABLE city
(
    id INTEGER,
    name VARCHAR(32)
)
SHARDING BY LIST (name)
    SHARD s1 VALUES IN ( 'SEOUL' ) AT CLUSTER GROUP g1,
    SHARD s2 VALUES IN ( 'PUSAN', 'ULSAN', 'DAEGU' ) AT CLUSTER GROUP g2,
    SHARD s3 VALUES IN ( 'DAEJEON', 'GWANGJU' ) AT CLUSTER GROUP g3,
    SHARD s4 VALUES IN ( 'ANSAN', 'GOYANG' ) AT CLUSTER GROUP g2,
    SHARD s5 VALUES IN ( DEFAULT ) AT CLUSTER GROUP g1
;
```

- Add a cluster group.

```
CREATE CLUSTER GROUP g4
    CLUSTER MEMBER g4n1 HOST '192.168.0.41' PORT 10401
;
```

- Relocate a list shard.
- The shard is not placed in a newly added cluster group g4.

```
ALTER TABLE t1 REBALANCE;
```

<list shard definition>

LIST list_name should be unique in a table.

It can define maximum 512 of <list shard definition>.

All <list value> of the listed <list shard definition> should be different each other.

DEFAULT are other values which is not the listed <list value>.

DEFAULT can not be defined together with another value.

A shard including DEFAULT is a DEFAULT shard.

MAX shard should exist, and it should be a single one.

- It should include a DEFAULT shard.

```
gSQL>
CREATE TABLE t1
(
    category INTEGER,
    name      VARCHAR(32)
)
SHARDING BY LIST (category)
    AT CLUSTER WIDE
    SHARD s1 VALUES IN ( 1, 3, 5, 7 ),
    SHARD s2 VALUES IN ( 2, 4, 6, 8 ),
    SHARD s3 VALUES IN ( DEFAULT )
;
```

Table created.

- If it does not include a DEFAULT shard, then an error occurs.

```

gSQL>
CREATE TABLE t1
(
  category INTEGER,
  name      VARCHAR(32)
)
SHARDING BY LIST (category)
  AT CLUSTER WIDE
  SHARD s1 VALUES IN ( 1, 3, 5, 7 ),
  SHARD s2 VALUES IN ( 2, 4, 6, 8 ),
  SHARD s3 VALUES IN ( 9, 10 )
;
ERR-42000(16385): DEFAULT shard not defined :
  SHARD s3 VALUES IN ( 9, 10 )
  *
ERROR at line 10:

```

<list value clause>

<list value> should be a constant.

NULL or DEFAULT can be used as <list value>.

- (O) SHARD s1 VALUES IN (1, 1 + 1, 3, 4)
- (O) SHARD s2 VALUES IN (5, 6, 7, NULL)
- (O) SHARD s3 VALUES IN (DEFAULT)
- (X) SHARD s4 VALUES IN (DEFAULT, 8, 9, 10)
- (X) SHARD s5 VALUES IN (current_timestamp, systimestamp)
- (X) SHARD s6 VALUES IN (c1, c2)

<table physical attribute clause>

It defines the physical attribute information of the table.

- PCTFREE integer
 - Definition
 - The reserved space in case the row size is increased when altering or updating a row in a page.
 - The initial input is input in other space except for this reserved space.
 - If PCTFREE is not enough ROW MIGRATION occurs when altering or updating the data.
 - It can use of the value from 0 to 99.
 - If it is omitted, the default value is 10.

- PCTUSED integer
 - Definition
 - It is the minimum percentage which can be used for the row data and overhead before adding a new row to a page.
 - It can be input only on this page when the value got smaller than PCTUSED due to alteration or deletion of the existing data.
 - It can use the value from 0 to 99.
 - If it is omitted, the default value is 40.
- INITRANS integer
 - Definition
 - It specifies the initial number of transactions which can simultaneously access the page.
 - If the number of users who access the index is small, INITRANS is set to low, and if the number of users who simultaneously access the index is big, INITRANS is set to high.
 - If necessary, it is automatically increased to the specified MAXTRANS.
 - It can use the value from 1 to 32.
 - If it is omitted, the default value is 4.
- MAXTRANS integer
 - Definition
 - It specifies the maximum number of transactions which can simultaneously access the page.
 - It can use the value from 1 to 32.
 - If it is omitted, the default value is 8.

⟨index physical attribute clause⟩

It defines the physical attributes of the index.

- PCTFREE integer
 - Definition
 - It is a reserved space for adjusting the frequency of page splits caused by the key insertion in the page.
 - It is applied only to the index bottom-up build.
 - It can use the value from 0 to 99.
 - If it is omitted, the value set in DEFAULT_INDEX_PCTFREE property is used.
- INITRANS integer
 - It is as same as INITRANS in ⟨table physical attribute clause⟩.
- MAXTRANS integer
 - It is as same as MAXTRANS in ⟨table physical attribute clause⟩.

<segment attr clause>

It describes the information about the space in which the table is stored.

- INITIAL integer
 - Definition
 - It specifies the size of physical storage space which is initially allocated when creating the table.
 - The size is aligned to the EXTENT size of TABLESPACE to which the table belongs. (e.g. If the EXT size is 8192 bytes, 'INITIAL 100' actually operates as 8192 bytes.)
 - The size (aligned to the size of TABLESPACE EXTENT) should be equal to or bigger than the size of MINEXTENTS, and it should be equal to or smaller than the size of the MAXEXTENTS.
 - The minimum value is 1, and the maximum value depends on the system environment.
 - If it is omitted, the default value is a single EXTENT size of TABLESPACE where the table belongs.

- NEXT integer
 - Definition
 - It specifies the physical space size to be allocated when adding the space to the table.
 - The size is aligned to EXTENT size of TABLESPACE to which the table belongs. (e.g. If the EXT size is 8192 bytes, 'INITIAL 100' actually operates as 8192 bytes.)
 - NEXT is operated as follows according to the size of the remaining space of the currently available table. (The size of subtracting the currently used space from the size of MAXEXTENTS.)
 - If the remaining space size is 0, then it can not extend the space.
 - If the remaining space size is bigger than 0, but smaller than NEXT, then it allocates the space as big as the remaining space.
 - If the remaining space size is bigger than NEXT, then it allocates the space as big as the NEXT.
 - The minimum value is 1, and the maximum value depends on the system environment.
 - If it is omitted, the default value is a single EXTENT size of TABLESPACE to which the table belongs.

- MINSIZE integer
 - Definition
 - It is the minimum space size which the table should maintain.
 - It should be equal to or smaller than the value of MAXSIZE.
 - It is aligned to the EXTENT size of TABLESPACE to which the table belongs.
 - The minimum value is 1, and the maximum value depends on the system environment.
 - If it is smaller than the size of two EXTENTs, the size of two EXTENTs is allocated.
 - If it is omitted, the default value is the size of two EXTENTs.

- MAXSIZE integer
 - Definition
 - It is the maximum space size which can be allocated to a table.
 - It should be equal to or bigger than the value of MINSIZE.

- This size is aligned to the EXTENT size of TABLESPACE to which the table belongs.
- The minimum value is 1, and the maximum value depends on the system environment.
- If it is omitted, the default value is EXTENT size * 2147483647 (The maximum positive integer of INT32).

⟨size clause⟩

It specifies the file size in bytes. (If it is omitted, the default unit is bytes.)

- K: Kilobytes
- M: Megabytes
- G: Gigabytes
- T: Terabytes

TABLESPACE tablespace_name

It specifies the tablespace name in which a table is to be stored.

If TABLESPACE clause is omitted, the default tablespace_name of the user performing the statement is used.

LOGGING | NOLOGGING

It specifies whether to perform redo logging of the index.

If not specified, the default value is NOLOGGING.

TABLESPACE index_tablespace_name

It specifies the tablespace name in which an index is to be stored.

If the TABLESPACE clause is omitted, LOGGING index uses the user's default data tablespace and NOLOGGING index uses the user's default temporary tablespace.

⟨constraint characteristics⟩

It defines characteristics of the constraint.

When defining constraints, the following characteristics can be set.

- DEFERRABLE | NOT DEFERRABLE
- ⟨constraint check time⟩

If ⟨constraint characteristics⟩ is omitted, it is set to NOT DEFERRABLE INITIALLY IMMEDIATE.

DEFERRABLE | NOT DEFERRABLE

It sets whether the constraints checking is deferrable so that the constraints can be checked when executing COMMIT without checking when executing DML statements.

The checking time of the deferrable constraint is controlled by **SET CONSTRAINTS**.

- NOT DEFERRABLE
 - The checking point is not deferrable, and the constraints are checked when executing INSERT/DELETE/UPDATE statements.
- DEFERRABLE
 - The checking point can be controlled by **SET CONSTRAINTS** statement.
 - SET CONSTRAINTS constraint_name IMMEDIATE
 - The constraint is checked when executing DML statement.
 - SET CONSTRAINTS constraint_name DEFERRED
 - The constraint is checked when executing COMMIT statement.
- If not specified, the default value is determined in accordance with the <constraint check time>.
 - If INITIALLY IMMEDIATE is specified, the constraint check time is NOT DEFERRABLE.
 - If INITIALLY DEFERRED is specified, the constraint check time is DEFERRABLE.
 - If <constraint check time> is not specified, the constraint check time is NOT DEFERRABLE.

<constraint check time>

If the constraints are DEFERRABLE, it sets an initial value for the checking time.

- INITIALLY IMMEDIATE
 - The constraint is checked when executing the DML statements.
- INITIALLY DEFERRED
 - The constraint is checked when executing the COMMIT statements.
 - It can not be used together with NOT DEFERRABLE.
- If not specified, the default value is INITIALLY IMMEDIATE.

For more information about the deferrable constraints, refer to **SET CONSTRAINTS**.

<table global secondary index clause>

It defines a global secondary index of the table.

- WITH GLOBAL SECONDARY INDEX [<index attributes> [...]] [TABLESPACE tablespace_name]
 - It creates a global secondary index when creating a table in a cluster system environment.
 - <index attribute>
 - It sets an index attribute of a global secondary index.
 - TABLESPACE tablespace_name

- It specifies a tablespace to create a global secondary index.
- WITHOUT GLOBAL SECONDARY INDEX
 - It does not create a global secondary index when creating a table in a cluster system environment.

Description

Constraint Characteristics

GOLDILOCKS automatically creates an index to check the uniqueness when generating key constraints.

The following columns do not allow NULL value.

- A column including NOT NULL constraint
- A column which is included in primary key constraints
- An identity column

Cluster Table

A table manages data using one of the following sharding strategies in a cluster environment.

- Cloned table
 - It duplicates all table data and place them in a cluster system.
- Hash sharded table
 - It divides the table data into several shards based on the hash value of a sharding key, then places them in the cluster system.
- Range sharded table
 - It divides the table data into several shards based on the range value of a sharding key, then places them in the cluster system.
- List sharded table
 - It divides the table data into several shards based on the list value of a sharding key, then places them in the cluster system.

The sharding strategy is determined considering the followings when creating a table. Tables operated in a cluster system are specified as a code table and a fact table based on its features.

- Code table
 - It is a table such as a product list or a provider list whose data is relatively small and is not often altered
 - This table is referenced often together with a fact table.
- Fact table
 - It is a table such as a transaction history or a call history whose data is relatively big and is often altered.

- Its data is big so required to be sharded.

<cloned strategy> is appropriate for a code table, and an appropriate <table sharding strategy> should be determined according to the table access pattern in case of a fact table.

Examples

The following is an example of generating an ordinary table.

```
gSQL> CREATE TABLE region
(
  r_regionkey  INTEGER
, r_name      CHAR(25)
, r_comment   VARCHAR(152)
);
```

Table created.

The following is an example of specifying the constraints on the columns when creating a table.

```
gSQL> CREATE TABLE supplier
(
  s_suppkey    INTEGER PRIMARY KEY
, s_name      CHAR(25) NOT NULL
, s_address   VARCHAR(40)
, s_nationkey  INTEGER
, s_phone     CHAR(15)
, s_acctbal   NUMERIC(12,2)
, s_comment   VARCHAR(101)
);
```

Table created.

The following is an example of specifying the constraint which includes multiple columns when creating a table.

```
gSQL> CREATE TABLE partsupp
(
  ps_partkey   INTEGER
, ps_suppkey   INTEGER
, ps_availqty  INTEGER
, ps_supplycost NUMERIC(12,2)
```

```
, ps_comment    VARCHAR(199)
, CONSTRAINT ps_unique_key UNIQUE(ps_partkey, ps_suppkey)
);
```

Table created.

The following is an example of specifying whether constraints are deferrable when creating a table.

```
gSQL> CREATE TABLE t1
(
  id      NUMBER          PRIMARY KEY
                                NOT DEFERRABLE INITIALLY IMMEDIATE
, name   VARCHAR(128)    CONSTRAINT t1_nn NOT NULL
                                DEFERRABLE INITIALLY IMMEDIATE
, addr   VARCHAR(1024)
, CONSTRAINT t1_uk UNIQUE ( id, name )
                                DEFERRABLE INITIALLY DEFERRED
);
```

Table created.

```
gSQL> COMMIT;
```

Commit complete.

The following is an example of specifying a column including automatically generated values and the default value when creating a table.

```
CREATE TABLE customer
(
  c_custkey      INTEGER  GENERATED BY DEFAULT AS IDENTITY
, c_name        VARCHAR(25)
, c_address     VARCHAR(40) DEFAULT 'N/A'
, c_nationkey   INTEGER
, c_phone       CHAR(15)
, c_acctbal     NUMERIC(12,2)
, c_mktsegment  CHAR(10)
, c_comment     VARCHAR(117)
);
```

Table created.

The following is an example of specifying the tablespace which is to be stored when creating a table.

```
gSQL> CREATE TABLE lineitem
(
  l_orderkey     INTEGER
```

```

, l_partkey      INTEGER
, l_suppkey     INTEGER
, l_linenumber  INTEGER
, l_quantity    NUMERIC(12,2)
, l_extendedprice NUMERIC(12,2)
, l_discount    NUMERIC(12,2)
, l_tax         NUMERIC(12,2)
, l_returnflag  CHAR(1)
, l_linestatus  CHAR(1)
, l_shipdate    DATE
, l_commitdate  DATE
, l_receiptdate DATE
, l_shipinstruct CHAR(25)
, l_shipmode    CHAR(10)
, l_comment     VARCHAR(44)
, PRIMARY KEY (l_orderkey, l_linenumber) INDEX lineitem_pk_idx TABLESPACE mem_temp_tbs
) TABLESPACE mem_data_tbs;
Table created.

```

The following is an example of defining a cluster-wide cloned table. The table data is copied and placed a ll over the cluster system.

```

gSQL>
CREATE TABLE region
(
  r_regionkey  INTEGER
, r_name      CHAR(25)
, r_comment   VARCHAR(152)
)
CLONED
AT CLUSTER WIDE
;
Table created.

```

The following is an example of defining a group-specific cloned table. The table data is copied and placed in a cluster group g1 and g2 specified by a user.

```

gSQL>
CREATE TABLE region
(
  r_regionkey  INTEGER
, r_name      CHAR(25)

```

```

, r_comment    VARCHAR(152)
)
CLONED
AT CLUSTER GROUP g1, g2
;
Table created.

```

The following is an example of defining a cluster-wide hash sharded table. The table data is divided into 24 shards based on the hash value of a `ps_partkey` column, and each shard is automatically placed all over the cluster system.

```

gSQL>
CREATE TABLE partsupp
(
    ps_partkey    INTEGER
, ps_suppkey    INTEGER
, ps_availqty   INTEGER
, ps_supplycost NUMERIC(12,2)
, ps_comment    VARCHAR(199)
)
SHARDING BY HASH ( ps_partkey )
SHARD COUNT 24
AT CLUSTER WIDE
;
Table created.

```

The following is an example of defining a group-specific hash sharded table. The table data is divided into 24 shards based on the hash value of a `ps_partkey` column, and each shard is automatically placed in a specified cluster group `g2` and `g3`.

```

gSQL>
CREATE TABLE partsupp
(
    ps_partkey    INTEGER
, ps_suppkey    INTEGER
, ps_availqty   INTEGER
, ps_supplycost NUMERIC(12,2)
, ps_comment    VARCHAR(199)
)
SHARDING BY HASH ( ps_partkey )
SHARD COUNT 24
AT CLUSTER GROUP g2, g3

```

;

Table created.

The following is an example of defining a cluster-wide range sharded table. The table data is divided into 24 shards based on the range value of D_ID column, and each shard is automatically placed all over the cluster system.

gSQL>

```
CREATE TABLE DISTRICT (
  D_ID      INTEGER,
  D_W_ID    INTEGER,
  D_NAME    VARCHAR(10),
  D_STREET_1 VARCHAR(20),
  D_STREET_2 VARCHAR(20),
  D_CITY    VARCHAR(20),
  D_STATE   CHAR(2),
  D_ZIP     CHAR(9),
  D_TAX     NUMERIC(4,4),
  D_YTD     NUMERIC(15,2),
  D_NEXT_O_ID INTEGER,
  PRIMARY KEY (D_W_ID, D_ID) INDEX DISTRICT_PK_IDX
)
SHARDING BY RANGE (D_ID)
AT CLUSTER WIDE
SHARD s1 VALUES LESS THAN ( 100 ),
SHARD s2 VALUES LESS THAN ( 200 ),
SHARD s3 VALUES LESS THAN ( 300 ),
SHARD s4 VALUES LESS THAN ( 400 ),
SHARD s5 VALUES LESS THAN ( 500 ),
SHARD s6 VALUES LESS THAN ( 600 ),
SHARD s7 VALUES LESS THAN ( 700 ),
SHARD s8 VALUES LESS THAN ( MAXVALUE );
;
```

Table created.

The following is an example of defining a group-specific range sharded table. The table data is divided into three range values based on the range value of a NO_D_ID column, and a shard s1 is placed in a cluster group g1, a shard s2 is placed in a cluster group g2, a shard s3 is placed in a cluster group g3.

gSQL>

```
CREATE TABLE NEW_ORDER
(
```

```

    NO_O_ID INTEGER,
    NO_D_ID INTEGER,
    NO_W_ID INTEGER,
    PRIMARY KEY(NO_W_ID, NO_D_ID, NO_O_ID) INDEX NEW_ORDER_PK_IDX
)
SHARDING BY RANGE (NO_D_ID)
SHARD s1 VALUES LESS THAN ( 5 )          AT CLUSTER GROUP g1,
SHARD s2 VALUES LESS THAN ( 8 )          AT CLUSTER GROUP g2,
SHARD s3 VALUES LESS THAN ( MAXVALUE ) AT CLUSTER GROUP g3
;
Table created.

```

The following is an example of defining a cluster-wide list sharded table. A list shard is divided into five based on a city column, and each shard is automatically placed all over the cluster system.

```

gSQL>
CREATE TABLE t1
(
    id    INTEGER
, name  VARCHAR(32)
, city  VARCHAR(128)
)
SHARDING BY LIST (city)
    AT CLUSTER WIDE
    SHARD s1 VALUES IN ( 'seoul' ),
    SHARD s2 VALUES IN ( 'busan', 'ulsan' ),
    SHARD s3 VALUES IN ( 'suwon', 'ansan', 'osan' ),
    SHARD s4 VALUES IN ( 'goyang', 'paju', 'guri' ),
    SHARD s5 VALUES IN ( DEFAULT )
;
Table created.

```

The following is an example of defining a group-specific list sharded table. A list shard is divided into five based on a city column, and each shard is placed in a specified cluster group.

```

gSQL>
CREATE TABLE t1
(
    id    INTEGER
, name  VARCHAR(32)
, city  VARCHAR(128)
)

```



```

SHARDING BY LIST (city)
  SHARD s1 VALUES IN ( 'seoul' )           AT CLUSTER GROUP g1,
  SHARD s2 VALUES IN ( 'busan', 'ulsan' )   AT CLUSTER GROUP g2,
  SHARD s3 VALUES IN ( 'suwon', 'ansan', 'osan' ) AT CLUSTER GROUP g1,
  SHARD s4 VALUES IN ( 'goyang', 'paju', 'guri' ) AT CLUSTER GROUP g2,
  SHARD s5 VALUES IN ( DEFAULT )           AT CLUSTER GROUP g3
;

```

Table created.

A table T1 is created without a global secondary index.

```

gSQL> CREATE TABLE T1 ( I1 INTEGER, I1 CHAR(32) ) WITHOUT GLOBAL SECONDARY INDEX;
Table created.

```

A global secondary index is created after creating a table T1.

```

gSQL> CREATE TABLE T1 ( I1 INTEGER, I1 CHAR(32) ) WITH GLOBAL SECONDARY INDEX;
Table created.

```

A global secondary index of table T1 is created in a tablespace USER_DATA_TBS with a logging option after creating a table T1.

```

gSQL> CREATE TABLE T1 ( I1 INTEGER, I1 CHAR(32) )
  WITH GLOBAL SECONDARY INDEX
  LOGGING TABLESPACE USER_DATA_TBS;
Table created.

```

A global secondary index of table T1 is created in a tablespace USER_TEMP_TBS with a nologging option after creating a table T1.

```

gSQL> CREATE TABLE T1 ( I1 INTEGER, I1 CHAR(32) )
  WITH GLOBAL SECONDARY INDEX
  NOLOGGING TABLESPACE USER_TEMP_TBS;
Table created.

```

Compatibility

The SQL standard does not define the following clauses.

- The physical concepts of TABLESPACE clause and <physical attribute clause> clause.
- The SQL standard does not allow an operation in DEFAULT clause.

Table 16-30 SQL standard compatibility

Feature ID	Description	Compatibility
T171	LIKE clause in table definition	X
F531	Temporary tables	X
S051	Create table of type	X
S043	Enhanced reference types	X
S081	Subtables	X
T173	Extended LIKE clause in table definition	X
T180	System-versioned tables	X
F692	Extended collation support	X
T174	Identity columns	O
T175	Generated columns	X
S071	SQL paths in function and type name resolution	X
F321	User authorization	O
T322	Extended roles	X
F762	CURRENT_CATALOG	O
F763	CURRENT_SCHEMA	O

For More Information

Refer to the followings.

- DROP TABLE
- ALTER TABLE
- CREATE TABLESPACE
- CREATE SCHEMA
- CREATE INDEX
- CREATE SEQUENCE
- SET CONSTRAINTS
- ALTER TABLE name ADD GLOBAL SECONDARY INDEX

16.86 CREATE TABLE AS SELECT

Function

It creates a new table from the query result.

Syntax

```

<table definition: AS query expression> ::=
    CREATE TABLE table_name
        [ ( column_name [, ...] ) ]
        [ <table sharding strategy> ]
        [ <table attribute clause> [, ...] ]
        [ TABLESPACE tablespace_name ]
        [ <table global secondary index clause> ]
        AS <query expression> [ WITH [ NO ] DATA ]
    ;

<table sharding strategy> ::=
    <cloned strategy>
    | <hash sharding strategy>
    | <range sharding strategy>
    | <list sharding strategy>

<cloned strategy> ::=
    CLONED [ <clone placement> ]

<clone placement> ::=
    AT CLUSTER WIDE
    | AT CLUSTER GROUP group_list

<hash sharding strategy> ::=
    SHARDING BY [HASH] ( column_list )
    [ <hash shard count> ]
    [ <hash shard placement> ]

<hash shard count> ::=
    SHARD COUNT integer

<hash shard placement> ::=
    AT CLUSTER WIDE
    | AT CLUSTER GROUP group_list

<range sharding strategy> ::=

```

```

SHARDING BY RANGE ( column_list )
  { <cluster-wide range shard placement> | <group-specific range shard placement> }
<cluster-wide range shard placement> ::=
  AT CLUSTER WIDE
  <range shard definition> [, ...]
<group-specific range shard placement> ::=
  <group-specific range shard definition> [, ...]
<group-specific range shard definition> ::=
  <range shard definition> AT CLUSTER GROUP group_name
<range shard definition> ::=
  SHARD range_name VALUES LESS THAN ( <range value clause> )
<range value clause> ::=
  <range value> [, ...]
<range value> ::=
  constant
  | MAXVALUE
<list sharding strategy> ::=
  SHARDING BY LIST ( column_name )
  { <cluster-wide list shard placement> | <group-specific list shard placement> }
<cluster-wide list shard placement> ::=
  AT CLUSTER WIDE
  <list shard definition> [, ...]
<group-specific list shard placement> ::=
  <group-specific list shard definition> [, ...]
<group-specific list shard definition> ::=
  <list shard definition> AT CLUSTER GROUP group_name
<list shard definition> ::=
  SHARD shard_name VALUES IN ( <list value clause> )
<list value clause> ::=
  <list value> [, ...]
<list value> ::=
  constant
  | NULL
  | DEFAULT
<table attribute clause> ::=
  [ <table physical attribute clause> ]
  | [ STORAGE ( <segment attr clause> [...] ) ]
<table physical attribute clause> ::=
  PCTFREE integer
  | PCTUSED integer
  | INITRANS integer

```

```

    | MAXTRANS integer
<index physical attribute clause> ::=
    PCTFREE integer
    | INITTRANS integer
    | MAXTRANS integer
<segment attr clause> ::=
    INITIAL <size_clause>
    | NEXT <size_clause>
    | MINSIZE <size_clause>
    | MAXSIZE <size_clause>
<size clause> ::=
    integer [ K | M | G | T ]
<table global secondary index clause> ::=
    WITH GLOBAL SECONDARY INDEX [ <index attributes> [...] ] [ TABLESPACE tablespace_name ]
    | WITHOUT GLOBAL SECONDARY INDEX

```

Invocation and Access Rules

A user should satisfy the following conditions to perform <table definition:AS query expression>statement.

- Table creation privilege
 - Refer to the access privilege in **CREATE TABLE**.
- SELECT access privilege
 - Refer to the access privilege in **SELECT**.

Syntax Rules and Parameters

table_name

It is the table name to be created.

For more information, refer to **table_name**.

column_name_list

It is the name of columns which configure the table, and it should be unique names within the table.

The number of columns should be as same as the number of result columns in SELECT clause.

If not specified, the column names of SELECT clause in <query expression> are used.

However, if there is an expression (function, operation, subquery, etc.) instead of a column in SELECT clause, the alias or column name should be specified.

The length of the column name should be shorter than 128 bytes.

WITH [NO] DATA

If WITH DATA is specified, the result of SELECT clause is inserted to the table to be created.

If WITH NO DATA is specified, the result of SELECT clause is not inserted to the table to be created.

If not specified, it is operated as same as when WITH DATA is specified.

Other Syntax

For more information about other syntaxes, refer to the syntax in **CREATE TABLE** statement.

Description

When executing CREATE TABLE AS SELECT, if a column including a NOT NULL constraint is specified in SELECT list, the NOT NULL constraint is also created in the new table.

However, if the NOT NULL constraint is deferrable, then NOT NULL constraint is not created in the new table.

On the other hand, the NOT NULL constraint is not created in the new table if NOT NULL constraint was not explicitly created but there is NOT NULL property such as primary key column or identity column.

Examples

The following is an example of executing CREATE TABLE AS SELECT statement.

```
gSQL> CREATE TABLE recent_orders
        AS SELECT order_id, order_item, order_date
        FROM orders
        WHERE order_date >= '2015-03-03'
```

Table created.

The following is an example of specifying the column name.

```
gSQL> CREATE TABLE recent_orders ( order_id, order_item, order_date )
      AS SELECT order_id, order_item, order_date
      FROM orders
      WHERE order_date >= '2015-03-03'
```

Table created.

The following is an example of a function in SELECT list.

```
gSQL> CREATE TABLE recent_orders ( order_id, order_item, order_date )
      AS SELECT order_date, COUNT(*)
      FROM orders
      WHERE order_date >= '2015-03-03'
      GROUP BY order_date;
```

Table created.

The following is an example of the statement including WITH DATA.

```
gSQL>CREATE TABLE orders
(
  order_id  NUMBER
, order_item VARCHAR(128)
, order_date DATE
);
gSQL> COMMIT;
gSQL> INSERT INTO orders VALUES ( 1, 'Pen', '2010-01-01' );
gSQL> INSERT INTO orders VALUES ( 2, 'Book', '2015-03-03' );
gSQL> COMMIT;
gSQL> CREATE TABLE recent_orders
      AS SELECT order_id, order_item, order_date
      FROM orders
      WHERE order_date >= '2015-03-03'
```

WITH DATA;

Table created.

```
gSQL> SELECT COUNT(*) FROM recent_orders;
```

```
COUNT(*)
```

```
-----
```

```
1
```

1 row selected.

The following is an example of the statement including WITH NO DATA.

```

gSQL>CREATE TABLE orders
(
    order_id    NUMBER
    , order_item VARCHAR(128)
    , order_date DATE
);
gSQL> COMMIT;
gSQL> INSERT INTO orders VALUES ( 1, 'Pen', '2010-01-01' );
gSQL> INSERT INTO orders VALUES ( 2, 'Book', '2015-03-03' );
gSQL> COMMIT;
gSQL> CREATE TABLE recent_orders
        AS SELECT order_id, order_item, order_date
        FROM orders
        WHERE order_date >= '2015-03-03'
        WITH NO DATA;
Table created.
gSQL> SELECT COUNT(*) FROM recent_orders;
COUNT(*)
-----
         0
1 row selected.

```

Compatibility

CREATE TABLE AS SELECT statement follows SQL standard. However, the following is an extension of SQL standard.

- SQL standard require parentheses outside SELECT clause, but it is optional in GOLDDILOCKS.
- SQL standard require WITH [NO] DATA clause, but it is optional in GOLDDILOCKS.
- The concepts of tablespace in GOLDDILOCKS is an extended concept, and it is not supported in SQL standard.

Table 16-31 SQL standard compatibility

Feature ID	Description	Compatibility
T172	AS subquery clause in table definition	O

For More Information

Refer to the followings.

- [CREATE TABLE](#)
- [SELECT](#)

16.87 CREATE GLOBAL TEMPORARY TABLE

Function

It creates a new global temporary table.

Syntax

```
<global temporary table definition> ::=
    CREATE GLOBAL TEMPORARY TABLE table_name
        ( <table element> [, ...] )
        [ <table commit action clause> ]
        [ TABLESPACE tablespace_name ]
    ;
<global temporary table definition: AS query expression> ::=
    CREATE GLOBAL TEMPORARY TABLE table_name
        [ TABLESPACE tablespace_name ]
        AS <query expression> [ WITH [ NO ] DATA ]
    ;
<table commit action clause> ::=
    ON COMMIT { PRESERVE | DELETE } ROWS
```



The definition of <table element> is as same as that of <table_definition>. For more information, refer to **CREATE TABLE**.

Invocation and Access Rules

A user should satisfy the following conditions to perform <global temporary table definition> statement.

- Table creation privilege
 - Refer to the access privilege in **CREATE TABLE**.
- SELECT access privilege
 - Refer to the access privilege in **SELECT**.

Syntax Rules and Parameters

table_name

It is the table name to be created.

For more information, refer to **table_name**.

other syntax

For more information about other syntaxes, refer to the syntax in **CREATE TABLE** and in **CREATE TABLE AS SELECT** statement.

Description

GLOBAL TEMPORARY TABLE is used to store the data which is maintained while a transaction or a session is performed.

It is used for the purpose as same as that of the variable of which a developer temporarily stores the mid-data of the operation when developing an application.

The global temporary table has the following features.

- The definition of the global temporary table can be viewed in every session.
- The physical segment is not allocated when defining the global temporary table, but the segment subordinated to that session is allocated when it is inserted for the first time.
- The data of the global temporary table can be viewed in a session or a transaction which was inserted.
- The tablespace to store the data of the global temporary table is determined as follows.

Whether to specify tablespace	The tablespace in which the table is created
It specifies the tablespace.	It is created in the specified tablespace.
It does not specify the tablespace.	It is created in the default temporary tablespace of the current session user.

- The index for the global temporary table is subordinate to the same session of the corresponding table, and the time duration is as same as that of the table.
- It can define the view for the global temporary table.
- It can not specify <table sharding strategy> statement which describe the cluster-related features of the table for the global temporary table, nor <table global secondary index clause> statement.
- It can not specify <table attribute clause> which describes the physical attributes of the table for the global temporary table, nor <index attribute clause> which describes the physical attributes of the index.

x.

- <index attribute clause> which describes the physical attributes of the index can not be specified for the index which is created based on the global temporary table.
- If a transaction is terminated by <table commit action clause>, it can determine how to process the remaining data.

Table commit action	Description
ON COMMIT PRESERVE ROWS	It maintains the data remained in a table even after COMMIT or ROLLBACK.
ON COMMIT DELETE ROWS (default)	It deletes all data remained in a table at the time of COMMIT or ROLLBACK (TRUNCATE).

- It supports most of DDLs for an ordinary table. (Including ALTER and TRUNCATE)
 - It does not support CLUSTER-related statement (SHARD and global secondary index-related statement).
 - DDL for the global temporary table which is currently used in its own session or in another session causes an error.
 - DDL is available after removing all segments which is used as TRUNCATE TABLE or COMMIT in all sessions in use.
- It supports all DMLs and select statements for an ordinary table.
- All alteration for the global temporary table (DML) do not leave the redo log.
- All alteration for the global temporary table (DML) leaves the undo log, the location of the undo log is determined according to TEMP_UNDO_ENABLED property.

TEMP_UNDO_ENABLED value	Description
TRUE	The undo log is recorded in the default temporary tablespace of the database system.
FALSE	The undo log is recorded in the undo tablespace of the database system.

- TRUNCATE command for the global temporary table truncates only the segment of the corresponding session.
- If the session is terminated, all segments are TRUNCATED and then returned.

Examples

The following is an example of performing CREATE GLOBAL TEMPORARY TABLE statement.

```
gSQL> CREATE GLOBAL TEMPORARY TABLE SESSION_TABLE1(
        COL1 CHAR(10)
        ,COL2 VARCHAR2(20)
        ,COL3 NUMBER(10)
```

```
) ON COMMIT DELETE ROWS;
Table created.
```

The following is an example of performing CREATE GLOBAL TEMPORARY TABLE ... AS SELECT statement.

```
gSQL> CREATE GLOBAL TEMPORARY TABLE SESSION_TABLE2
      ON COMMIT PRESERVE ROWS
      AS SELECT *
      FROM EMPLOYEES;
Table created.
```

Compatibility

CREATE GLOBAL TEMPORARY TABLE and CREATE GLOBAL TEMPORARY TABLE AS SELECT statement follows the definition of SQL standard <table definition>. However, the following is an extension of SQL standard.

- SQL standard require parentheses outside SELECT clause, but it is optional in GOLDILOCKS.
- SQL standard require WITH [NO] DATA clause, but it is optional in GOLDILOCKS.
- The concepts of tablespace in GOLDILOCKS is an extended concept, and it is not supported in SQL standard.

Table 16-32 SQL standard compatibility

Feature ID	Description	Compatibility
T171	LIKE clause in table definition	X
T172	AS subquery clause in table definition	O
F531	Temporary tables	X
S051	Create table of type	X
S043	Enhanced reference types	X
S081	Subtables	X
T173	Extended LIKE clause in table definition	X
T180	System-versioned tables	X
F692	Extended collation support	X
T174	Identity columns	O
T175	Generated columns	X
S071	SQL paths in function and type name resolution	X
F321	User authorization	O
T322	Extended roles	X
F762	CURRENT_CATALOG	O

Feature ID	Description	Compatibility
F763	CURRENT_SCHEMA	0

For More Information

Refer to the followings.

- CREATE TABLE
- CREATE TABLE AS SELECT

16.88 CREATE TABLESPACE

Function

It creates a tablespace.

Syntax

```
<create tablespace statement> ::=  
    <memory data tablespace statement>  
    | <memory temporary tablespace statement>  
    ;
```

Invocation and Access Rules

CREATE TABLESPACE ON DATABASE privilege is required to perform <create tablespace statement>.

The user who performed the statement has CREATE OBJECT ON TABLESPACE privilege on the created tablespace.

One of the following privileges are required to create the objects on the created tablespace.

- CREATE OBJECT ON TABLESPACE for that tablespace
- USAGE TABLESPACE ON DATABASE

Syntax Rules and Parameters

<memory data tablespace statement>

- [MEMORY] TEMPORARY

It is a memory temporary tablespace to store the no logging indexes or the temporary objects such as intermediate results which are generated during the query processing.

The reserved word MEMORY can be omitted.

⟨memory data tablespace clause⟩

It defines a memory data tablespace.

For more information, refer to `CREATE MEMORY DATA TABLESPACE`.

⟨memory temporary tablespace definition⟩

It defines a memory temporary tablespace.

For more information, refer to `CREATE MEMORY TEMPORARY TABLESPACE`.

Description

For more information, refer to the description of each detailed statement.

Example

For more information, refer to usage example of each detailed statement.

Compatibility

The SQL standard does not cover the concepts of the tablespace.

For More Information

Refer to the followings.

- `DROP TABLESPACE`
- `ALTER TABLESPACE`

16.89 CREATE MEMORY DATA TABLESPACE

Function

It defines a memory data tablespace.

Syntax

```

<memory data tablespace statement> ::=
    CREATE [ MEMORY ] [ DATA ] TABLESPACE tablespace_name
        DATAFILE <memory datafile clause> [, ...]
        [ <data tablespace management clause> [, ...] ]
<memory datafile clause> ::=
    'filename'
        [ SIZE <size clause> | REUSE | SIZE <size clause> REUSE ]
        [ AT <domain_name> ]
<size clause> ::=
    integer [ K | M | G | T ]
<data tablespace management clause> ::=
    { ONLINE | OFFLINE }
    | EXTSIZE <size clause>

```

Invocation and Access Rules

CREATE TABLESPACE ON DATABASE privilege is required to perform <memory data tablespace definition>

The user who performed the statement has CREATE OBJECT ON TABLESPACE privilege on the created tablespace.

One of the following privileges is required to create the objects on the created tablespace.

- CREATE OBJECT ON TABLESPACE for that tablespace
- USAGE TABLESPACE ON DATABASE

Syntax Rules and Parameters

[MEMORY] [DATA]

It is a memory tablespace to store the permanent objects such as tables, indexes, etc.

The reserved words, MEMORY and DATA, can be omitted.

tablespace_name

It is the tablespace name to be created.

The length of the tablespace name should be shorter than 128 bytes.

<memory datafile clause>

- 'filename'
 - It is the file name to store and manage the data.
 - It is the space to store the checkpoint image for the memory data.
 - filename can be either a new file or an already existing file.
 - The length of the filename should be shorter than 1024 bytes.
- SIZE <size clause>
 - The initial size is assigned for a new file by using the SIZE clause.
 - An error occurs if the file already exists.
 - The file size can be specified between minimum 1M and maximum 30G.
- REUSE
 - If the file already exists, REUSE clause is used.
 - If the file does not exist, a new file is created.
 - The newly created file size is
 - determined by MEMORY_DATA_TABLESPACE_SIZE property in case of the data tablespace.
 - determined by MEMORY_TEMP_TABLESPACE_SIZE property in case of the temporary tablespace.
- SIZE <size clause> REUSE
 - If both SIZE clause and REUSE clause are specified, it is operated as follows according to the presence of the filename.
 - For the new filename, the initial file size is assigned by using the SIZE clause.
 - For the existing filename, the size is adjusted to the value of SIZE clause by using the existing file.

<size clause>

It specifies the file size in bytes. (If it is omitted, the default unit is bytes.)

- K: Kilobytes
- M: Megabytes
- G: Gigabytes
- T: Terabytes

<domain name>

It is a name of a member or a group for which the statement is performed.

If it is omitted, it is performed for all groups.

ONLINE | OFFLINE

It sets ONLINE or OFFLINE of the tablespace.

- ONLINE is the state which a tablespace can be used as soon as it is created.
- OFFLINE is the state which a tablespace is unable to be used, it can be used after switching to ONLINE state.

EXTSIZE <size clause>

It specifies extent size of the tablespace.

- The extent size is specified in bytes, and one of the five (64K, 128K, 256K, 512K, 1M) is selected.
- If the extent size is defined as a value between 64K ~ 128K, 128K is set. If the extent size is defined as 1M or bigger, 1M is set.

Description

The data tablespace is an object which provides the physical space to store the SQL schema object such as a table, an index (with LOGGING option).

Examples

The following is an example of creating a memory data tablespace.

```
gSQL> CREATE TABLESPACE space1 DATAFILE 'test_file_1.dbf' SIZE 10M REUSE;  
Tablespace created.
```

The following is an example of creating a tablespace which consists of multiple data files.

```
gSQL> CREATE TABLESPACE space1  
        DATAFILE 'test_file_3_1.dbf' SIZE 10M REUSE,  
                'test_file_3_2.dbf' SIZE 10M REUSE;  
Tablespace created.
```

Compatibility

The SQL standard does not cover the concepts of the tablespace.

For More Information

Refer to the followings.

- **DROP TABLESPACE**
- **ALTER TABLESPACE**

16.90 CREATE MEMORY TEMPORARY TABLESPACE

Function

It defines a memory temporary tablespace.

Syntax

```
<memory temporary tablespace statement> ::=
    CREATE [ MEMORY ] TEMPORARY TABLESPACE tablespace_name
        MEMORY <memory clause> [, ...]
        <temporary tablespace management clause>
<memory clause>
    'memory_name' { SIZE <size clause> } [ AT <domain_name> ]
<temporary tablespace management clause> ::=
    EXTSIZE <size clause>
```

Invocation and Access Rules

CREATE TABLESPACE ON DATABASE privilege is required to perform <memory temporary tablespace definition>.

The user who performed the statement has CREATE OBJECT ON TABLESPACE privilege on the created tablespace.

One of the following privileges is required to create the objects on the created tablespace.

- CREATE OBJECT ON TABLESPACE for the tablespace.
- USAGE TABLESPACE ON DATABASE

Syntax Rules and Parameters

[MEMORY] TEMPORARY

It is a memory temporary tablespace to store the no logging indexes or the temporary objects such as intermediate results which are generated during the query processing.

The reserved word, MEMORY, can be omitted.

tablespace_name

It is the tablespace name to be created.

The length of the tablespace name should be shorter than 128 bytes.

<memory clause>

- 'memory_name'
 - It is a memory name to store the temporary data.
 - memory_name should be guaranteed to be unique within the tablespace.
 - The length of the memory_name should be shorter than 1024 bytes.
- SIZE <size clause>
 - It specifies the initial size.
 - It can be specified between minimum 1M and maximum 30G.

<size clause>

It specifies the size of shared memory space in bytes.(If it is omitted, the default unit is bytes.)

The image is not managed as a file in case of the temporary memory data.

- K: Kilobytes
- M: Megabytes
- G: Gigabytes
- T: Terabytes

<domain name>

It is a name of a member or a group for which the statement is performed.

If it is omitted, it is performed for all groups.

EXTSIZE <size clause>

It specifies extent size of the tablespace.

- The extent size is specified in bytes, and one of the five (64K, 128K, 256K, 512K, 1M) is selected.
- If the extent size is defined as a value between 64K ~ 128K, 128K is set. If the extent size is defined as 1M or bigger, 1M is set.

Description

The temporary tablespace is an object which provides the physical space to store the SQL schema objects such as an index (with NOLOGGING option), and to store the intermediate results for sorting, hashing during the query processing.

Examples

The following is an example of creating a temporary tablespace.

```
gSQL> CREATE TEMPORARY TABLESPACE temp_space1 MEMORY 'test_memory_1' SIZE 10M;  
Tablespace created.
```

The following is an example of creating a temporary tablespace which includes multiple memory spaces.

```
gSQL> CREATE TEMPORARY TABLESPACE temp_space1  
        MEMORY 'test_memory_3_1' SIZE 10M,  
        'test_memory_3_2' SIZE 10M;  
Tablespace created.
```

Compatibility

The SQL standard does not cover the concepts of the tablespace.

For More Information

Refer to the followings.

- `DROP TABLESPACE`
- `ALTER TABLESPACE`

16.91 CREATE USER

Function

It defines a database user.

Syntax

```
<user definition> ::=
    CREATE USER user_identifier IDENTIFIED BY password
    [ PROFILE { profile_name | DEFAULT | NULL } ]
    [ PASSWORD EXPIRE ]
    [ ACCOUNT { LOCK | UNLOCK } ]
    [ DEFAULT TABLESPACE tablespace_name ]
    [ TEMPORARY TABLESPACE tablespace_name ]
    [ INDEX TABLESPACE { tablespace_name | NULL } ]
    [ <schema clause> ]
    ;
<schema clause> ::=
    WITH SCHEMA [ schema_name ]
    | WITHOUT SCHEMA
```

Invocation and Access Rules

CREATE USER ON DATABASE privilege is required to perform <user definition>.

The created user, `user_identifier`, has the privilege, which is the owner the schema created by using <schema clause>.



A separate privilege is not granted to the created `user_identifier`.

The appropriate privileges should be granted to `user_identifier` to access and perform SQL statements.

Syntax Rules and Parameters

user_identifier

It is the username to be created.

The identical username (user identifier) or role (role name) should not exist.

The length of user_identifier should be shorter than 128 bytes.

password

It is the user's password to be created. It is encrypted and stored.

The length of password should be shorter than 128 bytes.

The password should start with an alphabetic character, and it can include alphabetic characters, number, underscore (_), and \$.

The other special characters should be enclosed in double quotes (").

PROFILE { profile_name | DEFAULT | NULL }

The profile for password management policy is assigned.

- PROFILE profile_name
 - It allocates the profile_name which is created by a user.
- PROFILE DEFAULT
 - It allocates the default profile "DEFAULT".
- PROFILE NULL
 - It does not allocate the profile.

If PROFILE clause is omitted, it is as same as PROFILE NULL, and the profile is not applied.

For more information about the password management policy, refer to **16.81 CREATE PROFILE**.

PASSWORD EXPIRE

It expires the user's password.

It is used when a user attempts to change the password by force before login.

ACCOUNT { LOCK | UNLOCK }

- ACCOUNT LOCK
 - It locks the user account.

- ACCOUNT UNLOCK
 - It unlocks the user account.

DEFAULT TABLESPACE `tablespace_name`

It specifies the default TABLESPACE to store objects such as the table created by the user, the indexes (with NOLOGGING option).

If DEFAULT TABLESPACE clause is omitted, default data tablespace(MEM_DATA_TBS) is specified, which was defined when creating DATABASE.

TEMPORARY TABLESPACE `tablespace_name`

It specifies the TABLESPACE which stores the temporary tables created by a user, indexes (NO LOGGING), and the intermediate results generated by the query processing.

If TEMPORARY TABLESPACE clause is omitted, default temporary tablespace (MEM_TEMP_TBS) is specified, which was defined when creating DATABASE.

INDEX TABLESPACE { `tablespace_name` | NULL }

It specifies the default TABLESPACE which stores the index objects created by a user.

- Specifying INDEX TABLESPACE `tablespace_name`
 - If it specifies the data tablespace, then it should be the LOGGING index.
 - If it specifies the temporary tablespace, then it should be the NOLOGGING index.
- INDEX TABLESPACE NULL
 - It does not specify the index tablespace.

If INDEX TABLESPACE clause is omitted, then it is INDEX TABLESPACE NULL.

<schema clause>

It creates a schema which a user uses by default.

The schema name should be unique in the database.

- WITH SCHEMA [`schema_name`]
 - If `schema_name` is not assigned, the schema is created whose name is as same as `user_identifier`.
 - SCHEMA PATH of the user is set as follows.
 - `schema_name`, PUBLIC
- WITHOUT SCHEMA
 - It does not create the schema which is to be owned by a user.

- SCHEMA PATH of the user is set as PUBLIC.

If <schema clause> is not specified, the default value is WITH SCHEMA and the schema is created whose name is as same as user_identifier.

The schema to be owned by the user can be additionally created by using **CREATE SCHEMA** statement.

Description

A user is an authorization object which consists of a set of privileges.

When <user definition> statement is executed for the first time, a user without any privilege is created, and the appropriate privileges should be granted as follows.

In GOLDILOCKS, the relationship between user and schema is 1 : N.

In other words, a user does not own any schema, or a user can own multiple schemas.

The SQL standard does not explicitly define the relationship of the non-schema objects such as a user, a schema, or a database. Each DBMS defines the relationship of non-schema objects in different concept as follows.



The relationship between user and schema in other DBMS.

- Oracle
 - User : schema = 1 : 1.
- DB2
 - It is as same as the OS user.
 - The separate SQL statements which creates or deletes a user do not exist.
- Postgres
 - User : schema = 1 : N.
- MySQL
 - Database : schema = 1 : 1.
 - User is a subordinate object of database (schema).

Examples

At least the following privileges should be granted to create a user, and for the created user to create the objects, manipulate data.

The following is an example of creating a user and granting privileges.

- Create a user.

```
gSQL> CREATE USER u1 IDENTIFIED BY u1_password
        DEFAULT TABLESPACE mem_data_tbs
        TEMPORARY TABLESPACE mem_temp_tbs
        INDEX TABLESPACE NULL;
```

User created.

```
gSQL> COMMIT;
```

Commit complete.

- Grant database privileges.

```
gSQL> GRANT CREATE SESSION ON DATABASE TO u1;
```

Grant succeeded.

```
COMMIT;
```

Commit complete.

- Grant schema privileges.

```
GRANT CREATE TABLE, CREATE VIEW, CREATE INDEX, CREATE SEQUENCE, ADD CONSTRAINT
        ON SCHEMA u1 TO u1;
```

Grant succeeded.

```
COMMIT;
```

Commit complete.

- Grant tablespace privileges.

```
GRANT CREATE OBJECT ON TABLESPACE mem_data_tbs TO u1;
```

Grant succeeded.

```
GRANT CREATE OBJECT ON TABLESPACE mem_temp_tbs TO u1;
```

Grant succeeded.

```
COMMIT;
```

Commit complete.

The following is an example of creating objects by the user.

- It needs CREATE SESSION ON DATABASE.

```
gSQL> \connect u1 u1_password
```

- It needs CREATE TABLE ON SCHEMA u1.
- It needs CREATE OBJECT ON TABLESPACE mem_data_tbs.

```
gSQL> CREATE TABLE u1.t1 ( c1 INTEGER, c2 INTEGER ) TABLESPACE mem_data_tbs;  
Table created.  
gSQL> COMMIT;
```

- It needs CREATE INDEX ON SCHEMA u1.
- It needs CREATE OBJECT ON TABLESPACE mem_temp_tbs.

```
gSQL> CREATE INDEX u1.idx ON t1 (c2) TABLESPACE mem_temp_tbs;  
Index created.  
gSQL> COMMIT;
```

- It needs ADD CONSTRAINT ON SCHEMA u1.

```
gSQL> ALTER TABLE t1 ADD CONSTRAINT u1.t1_pk PRIMARY KEY (c1) ;  
Table altered.  
gSQL> COMMIT;
```

- It needs CREATE SEQUENCE ON SCHEMA u1.

```
gSQL> CREATE SEQUENCE u1.seq;  
Sequence created.  
gSQL> COMMIT;  
gSQL> INSERT INTO u1.t1 VALUES ( u1.seq.NEXTVAL, u1.seq.NEXTVAL );  
1 row created  
gSQL> COMMIT;
```

Compatibility

The SQL standard covers the concepts of the user, but it does not define the SQL statements associated with the creation and deletion of user.

For More Information

Refer to the followings.

- [DROP USER](#)
- [ALTER USER](#)
- [CREATE SCHEMA](#)

16.92 CREATE VIEW

Function

It defines a view.

Syntax

```
<view definition> ::=  
    CREATE [ OR REPLACE ] [ FORCE | NO FORCE ]  
        VIEW view_name [ ( column_name [, ...] ) ]  
        AS <query expression>  
    ;
```

Invocation and Access Rules

The user should satisfy the following conditions to perform <view definition> statement.

- One of the following privileges is required to create a view.
 - (CREATE VIEW or CONTROL SCHEMA) ON SCHEMA for the schema to which the view belongs
 - CREATE ANY VIEW ON DATABASE
- When using OR REPLACE clause, if a view already exists, then one of the following privileges is required to remove the existing view.
 - The owner of that view
 - CONTROL TABLE ON TABLE for that view.
 - (DROP VIEW or CONTROL SCHEMA) ON SCHEMA for the schema to which the view belongs
 - DROP ANY VIEW ON DATABASE
- One of the following privileges is required for all tables used in <Query expression>.
 - SELECT(columns) ON TABLE for all columns used in the statement among table columns
 - (SELECT or CONTROL TABLE) ON TABLE for the table
 - (SELECT TABLE or CONTROL SCHEMA) ON SCHEMA for the schema to which the table belongs
 - SELECT ANY TABLE ON DATABASE
- The owner of the created view is determined as follows.

- The owner of the schema to which the view belongs.
- If the schema to which the view belongs is PUBLIC, then it is the user who executed the statement.
- The owner of the view has the following privileges for the created view.
 - SELECT ON TABLE WITH GRANT OPTION
 - INSERT ON TABLE WITH GRANT OPTION
 - UPDATE ON TABLE WITH GRANT OPTION
 - DELETE ON TABLE WITH GRANT OPTION
 - TRIGGER ON TABLE
 - LOCK ON TABLE WITH GRANT OPTION
 - ALTER ON TABLE WITH GRANT OPTION

Syntax Rules and Parameters

[OR REPLACE]

It replaces the existing view when a view already exists.

[FORCE | NO FORCE]

- FORCE
 - A view is created regardless of the validity of <query expression>.
- NO FORCE
 - A view is created when <Query expression> is valid.
- The default value is NO FORCE.

view_name

It is the view name to be created, and it should be a unique name within the schema.

The schema to which the view belongs, such as schema_name.view_name, can be defined. If schema_name is omitted, the default schema name of the user performing the statement is used.

The length of the view name must be shorter than 128 bytes.

[(column_name [, ...])]

It defines a column name which will configure the view.

Each column name should be unique within the view.

The number of columns should be as same as the number of result columns in SELECT clause.

If the list of column names is omitted, the column names of SELECT clause in <query expression> are used.

AS <query expression>

It is the SELECT query which will create a view.

<query expression> can not include the following variables.

- Host parameter
- SQL parameter
- Dynamic parameter
- Embedded variable
- SEQUENCE object

Description

A view is the object which gave a name to the query, and it is used in the similar way of a table.

When executing a query including the view, that view is interpreted as the query included in the view definition. If the table referenced by the view is altered, as the following example, the asterisk (*) included in the view definition is automatically interpreted based on the altered table information.

```
gSQL> CREATE VIEW v1 AS SELECT * FROM t1;
gSQL> COMMIT;
gSQL> SELECT * FROM v1;
ID NAME
-- -----
 1 leekmo
 2 mkkim
 3 egospace
3 rows selected.
gSQL> ALTER TABLE t1 ADD COLUMN ( dept_id INTEGER, addr VARCHAR(1024) );
gSQL> COMMIT;
gSQL> select * from v1;
ID NAME      DEPT_ID ADDR
-- -----
 1 leekmo      null null
 2 mkkim       null null
 3 egospace    null null
```

3 rows selected.

The view is affected if the view is created on the query including errors by using FORCE option, the tables referred by the view, or views are altered or deleted.

This information can be retrieved from INFORMATION_SCHEMA.VIEWS information.

- IS_COMPILED column
 - TRUE: The view is normally created.
 - FALSE: The view is created having an error by using FORCE option.
- IS_AFFECTED column
 - TRUE : The referenced tables by a view or view is altered.
 - FALSE: After a view is created and compiled, the referenced tables or views are not altered.

The maximum number of creating views and the maximum number of columns to be created within a view is not limited. Therefore, they can be created as many as the storage space is available.

Examples

The following is an example of creating a view.

```
gSQL> CREATE VIEW v1 AS SELECT * FROM t1 WHERE dept_id = 101;
View created.
```

The following is an example of defining the column names when defining a view.

```
gSQL> CREATE VIEW v1 ( v_id, v_name )
      AS SELECT id, name FROM t1 WHERE dept_id = 101;
View created.
```

The following is an example of removing the existing view and creating a new view by using REPLACE option.

```
gSQL> CREATE OR REPLACE VIEW v1(id, name)
      AS SELECT id, name FROM t1;
View created.
```

The following is an example of forcing to create a view by using FORCE option even when the referenced object by the view does not exist.

```

gSQL> CREATE FORCE VIEW v1
        AS SELECT * FROM t1 WHERE dept_id = 101;
ERR-01000(16243): Warning: View created with compilation errors
ERR-42000(16040): table or view does not exist :
        AS SELECT * FROM t1 WHERE dept_id = 101
                *
ERROR at line 2:
View created.

```

Compatibility

The SQL standard does not define the following clauses.

- [OR REPLACE] clause
- [FORCE | NO FORCE] clause

Table 16-33 SQL standard compatibility

Feature ID	Description	Compatibility
T131	Recursive query	X
F751	View CHECK enhancements	X
S043	Enhanced reference types	X
T111	Updatable joins, unions, and columns	X
F852	Top-level <order by clause> in views	O
F864	Top-level <result offset clause> in views	O
F859	Top-level <fetch first clause> in views	O
S081	Subtables	X

For More Information

Refer to the followings.

- DROP VIEW
- ALTER VIEW
- SELECT

16.93 DECLARE cursor_name

Function

It declares a cursor.

Syntax

```

<declare cursor> ::=
    DECLARE cursor_name <cursor properties> { FOR | IS } <cursor specification>
    ;
<cursor properties> ::=
    [ <cursor sensitivity> ] [ <cursor scrollability> ] CURSOR [ <cursor holdability> ]
    | [ <odbc cursor type> ] CURSOR [ <cursor holdability> ]
<cursor sensitivity> ::=
    INSENSITIVE
    | SENSITIVE
    | ASENSITIVE
<cursor scrollability> ::=
    NO SCROLL
    | SCROLL
<cursor holdability> ::=
    WITH HOLD
    | WITHOUT HOLD
<odbc cursor type> ::=
    STATIC
    | KEYSET
<cursor specification> ::=
    statement_name
    | <cursor query> [ <updatability clause> ]
<cursor query> ::=
    <select statement>
    | <insert returning query statement>
    | <update returning query statement>
    | <delete returning query statement>
<updatability clause> ::=
    FOR READ ONLY
  
```

```

| FOR UPDATE [ OF <column name list> ] [ <lock wait mode> ]
<lock wait mode> ::=
| WAIT
| WAIT second
| NOWAIT

```

Invocation and Access Rules

The dynamic cursor which uses `statement_name` can be used in an embedded SQL.

An appropriate access privilege is required depending on `<cursor query>` types. For more information about the access privileges, refer to the followings.

- The access privilege of a **SELECT** statement
- The access privilege of a **SELECT .. FOR UPDATE** statement
- The access privilege of a **INSERT INTO name RETURNING** statement
- The access privilege of a **UPDATE name RETURNING** statement
- The access privilege of a **DELETE FROM name RETURNING** statement

Syntax Rules and Parameters

`cursor_name`

It is the cursor name to be declared.

It should be a unique name within the session.

The length of cursor name should be shorter than 128 bytes.

{ FOR | IS }

Either FOR or IS is used as a syntax keyword in SQL standard.

<cursor properties>

It defines the cursor properties.

- If `<cursor sensitivity>` is not specified, the default value is **INSENSITIVE**.
- If `<cursor scrollability>` is not specified, the default value is **NO SCROLL**.
- If `<cursor holdability>` is not specified, the default value is determined by `<cursor updatability>`.

updatable query

To use a cursor property such as SENSITIVE or FOR UPDATE, a query of the cursor should identify changes in rows of the base table, or it should be the updatable query which can acquire a lock on the row.

The updatable query should satisfy all of the following conditions.

- DISTINCT should not exist at the top level query.
 - (X) SELECT DISTINCT * FROM t1;
- GROUP BY, HAVING, aggregation function should not exist at the top level query.
 - (X) SELECT MAX(c1) FROM t1;
- A returning query should not exist.
 - (X) DELETE FROM t1 RETURNING c1;
- Set operator should not exist.
 - (X) SELECT * FROM t1 UNION ALL SELECT * FROM t2;
- At least one updatable column is required on the listed tables in FROM clause.
 - The columns of the tables, which are included in join operations and are not used in the cross join, are not the updatable columns.
 - FULL OUTER JOIN is not cross join.
 - NATURAL JOIN is not cross join.
 - If INNER JOIN uses USING phrase, it is not cross join.
 - The columns of the following tables are not the updatable columns.
 - Dictionary table, fixed table, performance view
 - The columns of the view are not updatable tables.

<cursor sensitivity>

It determines whether the following data changes which affects the query results can be queried when operating the cursor.

- INSENSITIVE
 - It can not detect the data updated during the cursor operation.
- SENSITIVE
 - <cursor query> should be an updatable query.
 - It detects the updated and deleted data in the transaction as same as that of the cursor.
 - It detects the data updated and deleted through COMMIT of other transactions.
- ASENSITIVE
 - INSENSITIVE or SENSITIVE is determined depending on the type of <cursor query>.
 - For the updatable query, it is SENSITIVE.
 - For no updatable query, it is INSENSITIVE.
- If it is not specified, the default value is INSENSITIVE.

<cursor scrollability>

It specifies whether the result set of the cursor can be fetched sequentially or non-sequentially.

- NO SCROLL
 - Only sequential FETCH (FETCH NEXT) is possible.
- SCROLL
 - Non-sequential FETCH is possible.
- If not specified, the default value is NO SCROLL.

<cursor holdability>

It determines whether the cursor is maintained after the cursor is OPEN and the transaction is committed.

- WITH HOLD
 - The cursor is maintained after the transaction is committed.
 - It can not be used together with FOR UPDATE statement.
 - It can not be used together with **INSERT INTO name RETURNING** statement.
 - It can not be used together with **UPDATE name RETURNING** statement.
 - It can not be used together with **DELETE FROM name RETURNING** statement.
- WITHOUT HOLD
 - When the transaction is committed or rolled back, the cursor is closed.
- Rollback and cursor
 - It closes a cursor included in a transaction when rolling back the transaction.
 - It closes a cursor created since the savepoint when rolling back up to the savepoint.
- If not specified, the default value of <cursor holdability> is determined by <cursor updatability>.
 - If it is FOR READ ONLY or <cursor updatability> is not specified, the default value is WITH HOLD.
 - If it is used together with FOR UPDATE statement, the default value is WITHOUT HOLD.

<odbc cursor type>

It is the cursor type in the ODBC standard, and it has the SCROLL property.

- STATIC CURSOR
 - It is as same as INSENSITIVE SCROLL in SQL standard.
 - Non-sequential FETCH is possible.
 - It is the static scroll cursor in the ODBC standard.
- KEYSSET CURSOR
 - It is as same as ASENSITIVE SCROLL in SQL standard.
 - It is the keyset-driven scroll cursor in the ODBC standard.

- The property of sensitivity is determined according to the following characteristics.

Table 16-34 Sensitivity according to FOR [UPDATE / READ ONLY] statement and the query type

Updatability	Query type	Sensitivity
FOR UPDATE	Updatable query	SENSITIVE
FOR UPDATE	Non-updatable query	Query error
FOR READ ONLY	Any query	INSENSITIVE
N/A	Updatable query	SENSITIVE
N/A	Non-updatable query	INSENSITIVE

<cursor specification>

It defines a query which is a target of the cursor.

If statement_name is used, a dynamic cursor whose query has not been defined is declared.

If <cursor query> is used, a standing cursor whose query is defined is declared.

statement_name

It is a statement_name to be referenced by the cursor, and it can be used in an embedded SQL.

statement_name should exist before performing <declare cursor> statement, and the SQL statement referenced by statement_name should be the query prepared by **PREPARE statement_name** statement.

If it is not a query, an error occurs when executing **OPEN cursor_name** statement.

<cursor query>

For more information about available query types in the cursor, refer to the followings.

- SELECT
- SELECT .. FOR UPDATE
- INSERT INTO name RETURNING
- UPDATE name RETURNING
- DELETE FROM name RETURNING

<updatability clause>

It specifies whether to change rows by using the cursor.

- FOR READ ONLY
 - It declares a read-only cursor.

- FOR UPDATE
 - It declares a writable cursor.
 - When opening the cursor, the x lock for the corresponding rows is acquired to prevent the change by other transactions until the transaction is completed.
 - It can not be used together with WITH HOLD statement.
 - <cursor query> should be an updatable query.
- If not specified, the default value is FOR READ ONLY.

FOR UPDATE OF ...

It lists the columns associated with the lock obtaining when OPENing the cursor.

- If it is the columns listed in FOR UPDATE OF statement
 - It should be an updatable column of the table listed in FROM clause of <select statement>.
 - It acquires the lock for the table of listed columns.
- If only FOR UPDATE statement is used
 - It is the same meaning as listing all updatable columns of the table in FROM clause of <select statement>.
 - It acquires the lock for the table of all columns.

<lock wait mode>

It is used together with FOR UPDATE clause, and it specifies the lock acquisition method.

- WAIT
 - It acquires the lock for all rows of the query result when OPENing the cursor.
 - It waits until acquiring the lock.
- WAIT second
 - It acquires the lock for all rows of the query result when OPENing the cursor.
 - An error occurs if the lock is not acquired within the specified time.
 - The wait time is in seconds, and it can use the value between 0 and 1000000000.
- NOWAIT
 - It acquires the lock for all rows of the query result when OPENing the cursor.
 - An error occurs if the lock is not immediately acquired.
- If not specified, the default value is WAIT.

Description

When controlling the query property, using DECLARE CURSOR, OPEN, FETCH, CLOSE statements have the performance burden compared to using the cursor with the ODBC or JDBC statements. It is because usi

ng DECLARE CURSOR, OPEN, FETCH, CLOSE statements control the cursor of the server.

Before executing the query, the cursor property can be controlled by ODBC statement and JDBC statement. The SQL cursor property control method by DECLARE CURSOR statement, and cursor property control method by the ODBC standard and the JDBC standard are as follows.

Table 16-35 Controlling the cursor property of ODBC/ JDBC

Property	GOLDILOCKS cursor property	ODBC standard cursor property	JDBC standard cursor property
Sensitivity	INSENSITIVE	SQLSetStmtAttr(stmt, SQL_ATTR_CURSOR_SENSITIVITY, SQL_INSENSITIVE, len)	It can not be set.
	SENSITIVE	SQLSetStmtAttr(stmt, SQL_ATTR_CURSOR_SENSITIVITY, SQL_SENSITIVE, len)	It can not be set.
	ASENSITIVE	SQLSetStmtAttr(stmt, SQL_ATTR_CURSOR_SENSITIVITY, SQL_UNSPECIFIED, len)	It can not be set.
Scrollability	NO SCROLL	SQLSetStmtAttr(stmt, SQL_ATTR_CURSOR_SCROLLABLE, SQL_NONSCROLLABLE, len)	It can not be set.
	SCROLL	SQLSetStmtAttr(stmt, SQL_ATTR_CURSOR_SCROLLABLE, SQL_SCROLLABLE, len)	It can not be set.
Holdability	WITHOUT HOLD	It can not be set.	java.sql.Connection::prepareStatement(query, type, conc, ResultSet.CLOSE_CURSORS_AT_COMMIT)
	WITH HOLD	It can not be set.	java.sql.Connection::prepareStatement(query, type, conc, ResultSet.HOLD_CURSORS_OVER_COMMIT)

SQL cursor declaration corresponding to ODBC cursor type is as follows.

Table 16-36 SQL cursor declaration corresponding to ODBC cursor type

ODBC cursor type	SQL cursor declaration
SQLSetStmtAttr(stmt, SQL_ATTR_CURSOR_TYPE, SQL_CURSOR_FORWARD_ONLY, len)	NO SCROLL CURSOR
SQLSetStmtAttr(stmt, SQL_ATTR_CURSOR_TYPE, SQL_CURSOR_STATIC, len)	STATIC CURSOR
SQLSetStmtAttr(stmt, SQL_ATTR_CURSOR_TYPE, SQL_CURSOR_KEYSET_DRIVEN, len)	KEYSET CURSOR

SQL cursor declaration corresponding to JDBC cursor type is as follows.

Table 16-37 SQL cursor declaration corresponding to JDBC cursor type

JDBC cursor type	SQL cursor declaration
java.sql.Connection::prepareStatement(query, ResultSet.TYPE_FORWARD_ONLY, conc, hold)	INSENSITIVE NO SCROLL CURSOR
java.sql.Connection::prepareStatement(query, ResultSet.TYPE_SCROLL_INSENSITIVE, conc, hold)	INSENSITIVE SCROLL CURSOR
java.sql.Connection::prepareStatement(query, ResultSet.TYPE_SCROLL_SENSITIVE, conc, hold)	KEYSET CURSOR

Examples

The following is an example of declaring the cursor by using interactive SQL (gsq), and using it.

```
gsqSQL> DECLARE cur1 CURSOR FOR SELECT id, data FROM t1;
Cursor declared.
gsqSQL> OPEN cur1;
Cursor is open.
gsqSQL> \var v_id    INTEGER
gsqSQL> \var v_data VARCHAR(128)
gsqSQL> FETCH cur1 INTO :v_id, :v_data;
V_ID V_DATA
----
      1 data_1
1 row fetched.
gsqSQL> FETCH cur1 INTO :v_id, :v_data;
V_ID V_DATA
----
      2 data_2
1 row fetched.
gsqSQL> FETCH cur1 INTO :v_id, :v_data;
V_ID V_DATA
----
      3 data_3
1 row fetched.
gsqSQL> FETCH cur1 INTO :v_id, :v_data;
V_ID V_DATA
----
      4 data_4
1 row fetched.
```

```

gSQL> FETCH cur1 INTO :v_id, :v_data;
V_ID V_DATA
----
5 data_5
1 row fetched.
gSQL> FETCH cur1 INTO :v_id, :v_data;
no rows fetched.
gSQL> CLOSE cur1;
Cursor closed.

```

The following is an example of declaring KEYSET cursor, sequentially searching, then completing the transaction of UPDATE, DELETE statements, and searching for it in the reverse direction.

```

gSQL> DECLARE cur_keyset KEYSET CURSOR FOR SELECT id, data FROM t1;
Cursor declared.
gSQL> OPEN cur_keyset;
Cursor is open.
gSQL> \var v_id INTEGER
gSQL> \var v_data VARCHAR(128)
gSQL> FETCH NEXT cur_keyset INTO :v_id, :v_data;
V_ID V_DATA
----
1 data_1
1 row fetched.
gSQL> FETCH NEXT cur_keyset INTO :v_id, :v_data;
V_ID V_DATA
----
2 data_2
1 row fetched.
gSQL> FETCH NEXT cur_keyset INTO :v_id, :v_data;
V_ID V_DATA
----
3 data_3
1 row fetched.
gSQL> FETCH NEXT cur_keyset INTO :v_id, :v_data;
V_ID V_DATA
----
4 data_4
1 row fetched.
gSQL> FETCH NEXT cur_keyset INTO :v_id, :v_data;
V_ID V_DATA

```

```

-----
      5 data_5
1 row fetched.
gSQL> FETCH NEXT cur_keyset INTO :v_id, :v_data;
no rows fetched.
gSQL> UPDATE t1 SET data = 'new data_2' WHERE id = 2;
1 row updated.
gSQL> COMMIT;
Commit complete.
gSQL> DELETE FROM t1 WHERE id = 4;
1 row deleted.
gSQL> COMMIT;
Commit complete.
gSQL> FETCH PRIOR cur_keyset INTO :v_id, :v_data;
V_ID V_DATA
-----
      5 data_5
1 row fetched.
gSQL> FETCH PRIOR cur_keyset INTO :v_id, :v_data;
no rows fetched.
gSQL> FETCH PRIOR cur_keyset INTO :v_id, :v_data;
V_ID V_DATA
-----
      3 data_3
1 row fetched.
gSQL> FETCH PRIOR cur_keyset INTO :v_id, :v_data;
V_ID V_DATA
-----
      2 new data_2
1 row fetched.
gSQL> FETCH PRIOR cur_keyset INTO :v_id, :v_data;
V_ID V_DATA
-----
      1 data_1
1 row fetched.
gSQL> CLOSE cur_keyset;
Cursor closed.

```

The following is an example of declaring SCROLL cursor, and using the cursor through the fetch orientation.

```
gSQL> DECLARE cur_scroll SCROLL CURSOR FOR SELECT id, data FROM t1;
Cursor declared.
gSQL> OPEN cur_scroll;
Cursor is open.
gSQL> \var v_id INTEGER
gSQL> \var v_data VARCHAR(128)
gSQL> FETCH LAST cur_scroll INTO :v_id, :v_data;
V_ID V_DATA
----
5 data_5
1 row fetched.
gSQL> FETCH PRIOR cur_scroll INTO :v_id, :v_data;
V_ID V_DATA
----
4 data_4
1 row fetched.
gSQL> FETCH FIRST cur_scroll INTO :v_id, :v_data;
V_ID V_DATA
----
1 data_1
1 row fetched.
gSQL> FETCH ABSOLUTE 3 cur_scroll INTO :v_id, :v_data;
V_ID V_DATA
----
3 data_3
1 row fetched.
gSQL> FETCH RELATIVE -1 cur_scroll INTO :v_id, :v_data;
V_ID V_DATA
----
2 data_2
1 row fetched.
gSQL> FETCH ABSOLUTE 3 cur_scroll INTO :v_id, :v_data;
V_ID V_DATA
----
3 data_3
1 row fetched.
gSQL> CLOSE cur_scroll;
Cursor closed.
```

Compatibility

<declare cursor> statement has the following differences compared to the SQL standard.

- In SQL standard, the default value of <cursor sensitivity> is ASENSITIVE, but in GOLDILOCKS, the default value is INSENSITIVE.
- The SQL standard does not cover the following <odbc cursor type>.
 - STATIC CURSOR
 - KEYSSET CURSOR
- In SQL standard, the default value of <cursor holdability> is WITHOUT HOLD, but in GOLDILOCKS, the default value depends on <cursor updatability>.
- SQL standard can use only <select statement> as <cursor query>, but GOLDILOCKS can use the returning query as follows.
 - **INSERT INTO name RETURNING**
 - **UPDATE name RETURNING**
 - **DELETE FROM name RETURNING**
- In SQL standard, the default value of <cursor updatability> is determined by <select statement>, but in GOLDILOCKS the default value is FOR READ ONLY.
- In SQL standard, <lock wait mode> statement does not exist.

Table 16-38 SQL standard compatibility

Feature ID	Description	Compatibility
F831	Full cursor update	O
T231	Sensitive cursors	O
F791	Insensitive cursors	O
F431	Read-only scrollable cursors	O
T471	Result sets return value	X
T551	Optional key words for default syntax	O
T111	Updatable joins, unions, and columns	X
B031	Basic dynamic SQL	O

For More Information

Refer to the followings.

- **OPEN cursor_name**
- **FETCH cursor_name**
- **CLOSE cursor_name**
- **PREPARE statement_name**

- SELECT
- SELECT .. FOR UPDATE
- INSERT INTO name RETURNING
- UPDATE name RETURNING
- DELETE FROM name RETURNING

16.94 DELETE FROM

Function

It deletes rows in a table.

Syntax

```
<delete statement: searched> ::=
    DELETE [ FROM ] table_name [ [ AS ] alias_name ]
        [ WHERE <search condition> ]
        [ <result offset clause> ]
        [ <fetch limit clause> ]
    ;
<result offset clause> ::=
    OFFSET skip_count [ ROW | ROWS ]
<fetch limit clause> ::=
    <fetch first clause>
    | <limit clause>
<fetch first clause> ::=
    FETCH [ FIRST | NEXT ] [ row_count ] [ ROW ONLY | ROWS ONLY ]
<limit clause>
    LIMIT { fetch_row_count | offset_row_count, fetch_row_count | ALL }
```

Invocation and Access Rules

One of the following privileges is required to perform <delete statement: searched>.

- (DELETE or CONTROL TABLE) ON TABLE for the table
- (DELETE TABLE or CONTROL SCHEMA) ON SCHEMA for the schema to which the table belongs
- DELETE ANY TABLE ON DATABASE

Syntax Rules and Parameters

table_name

It is the name of a target table whose rows are to be deleted.

It defines the schema to which the table belongs such as schema_name.table_name.

If schema_name is omitted, the default schema name of the user performing the statement is used.

[AS alias_name]

It is the alias of table_name.

WHERE <search condition>

It deletes the rows which satisfy WHERE condition.

If WHERE condition is omitted, it deletes all rows.

For more information about WHERE condition, refer to **where clause** of SELECT statement.

<result offset clause>

It specifies the number of rows to be skipped among the query result.

For more information, refer to **offset limit clause** of SELECT statement.

<fetch limit clause>

The following two ways are used to specify the number of rows to be fetched.

- <fetch first clause>
 - It specifies the number of rows to be fetched.
 - For more information, refer to **<fetch first clause>** of SELECT statement.
- <limit clause>
 - It specifies the number of rows to be fetched, or it simultaneously specifies both the number of rows to be skipped and the number of rows to be fetched.
 - For more information, refer to **<limit clause>** of SELECT statement.

Description

Differences among DELETE-related Statements

- **DELETE FROM**
 - It deletes multiple rows which satisfy conditions.
 - e.g. DELETE FROM t1 WHERE c1 = 0;
- **DELETE FROM name WHERE CURRENT OF cursor_name**
 - It deletes the row which the current cursor indicates.
 - e.g. DELETE FROM t1 WHERE CURRENT OF cursor;
- **DELETE FROM name RETURNING**
 - It deletes multiple rows which satisfy the conditions, and the deleted rows can be retrieved in the same way as SELECT statement (API such as SQLFetch ()).
 - e.g. DELETE FROM t1 WHERE c1 = 0 RETURNING c2;
- **DELETE FROM name RETURNING .. INTO**
 - It deletes row equal to or less than one, and if one row is deleted, the value is obtained into the host variable of RETURNING INTO clause.
 - e.g. DELETE FROM t1 WHERE c1 = 0 RETURNING c2 INTO :v1;

Examples

The following is an example of DELETE statement.

```
gSQL> DELETE FROM t1 WHERE id > 3;
2 rows deleted.
```

The following is an example of skipping some rows (two rows) and deleting some rows (two rows) among the rows which satisfy the conditions by using <result offset clause> and <fetch first clause> clauses.

```
gSQL> DELETE FROM t1 OFFSET 2 FETCH 2;
2 rows deleted.
gSQL> SELECT * FROM t1 ORDER BY 1;
ID DATA
-- -----
1 data_1
2 data_2
5 data_5
3 rows selected.
```

Compatibility

The SQL standard does not define the following clauses of DELETE statement.

- <result offset clause>
- <fetch limit clause>

Table 16-39 SQL standard compatibility

Feature ID	Description	Compatibility
F781	Self-referencing operations	X
T111	Updatable joins, unions, and columns	X

For More Information

Refer to the followings.

- DELETE FROM name WHERE CURRENT OF cursor_name
- DELETE FROM name RETURNING
- DELETE FROM name RETURNING .. INTO
- SELECT

16.95 DELETE FROM name RETURNING

Function

It deletes rows of the table, and retrieves the deleted rows.

Syntax

```

<delete returning query statement> ::=
    DELETE [ FROM ] table_name [ [ AS ] alias_name ]
        [ WHERE <search condition> ]
        [ <result offset clause> ]
        [ <fetch limit clause> ]
        <returning clause>
    ;
<result offset clause> ::=
    OFFSET skip_count [ ROW | ROWS ]
<fetch limit clause> ::=
    <fetch first clause>
    | <limit clause>
<fetch first clause> ::=
    FETCH [ FIRST | NEXT ] [ row_count ] [ ROW ONLY | ROWS ONLY ]
<limit clause>
    LIMIT { fetch_row_count | offset_row_count, fetch_row_count | ALL }
<returning clause> ::=
    { RETURN | RETURNING } { * | { <value expression> [ [AS] alias_name ] } [, ...] }

```

Invocation and Access Rules

The user should satisfy the following conditions to perform <delete returning query statement>.

- One of the following privileges is required to perform DELETE statement.
 - (DELETE or CONTROL TABLE) ON TABLE for the table
 - (DELETE TABLE or CONTROL SCHEMA) ON SCHEMA for the schema to which the table belongs
 - DELETE ANY TABLE ON DATABASE

- One of the following privileges is required for all the columns used in RETURNING clause.
 - SELECT(columns) ON TABLE for all columns used in RETURNING clause.
 - (SELECT or CONTROL TABLE) ON TABLE for the table
 - (SELECT TABLE or CONTROL SCHEMA) ON SCHEMA for the schema to which the table belongs
 - SELECT ANY TABLE ON DATABASE

Syntax Rules and Parameters

table_name

It is the name of a target table whose rows are to be deleted.

[AS alias_name]

It is the alias of table_name.

WHERE <search condition>

It deletes the rows which satisfy WHERE condition.

For more information, refer to **DELETE FROM** statement.

<result offset clause>

It specifies the number of rows to be skipped among the query result.

For more information, refer to **DELETE FROM** statement.

<fetch first clause>

It specifies the number of rows to be fetched.

For more information, refer to **DELETE FROM** statement.

<limit clause>

It specifies the number of rows to be fetched, or it simultaneously specifies both the number of rows to be skipped and the number of rows to be fetched.

For more information, refer to **DELETE FROM** statement.

<returning clause>

It sets the deleted rows as a result set, and it specifies the columns to be searched from the set.

- RETURNING clause returns the rows deleted by DELETE statement as a result set.
- <value expression>
 - It is as same as <select list> of SELECT statement, but it can not use aggregation.
- [[AS] alias_name]
 - It can give the name to the value expression by using AS clause.

The keywords RETURNING and RETURN have the same meaning.

Description

For more information, refer to [Differences among DELETE-related Statements](#).

Examples

The following is an example of deleting rows which satisfy the condition, and searching for the deleted rows.

```
gSQL> DELETE FROM t1 WHERE id > 3 RETURNING *;
ID DATA
-- -----
 4 data_4
 5 data_5
2 rows deleted.
```

The following is an example of querying information of the deleted rows by using operation in RETURNING clause.

```
gSQL> DELETE FROM t1
        WHERE id > 3
        RETURNING 'ID: ' || id || ', DATA: ' || data AS id_data;
ID_DATA
-----
ID: 4, DATA: data_4
ID: 5, DATA: data_5
2 rows deleted.
```

Compatibility

The SQL standard does not cover <delete returning query statement>.

For More Information

Refer to the followings.

- DELETE FROM
- DELETE FROM name WHERE CURRENT OF cursor_name
- DELETE FROM name RETURNING .. INTO
- SELECT

16.96 DELETE FROM name RETURNING .. INTO

Function

It deletes a single row from the table, and the value of the deleted row is obtained into the host variable.

Syntax

```

<delete returning query statement> ::=
    DELETE [ FROM ] table_name [ [ AS ] alias_name ]
        [ WHERE <search condition> ]
        [ <result offset clause> ]
        [ <fetch limit clause> ]
        <returning into clause>
    ;
<result offset clause> ::=
    OFFSET skip_count [ ROW | ROWS ]
<fetch limit clause> ::=
    <fetch first clause>
    | <limit clause>
<fetch first clause> ::=
    FETCH [ FIRST | NEXT ] [ row_count ] [ ROW ONLY | ROWS ONLY ]
<limit clause>
    LIMIT { fetch_row_count | offset_row_count, fetch_row_count | ALL }
<returning into clause> ::=
    { RETURN | RETURNING } { * | { <value expression> [ [AS] alias_name ] } [, ...] } INTO
    variable_name [, ...]

```

Invocation and Access Rules

The user should satisfy the following conditions to perform <delete returning into statement>.

- One of the following privileges is required to perform DELETE statement.
 - (DELETE or CONTROL TABLE) ON TABLE for the table
 - (DELETE TABLE or CONTROL SCHEMA) ON SCHEMA for the schema to which the table belongs

- DELETE ANY TABLE ON DATABASE
- One of the following privileges is required for all columns used in RETURNING clause.
 - SELECT(columns) ON TABLE for all columns used in RETURNING clause
 - (SELECT or CONTROL TABLE) ON TABLE for the table
 - (SELECT TABLE or CONTROL SCHEMA) ON SCHEMA for the schema to which the table belongs
 - SELECT ANY TABLE ON DATABASE

Syntax Rules and Parameters

table_name

It is the name of a target table whose rows are to be deleted.

[AS alias_name]

It is the alias of table_name.

WHERE <search condition>

It deletes the rows which satisfy WHERE condition.
For more information, refer to **DELETE FROM** statement.

<result offset clause>

It specifies the number of rows to be skipped among the query result.
For more information, refer to **DELETE FROM** statement.

<fetch first clause>

It specifies the number of rows to be fetched.
For more information, refer to **DELETE FROM** statement.

<limit clause>

It specifies the number of rows to be fetched, or it simultaneously specifies both the number of rows to be skipped and the number of rows to be fetched.
For more information, refer to **DELETE FROM** statement.

⟨returning into clause⟩

- RETURNING .. AS ..
 - For more information, refer to ⟨returning clause⟩ of **16.95 DELETE FROM name RETURNING** statement.
- INTO variable_name [, ...]
 - The number of variables specified in INTO clause should be equal to the number of the expressions specified in RETURNING clause.

Description

The number of rows to be deleted should be equal to or less than one. If two or more rows are deleted, then an error occurs.

For more information, refer to **Differences among DELETE-related Statements**.

Example

The following is an example of deleting rows and obtaining the value of deleted rows into the host variable in an interactive SQL (gsq).

```
gsqSQL> \var v_id    INTEGER
gsqSQL> \var v_data  VARCHAR(128)
gsqSQL> DELETE FROM t1 WHERE id = 3 RETURNING id, data INTO :v_id, :v_data;
V_ID V_DATA
---- -
      3 data_3
1 row deleted.
```

Compatibility

The SQL standard does not cover ⟨delete returning into statement⟩.

For More Information

Refer to the followings.

- **DELETE FROM**
- **DELETE FROM name WHERE CURRENT OF cursor_name**
- **DELETE FROM name RETURNING**
- **SELECT**

16.97 DELETE FROM name WHERE CURRENT OF cursor_name

Function

It deletes a single row which the cursor indicates.

Syntax

```
<delete statement: positioned> ::=  
    DELETE [ FROM ] table_name [ [ AS ] alias_name ]  
        WHERE CURRENT OF cursor_name  
    ;
```

Invocation and Access Rules

The privilege to perform **DELETE FROM** statement is required to perform <delete statement: positioned>.

Syntax Rules and Parameters

table_name

It is the name of a target table whose rows are to be deleted.

[AS alias_name]

It is the alias of table_name.

cursor_name

The cursor corresponding to cursor_name should satisfy the following conditions.

- The cursor should be OPEN. (Refer to **OPEN cursor_name**.)

- Fetched rows by using the cursor should exist. (Refer to **FETCH cursor_name.**)
- The query used for the cursor should identify table_name. (Refer to **DECLARE cursor_name.**)
- The cursor should be updatable for table_name. (Refer to **DECLARE cursor_name.**)

Description

For more information, refer to **Differences among DELETE-related Statements.**

Example

The following is an example of declaring the FOR UPDATE cursor, and deleting rows by using the cursor in interactive SQL (gsq).

```
gsq> DECLARE cur1 CURSOR FOR SELECT id, data FROM t1 FOR UPDATE;
Cursor declared.
gsq> OPEN cur1;
Cursor is open.
gsq> \var v_id    INTEGER
gsq> \var v_data VARCHAR(128)
gsq> FETCH cur1 INTO :v_id, :v_data;
V_ID V_DATA
---- -
      1 data_1
1 row fetched.
gsq> FETCH cur1 INTO :v_id, :v_data;
V_ID V_DATA
---- -
      2 data_2
1 row fetched.
gsq> DELETE FROM t1 WHERE CURRENT OF cur1;
1 row deleted.
gsq> FETCH cur1 INTO :v_id, :v_data;
V_ID V_DATA
---- -
      3 data_3
1 row fetched.
gsq> FETCH cur1 INTO :v_id, :v_data;
V_ID V_DATA
```

```

-----
      4 data_4
1 row fetched.
gSQL> DELETE FROM t1 WHERE CURRENT OF cur1;
1 row deleted.
gSQL> FETCH cur1 INTO :v_id, :v_data;
V_ID V_DATA
-----
      5 data_5
1 row fetched.
gSQL> FETCH cur1 INTO :v_id, :v_data;
no rows fetched.
gSQL> CLOSE cur1;
Cursor closed.
gSQL> SELECT id, data FROM t1 ORDER BY 1;
ID DATA
-- -----
      1 data_1
      3 data_3
      5 data_5
3 rows selected.

```

Compatibility

Table 16-40 SQL standard compatibility

Feature ID	Description	Compatibility
S111	ONLY in query expressions	X
B031	Basic dynamic SQL	O

For More Information

Refer to the followings.

- **DECLARE** cursor_name
- **OPEN** cursor_name
- **FETCH** cursor_name
- **DELETE FROM**
- **DELETE FROM** name **RETURNING**

DELETE FROM name WHERE CURRENT OF cursor_name | 1,881

- DELETE FROM name RETURNING .. INTO

16.98 DROP AUDIT POLICY

Function

It drops an audit policy.

Syntax

```
<drop audit policy statement> ::=  
    DROP AUDIT POLICY [ IF EXISTS ] policy_name  
;
```

Invocation and Access Rules

AUDIT SYSTEM ON DATABASE privilege is required to perform <drop audit policy statement>.

Syntax Rules and Parameters

IF EXISTS

An error does not occur even when a policy_name does not exist.

policy_name

It is the name of an audit policy object to be dropped.

Description

The audit policy object which is already activated can not be dropped. In this case, the audit policy should be deactivated by using NOAUDIT POLICY statement.

Examples

The following is an example of dropping an audit policy.

```
DROP AUDIT POLICY policy_table;
```

Compatibility

In the SQL standard, an audit policy does not exist.

For More Information

Refer to the followings.

- Managing audit policy object
 - CREATE AUDIT POLICY
 - DROP AUDIT POLICY
 - ALTER AUDIT POLICY
- Activating/ deactivating audit policy
 - AUDIT POLICY
 - NOAUDIT POLICY
- Retrieving audit trail: **AUDIT_TRAIL**
- Clearing audit trail: **ALTER DATABASE CLEAR AUDIT TRAIL**

16.99 DROP CLUSTER GROUP

Function

It drops a cluster group from a cluster system.

Syntax

```
<drop cluster group statement> ::=  
    DROP CLUSTER GROUP [IF EXISTS] group_name  
    ;
```

Invocation and Access Rules

It can be performed in a cluster system.

ADMINISTRATION ON DATABASE privilege is required to perform <drop cluster group statement>.

Syntax Rules and Parameters

[IF EXISTS]

An error does not occur even when a cluster group does not exist.

group_name

It is the name of a cluster group.

A cluster group without any shard can be dropped.

Description

A cluster group can be dropped only when dropping the cluster group does not cause the data loss.

Examples

The following is an example of dropping a cluster group.

```
gSQL> DROP CLUSTER GROUP g3;  
Cluster Group dropped.
```

Compatibility

The SQL standard does not define the concepts of the cluster.

For More Information

Refer to [CREATE CLUSTER GROUP](#).

16.100 DROP CLUSTER LOCATION

Function

It drops the access information of a cluster member.

Syntax

```
<drop cluster location statement> ::=  
    DROP CLUSTER LOCATION member_name  
    ;
```

Invocation and Access Rules

It can be performed in a cluster system.

ADMINISTRATION ON DATABASE privilege is required to perform <drop cluster location statement>.

Syntax Rules and Parameters

member_name

It is the name of a cluster member.

The same cluster member name should exist in a registered cluster location information.

The length of the name should be shorter than 128 bytes.

Description

Generally, the information of the cluster location is automatically created by using the connection information provided when creating the cluster group or adding the cluster member. The created information is deleted together when deleting the cluster member and the cluster group.

If the access information of the cluster location is modified, then the connection information can be modi

fied by using **ALTER CLUSTER LOCATION** without deleting or recreating the cluster member.

Example

```
gSQL>  
DROP CLUSTER LOCATION g1n2  
;  
Created
```

Compatibility

The SQL standard does not define the concepts of the cluster.

For More Information

Refer to the followings.

- **CREATE CLUSTER LOCATION**
- **ALTER CLUSTER LOCATION**

16.101 DROP INDEX

Function

It drops an index.

Syntax

```
<drop index statement> ::=  
    DROP INDEX [ IF EXISTS ] index_name  
    ;
```

Invocation and Access Rules

One of the following privileges is required to perform <drop index statement>.

- The owner of that index
- The owner of the table to which the index belongs
- CONTROL TABLE ON TABLE for the table to which the index belongs
- (DROP INDEX or CONTROL SCHEMA) ON SCHEMA for the schema to which the index belongs
- DROP ANY INDEX ON DATABASE

Syntax Rules and Parameters

IF EXISTS

Even when the index does not exist, an error does not occur.

index_name

It is the index name to be dropped.

It can define schema to which the index belongs such as schema_name.index_name and if schema_name is omitted, the default schema name of the user performing the statement is used.

The indexes created for UNIQUE constraint, PRIMARY KEY constraint can not be dropped. To drop the indexes created for the constraints above, the constraints should be removed through **ALTER TABLE name DROP CONSTRAINT** statement.

Description

Data Definition Language (DDL) statement such as DROP INDEX can be rolled back if it is before when the transaction is committed.

Examples

The following is an example of dropping an index.

```
gSQL> DROP INDEX idx_t1_id;  
Index dropped.
```

The following is an example of preventing an error even when the index does not exist by using IF EXISTS statement.

```
gSQL> DROP INDEX IF EXISTS not_exist_index;  
Index dropped.
```

Compatibility

The SQL standard does not cover the concepts of the index.

For More Information

Refer to the followings.

- CREATE INDEX
- DROP TABLE
- ALTER TABLE name DROP CONSTRAINT

16.102 DROP PROFILE

Function

It drops a profile.

Syntax

```
<drop profile statement> ::=  
    DROP PROFILE [ IF EXISTS ] profile_name [ CASCADE ] ;
```

Invocation and Access Rules

DROP PROFILE ON DATABASE privilege is required to perform <drop profile statement>.

Syntax Rules and Parameters

IF EXISTS

Even when the profile does not exist, an error does not occur.

profile_name

It specifies the profile name to be dropped.

It can not drop the DEFAULT profile.

CASCADE

If the profile has already been assigned to users, CASCADE clause should be explicitly specified to drop the profile.

The profile which is assigned to users and to be dropped is changed to DEFAULT profile.

Example

The following is an example of dropping a profile by using CASCADE statement.

```
gSQL> DROP PROFILE prof CASCADE;  
Profile dropped.  
gSQL> COMMIT;  
Commit complete.
```

Compatibility

The SQL standard does not cover the concepts of the profile.

For More Information

Refer to the followings.

- CREATE PROFILE
- ALTER PROFILE

16.103 DROP SCHEMA

Function

It drops a schema.

Syntax

```
<drop schema statement> ::=  
    DROP SCHEMA [ IF EXISTS ] schema_name  
        [ <drop behavior> ]  
    ;  
<drop behavior> ::=  
    RESTRICT  
    | CASCADE
```

Invocation and Access Rules

One of the following privileges is required to perform <drop schema statement>.

- The owner of that schema
- CONTROL SCHEMA ON SCHEMA for the schema
- DROP SCHEMA ON DATABASE

Syntax Rules and Parameters

IF EXISTS

Even when the schema does not exist, an error does not occur.

schema_name

It is the schema name to be dropped.

However, it can not drop the built-in schema such as "DICTIONARY_SCHEMA", "INFORMATION_SCHEMA" and "PUBLIC" which are automatically created when creating the database.

<drop behavior>

- When it is RESTRICT
 - Objects should not exist within the schema.
- When it is CASCADE
 - It drops all objects in the schema together.
- When it is omitted, the default value is RESTRICT.

Description

Data Definition Language (DDL) statement such as DROP SCHEMA can be rolled back if it is before when the transaction is committed.

Examples

The following is an example of dropping a schema and all objects which exist within the schema.

```
gSQL> DROP SCHEMA s1 CASCADE;  
Schema dropped.
```

The following is an example of preventing an error even when the schema does not exist by using IF EXISTS statement.

```
gSQL> DROP SCHEMA IF EXISTS not_exist_schema;  
Schema dropped.
```

Compatibility

The SQL standard does not define IF EXISTS clause.

Table 16-41 SQL standard compatibility

Feature ID	Description	Compatibility
F032	CASCADE drop behavior	O
F381	Extended schema manipulation	O

For More Information

Refer to `CREATE SCHEMA`.

16.104 DROP SEQUENCE

Function

It drops a sequence.

Syntax

```
<drop sequence generator statement> ::=  
    DROP SEQUENCE [ IF EXISTS ] [schema_name.] sequence_name  
    ;
```

Invocation and Access Rules

One of the following privileges is required to perform <drop sequence generator statement>.

- The owner of that sequence
- (DROP SEQUENCE or CONTROL SCHEMA) ON SCHEMA for the schema to which the sequence belongs
- DROP ANY SEQUENCE ON DATABASE

Syntax Rules and Parameters

IF EXISTS

Even when the sequence does not exist, an error does not occur.

sequence_name

It is the sequence name to be dropped.

It can define schema to which the sequence belongs such as schema_name.sequence_name and if schema_name is omitted, the default schema name of the user performing the statement is used.

Description

Data Definition Language (DDL) statement such as DROP SEQUENCE can be rolled back if it is before when the transaction is committed.

Examples

The following is an example of dropping a sequence.

```
gSQL> DROP SEQUENCE seq1;
Sequence dropped.
```

The following is an example of preventing an error even when the sequence does not exist by using IF EXISTS statement.

```
gSQL> DROP SEQUENCE invalid_sequence;
ERR-42000(16044): sequence does not exist :
DROP SEQUENCE invalid_sequence
          *
ERROR at line 1:
gSQL> DROP SEQUENCE IF EXISTS invalid_sequence;
Sequence dropped.
```

Compatibility

The SQL standard does not define IF EXISTS clause.

Table 16-42 SQL standard compatibility

Feature ID	Description	Compatibility
T176	Sequence generator support	O

For More Information

Refer to the followings.

- CREATE SEQUENCE

- ALTER SEQUENCE

16.105 DROP SYNONYM

Function

It drops a synonym.

Syntax

```
<drop synonym statement> ::=  
    DROP [ PUBLIC ] SYNONYM [ IF EXISTS ] [schema_name.]synonym_name  
    ;
```

Invocation and Access Rules

DROP PUBLIC SYNONYM ON DATABASE privilege is required to drop a public synonym by specifying PUBLIC.

One of the following privileges is required to drop a private synonym.

- The owner of that synonym
- (DROP SYNONYM or CONTROL SCHEMA) ON SCHEMA for the schema to which the synonym belongs
- DROP ANY SYNONYM ON DATABASE

Syntax Rules and Parameters

[PUBLIC]

It is specified when dropping the public synonym.

If this clause is omitted, the private synonym is dropped.

IF EXISTS

Even when the synonym does not exist, an error does not occur.

synonym_name

It is the synonym name to be dropped.

It can define schema to which the synonym belongs such as `schema_name.synonym_name` and if `schema_name` is omitted, the default schema name of the user performing the statement is used.

If `PUBLIC` is explicitly specified, the schema name can not be specified.

Description

Data Definition Language (DDL) statement such as `DROP SYNONYM` can be rolled back if it is before when the transaction is committed.

Examples

The following is an example of dropping a private synonym.

```
gSQL> DROP SYNONYM MyEmp;  
Synonym dropped.
```

The following is an example of dropping a public synonym.

```
gSQL> DROP PUBLIC SYNONYM MainEmp;  
Synonym dropped.
```

Compatibility

The SQL standard does not define `DROP SYNONYM` statement.

For More Information

Refer to `CREATE SYNONYM`.

16.106 DROP TABLE

Function

It drops a table.

Syntax

```
<drop table statement> ::=  
    DROP TABLE [ IF EXISTS ] table_name  
    [ <drop behavior> ]  
    ;  
<drop behavior> ::=  
    RESTRICT  
    | CASCADE  
    | CASCADE CONSTRAINTS
```

Invocation and Access Rules

One of the following privileges is required to perform <drop table statement>.

- The owner of that table
- CONTROL TABLE ON TABLE for that table
- (DROP TABLE or CONTROL SCHEMA) ON SCHEMA for the schema to which the table belongs
- DROP ANY TABLE ON DATABASE

Syntax Rules and Parameters

IF EXISTS

Even when the table does not exist, an error does not occur.

table_name

It is the table name to be dropped.

It can define schema to which the table belongs such as `schema_name.table_name` and if `schema_name` is omitted, the default schema name of the user performing the statement is used.

The following tables which are automatically created during creating the database, can not be dropped.

- The tables in "DEFINITION_SCHEMA" schema
- The tables in "FIXED_TABLE_SCHEMA" schema

It also drops constraints and indexes created in the table.

drop behavior

Currently, both RESTRICT and CASCADE are operated same.

When it is omitted, the default value is RESTRICT.

Description

Data Definition Language (DDL) statement such as DROP TABLE can be rolled back if it is before when the transaction is committed.

Examples

The following is an example of dropping an ordinary table.

```
gSQL> DROP TABLE region;  
Table dropped.
```

The following is an example of preventing an error even when the table does not exist by using IF EXISTS statement.

```
gSQL> DROP TABLE IF EXISTS invalid_table;  
Table dropped.
```

The following is an example of rolling back the dropped table.

```

gSQL> SELECT r_regionkey, r_name FROM region;
R_REGIONKEY R_NAME
-----
          0 AFRICA
          1 AMERICA
          2 ASIA
          3 EUROPE
          4 MIDDLE EAST
5 rows selected.
gSQL> DROP TABLE region;
Table dropped.
gSQL> SELECT r_regionkey, r_name FROM region;
ERR-42000(16040): table or view does not exist :
SELECT r_regionkey, r_name FROM region
                                   *
ERROR at line 1:
gSQL> ROLLBACK;
Rollback complete.
gSQL> SELECT r_regionkey, r_name FROM region;
R_REGIONKEY R_NAME
-----
          0 AFRICA
          1 AMERICA
          2 ASIA
          3 EUROPE
          4 MIDDLE EAST
5 rows selected.

```

Compatibility

The SQL standard does not define the following clauses.

- IF EXISTS
- CASCADE CONSTRAINTS

Table 16-43 SQL standard compatibility

Feature ID	Description	Compatibility
F032	CASCADE drop behavior	O

For More Information

Refer to `CREATE TABLE`.

16.107 DROP TABLESPACE

Function

It drops a tablespace.

Syntax

```
<drop tablespace statement> ::=  
    DROP TABLESPACE [ IF EXISTS ] tablespace_name  
        [ INCLUDING CONTENTS ]  
        [ { AND | KEEP } DATAFILES ]  
        [ <drop behavior> ]  
    ;  
<drop behavior> ::=  
    RESTRICT  
    | CASCADE  
    | CASCADE CONSTRAINTS
```

Invocation and Access Rules

DROP TABLESPACE ON DATABASE privilege is required to perform <drop tablespace definition>.

Syntax Rules and Parameters

IF EXISTS

Even when the tablespace does not exist, an error does not occur.

tablespace_name

It is the tablespace name to be dropped.

The following system tablespaces which are automatically created during creating the database, can not

be dropped.

- `DICTIONARY_TBS`: system tablespace for dictionary management
- `MEM_UNDO_TBS`: system tablespace for default undo tablespace
- `MEM_DATA_TBS`: system tablespace for default user data tablespace
- `MEM_TEMP_TBS`: system tablespace for default temporary tablespace



If `tablespace_name` was used as a default tablespace of a user, the space for the objects can not be allocated after dropping the tablespace.

After dropping the tablespace, the default tablespace should be changed by using **16.69 ALTER USER** statement.

INCLUDING CONTENTS

It drops objects (table, index, key constraint) which belong to the tablespace. If the index or key constraint which refers to the table which belongs to the tablespace exists outside of the tablespace, then it is also dropped.

If `INCLUDING CONTENTS` clause is not used, then any object which belongs to the tablespace should not exist.

[{ AND | KEEP } DATAFILES]

It specifies whether to drop the datafiles which configure the tablespace together. The datafiles are not in the memory temporary tablespace, so the clause is ignored.

- `AND DATAFILES`
 - It drops the datafiles together.
- `KEEP DATAFILES`
 - It does not drop the datafiles, but keeps them.
- If it is not specified, the default value is `KEEP DATAFILES`.

drop behavior

Currently, both `RESTRICT` and `CASCADE` are operated same.

When it is omitted, the default value is `RESTRICT`.

Description

Unlike other Data Definition Language (DDL), DROP TABLESPACE statement can not be rolled back and the executed transaction is automatically committed.

Examples

The following is an example of dropping a tablespace together with all objects in the tablespace and data files which configure the tablespace.

```
gSQL> DROP TABLESPACE space1 INCLUDING CONTENTS AND DATAFILES CASCADE CONSTRAINTS;  
Tablespace dropped.
```

The following is an example of preventing an error even when the tablespace does not exist by using IF EXISTS statement.

```
gSQL> DROP TABLESPACE IF EXISTS not_exist_tablespace;  
Tablespace dropped.
```

Compatibility

The SQL standard does not cover the concepts of the tablespace.

For More Information

Refer to the followings.

- CREATE MEMORY DATA TABLESPACE
- CREATE MEMORY TEMPORARY TABLESPACE
- ALTER TABLESPACE

16.108 DROP USER

Function

It drops a database user.

Syntax

```
<drop user statement> ::=  
    DROP USER [ IF EXISTS ] user_identifier [ <drop behavior> ]  
    ;  
<drop behavior> ::=  
    RESTRICT  
    | CASCADE
```

Invocation and Access Rules

DROP USER ON DATABASE privilege is required to perform <drop user statement>.



The schema owned by user_identifier should not exist.
For more information about dropping the schema, refer to **DROP SCHEMA**.

Syntax Rules and Parameters

IF EXISTS

Even when the user does not exist, an error does not occur.

user_identifier

It is the database username to be dropped.

However, the user which is automatically created during creating the database such as "SYS", can not be

dropped.

It does not drop the object which is created by user_identifier but is not an owner as follows.

- Role
- Tablespace

<drop behavior>

- RESTRICT
 - There should not be the following user owned SQL schema objects.
 - Table, view
 - Index
 - Sequence
 - Table constraint
- CASCADE
 - It drops all the following user owned SQL schema objects.
 - Table, view
 - Index
 - Sequence
 - Table constraint
- When it is omitted, the default value is RESTRICT.



The relationship between user and schema in other DBMS

- Oracle
 - User : schema = 1 : 1.
 - When CASCADE, the schema is also dropped.
- DB2
 - It is as same as the OS user.
 - The separate SQL statements which create or delete a user do not exist.
- Postgres
 - User : schema = 1 : N.
 - It does not support CASCADE option, and a user can be dropped after dropping all the objects owned by the user and all the privileges granted to other users.

- MySQL
 - Database : schema = 1 : 1.
 - User is a subordinate object of database (schema), and it does not support CASCADE option.

Description

In GOLDILOCKS, relationship between the user and the schema is 1 : N. A user does not own a schema, or the user can have multiple schemas.

To drop a user, all schema owned by the user should be dropped.

Examples

The following is an example of dropping all schema owned by the user and then dropping the user.

```
gSQL> DROP SCHEMA u1 CASCADE;  
Schema dropped.  
gSQL> DROP USER u1 CASCADE;  
User dropped.
```

The following is an example of preventing an error even when the user does not exist by using IF EXISTS statement.

```
gSQL> DROP USER IF EXISTS not_exist_user;  
User dropped.
```

Compatibility

SQL standard cover the concepts of the user, but they do not define the SQL statements related to creating or dropping a user.

For More Information

Refer to the followings.

- [CREATE USER](#)
- [ALTER USER](#)
- [DROP SCHEMA](#)

16.109 DROP VIEW

Function

It drops a view.

Syntax

```
<drop view statement> ::=  
    DROP VIEW [ IF EXISTS ] view_name  
    ;
```

Invocation and Access Rules

One of the following privileges is required to perform <drop view statement>.

- The owner of that view
- CONTROL TABLE ON TABLE for that view
- (DROP VIEW or CONTROL SCHEMA) ON SCHEMA for the schema to which the view belongs
- DROP ANY VIEW ON DATABASE

Syntax Rules and Parameters

IF EXISTS

Even when the view does not exist, an error does not occur.

view_name

It is the view name to be dropped.

The schema to which the table belongs, such as schema_name.view_name, can be defined. If schema_name is omitted, the default schema name of the user performing the statement is used.

Description

Data Definition Language (DDL) statement such as DROP VIEW can be rolled back if it is before when the transaction is committed.

Examples

The following is an example of dropping a view.

```
gSQL> DROP VIEW v1;  
View dropped.
```

The following is an example of preventing an error even when the view does not exist by using IF EXISTS statement.

```
gSQL> DROP VIEW IF EXISTS not_exist_view;  
View dropped.
```

Compatibility

The SQL standard does not define IF EXISTS clause.

Table 16-44 SQL standard compatibility

Feature ID	Description	Compatibility
F032	CASCADE drop behavior	X

For More Information

Refer to the followings.

- CREATE VIEW
- ALTER VIEW

16.110 EXECUTE statement_name

Function

It executes the prepared statement.

Syntax

```
<execute statement> ::=
    EXECUTE statement_name [ <parameter using clause> ] [ <result into clause> ]
    ;
<parameter using clause> ::=
    <using parameter arguments>
<using parameter arguments> ::=
    USING variable_name [, ...]
<result into clause> ::=
    <into result arguments>
<into result arguments> ::=
    INTO variable_name [, ...]
```

Invocation and Access Rules

It can be used in an embedded SQL.

An appropriate privilege according to the type of a dynamic SQL statement is required.

Syntax Rules and Parameters

statement_name

It is the name of a prepared statement.

Statement_name should be prepared by using **PREPARE statement_name**.

If the dynamic SQL statement referenced by statement_name contains a dynamic parameter, <parameter using clause> should explicitly be specified.

```
{
  ...
  EXEC SQL PREPARE stmt1 FROM 'DELETE FROM t1 WHERE c1 > ?';
  EXEC SQL EXECUTE stmt1 USING :sValue;
  ...
}
```

```
{
  ...
  EXEC SQL PREPARE stmt1 FROM 'SELECT COUNT(*) INTO :v1 FROM t1';
  EXEC SQL EXECUTE stmt1 USING :sValue;
  ...
}
```

If the dynamic SQL statement referenced by statement_name is a query or a stored function including the result, <result into clause> should explicitly be specified.

```
{
  ...
  EXEC SQL PREPARE stmt1 FROM 'SELECT COUNT(*) FROM t1';
  EXEC SQL EXECUTE stmt1 INTO :sValue;
  ...
}
```

If there are multiple queries they are normally executed, but only the first query can get the result. To get multiple results, the following statements related to the cursor should be used.

- DECLARE cursor_name
- OPEN cursor_name
- FETCH cursor_name
- CLOSE cursor_name

If there is not any query result, it is completed as NO DATA.

[<parameter using clause>] [<result into clause>]

<parameter using clause> and <result into clause> can be specified in any order, but they should not be repeated.

⟨parameter using clause⟩

If any parameter exists in a dynamic SQL statement referenced by `statement_name`, the parameter information is specified with ⟨using parameter arguments⟩ clause.

⟨using parameter arguments⟩

If ⟨using parameter arguments⟩ statement is used, the number of `variable_name` should be equal to the number of the parameter included in the dynamic SQL statement referenced by `statement_name`.

The listed `variable_name` corresponds to the dynamic parameter in an order of its description.

```
{
  ...
  EXEC SQL PREPARE stmt1 FROM 'DELETE FROM t1 WHERE c1 IN ( ?, ?, ? )';
  EXEC SQL EXECUTE stmt1 USING :sValue1, :sValue2, :sValue3;
  ...
}
```

⟨result into clause⟩

If the dynamic SQL statement referenced by `statement_name` is a query, the information about the result columns is specified with ⟨into result arguments⟩ clause.

If the result is null and `INDICATOR` is not specified, [DATA EXCEPTION, NULL VALUE, NO INDICATOR PARAMETER] error occurs.

⟨into result arguments⟩

If ⟨into result arguments⟩ clause is used, the number of `variable_name` should be equal to the number of the result column in the dynamic SQL statement referenced by `statement_name`.

The listed `variable_name` corresponds to the dynamic parameter in an order of its description.

```
{
  ...
  EXEC SQL PREPARE stmt1 FROM 'SELECT MIN(salary), MAX(salary), AVG(salary) FROM employee';
  EXEC SQL EXECUTE stmt1 INTO :sMinValue, :sMaxValue, :sAvgValue;
  ...
}
```

Description

Statement_name is an identifier which informs the precompiler the statement in an embedded SQL source code.

A separate type or declaration is not required because statement_name is not a host variable. EXECUTE statement_name should be written after PREPARE statement_name.

For more information, refer to **Embedded Dynamic SQL**.

Example

The following is an example of using EXECUTE statement_name in an embedded SQL source code.

```
{
    ...
    sprintf( sUpdateSql, "UPDATE EMP SET sal = sal * :v1 WHERE JOB = 'SALES'");
    EXEC SQL PREPARE UPDATE_STMT FROM :sUpdateSql;
    if(sqlca.sqlcode != 0)
    {
        goto fail_exit;
    }
    sRatio = 1.1;
    EXEC SQL EXECUTE UPDATE_STMT USING :sRatio;
    if(sqlca.sqlcode != 0)
    {
        goto fail_exit;
    }
    ...
}
```

The full source code in which EXECUTE statement_name was used can be viewed in **Dynamic Embedded SQL Example Program**.

Compatibility

Table 16-45 SQL standard compatibility

Feature ID	Description	Compatibility
B031	Basic Dynamic SQL	O
B032	Extended dynamic SQL	X

For More Information

Refer to the followings.

- **PREPARE** `statement_name`
- **DECLARE** `cursor_name`
- **OPEN** `cursor_name`
- **FETCH** `cursor_name`
- **CLOSE** `cursor_name`
- **Embedded Dynamic SQL**

16.111 EXECUTE IMMEDIATE 'sql_string'

Function

It executes a dynamic SQL statement which was not defined when writing a program.

Syntax

```
<execute immediate statement> ::=  
    EXECUTE IMMEDIATE <SQL statement variable>  
    ;  
<SQL statement variable> ::=  
    variable_name  
    | 'sql statement'  
    | "sql statement"  
    | sql statement
```

Invocation and Access Rules

It can be used in an embedded SQL.

An appropriate privilege according to the type of a dynamic SQL statement is required.

Syntax Rules and Parameters

<SQL statement variable>

The dynamic SQL statement referenced by <SQL statement variable> can not use a host variable (:var) or parameter marker (?).

The following four types of <SQL statement variable> can be used.

- `variable_name`: It is a variable in which an SQL statement is stored.
- `'sql statement'`: It is an SQL statement which is enclosed with a single quote (').
- `"sql statement"`: It is an SQL statement which is enclosed with double quotes (").

- `sql statement`: It is an SQL statement without quote.

The single quote (') is used twice as follows to represent string data within a single-quoted string.

```
{  
    ...  
    EXEC SQL EXECUTE IMMEDIATE 'INSERT INTO t1 VALUES ( ''literal data'' )';  
    ...  
}
```

If the SQL statement is a query including a query result, it is successfully executed, but the result can not be obtained.

variable_name

The type corresponding to the `variable_name` should be a character string.
The dynamic SQL statement defined in the `variable_name` should be valid.

sql statement

The dynamic SQL statement defined in the `sql statement` should be valid.

Description

`EXECUTE IMMEDIATE 'sql_string'` statement can be used as the non-query SQL without a host variable in dynamic embedded SQL application. It is appropriate to execute DDL, DML as one-off because it does not require separate preparation procedure.

For more information, refer to [Embedded Dynamic SQL](#).

Example

The following is an example of using `EXECUTE IMMEDIATE 'sql_string'` in the embedded SQL source code.

```
{  
    ...  
    sprintf(sSqlStmt, "INSERT INTO EMP_RND\n"
```



```
        "SELECT *\n"
        "FROM   EMP\n"
        "WHERE  JOB = 'RND'\n" );
EXEC SQL EXECUTE IMMEDIATE :sSqlStmt;
if(sqlca.sqlcode != 0)
{
    goto fail_exit;
}
...
}
```

The full source code in which EXECUTE IMMEDIATE 'sql_string' was used can be viewed in [Dynamic Embedded SQL Example Program](#).

Compatibility

Table 16-46 SQL standard compatibility

Feature ID	Description	Compatibility
B031	Basic Dynamic SQL	O

For More Information

Refer to the followings.

- PREPARE statement_name
- EXECUTE statement_name
- Embedded Dynamic SQL

16.112 FETCH cursor_name

Function

It locates the cursor on a specific row of result set, and obtains the value of that row to a host variable.

Syntax

```
<fetch statement> ::=
    FETCH [ <fetch orientation> ] [ FROM ] cursor_name
        <result into clause>
    ;
<fetch orientation> ::=
    NEXT
    | PRIOR
    | FIRST
    | LAST
    | CURRENT
    | ABSOLUTE position
    | RELATIVE position
<result into clause> ::=
    <into result arguments>
<into result arguments> ::=
    INTO variable_name [, ...]
```

Syntax Rules and Parameters

[FROM] cursor_name

It should be an open cursor in a session.

FROM can be omitted.

<fetch orientation>

To use <fetch orientation> other than FETCH NEXT, a scrollable cursor should be used. If <fetch orientation> is omitted, the default value is NEXT.

The open cursor has the cursor position information for the result set as follows.

Figure 1 The position of cursor

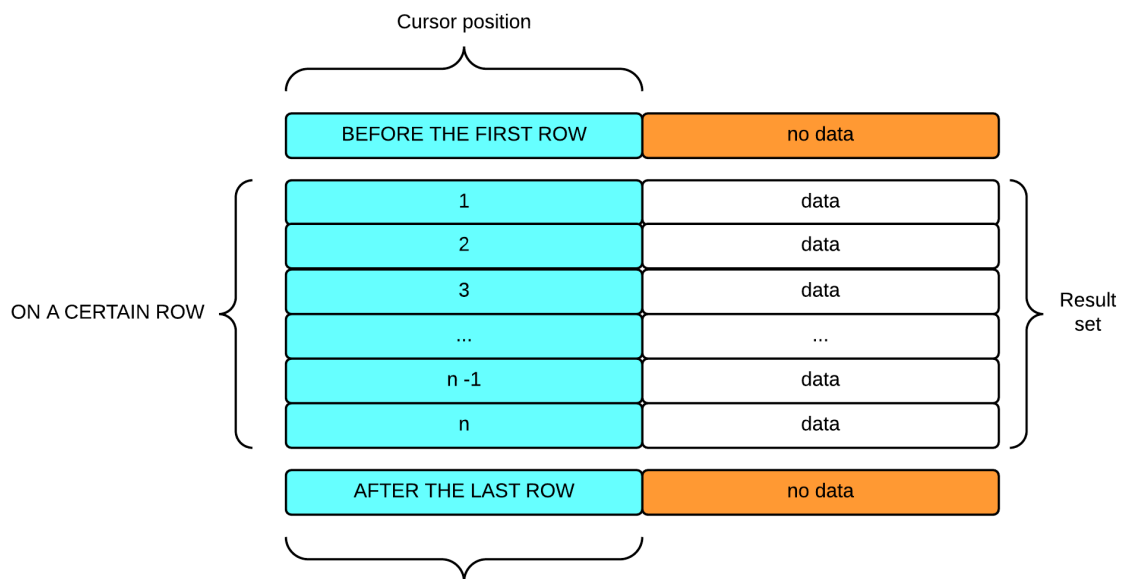

Table 16-47 The position of cursor

Cursor position	Description
BEFORE THE FIRST ROW	The cursor is positioned before the first row of the result set. It is also the cursor position when opening it.
ON A CERTAIN ROW	The cursor is positioned on a certain row of the result set through FETCH.
AFTER THE LAST ROW	The cursor is positioned after the last row of the result set.

Each <fetch orientation> operates based on the cursor position as follows.

- NEXT: It searches for the row next to the current position.
- PRIOR: It searches for the row prior to the current position.
- FIRST: It searches for the first row of the result set.
- LAST: It searches for the last row of the result set.
- CURRENT: It searches for the row in the current position.
- ABSOLUTE position
 - It searches for the row corresponding to the position from the result set.
 - If the position value is negative, it searches for the row at previous position from AFTER THE LAST ROW.
- RELATIVE position

- It searches for the row apart as much as position from the current position.

⟨result into clause⟩

The variable information to obtain the result column is specified by using ⟨into result arguments⟩.

If the result is null and INDICATOR is not specified, [DATA EXCEPTION, NULL VALUE, NO INDICATOR PARAMETER] error occurs.

⟨into result arguments⟩

The number of variables in INTO clause should be as same as the number of columns in the result set of the cursor.

Description

If the cursor is BEFORE THE FIRST ROW or AFTER THE LAST ROW after performing FETCH, it is positioned at the same position regardless of the entered position in ⟨fetch orientation⟩.

Example

The following is an example of declaring SCROLL cursor by using the interactive SQL (gsql), then operating the various ⟨fetch orientation⟩.

```
gSQL> DECLARE cur_scroll SCROLL CURSOR FOR SELECT id, data FROM t1;
Cursor declared.
gSQL> OPEN cur_scroll;
Cursor is open.
gSQL> \var v_id    INTEGER
gSQL> \var v_data VARCHAR(128)
gSQL> FETCH NEXT cur_scroll INTO :v_id, :v_data;
V_ID V_DATA
---- -
      1 data_1
1 row fetched.
gSQL> FETCH NEXT cur_scroll INTO :v_id, :v_data;
V_ID V_DATA
---- -
```

```
      2 data_2
1 row fetched.
gSQL> FETCH PRIOR cur_scroll INTO :v_id, :v_data;
V_ID V_DATA
-----
      1 data_1
1 row fetched.
gSQL> FETCH PRIOR cur_scroll INTO :v_id, :v_data;
no rows fetched.
gSQL> FETCH FIRST cur_scroll INTO :v_id, :v_data;
V_ID V_DATA
-----
      1 data_1
1 row fetched.
gSQL> FETCH FIRST cur_scroll INTO :v_id, :v_data;
V_ID V_DATA
-----
      1 data_1
1 row fetched.
gSQL> FETCH LAST cur_scroll INTO :v_id, :v_data;
V_ID V_DATA
-----
      5 data_5
1 row fetched.
gSQL> FETCH LAST cur_scroll INTO :v_id, :v_data;
V_ID V_DATA
-----
      5 data_5
1 row fetched.
gSQL> FETCH FIRST cur_scroll INTO :v_id, :v_data;
V_ID V_DATA
-----
      1 data_1
1 row fetched.
gSQL> FETCH CURRENT cur_scroll INTO :v_id, :v_data;
V_ID V_DATA
-----
      1 data_1
1 row fetched.
gSQL> FETCH LAST cur_scroll INTO :v_id, :v_data;
V_ID V_DATA
```

```
-----  
      5 data_5  
1 row fetched.  
gSQL> FETCH CURRENT cur_scroll INTO :v_id, :v_data;  
V_ID V_DATA  
-----  
      5 data_5  
1 row fetched.  
gSQL> FETCH ABSOLUTE 3 cur_scroll INTO :v_id, :v_data;  
V_ID V_DATA  
-----  
      3 data_3  
1 row fetched.  
gSQL> FETCH CURRENT cur_scroll INTO :v_id, :v_data;  
V_ID V_DATA  
-----  
      3 data_3  
1 row fetched.  
gSQL> FETCH ABSOLUTE 1 cur_scroll INTO :v_id, :v_data;  
V_ID V_DATA  
-----  
      1 data_1  
1 row fetched.  
gSQL> FETCH ABSOLUTE -1 cur_scroll INTO :v_id, :v_data;  
V_ID V_DATA  
-----  
      5 data_5  
1 row fetched.  
gSQL> FETCH ABSOLUTE 6 cur_scroll INTO :v_id, :v_data;  
no rows fetched.  
gSQL> FETCH ABSOLUTE -6 cur_scroll INTO :v_id, :v_data;  
no rows fetched.  
gSQL> FETCH ABSOLUTE 3 cur_scroll INTO :v_id, :v_data;  
V_ID V_DATA  
-----  
      3 data_3  
1 row fetched.  
gSQL> FETCH ABSOLUTE -3 cur_scroll INTO :v_id, :v_data;  
V_ID V_DATA  
-----  
      3 data_3
```

```

1 row fetched.
gSQL> FETCH RELATIVE 1 cur_scroll INTO :v_id, :v_data;
V_ID V_DATA
-----
      4 data_4
1 row fetched.
gSQL> FETCH RELATIVE -1 cur_scroll INTO :v_id, :v_data;
V_ID V_DATA
-----
      3 data_3
1 row fetched.
gSQL> FETCH RELATIVE 5 cur_scroll INTO :v_id, :v_data;
no rows fetched.
gSQL> FETCH RELATIVE -5 cur_scroll INTO :v_id, :v_data;
V_ID V_DATA
-----
      1 data_1
1 row fetched.
gSQL> CLOSE cur_scroll;
Cursor closed.

```

Compatibility

The SQL standard does not define CURRENT among <fetch orientation>.

Table 16-48 SQL standard compatibility

Feature ID	Description	Compatibility
F431	Read-only scrollable cursors	O
B031	Basic dynamic SQL	O

For More Information

Refer to the followings.

- DECLARE cursor_name
- OPEN cursor_name
- CLOSE cursor_name

16.113 GRANT privileges TO

Function

It grants privileges to a user.

Syntax

```
<grant privilege statement> ::=
    GRANT <privilege> TO <grantee> [, ...]
        [ WITH GRANT OPTION ]
    ;

<grantee> ::=
    PUBLIC
    | user_identifier
    ;

<privilege> ::=
    <database privilege>
    | <tablespace privilege>
    | <schema privilege>
    | <table privilege>
    | <sequence privilege>
    | <procedure privilege>

<database privilege> ::=
    ALL [ PRIVILEGES ] [ ON DATABASE]
    | <database action> [, ...] [ ON DATABASE]

<database action> ::=
    ADMINISTRATION
    | ANALYZE ANY
    | ALTER DATABASE
    | ALTER SYSTEM
    | AUDIT SYSTEM
    | ACCESS CONTROL
    | CREATE SESSION
    | CREATE PROFILE
    | ALTER PROFILE
```

- | DROP PROFILE
- | CREATE USER
- | ALTER USER
- | DROP USER
- | CREATE ROLE
- | ALTER ROLE
- | DROP ROLE
- | CREATE TABLESPACE
- | ALTER TABLESPACE
- | DROP TABLESPACE
- | USAGE TABLESPACE
- | CREATE SCHEMA
- | ALTER SCHEMA
- | DROP SCHEMA
- | CREATE PUBLIC SYNONYM
- | DROP PUBLIC SYNONYM
- | CREATE ANY TABLE
- | ALTER ANY TABLE
- | DROP ANY TABLE
- | SELECT ANY TABLE
- | INSERT ANY TABLE
- | DELETE ANY TABLE
- | UPDATE ANY TABLE
- | LOCK ANY TABLE
- | CREATE ANY VIEW
- | DROP ANY VIEW
- | CREATE ANY SEQUENCE
- | ALTER ANY SEQUENCE
- | DROP ANY SEQUENCE
- | USAGE ANY SEQUENCE
- | CREATE ANY INDEX
- | ALTER ANY INDEX
- | DROP ANY INDEX
- | CREATE ANY SYNONYM
- | DROP ANY SYNONYM
- | CREATE ANY PROCEDURE
- | ALTER ANY PROCEDURE
- | DROP ANY PROCEDURE
- | EXECUTE ANY PROCEDURE

<tablespace privilege> ::=

ALL [PRIVILEGES] ON TABLESPACE tablespace_name

```

    | <tablespace action> [, ...] ON TABLESPACE tablespace_name
<tablespace action> ::=
    CREATE OBJECT
<schema privilege> ::=
    ALL [ PRIVILEGES ] ON SCHEMA schema_name
    | <schema action> [, ...] [ON SCHEMA schema_name]
<schema action> ::=
    CONTROL SCHEMA
    | CREATE TABLE
    | ALTER TABLE
    | DROP TABLE
    | SELECT TABLE
    | INSERT TABLE
    | DELETE TABLE
    | UPDATE TABLE
    | LOCK TABLE
    | CREATE VIEW
    | DROP VIEW
    | CREATE SEQUENCE
    | ALTER SEQUENCE
    | DROP SEQUENCE
    | USAGE SEQUENCE
    | CREATE INDEX
    | ALTER INDEX
    | DROP INDEX
    | ADD CONSTRAINT
    | CREATE SYNONYM
    | DROP SYNONYM
    | CREATE PROCEDURE
    | ALTER PROCEDURE
    | DROP PROCEDURE
    | EXECUTE PROCEDURE
<table privilege> ::=
    ALL [ PRIVILEGES ] ON [TABLE] table_name
    | { <table action> | <column action> } [, ...] ON [TABLE] table_name
<table action> ::=
    CONTROL TABLE
    | SELECT
    | INSERT
    | UPDATE
    | DELETE

```

```

| REFERENCES
| LOCK
| INDEX
| ALTER
<column action> ::=
    SELECT ( column_name [, ...] )
| INSERT ( column_name [, ...] )
| UPDATE ( column_name [, ...] )
| REFERENCES ( column_name [, ...] )
<sequence privilege> ::=
    ALL [ PRIVILEGES ] ON SEQUENCE sequence_name
| <sequence action> ON SEQUENCE sequence_name
<sequence action> ::=
    USAGE
<procedure privilege> ::=
    ALL [ PRIVILEGES ] ON PROCEDURE procedure_name
| <procedure action> ON PROCEDURE procedure_name
<procedure action> ::=
    EXECUTE

```

Syntax Rules and Parameters

<grantee>

It is the user to be granted the privileges.

- user_identifier
 - It grants the privilege to a user.
- PUBLIC
 - It is an authorization object which means all users.

WITH GRANT OPTION

It allows the grantee to grant the privilege to other users.

When the same <privilege> is granted as follows, WITH GRANT OPTION is maintained.

- GRANT SELECT ON t1 TO u1 WITH GRANT OPTION;
- GRANT SELECT ON t1 TO u1;

<privilege>

It is a privilege which is to be granted to a grantee (the user to be granted the privilege).

The grantor (the user to perform the statement) should satisfy one of the following conditions.

- The grantor owns that <privilege> by using WITH GRANT OPTION.
 - The grantor is the user who performs the statement.
- The grantor owns the ACCESS CONTROL ON DATABASE privilege.
 - The grantor is the object owner.
 - <database privilege>: _SYSTEM account
 - <tablespace privilege>: _SYSTEM account
 - <schema privilege>: _SYSTEM account
 - <table privilege>: The owner of the table
 - <sequence privilege>: The owner of the sequence
 - <procedure privilege>: The owner of the procedure/function

<database privilege>

It is the privilege for the database objects.

[ON DATABASE] statement can be omitted.

The database action which can be defined with the database privilege is as follows.

- ALL [PRIVILEGES] [ON DATABASE]
 - All privileges for the database which the grantor (the user who performs the statement) owns by using WITH GRANT OPTION.

Table 16-49 Database privilege

<database action>	Description
ADMINISTRATION	Privilege for starting or terminating the server
ALTER DATABASE	Privilege for executing ALTER DATABASE
ALTER SYSTEM	Privilege for executing ALTER SYSTEM
AUDIT SYSTEM	Privilege for controlling the audit policy
ACCESS CONTROL	Privilege for controlling all the privileges
CREATE SESSION	Privilege for connecting to the database
CREATE PROFILE	Privilege for creating profiles in the database
ALTER PROFILE	Privilege for altering any profile in the database
DROP PROFILE	Privilege for dropping any profile in the database
CREATE USER	Privilege for creating users in the database
ALTER USER	Privilege for altering any user in the database
DROP USER	Privilege for dropping any user in the database

<database action>	Description
CREATE ROLE	Privilege for creating roles in the database
ALTER ROLE	Privilege for altering any role in the database
DROP ROLE	Privilege for dropping any role in the database
CREATE TABLESPACE	Privilege for creating tablespaces in the database
ALTER TABLESPACE	Privilege for altering any tablespace in the database
DROP TABLESPACE	Privilege for dropping any tablespace in the database
USAGE TABLESPACE	Privilege for using any tablespace in the database
CREATE SCHEMA	Privilege for creating schemas in the database
ALTER SCHEMA	Privilege for altering any schema in the database
DROP SCHEMA	Privilege for dropping any schema in the database
CREATE PUBLIC SYNONYM	Privilege for creating public synonyms in the database
DROP PUBLIC SYNONYM	Privilege for dropping any public synonym in the database
CREATE ANY TABLE	Privilege for creating tables in any schema of the database
ALTER ANY TABLE	Privilege for altering any table in the database
DROP ANY TABLE	Privilege for dropping any table in the database
SELECT ANY TABLE	Privilege for querying rows of any table in the database
INSERT ANY TABLE	Privilege for creating rows of any table in the database
DELETE ANY TABLE	Privilege for deleting rows of any table in the database
UPDATE ANY TABLE	Privilege for updating rows of any table in the database
LOCK ANY TABLE	Privilege for locking any table in the database
CREATE ANY VIEW	Privilege for creating views in any schema of the database
DROP ANY VIEW	Privilege for dropping any view in the database
CREATE ANY SEQUENCE	Privilege for creating sequences in any schema of the database
ALTER ANY SEQUENCE	Privilege for altering any sequence of the database
DROP ANY SEQUENCE	Privilege for dropping any sequence of the database
USAGE ANY SEQUENCE	Privilege for using any sequence of the database
CREATE ANY INDEX	Privilege for creating indexes in any schema of the database
ALTER ANY INDEX	Privilege for altering any index in the database
DROP ANY INDEX	Privilege for dropping any index in the database
CREATE ANY SYNONYM	Privilege for creating synonyms in the database
DROP ANY SYNONYM	Privilege for dropping any synonym in the database
CREATE ANY PROCEDURE	Privilege for creating any procedure/function in any schema of the database
ALTER ANY PROCEDURE	Privilege for altering any procedure/function in the database
DROP ANY PROCEDURE	Privilege for dropping any procedure/function in the database
EXECUTE ANY PROCEDURE	Privilege for executing any procedure/function in the database

<tablespace privilege>

It is the privilege for the tablespace objects.

The tablespace action which can be defined with the tablespace privilege is as follows.

- ALL [PRIVILEGES] ON TABLESPACE tablespace_name
 - All privileges for the tablespace which the grantor (the user who performs the statement) owns by using WITH GRANT OPTION.

Table 16-50 Tablespace privilege

<tablespace action>	Description
CREATE OBJECT	Privilege for creating objects in the tablespace

<schema privilege>

It is the privilege for the schema objects.

- Whether to omit [ON SCHEMA schema_name]
 - If multiple <grantee> exist, [ON SCHEMA schema_name] statement can not be omitted.
 - If ALL [PRIVILEGES] is used, [ON SCHEMA schema_name] statement can not be omitted.
 - If [ON SCHEMA schema_name] statement is omitted, <grantee> can use only one user_identifier, and the privilege on the first schema in the schema search path of <grantee> is granted.

The schema action which can be defined with the schema privilege is as follows.

- ALL [PRIVILEGES] ON SCHEMA schema_name
 - All privileges for the schema which the grantor (the user who performs the statement) owns by using WITH GRANT OPTION

Table 16-51 Schema privilege

<schema action>	Description
CONTROL SCHEMA	All privileges for that schema
CREATE TABLE	Privilege for creating tables in the schema
ALTER TABLE	Privilege for altering any table in the schema
DROP TABLE	Privilege for dropping any table in the schema
SELECT TABLE	Privilege for querying rows of any table in the schema
INSERT TABLE	Privilege for creating rows of any table in the schema
DELETE TABLE	Privilege for deleting rows of any table in the schema
UPDATE TABLE	Privilege for updating rows of any table in the schema
LOCK TABLE	Privilege for locking any table of the schema
CREATE VIEW	Privilege for creating views in the schema

<schema action>	Description
DROP VIEW	Privilege for dropping any view of the schema
CREATE SEQUENCE	Privilege for creating sequences in the schema
ALTER SEQUENCE	Privilege for altering any sequence of the schema
DROP SEQUENCE	Privilege for dropping any sequence of the schema
USAGE SEQUENCE	Privilege for using any sequence of the schema
CREATE INDEX	Privilege for creating indexes in the schema
ALTER INDEX	Privilege for altering any index in the schema
DROP INDEX	Privilege for dropping any index in the schema
ADD CONSTRAINT	Privilege for creating constraints in the schema
CREATE SYNONYM	Privilege for creating synonyms in the schema
DROP SYNONYM	Privilege for dropping any synonym of the schema
CREATE PROCEDURE	Privilege for creating any procedure/function in the schema
ALTER PROCEDURE	Privilege for altering any procedure/function in the schema
DROP PROCEDURE	Privilege for dropping any procedure/function in the schema
EXECUTE PROCEDURE	Privilege for executing any procedure/function in the schema

<table privilege>

It is the privilege for the table object or the view object.

[TABLE] statement can be omitted.

The table action which can be defined with the table privilege is as follows.

- ALL [PRIVILEGES] ON [TABLE] table_name
 - All privileges for the table which the grantor (the user who performs the statement) owns by using WITH GRANT OPTION

Table 16-52 Table privilege

<table action>	Description
CONTROL TABLE	All privileges for that table
SELECT	Privilege for querying rows of the table
INSERT	Privilege for creating rows into the table
UPDATE	Privilege for updating rows in the table
DELETE	Privilege for deleting rows from the table
REFERENCES	Privilege for creating referential constraints which refers to the table
LOCK	Privilege for locking the table
INDEX	Privilege for creating indexes in the table
ALTER	Privilege for altering the table

For SELECT, INSERT, UPDATE, REFERENCES, additional privileges are granted to all columns of the table.

The column action which can be defined with the table privilege is as follows. However, the column action is applicable only to the base table.

Table 16-53 Column privilege

<column action>	Description
SELECT (columns)	Privilege for querying that columns
INSERT (columns)	Privilege for creating rows including that columns
UPDATE (columns)	Privilege for updating that columns
REFERENCES (columns)	Privilege for creating referential constraints which refers to that columns

<sequence privilege>

It is the privilege for the sequence object.

The sequence action which can be defined with the sequence privilege is as follows.

- ALL [PRIVILEGES] ON SEQUENCE sequence_name
 - All privileges for the sequence which the grantor (the user who performs the statement) owns by using WITH GRANT OPTION.

Table 16-54 Sequence privilege

<sequence action>	Description
USAGE	Privilege for using the sequence

<procedure privilege>

It is the privilege for the procedure/ function object.

The action which can be defined with the procedure privilege is as follows.

- ALL [PRIVILEGES] ON PROCEDURE procedure_name
 - All privileges for the procedure/ function which the grantor (the user who performs the statement) owns by using WITH GRANT OPTION

Table 16-55 Procedure privilege

<procedure action>	Description
EXECUTE	Privilege for executing the procedure/function

Description

Data Definition Language (DDL) such as GRANT privilege can be rolled back if it is before when the transaction is committed.

The owner who created SQL schema object, such as table, sequence, has certain privileges without being granted any separate privilege for the object.

For more information, refer to the following CREATE statements.

- CREATE TABLE
- CREATE VIEW
- CREATE SEQUENCE
- ALTER TABLE name ADD COLUMN
- CREATE FUNCTION
- CREATE PROCEDURE

The owner who created non-schema object such as schema, tablespace, does not automatically have any privilege for the object. Therefore, the privilege should be separately granted.

For more information, refer to the following CREATE statements.

- CREATE SCHEMA
- CREATE TABLESPACE
- CREATE USER

Examples

The following is an example of granting SELECT ON TABLE t1 privilege to the user u1.

```
gSQL> GRANT SELECT ON t1 TO u1;  
Grant succeeded.
```

The following is an example of granting SELECT ON TABLE t1 privilege to the PUBLIC account (all users).

```
gSQL> GRANT SELECT ON t1 TO PUBLIC;  
Grant succeeded.
```

The following is an example that the user u1 grants the privilege to the other user by using WITH GRANT OPTION.

```
gSQL> GRANT SELECT ON t1 TO u1 WITH GRANT OPTION;  
Grant succeeded.
```

The following is the example that the user executing the statement grants all privileges on the TABLE t1 to user u1 by using WITH GRANT OPTION.

```
gSQL> GRANT ALL PRIVILEGES ON TABLE t1 TO u1;  
Grant succeeded.
```

The following is an example of granting CREATE SESSION ON DATABASE privilege which is a privilege for connecting to the database.

```
gSQL> GRANT CREATE SESSION ON DATABASE TO u1;  
Grant succeeded.
```

The following is an example of granting multiple privileges for creating objects such as the table, view, index, sequence, constraint in the SCHEMA s1 to the user u1.

```
gSQL> GRANT CREATE TABLE, CREATE VIEW, CREATE INDEX, CREATE SEQUENCE, ADD CONSTRAINT ON SCHEMA  
s1 TO u1;  
Grant succeeded.
```

The following is an example of granting the privileges for creating objects in TABLESPACE mem_data_tb to the user u1.

```
gSQL> GRANT CREATE OBJECT ON TABLESPACE mem_data_tbs TO u1;  
Grant succeeded.
```

The following is an example of granting the privilege for querying some columns in the TABLE t1 to the user u1.

```
gSQL> GRANT SELECT( id, name ) ON TABLE t1 TO u1;  
Grant succeeded.
```

The following is an example of granting the privilege to the user u1 for using NEXTVAL(), CURRVAL() functions in the SEQUENCE seq1.

```
gSQL> GRANT USAGE ON SEQUENCE seq1 TO u1;  
Grant succeeded.
```

Compatibility

The SQL standard does not define the following privileges.

- <database privilege>
- <tablespace privilege>
- <schema privilege>

Table 16-56 SQL standard compatibility

Feature ID	Description	Compatibility
S023	Basic structured types	X
S024	Enhanced structured types	X
S081	Subtables	X
T211	Basic trigger capability	X
T281	SELECT privilege with column granularity	O
T332	Extended Roles	X
F731	INSERT column privileges	O

For More Information

Refer to the followings.

- **REVOKE privileges FROM**
- **CREATE USER**
- **DROP USER**
- **ALTER USER**

16.114 INSERT INTO

Function

It creates new rows in a table.

Syntax

```

<insert statement> ::=
    INSERT INTO table_name [ ( column_name [, ...] ) ]
        <insert source>
    ;
<insert source> ::=
    <values clause>
  | <from subquery>
  | <from default>
<values clause> ::=
    VALUES { ( { <value expression> | DEFAULT } [, ...] ) } [, ...]
<from subquery> ::=
    <query expression>
<from default> ::=
    DEFAULT VALUES

```

Invocation and Access Rules

A user should satisfy the following conditions to perform <Insert statement>.

- One of the following privileges is required to perform the INSERT statement.
 - INSERT(columns) ON TABLE for all columns which are targets of insert
 - (INSERT or CONTROL TABLE) ON TABLE for the table
 - (INSERT TABLE or CONTROL SCHEMA) ON SCHEMA for the schema to which the table belongs
 - INSERT ANY TABLE ON DATABASE
- One of the following privileges is required for all tables used in <from subquery>.
 - SELECT(columns) ON TABLE for all columns of tables which were used in the statement
 - (SELECT or CONTROL TABLE) ON TABLE for the table

- (SELECT TABLE or CONTROL SCHEMA) ON SCHEMA for the schema to which the table belongs
- SELECT ANY TABLE ON DATABASE

Syntax Rules and Parameters

table_name

It is the name of a target table in which the row is to be created.

It can define schema to which the table belongs such as schema_name.table_name and if schema_name is omitted, the default schema name of the user performing the statement is used.

[(column_name [, ...])]

It is the column name of a table.

The column list can be omitted.

The number of columns and the number of <insert source> values should be same, and DEFAULT value is assigned to the omitted column.

<values clause>

It is the list of values to be assigned to the corresponding columns.

- <value expression>
 - It is the value or expression to be assigned to the corresponding column.
- DEFAULT
 - The value of corresponding column will use the default value which were defined through **CREATE TABLE**.
 - If it is not defined, NULL will be assigned.

Multiple rows can be created as follows.

```
INSERT INTO table_name VALUES ( 1, 'A' ), ( 2, 'B' ), ( 3, 'C' )
```

<from subquery>

It is the query to create rows.

For more information, refer to **query expression** clause of **SELECT** statement.

DEFAULT VALUES

It fills every column with default value.

DEFAULT VALUES clause means as same as the following.

```
VALUES ( DEFAULT, DEFAULT, ..., DEFAULT )
```

Description

Differences among INSERT-related Statements

- **INSERT INTO**
 - It creates one or multiple rows into the table.
 - e.g. INSERT INTO t1 SELECT * FROM t1;
- **INSERT INTO name RETURNING**
 - It creates one or multiple rows into the table, then the created rows can be retrieved in the same way as SELECT statement(API such as SQLFetch()).
 - e.g. INSERT INTO t1 SELECT * FROM t1 RETURNING c1;
- **INSERT INTO name RETURNING .. INTO**
 - It creates one or less row, and if a single row is created, it obtains the value to the host variable of RETURNING INTO clause.
 - e.g. INSERT INTO t1 DEFAULT VALUES RETURNING c1 INTO :v1;

Examples

The following is an example of creating a single row by using INSERT statement.

```
gSQL> INSERT INTO region VALUES ( 0, 'AFRICA' );
1 row created.
```

The following is an example of using the DEFAULT value or identity value of the column in INSERT statement.

```
gSQL> CREATE TABLE region
(
    r_regionkey    BIGINT    GENERATED BY DEFAULT AS IDENTITY
, r_name         CHAR(25)  DEFAULT 'N/A'
);
```

```
Table created.
gSQL> COMMIT;
Commit complete.
```

- DEFAULT is inserted into all columns.

```
gSQL> INSERT INTO region DEFAULT VALUES;
1 row created.
```

- DEFAULT is inserted into all columns.

```
gSQL> INSERT INTO region VALUES (DEFAULT, DEFAULT);
1 row created.
```

- If a column is omitted, the DEFAULT value of r_name column is used.

```
gSQL> INSERT INTO region(r_regionkey) VALUES (-100);
1 row created.
```

- If a column is omitted, the identity value of r_regionkey column is used.

```
gSQL> INSERT INTO region(r_name) VALUES ('ASIA');
1 row created.
```

```
gSQL> SELECT * FROM region;
```

```
R_REGIONKEY R_NAME
-----
          1 N/A
          2 N/A
        -100 N/A
           3 ASIA
```

```
4 rows selected.
```

The following is an example of creating multiple rows by describing them in VALUES clause.

```
gSQL> INSERT INTO region
      VALUES ( 1, 'AFRICA' ),
             ( 2, 'ASIA'   ),
             ( 3, 'EUROPE' );
3 rows created.
```

The following is an example of creating multiple rows by using a subquery.

```
gSQL> INSERT INTO region SELECT r_regionkey, r_name FROM tmp_region WHERE r_regionkey < 3;  
3 rows created.
```

Compatibility

Table 16-57 SQL standard compatibility

Feature ID	Description	Compatibility
F781	Self-referencing operations	X
F222	INSERT statement: DEFAULT VALUES clause	O
S204	Enhanced structured types	X
S043	Enhanced reference types	X
T111	Updatable joins, unions, and columns	X

For More Information

Refer to the followings.

- **SELECT**
- **INSERT INTO name RETURNING**
- **INSERT INTO name RETURNING .. INTO**

16.115 INSERT INTO name RETURNING

Function

It creates new rows in the table, and retrieves them.

Syntax

```

<insert statement> ::=
    INSERT INTO table_name [ ( column_name [, ...] ) ]
        <insert source>
        <returning clause>
    ;
<insert source> ::=
    <values clause>
    | <from subquery>
    | <from default>
<values clause> ::=
    VALUES { ( { <value expression> | DEFAULT } [, ...] ) } [, ...]
<from subquery> ::=
    <query expression>
<from default> ::=
    DEFAULT VALUES
<returning clause> ::=
    [ RETURN | RETURNING ] { * | { <value expression> [ [AS] alias_name ] } [, ...]

```

Invocation and Access Rules

A user should satisfy the following conditions to perform <insert returning query statement>.

- One of the following privileges is required to perform INSERT statement.
 - INSERT(columns) ON TABLE for all columns which are targets of insert
 - (INSERT or CONTROL TABLE) ON TABLE for the table
 - (INSERT TABLE or CONTROL SCHEMA) ON SCHEMA for the schema to which the table belongs
 - INSERT ANY TABLE ON DATABASE

- One of the following privileges is required for all tables used in `<from subquery>`.
 - `SELECT(columns) ON TABLE` for all columns of tables which were used in the statement
 - `(SELECT or CONTROL TABLE) ON TABLE` for the table
 - `(SELECT TABLE or CONTROL SCHEMA) ON SCHEMA` for the schema to which the table belongs
 - `SELECT ANY TABLE ON DATABASE`
- One of the following privileges is required for all columns used in `RETURNING` clause.
 - `SELECT(columns) ON TABLE` for all columns which were used in `RETURNING` clause.
 - `(SELECT or CONTROL TABLE) ON TABLE` for the table
 - `(SELECT TABLE or CONTROL SCHEMA) ON SCHEMA` for the schema to which the table belongs
 - `SELECT ANY TABLE ON DATABASE`

Syntax Rules and Parameters

`table_name`

It is the name of a target table in which the row is to be created.

`[(column_name [, ...])]`

It is the column name of a table.

For more information, refer to **INSERT INTO**.

`<values clause>`

It is the list of values to be assigned to the corresponding columns.

For more information, refer to **INSERT INTO**.

`<from subquery>`

It is the query to create rows.

For more information, refer to **INSERT INTO**.

DEFAULT VALUES

It fills every column with default value.

For more information, refer to **INSERT INTO**.

<returning clause>

It returns the inserted rows.

- It sets the inserted rows as a result set, and specifies the rows to be retrieved.
 - RETURNING clause returns the rows which were inserted by INSERT statement, and which is a result set.
 - <value expression>
 - It is as same as <select list> in SELECT statement, but it can not use the aggregation.
 - [[AS] alias_name]
 - It can name a value expression by using AS clause.

The keywords RETURNING and RETURN have the same meaning.

Description

For more information, refer to [Differences among INSERT-related Statements](#).

Examples

The following is an example of retrieving the column values created by using INSERT statement.

```
gSQL> CREATE TABLE region
(
  r_regionkey  BIGINT    GENERATED BY DEFAULT AS IDENTITY
, r_name      CHAR(25)  DEFAULT 'N/A'
);
Table created.
gSQL> COMMIT;
Commit complete.
```

- The following is an example of returning the created DEFAULT value (RETURNING).

```
gSQL> INSERT INTO region VALUES ( DEFAULT, DEFAULT ) RETURNING r_regionkey, r_name;
R_REGIONKEY R_NAME
-----
          1 N/A
1 row created.
```

- The following is an example of returning the omitted column value (RETURNING).

```
gSQL> INSERT INTO region(r_name) VALUES ('ASIA') RETURNING r_regionkey;
R_REGIONKEY
-----
          2
1 row created.
```

The following is an example of retrieving the rows created by using the subquery.

```
gSQL> INSERT INTO region
      SELECT r_regionkey, r_name FROM tmp_region WHERE r_regionkey < 3
      RETURNING r_regionkey, r_name;
R_REGIONKEY R_NAME
-----
          0 AFRICA
          1 AMERICA
          2 ASIA
3 rows created.
```

Compatibility

The SQL standard does not define <insert returning query statement>.

For More Information

Refer to the followings.

- INSERT INTO**
- INSERT INTO name RETURNING .. INTO**

16.116 INSERT INTO name RETURNING .. INTO

Function

It creates a single row in a table, and obtains the value of the created row as a host variable.

Syntax

```

<insert statement> ::=
    INSERT INTO table_name [ ( column_name [, ...] ) ]
        <insert source>
        <returning into clause>
    ;
<insert source> ::=
    <values clause>
    | <from subquery>
    | <from default>
<values clause> ::=
    VALUES { ( { <value expression> | DEFAULT } [, ...] ) } [, ...]
<from subquery> ::=
    <query expression>
<from default> ::=
    DEFAULT VALUES
<returning into clause> ::=
    [ RETURN | RETURNING ] { * | { <value expression> [ [AS] alias_name ] } [, ...] INTO
    variable_name [, ...]

```

Invocation and Access Rules

A user should satisfy the following conditions to perform <insert returning into statement>.

- One of the following privileges is required to perform INSERT statement.
 - INSERT(columns) ON TABLE for all columns which are targets of insert.
 - (INSERT or CONTROL TABLE) ON TABLE for the table
 - (INSERT TABLE or CONTROL SCHEMA) ON SCHEMA for the schema to which the table belongs

- INSERT ANY TABLE ON DATABASE
- One of the following privileges is required for all tables used in <from subquery>.
 - SELECT(columns) ON TABLE for all columns of tables which were used in the statement
 - (SELECT or CONTROL TABLE) ON TABLE for the table
 - (SELECT TABLE or CONTROL SCHEMA) ON SCHEMA for the schema to which the table belongs
 - SELECT ANY TABLE ON DATABASE
- One of the following privileges is required for all columns used in RETURNING clause.
 - SELECT(columns) ON TABLE for all columns which were used in RETURNING clause
 - (SELECT or CONTROL TABLE) ON TABLE for the table
 - (SELECT TABLE or CONTROL SCHEMA) ON SCHEMA for the schema to which the table belongs
 - SELECT ANY TABLE ON DATABASE

Syntax Rules and Parameters

table_name

It is the name of a target table in which the row is to be created.

[(column_name [, ...])]

It is the column name of a table.

For more information, refer to **INSERT INTO**.

<values clause>

It is the list of values to be assigned to the corresponding columns.

For more information, refer to **INSERT INTO**.

<from subquery>

It is the query to create rows.

For more information, refer to **INSERT INTO**.

DEFAULT VALUES

It fills every column with default value.

For more information, refer to **INSERT INTO**.

⟨returning clause⟩

It returns the inserted rows.

For more information, refer to ⟨returning clause⟩ in **INSERT INTO name RETURNING** statement.

INTO variable_name [, ...]

The number of variables in INTO clause should be equal to the number of the expressions in RETURNING clause.

The row to be created should be one or less. If two or more rows are created, an error occurs.

Description

For more information, refer to **Differences among INSERT-related Statements**.

Example

The following is an example of obtaining the value of the created row as a host variable.

```
gSQL> CREATE TABLE region
(
    r_regionkey    BIGINT    GENERATED BY DEFAULT AS IDENTITY
    , r_name       CHAR(25)  DEFAULT 'N/A'
);
Table created.
gSQL> COMMIT;
Commit complete.
```

- The host variables are declared.

```
\VAR v_key    BIGINT
\VAR v_name   VARCHAR(128)
```

- The created DEFAULT values are obtained as the host variables.

```
gSQL> INSERT INTO region
      VALUES ( DEFAULT, DEFAULT )
      RETURNING r_regionkey, r_name
      INTO :v_key, :v_name;
V_KEY V_NAME
-----
      1 N/A
1 row created.
```

- The omitted column value is obtained as the host variable.

```
gSQL> INSERT INTO region(r_name)
      VALUES ('ASIA')
      RETURNING r_regionkey
      INTO :v_key;
V_KEY
-----
      2
1 row created.
```

Compatibility

The SQL standard does not define <insert returning into statement>.

For More Information

Refer to the followings.

- **INSERT INTO**
- **INSERT INTO name RETURNING**

16.117 LOCK TABLE

Function

It locks one or more tables.

Syntax

```
<lock table statement> ::=
    LOCK TABLE lock target [, ...]
    IN <lock mode> MODE [<wait clause>]
    ;
<lock mode> ::=
    SHARE
    | EXCLUSIVE
    | ROW SHARE
    | ROW EXCLUSIVE
    | SHARE ROW EXCLUSIVE
<wait clause> ::=
    NOWAIT
    | WAIT time
```

Invocation and Access Rules

One of the following privileges is required to perform <lock table statement>.

- (LOCK or CONTROL TABLE) ON TABLE for the table
- (LOCK TABLE or CONTROL SCHEMA) ON SCHEMA for the schema to which the table belongs
- LOCK ANY TABLE ON DATABASE

Syntax Rules and Parameters

<lock target>

It specifies the target table to be locked.

<lock mode>

It specifies the LOCK mode.

- SHARE
 - It allows concurrent queries for the locked table, but prohibits updating the table.
- EXCLUSIVE
 - It allows exclusive queries for the locked table.
- ROW SHARE
 - It allows concurrent access to the locked table, but prohibits locking the entire table for exclusive access.
- ROW EXCLUSIVE
 - It allows concurrent access to the locked table, but prohibits locking the entire table for exclusive access.
 - If ROW EXCLUSIVE mode is set, it prohibits locking in SHARE mode.
 - ROW EXCLUSIVE mode is automatically obtained when updating, inserting, deleting.
- SHARE ROW EXCLUSIVE
 - It is used to search for the entire table or to make other users search for the rows in the table.
 - It prohibits other users from accessing the locked tables in SHARE mode or accessing the rows being updated.

<wait clause>

It specifies the waiting time to acquire the lock.

- NOWAIT
 - It immediately acquires the lock control for the object.
 - If the lock is already set by another user, the control is immediately handed over.
 - In this case, the database generates a message.
- WAIT time
 - It sets the waiting time for acquiring the lock.
 - It is specified in seconds, and its value is from 0 to 1,000,000,000.
- If it is not specified, it waits indefinitely until acquiring the lock.

Description

If the transaction is committed or rolled back all acquired locks are automatically released. When using ROLLBACK TO SAVEPOINT statement, all locks acquired since that savepoint are released.

Examples

The following is an example of locking the TABLE t1 to prevent any updating operation by another transaction.

```
gSQL> LOCK TABLE t1 IN EXCLUSIVE MODE;  
Table locked.
```

The following is an example of performing LOCK statement for multiple tables.

```
gSQL> LOCK TABLE t1, t2 IN EXCLUSIVE MODE;  
Table locked.
```

The following is an example of acquiring SHARE ROW EXCLUSIVE lock for the TABLE t1.

```
gSQL> LOCK TABLE t1 IN SHARE ROW EXCLUSIVE MODE;  
Table locked.
```

The following statement is performed only when the lock can be immediately acquired for the table. If the lock can not be acquired, an error occurs.

```
gSQL> LOCK TABLE t1 IN EXCLUSIVE MODE NOWAIT;  
Table locked.
```

The following is an example of waiting 10 seconds to acquire the lock.

```
gSQL> LOCK TABLE t1 IN EXCLUSIVE MODE WAIT 10;  
Table locked.
```

Compatibility

The SQL standard does not cover the concepts of the lock table.

For More Information

Refer to the followings.

- COMMIT
- ROLLBACK

16.118 NOAUDIT POLICY

Function

It deactivates the audit policy.

Syntax

```
<noaudit policy statement> ::=  
    NOAUDIT POLICY policy_name  
    [ <specified_user_option> ]  
    ;  
<specified_user_option> ::=  
    BY user_name [, ...]
```

Invocation and Access Rules

AUDIT SYSTEM ON DATABASE privilege is required to perform <noaudit policy statement>.

Syntax Rules and Parameters

policy_name

It is the name of the audit policy object to be deactivated.

The deactivated audit policy does not effect on the existing session, and it effects only on the newly created session.

<specified_user_option>

It specifies the user to be excluded from the auditing target.

Unlike AUDIT POLICY statement, NOAUDIT POLICY does not have EXCEPT option.

If AUDIT POLICY name BY clause is used, NOAUDIT POLICY name BY statement should be used to deactivate it.

If AUDIT POLICY name EXCEPT clause is used, NOAUDIT POLICY name statement without BY clause should be used to deactivate it.

NOAUDIT POLICY statement should be used as follows according to the usage of AUDIT POLICY statement to deactivate it.

Table 16-58 Activating/ deactivating audit policy

Type	AUDIT POLICY statement	NOAUDIT POLICY statement
All users	AUDIT POLICY p1	NOAUDIT POLICY p1
Using BY	AUDIT POLICY p1 BY u1	NOAUDIT POLICY p1 BY u1
Using EXCEPT	AUDIT POLICY p1 EXCEPT u1	NOAUDIT POLICY p1

When deactivating all activated users, the audit policy object is completely deactivated.

Description

The information about activation of the audit policy object is retrieved as follows.

```
SELECT policy_name
       , enabled_opt
       , user_name
FROM audit_policy_enabled
WHERE policy_name = 'P1';
```

NOAUDIT POLICY statement deletes each created information about activation according to the AUDIT POLICY specifying method.

If the information activated through the query above does not exist, then the audit policy is completely deactivated.

If all users are activated as follows, NOAUDIT POLICY BY clause does not affect it.

```
AUDIT POLICY p1;
```

- It does not affect any.

```
NOAUDIT POLICY p1 BY u1;
```

- It should be deactivated as follows.

```
NOAUDIT POLICY p1;
```

If one or more users are separately activated, use NOAUDIT POLICY statement according to the AUDIT POLICY specifying method.

When Activated by Using BY

If the audit policy is activated as follows,

```
AUDIT POLICY p1 WHENEVER NOT SUCCESSFUL;
AUDIT POLICY p1 BY u1;
AUDIT POLICY p1 BY u2;
```

the information about activation is as follows.

```
SELECT policy_name
       , enabled_opt
       , user_name
       , when_success
       , when_failure
FROM   audit_policy_enabled
WHERE  policy_name = 'P1';
```

POLICY_NAME	ENABLED_OPT	USER_NAME	WHEN_SUCCESS	WHEN_FAILURE
P1	BY	ALL USERS	NO	YES
P1	BY	U1	YES	YES
P1	BY	U2	YES	YES

The following is an example of performing NOAUDIT statement and the information about activation.

```
NOAUDIT POLICY p1;
SELECT policy_name
       , enabled_opt
       , user_name
       , when_success
       , when_failure
FROM   audit_policy_enabled
WHERE  policy_name = 'P1';
```

POLICY_NAME	ENABLED_OPT	USER_NAME	WHEN_SUCCESS	WHEN_FAILURE
P1	BY	U1	YES	YES
P1	BY	U2	YES	YES

The auditing for a failure for ALL USERS is deactivated, but the auditing for user u1, u2 is still activated.

If NOAUDIT POLICY statement is additionally used through BY option as follows, then audit policy p1 is completely deactivated.

```
NOAUDIT POLICY p1 BY u1, u2;
SELECT policy_name
       , enabled_opt
       , user_name
       , when_success
       , when_failure
FROM   audit_policy_enabled
WHERE  policy_name = 'P1';
no rows selected.
```

When Activated by Using EXCEPT

If the audit policy is activated as follows,

```
AUDIT POLICY p1 EXCEPT u1, sys;
```

the information about activation is as follows.

```
SELECT policy_name
       , enabled_opt
       , user_name
       , when_success
       , when_failure
FROM   audit_policy_enabled
WHERE  policy_name = 'P1';
```

POLICY_NAME	ENABLED_OPT	USER_NAME	WHEN_SUCCESS	WHEN_FAILURE
P1	EXCEPT	U1	YES	YES
P1	EXCEPT	SYS	YES	YES

Unlike AUDIT POLICY statement, NOAUDIT POLICY does not have EXCEPT option, so execute the statement without an option as follows.

```
NOAUDIT POLICY p1;
SELECT policy_name
       , enabled_opt
       , user_name
```



```
, when_success  
, when_failure  
FROM audit_policy_enabled  
WHERE policy_name = 'P1';  
no rows selected.
```

In other words, if the audit policy is activated by using EXCEPT option, each user can not be activated again by using NOAUDIT POLICY statement.

Examples

The following is an example of deactivating all users.

```
NOAUDIT POLICY table_pol;
```

The following is an example of deactivating a specific activated user by using BY.

```
NOAUDIT POLICY table_pol BY u1;
```

Compatibility

The SQL standard does not have the audit policy.

For More Information

Refer to the followings.

- Managing audit policy object
 - CREATE AUDIT POLICY
 - DROP AUDIT POLICY
 - ALTER AUDIT POLICY
- Activating/ deactivating audit policy
 - AUDIT POLICY
 - NOAUDIT POLICY
- Viewing audit trail: **AUDIT_TRAIL**

- Clearing audit trail: **ALTER DATABASE CLEAR AUDIT TRAIL**

16.119 OPEN cursor_name

Function

It opens a cursor.

Syntax

```
<open statement> ::=  
    OPEN cursor_name [ <parameter using clause> ]  
    ;  
<parameter using clause> ::=  
    <using parameter arguments>  
<using parameter arguments> ::=  
    USING variable_name [, ...]
```

Invocation and Access Rules

If cursor_name is a dynamic cursor which is declared by using **PREPARE statement_name** and **DECLARE cursor_name**, it can be used in an embedded SQL.

It is same with the privilege of **<cursor query>** included in **DECLARE cursor_name** which declared cursor_name.

Syntax Rules and Parameters

cursor_name

It should be a cursor declared with **DECLARE cursor_name** within the session.

⟨parameter using clause⟩

It can be used in an embedded SQL.

When ⟨parameter using clause⟩ is used, `cursor_name` should be a dynamic cursor declared by using **PREPARE statement_name** and **DECLARE cursor_name**.

⟨using parameter arguments⟩

When ⟨using parameter arguments⟩ is used, the number of `variable_name` should be equal to the number of the parameter included in a query which is referenced by **PREPARE statement_name**.

The listed `variable_name` corresponds to the dynamic parameter in an order of its description.

```
{
  ...
  EXEC SQL PREPARE stmt1 FROM 'SELECT c1, c2 FROM t1 WHERE c1 IN ( ?, ?, ? )';
  EXEC SQL DECLARE cur1 CURSOR FOR stmt1;
  EXEC SQL OPEN cur1 USING :sValue1, :sValue2, :sValue3;
  ...
  EXEC SQL WHENEVER NOT FOUND DO break;
  for(;;)
  {
    EXEC SQL FETCH cur1 INTO :sC1, :sC2;
  }
  EXEC SQL WHENEVER NOT FOUND CONTINUE;
  ...
  EXEC SQL CLOSE cur1;
  ...
}
```

Description

The cursor is a distinguishable object in a session. The cursor being used in the current session has nothing to do with the cursor being used in another session.

To use `OPEN cursor_name` statement, it should be a cursor declared with **DECLARE cursor_name**, and it should be a closed cursor.

Examples

The following is an example of declaring a cursor and using OPEN cursor statement in an interactive SQL (gsql).

```
gSQL> DECLARE cur1 CURSOR FOR SELECT id, data FROM t1;
Cursor declared.
gSQL> OPEN cur1;
Cursor is open.
gSQL> \var v_id    INTEGER
gSQL> \var v_data VARCHAR(128)
gSQL> FETCH cur1 INTO :v_id, :v_data;
V_ID V_DATA
-----
      1 data_1
1 row fetched.
gSQL> FETCH cur1 INTO :v_id, :v_data;
V_ID V_DATA
-----
      2 data_2
1 row fetched.
gSQL> FETCH cur1 INTO :v_id, :v_data;
V_ID V_DATA
-----
      3 data_3
1 row fetched.
gSQL> FETCH cur1 INTO :v_id, :v_data;
V_ID V_DATA
-----
      4 data_4
1 row fetched.
gSQL> FETCH cur1 INTO :v_id, :v_data;
V_ID V_DATA
-----
      5 data_5
1 row fetched.
gSQL> FETCH cur1 INTO :v_id, :v_data;
no rows fetched.
gSQL> CLOSE cur1;
Cursor closed.
```

Compatibility

Table 16-59 SQL standard compatibility

Feature ID	Description	Compatibility
B031	Basic Dynamic SQL	O

For More Information

Refer to the followings.

- `DECLARE cursor_name`
- `FETCH cursor_name`
- `CLOSE cursor_name`
- `PREPARE statement_name`

16.120 PREPARE statement_name

Function

It prepares a dynamic SQL statement for a repeated execution.

Syntax

```
<prepare statement> ::=  
    PREPARE statement_name FROM <SQL statement variable>  
    ;  
<SQL statement variable> ::=  
    variable_name  
    | 'sql statement'  
    | "sql statement"  
    | sql statement
```

Invocation and Access Rules

It can be used in an embedded SQL.

An appropriate privilege according to the type of a dynamic SQL statement is required.

Syntax Rules and Parameters

statement_name

It is the name of the statement to be prepared.

The length of the statement name should be shorter than 128 bytes.

EXECUTE statement_name and **DECLARE cursor_name**, which are to be performed later, refers to the statement_name.

If the same statement_name exists, the previously prepared dynamic SQL is dropped.

```

{
  ...
  EXEC SQL PREPARE stmt1 FROM 'DELETE FROM t1';
  ...
  EXEC SQL PREPARE stmt1 FROM 'UPDATE t1 SET c1 = c1 + 10';
  ...
}

```

⟨SQL statement variable⟩

⟨SQL statement variable⟩ can be used as following four types.

- `variable_name`: It is a variable in which an SQL statement is stored.
- `'sql statement'`: It is an SQL statement which is enclosed with single quote (').
- `"sql statement"`: It is an SQL statement which is enclosed with double quotes (").
- `sql statement`: It is an SQL statement without quote.

The single quote (') is used twice as follows to represent string data within single-quoted string.

```

{
  ...
  PREPARE stmt_name FROM 'INSERT INTO t1 VALUES ( ''literal data'' )';
  ...
}

```

The dynamic SQL statement referenced by ⟨SQL statement variable⟩ can use a host variable (:var) or parameter marker (?).

However, if the unquoted SQL statement is used, the parameter marker (?) can not be used.

Depending on the characteristics of the referenced dynamic SQL statements, the variable can be either input or output dynamic parameter.

The dynamic parameter described in the dynamic SQL statement does not have a meaning for the variable name, and it is identified by the specified order regardless of its type.

- Example 1

```

{
  ...
  int sValue1;
  int sValue2;
  ...
  EXEC SQL PREPARE stmt1 FROM 'DELETE FROM t1 WHERE c1 BETWEEN ? AND ?';
}

```



```

EXEC SQL EXECUTE stmt1 USING :sValue1, :sValue2;
...
}

```

- All parameter markers are the input dynamic parameters.
- The order to identify
 - No. 1 - BETWEEN ?
 - Input dynamic parameter
 - It uses the value of :sValue1.
 - No. 2 - AND ?
 - Input dynamic parameter
 - It uses the value of :sValue2.
- Example 2

```

{
...
int sValue1;
int sValue2;
...
EXEC SQL PREPARE stmt1 FROM 'SELECT SUM(c2) INTO :v1 FROM t1 WHERE c1 > :v2';
EXEC SQL EXECUTE stmt1 USING :sValue1, :sValue2;
...
}

```

- The input dynamic parameter and the output dynamic parameter exist.
- The order to identify
 - No. 1 - :v1
 - Output dynamic parameter
 - It stores the value in :sValue1.
 - No. 2 - :v2
 - Input dynamic parameter
 - It uses the value of :sValue2.

variable_name

The type corresponding to variable_name should be a character string.
 The dynamic SQL statement defined in variable_name should be valid.

sql statement

The dynamic SQL statement defined in the sql statement should be valid.

Description

PREPARE statement_name FROM sql_string statement analyzes SQL statement to use EXECUTE or cursor statement. Statement_name is an identifier which informs the precompiler the statement in an embedded SQL source code. A separate type or declaration is not required because statement_name is not a host variable.

For more information, refer to **Embedded Dynamic SQL**.

Example

The following is an example of using PREPARE statement_name in an embedded SQL source code.

```
{
    ...
    sprintf( sUpdateSql, "UPDATE EMP SET sal = sal * :v1 WHERE JOB = 'SALES'");
    EXEC SQL PREPARE UPDATE_STMT FROM :sUpdateSql;
    if(sqlca.sqlcode != 0)
    {
        goto fail_exit;
    }
    sRatio = 1.1;
    EXEC SQL EXECUTE UPDATE_STMT USING :sRatio;
    if(sqlca.sqlcode != 0)
    {
        goto fail_exit;
    }
    ...
}
```

The full source code in which PREPARE statement_name was used can be viewed in **Dynamic Embedded SQL Example Program**.

Compatibility

Table 16-60 SQL standard compatibility

Feature ID	Description	Compatibility
B031	Basic Dynamic SQL	O
B034	Dynamic specification of cursor attributes	X

For More Information

Refer to the followings.

- EXECUTE statement_name
- DECLARE cursor_name
- EXECUTE IMMEDIATE 'sql_string'
- Embedded Dynamic SQL

16.121 RELEASE SAVEPOINT savepoint_specifier

Function

It releases a savepoint.

Syntax

```
<release savepoint statement> ::=  
    RELEASE SAVEPOINT savepoint_name  
    ;
```

Syntax Rules and Parameters

savepoint_name

It is a name of the savepoint, and it should exist.

The length of the savepoint name should be shorter than 128 bytes.

Description

If multiple savepoints are defined and `RELEASE SAVEPOINT savepoint_name` statement is performed, all savepoints defined since the `savepoint_name` are also released.

Example

The following is an example of releasing a savepoint.

```
gSQL> RELEASE SAVEPOINT sp2;  
Savepoint dropped.
```

Compatibility

Table 16-61 SQL standard compatibility

Feature ID	Description	Compatibility
T271	Savepoints	O

For More Information

Refer to the followings.

- COMMIT
- ROLLBACK
- SAVEPOINT savepoint_specifier

16.122 REVOKE privileges FROM

Function

It revokes the granted privilege from a user.

Syntax

```

<revoke privilege statement> ::=
    REVOKE [ <revoke option extention> ] <privilege>
        FROM <grantee> [, ...]
        [ <revoke behavior> ]
    ;
<revoke option extention> ::=
    GRANT OPTION FOR
<revoke behavior> ::=
    RESTRICT
    | CASCADE
    | CASCADE CONSTRAINTS

```

Syntax Rules and Parameters

<privilege>

It is a privilege which is to be revoked from the revokee (the user whose privilege is to be revoked).

The revoker (the user who performs the statement) should satisfy one of the following conditions.

- If it is <privilege> which the revoker grants to the revokee.
 - Only the <privilege> which the revoker grants to the revokee is revoked.
- If the revoker owns ACCESS CONTROL ON DATABASE privilege.
 - The <privilege> which other grantors grant to the revokee is revoked.

When using ALL [PRIVILEGES], it succeeds even when the satisfying <privilege> does not exist.

For more information about the types of <privilege>, refer to <privilege> clause of **GRANT privileges TO** statement.

<grantee>

It is a user whose privilege is to be revoked.

- user_identifier
 - It revokes the privilege of that user.
- PUBLIC
 - They are authorization objects which mean all users.

GRANT OPTION FOR

It revokes WITH GRANT OPTION included in the privilege.

It also revokes WITH GRANT OPTION of the dependent privilege.

The privilege is maintained.

<revoke behavior>

- Dependent privilege: It is as same as the <privilege> which was granted to the revokee by using WITH GRANT OPTION and granted to another user by the revokee.
- RESTRICT
 - If the dependent privilege exists, it can not be revoked.
- CASCADE
 - The dependent privilege should also be revoked.
- CASCADE CONSTRAINTS
 - The dependent privilege should also be revoked.
- If it is omitted, the default value is CASCADE.

Description

Data Definition Language (DDL) such as REVOKE privilege can be rolled back if it is before when the transaction is committed.

When performing the following DROP statement, all privilege information related to the object is revoked even without performing any separate REVOKE statement.

- DROP statement related to SQL schema object

- DROP TABLE
 - DROP VIEW
 - DROP SEQUENCE
 - ALTER TABLE name SET UNUSED COLUMN
 - DROP FUNCTION
 - DROP PROCEDURE
- DROP statement related to non-schema object
 - DROP SCHEMA
 - DROP TABLESPACE
 - DROP USER

Examples

The following is an example of revoking multiple privileges for the table t1.

```
gSQL> REVOKE INSERT, UPDATE, DELETE, LOCK, ALTER, INDEX ON t1 FROM u1;  
Revoke succeeded.
```

The following is an example of revoking SELECT ON TABLE t1 privilege granted to the PUBLIC account, which means all users. However, only the privilege for PUBLIC account is revoked, and SELECT ON TABLE t1 privilege which was explicitly granted to a specific user is not revoked.

```
gSQL> REVOKE SELECT ON t1 FROM PUBLIC;  
Revoke succeeded.
```

The following is an example that SELECT ON TABLE t1 privilege granted to user u1 is remained, and only REVOKE GRANT OPTION which can grant the privilege to another user is revoked.

```
gSQL> REVOKE GRANT OPTION FOR SELECT ON t1 FROM u1;  
Revoke succeeded.
```

The following is an example that an error occurs when the privilege granted to the user u1 is revoked by using RESTRICT option and the user u1 grants it to another user. CASCADE option is used to revoke these dependent privileges as well.

```
gSQL> REVOKE SELECT ON t1 FROM u1 RESTRICT;  
ERR-2B000(16235): dependent privilege descriptors still exist  
gSQL> REVOKE SELECT ON t1 FROM u1 CASCADE;  
Revoke succeeded.
```

Compatibility

The SQL standard does not define the following privileges.

- <database privilege>
- <tablespace privilege>
- <schema privilege>

<revoke behavior> of the SQL standard has the following differences.

- The default value of the SQL standard is RESTRICT.
- The SQL standard does not cover CASCADE CONSTRAINTS.

Table 16-62 SQL standard compatibility

Feature ID	Description	Compatibility
T311	Basic roles	X
F034	Extended REVOKE statement	X
S081	Subtables	X

For More Information

Refer to the followings.

- **GRANT privileges TO**
- <database privilege>
- <tablespace privilege>
- <schema privilege>
- <table privilege>
- Column privilege
- <sequence privilege>

16.123 ROLLBACK

Function

It rolls back a transaction, or the operation after the savepoint.

Syntax

```
<rollback statement> ::=  
    ROLLBACK [ WORK ] [ <rollback force clause> | <savepoint clause> ]  
    ;  
<rollback force clause> ::=  
    FORCE 'xid_string' [ COMMENT 'comment_string' ]  
<savepoint clause> ::=  
    TO SAVEPOINT savepoint_name
```

Syntax Rules and Parameters

WORK

It is a reserved word which does not affect the operation.

<rollback force clause>

It is used to manually rollback the distributed transaction.

- FORCE 'xid_string'
 - It rolls back the distributed transaction corresponding to 'xid_string'.
 - 'xid_string' consists of 'format_id.transaction_id.branch_id'.
- COMMENT 'comment_string'
 - It specifies the comment on a transaction when rolling back the distributed transaction.

<savepoint clause>

It specifies the rollback scope of the current transaction.

- If it is omitted
 - It undoes all operations of the current transaction.
 - It ends the transaction.
 - It deletes all savepoints.
 - It releases all transaction locks.
- TO SAVEPOINT savepoint_name
 - It undoes the operations of the current transaction since savepoint_name.
 - It does not end the transaction.
 - It deletes all savepoints since savepoint_name.
 - It releases all transaction locks acquired since savepoint_name.

Description

ROLLBACK statement undoes the following statements performed in the transaction.

- Data Manipulation Language (DML) statement
 - The statements to update data, such as INSERT, UPDATE and DELETE
- Data Definition Language (DDL) statement
 - The statements to alter the structure and definition of the object such as CREATE, DROP, ALTER, TRUNCATE, GRANT and REVOKE

Exceptionally, the following statements of DDL which deals with OS resources or alters the DATA TYPE can not be rolled back, but are automatically committed when executing the statement.

- CREATE TABLESPACE
- DROP TABLESPACE
- ALTER TABLESPACE
- ALTER TABLE .. ALTER COLUMN .. SET DATA TYPE: <alter column data type clause>

Examples

The following is an example of rolling back the INSERT statement.

```

gSQL> INSERT INTO t1 VALUES ( 1, 'anonymous' );
1 row created.
gSQL> SELECT * FROM t1;
ID DATA
-- -----
1 anonymous
1 row selected.
gSQL> ROLLBACK;
Rollback complete.
gSQL> SELECT * FROM t1;
no rows selected.

```

The following is an example of ROLLBACK after performing the DROP TABLE statement.

```

gSQL> DROP TABLE t1;
Table dropped.
gSQL> SELECT * FROM t1;
ERR-42000(16040): table or view does not exist :
SELECT * FROM t1
          *
ERROR at line 1:
gSQL> ROLLBACK;
Rollback complete.
gSQL> SELECT * FROM t1;
ID DATA
-- -----
1 anonymous
1 row selected.

```

Compatibility

Table 16-63 SQL standard compatibility

Feature ID	Description	Compatibility
T271	Savepoints	O
T261	Chained transactions	X

For More Information

Refer to the followings.

- COMMIT
- SAVEPOINT `savepoint_specifier`

16.124 SAVEPOINT savepoint_specifier

Function

It defines a savepoint.

Syntax

```
<savepoint statement> ::=  
    SAVEPOINT savepoint_name  
    ;
```

Syntax Rules and Parameters

savepoint_name

It is a name of the savepoint.

If the savepoint name is as same as the existing savepoint name, then the existing savepoint is deleted.

The length of the savepoint name should be shorter than 128 bytes.

Description

The defined savepoint is used by ROLLBACK TO SAVEPOINT statement (refer to **ROLLBACK.**), and DML or DDL statement which has been performed up to the savepoint is rolled back. Then the locks acquired by using that statement are released, too.

The defined savepoint is automatically deleted when the transaction is committed or rolled back, or it can be explicitly deleted by using **RELEASE SAVEPOINT savepoint_specifier**.

Example

The following is an example of defining the savepoint and using ROLLBACK TO SAVEPOINT statement.

```
gSQL> SAVEPOINT sp1;
Savepoint created.
gSQL> INSERT INTO t1 VALUES ( 1, 'anonymous' );
1 row created.
gSQL> SAVEPOINT sp2;
Savepoint created.
gSQL> INSERT INTO t1 VALUES ( 2, 'someone' );
1 row created.
gSQL> SAVEPOINT sp3;
Savepoint created.
gSQL> INSERT INTO t1 VALUES ( 3, 'anyone' );
1 row created.
gSQL> SELECT * FROM t1;
ID DATA
-- -----
 1 anonymous
 2 someone
 3 anyone
3 rows selected.
gSQL> ROLLBACK TO SAVEPOINT sp3;
Rollback complete.
gSQL> SELECT * FROM t1;
ID DATA
-- -----
 1 anonymous
 2 someone
2 rows selected.
gSQL> ROLLBACK TO SAVEPOINT sp2;
Rollback complete.
gSQL> SELECT * FROM t1;
ID DATA
-- -----
 1 anonymous
1 row selected.
gSQL> ROLLBACK TO SAVEPOINT sp1;
Rollback complete.
```

```
gSQL> SELECT * FROM t1;  
no rows selected.
```

Compatibility

Table 16-64 SQL standard compatibility

Feature ID	Description	Compatibility
T271	Savepoints	O

For More Information

Refer to the followings.

- COMMIT
- ROLLBACK
- RELEASE SAVEPOINT `savepoint_specifier`

16.125 SELECT

query expression

Function

It retrieves desired rows from one or more tables or views.

Syntax

```
<query expression> ::=
    <query expression body> [ <order by clause> ] [ <offset limit clause> ]
<query expression body> ::=
    <query term>
    | <set operator>
<query term> ::=
    <query specification>
    | <left paren> <query expression body> [ <order by clause> ] [ <offset limit clause> ]
    <right paren>
```

Invocation and Access Rules

One of the following privileges for all tables used in the statement is required for a user to perform <query expression>.

- SELECT(columns) ON TABLE for all used columns of table in the statement
- (SELECT or CONTROL TABLE) ON TABLE for the table
- (SELECT TABLE or CONTROL SCHEMA) ON SCHEMA for the schema to which the table belongs
- SELECT ANY TABLE ON DATABASE

Syntax Rules and Parameters

<set operator>

It performs a set operation among the subqueries.

For more information, refer to **set operator**.

<query specification>

It specifies a single subquery.

For more information, refer to <query specification>.

<order by clause>

It specifies sorting information of a query result.

For more information, refer to **order by clause**.

<offset limit clause>

It specifies the number of rows to skip and the number of rows to fetch from the query result set.

For more information, refer to **offset limit clause**.

Description

It is specifying SELECT statement, and <order by clause>, <offset limit clause> can be omitted and two or more subqueries can be specified through <set operator>.

Examples

The following is an example of SELECT statement.

```
gSQL> SELECT s_name, s_nation FROM supplier;
S_NAME          S_NATION
-----
Supplier#1      FRANCE
Supplier#2      KOREA
Supplier#3      GERMANY
Supplier#4      UNITED STATES
Supplier#5      CANADA
5 rows selected.
```

The following is an example of the SELECT statement which uses <order by clause>.

```
gSQL> SELECT s_name, s_nation FROM supplier ORDER BY s_name DESC;
S_NAME          S_NATION
-----
Supplier#5      CANADA
Supplier#4      UNITED STATES
Supplier#3      GERMANY
```

```
Supplier#2          KOREA
Supplier#1          FRANCE
5 rows selected.
```

The following is an example of the SELECT statement which uses <offset limit clause>.

```
gSQL> SELECT s_name, s_nation FROM supplier OFFSET 1;
S_NAME          S_NATION
-----
Supplier#2      KOREA
Supplier#3      GERMANY
Supplier#4      UNITED STATES
Supplier#5      CANADA
4 rows selected.
gSQL> SELECT s_name, s_nation FROM supplier LIMIT 1;
S_NAME          S_NATION
-----
Supplier#1      FRANCE
1 row selected.
```

The following is an example of the SELECT statement which uses <order by clause> and <offset limit clause>.

```
gSQL> SELECT s_name, s_nation FROM supplier ORDER BY s_name DESC OFFSET 3 LIMIT 1;
S_NAME          S_NATION
-----
Supplier#2      KOREA
1 row selected.
```

Compatibility

Table 16-65 SQL standard compatibility

Feature ID	Description	Compatibility
T121	WITH(excluding RECURSIVE) in query expression	X
T122	WITH(excluding RECURSIVE) in subquery	X
T131	Recursive query	X
T132	Recursive query in subquery	X
F661	Simple tables	O
F302	INTERSECT table operator	O
F301	CORRESPONDING in query expressions	X
T551	Optional key words for default syntax	O

Feature ID	Description	Compatibility
F304	EXCEPT ALL table operator	O
F850	Top-level <order by clause> in <query expression>	X
F851	<order by clause> in subqueries	O
F855	Nested <order by clause> in <query expression>	O
F856	Nested <fetch first clause> in <query expression>	X
F857	Top-level <fetch first clause> in <query expression>	X
F858	<fetch first clause> in subqueries	X
F860	dynamic <fetch first row count> in <fetch first clause>	X
F861	Top-level <result offset clause> in <query expression>	O
F862	<result offset clause> in subqueries	O
F863	Nested <result offset clause> in <query expression>	O
F865	dynamic <offset row count> in <result offset clause>	X
F866	FETCH FIRST clause: PERCENT option	X
F867	FETCH FIRST clause: WITH TIES option	X

query specification

Function

It specifies the table which is derived from the result of <table expression>.

Syntax

```
<query specification> ::=
    SELECT [ <hint clause> ] [ <set quantifier> ] <select list> <table expression>
<set quantifier> ::=
    ALL
    | DISTINCT
<table expression> ::=
    <from clause> [ <where clause> ] [ <group by clause> ] [ <having clause> ]
```

Invocation and Access Rules

The use should satisfy one of the following conditions to perform <query specification>.

- The owner of that table
- SELECT privilege for the table
- The user owns one of SELECT TABLE, CONTROL TABLE, CONTROL privileges for the schema to which the table belongs
- The user owns the SELECT TABLE privilege for the database

Syntax Rules and Parameters

<hint clause>

It specifies the hint for query execution.
For more information, refer to **hint clause**.

<set quantifier>

It specifies whether to remove a duplicate of the query result.
If it is omitted, it operates in the same way as ALL.

<select list>

It specifies the expression to be output among query results.
For more information, refer to **select list**.

<from clause>

It specifies the tables to be retrieved.
For more information, refer to **from clause**.

<where clause>

It specifies conditions for retrieving.
For more information, refer to **where clause**.

<group by clause>

It specifies grouping of the query result.
For more information, refer to **group by clause**.

<having clause>

It specifies conditions for the grouping result.
For more information, refer to **having clause**.

Description

<hint clause>

<hint clause> is a statement that the user commands an optimizer to perform the better execution plan than the plan selected by an optimizer, if exist.

The optimizer of GOLDILOCKS preferentially applies <hint clause> specified by a user. If it is not applicable, the optimizer selects the best execution plan through the cost calculation.

Even when a syntactic error occurs in <hint clause>, GOLDILOCKS is set to ignore and perform it by default. Set "HINT_ERROR" property to *on*, then execute the query to check if a syntactic error exist in <hint clause>.

<set quantifier>

<set quantifier> sets whether to remove duplicates for each row consisting of the expressions specified in <select list>. The meaning of each set quantifier is as follows.

- ALL: It does not remove the duplicates from the result set.
- DISTINCT: It removes the duplicates from the result set.

⟨set quantifier⟩ can be omitted. If it is omitted, it is operated by default which is as same as ALL.

⟨select list⟩

⟨select list⟩ specifies the expression list to be returned from each row of the result set.

They are listed by separating by a comma (,).

An asterisk (*) is used to specify all columns in ⟨from clause⟩.

⟨from clause⟩

⟨from clause⟩ specifies the tables or views to be retrieved.

⟨where clause⟩

⟨where clause⟩ specifies the conditions to get only the desired results from the result obtained from ⟨table expression⟩.

⟨group by clause⟩

⟨group by clause⟩ specifies the grouping method for the result set acquired from ⟨table expression⟩.

When ⟨group by clause⟩ is specified, only the group key determining the group, or aggregation function for the data belonging to the group can be used in ⟨select list⟩.

⟨having clause⟩

⟨having clause⟩ specifies the retrieving condition for the group to get only the desired results from the grouped result set.

It is generally used together with ⟨group by clause⟩. When it is used without ⟨group by clause⟩, the result set returned from ⟨table expression⟩ operates as same as when ⟨group by clause⟩, a single group, is specified.

Examples

The following is an example of SELECT statement which uses ⟨hint clause⟩.

```
gSQL> SELECT /*+ INDEX_DESC(supplier, supplier_pk_index) */ s_name, s_nation FROM supplier;
S_NAME                S_NATION
-----
Supplier#5            CANADA
Supplier#4            UNITED STATES
```

```

Supplier#3          GERMANY
Supplier#2          KOREA
Supplier#1          FRANCE
5 rows selected.

```

The following is an example of SELECT statement which uses <set quantifier>.

```

gSQL> SELECT ALL p_type FROM part;
P_TYPE
-----
COPPER
NICKEL
STEEL
NICKEL
STEEL
5 rows selected.
gSQL> SELECT DISTINCT p_type FROM part;
P_TYPE
-----
COPPER
STEEL
NICKEL
3 rows selected.

```

The following is an example of SELECT statement which uses <where clause>.

```

gSQL> SELECT p_name, p_brand, p_type, p_size FROM part where p_size < 10;
P_NAME P_BRAND   P_TYPE P_SIZE
-----
Part#1 Brand#1  COPPER    7
Part#2 Brand#1  NICKEL    1
2 rows selected.

```

The following is an example of SELECT statement which uses <group by clause>.

```

gSQL> SELECT ps_partkey, SUM(ps_availqty) FROM partsupp GROUP BY ps_partkey;
PS_PARTKEY SUM(PS_AVAILQTY)
-----
1          11401
2          8025
3          13864
4          11564

```



```
5          8744
```

```
5 rows selected.
```

The following is an example of SELECT statement which uses <having clause>.

```
gSQL> SELECT ps_partkey, SUM(ps_availqty) FROM partsupp GROUP BY ps_partkey having
SUM(ps_availqty) > 10000;
```

```
PS_PARTKEY SUM(PS_AVAILQTY)
```

```
-----
```

```
1          11401
```

```
3          13864
```

```
4          11564
```

```
3 rows selected.
```

Compatibility

Table 16-66 SQL standard compatibility

Feature ID	Description	Compatibility
F801	Full set function	X
T051	Row types	X
T301	Functional dependencies	X
T325	Qualified SQL parameter references	X
T053	Explicit aliases for all-fields reference	O
T285	Enhanced derived column names	O

For More Information

Refer to [query expression](#).

select list

Function

It specifies the columns to be retrieved from the query result.

Syntax

```

<select list> ::=
    <asterisk>
  | <select sublist> [ { <comma> <select sublist> } ... ]
<select sublist> ::=
    <derived column>
  | <qualified asterisk>
<qualified asterisk> ::=
    <asterisked identifier chain> <period> <asterisk>
<asterisked identifier chain> ::=
    <asterisked identifier> [ { <period> <asterisked identifier> } ... ]
<derived column> ::=
    <value expression> [ <as clause> ]
<as clause> ::=
    [ AS ] <column name>

```

Invocation and Access Rules

If columns or subqueries exist in <select list> statement, to perform <select list>, a user should have the access privileges for the columns and the access privileges for the table and columns of the subqueries.

Syntax Rules and Parameters

<select list>

It has <asterisk> or <select sublist>.

<asterisk> can be used in <select list> only when it is alone. In other words, it can not specify <select sublist>.

If two or more <select sublist> are specified, each <select sublist> should be separated by a comma(,).

<select sublist>

It has <derived column> or <qualified asterisk>.

A single table can have only one <quantified asterisk>.

<derived column> can change the output name by using *AS*, and *AS* can be omitted.

Description

<select list>

<select list> specifies the columns to be included in the result set. If <asterisk> is specified in <select list>, all columns in <from clause> are specified as a select list, and <select sublist> can not be additionally specified.

<select sublist>

<select sublist> has <derived column> or <qualified asterisk>. If two or more <select sublist> are specified, they should be separated by a comma (',').

For <qualified asterisk>, all columns belonging to a particular table or view are set as a select list. For <derived column>, the column can be directly specified, or <value expression> can be specified.

<derived column> can change the column name by using <as clause>, and *AS* can be omitted.

Names to Be Set in select list

- When <column name> is specified in <derived column>, the name is set as a select list name.
- When <column name> is not specified in <derived column>, the select list name is specified as follows.
 - If <derived column> is a single column reference, the column name of a single column is set to a select list name.
 - If <derived column> is SQL parameter reference, <SQL parameter name> of SQL parameter is set as a select list name.
 - Otherwise, the column name of <derived column> is not set.
- When two or more tables exist in <from clause> and the columns with the same name are included in these tables, the table name or table alias should be specified to refer to these columns.

Examples

The following is an example of SELECT statement which uses <asterisk>.

```
gSQL> SELECT * FROM supplier;
```

S_SUPPKEY	S_NAME	S_NATION	S_PHONE
-----	-----	-----	-----

1 Supplier#1	FRANCE	27-918-335-1736
2 Supplier#2	KOREA	15-679-861-2259
3 Supplier#3	GERMANY	11-383-516-1199
4 Supplier#4	UNITED STATES	25-843-787-7479
5 Supplier#5	CANADA	21-151-690-3663

5 rows selected.

The following is an example of SELECT statement which uses <select sublist>.

```
gSQL> SELECT revenue.* FROM revenue;
```

```
SUPPLIER_NO TOTAL_REVENUE
```

```
-----
1      11978.64
2      20321.5
3      41844.68
```

3 rows selected.

```
gSQL> SELECT supplier_no suppno, total_revenue AS TOTAL FROM revenue;
```

```
SUPPNO    TOTAL
```

```
-----
1 11978.64
2 20321.5
3 41844.68
```

3 rows selected.

```
gSQL> SELECT 1, revenue.*, CAST( total_revenue AS NATIVE_INTEGER ) TOTAL FROM revenue;
```

```
1 SUPPLIER_NO TOTAL_REVENUE TOTAL
```

```
- - - - -
1      1      11978.64 11979
1      2      20321.5 20322
1      3      41844.68 41845
```

3 rows selected.

Compatibility

Unlike <select list>, the SQL standard supports <all fields reference>.

For More Information

Refer to [query specification](#).

from clause

Function

It specifies the table which is derived from one or more tables.

Syntax

```

<from clause> ::=
    FROM <table reference list>
<table reference list> ::=
    <table reference> [ { , <table reference> } ... ]
<table reference> ::=
    <table factor>
    | <joined table>
<table factor> ::=
    <table primary>
<table primary> ::=
    <table name> [ <cluster domain> ] [ [ AS ] <correlation name> ]
    | <derived table> [ <cluster domain> ] [ [ AS ] <correlation name> [ <left paren> <derived
column list> <right paren> ] ]
    | <parenthesized joined table>
<derived table> ::=
    <table subquery>
<parenthesized joined table> ::=
    <left paren> <parenthesized joined table> <right paren>
    | <left paren> <joined table> <right paren>
<derived column list> ::=
    <column name list>
<cluster domain> ::=
    @ <cluster domain name>
<cluster domain name> ::=
    GLOBAL
    | LOCAL
    | LOCAL_OFFLINE
    | <identifier>

```

Invocation and Access Rules

The access privilege for the table or view specified in <table reference list> is required.

Syntax Rules and Parameters

<table reference list>

- One or more tables can be specified in <table reference list> by using a comma (,).
- When two or more tables are specified
 - The evaluation order for the tables is from left to right.
 - When * is specified in <select list>, the columns are sequentially mapped in <select list> from the left table to the right table.

<table primary>

An alias name can be specified by using <correlation name>.

<table subquery> is in <derived table>, and an alias name can be specified by using <correlation name>. <derived column list> can be specified in <derived table>, and the number of <column name> in <derived column list> should be same as the number of the target of <select list> specified in <table subquery>.

If <derived column list> is specified in <derived table>, then it is sequentially mapped one to one with targets of <select list> specified in <table subquery>.

If <derived column list> is specified in <derived table>, <column name> in <derived column list> should be used to refer to <select list> of <table subquery> in <derived table>.

<correlation name>

The same <correlation name> should not exist two or more in <table reference list>.

When <correlation name> is specified in <table name> or <derived table>, <correlation name> should be used to refer to <table name> or <derived table>.

AS which is specified in front of <correlation name> can be omitted.

<derived column list>

The same <column name> should not exist two or more in <derived column list>.

<cluster domain>

- <cluster domain> may be a table, a view, or a table subquery, but a joined table in parentheses can not be <cluster domain>.
- <cluster domain> can not be specified in a table or a view whose structure or data is to be altered.
 - However, "@LOCAL" is specified in a target table for a data altering query created by **Processing SELECT in Cluster**.

<cluster domain name>

Only a cluster group name or a cluster member name can be <identifier> of <cluster domain name>.

Description

<table reference list>

Two or more tables can be specified in <table reference list> by using a comma (.). When specifying two or more tables, it operates in the same way as cross join each table from left to right. If the conditions to join two tables exist in <where clause>, the two tables operate in the same way as inner join which has <where clause> as a join condition.

If outer join operator (+) is used in <where clause>, it operates in the same way as outer join.

For more information about outer join operator (+), refer to outer join operator specification of **joined table**.

<table reference>

A single table, or view, table subquery, joined table can be <table reference>. They can have a correlation name except for the joined table.

For more information about joined table, refer to **joined table**.

<table primary>

The tables, views, table subqueries and joined tables in parentheses can be <table primary>. The table, view, table subquery can have a correlation name, and 'AS' can be omitted. If the correlation name is specified, it should be used in everywhere referring to the table, view, table subquery such as <select list>, <where clause>.

The table subquery can specify <derived column list> by using parentheses. The name specified in <derived column list> should be used in everywhere referring to table subquery column like as correlation name. To use <derived column list> in the table subquery, the correlation name should be specified.

The joined table enclosed with parentheses specifies the logical join order for the table participating in th

e join operation. At this time, if all join operations for the tables enclosed with parentheses are cross join, inner join, the join order can be changed by an optimizer.

<cluster domain>

When <cluster domain> is omitted, it means the same as using GLOBAL as <cluster domain name>.

<cluster domain name>

The reserved words defined in <cluster domain name> mean as follows.

- GLOBAL
 - It selects all cluster groups as a cluster domain.
- LOCAL
 - It selects only the server performing the user query as a cluster domain.
- LOCAL_OFFLINE
 - If the table to which the domain is to be applied is offline, it selects only the server performing the user query as a cluster domain.
 - If LOCAL_OFFLINE domain is specified in an online table, then an error occurs.

If <identifier> is specified in <cluster domain name>, a cluster group or a cluster member with the corresponding name is selected as **Cluster Domain**.

Examples

The following is an example of SELECT statement to query a single table by using <table name>.

```
gSQL> SELECT c_name, c_nation FROM customer;
C_NAME      C_NATION
-----
Customer#1  KOREA
Customer#2  CANADA
Customer#3  KOREA
Customer#4  GERMANY
Customer#5  UNITED STATES
5 rows selected.
```

The following is an example of SELECT statement which uses <derived table>.

```
gSQL> SELECT * FROM (SELECT c_name, c_nation FROM customer);
C_NAME      C_NATION
-----
Customer#1  KOREA
```



```

Customer#2 CANADA
Customer#3 KOREA
Customer#4 GERMANY
Customer#5 UNITED STATES
5 rows selected.
gSQL> SELECT * FROM (SELECT c_name, c_nation FROM customer) AS CUST ("CUSTOMER_NAME",
"CUSTOMER_NATION");
CUSTOMER_NAME CUSTOMER_NATION
-----
Customer#1     KOREA
Customer#2     CANADA
Customer#3     KOREA
Customer#4     GERMANY
Customer#5     UNITED STATES
5 rows selected.

```

The following is an example of SELECT statement for a joined table which uses parentheses.

```

gSQL> SELECT customer.c_name, o_totalprice FROM (customer INNER JOIN orders ON
customer.c_custkey = orders.o_custkey);
C_NAME      O_TOTALPRICE
-----
Customer#1  173665.47
Customer#2  46929.18
Customer#4  193846.25
Customer#3  32151.78
Customer#5  144659.2
5 rows selected.

```

The following is an example of SELECT statement which uses two table separated by a comma (,).

```

gSQL> SELECT c_name, o_totalprice FROM customer, orders;
C_NAME      O_TOTALPRICE
-----
Customer#1  173665.47
Customer#1  46929.18
Customer#1  193846.25
Customer#1  32151.78
Customer#1  144659.2
Customer#2  173665.47
Customer#2  46929.18
Customer#2  193846.25

```

```

Customer#2      32151.78
Customer#2      144659.2
Customer#3      173665.47
Customer#3      46929.18
Customer#3      193846.25
Customer#3      32151.78
Customer#3      144659.2
Customer#4      173665.47
Customer#4      46929.18
Customer#4      193846.25
Customer#4      32151.78
Customer#4      144659.2
C_NAME         O_TOTALPRICE
-----
Customer#5      173665.47
Customer#5      46929.18
Customer#5      193846.25
Customer#5      32151.78
Customer#5      144659.2
25 rows selected.

```

The following is an example of SELECT statement which uses <cluster domain>.

- Using the reserved word GLOBAL

```

gSQL> SELECT * FROM (SELECT c_name, c_nation FROM customer@GLOBAL);
C_NAME      C_NATION
-----
Customer#1  KOREA
Customer#2  CANADA
Customer#3  KOREA
Customer#4  GERMANY
Customer#5  UNITED STATES
5 rows selected.

```

- Using the reserved word LOCAL

```

gSQL> SELECT * FROM (SELECT c_name, c_nation FROM customer)@LOCAL;
C_NAME      C_NATION
-----
Customer#1  KOREA
Customer#2  CANADA

```

2 rows selected.

- Using the cluster group name G1

```
gSQL> SELECT * FROM (SELECT c_name, c_nation FROM customer@G1);
C_NAME      C_NATION
-----
Customer#1  KOREA
Customer#2  CANADA
2 rows selected.
```

- Using the cluster member name G2N1

```
gSQL> SELECT * FROM (SELECT c_name, c_nation FROM customer@G2N1);
C_NAME      C_NATION
-----
Customer#3  KOREA
Customer#4  GERMANY
2 rows selected.
```

Compatibility

The SQL standard has the following differences compared to GOLDILOCKS.

- It supports `<sample clause>` in `<table factor>`.
- It supports `<lateral derived table>`, `<collection derived table>`, `<table function derived table>`, `<only spec>`, `<data change delta table>` in `<table primary>`.
 - `<lateral derived table>` allows `<from clause>` to refer to the left tables of the corresponding statement within subquery of `<lateral derived table>`. (e.g. `select * from dual a,(select * from dual b where a.dummy = b.dummy);`)
 - `<only spec>` does not allow the results of the subview to be included if the view of `<from clause>` is a hierarchical view.
- It supports system-versioned table in `<table primary>`.
- It supports `<derived column list>` in `<table primary>`.
- It supports `<transition table name>` and `<query name>` in `<table primary>`.
- `<correlation name>` should exist for `<derived table>`.

For More Information

Refer to `subquery`.

joined table

Function

It specifies the table derived from a cartesian product, inner join, outer join.

Syntax

```

<joined table> ::=
    <cross join>
  | <qualified join>
  | <natural join>
<cross join> ::=
    <table reference> CROSS JOIN <table factor>
<qualified join> ::=
    <table reference> [ <join type> ] JOIN <table reference> <join specification>
<natural join> ::=
    <table reference> NATURAL [ <join type> ] JOIN <table factor>
<join specification> ::=
    <join condition>
  | <named columns join>
<join condition> ::=
    ON <search condition>
<named columns join> ::=
    USING ( <join column list> )
<join type> ::=
    INNER
  | { LEFT | RIGHT | FULL } [ OUTER ]
<join column list> ::=
    <column name list>

```

Invocation and Access Rules

The access privilege for all tables and views specified in a joined table is required.

Syntax Rules and Parameters

<cross join>

<join specification> does not appear, and a single table, <table subquery> or <joined table> in parentheses can appear on the right.

<qualified join>

- <join specification> should be specified.
- <join type> can be omitted. When it is omitted, it performs INNER.
- OUTER can be omitted in <join type>.
- If <join type> is OUTER JOIN, only <join condition> can appear in <join specification>. (If <named columns join> appears, an error occurs.)

<natural join>

- <join specification> does not appear and a single table, <table subquery> or <joined table> in parentheses can appear on the right.
- <join type> can be omitted. When it is omitted, it performs INNER.
- It does not support OUTER in <join type>.
- If the same <column name> does not exist between the left row and right row of NATURAL JOIN, it performs <cross join>.
- If the same <column name> exists between the left row and right row of NATURAL JOIN, it is treated in the same way specified with USING clause.
- If comparison operation does not exist for the two corresponding columns, an error occurs.

<join specification>

- Only one of <join condition> or <named columns join> can be specified.
- When <named columns join> is specified
 - One or more column name should be specified in <join column list>.
 - The column name can not be specified such as <table name>.<column name>.
 - The listed columns in <join column list> should be on the left row and right row of JOIN, and they should be able to be compared.
 - If * is used in <select list>, the display column names of listed columns in <join column list> are corresponding column names, and those columns are excluded from the left row and right row of JOIN.
 - If * is used in <select list>, the display order of target is the listed columns in <join column list>, followed by the columns which does not correspond to <join column list> on the left row, then followed by the columns which does not correspond to <join column list> on the right row.
 - The columns corresponding to the left row and right row of the columns specified in <join column list> of the JOIN statement can not be referenced. (In other words, <column name> specified in <join column list> can not be referenced such as <table name>.<column name>, but only <column name> can be referenced.)

- If the listed columns in <join column list> are treated using a join condition, the condition <left table name>.<column name> = <right table name>.<column name> is generated for each <column name>, and the conditions to treat each <column name> condition using AND are generated and processed.
- It can not use '<table name>.*' phrase which returns all the row for a particular table to <select list>.
- If comparison operation does not exist for the two corresponding columns, an error occurs.

Description

<cross join>

<cross join> returns a result which combines all of each left row with each right rows.

The explicit join condition can not be specified in <cross join>, but the join condition for the two tables can be specified in <where clause>. In this case, it performs inner join.

<qualified join>

<qualified join> returns results which satisfy the join condition in combinations of all right rows for each left row. If <where clause> exists, the conditions of <where clause> are applied to the result rows to which the join condition is applied when executing join statement.

The result is same, even when inner join treats the conditions in <where clause> in the same way as the join conditions. But result differs when outer join treats the conditions in <where clause> in the same way as the join conditions.

Left outer join returns combined results of rows when right rows satisfying the condition for the left rows exist. If right rows satisfying the condition for the left rows do not exist, then it keep the value of left rows and fill the value of right rows with NULL and return them as a result.

Right outer join is operated exactly contrary to the left outer join.

Full outer join returns the result of left outer join, and rows whose values of the left rows are filled with NULL for all right rows which do not satisfy the join condition.

<natural join>

<natural join> joins all columns with same names in two tables participating in join as equal. In other words, it is as same as specifying all columns with same names in two tables participating in join in USING clause of inner join.

⟨join specification⟩

⟨join condition⟩ specifies the condition for joining left rows and right rows of a join statement. ⟨named columns join⟩ specifies the join condition by listing that ⟨column name⟩, if the same ⟨column name⟩ exist in left rows and right rows.

Examples

The following is an example of SELECT statement which uses ⟨cross join⟩.

```
gSQL> SELECT c_name, o_totalprice FROM customer CROSS JOIN orders;
```

C_NAME	O_TOTALPRICE
-----	-----
Customer#1	173665.47
Customer#1	46929.18
Customer#1	193846.25
Customer#1	32151.78
Customer#1	144659.2
Customer#2	173665.47
Customer#2	46929.18
Customer#2	193846.25
Customer#2	32151.78
Customer#2	144659.2
Customer#3	173665.47
Customer#3	46929.18
Customer#3	193846.25
Customer#3	32151.78
Customer#3	144659.2
Customer#4	173665.47
Customer#4	46929.18
Customer#4	193846.25
Customer#4	32151.78
Customer#4	144659.2
C_NAME	O_TOTALPRICE
-----	-----
Customer#5	173665.47
Customer#5	46929.18
Customer#5	193846.25
Customer#5	32151.78
Customer#5	144659.2

25 rows selected.

The following is an example of SELECT statement which uses inner join.

```
gSQL> SELECT c_name, o_totalprice FROM customer INNER JOIN orders ON c_custkey = o_custkey;
C_NAME      O_TOTALPRICE
-----
Customer#1   173665.47
Customer#2   46929.18
Customer#4   193846.25
Customer#3   32151.78
Customer#5   144659.2
5 rows selected.
```

The following is an example of SELECT statement which uses outer join.

```
gSQL> SELECT c_name, o_totalprice FROM customer LEFT OUTER JOIN orders ON c_custkey =
o_custkey AND o_orderdate < '1996-01-01';
C_NAME      O_TOTALPRICE
-----
Customer#1      null
Customer#2      null
Customer#3      32151.78
Customer#4      193846.25
Customer#5      144659.2
5 rows selected.
```

```
gSQL> SELECT c_name, o_totalprice FROM customer RIGHT OUTER JOIN orders ON c_custkey =
o_custkey AND c_nation = 'KOREA';
C_NAME      O_TOTALPRICE
-----
Customer#1   173665.47
null         46929.18
null         193846.25
Customer#3   32151.78
null         144659.2
5 rows selected.
```

```
gSQL> SELECT c_name, o_totalprice FROM customer FULL OUTER JOIN orders ON c_custkey =
o_custkey AND c_nation = 'KOREA' AND o_orderdate < '1996-01-01';
C_NAME      O_TOTALPRICE
-----
Customer#1      null
Customer#2      null
Customer#3      32151.78
```



```

Customer#4      null
Customer#5      null
null           173665.47
null           46929.18
null           193846.25
null           144659.2
9 rows selected.

```

The following is an example of SELECT statement which uses natural join.

```

gSQL> SELECT c_name, o_totalprice FROM (SELECT c_custkey custkey, c_name FROM customer)
NATURAL JOIN (SELECT o_custkey custkey, o_totalprice FROM orders);
C_NAME      O_TOTALPRICE
-----
Customer#1  173665.47
Customer#2  46929.18
Customer#4  193846.25
Customer#3  32151.78
Customer#5  144659.2
5 rows selected.

```

Compatibility

The SQL standard has the following differences compared to GOLDILOCKS.

- It supports <partitioned join table> for <qualified join> and <natural join>.
- It supports USING clause for the outer join.
- It supports the type for outer join as <join type> of <natural join>.
- It supports <set function specification> in <join condition>.

Table 16-67 SQL standard compatibility

Feature ID	Description	Compatibility
F401	Extended joined table	O
F402	Named column joins for LOBs, arrays, and multisets	X
F403	Partitioned join tables	X

For More Information

Refer to [from clause](#).

where clause

Function

It applies <search condition> to the result of <from clause>.

Syntax

```
<where clause> ::=
    WHERE <search condition>
```

Syntax Rules and Parameters

<where clause>

<search condition> which returns a boolean type is required after WHERE keyword.

Description

For more information about <where clause>, refer to **Conditions**.

Example

The following is an example of SELECT statement which uses <where clause>.

```
gSQL> SELECT s_name, s_nation FROM supplier WHERE s_nation = 'KOREA';
S_NAME                S_NATION
-----
Supplier#2            KOREA
1 row selected.
gSQL> SELECT s_name, ps_availqty, ps_supplycost FROM supplier, partsupp WHERE s_nation =
'KOREA' AND s_suppkey = ps_suppkey;
S_NAME                PS_AVAILQTY PS_SUPPLYCOST
-----
Supplier#2            8076        993.49
Supplier#2            4069        357.84
2 rows selected.
```

Compatibility

Table 16-68 SQL standard compatibility

Feature ID	Description	Compatibility
F441	Extended set function support	O

For More Information

Refer to [query specification](#).

group by clause

Function

It specifies the grouped table of which <group by clause> was applied to the result processed by the previous statements.

Syntax

```
<group by clause> ::=  
    GROUP BY <grouping element list>  
<grouping element list> ::=  
    <grouping element> [ { , <grouping element> } ... ]  
<grouping element> ::=  
    <ordinary grouping set>  
    | <empty grouping set>  
<ordinary grouping set> ::=  
    <grouping column reference>  
<grouping column reference> ::=  
    <column reference>  
    | <value_expression>  
<empty grouping set> ::=  
    <left paren> <right paren>
```

Invocation and Access Rules

Any separate access privilege is not required for a user to perform <group by clause>.

Syntax Rules and Parameters

<ordinary grouping set>

It consists of one or more <grouping column reference>.

It does not support LONG type.

<empty grouping set>

It can be specified by using only parentheses, and any expression should not be used within the parentheses.

Description

⟨grouping element list⟩

⟨grouping element⟩ in ⟨group by clause⟩ is grouped sequentially into a GROUPING SET. At this time, if all values of ⟨grouping element⟩ in GROUPING SET are matched sequentially, it is processed as the same group.

When ⟨group by clause⟩ is specified, the column in ⟨group by clause⟩ or the column, not in ⟨group by clause⟩ but in aggregate functions, can appear in ⟨select list⟩.

⟨grouping column reference⟩

⟨column reference⟩ or ⟨value expression⟩ can appear in ⟨grouping column reference⟩.

For ⟨column reference⟩, only the columns belong to ⟨from clause⟩ of ⟨query specification⟩ can be referenced. If columns with a same name exist, the column name should be explicitly specified by using the table name.

⟨value expression⟩ consists of expressions which include or do not include ⟨column reference⟩. The former can be divided into several groups by ⟨column reference⟩, but all records of the latter are configured into a single group because all values of ⟨value expression⟩ is an identical constant value.

If NULL is specified in ⟨value expression⟩, all NULL values are treated as the same value. Therefore, all records with NULL values are configured into a single group.

⟨empty grouping set⟩

⟨empty grouping set⟩ specifies that the grouping target column does not exist. Therefore, all records are configured into a single group.

Example

The following is an example of SELECT statement which uses GROUP BY clause.

```
gSQL> SELECT c_nation, COUNT(c_name) FROM customer GROUP BY c_nation;
C_NATION      COUNT(C_NAME)
-----
UNITED STATES      1
CANADA             1
KOREA              2
GERMANY            1
4 rows selected.
gSQL> SELECT COUNT(c_name) FROM customer GROUP BY NULL;
COUNT(C_NAME)
```

```

-----
          5
1 row selected.
gSQL> SELECT COUNT(c_name) FROM customer GROUP BY ();
COUNT(C_NAME)
-----
          5
1 row selected.

```

Compatibility

Table 16-69 SQL standard compatibility

Feature ID	Description	Compatibility
T431	Extended grouping capabilities	X
T432	Nested and concatenated GROUPING SETS	X
T434	GROUP BY DISTINCT	X

For More Information

Refer to the followings.

- [having clause](#)
- [query specification](#)

having clause

Function

It specifies grouped tables having removed groups which do not satisfy <search condition>.

Syntax

```
<having clause> ::=  
    HAVING <search condition>
```

Invocation and Access Rules

Any separate access privilege is not required for a user to perform <having clause>.

Syntax Rules and Parameters

<having clause>

The columns which can be used without aggregate functions in <search condition> is only the columns specified in <group by clause>.

The columns which are not specified in <group by clause> can be specified by using aggregate functions.

Description

<having clause>

<having clause> specifies search conditions for the grouped data. Generally, it is used together with <group by clause>. When <having clause> is used without <group by clause>, it is considered as if "GROUP BY ()" exists.

Other columns can not be specified alone in <having clause> but only the columns specified in <group by clause> can be specified. Other columns can be used only when using aggregate functions.

Example

The following is an example of SELECT statement which uses <having clause>.

```

gSQL> SELECT c_nation, COUNT(c_name) FROM customer GROUP BY c_nation HAVING COUNT(c_name) > 1;
C_NATION COUNT(C_NAME)
-----
KOREA          2
1 row selected.
gSQL> SELECT COUNT(c_name) FROM customer HAVING COUNT(c_name) > 1;
COUNT(C_NAME)
-----
5
1 row selected.

```

Compatibility

Table 16-70 SQL standard compatibility

Feature ID	Description	Compatibility
T301	Functional dependencies	O

For More Information

Refer to the followings.

- **group by clause**
- **Conditions**

order by clause

Function

It specifies the sorting order of the query results.

Syntax

```

<order by clause> ::=
    ORDER BY <sort specification list>
<sort specification list> ::=
    <sort specification> [ { <comma> <sort specification> }... ]
<sort specification> ::=
    <sort key> [ <ordering specification> ] [ <null ordering> ]
<sort key> ::=
    <value expression>
<ordering specification> ::=
    ASC
    | DESC
<null ordering> ::=
    NULLS FIRST
    | NULLS LAST

```

Invocation and Access Rules

The access privilege for a column is required if the column exist in a sort key specified for sorting.

Syntax Rules and Parameters

<order by clause>

- When the column not used in <select list> of <query specification> is used as <sort key>, <set quantifier> DISTINCT or one or more <set function specification> can not be specified.
- However, the specified DISTINCT clause can be omitted in the followings, so the constraint above is not applied to them.
 - When <group by clause> or <having clause> is not specified, and one or more <set function specification> are specified.
 - When one or more nested <set function specification> are specified.
- If <order by clause> is specified in <set operator>, <sort key> is analysed based on the firstly specified <query specification>.

⟨sort specification list⟩

If ⟨ordering specification⟩ is not specified, the default value is ASC.

If ⟨null ordering⟩ is not specified, the default value is NULLS LAST.

⟨sort key⟩

- If ⟨value expression⟩ of ⟨sort key⟩ is the positive integer value whose scale is zero, the value is used as a sort key index.
 - The i-th ⟨select sublist⟩ of ⟨query specification⟩ which corresponds to the value is used as a sort key.
 - If the i-th ⟨select sublist⟩ of ⟨query specification⟩ which corresponds to the value does not exist, it returns an error.
- A row subquery or relation subquery is not supported as ⟨value expression⟩.
- Other ⟨value expression⟩ are used as sort keys.

Description

⟨order by clause⟩

⟨order by clause⟩ specifies a method to sort the query results. ⟨sort key⟩ can be listed in ⟨order by clause⟩ by using a comma (,), and ⟨sort key⟩ of each records are compared and listed in order.

⟨ordering specification⟩ can specify a sorting by an ascending or by a descending order in ⟨sort key⟩. If it is omitted, it is regarded as a sorting by an ascending order.

Also, ⟨null ordering⟩ specifies an order between the non-NULL values and NULL values in ⟨sort key⟩. If it is omitted, it is regarded as NULLS LAST.

If a constant value is specified in ⟨sort key⟩, the expression positioned in the location corresponding to its value in ⟨select list⟩ is regarded as ⟨sort key⟩. In this case, the constant value should be equal to or smaller than the total number of expression in ⟨select list⟩, and its scale should be 0.

LONG type can not be specified in ⟨sort key⟩.

Comparison of Null Value

- The comparison between null values is regarded as the same value.
- The comparison between non-null value and null value is subject to the following rules.
 - When it is NULLS FIRST and ASC: null value < not null value
 - When it is NULLS LAST and ASC: null value > not null value
 - When it is NULLS FIRST and DESC: null value > not null value
 - When it is NULLS LAST and DESC: null value < not null value
- If the comparison result between null values is UNKNOWN, it is sorted according to the scan order.

Sorting Rows Which Have Same Sort Key Value

Peers are rows which can not be distinguished by a sort key, and the peers are sorted according to the scan order.

⟨aggregation function⟩ Which Is Used As ⟨sort key⟩

If ⟨aggregation function⟩ is used in ⟨query specification⟩, or ⟨group by clause⟩ is specified, ⟨aggregation function⟩ can be used as ⟨sort key⟩. However, the nested aggregation function can be used as ⟨sort key⟩ only when ⟨group by clause⟩ is specified.

Example

The following is an example of SELECT statement which uses ORDER BY clause.

```
gSQL> SELECT c_name, c_nation FROM customer ORDER BY c_nation;
C_NAME      C_NATION
-----
Customer#2  CANADA
Customer#4  GERMANY
Customer#1  KOREA
Customer#3  KOREA
Customer#5  UNITED STATES
5 rows selected.
gSQL> SELECT c_name, c_nation FROM customer ORDER BY c_nation DESC;
C_NAME      C_NATION
-----
Customer#5  UNITED STATES
Customer#1  KOREA
Customer#3  KOREA
Customer#4  GERMANY
Customer#2  CANADA
5 rows selected.
gSQL> SELECT c_name, c_nation FROM customer ORDER BY 2 DESC;
C_NAME      C_NATION
-----
Customer#5  UNITED STATES
Customer#1  KOREA
Customer#3  KOREA
Customer#4  GERMANY
Customer#2  CANADA
```

5 rows selected.

Compatibility

⟨order by clause⟩ has the following differences compared to the SQL standard.

- The SQL standard supports only ⟨column reference⟩ as ⟨value expression⟩ of ⟨sort key⟩.
- The SQL standard does not use ⟨value expression⟩ of ⟨sort key⟩ as a sort key index.

Table 16-71 SQL standard compatibility

Feature ID	Description	Compatibility
F850	Top-level ⟨order by clause⟩ in ⟨query expression⟩	X
F851	⟨order by clause⟩ in subqueries	O
F852	Top-level ⟨order by clause⟩ in views	O
F855	Nested ⟨order by clause⟩ in ⟨query expression⟩	O

For More Information

Refer to **query expression**.

offset limit clause

Function

It specifies the number of rows to skip and the number of rows to fetch from the query results.

Syntax

```

<offset limit clause> ::=
    <result offset clause>
    | <fetch limit clause>
    | <result offset clause> <fetch limit clause>
<result offset clause> ::=
    OFFSET <offset row count> [ { ROW | ROWS } ]
<fetch limit clause> ::=
    <fetch first clause>
    | <limit clause>
<fetch first clause> ::=
    FETCH [ FIRST | NEXT ] [ <fetch row count> ] [ ROW ONLY | ROWS ONLY ]
<limit clause> ::=
    LIMIT { <fetch row count> | <offset row count> , <fetch row count> | ALL }

```

Invocation and Access Rules

The access privilege for <offset limit clause> is not required.

Syntax Rules and Parameters

<result offset clause>

- <offset row count> value should be a positive integer which is equal to or bigger than zero.
- ROW and ROWS are keywords with the same meaning and they can be omitted.
- If the statement is omitted, it means as same as *OFFSET 0 ROWS*.

<fetch limit clause>

- It specifies the number of rows to skip in the query result.
- If the statement is omitted, it means as same as *LIMIT ALL*.

<fetch first clause>

- It specifies the number of rows to fetch from the query result.
- It can not be used together with <limit clause>.
- FIRST and NEXT are keywords with the same meaning and they can be omitted.
- The value of <fetch row count> should be a positive integer which is bigger than zero.
- ROW ONLY and ROWS ONLY are keywords with the same meaning and they can be omitted.
- <fetch row count> can be omitted and if it is omitted, its value is one.

<limit clause>

- It specifies the number of rows to fetch or, it specifies the number of rows to fetch and the number of rows to be skipped in query results together.
- It can not be used together with <fetch first clause>.
- When it is used as LIMIT <fetch row count>
 - <fetch row count> should be a positive integer which is bigger than zero.
 - The statement means as same as *FETCH FIRST <fetch row count> ROWS ONLY*.
- When it is used as LIMIT <offset row count>, <fetch row count>
 - It can not be used together with <result offset clause>.
 - <offset row count> should be a positive integer which is equal to or bigger than zero.
 - <fetch row count> should be a positive integer which is bigger than zero.
 - The statement means as same as *OFFSET <offset row count> ROWS FETCH FIRST <fetch row count> ROWS ONLY*.
- When it is used as LIMIT ALL
 - It does not limit the number of rows to fetch.

Description

<result offset clause>

It returns rows starting from the <offset row count> th of the query results to a user. If <offset row count> is equal to or greater than the number of rows of query results, the returned result to a user is zero.

<fetch first clause>

It returns the query results to a user as many as the number of <fetch row count>.

<limit clause>

When it is used as LIMIT <fetch_row_count>, it returns the query results to a user as many as the number of <fetch row count>.

When it is used as LIMIT <offset row count>, <fetch row count>, it returns the query results to a user as m

any as the number of <fetch row count> from the <offset row count>th row.

When it is used as LIMIT ALL, it returns the query results to a user without limit of the number.

Examples

The following is an example of SELECT statement which uses <result offset clause>.

```
gSQL> SELECT c_name, c_nation FROM customer OFFSET 1;
C_NAME      C_NATION
-----
Customer#2  CANADA
Customer#3  KOREA
Customer#4  GERMANY
Customer#5  UNITED STATES
4 rows selected.
```

The following is an example of SELECT statement which uses <fetch first clause>.

```
gSQL> SELECT c_name, c_nation FROM customer FETCH FIRST ROW ONLY;
C_NAME      C_NATION
-----
Customer#1  KOREA
1 row selected.
gSQL> SELECT c_name, c_nation FROM customer FETCH FIRST 2 ROW ONLY;
C_NAME      C_NATION
-----
Customer#1  KOREA
Customer#2  CANADA
2 rows selected.
```

The following is an example of SELECT statement which uses <limit clause>.

```
gSQL> SELECT c_name, c_nation FROM customer LIMIT 1;
C_NAME      C_NATION
-----
Customer#1  KOREA
1 row selected.
gSQL> SELECT c_name, c_nation FROM customer LIMIT 1, 2;
C_NAME      C_NATION
-----
Customer#2  CANADA
```

```

Customer#3 KOREA
2 rows selected.
gSQL> SELECT c_name, c_nation FROM customer LIMIT ALL;
C_NAME      C_NATION
-----
Customer#1 KOREA
Customer#2 CANADA
Customer#3 KOREA
Customer#4 GERMANY
Customer#5 UNITED STATES
5 rows selected.

```

The following is an example of SELECT statement which uses <result offset clause> and <fetch limit clause>

```

gSQL> SELECT c_name, c_nation FROM customer OFFSET 1 FETCH 2;
C_NAME      C_NATION
-----
Customer#2 CANADA
Customer#3 KOREA
2 rows selected.
gSQL> SELECT c_name, c_nation FROM customer OFFSET 1 LIMIT 2;
C_NAME      C_NATION
-----
Customer#2 CANADA
Customer#3 KOREA
2 rows selected.

```

Compatibility

The SQL standard has the following differences compared to GOLDILOCKS.

- ROW or ROWS can not be omitted.
- FIRST or NEXT can not be omitted.
- It supports <fetch first percentage> in <fetch first clause>.
 - <simple value specification> can be any numeric in <fetch first percentage>. (In other words, a number below decimal point is also allowed.)
 - When <fetch first percentage> is specified, the value is converted to <fetch row count>. The conversion formula is as follows.
 - $FRC = CEILING(FFP * LOCT / 100.0E0)$
 - FFP: The value of <simple value specification>
 - LOCT: The number of rows in the query results

- FRC: The value which is converted to <fetch row count>
- It supports WITH TIES in <fetch first clause>
 - When using <fetch first clause> which specified WITH TIES, <order by clause> should exist.
 - When WITH TIES is specified, a sort key of <order by clause> returns the peers as many as the number of <fetch row count> based on the peers. The peers are units of rows whose sort keys are same.



OFFSET and LIMIT syntax

- The SQL standard defines OFFSET .. FETCH {FIRST|NEXT} ... syntax.
- IBM DB2 and Postgres provide the same syntax as the SQL standard.
- Postgres and MySQL provide OFFSET .. LIMIT syntax.
- Oracle performs a similar function through ROWNUM column.

Table 16-72 SQL standard compatibility

Feature ID	Description	Compatibility
F861	Top-level <result offset clause> in <query expression>	O
F862	<result offset clause> in subqueries	O
F863	Nested <result offset clause> in <query expression>	O
F864	Top-level <result offset clause> in views	O
F865	dynamic <offset row count> in <result offset clause>	X

set operator

Function

It performs a set operation for results of the subquery.

Syntax

```

<set operator> ::=
    <set operator term>
  | <query expression body> UNION [ ALL | DISTINCT ] <set operator term>
  | <query expression body> EXCEPT [ ALL | DISTINCT ] <set operator term>
  | <query expression body> MINUS [ ALL | DISTINCT ] <set operator term>
<set operator term> ::=
    <query term>
  | <set operator term> INTERSECT [ ALL | DISTINCT ] <set operator term>

```

Invocation and Access Rules

All access privileges for the <query expression> in each <set operator term> are required for using <set operator> statement.

Syntax Rules and Parameters

<set operator>

- It specifies the set operations among the subqueries.
- The number of the target in <select list> of each subquery should be same, and all matched targets should belong to the same data type group.
- The representative name of the result target of <set operator> is the target name of <select list> of the first subquery.
- If the processing order is not explicitly specified by using parentheses it processes by evaluating specified subqueries from the left to the the right.
- The meaning of each operator in <set operator> is as follows.
 - UNION
 - UNION ALL: It is a union of all subquery results without removing the duplicates.
 - UNION DISTINCT: It is a union of all subquery results, which removed the duplicates.
 - If at least one of ALL and DISTINCT is not specified, it is operated as same as when DISTINCT is specified.
 - EXCEPT

- EXCEPT ALL: It returns the difference of all rows for the subquery result including all duplicates.
- EXCEPT DISTINCT: It returns the difference of all rows for the subquery result excluding all duplicates.
- If at least one of ALL and DISTINCT is not specified, it is operated as same as when DISTINCT is specified.
- MINUS
 - It is an alias of EXCEPT and, it is operated as same as EXCEPT.
- INTERSECT
 - INTERSECT ALL: It is a intersection of all subquery results without removing the duplicates.
 - INTERSECT DISTINCT: It is a intersection of all subquery results, which removed the duplicates.
 - If at least one of ALL and DISTINCT is not specified, it is operated as same as when DISTINCT is specified.

⟨query term⟩

It specifies the single subquery.

For more information, refer to **query expression**.

Description

The Differences between ALL and DISTINCT in ⟨set operator⟩

For example, if the data of the table R1 and R2 is given as follows, the result of each ⟨set operator⟩ is as follows.

- TABLE data
 - R1 TABLE = {1, 1, 1, 2, 2, 2, 3, 4, 4, 5}
 - R2 TABLE = {1, 1, 3, 3, 4}
- SELECT * FROM R1 UNION ALL SELECT * FROM R2;
 - result = {1, 1, 1, 1, 1, 2, 2, 2, 3, 3, 3, 4, 4, 4, 5}
- SELECT * FROM R1 UNION DISTINCT SELECT * FROM R2;
 - result = {1, 2, 3, 4, 5}
- SELECT * FROM R1 MINUS ALL SELECT * FROM R2;
 - result = {1, 2, 2, 2, 4, 5}
- SELECT * FROM R1 MINUS DISTINCT SELECT * FROM R2;
 - result = {2, 5}
- SELECT * FROM R1 INTERSECT ALL SELECT * FROM R2;
 - result = {1, 1, 3, 4}
- SELECT * FROM R1 INTERSECT DISTINCT SELECT * FROM R2;
 - result = {1, 3, 4}

Figure 2 SET operation results

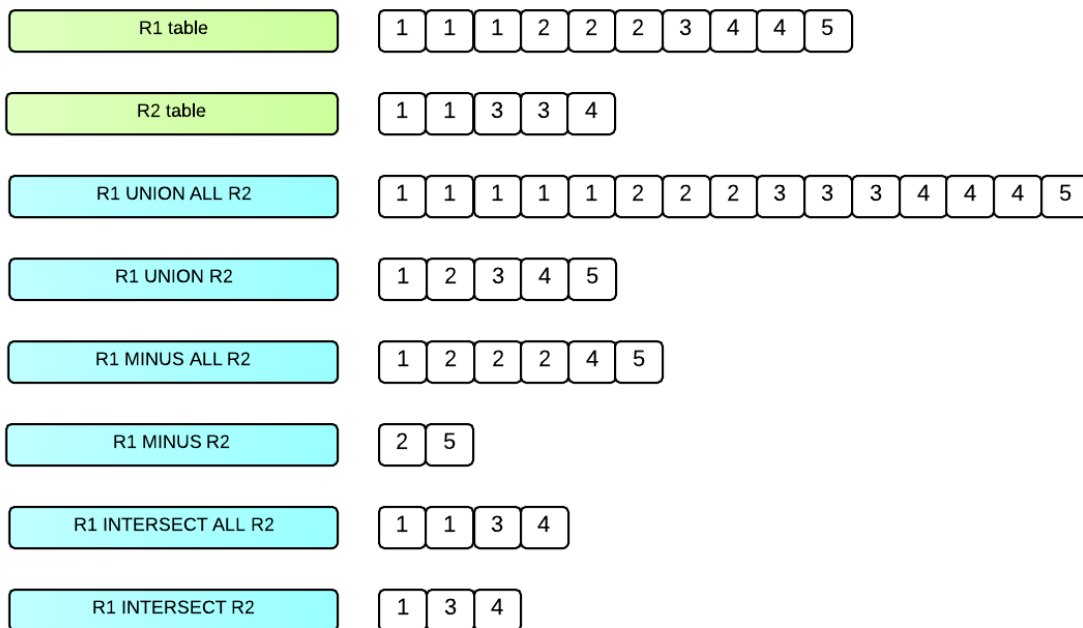

Operator Precedence

The operator precedence of <set operator> is as follows.

- Parentheses () has a priority.
- INTERSECT has a priority.
- For UNION and EXCEPT, the precedence is according to an order listed from left to right within an expression.

The Result Type of <set operator>

The i-th column of all subqueries in <set operator> should be a data type of the same family, and its result type is determined by **Result Type Combination Rule**.

However, LONG VARCHAR and LONG VARBINARY types can only use UNION ALL.

ORDER BY Clause

When <set operator> is used together with ORDER BY, and the column names are different among subqueries, then it can be used as follows.

- ORDER BY indicator
 - It specifies the order of result columns.

```
SELECT c1 FROM t1
UNION ALL
```

```
SELECT c2 FROM t2
ORDER BY 1;
```

- ORDER BY left_column_name
 - It specifies the column name of the first subquery.

```
SELECT c1 FROM t1
UNION ALL
SELECT c2 FROM t2
ORDER BY c1;
```

Examples

The following is an example of SELECT statement which uses UNION operator.

```
gSQL> SELECT s_nation nation FROM supplier UNION ALL SELECT c_nation FROM customer;
NATION
-----
FRANCE
KOREA
GERMANY
UNITED STATES
CANADA
KOREA
CANADA
KOREA
GERMANY
UNITED STATES
10 rows selected.
gSQL> SELECT s_nation nation FROM supplier UNION DISTINCT SELECT c_nation FROM customer;
NATION
-----
UNITED STATES
CANADA
KOREA
GERMANY
FRANCE
5 rows selected.
```

The following is an example of SELECT statement which uses EXCEPT operator.

```
gSQL> SELECT c_nation nation FROM customer EXCEPT ALL SELECT s_nation FROM supplier;
NATION
```

```
-----
```

```
KOREA
```

```
1 row selected.
```

```
gSQL> SELECT c_nation nation FROM customer EXCEPT DISTINCT SELECT s_nation FROM supplier;
```

```
no rows selected.
```

The following is an example of SELECT statement which uses INTERSECT operator.

```
gSQL> SELECT c_nation nation FROM customer INTERSECT ALL SELECT s_nation FROM supplier;
```

```
NATION
```

```
-----
```

```
UNITED STATES
```

```
CANADA
```

```
KOREA
```

```
GERMANY
```

```
4 rows selected.
```

```
gSQL> SELECT c_nation nation FROM customer INTERSECT DISTINCT SELECT s_nation FROM supplier;
```

```
NATION
```

```
-----
```

```
UNITED STATES
```

```
CANADA
```

```
KOREA
```

```
GERMANY
```

```
4 rows selected.
```

Compatibility

<set operator> has the following differences compared to the SQL standard.

- The SQL standard does not support MINUS.
- In the SQL standard, <set operator> can not be used together with ORDER BY indicator.
- In the SQL standard, if ORDER BY column_name is used together with <set operator>, it should be identical to the column name of all subqueries.

Table 16-73 SQL standard compatibility

Feature ID	Description	Compatibility
F302	INTERSECT table operator	O
F301	CORRESPONDING	X
T551	Optional key words for default syntax	O
F304	EXCEPT ALL table operator	O

For More Information

Refer to [query expression](#).

subquery

Function

It specifies the scalar value, row, table which are derived from `<query expression>`.

Syntax

```
<scalar subquery> ::=  
    <subquery>  
<row subquery> ::=  
    <subquery>  
<table subquery> ::=  
    <subquery>  
<subquery> ::=  
    ( <query expression> )
```

Invocation and Access Rules

The access privilege for `<query expression>` in `<subquery>` is required.

Syntax Rules and Parameters

`<scalar subquery>`

- The number of targets in `<query expression>` should be one.
- The result value according to the number of rows returned from `<query expression>` is as follows.
 - If the number of returned rows is zero, the result value is NULL.
 - If the number of returned rows is one, the result value is a value contained in the row.
 - If the number of returned rows is two or more, an exception error occurs.

`<row subquery>`

- The number of target in `<query expression>` should be two or more.
- The result value according to the number of rows returned from `<query expression>` is as follows.
 - If the number of returned rows is zero, the result value is a row all of whose columns are NULL.
 - If the number of returned rows is one, the result value is that row.
 - If the number of returned rows is two or more, an exception error occurs.

⟨table subquery⟩

- The number of target in ⟨query expression⟩ should be one or more.
- The result according to the number of rows returned from ⟨query expression⟩ is as follows.
 - If the number of returned rows is zero, the result value is *no rows*.
 - If the number of returned rows is one or more, the result value is that row.

Description

⟨scalar subquery⟩

⟨scalar subquery⟩ returns one row which has one column as a result. The target of ⟨scalar subquery⟩ should be only one, and the result data type depends on the data type of the target.

⟨scalar subquery⟩ can be used alone in the target of ⟨select list⟩, and it can be used in the operator which has a single column.

⟨row subquery⟩

⟨row subquery⟩ returns one row which has two or more columns as a result. The targets of ⟨row subquery⟩ should be two or more, and the result data type depends on the data type of each target.

⟨row subquery⟩ can not be used alone in the target of ⟨select list⟩, and it can only be used in the row operator which has two or more columns.

⟨table subquery⟩

⟨table subquery⟩ returns one or more rows which have one or more columns as a result. The targets of ⟨table subquery⟩ should be one or more, and the result data type depends on the data type of each target.

⟨table subquery⟩ can not be used alone in the target of ⟨select list⟩, but it can be used in the operators such as IN, NOT IN, EXISTS, NOT EXISTS, quantify operator.

Examples

The following is an example of SELECT statement which uses ⟨scalar subquery⟩.

```
gSQL> SELECT (SELECT c_name FROM dual) FROM customer;
(SELECT C_NAME FROM DUAL)
-----
Customer#1
Customer#2
Customer#3
Customer#4
```

```

Customer#5
5 rows selected.
gSQL> SELECT c_name, c_nation FROM customer WHERE c_nation = (SELECT 'CANADA' FROM dual);
C_NAME      C_NATION
-----
Customer#2 CANADA
1 row selected.

```

The following is an example of SELECT statement which uses <row subquery>.

```

gSQL> SELECT p_name, p_brand, p_type FROM part WHERE (p_brand, p_type) = (SELECT 'Brand#1',
'NICKEL' FROM dual);
P_NAME P_BRAND  P_TYPE
-----
Part#2 Brand#1  NICKEL
1 row selected.

```

The following is an example of SELECT statement which uses <table subquery>.

```

gSQL> SELECT s_name, s_nation FROM supplier WHERE s_nation IN (SELECT c_nation FROM customer);
S_NAME      S_NATION
-----
Supplier#2   KOREA
Supplier#3   GERMANY
Supplier#4   UNITED STATES
Supplier#5   CANADA
4 rows selected.
gSQL> SELECT * FROM (SELECT s_name, s_nation FROM supplier);
S_NAME      S_NATION
-----
Supplier#1   FRANCE
Supplier#2   KOREA
Supplier#3   GERMANY
Supplier#4   UNITED STATES
Supplier#5   CANADA
5 rows selected.

```

Compatibility

Table 16-74 SQL standard compatibility

Feature ID	Description	Compatibility
F471	Scalar subquery values	O
F641	Row and table constructors	X
T501	Enhanced EXISTS predicate	O
E061-11	Subqueries in IN predicate	O
E061-12	Subqueries in quantified comparison predicate	O
E061-12	Correlated subqueries	O

For More Information

Refer to the followings.

- **from clause**
- **where clause**

hint clause

Function

It specifies a hint to be used for a query execution.

Syntax

```

<hint clause> ::=
    /*+ <hint element> [ comment ] [ [ , ] <hint element> [ comment ] ] */
<hint element> ::=
    <access path hints>
  | <join order hints>
  | <join operation hints>
  | <query transformation hints>
  | <other hints>
<access_path_hints> ::=
    FULL( table_name )
  | INDEX( table_name [ , ] [ index_name [ [ , ] index_name ] ] )
  | NO_INDEX( table_name [ , ] [ index_name [ [ , ] index_name ] ] )
  | INDEX_ASC( table_name [ , ] [ index_name [ [ , ] index_name ] ] )
  | INDEX_DESC( table_name [ , ] [ index_name [ [ , ] index_name ] ] )
  | INDEX_COMBINE( table_name [ , ] [ index_name [ [ , ] index_name ] ] )
  | ROWID( table_name )
<join order hints> ::=
    ORDERED
  | ORDERING( table_name [ LEFT | RIGHT ] [ , table_name [ LEFT | RIGHT ] ] )
  | LEADING( table_name [ [ , ] table_name ] )
<join operation hints> ::=
    USE_HASH( table_name [ [ , ] table_name ] )
  | NO_USE_HASH( table_name [ [ , ] table_name ] )
  | USE_MERGE( table_name [ [ , ] table_name ] )
  | NO_USE_MERGE( table_name [ [ , ] table_name ] )
  | USE_NL( table_name [ [ , ] table_name ] )
  | NO_USE_NL( table_name [ [ , ] table_name ] )
  | USE_INL( table_name [ [ , ] table_name ] )
  | NO_USE_INL( table_name [ [ , ] table_name ] )
<query transformation hints> ::=
    UNNEST
  | NO_UNNEST

```

```

| NL_SJ
| NL_ISJ
| MERGE_SJ
| HASH_SJ
| HASH_ISJ
| HASH_AJ
| TRANSITIVE_CLOSURE
| NO_TRANSITIVE_CLOSURE
| MERGE( view_name )
| NO_MERGE( view_name )
| NO_QUERY_TRANSFORMATION
<other hints> ::=
    PUSH_SUBQ
| NO_PUSH_SUBQ

```

Invocation and Access Rules

The privilege for query execution is required to perform <hint clause>.

Syntax Rules and Parameters

The basic syntax rules for <hint clause> are as follows.

- <hint clause> can be specify multiple <hint element> by using a space or ','.
- If two or more <hint element> for the same object exist and they are not applicable simultaneously, only the firstly specified <hint element> is applied.
- When a syntax error occurs for <hint element>, it is ignored by default. If "hint_error" property is set to *on*, <hint clause> is treated as a validation error.
- When a table name is specified in <hint clause>, it should be identical to one of the table names (or the alias name if an alias name is specified in the table) in <from clause>.
- The table name can not be specified together with a schema name.
- Even when <hint element> is correctly specified, if it is not applicable, the optimizer ignores the <hint element>.

<access_path_hints>

FULL

It instructs an optimizer to perform table full scan for the specified table. When this hint is specified, the optimizer does not take into account the optimization which uses the index scan, rowid scan, index combine.

When specifying FULL hint, the table name is required, and only a single table name should be specified.

The specified table name should exist in <from clause>.

The following is an example of applying a hint to perform table full scan for the table T1.

- Type 1: The table name is specified in <from clause>.

```
SELECT /*+ FULL(T1) */ I1
  FROM T1;
```

- Type 2: The alias name is specified in <from clause>.

```
SELECT /*+ FULL(T1_ALIAS) */ I1
  FROM T1 T1_ALIAS;
```

INDEX

It instructs an optimizer to perform index scan for the specified table. When this hint is specified, the optimizer does not take into account the optimization which uses the table scan, index scan by another index, rowid scan, index combine.

When specifying INDEX hint, the table name should exist in <from clause>, and the index name should be the name of an index which exists in the table.

One or more index names can be specified or an index name can be omitted. If the index name is omitted, all indexes in the table are targeted.

If two or more index names are specified or an index name for the table with two or more indexes is omitted, an optimizer calculates scan cost of each index and selects the best index scan method.

The following is an example of applying a hint to perform index scan for the table T1.

- Type 1: Only one index name is specified.

```
SELECT /*+ INDEX(T1, T1_PK_INDEX) */ I1
  FROM T1;
```

- Type 2: Two or more index names are specified.

```
SELECT /*+ INDEX(T1, T1_PK_INDEX T1_UNIQUE_INDEX) */ I1
  FROM T1;
```

- Type 3: The index name is omitted.

```
SELECT /*+ INDEX(T1) */ I1
  FROM T1;
```

NO_INDEX

It instructs an optimizer not to perform index scan for indexes corresponding to the index name in the specified table. When this hint is specified, the optimizer does not take into account the optimization which uses the index scan for the specified indexes in the table.

When specifying NO_INDEX hint, the table name should exist in <from clause>, and the index name should be the name of an index which exists in the table.

One or more index names can be specified or an index name can be omitted. If the index name is omitted, an optimizer does not take into account the index scan for the table.

If indexes which are not specified in NO_INDEX hint exist, an optimizer calculates index scan cost for the indexes and selects the best scan method including table scan cost and rowid scan cost.

The following is an example of applying NO_INDEX hint to the table T1.

- Type 1: Only one index name is specified.

```
SELECT /*+ NO_INDEX(T1, T1_PK_INDEX) */ I1
FROM T1;
```

- Type 2: Two or more index names are specified.

```
SELECT /*+ NO_INDEX(T1, T1_PK_INDEX T1_UNIQUE_INDEX) */ I1
FROM T1;
```

- Type 3: The index name is omitted.

```
SELECT /*+ NO_INDEX(T1) */ I1
FROM T1;
```

INDEX_ASC

It instructs an optimizer to perform ascending index scan for the specified table. When this hint is specified, the optimizer does not take into account the optimization which uses the table scan, index scan by another index, rowid scan, index combine.

If the index of the selected index scan consists of ascending (descending) order, it scans the index in ascending (descending) order.

The syntax rule for INDEX_ASC hint is as same as the syntax rule for INDEX hint.

INDEX_DESC

It instructs an optimizer to perform descending index scan for the specified table. When this hint is specified, the optimizer does not take into account the optimization which uses the table scan, index scan by another index, rowid scan, index combine.

If the index of the selected index scan consists of ascending (descending) order, it scans the index in ascending (descending) order.

The syntax rule for INDEX_DESC hint is as same as the syntax rule for INDEX hint.

INDEX_COMBINE

It instructs an optimizer to separate OR statements and perform index scan for the specified table then to combine the results. When this hint is specified, the optimizer firstly takes into account the optimization which uses the index combine. If index combine is not available, it calculates the cost of table scan, index scan or rowid scan, and selects the best scan method.

When specifying INDEX_COMBINE hint, the table name should exist in <from clause>, and the index name should be the name of an index which exists in the table.

One or more index names can be specified or an index name can be omitted. If the index name is omitted, all indexes in the table are targeted.

OR statements should exist in the condition to scan the table to perform INDEX_COMBINE hint. If OR statement does not exist, an optimizer ignores the hint and it calculates the cost of the table scan, index scan or rowid scan, and chooses the best scan method.

If two or more index names are specified or an index name for the table with two or more indexes is omitted, an optimizer calculates index scan cost of each index in each OR statement, then selects the best index scan method. Therefore, it can select an index scan which uses each different index for conditions separated by OR statements.

The following is an example of applying a hint to perform the index combine for the table T1.

- Type 1: Only one index name is specified.

```
SELECT /*+ INDEX_COMBINE(T1, T1_PK_INDEX) */ I1
  FROM T1
 WHERE I1 = 1
        OR I1 = 2;
```

- Type 2: Two or more index names are specified.

```
SELECT /*+ INDEX_COMBINE(T1, T1_PK_INDEX T1_UNIQUE_INDEX) */ I1
  FROM T1
 WHERE I1 = 1
        OR I2 = 2;
```

- Type 3: The index name is omitted.

```
SELECT /*+ INDEX_COMBINE(T1) */ I1
  FROM T1
 WHERE I1 = 1
        OR I2 = 2;
```

- Type 4: INDEX_COMBINE hint is not applicable. (An OR statement does not exist.)

```
SELECT /*+ INDEX_COMBINE(T1, T1_PK_INDEX) */ I1
  FROM T1
 WHERE I1 = 1;
```

ROWID

It instructs an optimizer to perform rowid scan for the specified table. When this hint is specified, the optimizer takes into account the optimization which uses the rowid scan firstly. If rowid scan is not available, it calculates the cost of table scan, index scan, index combine, and selects the best index scan method.

When specifying ROWID hint, the table name is required, and only a single table name should be specified. The specified table name should exist in <from clause>.

To perform ROWID hint, EQUAL condition using ROWID should exist in the condition to scan the table. If the EQUAL condition does not exist, an optimizer ignores the hint and it calculates the cost of table scan, index scan, index combine, and selects the best scan method.

The following is an example of applying a hint to perform ROWID scan for the table T1.

- Type 1: The table name is specified in <from clause>.

```
SELECT /*+ ROWID(T1) */ I1
  FROM T1
 WHERE ROWID = 'AAAAAAAAADXAACAAAGA1AAA';
```

- Type 2: The alias name is specified in <from clause>.

```
SELECT /*+ ROWID(T1_ALIAS) */ I1
  FROM T1 T1_ALIAS
 WHERE ROWID = 'AAAAAAAAADXAACAAAGA1AAA';
```

- Type 3: ROWID hint is not applicable. (A rowid condition does not exist.)

```
SELECT /*+ ROWID(T1) */ I1
  FROM T1
 WHERE I1 = 1;
```

<join_order_hints>

ORDERED

It instructs an optimizer to perform join in an order specified in <from clause> for the tables. This hint is applicable only when tables which are separated by ',' are specified in <from clause> or the tables are specified by inner join.

The following is an example of applying ORDERED hint for joining the tables T1 and T2.

- Type 1: The tables separated by ',' are specified in <from clause>.

```
SELECT /*+ ORDERED */ *
  FROM T1, T2
 WHERE T1.I1 = T2.I1;
```

- Type 2: The tables are specified as inner join in <from clause>.

```
SELECT /*+ ORDERED */ *
  FROM T1 INNER JOIN T2 ON T1.I1 = T2.I1;
```

- Type 3: ORDERED hint is not applicable. (It is outer join.)

```
SELECT /*+ ORDERED */ *
  FROM T1 LEFT OUTER JOIN T2 ON T1.I1 = T2.I1;
```

ORDERING

It instructs an optimizer to perform join in an order of specified tables in this hint. This hint is applicable only when tables which are separated by ',' are specified in <from clause> or the tables are specified by inner join.

ORDERING hint can specify a positioning option for each table. The positioning option can not be specified for the first and second tables but it can be specified since the third table. The position for the first and second tables can be specified according to the order specified in the ORDERING hint.

The positioning options are LEFT or RIGHT. LEFT locates a table to the left node (outer node) of join, and RIGHT locates a table to the right node (inner node) of join.

When the positioning option is specified in the table, the table executes join at the fixed position specified by the option. When the positioning option is not specified in the table, the optimizer calculates cost of positioning the table in the left node(outer node) and right node(inner node), and selects the best join order.

The following is an example of applying ORDERING hint for joining the tables T1, T2, T3.

- Type 1: The tables separated by ',' are specified in <from clause>.

```
SELECT /*+ ORDERING(T2, T3, T1) */ *
  FROM T1, T2, T3
 WHERE T1.I1 = T2.I1
       AND T2.I2 = T3.I2;
```

- Type 2: The tables are specified as inner join in <from clause>.

```
SELECT /*+ ORDERING(T2, T3, T1) */ *
  FROM (T1 INNER JOIN T2 ON T1.I1 = T2.I1) INNER JOIN T3 ON T2.I2 = T3.I2;
```

- Type 3: The positioning option is specified in ORDERING hint.

```
SELECT /*+ ORDERING(T2, T3, T1 LEFT) */ *
  FROM T1, T2, T3
 WHERE T1.I1 = T2.I1
       AND T2.I2 = T3.I2;
```

- Type 4: ORDERING hint is not applicable. (It is outer join.)

```
SELECT /*+ ORDERING(T1, T2) */ *
  FROM T1 LEFT OUTER JOIN T2 ON T1.I1 = T2.I1;
```

- Type 5: The positioning option is misused in the ORDERING hint. (It is used in the first table.)

```
SELECT /*+ ORDERING(T2 RIGHT, T3, T1) */ *
  FROM T1, T2, T3
 WHERE T1.I1 = T2.I1
       AND T2.I2 = T3.I2;
```

LEADING

It instructs an optimizer to perform join in an order of specified tables in this hint. This hint is applicable only when tables which are separated by ',' are specified in <from clause> or the tables are specified by inner join.

LEADING hint can not specify the position, unlike ORDERING hint, but it can specify the order of the table participating in join operation. Therefore, the first and second table is determined to be placed in the left node (outer node) and the right node (inner node) each according to the order.

From the third table, the optimizer calculates cost of positioning the table in the left node (outer node) and right node(inner node), and selects a better position.

The following is an example of applying LEADING hint to join the tables T1, T2, T3.

- Type 1: The tables separated by ',' are specified in <from clause>.

```
SELECT /*+ LEADING(T2, T3, T1) */ *
  FROM T1, T2, T3
 WHERE T1.I1 = T2.I1
        AND T2.I2 = T3.I2;
```

- Type 2: The tables are specified as inner join in <from clause>.

```
SELECT /*+ LEADING(T2, T3, T1) */ *
  FROM (T1 INNER JOIN T2 ON T1.I1 = T2.I1) INNER JOIN T3 ON T2.I2 = T3.I2;
```

- Type 3: LEADING hint is not applicable. (It is outer join.)

```
SELECT /*+ LEADING(T1, T2) */ *
  FROM T1 LEFT OUTER JOIN T2 ON T1.I1 = T2.I1;
```

<join operation_hints>

USE_HASH

It instructs an optimizer to perform join by using the hash join method if the table specified in this hint is included when performing join. This hint is applicable to all join types.

USE_HASH hint should specify one or more tables, and it can not specify identical tables more than two. The tables specified in USE_HASH hint are not allowed to be specified in USE_MERGE, USE_NL, USE_INL. When it is specified, if "hint_error" property is set to *on*, it is treated as a validation error. If "hint_error" property is set to *off* the firstly specified hint is applied.

Also, if each different join operation hints are specified for two tables participating in join, the hint specified in the left node(outer node) is firstly applied.

When the table specified in USE_HASH hint participates in join, the condition which can hash join should exist in join condition. (The column should be comparable and it should be equi-join) If the condition does not exist, an optimizer ignores the hint and selects the best join operation according to the cost calculation.

The following is an example of applying USE_HASH hint to join the tables T1, T2.

- Type 1: The join operation hint is specified only for a single table.

```
SELECT /*+ USE_HASH(T1) */ *
  FROM T1, T2
 WHERE T1.I1 = T2.I1;
```

- Type 2: Each different join operation hints are specified for two tables. (The order is determined according to ORDERED hint, and the join operation hint (USE_HASH) for

the table T1 in the left node (outer node) is applied.)

```
SELECT /*+ ORDERED USE_HASH(T1) USE_MERGE(T2) */ *
  FROM T1, T2
 WHERE T1.I1 = T2.I1;
```

- Type 3: USE_HASH hint is not applicable. (A hash join condition does not exist.)

```
SELECT /*+ USE_HASH(T1, T2) */ *
  FROM T1, T2
 WHERE T1.I1 < T2.I1;
```

NO_USE_HASH

It instructs an optimizer to perform join by selecting one of the methods except for the hash join method if the table specified in this hint is included when performing join. This hint is applicable to all join types.

NO_USE_HASH hint should specify one or more tables, and it can not specify identical tables more than two. The tables specified in NO_USE_HASH hint are allowed to be specified in any other join operation hint except for USE_HASH hint.

When the table specified in this hint is specified in USE_HASH hint, if "hint_error" property is set to on, it is treated as a validation error. If "hint_error" property is set to off the firstly specified hint is applied.

Also, if each different join operation hints are specified for two tables participating in join, the hint specified in the left node (outer node) is firstly applied.

When tables specified in NO_USE_HASH hint participates in join, an optimizer calculates the cost of other join operations except for hash join, and selects the best join operation.

The following is an example of applying NO_USE_HASH hint to join of the tables T1, T2.

- Type 1: The join operation hint is specified only for a single table.

```
SELECT /*+ NO_USE_HASH(T1) */ *
  FROM T1, T2
 WHERE T1.I1 = T2.I1;
```

- Type 2: Each different join operation hints are specified for two tables.
(The hint specified in table T2 is applied, so the merge join is applied.)

```
SELECT /*+ NO_USE_HASH(T1) USE_MERGE(T2) */ *
  FROM T1, T2
 WHERE T1.I1 = T2.I1;
```

USE_MERGE

It instructs an optimizer to perform join by using a merge join method if the table specified in this hint is included when performing join. This hint is applicable to all join types.

USE_MERGE hint should specify one or more tables, and it can not specify identical tables more than two. The tables specified in USE_MERGE hint are not allowed to be specified in USE_HASH, USE_NL, USE_INL. When it is specified, if "hint_error" property is set to *on*, it is treated as a validation error. If "hint_error" property is set to *off*, the firstly specified hint is applied.

Also, if each different join operation hints are specified for two tables participating in join, the hint specified in the left node(outer node) is firstly applied.

When the table specified in USE_MERGE hint participates in join, the condition which can merge join should exist in join condition. (The column should be comparable and it should be equi-join) If the condition does not exist, an optimizer ignores the hint and selects the best join operation according to the cost calculation.

The following is an example of applying USE_MERGE hint to join the tables T1, T2.

- Type 1: The join operation hint is specified only for a single table.

```
SELECT /*+ USE_MERGE(T1) */ *
  FROM T1, T2
 WHERE T1.I1 = T2.I1;
```

- Type 2: Each different join operation hints are specified for two tables.
(The order is determined according to ORDERED hint, and the join operation hint (USE_MERGE) is applied for the table T1 in the left node(outer node))

```
SELECT /*+ ORDERED USE_MERGE(T1) USE_HASH(T2) */ *
  FROM T1, T2
 WHERE T1.I1 = T2.I1;
```

- Type 3: USE_MERGE hint is not applicable. (A hash join condition does not exist.)

```
SELECT /*+ USE_MERGE(T1, T2) */ *
  FROM T1, T2
 WHERE T1.I1 < T2.I1;
```

NO_USE_MERGE

It instructs an optimizer to perform join by selecting one of the methods except for the merge join method if the table specified in this hint is included when performing join. This hint is applicable to all join types.

NO_USE_MERGE hint should specify one or more tables, and it can not specify identical tables more than two. The tables specified in NO_USE_MERGE hint are allowed to be specified in any other join operation hint except for USE_MERGE hint.

When the table specified in this hint is specified in USE_MERGE hint, if "hint_error" property is set to on, it is treated as a validation error. If "hint_error" property is set to off the firstly specified hint is applied.

Also, if each different join operation hints are specified for two tables participating in join, the hint specified in the left node(outer node) is firstly applied.

When tables specified in NO_USE_MERGE hint participates in join, an optimizer calculates the cost of other join operations except for merge join, and selects the best join operation.

The following is an example of applying NO_USE_MERGE hint to join the tables T1, T2.

- Type 1: The join operation hint is specified only for a single table.

```
SELECT /*+ NO_USE_MERGE(T1) */ *
  FROM T1, T2
 WHERE T1.I1 = T2.I1;
```

- Type 2: Each different join operation hints are specified for two tables.
(The hint specified in table T2 is applied, so the hash join is applied.)

```
SELECT /*+ NO_USE_MERGE(T1) USE_HASH(T2) */ *
  FROM T1, T2
 WHERE T1.I1 = T2.I1;
```

USE_NL

It instructs an optimizer to perform join by using a nested loops join method if the table specified in this hint is included when performing join. This hint is applicable to all join types.

USE_NL hint should specify one or more tables, and it can not specify identical tables more than two. The tables specified in USE_NL hint are not allowed to be specified in USE_HASH, USE_MERGE, USE_INL.

When it is specified, if "hint_error" property is set to on, it is treated as a validation error. If "hint_error" property is set to off the firstly specified hint is applied.

Also, if each different join operation hints are specified for two tables participating in join, the hint specified in the left node(outer node) is firstly applied.

The nested loops join, unlike the hash join and the merge join, can perform join without any constraints.

The following is an example of applying USE_NL hint to join of the tables T1, T2.

- Type 1: The join operation hint is specified only for a single table.

```
SELECT /*+ USE_NL(T1) */ *
  FROM T1, T2
 WHERE T1.I1 = T2.I1;
```

- Type 2: Each different join operation hints are specified for two tables.
(The order is determined according to ORDERED hint, and the join operation hint (USE_NL) is applied for the table T1 in the left node (outer node))

```
SELECT /*+ ORDERED USE_NL(T1) USE_HASH(T2) */ *
  FROM T1, T2
 WHERE T1.I1 = T2.I1;
```

NO_USE_NL

It instructs an optimizer to perform join by selecting one of the methods except for the nested loops join method if the table specified in this hint is included when performing join. This hint is applicable to all join types.

NO_USE_NL hint should specify one or more tables, and it can not specify identical tables more than two. The tables specified in NO_USE_NL hint are allowed to be specified in any other join operation hint except for USE_NL hint.

When the table specified in this hint is specified in USE_NL hint, if "hint_error" property is set to *on*, it is treated as a validation error. If "hint_error" property is set to *off* the firstly specified hint is applied. Also, if each different join operation hints are specified for two tables participating in join, the hint specified in the left node (outer node) is firstly applied.

When tables specified in NO_USE_NL hint participates in join, an optimizer calculates the cost of other join operations except for nested loops join, and selects the best join operation.

However, if other join operations can not be used because of constraints, the optimizer ignores the hint, and selects the nested loops join.

The following is an example of applying NO_USE_NL hint to join the tables T1, T2.

- Type 1: The join operation hint is specified only for a single table.

```
SELECT /*+ NO_USE_NL(T1) */ *
  FROM T1, T2
 WHERE T1.I1 = T2.I1;
```

- Type 2: Each different join operation hints are specified for two tables.
(The hint specified in table T2 is applied, so the hash join is applied.)

```
SELECT /*+ NO_USE_NL(T1) USE_HASH(T2) */ *
  FROM T1, T2
 WHERE T1.I1 = T2.I1;
```

- Type 3: NO_USE_NL hint is specified but the join operation such as hash join can not be applied because of constraints.
(A nested loops join is applied.)

```
SELECT /*+ NO_USE_NL(T1) */ *
  FROM T1, T2
 WHERE T1.I1 < T2.I1;
```

USE_INL

It instructs an optimizer to perform join by using a nested loops join method which uses a sort instant if the table specified in this hint is included when performing join.

This hint is applicable only when tables which are separated by ',' are specified in <from clause> or the tables are specified by inner join.

USE_INL hint should specify one or more tables, and it can not specify identical tables more than two. The tables specified in USE_INL hint are not allowed to be specified in USE_HASH, USE_MERGE, USE_NL. When it is specified, if "hint_error" property is set to *on*, it is treated as a validation error. If "hint_error" property is set to *off*, the firstly specified hint is applied.

Also, if each different join operation hints are specified for two tables participating in join, the hint specified in the left node (outer node) is firstly applied.

The nested loops join using a sort instant creates a sort instance whose sort key is expressions satisfying the join condition for the table in the right node (inner node), and performs join using it. In this case, the sort key should be a type which can perform key compare.

If all expressions satisfying the join condition are a type which can not perform key compare, this method can not be applied. In this case, an optimizer calculates the cost of other join operations and selects the best join operation.

The following is an example of applying USE_INL hint to join the tables T1, T2.

- Type 1: The join operation hint is specified only for a single table.

```
SELECT /*+ USE_INL(T1) */ *
  FROM T1, T2
 WHERE T1.I1 = T2.I1;
```

- Type 2: Each different join operation hints are specified for two tables.
(The order is determined according to ORDERED hint, and the join operation hint

(USE_INL) is applied for the table T1 in the left node (outer node))

```
SELECT /*+ ORDERED USE_INL(T1) USE_HASH(T2) */ *
  FROM T1, T2
 WHERE T1.I1 = T2.I1;
```

NO_USE_INL

It instructs an optimizer to perform join by selecting one of the methods except for the nested loops join method which uses a sort instant if the table specified in this hint is included when performing join. This hint is applicable to all join types.

NO_USE_INL hint should specify one or more tables, and it can not specify identical tables more than two. The tables specified in NO_USE_INL hint are allowed to be specified in any other join operation hint except for USE_INL hint.

When the table specified in this hint is specified in USE_INL hint, if "hint_error" property is set to *on*, it is treated as a validation error. If "hint_error" property is set to *off* the firstly specified hint is applied.

Also, if each different join operation hints are specified for two tables participating in join, the hint specified in the left node(outer node) is firstly applied.

When tables specified in NO_USE_INL hint participates in join, an optimizer calculates the cost of other join operations except for the nested loops join method which uses a sort instant, and selects the best join operation..

The following is an example of applying NO_USE_INL hint to join the tables T1, T2.

- Type 1: The join operation hint is specified only for a single table.

```
SELECT /*+ NO_USE_INL(T1) */ *
  FROM T1, T2
 WHERE T1.I1 = T2.I1;
```

- Type 2: Each different join operation hints are specified for two tables.
(The hint specified in table T2 is applied, so the hash join is applied.)

```
SELECT /*+ NO_USE_INL(T1) USE_HASH(T2) */ *
  FROM T1, T2
 WHERE T1.I1 = T2.I1;
```

<query_transformation_hints>

UNNEST

It instructs an optimizer to change subqueries to the join statement which guarantees the same results. Therefore, it does not repeatedly perform subqueries by using the method to treat the join with the upper-

level query instead of separately performing a subquery.

The UNNEST hint can be specified only in <hint clause> of the subquery. It is applied only to the subquery, and is not applied to subordinate subqueries.

To unnest all subqueries when multiple subqueries exist, the UNNEST hints should be specified for all subqueries. To unnest a subquery which exist within a subquery, the UNNEST hints should be specified for that subquery.

If UNNEST hint is specified together with NO_QUERY_TRANSFORMATION hint, UNNEST hint is ignored due to NO_QUERY_TRANSFORMATION hint.

UNNEST hint can not be used simultaneously with the NO_UNNEST hint. If they are used simultaneously and "hint_error" property is set to *on*, it is treated as a validation error. If "hint_error" property is set to *off* the firstly specified hint is applied.

The following is an example of applying unnesting to a subquery by using UNNEST hint.

- Type 1: It is used in IN subquery.

```
SELECT *
  FROM T1
 WHERE I1 IN ( SELECT /*+ UNNEST */ I1
              FROM T2 );
```

- Type 2: UNNEST hint and NO_QUERY_TRANSFORMATION hint are specified.
(The subquery is not unnested due to NO_QUERY_TRANSFORMATION hint.)

```
SELECT *
  FROM T1
 WHERE I1 IN ( SELECT /*+ UNNEST NO_QUERY_TRANSFORMATION */ I1
              FROM T2 );
```

NO_UNNEST

It instructs an optimizer to process a subquery as a filter instead of unnesting. This performs subquery whenever in need.

NO_UNNEST hint can be specified only in <hint clause> of a subquery. It is applied only to the subquery, and is not applied to subordinate subqueries.

Not to unnest all subqueries when multiple subqueries exist, the NO_UNNEST hints should be specified for all subqueries. Not to unnest a subquery which exist within a subquery, the NO_UNNEST hints should be specified for that subquery.

If NO_UNNEST hint is specified together with NO_QUERY_TRANSFORMATION hint, NO_UNNEST hint is i

gnored due to NO_QUERY_TRANSFORMATION hint.

NO_UNNEST hint can not be used simultaneously with UNNEST hint. If they are used simultaneously and "hint_error" property is set to *on*, it is treated as a validation error. If "hint_error" property is set to *off*, the firstly specified hint is applied.

The following is an example of applying no unnesting to a subquery by using NO_UNNEST hint.

- It is used in IN subquery.

```
SELECT *
  FROM T1
 WHERE I1 IN ( SELECT /*+ NO_UNNEST */ I1
              FROM T2 );
```

NL_SJ

It instructs an optimizer to process a subquery by using nested loops semi join. This method changes the subquery to a semi join form which has the same result.

NL_SJ hint can be used in EXISTS, IN, ANY quantify operator and it can not be used in NOT EXISTS, NOT IN, ALL quantify operator.

The optimizer ignores NL_SJ hint when it is specified in a subquery which can be changed only to anti-semi join form because NL_SJ hint changes the subquery to semi join form.

The following is an example of changing a subquery to a join form by using NL_SJ hint.

- Type 1: It is used in IN subquery.

```
SELECT *
  FROM T1
 WHERE I1 IN ( SELECT /*+ NL_SJ */ I1
              FROM T2 );
```

- Type 2: It is used in EXISTS subquery.

```
SELECT *
  FROM T1
 WHERE EXISTS ( SELECT /*+ NL_SJ */ I1
              FROM T2
              WHERE T1.I1 = T2.I1 );
```

- Type 3: It is used in the subquery of a quantify operator.

```
SELECT *
  FROM T1
 WHERE I1 < ANY ( SELECT /*+ NL_SJ */ I1
                  FROM T2 );
```

- Type 4: It is used in NOT IN subquery.
(The hint is ignored because it is an operator which can be changed to anti-semi join)

```
SELECT *
  FROM T1
 WHERE I1 NOT IN ( SELECT /*+ NL_SJ */ I1
                  FROM T2 );
```

NL_ISJ

It instructs an optimizer to process a subquery by using nested loops inverted semi join. This method changes the subquery to a inverted semi join form which has the same result.

Inverted semi join creates a sort instant which has a key for a semi join as a unique sort key on the right node (inner node). Then it reversely searches for a record which is identical to the corresponding key from the left node (outer node).

NL_ISJ hint is more advantageous in case when there are many duplicate right nodes (inner nodes) for keys of semi join and the key in the left node (outer node) can perform the index scan.

The optimizer ignores the hint when the index scan can not be performed in the left node (outer node) for the key of semi join. Also, the optimizer ignores the hint when the key compare for the key of semi join can not be performed.

NL_ISJ hint can be used in EXISTS, IN, = ANY quantify operator, and it can not be used in NOT EXISTS, NOT IN, ALL quantify operator, and ANY quantify operator except for =ANY.

The optimizer ignores NL_ISJ hint when it is specified in a subquery which can be changed only to anti-semi join form because NL_ISJ hint changes the subquery to semi join.

The following is an example of changing a subquery to a join form by using NL_ISJ hint.

- Type 1: It is used in IN subquery.

```
SELECT *
  FROM T1
 WHERE I1 IN ( SELECT /*+ NL_ISJ */ I1
              FROM T2 );
```

- Type 2: It is used in EXISTS subquery.

```
SELECT *
  FROM T1
 WHERE EXISTS ( SELECT /*+ NL_ISJ */ I1
                FROM T2
                WHERE T1.I1 = T2.I1 );
```

- Type 3: It is used in the subquery of a quantify operator.

```
SELECT *
  FROM T1
 WHERE I1 = ANY ( SELECT /*+ NL_ISJ */ I1
                 FROM T2 );
```

- Type 4: It is used in NOT IN subquery.
(The hint is ignored because it is an operator which can be changed to anti-semi join)

```
SELECT *
  FROM T1
 WHERE I1 NOT IN ( SELECT /*+ NL_ISJ */ I1
                  FROM T2 );
```

MERGE_SJ

It instructs an optimizer to process a subquery by using merge semi join. This method changes the subquery to a semi join form which has the same result.

MERGE_SJ hint can be used in EXISTS, IN, = ANY quantify operator, and it can not be used in NOT EXISTS, NOT IN, ALL quantify operator, and ANY quantify operator except for =ANY.

The optimizer ignores MERGE_SJ hint when it is specified in a subquery which can be changed only to an anti-semi join form because MERGE_SJ hint changes the subquery to semi join. Also, the optimizer ignores the hint when the key compare for the key of merge semi join can not be performed.

The following is an example of changing a subquery to a join form by using MERGE_SJ hint.

- Type 1: It is used in IN subquery.

```
SELECT *
  FROM T1
 WHERE I1 IN ( SELECT /*+ MERGE_SJ */ I1
              FROM T2 );
```

- Type 2: It is used in EXISTS subquery.

```
SELECT *
  FROM T1
 WHERE EXISTS ( SELECT /*+ MERGE_SJ */ I1
                FROM T2
                WHERE T1.I1 = T2.I1 );
```

- Type 3: It is used in the subquery of a quantify operator.

```
SELECT *
  FROM T1
 WHERE I1 = ANY ( SELECT /*+ MERGE_SJ */ I1
                 FROM T2 );
```

- Type 4: It is used in NOT IN subquery.
(The hint is ignored because it is an operator which can be changed to anti-semi join)

```
SELECT *
  FROM T1
 WHERE I1 NOT IN ( SELECT /*+ MERGE_SJ */ I1
                  FROM T2 );
```

HASH_SJ

It instructs an optimizer to process a subquery by using hash semi join. This method changes the subquery to a semi join form which has the same result.

HASH_SJ hint can be used in EXISTS, IN, = ANY quantify operator, and it can not be used in NOT EXISTS, NOT IN, ALL quantify operator, ANY quantify operator except for = ANY.

The optimizer ignores HASH_SJ hint when it is specified in a subquery which can be changed only to anti-semi join form because HASH_SJ hint changes the subquery to semi join. Also, the optimizer ignores the hint when the key compare for the key of hash semi join can not be performed.

The following is an example of changing a subquery to a join form by using HASH_SJ hint.

- Type 1: It is used in IN subquery.

```
SELECT *
  FROM T1
 WHERE I1 IN ( SELECT /*+ HASH_SJ */ I1
              FROM T2 );
```

- Type 2: It is used in EXISTS subquery.

```

SELECT *
  FROM T1
 WHERE EXISTS ( SELECT /*+ HASH_SJ */ I1
                FROM T2
                WHERE T1.I1 = T2.I1 );

```

- Type 3: It is used in the subquery of a quantify operator.

```

SELECT *
  FROM T1
 WHERE I1 = ANY ( SELECT /*+ HASH_SJ */ I1
                 FROM T2 );

```

- Type 4: It is used in NOT IN subquery.
(The hint is ignored because it is an operator which can be changed to anti-semi join)

```

SELECT *
  FROM T1
 WHERE I1 NOT IN ( SELECT /*+ HASH_SJ */ I1
                  FROM T2 );

```

HASH_ISJ

It instructs an optimizer to process a subquery by using hash inverted semi join. This method changes the subquery to a inverted semi join form which has the same result.

HASH_ISJ hint is more advantageous in the case that the number of rows of the left node (outer node) is small, whereas the number of rows of the right node (inner node) is large. The optimizer ignores the hint when the key compare for the key of semi join can not be performed.

HASH_ISJ hint can be used in EXISTS, IN, = ANY quantify operator, and it can not be used in NOT EXISTS, NOT IN, ALL quantify operator, ANY quantify operator except for = ANY.

The optimizer ignores HASH_ISJ hint when it is specified in a subquery which can be changed only to anti-semi join form because HASH_ISJ hint changes the subquery to semi join. Also, the optimizer ignores the hint when the key compare for the key of hash semi join can not be performed.

The following is an example of changing a subquery to a join form by using HASH_ISJ hint.

- Type 1: It is used in IN subquery.

```

SELECT *
  FROM T1
 WHERE I1 IN ( SELECT /*+ HASH_ISJ */ I1
              FROM T2 );

```

- Type 2: It is used in EXISTS subquery.

```
SELECT *
  FROM T1
 WHERE EXISTS ( SELECT /*+ HASH_ISJ */ I1
                FROM T2
                WHERE T1.I1 = T2.I1 );
```

- Type 3: It is used in the subquery of a quantify operator.

```
SELECT *
  FROM T1
 WHERE I1 = ANY ( SELECT /*+ HASH_ISJ */ I1
                  FROM T2 );
```

- Type 4: It is used in NOT IN subquery.
(The hint is ignored because it is an operator which can be changed to anti-semi join)

```
SELECT *
  FROM T1
 WHERE I1 NOT IN ( SELECT /*+ HASH_ISJ */ I1
                  FROM T2 );
```

HASH_AJ

It instructs an optimizer to process a subquery by using hash anti-semi join. This method changes the subquery to a anti-semi join form which has the same result.

HASH_AJ hint can be used in NOT EXISTS, NOT IN, != ALL quantify operator, and it can not be used in EXISTS, IN, ANY quantify operator, ALL quantify operator except for != ALL.

The optimizer ignores HASH_AJ hint when it is specified in a subquery which can be changed only to semi join form because HASH_AJ hint changes the subquery to anti-semi join. Also, the optimizer ignores the hint when the key compare for the key of hash semi join can not be performed.

The following is an example of changing a subquery to a join form by using HASH_AJ hint.

- Type 1: It is used in NOT IN subquery.

```
SELECT *
  FROM T1
 WHERE I1 NOT IN ( SELECT /*+ HASH_AJ */ I1
                  FROM T2 );
```

- Type 2: It is used in NOT EXISTS subquery.

```

SELECT *
  FROM T1
 WHERE NOT EXISTS ( SELECT /*+ HASH_AJ */ I1
                   FROM T2
                   WHERE T1.I1 = T2.I1 );

```

- Type 3: It is used in the subquery of a quantify operator.

```

SELECT *
  FROM T1
 WHERE I1 != ALL ( SELECT /*+ HASH_AJ */ I1
                  FROM T2 );

```

- Type 4: It is used in IN subquery.
(The hint is ignored because it is an operator which can be changed to semi join)

```

SELECT *
  FROM T1
 WHERE I1 IN ( SELECT /*+ HASH_AJ */ I1
              FROM T2 );

```

TRANSITIVE_CLOSURE

If $A=B$ and $B=C$, then $A=C$. The relation like this is applied to a join predicate.

- 'T1.i1 = T2.i1' and 'T2.i1 = T3.i1' create 'T1.i1 = T3.i1' predicate.
However, if it is not used in a join ordering, then it will be automatically deleted.

```

SELECT *
  FROM T1, T2, T3
 WHERE T1.i1 = T2.i1 AND T2.i1 = T3.i1;

```

In the example above, if the join ordering is $((t1 \bowtie t2) \bowtie t3)$, then only one predicate with higher selectivity is selected between 'T2.i1 = T3.i1' and 'T1.i1 = T3.i1'. If the join ordering is $((t1 \bowtie t3) \bowtie t2)$, then only one predicate with higher selectivity is selected between 'T1.i1 = T2.i1' and 'T2.i1 = T3.i1'.

NO_TRANSITIVE_CLOSURE

It does not apply the join transitive closure to a join predicate.

- 'T1.i1 = T2.i1' and 'T2.i1 = T3.i1' does not create 'T1.i1 = T3.i1' predicate.

```
SELECT *
  FROM T1, T2, T3
 WHERE T1.i1 = T2.i1 AND T2.i1 = T3.i1;
```

The join transitive closure is not applied, so 'T1.i1 = T3.i1' predicate does not exist. Therefore, the join ordering such as ((t1 ⋈ t3) ⋈ t2) can not occur.

MERGE

It instructs an optimizer to apply a simple view merging to the specified view when it is possible. This hint should be specified in superordinate query block which includes the specified view.

If MERGE hint is used together with <join order hints>, <join operation hints>, <other hints>, TRANSITIVE_CLOSURE/NO_TRANSITIVE hint, NO_MERGE hint, then the processing is ambiguous.

Therefore, if these hints are used together with MERGE hint, and "hint_error" property is set to *on* it is treated as a validation error. If "hint_error" property is set to *off*, the firstly specified hint is applied.

The following is an example of applying simple view merging by using MERGE hint.

- Type 1: If MERGE hint is specified in a single view, then a simple view merging is performed for v1.

```
SELECT /*+ MERGE(v1) */ *
  FROM ( SELECT * FROM t1 ) v1;
```

- Type 2: If MERGE hint is specified in multiple views, then a simple view merging is performed for v1 and v2, but it is not applied to v3.

```
SELECT /*+ MERGE(v1) MERGE(v2) NO_MERGE(v3) */ *
  FROM ( SELECT i1 FROM t1 ) v1,
        ( SELECT i1 FROM t2 ) v2,
        ( SELECT i1 FROM t3 ) v3
 WHERE v1.i1 = v2.i1 AND v2.i1 = v3.i1;
```

- Type 3: If the simple view merging is performed when the hint is specified together with <join order hints>, then the application order and direction between t3 and t4 is ambiguous. Therefore, the firstly specified hint is applied only, and the simple view merging is not performed.

```
SELECT /*+ ORDERING( t1, t2, v1 RIGHT ) MERGE(v1) */ *
  FROM t1,
        t2,
        ( SELECT * FROM t3, t4 WHERE t3.i1 = t4.i1 ) v1
 WHERE t1.i1 = t2.i1 AND t2.i1 = v1.i1;
```

→

- Type 4: If the simple view merging is performed when the hint is specified together with <join operation hints>, then the view which is a target of hashing disappears. Therefore, the firstly specified hint is applied only, and the simple view merging is not performed.

```
SELECT /*+ USE_HASH(v1) MERGE(v1) */ *
  FROM t1,
       t2,
       ( SELECT * FROM t3, t4 WHERE t3.i1 = t4.i1 ) v1
 WHERE t1.i1 = t2.i1 AND t2.i1 = v1.i1;
```

- Type 5: If the simple view merging is performed when the hint is specified together with <other hints>, then other hints between the view and the superordinate query conflicts. Therefore, the firstly specified hint is applied only, and the simple view merging is not performed.

```
SELECT /*+ PUSH_PRED MERGE(v1) */ *
  FROM ( SELECT /*+ NO_PUSH_PRED */ * FROM t1 WHERE t1.i1 = 1 ) v1
 WHERE v1.i1 = 1;
```

- Type 6: If the simple view merging is performed when the hint is specified together with TRANSITIVE_CLOSURE hint, then other hints between the view and the superordinate query conflicts. Therefore, the firstly specified hint is applied only, and the simple view merging is not performed.

```
SELECT /*+ TRANSITIVE_CLOSURE MERGE(v1) */ *
  FROM ( SELECT /*+ NO_TRANSITIVE_CLOSURE */ *
        FROM t1, t2, t3
        WHERE t1.i1 = t2.i1 AND t2.i1 = t3.i1 ) v1;
```

NO_MERGE

It instructs an optimizer not to apply a simple view merging to the specified view even when it is possible. This hint should be specified in superordinate query block which includes the specified view.

If NO_MERGE hint is used together with <join order hints>, <join operation hints>, <other hints>, TRANSITIVE_CLOSURE/NO_TRANSITIVE hint, MERGE hint, then the processing is ambiguous.

Therefore, if these hints are used together with NO_MERGE hint, and "hint_error" property is set to *on* it is treated as a validation error. If "hint_error" property is set to *off*, the firstly specified hint is applied.

The following is an example of not applying simple view merging by using NO_MERGE hint.

- Type 1: If NO_MERGE hint is specified in a single view, then a simple view merging is not performed for v1.

```
SELECT /*+ NO_MERGE(v1) */ *
  FROM ( SELECT * FROM t1 ) v1;
```

- Type 2: If NO_MERGE hint is specified in multiple views, then a simple view merging is performed for v1 and v2, but it is not applied to v3.

```
SELECT /*+ MERGE(v1) MERGE(v2) NO_MERGE(v3) */ *
  FROM ( SELECT i1 FROM t1 ) v1,
        ( SELECT i1 FROM t2 ) v2,
        ( SELECT i1 FROM t3 ) v3
 WHERE v1.i1 = v2.i1 AND v2.i1 = v3.i1;
```

NO_QUERY_TRANSFORMATION

It instructs an optimizer not to change anything for a query. This hint does not perform the process of which a heuristic optimizer and cost based optimizer changes the query for the best performance.

NO_QUERY_TRANSFORMATION hint can be specified in the top-level query and subquery, and it is applied to the specified query and all its subordinate subqueries.

The following is an example of preventing a query being changed by using NO_QUERY_TRANSFORMATION.

- Type 1: NO_QUERY_TRANSFORMATION hint is used in the subquery.
(Only the query in the subquery is not changed.)

```
SELECT *
  FROM T1
 WHERE I1 IN ( SELECT /*+ NO_QUERY_TRANSFORMATION */ I1
              FROM T2 );
```

- Type 2: NO_QUERY_TRANSFORMATION hint is used in the top-level query.
(All queries in the top-level query and its subquery are not changed.)

```
SELECT /*+ NO_QUERY_TRANSFORMATION */ *
  FROM T1
 WHERE I1 IN ( SELECT I1
              FROM T2 );
```

- Type 3: NO_QUERY_TRANSFORMATION hint is used in the top-level query, and the UNNEST hint is used in the subquery.
(The UNNEST hint for the subquery is ignored.)

```
SELECT /*+ NO_QUERY_TRANSFORMATION */ *
  FROM T1
 WHERE I1 IN ( SELECT /*+ UNNEST */ I1
              FROM T2 );
```

<other_hints>

PUSH_PRED

It instructs an optimizer to push filters which are applicable to a single table. The hint pushes filters of the select statement to a single table to which the filters are applicable, then preprocess it.

The hint can be respectively specified to subqueries starting with SELECT, and it is applied only within a block of each query, but it is not spreaded to a subordinate subquery.

The hint can be independently specified in each subqueries.

If it is not specified, the default value is applied. The default value is PUSH_PRED.

The following is an example of pushing a subquery by using PUSH_PRED hint.

- It pushes $T1.i1 = 1$ to table T1.

```
SELECT /*+ PUSH_PRED */ *
  FROM T1, T2
 WHERE T1.I1 = T2.I1
       AND T1.I1 = 1;
```

NO_PUSH_PRED

It instructs an optimizer not to push filters which are applicable to a single table. The hint prevents pushing filters of the select statement to a single table to which the filters are applicable, so that it is not to be preprocessed.

The hint can be respectively specified to subqueries starting with SELECT, and it is applied only within a block of each query, but it is not spreaded to a subordinate subquery.

The hint can be independently specified in each subqueries.

If it is not specified, the default value is applied. The default value is PUSH_PRED.

If the hint is specified, and a join exists in a from statement, then it is processed at the lowest join among joins which can process the filter. In other words, it prevents preprocessing in a single table which can process the filter.

If the hint is specified, and a view exists in the from statement, then the filter is not pushed to the low-level of the view.

The following is an example of pushing a filter by using NO_PUSH_PRED hint.

- Type 1: It performs $T1.i1 = 1$ after joining T1 and T2.

```
SELECT /*+ NO_PUSH_PRED */ *
  FROM T1, T2
 WHERE T1.I1 = T2.I1
        AND T1.I1 = 1;
```

- Type 2: It performs $A.i1 = 1$ after processing view A.

```
SELECT /*+ NO_PUSH_PRED */ *
  FROM (SELECT I1 FROM T1) AS A
 WHERE A.I1 = 1;
```

PUSH_SUBQ

It instructs an optimizer to push a subquery to the lowest applicable node. When the upper level query of the subquery consists of join, this hint scans a structure of the join nodes, from the top to the bottom, to find a node which can process the subquery. Then it processes the subquery from the lowest node which can push the subquery.

PUSH_SUBQ hint can be specified only in the subquery. When multiple subqueries exist, PUSH_SUBQ hint should be respectively specified in each subquery.

If the PUSH_SUBQ hint is not specified, the optimizer calculates the cost and pushes the subquery to the node of the best cost.

The following is an example of pushing a subquery by using PUSH_SUBQ hint.

- Type 1: A subquery is pushed to the table T1.

```
SELECT *
  FROM T1, T2
 WHERE T1.I1 = T2.I1
        AND T1.I1 IN ( SELECT /*+ PUSH_SUBQ */ I1
                      FROM T3 );
```

- Type 2: The subquery can be processed only in the top node.
(The subquery can not be pushed to the subordinate node.)

```
SELECT *
  FROM T1, T2
 WHERE T1.I1 = T2.I1
        AND T1.I1 IN ( SELECT /*+ PUSH_SUBQ */ I1
                      FROM T3
```

```
WHERE T3.I2 = T1.I2
AND T3.I3 = T2.I3 );
```

NO_PUSH_SUBQ

It instructs the optimizer not to push the subquery to a subordinate node. When a superordinate query of the subquery consists of join, this hint processes the subquery at the top node of the join node.

NO_PUSH_SUBQ hint can be specified only in the subquery. When multiple subqueries exist, NO_PUSH_SUBQ hint should be respectively specified in each subquery.

If NO_PUSH_SUBQ hint is not specified, the optimizer calculates the cost and pushes the subquery to the node of the best cost.

The following is an example of pushing a subquery by using NO_PUSH_SUBQ hint.

- NO_PUSH_SUBQ hint is used for the subquery which can be processed in the table T1. (After joining the tables T1 and T2, the subquery is processed.)

```
SELECT *
FROM T1, T2
WHERE T1.I1 = T2.I1
AND T1.I1 IN ( SELECT /*+ NO_PUSH_SUBQ */ I1
FROM T3 );
```

USE_GROUP_HASH

When group by clause exists, it instructs an optimizer to use a hash instant for grouping.

USE_GROUP_HASH hint can be specified only in group by clause. When multiple subqueries exist, USE_GROUP_HASH hint should be respectively specified in each subquery.

If USE_GROUP_HASH hint is not used and group keys for grouping are sorted from a subordinate node, a method using the group node is considered.

The following is an example of using USE_GROUP_HASH hint.

- USE_GROUP_HASH is used when the index consisting of group keys in the table T1 exists.

```
SELECT /*+ USE_GROUP_HASH */ *
FROM T1
GROUP BY I1;
```

USE_DISTINCT_HASH

When distinct clause exist, it instructs an optimizer to use a hash instant to perform distinct.

USE_DISTINCT_HASH hint can be specified only in a statement with distinct clause. When multiple subqueries exist, USE_DISTINCT_HASH hint should be respectively specified in each subquery.

If USE_DISTINCT_HASH hint is not used and distinct keys are sorted from a subordinate node, a method using the group node is considered.

The following is an example of using USE_DISTINCT_HASH hint.

- USE_DISTINCT_HASH is used when the index consisting of distinct keys is in the table T1 exists.

```
SELECT /*+ USE_DISTINCT_HASH */ I1, I2  
FROM T1;
```

Description

A hint is a comment which a user directly instructs how to perform an SQL statement to the GOLDILOCKS optimizer. When GOLDILOCKS optimizer does not determine an appropriate execution plan, the user can select the execution plan using the hint.

The GOLDILOCKS optimizer preferentially selects the user defined hints to determine an execution plan. If the user defined hint is not available, the GOLDILOCKS optimizer determines the execution plan.

GOLDILOCKS optimizer operates based on the user defined hint as possible when the user uses a hint. Therefore, it is recommended to use the hint only when it is determined that the execution plan of GOLDILOCKS optimizer is wrong while the user performs the SQL statement.

Especially, GOLDILOCKS optimizer performs the execution plan according to the user defined hint when repeatedly using the same SQL statement by a hint. Therefore, be cautious that the table or view included in the SQL statement is updated, and the performance of another execution plan may be degraded.

In GOLDILOCKS, the hint can be used in SELECT, INSERT SELECT, DELETE, UPDATE statements. The hint can be specified after the keyword of each statement and it is specified between the keywords '/ * + ' and '* / '.

If a wrong hint is specified, or if hints conflict because two or more hints for the same execution plan are specified, the hint is ignored or the first hint is applied. To check if the hint is wrong, use the hint after setting HINT_ERROR property to *on* by using ALTER statement.

Examples

The following is an example of using <hint clause> in INSERT SELECT, DELETE, UPDATE, SELECT statements.

- It is used in INSERT SELECT statement.

```
gSQL> INSERT INTO T1 SELECT /*+ INDEX(T1, T1_IDX) */ * FROM T1;
1 row created.
```

- It is used in SELECT statement.

```
gSQL> SELECT /*+ INDEX(T1, T1_IDX) */ * FROM T1;
I1
--
1
1
2 rows selected.
```

- It is used in UPDATE statement.

```
gSQL> UPDATE /*+ INDEX(T1, T1_IDX) */ T1 SET I1 = 2;
2 rows updated.
```

- It is used in DELETE statement.

```
gSQL> DELETE /*+ INDEX(T1, T1_IDX) */ T1 WHERE I1 = 2;
2 rows deleted.
```

The following is an example of using a wrong hint when HINT_ERROR property is set to *on* by using ALTER statement.

```
gSQL> ALTER SESSION SET HINT_ERROR = ON;
Session altered.
gSQL> SELECT /*+ INDEX(T2, T1_IDX) */ * FROM T1;
ERR-42000(16058): not applicable hint :
SELECT /*+ INDEX(T2, T1_IDX) */ * FROM T1
      *
ERROR at line 1:
```

Compatibility

The SQL standard does not define a hint, and the other vendors, such as Oracle support a hint in their own forms.

Most hints of GOLDILOCKS are compatible with hints of Oracle, and the hints of GOLDILOCKS which are as same as the hints of Oracle are operated in Oracle in the same way. However, Oracle has a different meaning for the INDEX_COMBINE hint, and Oracle does not support the ORDERING hint.

For More Information

Refer to [query specification](#).

16.126 SELECT .. FOR UPDATE

Function

It sets whether or not to update the result set of SELECT statement.

Syntax

```
<select for update statement> ::=
    <query expression> <updatability clause>
    ;
<updatability clause> ::=
    FOR READ ONLY
    | FOR UPDATE [ OF <column name list> ] [ <lock wait mode> ]
<lock wait mode> ::=
    | WAIT
    | WAIT second
    | NOWAIT
```

Invocation and Access Rules

The user should satisfy the following conditions to perform <select for update statement>.

- One of the following privileges for all tables used in the statement is required for a user to perform <query expression>.
 - SELECT(columns) ON TABLE for all columns used in the statement among the table columns
 - (SELECT or CONTROL TABLE) ON TABLE for that table
 - (SELECT TABLE or CONTROL SCHEMA) ON SCHEMA for the schema to which the table belongs
 - SELECT ANY TABLE ON DATABASE
- If FOR UPDATE clause is used, one of the following privileges for the tables to be locked is required.
 - (LOCK or CONTROL TABLE) ON TABLE for that table
 - (LOCK TABLE or CONTROL SCHEMA) ON SCHEMA for the schema to which the table belongs
 - LOCK ANY TABLE ON DATABASE

Syntax Rules and Parameters

<query expression>

INTO clause should not exist in SELECT statement.

To use FOR UPDATE, the query should identify the row updates of the base table, or it should be an updatable query which can acquire the lock into the row.

The updatable query should satisfy all of following conditions.

- DISTINCT should not exist in the top-level query.
 - (X) SELECT DISTINCT * FROM t1;
- GROUP BY, HAVING, aggregation function should not exist in the top-level query.
 - (X) SELECT MAX(c1) FROM t1;
- Set operators should not exist.
 - (X) SELECT * FROM t1 UNION ALL SELECT * FROM t2;
- There should be at least one updatable column in the table listed in FROM clause.
 - The column of the table which is not for cross join among the tables included in join is not an updatable column.
 - OUTER JOIN is not the cross join.
 - NATURAL JOIN is not the cross join.
 - If USING clause is used in INNER JOIN, it is not the cross join.
 - The column of the following tables is not an updatable column.
 - Dictionary table, fixed table, performance view
 - The column of a view is not an updatable table.

For more information about SELECT statement, refer to **query expression**.

<updatability clause>

It specifies whether or not to update the row for the result set.

- FOR READ ONLY
 - The read-only query is declared.
- FOR UPDATE
 - The writable query is declared.
 - x lock is acquired for the rows until the end of the transaction to prevent other transactions from updating the rows when executing the query.
 - <query expression> should be an updatable query.

FOR UPDATE OF ...

It lists the columns relating to acquiring lock when executing the query.

- The column listed in FOR UPDATE OF statement.
 - It should be updatable columns of the table listed in the FROM clause of <query expression>.
 - It acquires a lock for the table of the listed column.
- Only FOR UPDATE is used
 - It means the same as listing all updatable columns of the table in FROM clause of <query expression>.
 - It acquires a lock for the table of all columns.

<lock wait mode>

It is used together with FOR UPDATE statement, and it specifies the lock acquisition method.

- WAIT
 - It acquires a lock for all rows of the query result before obtaining the query result.
 - It waits until acquiring a lock.
- WAIT second
 - It acquires a lock for all rows of the query result before acquiring the query result.
 - If the lock is not acquired for a specified time, an error occurs.
 - The wait time is in seconds and it can use the value between 0 and 1,000,000,000.
- NOWAIT
 - It acquires a lock for all rows of the query result before acquiring the query result.
 - If the lock is not immediately acquired, an error occurs.
- If it is not specified, the default value is WAIT.

Description

SELECT statement keep fetching the rows regardless of whether the transaction ends. However, SELECT .. FOR UPDATE statement can not fetch the rows when the transaction ends because the statement acquires the lock for the rows.



Cursor holdability

- WITH HOLD
 - It can keep fetching regardless of whether the transaction ends.
 - It is also known as fetch across commit.

- WITHOUT HOLD
 - When the transaction ends, it can not fetch.

Examples

The following is an example of acquiring a lock for the row by using FOR UPDATE statement.

```
gSQL> SELECT id, data FROM t1 WHERE id = 3 FOR UPDATE;
ID DATA
-- -----
 3 data_3
1 row selected.
```

The following uses join and ORDER BY clause but it is an updatable query, so FOR UPDATE statement can be used.

```
gSQL> SELECT t1.id, t1.name, t2.addr
        FROM t1, t2
        WHERE t1.id = t2.id
        ORDER BY 1
        FOR UPDATE;
ID NAME  ADDR
-- -----
 1 someone somewhere
 2 anyone  anywhere
 3 unknown N/A
 4 leekmo  leekmo's home
 5 mkkim   seoul
5 rows selected.
```

The following is a non-updatable query, so FOR UPDATE statement can not be used.

```
gSQL> SELECT id, COUNT(*)
        FROM t1
        GROUP BY id
        FOR UPDATE;
ERR-42000(16112): query expression is not updatable
```

Compatibility

In the SQL standard, <select for update statement> is not defined, but it can be defined by using **DECLARE cursor_name** statement.

16.127 SELECT .. INTO

Function

It retrieves a single row by using a query, then obtains the value of retrieved row into the host variable.

Syntax

```
<select statement: single row> ::=  
    SELECT [ <hint clause> ] [ <set quantifier> ] <select list>  
        INTO <select target list>  
        <table expression>  
    ;  
<select target list> ::=  
    variable_name [, ...]
```

Invocation and Access Rules

One of the following privileges for all tables used in the statement is required for a user to perform <select statement: single row>.

- SELECT(columns) ON TABLE for all columns used in the statement among the table columns
- (SELECT or CONTROL TABLE) ON TABLE for that table
- (SELECT TABLE or CONTROL SCHEMA) ON SCHEMA for the schema to which the table belongs
- SELECT ANY TABLE ON DATABASE

Syntax Rules and Parameters

<hint clause>

It specifies hints for query execution.

For more information, refer to **hint clause** of SELECT statement.

⟨set quantifier⟩

It specifies whether to remove duplicates from the query result.
For more information, refer to **query specification** clause.

⟨select list⟩

It specifies the columns to be retrieved from the query result.
For more information, refer to **select list** clause.

INTO ⟨select target list⟩

The number of the variable specified in INTO clause should be equal to the number of the expression specified in ⟨select list⟩.

⟨table expression⟩

It specifies the query information such as a search condition.
For more information, refer to **query specification** clause.

Description

The rows to be retrieved should be one or less.
If two or more rows are retrieved, an error occurs.

Differences among SELECT-related Statements

- ⟨select statement⟩
 - It retrieves multiple rows which satisfy the condition, and the retrieved rows can be retrieved by using API such as SQLFetch ().
 - e.g. `SELECT c1 FROM t1 WHERE c1 > 0;`
- ⟨select statement: single row⟩
 - It can retrieve one or less row which satisfies the condition, then obtains the value into the host variable in INTO clause when the retrieved row is a single row.
 - e.g. `SELECT c2 INTO :v1 FROM t1 WHERE c1 = 0;`

Example

The following is an example of obtaining the value into the host variable by using interactive SQL (gsql).

```
gSQL> \var v_id    INTEGER
gSQL> \var v_data VARCHAR(128)
gSQL> SELECT id, data INTO :v_id, :v_data FROM t1 WHERE id = 3;
V_ID V_DATA
---- -
      3 data_3
1 row selected.
```

16.128 SELECT .. INTO .. FOR UPDATE

Function

It sets whether to update the row by retrieving a single row through the query, then obtains the value of retrieved row into the host variable.

Syntax

```

<select for update statement: single row> ::=
    SELECT [ <hint clause> ] [ <set quantifier> ] <select list>
        INTO <select target list>
            <table expression> <updatability clause>
    ;
<select target list> ::=
    variable_name [, ...]
<updatability clause> ::=
    FOR READ ONLY
    | FOR UPDATE [ OF <column name list> ] [ <lock wait mode> ]
<lock wait mode> ::=
    | WAIT
    | WAIT second
    | NOWAIT

```

Invocation and Access Rules

One of the following privileges for all tables used in the statement is required for a user to perform <select statement: single row>.

- SELECT(columns) ON TABLE for all columns used in the statement among the table columns
- (SELECT or CONTROL TABLE) ON TABLE for that table
- (SELECT TABLE or CONTROL SCHEMA) ON SCHEMA for the schema to which the table belongs
- SELECT ANY TABLE ON DATABASE

If FOR UPDATE clause is used, one of the following privileges for the tables to be locked is required.

- (LOCK or CONTROL TABLE) ON TABLE for that table
- (LOCK TABLE or CONTROL SCHEMA) ON SCHEMA for the schema to which the table belongs
- LOCK ANY TABLE ON DATABASE

Syntax Rules and Parameters

⟨select for update statement: single row⟩

To use FOR UPDATE, the query should identify the row updates of the base table, or it should be an updatable query which can acquire the lock into the row.

The updatable query should satisfy all of following conditions.

- DISTINCT should not exist in the top-level query.
 - (X) SELECT DISTINCT * FROM t1;
- GROUP BY, HAVING, aggregation function should not exist in the top-level query.
 - (X) SELECT MAX(c1) FROM t1;
- Set operators should not exist.
 - (X) SELECT * FROM t1 UNION ALL SELECT * FROM t2;
- There should be at least one updatable column in the table listed in FROM clause.
 - The column of the table which is not for cross join among the tables included in join is not an updatable column.
 - FULL OUTER JOIN is not the cross join.
 - NATURAL JOIN is not the cross join.
 - If USING clause is used in INNER JOIN, it is not the cross join.
 - The column of the following tables is not an updatable column.
 - Dictionary table, fixed table, performance view
 - The column of a view is not an updatable table.

⟨updatability clause⟩

It specifies whether or not to update the row for the result set.

- FOR READ ONLY
 - The read-only query is declared.
- FOR UPDATE
 - The writable query is declared.
 - x lock is acquired for the rows until the end of the transaction to prevent other transactions from updating the rows when executing the query.
 - ⟨query expression⟩ should be an updatable query.

FOR UPDATE OF ...

It lists the columns relating to acquiring lock when executing the query.

- The column listed in FOR UPDATE OF statement.
 - It should be updatable columns of the table listed in the FROM clause of <query expression>.
 - It acquires a lock for the table of the listed column.
- Only FOR UPDATE is used
 - It means the same as listing all updatable columns of the table in FROM clause of <query expression>.
 - It acquires a lock for the table of all columns.

<lock wait mode>

It is used together with FOR UPDATE statement, and it specifies the lock acquisition method.

- WAIT
 - It acquires a lock for all rows of the query result before obtaining the query result.
 - It waits until acquiring a lock.
- WAIT second
 - It acquires a lock for all rows of the query result before acquiring the query result.
 - If the lock is not acquired for a specified time, an error occurs.
 - The wait time is in seconds and it can use the value between 0 and 1,000,000,000.
- NOWAIT
 - It acquires a lock for all rows of the query result before acquiring the query result.
 - If the lock is not immediately acquired, an error occurs.
- If it is not specified, the default value is WAIT.

<hint clause>

It specifies hints for query execution.

For more information, refer to **hint clause** of SELECT statement.

<set quantifier>

It specifies whether to remove duplicates from the query result.

For more information, refer to **query specification** clause.

<select list>

It specifies the columns to be retrieved from the query result.
For more information, refer to **select list** clause.

INTO <select target list>

The number of the variable specified in INTO clause should be equal to the number of the expression specified in <select list>.

<table expression>

It specifies the query information such as a search condition.
For more information, refer to **query specification** clause.

Description

The rows to be retrieved should be one or less.
If two or more rows are retrieved, an error occurs.

SELECT statement keep fetching the rows regardless of whether the transaction ends. However, SELECT .. FOR UPDATE statement can not fetch the rows when the transaction ends because the statement acquires the lock for the rows.



Cursor holdability

- WITH HOLD
 - It can keep fetching regardless of whether the transaction ends.
 - It is also known as fetch across commit.
- WITHOUT HOLD
 - When the transaction ends, it can not fetch.

Differences among SELECT-related Statements

- <select for update statement>
 - It retrieves multiple rows which satisfy the condition, sets whether to update them and the retrieved rows can be retrieved by using API such as SQLFetch ().

- e.g. `SELECT c1 FROM t1 WHERE c1 > 0 FOR UPDATE;`
- `<select for update statement: single row>`
 - It can retrieve one or less row which satisfies the condition, sets whether to update them then obtains the value into the host variable in INTO clause when the retrieved row is a single row.
 - e.g. `SELECT c2 INTO :v1 FROM t1 WHERE c1 = 0 FOR UPDATE;`

Examples

The following is an example of acquiring a lock for the row by using FOR UPDATE statement, and obtaining the value into the host variable by using interactive SQL (gsql).

```
gSQL> \var v_id    INTEGER
gSQL> \var v_data VARCHAR(128)
gSQL> SELECT id, data INTO :v_id, :v_data FROM t1 WHERE id = 3 FOR UPDATE;
V_ID V_DATA
---- -
      3 data_3
1 row selected.
```

The following uses join and ORDER BY clause but it is an updatable query, so FOR UPDATE statement can be used.

```
gSQL> \var v_id    INTEGER
gSQL> \var v_name  VARCHAR(128)
gSQL> \var v_addr  VARCHAR(128)
gSQL> SELECT t1.id, t1.name, t2.addr
        INTO :v_id, :v_name, :v_addr
        FROM t1, t2
        WHERE t1.id = t2.id
        ORDER BY 1
        LIMIT 1
        FOR UPDATE;
ID NAME    ADDR
-- -
1  someone somewhere
1 row selected.
```

The following is a non-updatable query, so FOR UPDATE statement can not be used.

```
gSQL> \var v_id    INTEGER
gSQL> \var v_count INTEGER
gSQL> SELECT id, COUNT(*)
        INTO :v_id, :v_count
        FROM t1
        GROUP BY id
        FOR UPDATE;
ERR-42000(16112): query expression is not updatable
```

For More Information

Refer to the followings.

- [SELECT .. FOR UPDATE](#)
- [SELECT .. INTO](#)

16.129 SET CONSTRAINTS

Function

It sets the check point of deferrable constraint in a transaction to IMMEDIATE or DEFERRED.

Syntax

```
<set constraints mode statement> ::=  
    SET { CONSTRAINT | CONSTRAINTS } <constraint name list> { DEFERRED | IMMEDIATE }  
    ;  
<constraint name list> ::=  
    ALL  
    | <constraint name> [, ...]
```

Invocation and Access Rules

Any separate access privilege is not required for a user to perform SET CONSTRAINTS.



It is not supported in the cluster system.

Syntax Rules and Parameters

CONSTRAINT | CONSTRAINTS

CONSTRAINT and CONSTRAINTS are the keywords of the same meaning, and the SQL standard uses CONSTRAINTS.

<constraint name list>

It specifies the list of constraint names, or specifies ALL to set all deferrable constraints. When specifying <constraint name>, it should be the name of the deferrable constraint.

ALL means all deferrable constraints.

DEFERRED | IMMEDIATE

It sets the check point of specified deferrable constraints.

- IMMEDIATE
 - It checks the specified constraints when executing the DML statement.
 - If the transaction violates the constraints, then an error occurs.
- DEFERRED
 - It checks the specified constraints when the transaction is committed.

If the transaction is in progress, the check point of the constraint is set in the current transaction. If the transaction is not in progress, it is set in the next transaction.

After the transaction ends, it does not affect the next transaction.

Description

Deferrable Constraint

DEFERRABLE constraint can change its check point.

The following is an example of creating a table with a deferrable constraint, and inserting data to the table.

```
gSQL> CREATE TABLE t1
(
  id    INTEGER,
  name  VARCHAR(128) CONSTRAINT t1_uk UNIQUE
        DEFERRABLE INITIALLY IMMEDIATE
);
Table created.
gSQL> COMMIT;
Commit complete.
gSQL> INSERT INTO t1 VALUES ( 1, 'leekmo' );
1 row created.
gSQL> INSERT INTO t1 VALUES ( 2, 'mkkim' );
1 row created.
gSQL> COMMIT;
Commit complete.
```

In the example above, UNIQUE constraint which is deferrable is created on a name column, and the initial check point is set as INITIALLY IMMEDIATE. Therefore, the constraint is checked whenever DML statement is executed.

In this case, if the user tries to exchange the name value of two rows as follows, it violates the constraint because the check point is IMMEDIATE.

```
gSQL> UPDATE t1 SET name = 'mkkim' WHERE id = 1;
ERR-23000(16057): unique constraint (PUBLIC.T1_UK) violated
gSQL> UPDATE t1 SET name = 'leekmo' WHERE id = 2;
ERR-23000(16057): unique constraint (PUBLIC.T1_UK) violated
```

If the check point is changed to DEFERRED as follows, the operation as same as above succeeds because the constraint is checked when the transaction is committed.

```
gSQL> SET CONSTRAINTS t1_uk DEFERRED;
Constraints set.
gSQL> UPDATE t1 SET name = 'mkkim' WHERE id = 1;
1 row updated.
gSQL> UPDATE t1 SET name = 'leekmo' WHERE id = 2;
1 row updated.
gSQL> COMMIT;
Commit complete.
```

If the check point is set to DEFERRED, then the constraint is checked when the transaction is committed. Therefore, if the transaction is committed when the constraint is violated, then the transaction fails and it is rolled back as follows.

```
gSQL> SET CONSTRAINTS t1_uk DEFERRED;
Constraints set.
gSQL> INSERT INTO t1 VALUES ( 3, 'leekmo' );
1 row created.
gSQL> COMMIT;
ERR-40002(16291): transaction rollback: integrity constraint violation : PUBLIC.T1_UK(1)
```

Violation of a Deferred Constraint

Executing the following statements when the transaction violates the constraints set to DEFERRED, then an error occurs as follows.

- COMMIT
 - An error occurs and the transaction is rolled back.

- SET CONSTRAINTS ALL IMMEDIATE
 - An syntax error occurs.
- DDL
 - An syntax error occurs.

An unexpected ROLLBACK can occur when COMMIT, it is necessary to ensure whether the transaction violates the constraint by using SET CONSTRAINTS ALL IMMEDIATE statement.

```
gSQL> SET CONSTRAINTS t1_uk DEFERRED;
Constraints set.
gSQL> INSERT INTO t1 VALUES ( 3, 'leekmo' );
1 row created.
gSQL> SET CONSTRAINTS ALL IMMEDIATE;
ERR-23000(16038): integrity constraint violation : PUBLIC.T1_UK(1)
gSQL> SELECT * FROM t1 ORDER BY id;
ID NAME
-- -----
1 mkkim
2 leekmo
3 leekmo
3 rows selected.
gSQL> UPDATE t1 SET name = 'xcom73' WHERE id = 3;
1 row updated.
gSQL> SET CONSTRAINTS ALL IMMEDIATE;
Constraints set.
gSQL> COMMIT;
Commit complete.
```

Transaction Control Language

SET CONSTRAINTS statement is a transaction control language which is used when the transaction is in progress such as **SAVEPOINT savepoint_specifier**.

The transaction control such as COMMIT, ROLLBACK, ROLLBACK TO SAVEPOINT statement is applied to SET CONSTRAINTS statement.

The following is an example of a table with multiple deferrable constraints.

```
CREATE TABLE t1
(
  id1 INTEGER CONSTRAINT t1_uk1 UNIQUE DEFERRABLE INITIALLY IMMEDIATE,
  id2 INTEGER CONSTRAINT t1_uk2 UNIQUE DEFERRABLE INITIALLY IMMEDIATE,
```

```
id3 INTEGER CONSTRAINT t1_uk3 UNIQUE DEFERRABLE INITIALLY IMMEDIATE
);
```

If `<set constraints mode statement>` statement is performed when the transaction is in progress, the check point of deferrable constraints is changed depending on each point as follows.

- result: success

```
INSERT INTO t1 VALUES ( 1, 1, 1 );
1 row created.
COMMIT;
Commit complete.
```

- result: success

```
SAVEPOINT sp1;
Savepoint created.
```

- result: success
- t1_uk1 constraint is DEFERRED

```
SET CONSTRAINTS t1_uk1 DEFERRED;
Constraints set.
```

- result: success

```
SAVEPOINT sp2;
Savepoint created.
```

- result: success
- t1_uk1, t1_uk2 constraints are DEFERRED

```
SET CONSTRAINTS t1_uk2 DEFERRED;
Constraints set.
```

- result: success

```
SAVEPOINT sp3;
Savepoint created.
```

- result: success
- ALL constraints are DEFERRED

```
SET CONSTRAINTS ALL DEFERRED;  
Constraints set.
```

- result: success

```
SAVEPOINT sp4;  
Savepoint created.
```

- result: success
- ALL constraints are IMMEDIATE

```
SET CONSTRAINTS ALL IMMEDIATE;  
Constraints set.
```

When the transaction is partially rolled back by using ROLLBACK TO SAVEPOINT statement as follows, SET CONSTRAINTS statement is also partially rolled back and the check point is changed.

- result: error

```
INSERT INTO t1 VALUES ( 1, 2, 2 );  
ERR-23000(16057): unique constraint (PUBLIC.T1_UK1) violated
```

- result: error

```
INSERT INTO t1 VALUES ( 3, 1, 3 );  
ERR-23000(16057): unique constraint (PUBLIC.T1_UK2) violated
```

- result: error

```
INSERT INTO t1 VALUES ( 4, 4, 1 );  
ERR-23000(16057): unique constraint (PUBLIC.T1_UK3) violated
```

- result: success
- t1_uk1, t1_uk2 constraints are DEFERRED

```
ROLLBACK TO SAVEPOINT sp4;  
Rollback complete.
```

- result: success

```
INSERT INTO t1 VALUES ( 1, 2, 2 );  
1 row created.
```

- result: success

```
INSERT INTO t1 VALUES ( 3, 1, 3 );  
1 row created.
```

- result: success

```
INSERT INTO t1 VALUES ( 4, 4, 1 );  
1 row created.
```

- result: success
- t1_uk1, t1_uk2 constraints are DEFERRED

```
ROLLBACK TO SAVEPOINT sp3;  
Rollback complete.
```

- result: success

```
INSERT INTO t1 VALUES ( 1, 2, 2 );  
1 row created.
```

- result: success

```
INSERT INTO t1 VALUES ( 3, 1, 3 );  
1 row created.
```

- result: success

```
INSERT INTO t1 VALUES ( 4, 4, 1 );  
ERR-23000(16057): unique constraint (PUBLIC.T1_UK3) violated
```

- result: success
- t1_uk1 constraint is DEFERRED

```
ROLLBACK TO SAVEPOINT sp2;  
Rollback complete.
```

- result: success

```
INSERT INTO t1 VALUES ( 1, 2, 2 );  
1 row created.
```

- result: error

```
INSERT INTO t1 VALUES ( 3, 1, 3 );
ERR-23000(16057): unique constraint (PUBLIC.T1_UK2) violated
```

- result: error

```
INSERT INTO t1 VALUES ( 4, 4, 1 );
ERR-23000(16057): unique constraint (PUBLIC.T1_UK3) violated
```

- result: success
- all constraint are IMMEDIATE

```
ROLLBACK TO SAVEPOINT sp1;
Rollback complete.
```

- result: error

```
INSERT INTO t1 VALUES ( 1, 2, 2 );
ERR-23000(16057): unique constraint (PUBLIC.T1_UK1) violated
```

- result: error

```
INSERT INTO t1 VALUES ( 3, 1, 3 );
ERR-23000(16057): unique constraint (PUBLIC.T1_UK2) violated
```

- result: error

```
INSERT INTO t1 VALUES ( 4, 4, 1 );
ERR-23000(16057): unique constraint (PUBLIC.T1_UK3) violated
```

- result: 1 row
- 1 1 1

```
SELECT * FROM t1;
ID1 ID2 ID3
----
1 1 1
1 row selected.
```

When the transaction is committed or rolled back, the effects of SET CONSTRAINTS statement is also terminated, and all deferrable constraints follows the constraints property which is INITIALLY IMMEDIATE or INITIALLY DEFERRED value.

Examples

The following is an example of changing the check point by specifying the constraint name.

```
gSQL> SET CONSTRAINTS t1_uk1 DEFERRED;
Constraints set.
```

The following is an example of changing the check point of all deferrable constraints.

```
gSQL> SET CONSTRAINTS ALL DEFERRED;
Constraints set.
```

Compatibility

The SQL standard does not define CONSTRAINT keyword clause.

Table 16-75 SQL standard compatibility

Feature ID	Description	Compatibility
F721	Deferrable constraints	O

For More Information

Refer to the followings.

- Adding constraints
 - **CREATE TABLE**
 - **ALTER TABLE name ADD CONSTRAINT**
 - **ALTER TABLE name ADD COLUMN**
 - **ALTER TABLE name ALTER COLUMN**
- Altering constraints: **ALTER TABLE name ALTER CONSTRAINT**
- Controlling the check point of constraints: **SET CONSTRAINTS**

16.130 SET SESSION AUTHORIZATION user_identifier

Function

It sets the session user and current user.

Syntax

```
<set session user identifier statement> ::=  
    SET SESSION AUTHORIZATION user_identifier  
    ;
```

Invocation and Access Rules

ACCESS CONTROL ON DATABASE privilege is required for a logon user to perform <set session user identifier statement>.

The user information is managed in three types as follows.

- Logon user
 - It is a user who performed login, and it is maintained until the connection is closed.
- Session user
 - It is as same as the first logon user, but it can be changed using the SET SESSION AUTHORIZATION statement.
- Current user
 - It is generally as same as the session user, but it is temporarily changed internally in system to control access when using the PSM or view.
 - The session user and current user is similar to the difference between the unix system's real user and the effective user.

Syntax Rules and Parameters

user_identifier

It is the username to be altered.

Description

After performing SET SESSION AUTHORIZATION statement, all statements is performed based on the session user. Therefore, the privilege for the session user is checked and the owner of when creating objects also is the session user.

Example

The following is an example that the user test with ACCESS CONTROL ON DATABASE privilege sets the user u1 to the session user.

```
gSQL> SET SESSION AUTHORIZATION u1;
Session set.
gSQL> SELECT LOGON_USER(), SESSION_USER(), CURRENT_USER FROM dual;
LOGON_USER() SESSION_USER() CURRENT_USER
-----
TEST          U1              U1
1 row selected.
```

Compatibility

Table 16-76 SQL standard compatibility

Feature ID	Description	Compatibility
F321	User authorization	O

16.131 SET SESSION CHARACTERISTICS AS transaction_mode

Function

It sets the transaction property of a session.

Syntax

```
<set session characteristics statement> ::=  
    SET SESSION CHARACTERISTICS AS TRANSACTION <transaction_mode>  
    ;  
<transaction_mode> ::=  
    { <transaction_access_mode> | ISOLATION LEVEL < isolation_level > }  
<transaction_access_mode> ::=  
    READ { ONLY | WRITE }  
< isolation_level > ::=  
    { READ COMMITTED | SERIALIZABLE }
```

Syntax Rules and Parameters

<transaction_access_mode>

It is ACCESS MODE of the following transactions.

- READ ONLY
- READ WRITE

<isolation_level>

It is ISOLATION LEVEL of the following transactions.

- READ COMMITTED
- SERIALIZABLE

Description

SET SESSION CHARACTERISTICS sets the transaction property of a session. In other words, properties of all transactions created within the session follows these properties.

However, SET TRANSACTION `transaction_mode` statement sets only the property of a single transaction which is performed next.

Examples

The following is an example that all transactions to be created within the session are set to READ ONLY.

```
gSQL> SET SESSION CHARACTERISTICS AS TRANSACTION READ ONLY;  
Session set.
```

The following is an example that the isolation level of all transactions to be created within the session is set to READ COMMITTED.

```
gSQL> SET SESSION CHARACTERISTICS AS TRANSACTION ISOLATION LEVEL READ COMMITTED;  
Session set.
```

Compatibility

Table 16-77 SQL standard compatibility

Feature ID	Description	Compatibility
F761	Session management	O

For More Information

Refer to SET TRANSACTION `transaction_mode`.

16.132 SET TIME ZONE

Function

It sets the TIMEZONE of a session.

Syntax

```
<set local time zone statement> ::=  
    SET TIME ZONE <set time zone value>  
    ;  
<set time zone value> ::=  
    { '[+|-]hh:mm' | LOCAL }
```

Syntax Rules and Parameters

<set time zone value>

It is the TIMEZONE value to be set.

- hh:mm: It is a GMT OFFSET of the TIMEZONE to be set.
 - The range of the offset value is '-14:00' ~ '+14:00' .
- LOCAL: It is the TIME ZONE at the time of session creation.
 - TIME ZONE at the time of session creation is set to TIME ZONE of the client OS.

Description

Altering the time zone of the session affects the result value of function such as **CURRENT_TIME**, **CURRENT_TIMESTAMP**.

Example

The following is an example of altering the session time zone to '+09:00'.

```
gSQL> SET TIME ZONE '+09:00';  
Session set.
```

Compatibility

Table 16-78 SQL standard compatibility

Feature ID	Description	Compatibility
F411	Time zone specifications	O

16.133 SET TRANSACTION transaction_mode

Function

It sets the transaction property.

Syntax

```
<set transaction statement> ::=  
    SET TRANSACTION <transaction_mode>  
    ;  
<transaction_mode> ::=  
    { <transaction_access_mode> | ISOLATION LEVEL < isolation_level > }  
<transaction_access_mode> ::=  
    READ { ONLY | WRITE }  
< isolation_level > ::=  
    { READ COMMITTED | SERIALIZABLE }
```

Syntax Rules and Parameters

<transaction_access_mode>

It is ACCESS MODE of the following transactions.

- READ ONLY
- READ WRITE

<isolation_level>

It is ISOLATION LEVEL of the following transactions.

- READ COMMITTED
- SERIALIZABLE

Description

SET TRANSACTION sets property of the next transaction, and the property is reset to the default value after the next transaction ends.

Example

The following is an example of setting the next transaction to READ ONLY.

```
gSQL> SET TRANSACTION READ ONLY;  
Transaction set.
```

Compatibility

Table 16-79 SQL standard compatibility

Feature ID	Description	Compatibility
T251	SET TRANSACTION statement: LOCAL option	X

For More Information

Refer to SET SESSION CHARACTERISTICS AS transaction_mode.

16.134 TRUNCATE TABLE

Function

It truncates all rows from a table.

Syntax

```
<truncate table statement> ::=  
    TRUNCATE TABLE table_name  
        [ RESTART IDENTITY | CONTINUE IDENTITY ]  
        [ DROP STORAGE | DROP ALL STORAGE ]  
    ;
```

Invocation and Access Rules

One of the following privileges is required for a user to perform <truncate table statement>.

- The owner of that table
- CONTROL TABLE ON TABLE for the table
- (DROP TABLE or CONTROL SCHEMA) ON SCHEMA for the schema to which the table belongs
- DROP ANY TABLE ON DATABASE

Syntax Rules and Parameters

table_name

It is the name of a target table whose rows are to be truncated.

It can define schema to which the table belongs such as schema_name.table_name and if schema_name is omitted, the default schema name of the user performing the statement is used.

[RESTART IDENTITY | CONTINUE IDENTITY]

- RESTART IDENTITY
 - If an identity column which has auto created value in that table exists, it automatically restarts value.
- CONTINUE IDENTITY
 - If an identity column which has auto created value in that table exists, it does not change the existing value.
- If it is not specified, the default value is CONTINUE IDENTITY.

[DROP STORAGE | DROP ALL STORAGE]

- DROP STORAGE
 - It drops allocated extents from the the table excluding the space of MINSIZE.
- DROP ALL STORAGE
 - It drops all extents allocated to the table.
- If it is not specified, the default value is DROP STORAGE.

Description

Data Definition Language (DDL) statement such as TRUNCATE TABLE can be rolled back if it is before when the transaction is committed.

Examples

The following is an example of performing TRUNCATE TABLE statement.

```
gSQL> TRUNCATE TABLE t1;  
Table truncated.
```

The following is an example of restarting the value of the identity column when performing TRUNCATE TABLE.

```
TRUNCATE TABLE t1 RESTART IDENTITY;  
Table truncated.
```

Compatibility

The SQL standard does not define [DROP STORAGE | DROP ALL STORAGE] clause.

Table 16-80 SQL standard compatibility

Feature ID	Description	Compatibility
F200	TRUNCATE TABLE statement	O
F202	TRUNCATE TABLE: identity column restart option	O

16.135 UPDATE

Function

It updates rows in a table.

Syntax

```

<update statement: searched> ::=
    UPDATE table_name [ [ AS ] alias_name ]
        SET <set clause> [, ...]
        [ WHERE <search condition> ]
        [ <result offset clause> ]
        [ <fetch limit clause> ]
    ;
<set clause> ::=
    column_name = { <value expression> | DEFAULT }
    | ( column_name [, ...] ) = ( { <value expression> | DEFAULT } [, ...] )
    | ( column_name [, ...] ) = ( <query expression> )
<result offset clause> ::=
    OFFSET skip_count [ ROW | ROWS ]
<fetch limit clause> ::=
    <fetch first clause>
    | <limit clause>
<fetch first clause> ::=
    FETCH [ FIRST | NEXT ] [ row_count ] [ ROW ONLY | ROWS ONLY ]
<limit clause>
    LIMIT { fetch_row_count | offset_row_count, fetch_row_count | ALL }

```

Invocation and Access Rules

One of the following privileges is required for a user to perform <update statement: searched>.

- UPDATE(columns) ON TABLE for all columns which are targets to be updated
- (UPDATE or CONTROL TABLE) ON TABLE for the table

- (UPDATE TABLE or CONTROL SCHEMA) ON SCHEMA for the schema to which the table belongs
- UPDATE ANY TABLE ON DATABASE

Syntax Rules and Parameters

table_name

It is the name of a target table whose rows are to be updated.

It can define schema to which the table belongs such as schema_name.table_name and if schema_name is omitted, the default schema name of the user performing the statement is used.

[AS alias_name]

It is the alias of table_name.

<set clause>

It defines the columns to be updated and its values to be assigned. The number of columns in <set clause > should be as same as the number of values.

It can be defined as follows.

- column_name = { <value expression> | DEFAULT }

```
UPDATE table_name
  SET column1 = value1, column2 = value2, column3 = value3
```

- (column_name [, ...]) = ({ <value expression> | DEFAULT } [, ...])

```
UPDATE table_name
  SET ( column1, column2, column3 ) = ( value1, value2, value3 )
```

- (column_name [, ...]) = (<query expression>)

```
UPDATE table_name
  SET column1 = ( SELECT max(value1) FROM other_table_name )
```

<query expression> should be a query which creates a single row.

If DEFAULT is defined as a column value, the default values (refer to **<default clause>**) defined when executing CREATE TABLE is used. If it is not defined, NULL value is assigned.

WHERE <search condition>

It updates the rows which satisfy WHERE condition.

If WHERE condition is not specified, all rows are updated.

For more information about WHERE condition, refer to **where clause** of SELECT.

<result offset clause>

It specifies the number of rows to skip from the query result.

For more information, refer to **<result offset clause>** of SELECT.

<fetch limit clause>

It specifies the number of rows to fetch in two ways, which are **<fetch first clause>** and **<limit clause>**.

- **<fetch first clause>**
 - It specifies the number of rows to be fetched.
 - For more information, refer to **<fetch first clause>** of SELECT statement.
- **<limit clause>**
 - It specifies the number of rows to be fetched, or it simultaneously specifies both the number of rows to be skipped and the number of rows to be fetched.
 - For more information, refer to **<limit clause>** of SELECT statement.

Description

Differences among UPDATE-related Statements

- **UPDATE**
 - It updates multiple rows which satisfy the condition.
 - e.g. UPDATE t1 SET c2 = c2 + 1 WHERE c1 > 0;
- **UPDATE name WHERE CURRENT OF cursor_name**
 - It updates the row which the current cursor indicates.
 - e.g. UPDATE t1 WHERE CURRENT OF cursor;
- **UPDATE name RETURNING**
 - It updates multiple rows which satisfy the conditions, and the updated rows can be retrieved in the same way as SELECT statement (API such as SQLFetch ()).

- e.g. UPDATE t1 SET c2 = c2 + 1 WHERE c1 > 0 RETURNING c2;
- **UPDATE name RETURNING .. INTO**
 - It updates row equal to or less than one, and if a single row is updated, it obtains the value to the host variable of RETURNING INTO clause.
 - e.g. UPDATE t1 SET c2 = c2 + 1 WHERE c1 = 0 RETURNING c2 INTO :v1;

Examples

The following is an example of updating multiple rows which satisfy the condition.

```
gSQL> UPDATE lineitem
      SET l_shipdate = CURRENT_DATE
      WHERE l_returnflag = 'R';
5 rows updated.
```

The following is an example of updating the value of multiple columns.

```
gSQL> UPDATE lineitem
      SET l_shipdate = CURRENT_DATE
        , l_returnflag = 'A'
      WHERE l_returnflag = 'R';
5 rows updated.
```

The following is an example of updating multiple columns by enclosing them with parentheses.

```
gSQL> UPDATE lineitem
      SET ( l_shipdate , l_returnflag )
        = ( CURRENT_DATE, 'A' )
      WHERE l_returnflag = 'R';
5 rows updated.
```

The following is an example of updating the column value by using the subquery.

```
gSQL> UPDATE lineitem
      SET l_discount = ( SELECT MAX(l_discount) + 0.01 FROM lineitem )
      WHERE l_returnflag = 'R';
5 rows updated.
```

The following is an example of updating part of the rows which satisfy the condition by using OFFSET and FETCH clauses.

```
gSQL> UPDATE lineitem
      SET l_discount = l_discount + 0.01
      WHERE l_returnflag = 'R'
      OFFSET 3
      FETCH 2;
2 rows updated.
```

Compatibility

The SQL standard does not define the following clauses in UPDATE statement.

- <result offset clause>
- <fetch limit clause>

Table 16-81 SQL standard compatibility

Feature ID	Description	Compatibility
F781	Self-referencing operations	X
T111	Updatable joins, unions, and columns	X

16.136 UPDATE name RETURNING

Function

It updates rows in a table, and retrieves the rows of before or after the update.

Syntax

```

<update statement: searched> ::=
    UPDATE table_name [ [ AS ] alias_name ]
        SET <set clause> [, ...]
        [ WHERE <search condition> ]
        [ <result offset clause> ]
        [ <fetch limit clause> ]
        <returning clause>

<set clause> ::=
    column_name = { <value expression> | DEFAULT }
    | ( column_name [, ...] ) = ( { <value expression> | DEFAULT } [, ...] )
    | ( column_name [, ...] ) = ( <query expression> )

<result offset clause> ::=
    OFFSET skip_count [ ROW | ROWS ]

<fetch limit clause> ::=
    <fetch first clause>
    | <limit clause>

<fetch first clause> ::=
    FETCH [ FIRST | NEXT ] [ row_count ] [ ROW ONLY | ROWS ONLY ]

<limit clause>
    LIMIT { fetch_row_count | offset_row_count, fetch_row_count | ALL }

<returning clause> ::=
    { RETURN | RETURNING } [ NEW | OLD ] { * | { <value expression> [ [AS] alias_name ] } [,
... ] }

```

Invocation and Access Rules

The user should satisfy the following conditions to perform <update returning query statement>.

- One of the following privileges is required to perform UPDATE statement.
 - UPDATE(columns) ON TABLE for all columns which are targets to be updated
 - (UPDATE or CONTROL TABLE) ON TABLE for the table
 - (UPDATE TABLE or CONTROL SCHEMA) ON SCHEMA for the schema to which the table belongs
 - UPDATE ANY TABLE ON DATABASE
- One of the following privileges for all columns used in RETURNING clause is required.
 - SELECT(columns) ON TABLE for all columns used in RETURNING clause
 - (SELECT or CONTROL TABLE) ON TABLE for the table
 - (SELECT TABLE or CONTROL SCHEMA) ON SCHEMA for the schema to which the table belongs
 - SELECT ANY TABLE ON DATABASE

Syntax Rules and Parameters

table_name

It is the name of a target table whose rows are to be updated.

[AS alias_name]

It is the alias of table_name.

<set clause>

It defines the columns to be updated and its values to be assigned. The number of columns in <set clause > should be as same as the number of values.

For more information, refer to **UPDATE**.

WHERE <search condition>

It updates the rows which satisfy WHERE condition.

If WHERE condition is not specified, all rows are updated.

For more information about WHERE condition, refer to **where clause** of **SELECT**.

⟨result offset clause⟩

It specifies the number of rows to skip from the query result.
For more information, refer to ⟨result offset clause⟩ of SELECT.

⟨fetch limit clause⟩

It specifies the number of rows to fetch in two ways, which are ⟨fetch first clause⟩ and ⟨limit clause⟩.

- ⟨fetch first clause⟩
 - It specifies the number of rows to be fetched.
 - For more information, refer to ⟨fetch first clause⟩ of SELECT statement.
- ⟨limit clause⟩
 - It specifies the number of rows to be fetched, or it simultaneously specifies both the number of rows to be skipped and the number of rows to be fetched.
 - For more information, refer to ⟨limit clause⟩ of SELECT statement.

⟨returning clause⟩

It defines the updated rows as a result set, and specifies columns to be retrieved from the result set.

- RETURN and RETURNING are the keywords with the same meaning.
- NEW | OLD
 - NEW: It searches for updated rows based on the row after the update.
 - OLD: It searches for updated rows based on the row before the update.
 - If it is omitted, the default value is NEW.
- ⟨value expression⟩
 - It is as same as ⟨select list⟩ in SELECT statement, but aggregation can not be used.
- [[AS] alias_name]
 - It can name ⟨value expression⟩ by using AS clause.

Description

For more information, refer to **Differences among UPDATE-related Statements**.

Examples

The following is an example of obtaining values of the updated rows by using RETURNING clause.

```
gSQL> UPDATE lineitem
      SET l_discount = l_discount + 0.01
      WHERE l_returnflag = 'R'
      RETURNING l_orderkey, l_linenum, l_discount;
```

L_ORDERKEY	L_LINENUMBER	L_DISCOUNT
8	1	.07
9	2	.11
12	5	.05
15	1	.03
16	2	.08

5 rows updated.

The following is an example of obtaining values before the update for the updated rows by using RETURNING OLD clause.

```
gSQL> UPDATE lineitem
      SET l_discount = l_discount + 0.01
      WHERE l_returnflag = 'R'
      RETURNING OLD l_orderkey, l_linenum, l_discount;
```

L_ORDERKEY	L_LINENUMBER	L_DISCOUNT
8	1	.06
9	2	.1
12	5	.04
15	1	.02
16	2	.07

5 rows updated.

Compatibility

The SQL standard does not define <update returning query statement>.

16.137 UPDATE name RETURNING .. INTO

Function

It updates a single row of a table, and the updated value is obtained into the host variable.

Syntax

```

<update statement: searched> ::=
    UPDATE table_name [ [ AS ] alias_name ]
        SET <set clause> [, ...]
        [ WHERE <search condition> ]
        [ <result offset clause> ]
        [ <fetch limit clause> ]
        <returning into clause>
    ;
<set clause> ::=
    column_name = { <value expression> | DEFAULT }
    | ( column_name [, ...] ) = ( { <value expression> | DEFAULT } [, ...] )
    | ( column_name [, ...] ) = ( <query expression> )
<result offset clause> ::=
    OFFSET skip_count [ ROW | ROWS ]
<fetch limit clause> ::=
    <fetch first clause>
    | <limit clause>
<fetch first clause> ::=
    FETCH [ FIRST | NEXT ] [ row_count ] [ ROW ONLY | ROWS ONLY ]
<limit clause>
    LIMIT { fetch_row_count | offset_row_count, fetch_row_count | ALL }
<returning into clause> ::=
    { RETURN | RETURNING } [ NEW | OLD ] { * | { <value expression> [ [AS] alias_name] } [,
... ] } INTO variable_name [, ...]

```

Invocation and Access Rules

The user should satisfy the following conditions to perform <update returning query statement>.

- One of the following privileges is required to perform UPDATE statement.
 - UPDATE(columns) ON TABLE for all columns which are targets to be updated
 - (UPDATE or CONTROL TABLE) ON TABLE for the table
 - (UPDATE TABLE or CONTROL SCHEMA) ON SCHEMA for the schema to which the table belongs
 - UPDATE ANY TABLE ON DATABASE
- One of the following privileges for all columns used in RETURNING clause is required.
 - SELECT(columns) ON TABLE for all columns used in RETURNING clause
 - (SELECT or CONTROL TABLE) ON TABLE for the table
 - (SELECT TABLE or CONTROL SCHEMA) ON SCHEMA for the schema to which the table belongs
 - SELECT ANY TABLE ON DATABASE

Syntax Rules and Parameters

table_name

It is the name of a target table whose rows are to be updated.

[AS alias_name]

It is the alias of table_name.

<set clause>

It defines the columns to be updated and its values to be assigned. The number of columns in <set clause > should be as same as the number of values.

For more information, refer to **UPDATE**.

WHERE <search condition>

It updates the rows which satisfy WHERE condition.

If WHERE condition is not specified, all rows are updated.

For more information about WHERE condition, refer to **where clause** of **SELECT**.

⟨result offset clause⟩

It specifies the number of rows to skip in the query result.

For more information, refer to ⟨result offset clause⟩ of SELECT.

⟨fetch limit clause⟩

It specifies the number of rows to fetch in two ways, which are ⟨fetch first clause⟩ and ⟨limit clause⟩.

- ⟨fetch first clause⟩
 - It specifies the number of rows to be fetched.
 - For more information, refer to ⟨fetch first clause⟩ of SELECT statement.
- ⟨limit clause⟩
 - It specifies the number of rows to be fetched, or it simultaneously specifies both the number of rows to be skipped and the number of rows to be fetched.
 - For more information, refer to ⟨limit clause⟩ of SELECT statement.

RETURNING .. AS ..

It defines the updated rows as a result set, and specifies columns to be retrieved from the result set.

For more information, refer to ⟨returning clause⟩ of UPDATE name RETURNING.

INTO variable_name [, ...]

The number of variables specified in INTO clause should be equal to the number of the expressions specified in RETURNING clause.

The row to be updated should be one or less. If two or more rows are updated, an error occurs.

Description

For more information, refer to **Differences among UPDATE-related Statements**.

Example

The following is an example of obtaining column values of the updated rows into the host variables.

- Declare the host variable.

```
gSQL> \VAR v_discount NUMBER
gSQL> UPDATE lineitem
      SET l_discount = l_discount + 0.01
      WHERE l_orderkey = 12 AND l_linenumber = 5
      RETURNING l_discount INTO :v_discount;
V_DISCOUNT
-----
          .05
1 row updated.
```

Compatibility

In the SQL standard, <update returning into statement> statement does not exist.

16.138 UPDATE name WHERE CURRENT OF cursor_name

Function

It updates a single row which the current cursor indicates.

Syntax

```
<update statement: positioned> ::=  
    UPDATE table_name [ [ AS ] alias_name ]  
        SET <set clause> [, ...]  
        WHERE CURRENT OF cursor_name  
    ;
```

Invocation and Access Rules

The user should satisfy the following conditions to perform <update statement: positioned>.

- One of the following privileges is required to perform UPDATE statement.
 - UPDATE(columns) ON TABLE for all columns which are targets to be updated
 - (UPDATE or CONTROL TABLE) ON TABLE for the table
 - (UPDATE TABLE or CONTROL SCHEMA) ON SCHEMA for the schema to which the table belongs
 - UPDATE ANY TABLE ON DATABASE

Syntax Rules and Parameters

table_name

It is the name of a table whose rows are to be updated.

[AS alias_name]

It is the alias of table_name.

<set clause>

It defines the columns to be updated and its values to be assigned. The number of columns in <set clause> should be as same as the number of values.

For more information, refer to **UPDATE**.

cursor_name

The cursor corresponding to cursor_name should satisfy the following conditions.

- The cursor should be OPEN. (Refer to **OPEN cursor_name**.)
- Fetched rows by using the cursor should exist. (Refer to **FETCH cursor_name**.)
- The query used for the cursor should identify table_name. (Refer to **DECLARE cursor_name**.)
- The cursor should be updatable for table_name. (Refer to **DECLARE cursor_name**.)

Description

For more information, refer to **Differences among UPDATE-related Statements**.

Examples

The following is an example that <update statement: positioned> is performed in interactive SQL (gsql) using the cursor.

- Declare the host variable.

```
gSQL> \VAR v_discount NUMBER
```

- Declare the cursor.

```
gSQL> DECLARE update_cursor CURSOR FOR
      SELECT l_discount
      FROM lineitem
      WHERE l_orderkey = 8 AND l_linenumber = 1
```

```
FOR UPDATE;
```

Cursor declared.

- Open the cursor.

```
gSQL> OPEN update_cursor;
```

Cursor is open.

- Fetch the row.

```
gSQL> FETCH update_cursor INTO :v_discount;
```

```
V_DISCOUNT
```

```
-----
```

```
      .06
```

1 row fetched.

- Update the current row.

```
gSQL> UPDATE lineitem
```

```
      SET l_discount = l_discount + 0.01
```

```
      WHERE CURRENT OF update_cursor;
```

1 row updated.

- Close the cursor.

```
gSQL> CLOSE update_cursor;
```

Cursor closed.

```
gSQL> COMMIT;
```

Commit complete.

The following is an example of performing `<update statement: positioned>` by using the cursor in embedded SQL program.

```
{
    ...
    EXEC SQL BEGIN DECLARE SECTION;
        ...
        double v_discount;
        ...
    EXEC SQL END DECLARE SECTION;
    ...
    EXEC SQL DECLARE update_cursor CURSOR FOR
```

```

        SELECT l_discount
        FROM lineitem
        WHERE l_orderkey = 8 AND l_linenumber = 1
        FOR UPDATE;
    ...
EXEC SQL OPEN update_cursor;
    ...
EXEC SQL FETCH NEXT update_cursor INTO :v_discount;
    ...
EXEC SQL UPDATE lineitem
        SET l_discount = l_discount + 0.01
        WHERE CURRENT OF update_cursor;
    ...
EXEC SQL CLOSE update_cursor;
    ...
EXEC SQL COMMIT WORK;
    ...
}

```

Compatibility

Table 16-82 SQL standard compatibility

Feature ID	Description	Compatibility
F831	Full cursor update	O
B031	Basic dynamic SQL	O

For More Information

Refer to `CLOSE cursor_name`.

Part IV.

PSM Manual

17. Overview of PSM	2,135
17.1 Features of PSM	2,136
Closely Interworking with SQL	2,136
Improving Performance	2,136
Improving Productivity	2,136
Portability	2,136
Easy Maintenance	2,137
17.2 Language Elements	2,138
Data Types	2,138
Variables	2,138
Control Structures	2,138
Subprograms	2,138
17.3 Processing Transaction in PSM	2,139
18. PSM DataTypes	2,141
18.1 Built-in Data Types	2,142
Numeric Types	2,142
CHARACTER STRING Types	2,142
BINARY STRING Type	2,142
DATE/TIME Type	2,143
INTERVAL Type	2,143
BOOLEAN Type	2,143
ROWID Type	2,143
Declaring Built-in Data Type Variables	2,143
18.2 Attribute Data Types	2,145
%TYPE	2,145
%ROWTYPE	2,145
Constraint Attributes Inheritance	2,146
18.3 User-defined Record Type	2,147
18.4 User-defined Collection Type	2,149
Associative Array	2,149
Assign Values to Collection Variables	2,151
Collection Method	2,154
18.5 SYS_REFCURSOR	2,157
19. PSM Control Statements	2,159
19.1 Assignment	2,160
Assignment Target	2,160
Assigning Expression	2,160
Assignment Compatibility	2,162

19.2	PL Block	2,164
	PL Block Configuration	2,164
19.3	NULL Statement	2,167
19.4	Testing Conditions	2,168
	IF	2,168
	CASE	2,169
19.5	Iterative Control	2,171
	Basic Loop	2,171
	FOR Loop	2,172
	WHILE Loop	2,173
19.6	Sequential Control	2,174
	GOTO	2,174
	CONTINUE	2,177
	EXIT	2,178
19.7	Error Handling	2,180
	Errors at Compile Time	2,180
	Errors at Run-time	2,182
	Cursor Attributes	2,183
	EXCEPTION Handling	2,186
	PRAGMA EXCEPTION_INIT	2,191
	DBMS_STANDARD.RAISE_APPLICATION_ERROR	2,193
20.	PSM Cursor Statements	2,195
20.1	Declaration	2,196
20.2	OPEN	2,200
20.3	FETCH	2,201
20.4	CLOSE	2,203
20.5	EXPLICIT CURSOR ATTRIBUTES	2,204
20.6	IMPLICIT_CURSOR_ATTRIBUTES	2,206
20.7	CURSOR VARIABLES	2,208
	OPEN and Close Cursor Variables	2,210
	Fetching Data With Cursor Variables	2,211
	Assign Values to Cursor Variables	2,211
21.	Using PSM Subprograms	2,215
21.1	Anonymous PL Block	2,216
21.2	Nested Procedure	2,217
21.3	Nested Function	2,219
21.4	Schema-level Procedure	2,220
	Creating Schema-level Procedure	2,220
	Using Schema-level Procedure	2,221

Dropping Schema-level Procedure	2,223
Recompiling Schema-level Procedure	2,223
21.5 Schema-level Function	2,225
Creating Schema-level Function	2,225
Using Schema-level Function	2,225
Dropping Schema-level Function	2,226
21.6 Built-in Procedures	2,228
22. Using SQLs in PSM	2,231
22.1 Static SQLs	2,232
SELECT	2,232
INSERT	2,236
UPDATE	2,239
DELETE	2,240
RETURNING INTO	2,241
COMMIT, ROLLBACK, SAVEPOINT	2,246
22.2 Dynamic SQL	2,249
EXECUTE IMMEDIATE	2,249
OPEN FOR, FETCH and CLOSE	2,251
23. PSM Language Element References	2,255
23.1 Assignment Statement	2,256
Function	2,256
Syntax	2,256
Invocation and Access Rules	2,256
Syntax Rules and Parameters	2,256
Description	2,257
Examples	2,257
Compatibility	2,258
For More Information	2,259
23.2 Basic LOOP Statement	2,260
Function	2,260
Syntax	2,260
Invocation and Access Rules	2,260
Syntax Rules and Parameters	2,260
Description	2,260
Examples	2,261
Compatibility	2,261
For More Information	2,261
23.3 Block (BEGIN .. END)	2,262
Function	2,262

Syntax	2,262
Invocation and Access Rules	2,262
Syntax Rules and Parameters	2,263
Description	2,263
Examples	2,263
Compatibility	2,264
For More Information	2,264
23.4 CASE Statement	2,265
Function	2,265
Syntax	2,265
Invocation and Access Rules	2,265
Syntax Rules and Parameters	2,266
Description	2,266
Examples	2,266
Compatibility	2,267
23.5 CLOSE Statement	2,268
Function	2,268
Syntax	2,268
Invocation and Access Rules	2,268
Syntax Rules and Parameters	2,268
Description	2,268
Examples	2,269
Compatibility	2,269
For More Information	2,269
23.6 Collection Method Invocation	2,270
Function	2,270
Syntax	2,270
Invocation and Access Rules	2,270
Syntax Rules and Parameters	2,270
Description	2,271
Examples	2,271
For More Information	2,273
23.7 COLLECTION Variable Declaration	2,274
Function	2,274
Syntax	2,274
Invocation and Access Rules	2,274
Syntax Rules and Parameters	2,275
Description	2,275
Examples	2,275

Compatibility	2,277
For More Information	2,277
23.8 CONTINUE Statement	2,278
Function	2,278
Syntax	2,278
Invocation and Access Rules	2,278
Syntax Rules and Parameters	2,278
Description	2,279
Examples	2,279
Compatibility	2,280
For More Information	2,280
23.9 Cursor FOR LOOP Statement	2,281
Function	2,281
Syntax	2,281
Invocation and Access Rules	2,281
Syntax Rules and Parameters	2,282
Description	2,282
Examples	2,282
For More Information	2,284
23.10 Cursor Variable Declaration	2,285
Function	2,285
Syntax	2,285
Invocation and Access Rules	2,285
Syntax Rules and Parameters	2,285
Description	2,285
Examples	2,286
For More Information	2,286
23.11 DELETE Statement Extension	2,287
Function	2,287
Syntax	2,287
Invocation and Access Rules	2,288
Syntax Rules and Parameters	2,288
Description	2,288
Examples	2,288
For More Information	2,289
23.12 EXCEPTION_INIT Pragma	2,290
Function	2,290
Syntax	2,290
Invocation and Access Rules	2,290

Syntax Rules and Parameters	2,290
Description	2,290
Examples	2,291
Compatibility	2,291
For More Information	2,291
23.13 Exception Declaration	2,292
Function	2,292
Syntax	2,292
Invocation and Access Rules	2,292
Syntax Rules and Parameters	2,292
Description	2,292
Examples	2,292
Compatibility	2,293
For More Information	2,293
23.14 Exception Handler	2,294
Function	2,294
Syntax	2,294
Invocation and Access Rules	2,294
Syntax Rules and Parameters	2,294
Description	2,295
Examples	2,295
Compatibility	2,296
For More Information	2,296
23.15 EXECUTE IMMEDIATE Statement	2,297
Function	2,297
Syntax	2,297
Invocation and Access Rules	2,297
Syntax Rules and Parameters	2,298
Description	2,299
Examples	2,300
23.16 EXIT Statement	2,301
Function	2,301
Syntax	2,301
Invocation and Access Rules	2,301
Syntax Rules and Parameters	2,301
Description	2,301
Examples	2,302
Compatibility	2,302
23.17 Explicit Cursor Attribute	2,303

Function	2,303
Syntax	2,303
Invocation and Access Rules	2,303
Syntax Rules and Parameters	2,303
Description	2,303
Examples	2,304
Compatibility	2,305
23.18 Explicit Cursor Declaration and Definition	2,306
Function	2,306
Syntax	2,306
Invocation and Access Rules	2,306
Syntax Rules and Parameters	2,306
Description	2,307
Examples	2,308
Compatibility	2,309
For More Information	2,309
23.19 FETCH Statement	2,310
Function	2,310
Syntax	2,310
Invocation and Access Rules	2,310
Syntax Rules and Parameters	2,310
Description	2,311
Examples	2,311
Compatibility	2,312
For More Information	2,312
23.20 FOR LOOP Statement	2,313
Function	2,313
Syntax	2,313
Invocation and Access Rules	2,313
Syntax Rules and Parameters	2,313
Description	2,314
Examples	2,314
Compatibility	2,314
For More Information	2,315
23.21 Function Declaration and Definition	2,316
Function	2,316
Syntax	2,316
Invocation and Access Rules	2,316
Syntax Rules and Parameters	2,316

Description	2,317
Examples	2,317
Compatibility	2,318
For More Information	2,318
23.22 GOTO Statement	2,319
Function	2,319
Syntax	2,319
Invocation and Access Rules	2,319
Syntax Rules and Parameters	2,319
Description	2,319
Examples	2,320
Compatibility	2,320
For More Information	2,320
23.23 IF Statement	2,321
Function	2,321
Syntax	2,321
Invocation and Access Rules	2,321
Syntax Rules and Parameters	2,321
Description	2,322
Examples	2,322
Compatibility	2,322
23.24 Implicit Cursor Attribute	2,323
Function	2,323
Syntax	2,323
Invocation and Access Rules	2,323
Description	2,323
Examples	2,323
Compatibility	2,324
23.25 INSERT Statement Extension	2,325
Function	2,325
Syntax	2,325
Invocation and Access Rules	2,325
Syntax Rules and Parameters	2,326
Description	2,326
Examples	2,326
Compatibility	2,327
23.26 NULL Statement	2,328
Function	2,328
Syntax	2,328

Invocation and Access Rules	2,328
Description	2,328
Examples	2,328
Compatibility	2,329
23.27 OPEN Statement	2,330
Function	2,330
Syntax	2,330
Invocation and Access Rules	2,330
Syntax Rules and Parameters	2,330
Description	2,330
Examples	2,331
Compatibility	2,331
For More Information	2,332
23.28 OPEN FOR Statement	2,333
Function	2,333
Syntax	2,333
Invocation and Access Rules	2,333
Syntax Rules and Parameters	2,333
Description	2,333
Examples	2,334
Compatibility	2,335
For More Information	2,335
23.29 Procedure Call	2,336
Function	2,336
Syntax	2,336
Invocation and Access Rules	2,336
Syntax Rules and Parameters	2,336
Description	2,337
Examples	2,337
Compatibility	2,338
23.30 Procedure Declaration and Definition	2,339
Function	2,339
Syntax	2,339
Invocation and Access Rules	2,339
Syntax Rules and Parameters	2,339
Description	2,340
Examples	2,340
Compatibility	2,340
For More Information	2,340

23.31	RAISE Statement	2,341
	Function	2,341
	Syntax	2,341
	Invocation and Access Rules	2,341
	Syntax Rules and Parameters	2,341
	Description	2,341
	Examples	2,342
	Compatibility	2,343
	For More Information	2,343
23.32	Record Variable Declaration	2,344
	Function	2,344
	Syntax	2,344
	Invocation and Access Rules	2,344
	Syntax Rules and Parameters	2,344
	Description	2,345
	Examples	2,345
	Compatibility	2,345
23.33	RETURN Statement	2,346
	Function	2,346
	Syntax	2,346
	Invocation and Access Rules	2,346
	Syntax Rules and Parameters	2,346
	Description	2,346
	Examples	2,347
	Compatibility	2,347
23.34	RETURNING INTO clause	2,348
	Function	2,348
	Syntax	2,348
	Invocation and Access Rules	2,348
	Syntax Rules and Parameters	2,348
	Description	2,348
	Examples	2,349
	Compatibility	2,349
23.35	%ROWTYPE Attribute	2,350
	Function	2,350
	Syntax	2,350
	Invocation and Access Rules	2,350
	Syntax Rules and Parameters	2,350
	Description	2,350

Examples	2,351
Compatibility	2,351
23.36 Scalar Variable Declaration	2,352
Function	2,352
Syntax	2,352
Invocation and Access Rules	2,352
Syntax Rules and Parameters	2,352
Description	2,353
Examples	2,353
Compatibility	2,354
23.37 SELECT INTO Statement	2,355
Function	2,355
Syntax	2,355
Invocation and Access Rules	2,355
Syntax Rules and Parameters	2,355
Description	2,355
Examples	2,356
Compatibility	2,356
23.38 SQLCODE Function	2,357
Function	2,357
Syntax	2,357
Invocation and Access Rules	2,357
Syntax Rules and Parameters	2,357
Description	2,357
Examples	2,357
Compatibility	2,358
23.39 SQLERRM Function	2,359
Function	2,359
Syntax	2,359
Invocation and Access Rules	2,359
Syntax Rules and Parameters	2,359
Description	2,359
Examples	2,359
Compatibility	2,360
23.40 %TYPE Attribute	2,361
Function	2,361
Syntax	2,361
Invocation and Access Rules	2,361
Syntax Rules and Parameters	2,361

Description	2,361
Examples	2,362
Compatibility	2,362
23.41 UPDATE Statement Extension	2,363
Function	2,363
Syntax	2,363
Invocation and Access Rules	2,364
Syntax Rules and Parameters	2,364
Description	2,364
Examples	2,364
Compatibility	2,365
23.42 WHILE LOOP Statement	2,366
Function	2,366
Syntax	2,366
Invocation and Access Rules	2,366
Syntax Rules and Parameters	2,366
Description	2,366
Examples	2,367
Compatibility	2,367
For More Information	2,367
24. PSM SQL References	2,369
24.1 ALTER FUNCTION	2,370
Function	2,370
Syntax	2,370
Invocation and Access Rules	2,370
Syntax Rules and Parameters	2,370
Description	2,370
Examples	2,371
Compatibility	2,371
For More Information	2,371
24.2 ALTER PROCEDURE	2,372
Function	2,372
Syntax	2,372
Invocation and Access Rules	2,372
Syntax Rules and Parameters	2,372
Description	2,372
Examples	2,373
Compatibility	2,373
For More Information	2,374

24.3 CALL Statement	2,375
Function	2,375
Syntax	2,375
Invocation and Access Rules	2,375
Syntax Rules and Parameters	2,375
Description	2,376
Examples	2,376
Compatibility	2,377
24.4 CREATE FUNCTION	2,378
Function	2,378
Syntax	2,378
Invocation and Access Rules	2,378
Syntax Rules and Parameters	2,379
Description	2,380
Examples	2,380
Compatibility	2,381
For More Information	2,382
24.5 CREATE PROCEDURE	2,383
Function	2,383
Syntax	2,383
Invocation and Access Rules	2,383
Syntax Rules and Parameters	2,384
Description	2,385
Examples	2,385
Compatibility	2,386
For More Information	2,387
24.6 DROP FUNCTION	2,388
Function	2,388
Syntax	2,388
Invocation and Access Rules	2,388
Syntax Rules and Parameters	2,388
Description	2,389
Examples	2,389
Compatibility	2,389
For More Information	2,389
24.7 DROP PROCEDURE	2,391
Function	2,391
Syntax	2,391
Invocation and Access Rules	2,391

Syntax Rules and Parameters	2,391
Description	2,392
Examples	2,392
Compatibility	2,392
For More Information	2,393

17.

Overview of PSM

17.1 Features of PSM

Closely Interworking with SQL

GOLDILOCKS PSM can closely interworks with GOLDILOCKS SQL.

- It supports all data types supported by GOLDILOCKS SQL.
- It supports an attribute type (%TYPE, %ROWTYPE), so a flexible tables and column types are available.
- It supports all operators and built-in functions supported by GOLDILOCKS SQL.
- It supports all DML, DCL (COMMIT/ROLLBACK) supported by GOLDILOCKS SQL.
- It supports SQL SELECT statements by declaring a cursor and using OPEN, FETCH, CLOSE statements.
- It supports SQL DDL statements through the dynamic SQL feature.

Improving Performance

GOLDILOCKS PSM is operated only within a server, so it reduces the number of communications between the user application and the DBMS server. Therefore, the overall performance is improved.

Improving Productivity

The language of GOLDILOCKS PSM is quite similar to that of script, a less effort is required to write a code for the desired feature. The time of writing a client application can be reduced if the procedure and function is created by modularizing the user's work logic.

Portability

Procedures and functions created by GOLDILOCKS PSM can also be used in ODBC, JDBC, an embedded SQL, and various development tools in the same way. Also, it can be easily transplanted in a different platform regardless of the platform type of server or a client.

Easy Maintenance

GOLDILOCKS PSM is implemented into a single module in a server from each similar logics in separate clients. Therefore, it is easy to manage, and enable to modify when it is in need even during the module is in use.

17.2 Language Elements

Data Types

GOLDILOCKS PSM provides all built-in data types provided by GOLDILOCKS SQL, and it even supports user defined records and collection types.

For more information, refer to **PSM DataTypes**.

Variables

Required variables declared by a user in GOLDILOCKS PSM can be used in all expressions.

For more information, refer to the followings.

- **Declarative Part**
- **Assignment**

Control Structures

GOLDILOCKS PSM supports most of decision branch statements, unconditional branch statements (GOTO), loop statement for repeated executions which were provided by a general script language.

For more information, refer to **PSM Control Statements**.

Subprograms

GOLDILOCKS PSM subprogram is a PSM block with a name and it can be repeatedly performed. If a subprogram has an argument, then it can be performed by being given different arguments when each time it is called.

Subprogram is either in a procedure form or a function form, and the function form has a return value. It also supports a nested subprogram which is declared in a specific block and used within it.

For more information, refer to **Using PSM Subprograms**.

17.3 Processing Transaction in PSM

A database transaction is a work unit which consists of one or more of SQL statements and it can not be disassembled. The followings are SQL statements which use transactions in GOLDILOCKS database.

- DML except for SELECT statements
- All DDL

A transaction starts in the following cases.

- When performing SQL which uses a transaction for the first time immediately after the connection.
- When performing SQL which uses a transaction for the first time since COMMIT or ROLLBACK

A transaction ends when a user performs COMMIT or ROLLBACK, or terminates the connection.

A subprogram module created by GOLDILOCKS PSM is a statement which does not uses its own transaction, so a new transaction does not occur when the subprogram is called.

However, to guarantee atomicity of the SQL statement, the the available SQL types in a subprogram may vary depending on the case of calling the subprogram.

- When a user directly calls a subprogram module by using CALL statement, or performs an anonymous block
 - A superordinate statement does not exists, so all kinds of SQL can be used within a subprogram and COMMIT/ROLLBACK is also allowed.
- When a subprogram module is used within a DML statement (INSERT/UPDATE/DELETE) except for SELECT
 - A superordinate statement has a transaction, so all kinds of SQL can be used within a subprogram. However, to guarantee the atomicity of the superordinate statement, neither COMMIT nor ROLLBACK is allowed.
- When a subprogram module is called within a SELECT statement
 - A superordinate statement does not use a transaction, so any kind of SQL using a transaction can not be used even within a called subprogram, nor is COMMIT/ROLLBACK allowed. Only SELECT statement is allowed.

18.

PSM DataTypes

18.1 Built-in Data Types

GOLDILOCKS PSM supports all basic data types provided by GOLDILOCKS SQL in the same way.

The followings are the basic data types.

For more information, refer to **Data Type**.

Numeric Types

- NUMBER
- NUMERIC
- FLOAT
- NATIVE_INTEGER
- NATIVE_DOUBLE

CHARACTER STRING Types

- CHARACTER (CHAR)
- CHARACTER VARYING (VARCHAR, VARCHAR2)
- CHARACTER LONG VARYING (LONG VARCHAR)



Exceptionally, for the compatibility with other database, GOLDILOCKS PSM provides VARCHAR types (VARCHAR2, CHAR VARYING, CHARACTER VARYING) whose precision is not specified, and which is not supported by GOLDILOCKS SQL.

This type can not be used when declaring an ordinary variable, but it can be used only when declaring an argument of a subprogram, a return type or an argument of a cursor. If this type is specified, then the argument and the return type is determined as a type with the biggest value among VARCHAR types. (precision = 4000)

BINARY STRING Type

- BINARY
- BINARY VARYING (VARBINARY)
- BINARY LONG VARYING (LONG VARBINARY)

DATE/TIME Type

- DATE
- TIME [WITH/WITHOUT TIME ZONE]
- TIMESTAMP [WITH/WITHOUT TIME ZONE]

INTERVAL Type

- INTERVAL YEAR
- INTERVAL MONTH
- INTERVAL YEAR TO MONTH
- INTERVAL DAY
- INTERVAL HOUR
- INTERVAL MINUTE
- INTERVAL SECOND
- INTERVAL DAY TO HOUR
- INTERVAL DAY TO MINUTE
- INTERVAL DAY TO SECOND
- INTERVAL HOUR TO MINUTE
- INTERVAL HOUR TO SECOND
- INTERVAL MINUTE TO SECOND

BOOLEAN Type

BOOLEAN

ROWID Type

ROWID

Declaring Built-in Data Type Variables

A variable can be declared in each declaration section within an anonymous block, a procedure or a function.

```
DECLARE
  V_MSG VARCHAR(20) := 'HELLO, WORLD!';
BEGIN
  DBMS_OUTPUT.PUT_LINE( 'My First Message Is : ' || V_MSG );
END;
/
```

For more information, refer to [Built-in Data Type References](#).

18.2 Attribute Data Types

It is a data type which is used when specifying types of other PSM variables, cursors, tables or a specific column in a table.

If an attribute variable or a target object (table) of a function is altered, then PSM (procedure, function) is automatically compiled again according to the altered type and it is applied.

%TYPE

It is used when specifying a type of other variables or a column type of a specific table. The following objects can be referenced.

- Scalar type (Including built-in data type) variables
- User defined record type variables
- A specific field of a record type variable
- Collection type variables
- A specific field of a collection type variable
- A specific column of a table

%TYPE is used as follows.

```
CREATE TABLE EMP ( ID INTEGER, NAME VARCHAR(32) );
INSERT INTO EMP VALUES ( 1001, 'Tom Jackson' );
COMMIT;
DECLARE
  V_NAME EMP.NAME%TYPE;
BEGIN
  SELECT NAME INTO V_NAME FROM EMP;
  DBMS_OUTPUT.PUT_LINE( 'EMP.NAME = ' || V_NAME );
END;
/
```

%ROWTYPE

It is used to specify the structure of a specific table, or the record type as same as the returned type of a specific cursor. It can refer to the following objects.

- Table
- Cursor
- Cursor variable

Neither the record type variable nor collection type variable can be a target of %ROWTYPE.

The following is an example of using %ROWTYPE.

```

DECLARE
  V_EMP EMP%ROWTYPE;
BEGIN
  SELECT * INTO V_EMP FROM EMP WHERE ID = 1001;
  DBMS_OUTPUT.PUT_LINE( 'Name of ID 1001 Is : ' || V_EMP.NAME );
END;
/

```

Constraint Attributes Inheritance

The constraint attributes of variables declared as an attribute type inherits the constraint attributes of the reference target as follows.

Table 18-1 Whether to inherit constraints of the attribute types

Attribute type	Reference target	NOT NULL	Default value
%TYPE	Scalar variable	O	X
	Record type variable	O	O
	A specific field of a record type variable	O	X
	Collection type variable - scalar element	O	X
	Collection type variable - record element	O	O
	A specific field of a collection type variable	O	X
	A specific column of a table	X	X
%ROWTYPE	Table	X	X
	Cursor	X	X
	Cursor Variable	X	X

18.3 User-defined Record Type

The record type variable is a complex structure type which consists of several fields of each different type. A record type variable can be created by copying types of other tables or cursors by using %ROWTYPE, or by declaring a data structure which is appropriate to a specific purpose by a user.

A user defined record type can be defined by using TYPE keyword in PSM declarative part as follows. Each field can optionally specify a NOT NULL constraint and a default value.

```
DECLARE
  TYPE MY_EMP_TYPE IS RECORD
  (
    ID INTEGER := 99999,
    NAME VARCHAR(32) NOT NULL DEFAULT 'anonymous'
  );
  V_EMP MY_EMP_TYPE;
BEGIN
  SELECT ID, NAME INTO V_EMP.ID, V_EMP.NAME FROM EMP;
  DBMS_OUTPUT.PUT_LINE('ID = ' || V_EMP.ID);
  DBMS_OUTPUT.PUT_LINE('NAME = ' || V_EMP.NAME);
END;
/
```

The following is an example of using it in a nested procedure or in a nested function.

```
DECLARE
  TYPE MY_EMP_TYPE IS RECORD
  (
    ID INTEGER := 99999,
    NAME VARCHAR(32) NOT NULL DEFAULT 'anonymous'
  );
  V_EMP MY_EMP_TYPE;
  PROCEDURE SET_EMP( A_EMP IN OUT MY_EMP_TYPE )
  IS
  BEGIN
    DBMS_OUTPUT.PUT_LINE('ID = ' || A_EMP.ID);
    DBMS_OUTPUT.PUT_LINE('NAME = ' || A_EMP.NAME);
    SELECT ID, NAME INTO A_EMP.ID, A_EMP.NAME FROM EMP;
  END;
BEGIN
```

```
SET_EMP( V_EMP );  
DBMS_OUTPUT.PUT_LINE(' ID = ' || V_EMP.ID);  
DBMS_OUTPUT.PUT_LINE(' NAME = ' || V_EMP.NAME);  
END;  
/
```

A user defined record type can be used as an argument or a returned type of a general regional variable, a nested procedure, or a nested function. However, it can not be used as an argument or a returned type of a schema-level procedure or a schema-level function.

18.4 User-defined Collection Type

User defined collection type is a kind of an array structure which stores one or more data. GOLDILOCKS PSM supports an associative array type which can be stored as key/value pair among collection types.

The following is a basic SYNTAX to declare an associative type.

```
TYPE <type_name> IS TABLE OF <element_data_type> INDEX BY <index_key_data_type>
```

- <type_name> is a user defined name for the type.
- <element_data_type> specifies a data type of a value which configures an array.
- <index_key_data_type> specifies a data type of an index key which explores for an element.

For example, if the information corresponding to (number) is in form of (name, age), then a table can be created and stored in a database as follows.

```
CREATE TABLE INFO
(
  NO INTEGER,
  NAME VARCHAR(20),
  AGE INTEGER
)
CREATE UNIQUE INDEX IDX_NO ON INFO (NO)
```

- If the information above is stored as an associative array, then its configuration is as follows.
 - Index_key corresponds to a number (NO).
 - Element_data consists of a name (NAME) and an age (AGE).

An associative array variable to store it is defined within a real PSM as follows.

```
TYPE rec IS RECORD (NAME VARCHAR(20), AGE INTEGER);
TYPE info IS TABLE OF rec INDEX BY INTEGER;
```

For more information, refer to **COLLECTION Variable Declaration**.

Associative Array

An associative array type variable has a data type key specified in an index clause, and it is a PSM variable which can store a value of element data type specified in TABLE OF clause in one or more values in a key/value form.

- The features of an associative array type of GOLDILOCKS PSM is as follows.
 - It has an exploring key in a data type form specified in INDEX BY clause, and it is automatically sorted and stored.
 - It consists of elements specified in TABLE OF clause.
 - It provides exploring functions called as collection methods.
 - It is stored in a replace form when storing an element in an existing index key.
 - The maximum storage size is restricted to the available size of MEMORY_TEMP_TBS_SIZE.

The following is an example of declaring an element type as an SQL data type, and inserting data.

```
gSQL> CREATE TABLE T1
(
  C1 VARCHAR(20),
  C2 VARCHAR(20)
);
Table created.
gSQL> DECLARE
  TYPE rec IS TABLE OF VARCHAR(20) INDEX BY VARCHAR(10);
  V1 rec;
BEGIN
  V1('aa') := 'Dog';
  V1('bb') := 'Cat';
  INSERT INTO T1 VALUES ( V1('aa'), V1('bb') );
END;
/
Anonymous PL block executed.
gSQL> SELECT * FROM T1;
C1  C2
--- ---
Dog Cat
1 row selected.
```

The following is an example of having a record type as an element.

```
gSQL> CREATE TABLE T1
(
  C1 VARCHAR(20),
  C2 VARCHAR(20)
);
Table created.
gSQL> DECLARE
  TYPE rec IS TABLE OF T1%ROWTYPE INDEX BY VARCHAR(10);
```

```

V1 rec;
BEGIN
  V1('person1').C1 := 'seoul';
  V1('person1').C2 := '12';
  V1('person2').C1 := 'busan';
  V1('person2').C2 := '24';
  INSERT INTO T1 VALUES V1('person1'), V1('person2');
END;
/
Anonymous PL block executed.
gSQL> SELECT * FROM T1;
C1    C2
----- --
seoul 12
busan 24
2 rows selected.

```

- The following is a data type which can be specified in an index key of an associative array of GOLDLOCKS PSM.
 - INTEGER
 - LONG
 - CHAR
 - VARCHAR
- The following is a data type which can be used as an element type of an associative array of GOLDLOCKS PSM.
 - SQL Data Type
 - %TYPE
 - %ROWTYPE
 - User defined Record Type

For more information, refer to **Built-in Data Types**, **%TYPE**, **%ROWTYPE**, **User Defined Record Type**.

Assign Values to Collection Variables

The following rules are applied when assigning values to collection variables.

- The rules as same as <Assign Statement> is applied to an element assignment.
- To assign values to the entire collection variable, the types of collection variables should be same.
- When assigning an element of a collection variable, it is operated according to the element data type as follows.

- Assigning a user defined type element is allowed among same type.
- Else, it is allowed to assign when data types of a field configuring an element are compatible at a run-time.

The following is an example of an error due to the assignment of a different type.

```

DECLARE
  TYPE udr1 IS RECORD (F1 INTEGER, F2 VARCHAR(20));
  TYPE udr2 IS RECORD (F1 INTEGER, F2 VARCHAR(20));
  TYPE rec1 IS TABLE OF udr1 INDEX BY VARCHAR(10);
  TYPE rec2 IS TABLE OF udr2 INDEX BY VARCHAR(10);
  V1 rec1;
  V2 rec2;
BEGIN
  V2('person1').F1 := 24;
  V2('person1').F2 := 'seoul korea';
  V1 := V2;
END;
/
ERR-HY000(17032): PSM compilation error :
(1) at (14:9): ERR-HY000(17007): invalid expression

```

In the example above, configuration of each field of an element which consists of user defined type is same. However, the variable types are different, so the assignment fails.

The following is an example of succeeding in an assignment by using the same type.

```

DECLARE
  TYPE udr1 IS RECORD (F1 INTEGER, F2 VARCHAR(20));
  TYPE rec1 IS TABLE OF udr1 INDEX BY VARCHAR(10);
  V1 rec1;
  V2 rec1;
BEGIN
  V2('person1').F1 := 24;
  V2('person1').F2 := 'seoul korea';
  V1 := V2;
END;
/
Anonymous PL block executed.

```

Assignment of an associative type in an element unit is allowed only when the data types of elements are compatible.

Refer to the following example.

```

gSQL> CREATE TABLE T1
(
  c1 VARCHAR(20),
  c2 VARCHAR(20)
);
Table created.
gSQL> DECLARE
TYPE record_org1 IS RECORD (f1 VARCHAR(20), f2 VARCHAR(20));
TYPE rec1 IS TABLE OF t1%rowtype INDEX BY VARCHAR(10);
TYPE rec2 IS TABLE OF record_org1 INDEX BY VARCHAR(10);
v1 record_org1;
v2 rec1;
v3 rec2;
v4 t1%rowtype;
BEGIN

  -- From record_org1 type to %rowtype
  V2('first') := v1;
  -- From record_org1 type to record_org1 type
  V3('first') := v1;

  -- From t1%rowtype to record_org1 type
  V3('second') := V2('first');
END;
/
Anonymous PL block executed.

```

An associative type variable is stored in a volatile memory space, and the user accessible TEMP TABLESPACE should be extended when the space is insufficient. The following is an example of an error due to the memory insufficiency.

```

DECLARE
TYPE rec IS TABLE OF t1%rowtype INDEX BY varchar(20);
v1 rec;
BEGIN
  BEGIN
    FOR i IN 1 .. 100000
    LOOP
      v1(i).c1 := i;
    
```

```

        v1(i).c2 := i;
        v1(i).c3 := i;
    END LOOP;
    EXCEPTION WHEN OTHERS THEN
        dbms_output.put_line('error: count=' || v1.count());
        dbms_output.put_line('sqlcode=' || SQLCODE);
        dbms_output.put_line('sqlmsg =' || SQLERRM);
    END;
    dbms_output.put_line('v1.count=' || v1.count());
END;
/
error: count=95004
sqlcode=-14015
sqlmsg =[SUNJESOFT][PSM][GOLDILOCKS]there is no extendible datafile in tablespace
'MEM_TEMP_TBS'
v1.count=95004
Anonymous PL block executed.

```

Collection Method

A collection method is a function or a procedure which is provided to easily operate a collection type variable. Associative array provides the following methods.

Table 18-2 Collection method

Method	Type	Input argument	Return type	Description
FIRST	Function	X	Index key data type	It returns the first index key.
LAST	Function	X	Index key data type	It returns the last index key.
COUNT	Function	X	INTEGER	It returns the number of elements.
EXISTS	Function	O	BOOLEAN	It returns whether an index key exists or not.
PRIOR	Function	O	Index key data type	It returns an index key prior to the input index key.
NEXT	Function	O	Index key data type	It returns an index key next to the input index key.
DELETE	Procedure	O	N/A	It deletes an element corresponding to the input index key.

A collection method is used as follows.

```

gSQL> CREATE TABLE T1
(
  C1 VARCHAR(20),
  C2 VARCHAR(20)
);
Table created.
gSQL> DECLARE
  TYPE rec IS TABLE OF T1%ROWTYPE INDEX BY VARCHAR(10);
  V1 rec;
BEGIN
  V1('person1').C1 := 'seoul';
  V1('person1').C2 := '12';
  V1('person2').C1 := 'busan';
  V1('person2').C2 := '24';
  V1('person3').C1 := 'Daegu';
  V1('person3').C2 := '36';
  -- First method
  DBMS_OUTPUT.PUT_LINE('First Index Key = ' || V1.first() );
  -- Last method
  DBMS_OUTPUT.PUT_LINE('Last Index Key = ' || V1.last() );
  -- Count method
  DBMS_OUTPUT.PUT_LINE('Count of element = ' || V1.count() );
  -- Prior Method
  DBMS_OUTPUT.PUT_LINE('Prior (person1) = ' || V1.prior('person1') ); -- return NULL
  DBMS_OUTPUT.PUT_LINE('Prior (person3) = ' || V1.prior('person3') );
  -- Next Method
  DBMS_OUTPUT.PUT_LINE('Next (person1) = ' || V1.next('person1') );
  DBMS_OUTPUT.PUT_LINE('Next (person3) = ' || V1.next('person3') ); -- return NULL
  -- Exists Method
  DBMS_OUTPUT.PUT_LINE('Exists (person2) = ' || V1.exists('person2') );
  -- Delete Method
  V1.delete('person2');
  -- Exists Method
  DBMS_OUTPUT.PUT_LINE('After delete, Exists (person2) = ' || V1.exists('person2') );
END;
/
First Index Key = person1
Last Index Key = person3
Count of element = 3
Prior (person1) =
Prior (person3) = person2

```

```
Next (person1) = person2
Next (person3) =
Exists (person2) = TRUE
After delete, Exists (person2) = FALSE
Anonymous PL block executed.
```

If a delete procedure deleting an element can not find an index key corresponding to the input argument, then an error occurs as follows.

```
gSQL> DECLARE
  TYPE rec IS TABLE OF T1%ROWTYPE INDEX BY VARCHAR(10);
  V1 rec;
BEGIN
  V1('person1').C1 := 'seoul';
  V1('person1').C2 := '12';
  -- Call delete procedure
  V1.delete('person2');
END;
/
ERR-HY000(17045): no data found :
  V1.delete('person2');
*
ERROR at line 9:
Anonymous PL block executed.
```

18.5 SYS_REFCURSOR

SYS_REFCURSOR is a predefined type for a cursor variable, and it is used to declare a cursor variable.

It is used to declare a cursor variable in the following form.

```
cursor_variable_name SYS_REFCURSOR;
```

Cursor variable can be used together with OPEN FOR, FETCH, CLOSE statement as follows.

```
DECLARE
  v1 VARCHAR(20);
  v2 VARCHAR(20);
  cv1 SYS_REFCURSOR;
  cv2 SYS_REFCURSOR;
BEGIN
  OPEN cv1 FOR SELECT * FROM T1;
  cv2 := cv1;
  FETCH cv2 INTO V1, V2;
  DBMS_OUTPUT.PUT_LINE('V1 = ' || V1 || ' , V2 = ' || V2);

END;
/
V1 = Seoul , V2 = 24
Anonymous PL block executed.
```

- The variable declared by using SYS_REFCURSOR is used as follows.
 - It is possible to assign each cursor variable among cursor variables. An existing open cursor of the cursor variable which is on the right of the assign can not be used any more.
 - An explicit cursor can not be assigned to a cursor variable.
 - A variable of a different data type can not be assigned to a cursor variable.
 - A nested function/procedure and schema-level function/procedure can be used as a parameter.

For more information, refer to **CURSOR VARIABLES**, **Cursor Variable Declaration**, **OPEN FOR Statement**.

19.

PSM Control Statements

19.1 Assignment

It inserts the calculation value of the right expression into the left variable by using assignment operators (':=').

Assignment Target

An assignment target is on the left side of the assignment operator, and the following items may exist on it.

- Variables (Including an argument of a procedure or a function except for IN type)
- Bind parameter such as '?' or ':V1' (It can be used only in an anonymous PL block.)

Assigning Expression

An expression available on PSM is on the right side of the assignment operator. Expressions available on a PSM expression is as follows.

- Constant
- All operators, built-in functions or pseudo columns provided by GOLDILOCKS SQL
- Bind parameter bound to IN or IN OUT type (It can be used only in an anonymous PL block.)
- PSM variable
- PSM nested function
- Schema-level function

The following is an example of assignment statement per each type.

```
CREATE OR REPLACE FUNCTION ADD_TEN( A1 INTEGER )
RETURN INTEGER
IS
BEGIN
    RETURN A1 + 10;
END;
/
COMMIT;
DECLARE
    FUNCTION ADD_ONE( A1 INTEGER )
```



```

RETURN INTEGER
IS
BEGIN
    RETURN A1 + 1;
END;
V_NUM INTEGER;
V_STR VARCHAR(10);
BEGIN
    V_NUM := 10;           ❶ Numeric literal
    V_STR := 'ABC';       ❷ String literal
    :V_PARAM := V_STR || 'DEF';  ❸ PSM variable, SQL operator
    V_NUM := ADD_ONE( 100 ) + ADD_TEN( 1000 );
                                ❹ Nested function, Schema-level function
END;
/

```

The following expressions can not be used in an PSM expression.

- Column of a table, view or the corresponding object
- SQL objects such as an index, a sequence or a synonym
- Subquery
- Nested procedure
- Schema-level procedure

The following is an example of an error due to a wrong expression.

```

gSQL> CREATE SEQUENCE SEQ1;
Sequence created.
gSQL> COMMIT;
Commit complete.
gSQL> DECLARE
    V1 INTEGER;
BEGIN
    V1 := SEQ1.NEXTVAL;
END;
/
ERR-HY000(17032): PSM compilation error :
(1) at (4:9): ERR-42000(16074): sequence number not allowed here

```

To assign an object value of a type which is not available in an PSM expression, use SELECT INTO statement as follows.

```

gSQL> DECLARE
    V1 INTEGER;
BEGIN
    SELECT SEQ1.NEXTVAL INTO V1 FROM DUAL;
END;
/
Anonymous PL block executed.

```

Assignment Compatibility

Even though the statement can use an expression of an assignment statement, it may succeed or fail depending on a target type and the final result type of an expression. The available expression types according to a target type is as follows.

Table 19-1 Assignment compatibility

Target type	Final result type of an expression
Scalar type <ul style="list-style-type: none"> Scalar type variable A specific field of a record type variable Scalar element of a collection variable with a key value 	It is allowed only when it is a scalar type with a value convertible to a target type.
Attribute record type (%ROWTYPE)	It is allowed only when the number of fields are same and each field value is convertible to the field of the corresponding order of a target.
User defined record type	Only the exactly same type is allowed.
Collection type <ul style="list-style-type: none"> Collection type variable whose key value is not specified 	Only the exactly same type is allowed.

Even though the internal structures of user defined record type variables are same, an error occurs if the type names are different.

```

gSQL> DECLARE
    TYPE MY_REC1 IS RECORD ( F1 INTEGER := 1, F2 VARCHAR(10) := 'AAA' );
    TYPE MY_REC2 IS RECORD ( F1 INTEGER := 1, F2 VARCHAR(10) := 'AAA' );
    V1 MY_REC1;
    V2 MY_REC2;
BEGIN
    V2 := V1;
END;

```

```
/  
ERR-HY000(17032): PSM compilation error :  
(1) at (7:9): ERR-HY000(17007): invalid expression
```

Moreover, if a target is an argument variable defined with IN attribute or is a bind parameter bound with IN attribute, an error occurs.

```
gSQL> DECLARE  
  FUNCTION ADD_ONE( A1 IN INTEGER )  
  RETURN INTEGER  
  IS  
  BEGIN  
    A1 := A1 + 1;  
    RETURN A1;  
  END;  
  V1 INTEGER;  
BEGIN  
  V1 := ADD_ONE( 10 );  
END;  
/  
ERR-HY000(17032): PSM compilation error :  
(1) at (6:5): ERR-HY000(17024): (A1) cannot be used as assignment target
```

Assignment compatibility rules are applied same even when assigning the value of an actual parameter to a formal parameter variable while calling a function or a procedure.

19.2 PL Block

A PL block is a basic unit which configures PSM. A PL block can be nested again in another PL block. Items declared within a PL block can be referenced only within the range of its own block (including subordinate blocks)

PL Block Configuration

A single PL block is divided into the following three parts.
For more information, refer to **Block (BEGIN .. END)**.

```
[DECLARE  
  ① Declarative part]  
BEGIN  
  ② Statements  
[EXCEPTION  
  ③ Handlers]  
END;
```

Declarative Part

A declarative part is an area in which a local item to be used within a PL block is declared. If an item such as a local variable to be declared does not exist, then a declarative part is not defined, but it starts from an executable part.

Local items to be declared in a declarative part is as follows.

- Variable (Refer to **PSM DataTypes**.)
- User defined type
- Cursor
- Nested function or a procedure (Subprogram)
- User defined exception

All names of items declared in a single PL block should be unique regardless of their types. For example, a cursor whose name is as same as a name of a variable can not be declared.

```
gSQL> DECLARE  
  C1 INTEGER;  
  CURSOR C1 IS SELECT * FROM DUAL;
```

```

BEGIN
  OPEN C1;
  FETCH C1 INTO C1;
  CLOSE C1;
END;
/
ERR-HY000(17032): PSM compilation error :
(1) at (3:10): ERR-HY000(17027): duplicated identifier
(2) at (5:8): ERR-HY000(17031): mismatch identifier type
(3) at (6:9): ERR-HY000(17031): mismatch identifier type
(4) at (7:9): ERR-HY000(17031): mismatch identifier type

```

However, an item in a subordinate PL block whose name is as same as an item in a superordinate PL block can be declared. In this case, that name means the item found first when exploring from the current location toward the superordinate block.

```

gSQL> <<PP>>
DECLARE ① Parent scope begin
  V1 VARCHAR(10) := 'AAA';
BEGIN
  <<CC>>
  DECLARE ② Child scope begin
    V1 INTEGER := 99;
  BEGIN
    DBMS_OUTPUT.PUT_LINE( 'PP.V1 = ' || PP.V1 );
    DBMS_OUTPUT.PUT_LINE( 'CC.V1 = ' || CC.V1 );
    DBMS_OUTPUT.PUT_LINE( 'V1 = ' || V1 );
  END; ③ Child scope end
END; ④ Parent scope end
/
PP.V1 = AAA
CC.V1 = 99
V1 = 99
Anonymous PL block executed.

```

Executable Part

In an executable part, a declared items are manipulated and included statements are performed. Statements available in an executable parts are as follows.

- Control Statements (Refer to **PSM Control Statements**.)

- Cursor Statements (Refer to **PSM Cursor Statements**.)
- SQL Statements (static/ dynamic) (Refer to **Using SQLs In PSM**.)

Exception Handling Part

It defines handlers which handles multiple exceptions occurring during the execution.

If an exception occurs during executing several statements in an executable part, then it explores from the location of that PL block to the superordinate PL block to find out whether a handler is registered to handle the exception. If there is the handler, then it performs the contents of that handler, then initializes the situation at exceptional situation.

```

DECLARE
  V1 INTEGER;
BEGIN
  SELECT C1 INTO V1 FROM T1 WHERE C1 = 100;
EXCEPTION
  WHEN NO_DATA_FOUND THEN
    DBMS_OUTPUT.PUT_LINE('SQL%ISOPEN = ' || SQL%ISOPEN);
    DBMS_OUTPUT.PUT_LINE('SQL%FOUND = ' || SQL%FOUND);
    DBMS_OUTPUT.PUT_LINE('SQL%NOTFOUND = ' || SQL%NOTFOUND);
    DBMS_OUTPUT.PUT_LINE('SQL%ROWCOUNT = ' || SQL%ROWCOUNT);
END;
/

```

If an appropriate handler is not found even after exploring to the top-level PL block, then the occurred exception is returned to a caller, and it is terminated.

```

gSQL> DECLARE
  v1 INTEGER;
BEGIN
  v1 := 1/ 0;
END;
/
ERR-HY000(17007): invalid expression :
  v1 := 1/ 0;
      *
ERROR at line 4:
ERR-22012(12122): divisor is equal to zero

```

For more information about declaration of user defined exception, built-in handler types or installing a handler, refer to **Error Handling**.

19.3 NULL Statement

It is used to specify a statement which does not have any role in PSM such as no-op.
For more information, refer to **NULL Statement**.

```
DECLARE
  V1 INTEGER := 1;
BEGIN
  IF V1 < 10 THEN
    V1 := V1 + 1;
  ELSE
    NULL; -- do nothing
  END IF;
END;
/
```

19.4 Testing Conditions

Conditional branch statements perform statements according to true/false of the given condition. GOLDI LOCKS PSM provides two conditional branch statements, which are IF and CASE.

IF

IF statement performs statements which are true among conditions of the given expression. Conditions of an expression can be specified next to IF and ELSIF. If the condition of an expression is true when checking conditions in an order specified when performing, then it performs the statements below THEN clause. If all IF conditions and ELSIF conditions are false, and ELSE clause is specified, then it performs the statements below ELSE clause.

IF statement always ends with END IF keyword.

For more information, refer to **IF Statement**.

```
DECLARE
V1 INTEGER := 1;
BEGIN
  -- IF COND
  IF V1 > 0 THEN
    DBMS_OUTPUT.PUT_LINE( 'IF COND' );
  ELSIF V1 = 0 THEN
    DBMS_OUTPUT.PUT_LINE( 'ELSIF COND' );
  ELSE
    DBMS_OUTPUT.PUT_LINE( 'ELSE COND' );
  END IF;
  -- ELSIF COND
  IF V1 = 0 THEN
    DBMS_OUTPUT.PUT_LINE( 'IF COND' );
  ELSIF V1 > 0 THEN
    DBMS_OUTPUT.PUT_LINE( 'ELSIF COND' );
  ELSE
    DBMS_OUTPUT.PUT_LINE( 'ELSE COND' );
  END IF;
  -- ELSE COND
  IF V1 = 0 THEN
    DBMS_OUTPUT.PUT_LINE( 'IF COND' );
```



```

ELSIF V1 < 0 THEN
    DBMS_OUTPUT.PUT_LINE( 'ELSIF COND' );
ELSE
    DBMS_OUTPUT.PUT_LINE( 'ELSE COND' );
END IF;
END;
/

```

ELSIF clause and ELSE clause are optional, so it may or may not be specified.

When ELSE statement is not specified and any conditions of IF or ELSIF is not true, then it does not perform any statement, but proceeds to the next statement without causing any exception.

CASE

CASE statement selects a single array among arrays of multiple statements such as IF statement, then performs it. CASE statement ends with END CASE keyword, and ELSE clause is optional so it may or may not be specified.

If WHEN clause with an appropriate condition can not be found and ELSE clause is specified, then it arrays statements below ELSE clause. If an appropriate condition does not exist nor is ELSE clause specified, then CASE_NOT_FOUND exception occurs.

For more information, refer to **CASE Statement**.

WHEN clauses in CASE is evaluated in an specified order, and if an appropriate WHEN clause is found and statements of that WHEN clause are arrayed, then all WHEN clauses after that are ignored.

There are two kinds of CASE statements as follows.

- Simple CASE statement
- Searched CASE statement

Simple CASE Statement

A simple CASE statement arrays statements owned by WHEN clause which has the same value as a select or expression among expressions specified next to WHEN clause by using a selector expression specified next to CASE keyword. Then it ends.

```

DECLARE
V1 VARCHAR(1) := '2';
BEGIN

```

```
CASE V1 WHEN '0' THEN DBMS_OUTPUT.PUT_LINE ('Result = 0');
        WHEN '1' THEN DBMS_OUTPUT.PUT_LINE ('Result = 1');
        WHEN '2' THEN DBMS_OUTPUT.PUT_LINE ('Result = 2');
        ELSE DBMS_OUTPUT.PUT_LINE ('Result = Other');
END CASE;
END;
/
```

Searched CASE Statement

A searched CASE statement does not have a selector expression, instead a conditional expression which is evaluated as boolean type per each WHEN clause is specified. When it is executed, it arrays statements owned by the first WHEN clause which is TRUE by evaluating expressions of each WHEN clause. Then it ends.

```
DECLARE
V1 VARCHAR(1) := '2';
BEGIN
CASE WHEN V1 = 0 THEN DBMS_OUTPUT.PUT_LINE ('Result = 0');
      WHEN V1 = 1 THEN DBMS_OUTPUT.PUT_LINE ('Result = 1');
      WHEN V1 = 2 THEN DBMS_OUTPUT.PUT_LINE ('Result = 2');
      ELSE DBMS_OUTPUT.PUT_LINE ('Result = OTHER');
END CASE;
END;
/
```

19.5 Iterative Control

Iterative control statements performs a series of statements several times. GOLDILOCKS PSM provides the following iterative control statements.

- Basic loop
- FOR loop
- WHILE loop

Basic Loop

A basic loop statement encloses a series of statements which are to be performed several times with LOOP and END LOOP keywords. This statement indefinitely performs the inner statements, and it can escape out of the loop by using EXIT or GOTO statements which are sequential control statements.

For more information, refer to **Basic LOOP Statement**.

The following is an example of escaping from a basic loop which has the closest scope from that location by using EXIT WHEN statement.

For more information, refer to **EXIT Statement**.

```
gSQL> DECLARE
  V1 INTEGER := 1;
BEGIN
  LOOP
    DBMS_OUTPUT.PUT_LINE( 'V1 = ' || V1 );
    V1 := V1 + 1;
    EXIT WHEN V1 > 10;  -- Escape Condition
  END LOOP;
END;
/
V1 = 1
V1 = 2
V1 = 3
V1 = 4
V1 = 5
V1 = 6
V1 = 7
V1 = 8
V1 = 9
```

```
V1 = 10
```

Anonymous PL block executed.

To escape out of a specific loop when multiple loops are nested, specify a label in front of that loop and specify that label as a target label in EXIT statement.

```
gSQL> DECLARE
  V1 INTEGER := 1;
BEGIN
  <<OUTER_LOOP>>
  LOOP
    <<INNER_LOOP>>
    LOOP
      DBMS_OUTPUT.PUT_LINE( 'V1 = ' || V1 );
      V1 := V1 + 1;
      EXIT OUTER_LOOP WHEN V1 > 5; -- Escape Condition
    END LOOP INNER_LOOP;
    DBMS_OUTPUT.PUT_LINE( 'END OF INNER LOOP' );
    V1 := V1 + 5;
  END LOOP OUTER_LOOP;
  DBMS_OUTPUT.PUT_LINE( 'END OF OUTER LOOP' );
END;
/
V1 = 1
V1 = 2
V1 = 3
V1 = 4
V1 = 5
END OF OUTER LOOP
```

Anonymous PL block executed.

FOR Loop

FOR loop statement repeatedly performs a series of statements as many times as the number of integers of the given scope.

For more information, refer to **FOR LOOP Statement**.

A user creates an index variable with the name specified next to FOR keyword, and it sets the beginning value specified on the left side of a scope operator ('..') which is next to IN keyword as an initial value. The n, it performs a series of statements by increasing by 1 per each loop until it becomes as same as the end

value specified on the right side of a scope operator.

```
BEGIN
  FOR I IN 0 .. 10 LOOP
    DBMS_OUTPUT.PUT_LINE( 'I = ' || I );
  END LOOP;
END;
/
```

When REVERSE keyword is specified in front of the scope, then it performs loop by reducing the value of an index variable by 1.

```
BEGIN
  FOR I IN REVERSE 10 .. 1 LOOP
    DBMS_OUTPUT.PUT_LINE( 'I = ' || I );
  END LOOP;
END;
/
```

WHILE Loop

WHILE loop statement repeatedly performs a series of statements while the given condition is TRUE. For more information, refer to **WHILE LOOP Statement**.

```
DECLARE
  V1 integer := 0;
BEGIN
  WHILE V1 < 10 LOOP
    DBMS_OUTPUT.PUT_LINE( 'V1 = ' || V1 );
    V1 := V1 + 1;
  END LOOP;
END;
/
```

WHILE loop checks given conditions before performing statements of a body so if the condition is FALSE from the beginning, then it may not perform statements of a body at all.

19.6 Sequential Control

Sequential control statements move on which a program is performed from the current performing location to another location.

GOLDILOCKS PSM provides the following three sequential control statements.

- GOTO
- CONTINUE
- EXIT

GOTO

GOTO statement moves the performing location to the statement in which the given label is. It can be specified in front of any statement which is executable within PSM of a label. A target label to which GOTO moves can exist before and after the GOTO statement. However, only a visible statement can perform GOTO.

For more information, refer to **GOTO Statement**.

Conditions for a visible statement is as follows.

- Sibling statements located before and after the current performing location
- A superordinate statement of the current location, and sibling statements located before and after the superordinate statement

The following is an example of moving a performing location to a sibling statement of the current location.

```
gSQL> BEGIN
  <<PARENT_PREV>>
  DBMS_OUTPUT.PUT_LINE('PARENT PREV');
  <<PARENT>>
  IF 1 > 0 THEN
    <<SIBLING_PREV>>
    DBMS_OUTPUT.PUT_LINE('SIBLING PREV');
    <<CURRENT_POSITION>>
    GOTO SIBLING_NEXT;
    DBMS_OUTPUT.PUT_LINE('SIBLINGS');
    DBMS_OUTPUT.PUT_LINE('SIBLINGS');
    <<SIBLING_NEXT>>
```

```

    DBMS_OUTPUT.PUT_LINE('SIBLING NEXT');
ELSE
    <<NON_SIBLING>>
    DBMS_OUTPUT.PUT_LINE('NON SIBLING');
END IF;
<<PARENT_NEXT>>
DBMS_OUTPUT.PUT_LINE('PARENT NEXT');
END;
/
PARENT PREV
SIBLING PREV
SIBLING NEXT
PARENT NEXT
Anonymous PL block executed.

```

The following is an example of moving a performing location to a superordinate statement of a current location.

```

gSQL> BEGIN
    <<PARENT_PREV>>
    DBMS_OUTPUT.PUT_LINE('PARENT PREV');
    <<PARENT>>
    IF 1 > 0 THEN
        <<SIBLING_PREV>>
        DBMS_OUTPUT.PUT_LINE('SIBLING PREV');
        <<CURRENT_POSITION>>
        GOTO PARENT_NEXT;
        DBMS_OUTPUT.PUT_LINE('SIBLINGS');
        DBMS_OUTPUT.PUT_LINE('SIBLINGS');
        <<SIBLING_NEXT>>
        DBMS_OUTPUT.PUT_LINE('SIBLING NEXT');
    ELSE
        <<NON_SIBLING>>
        DBMS_OUTPUT.PUT_LINE('NON SIBLING');
    END IF;
    <<PARENT_NEXT>>
    DBMS_OUTPUT.PUT_LINE('PARENT NEXT');
END;
/
PARENT PREV
SIBLING PREV

```

PARENT NEXT

Anonymous PL block executed.

The following is an example of moving a performing location to a statement which is not a sibling, so an error occurs.

```
gSQL> BEGIN
  <<PARENT_PREV>>
  DBMS_OUTPUT.PUT_LINE('PARENT PREV');
  <<PARENT>>
  IF 1 > 0 THEN
    <<SIBLING_PREV>>
    DBMS_OUTPUT.PUT_LINE('SIBLING PREV');
    <<CURRENT_POSITION>>
    GOTO NON_SIBLING;
    DBMS_OUTPUT.PUT_LINE('SIBLINGS');
    DBMS_OUTPUT.PUT_LINE('SIBLINGS');
    <<SIBLING_NEXT>>
    DBMS_OUTPUT.PUT_LINE('SIBLING NEXT');
  ELSE
    <<NON_SIBLING>>
    DBMS_OUTPUT.PUT_LINE('NON SIBLING');
  END IF;
  <<PARENT_NEXT>>
  DBMS_OUTPUT.PUT_LINE('PARENT NEXT');
END;
/
ERR-HY000(17032): PSM compilation error :
(1) at (12:10): ERR-HY000(17010): can not find label name
```

Likewise, when moving a performing location to a statement which is not a superordinate sibling of the current statement, then an error occurs.

GOTO is a good tool to make a PSM program logic flexible. However, like in other languages, if it is used too much, then it may downgrade the readability, so maintenance becomes difficult. Therefore, it is recommended to use loop statements such as FOR or WHILE for an ordinary logics, and use GOTO only when it is necessary.

CONTINUE

CONTINUE statement terminates the current iteration and starts the next iteration within a loop statement such as FOR or WHILE.

For more information, refer to **CONTINUE Statement**.

```

DECLARE
  V1 INTEGER := 1;
BEGIN
  <<AAA>>
  WHILE V1 <= 10 LOOP
    DBMS_OUTPUT.PUT_LINE( 'V1 = ' || V1 );
    V1 := V1 + 1;
    IF V1 <= 2 THEN
      DBMS_OUTPUT.PUT_LINE( 'CONTINUE' );
      CONTINUE;
    ELSE
      EXIT;
    END IF;
    DBMS_OUTPUT.PUT_LINE( 'END-OF-WHILE' );
  END LOOP AAA;
END;
/

```

If a target label is specified, it starts the next iteration of a loop which has the corresponding label. If it is not specified, it starts the next iteration of the closest (inner) loop.

```

DECLARE
  V1 INTEGER := 1;
BEGIN
  <<AAA>>
  FOR I IN 0..5 LOOP
    <<BBB>>
    WHILE V1 <= 10 LOOP
      DBMS_OUTPUT.PUT_LINE( 'I = ' || I );
      DBMS_OUTPUT.PUT_LINE( 'V1 = ' || V1 );
      V1 := V1 + 1;
      IF V1 <= 2 THEN
        CONTINUE BBB;
      ELSE

```

```

        EXIT AAA;
    END IF;
END LOOP BBB;
END LOOP AAA;
END;
/

```

WHEN clause can be optionally specified in CONTINUE statement. In this case, it terminates the current iteration and starts the next iteration, only when an expression next to WHEN clause is TRUE.

```

DECLARE
    V1 INTEGER :=0 ;
BEGIN
    LOOP
        V1 := V1 + 1;
        CONTINUE WHEN V1 < 5;
        EXIT;
    END LOOP;
END;
/

```

EXIT

EXIT statement escapes the current loop and performs the next statement. For more information, refer to **EXIT Statement**.

```

DECLARE
    V1 INTEGER := 1;
BEGIN
    WHILE V1 <= 10 LOOP
        DBMS_OUTPUT.PUT_LINE( 'V1 = ' || V1 );
        IF V1 > 5 THEN
            EXIT;
        END IF;
        V1 := V1 + 1;
    END LOOP;
END;
/

```

If a target loop is specified, then it escapes a loop which has the corresponding label.

```

DECLARE
  V1 INTEGER := 1;
BEGIN
  <<AAA>>
  FOR I IN 0..5 LOOP
    <<BBB>>
    WHILE V1 <= 10 LOOP
      DBMS_OUTPUT.PUT_LINE( 'V1 = ' || V1 );
      IF V1 >= 5 THEN
        EXIT AAA;
      END IF;
      V1 := V1 + 1;
    END LOOP BBB;
  END LOOP AAA;
END;
/

```

WHEN clause can be optionally specified in EXIT statement, like as in CONTINUE statement. In this case, it performs EXIT, only when the given condition is TRUE.

```

DECLARE
  V1 INTEGER := 1;
BEGIN
  <<AAA>>
  FOR I IN 0..5 LOOP
    <<BBB>>
    WHILE V1 <= 10 LOOP
      DBMS_OUTPUT.PUT_LINE( 'V1 = ' || V1 );
      EXIT AAA WHEN V1 >= 5;
      V1 := V1 + 1;
    END LOOP BBB;
  END LOOP AAA;
END;
/

```

19.7 Error Handling

Errors in PSM are as follows depending on the point of time when it occurs.

- Errors at compile time
- Errors at run time

Errors at Compile Time

A compile error outputs an error which occurs during the validation of PSM statement specified in a procedure/function.

A syntax error outputs only the location of the first found syntax error as follows, so a user should compile it again to find out if there are any additional errors.

```
CREATE OR REPLACE PROCEDURE PROC1
IS
BEGIN
  V1 = 1;
  V2 = 1;
END;
/
ERR-42000(40000): syntax error:
  V1 = 1;
.....^
Error at line 4
```

If a syntax error does not exist, then GOLDILOCKS performs a validation while compiling a PSM statement and the errors occurred in this case are output as follows.

```
CREATE OR REPLACE PROCEDURE PROC1
IS
BEGIN
  V1 := 1;
  V2 := 2;
END;
/
ERR-01000(16409): Warning: Routine definition has compilation errors
ERR-HY000(17032): PSM compilation error :
```

```
(1) at (4:3): ERR-HY000(17006): unknown variable or column name (V1)
(2) at (5:3): ERR-HY000(17006): unknown variable or column name (V2)
Procedure created.
```

Compile errors output the information of errors within the size which is allowed in the error output buffer of GOLDILOCKS. Therefore, some errors may not be output. If so, it is output in the following form to notify that there are errors which are not output.

```
CREATE OR REPLACE PROCEDURE PROC1
IS
BEGIN
V1 := 1;
V2 := 2;
V3 := 2;
V4 := 2;
V5 := 2;
V6 := 2;
V7 := 2;
V8 := 2;
V10 := 2;
END;
/
ERR-01000(16409): Warning: Routine definition has compilation errors
ERR-HY000(17032): PSM compilation error :
(1) at (4:3): ERR-HY000(17006): unknown variable or column name (V1)
(2) at (5:3): ERR-HY000(17006): unknown variable or column name (V2)
(3) at (6:3): ERR-HY000(17006): unknown variable or column name (V3)
(4) at (7:3): ERR-HY000(17006): unknown variable or column name (V4)
(5) at (8:3): ERR-HY000(17006): unknown variable or column name (V5)
(6) at (9:3): ERR-HY000(17006): unknown variable or column name (V6)
(7) at (10:3): ERR-HY000(17006): unknown variable or column name (V7)
2 more errors...
```

An error message is output in the following form.

```
(Index) at (Line_Number : Column_Position): ERR-SQLState( Internal_ErrorCode):
Detail_Error_Message
```

- Index
 - It is a sequence of an error occurrence.
- Line_Number
 - It is a location of a line of source in which an error occurred.

- Column_Position
 - It is a location of a column of a source in which an error occurred.
- ERR-SQLState
 - It is a standard SQLState.
- Internal_ErrorCode
 - It is an internal error code.
- Detail_Error_Message
 - It is details of an error message.

Errors at Run-time

An error may occur in a PSM statement for various reasons even when PSM is normally executed. In this case, GOLDILOCKS provides an exception handling to help a user to control the error.

The following is an example of an error occurrence at the time of execution. If an error occurs when executing GOLDILOCKS PMS, then it outputs a location of an error, a PSM error and an internal error together. In other words, one or more errors may occur, so all errors should be retrieved from the database through a function such as SQLGetDiagRec if a user wants to find out the exact error message during the development process such as ODBC.

```

DECLARE
  V1 INTEGER;
BEGIN
  V1 := 1 / 0;
END;
/
ERR-HY000(17007): invalid expression :
  V1 := 1 / 0;
      *
ERROR at line 4:
ERR-22012(12122): divisor is equal to zero

```

If an error occurs at the time of operation, PSM immediately stops the operation and notifies it to a user. However, if a user wants to directly control these errors and keep the program running, the user should perform the exception handling.

The following is an example of definition to run the user program without interruption by performing the exception handling on the location of an error.

```

DECLARE
  V1 INTEGER;
BEGIN
  BEGIN
    V1 := 1 / 0;
  EXCEPTION WHEN OTHERS
    THEN DBMS_OUTPUT.PUT_LINE('SQLCODE = ' || SQLCODE);
    DBMS_OUTPUT.PUT_LINE('SQLERRM = ' || SQLERRM);
  END;

  DBMS_OUTPUT.PUT_LINE('next code');
END;
/
SQLCODE = -12122
SQLERRM = [SUNJESOFT][PSM][GOLDILOCKS]divisor is equal to zero
next code
Anonymous PL block executed.

```

For more information, refer to [EXCEPTION Handling](#), [SQLCODE Function](#), [SQLERRM Function](#).

Cursor Attributes

Cursor attributes are attributes (variables) which are provided to display the cursor status specified by a user or to display the inside of the database, while processing PSM.

- Cursors are specified as follows.
 - Implicit cursor
 - It is a cursor which is OPEN/ FETCH/ CLOSE inside of the database when it is required.
 - Explicit cursor
 - It is a cursor which OPEN/ FETCH /CLOSE after when a user explicitly perform declaration/ definition.

Implicit Cursor Attributes

Implicit cursor attributes in PSM is used to find out the processing status of a SQL statement which was approximately performed. Each value of attributes can be used in expressions such as a conditional expression, so a user can control it such as branching logics of a program through that value.

For more information about attributes, refer to the following table.

Table 19-2 Implicit cursor attributes

Attribute name	Return type	Description
ISOPEN	BOOLEAN	It is always FALSE because it is internally closed.
FOUND	BOOLEAN	If the data is returned by the previous statement, then it is TRUE. Otherwise, it is FALSE.
NOTFOUND	BOOLEAN	It is the opposite value of FOUND.
ROWCOUNT	INTEGER	It is the number of rows affected by the previous statement.

The syntax is used in the following form.

```
SQL%Attribute_name
Attribute_name := ISOPEN | FOUND | NOTFOUND | ROWCOUNT
```

Each attribute can be viewed as the following example.

```
gSQL> CREATE TABLE T1
(
  C1 VARCHAR(20),
  C2 VARCHAR(20)
);
Table created.
gSQL> INSERT INTO T1 VALUES ('Seoul', '24');
1 row created.
gSQL> INSERT INTO T1 VALUES ('Pusan', '44');
1 row created.
gSQL> BEGIN
  UPDATE T1 SET C2 = C2 + 1;

  DBMS_OUTPUT.PUT_LINE('ISOPEN   = ' || SQL%ISOPEN );
  DBMS_OUTPUT.PUT_LINE('FOUND    = ' || SQL%FOUND  );
  DBMS_OUTPUT.PUT_LINE('NOTFOUND = ' || SQL%NOTFOUND );
  DBMS_OUTPUT.PUT_LINE('ROWCOUNT = ' || SQL%ROWCOUNT );
END;
/
ISOPEN   = FALSE
FOUND    = TRUE
NOTFOUND = FALSE
ROWCOUNT = 2
Anonymous PL block executed.
```

Explicit Cursor Attributes

Explicit cursor attributes is used to enquire the status of an explicit cursor. For more information about attributes, refer to the following table.

Table 19-3 Cursor attributes

Attributes	Return type	Description
%ISOPEN	BOOLEAN	It is TRUE only when a cursor is normally open. Otherwise, it is FALSE.
%FOUND	BOOLEAN	It is NULL before FETCH, and it is TRUE when FETCH is normally performed. It is FALSE when data does not exist, and it is NULL after CLOSE.
%NOTFOUND	BOOLEAN	It is the opposite value of %FOUND.
%ROWCOUNT	INTEGER	It is NULL before OPEN, and it is 0 when it is normally OPEN. It increases by 1 whenever FETCH succeeds.

It is used as follows within PSM.

```
Cursor_Name % Attribute_name
Attribute_name := ISOPEN
                | FOUND
                | NOTFOUND
                | ROWCOUNT
```

The following is an example of using an explicit cursor attribute.

```
gSQL> CREATE TABLE T1
(
  C1 VARCHAR(20),
  C2 VARCHAR(20)
);
Table created.
gSQL> INSERT INTO T1 VALUES ('Seoul', '24');
1 row created.
gSQL> INSERT INTO T1 VALUES ('Pusan', '44');
1 row created.
gSQL> DECLARE
  CURSOR C1 IS SELECT * FROM T1;
  v1 c1%ROWTYPE;
BEGIN
```

- Check if the cursor is open through ISOPEN.

```

IF C1%ISOPEN = FALSE
  THEN
    OPEN C1;
  END IF;
LOOP
  FETCH C1 INTO v1;

```

- Check if there is any more data through NOTFOUND.

```
EXIT WHEN C1%NOTFOUND;
```

- Find out the number of fetched rows through ROWCOUNT.

```

DBMS_OUTPUT.PUT_LINE('COUNT = ' || C1%ROWCOUNT );
END LOOP;
CLOSE C1;

END;
/
COUNT = 1
COUNT = 2
Anonymous PL block executed.

```

EXCEPTION Handling

Exceptions within PSM is a definition of various errors occurred while a user is executing PSM. If an error occurs at the time of operation, PSM immediately stops the operation and returns an error to a user. EXCEPTION handling is a function provided to a user to control EXCEPTION situation and keep the program running without interruption.

Exception Handler

An error situation can be controlled through an exception handler defined in PSM BLOCK as follows.

```

DECLARE
  V1 INTEGER;
BEGIN
  BEGIN
    V1 := 1 / 0;

```

- Exception handler

```

EXCEPTION WHEN OTHERS
    THEN DBMS_OUTPUT.PUT_LINE('SQLCODE = ' || SQLCODE);
         DBMS_OUTPUT.PUT_LINE('SQLERRM = ' || SQLERRM);

END;

DBMS_OUTPUT.PUT_LINE('next code');
END;
/
SQLCODE = -12122
SQLERRM = [SUNJESOFT][PSM][GOLDILOCKS]divisor is equal to zero
next code

```

In the example above, the program is stopped by *divide by zero* at the time of execution. However, if an error occurred by an exception handler, then only the corresponding BLOCK stops, but the processing continues from the next location.

An exception handler is specified as follows.

```

BEGIN
EXCEPTION WHEN exception_name, [exception_name, ...] THEN pl_statements;
           [WHEN exception_name, [exception_name, ...] THEN pl_statements;
END

```

- Features of an exception handler are as follows.
 - A single exception handler is specified in BLOCK.
 - One or more Exception_Name can be specified and its operation can be defined within an exception handler.
 - Exception_name within an exception handler should not be duplicate.
 - It is operated only for an error within PL BLOCK SCOPE in which an exception handler is specified.
 - OTHERS indicating all exceptional situations should be unique, and should be specified at last.
 - If an exception handler is normally completed, the previous errors are cleared. Therefore, a user should store them in a separate PSM variable if in need.

An exception in GOLDILOCKS has the following properties.

Table 19-4 EXCEPTION types

Type	Definer	Error code	Name	Raise implicitly	Raise explicitly
Pre-defined	Database	O	O	O	Optionally
User defined	User	User-defined	User defined	X	O



For more information about a predefined exception or a user defined exception provided by GO LDILOCKS, refer to **Exception Declaration**.

Propagating Exception

If an appropriate exception handler does not exist in the current BLOCK when an exception occurs, then it is propagated to an exception handler of the superordinate BLOCK until the exception is processed.

If an error occurred on LINE_1 in the following code, the result varies upon whether an exception handler operates.

```
BEGIN
  ...
  BEGIN
    LINE_1
    EXCEPTION HANDLER_1
  END;
  LINE_2
  EXCEPTION HANDLER_2
END;
/
```

- When it is processed in EXCEPTION_HANDLER_1
 - If the handler operation is normally completed, then it is performed from LINE_2.
- When an appropriate handler does not exist in EXCEPTION_HANDLER_1
 - It can not perform LINE_2, and the currently occurred EXCEPTION is propagated to EXCEPTION_HANDLER_2.
 - When an appropriate handler exists in EXCEPTION_HANDLER_2, if a handler operation is normally completed, then the program ends.
 - If a handler does not exist in EXCEPTION_HANDLER_2, the program stops and the currently occurred error is returned to a user.



If an error occurred in an exception handler which was processing an exception, then the error code is propagated to a superordinate BLOCK.

```
DECLARE
  V1 INTEGER;
  E1 EXCEPTION;
  E2 EXCEPTION;
BEGIN
```

```

BEGIN
  RAISE E1;
EXCEPTION WHEN E1 THEN V1 := 1 / 0; ❶ A new error occurs.
END;
EXCEPTION WHEN E1
  THEN DBMS_OUTPUT.PUT_LINE('User Exception');
  WHEN ZERO_DIVIDE
  THEN DBMS_OUTPUT.PUT_LINE('Zero divide');
END;
/
Zero divide
Anonymous PL block executed.

```

User Defined Exception

A user defined exception is an exception used by setting an exception name and an error-code by a user except for a pre-defined. User defined exception can not implicitly occur, but a user should execute it by explicitly using a RAISE statement.

The following is an example of causing an exception by using a RAISE statement.

```

DECLARE
  V1  INTEGER;
  high EXCEPTION;
  low  EXCEPTION;
BEGIN
  BEGIN
    V1 := 10;
    IF V1 > 10
    THEN
      RAISE high;
    ELSE
      RAISE low;
    END IF;
  EXCEPTION WHEN high
    THEN DBMS_OUTPUT.PUT_LINE('High');
    WHEN low
    THEN DBMS_OUTPUT.PUT_LINE('Low');
  END;
END;
/
Low

```

- A user defined exception is processed depending on the following two cases.
 - When an error-code is set
 - When an error-code is not set

It is operated as follows when a user sets an error code.

```

DECLARE
  V1 INTEGER;
  E1 EXCEPTION;
  PRAGMA EXCEPTION_INIT( E1, -12122);
BEGIN
  BEGIN
    V1 := 1 / 0;
  EXCEPTION WHEN E1
    THEN DBMS_OUTPUT.PUT_LINE('SQLCODE = ' || SQLCODE);
    DBMS_OUTPUT.PUT_LINE('SQLERRM = ' || SQLERRM);
  END;
END;
/
SQLCODE = -12122
SQLERRM = [SUNJESOFT][PSM][GOLDILOCKS]divisor is equal to zero

```

The ZERO_DIVIDE predefined exception exists, but a user sets a handler by setting an error code as E1 exception. For the program compatibility between vendors with each different error code as above, an exception handler is available of which a user directly resets an error code.

A user defined exception in which an error-code is not set is set as the following error code and message in an exception handler.

```

DECLARE
  V1 INTEGER;
  E1 EXCEPTION;
BEGIN
  BEGIN
    RAISE E1;
  EXCEPTION WHEN E1
    THEN DBMS_OUTPUT.PUT_LINE('SQLCODE = ' || SQLCODE);
    DBMS_OUTPUT.PUT_LINE('SQLERRM = ' || SQLERRM);
  END;
END;
/
SQLCODE = 1

```

SQLERRM = [SUNJESOFT][PSM][GOLDILOCKS]User-Defined Exception
Anonymous PL block executed.

A propagation process of a user defined exception is as same as that of a predefined exception. However, if an error-code is not set in a user defined exception, it is propagated as unhandled user exception error to the superordinate BLOCK.

```

DECLARE
  V1 INTEGER;
  E1 EXCEPTION;
  E2 EXCEPTION;
BEGIN
  BEGIN
    RAISE E1;
  EXCEPTION WHEN E2
    THEN DBMS_OUTPUT.PUT_LINE('SQLCODE = ' || SQLCODE);
    DBMS_OUTPUT.PUT_LINE('SQLERRM = ' || SQLERRM);
  END;
END;
/
ERR-HY000(17017): Unhandled user exception :
  RAISE E1;
  *
ERROR at line 7:

```

An unhandled user exception can be caught by specifying a user defined exception in an exception handler or by using OTHERS which is a predefined exception.

PRAGMA EXCEPTION_INIT

It is used for a user sets a specific DBMS error code when using a user defined exception. DBMS error codes varies depending on vendors, so it can be used for a compatibility of an exception handler of PSM code.

The syntax is as follows.

```

<PRAGMA EXCEPTION_INIT> ::=
  PRAGMA EXCEPTION_INIT ( exception_name, internal_errorcode )

```

- Constraints are as follows.
 - exception_name should be declared in advance.

- exception_name can not use a predefined exception.
- Only an internal error-code of GOLDILOCKS is available for internal_errorcode.
- It can not set 0 which means SUCCESS.

The following is an example of handling an exception of when assigning NULL to V1 (the PSM variable to which NOT NULL constraints are applied) by using a user defined exception.

```
DECLARE
  V1 VARCHAR(20) NOT NULL := 10;
  USER_EXCEPT EXCEPTION;
```

- Declare the PSM NOT NULL constraint error as a user defined exception.

```
PRAGMA EXCEPTION_INIT( USER_EXCEPT, -17009 );
BEGIN
```

- Generate a situation of an exception.

```
V1 := NULL;
  EXCEPTION WHEN USER_EXCEPT THEN DBMS_OUTPUT.PUT_LINE('Check Value');
END;
/
Check Value
Anonymous PL block executed.
```

The following error occurs when setting a value which is not an internal error-code of GOLDILOCKS.

```
DECLARE
  E1 EXCEPTION;
  PRAGMA EXCEPTION_INIT( E1, 99999);
BEGIN
  NULL;
END;
/
ERR-HY000(17032): PSM compilation error :
(1) at (3:30): ERR-HY000(17021): Invalid error number for PRAGMA EXCEPTION_INIT
```

DBMS_STANDARD.RAISE_APPLICATION_ERROR

It is used to easily generate an exception through an arbitrary user error code and a message, instead of explicitly defining a user exception. It belongs to a DBMS_STANDARD module, and the routines of this module can be called even when omitting a name of that module.

There are three types of arguments as follows.

Table 19-5 RAISE_APPLICATION_ERROR

Argument	Description
error_code IN NATIVE_INTEGER	It is a value of an error code to be arbitrarily generated. Only the value within the range of -20000 ~ -20999 can be used.
error_message IN VARCHAR(4000)	It is a message to be stored in SQLERRM when an error occurs.
stack_flag IN BOOLEAN := FALSE	It is a flag of whether to stack on the existing errors (TRUE), or to replace with all existing errors (FALSE). The default value is FALSE.

The following is a simple example of using it.

```
CREATE OR REPLACE PROCEDURE PROC1
IS
BEGIN
  RAISE_APPLICATION_ERROR (-20000, 'USER DEFINED ERROR TEST');
END;
/
Procedure created.
BEGIN
  PROC1;
EXCEPTION WHEN OTHERS THEN
  DBMS_OUTPUT.PUT_LINE( 'SQLCODE : ' || SQLCODE || ' SQLERRM : ' || SQLERRM );
END;
/
SQLCODE : -20000 SQLERRM : [SUNJESOFT][PSM][GOLDLOCKS]USER DEFINED ERROR TEST
Anonymous PL block executed.
```

20.

PSM Cursor Statements

20.1 Declaration

When retrieving through a PSM statement two or more results can not be returned from the database. Therefore, to retrieve two or more results, a cursor should be used by declaring and defining it.

- Cursors are specified as follows.
 - Explicit cursor
 - A user explicitly declares it through cursor declaration/ definition.
 - Implicit cursor
 - It is a cursor processed through PSM statement within the database, and they can not be defined nor is it declared by a user.

A cursor should be declared and defined in a PSM declare section before using an explicit cursor. (In the following description, a cursor means an explicit cursor.)

- A cursor declaration defines the followings.
 - Cursor name
 - Parameter list owned by a cursor
 - Return type of a cursor
- A cursor definition defines the followings.
 - Cursor name
 - Parameter list owned by a cursor
 - Return type of a cursor
 - SELECT and SELECT .. FOR UPDATE statement which are to be performed by a cursor
- Each item used in a cursor declaration and a cursor definition has the following features.
 - Cursor name
 - A cursor should be unique within the declared SCOPE.
 - The name should be shorter than 128 bytes.
 - Parameter list
 - It is defined when binding a PSM variable or a value in an SQL which is to be performed by a cursor.
 - Return type
 - It is used to strictly define the result set of validating an SQL statement owned by a cursor.
 - If a definition of the result of SQL statement owned by a cursor is different from a definition of the return type, then an error occurs.



A cursor definition should be the same type as the type of the previously declared cursor (name, parameter list, return type).

For a cursor declaration/ definition, refer to the followings.

```
DECLARE
```

- Declaration

```
CURSOR C1 RETURN T1%ROWTYPE;
```

- Declaration & definition

```
CURSOR C2 IS SELECT * FROM T1;
```

- Definition for C1

```
CURSOR C1 RETURN T1%ROWTYPE IS SELECT * FROM T1;
BEGIN
  NULL;
END;
/
```

If the declaration and definition of cursor RETURN TYPE with the same cursor_name are different, then the following error may occur.

```
gSQL> CREATE TABLE T1
(
  C1 VARCHAR(20),
  C2 VARCHAR(20)
);
Table created.
gSQL> DECLARE
  TYPE rec IS RECORD (C1 VARCHAR(20), C2 VARCHAR(20));
```

The following two cursor return types are same, but it is recognized as using different types. Therefore, an error caused by using the same cursor name occurs.

```
CURSOR C1 RETURN rec;
  CURSOR C1 RETURN T1%ROWTYPE IS SELECT * FROM T1;
BEGIN
  NULL;
END;
/
ERR-HY000(17032): PSM compilation error :
```

(1) at (4:12): ERR-HY000(17033): duplicated cursor name

If the declaration and the definition of items in a parameter list are different, then an error occurs.

DECLARE

- The declaration and the definition of a parameter are different. (Parameter name)

```
CURSOR C1 (A1 INTEGER, A2 INTEGER DEFAULT 10) RETURN T1%ROWTYPE;
  CURSOR C1 (A1 INTEGER, A3 INTEGER DEFAULT 10) RETURN T1%ROWTYPE IS
    SELECT * FROM T1;
BEGIN
  NULL;
END;
/
ERR-HY000(17032): PSM compilation error :
```

(1) at (3:12): ERR-HY000(17033): duplicated cursor name

If an SQL statement defined in a cursor should be performed by referring to a PSM variable at the run-time, then it can be defined with a parameter of a cursor.

```
DECLARE
  cursor c1 (a1 varchar ) return t1%rowtype;
  cursor c2 (a1 varchar(20) ) return t1%rowtype;
BEGIN
  NULL;
END;
/
```

If a DEFAULT clause is defined, the definition of a parameter can be omitted at the time of performing a cursor.

The following is an example of performing a cursor by inputting all parameters, and an example of performing a cursor by omitting the definition of a parameter in a DEFAULT clause.

```
gSQL> CREATE TABLE T1
(
  C1 VARCHAR(20),
  C2 VARCHAR(20)
);
Table created.
gSQL> INSERT INTO T1 VALUES ('Seoul', '24');
1 row created.
```

```

gSQL> INSERT INTO T1 VALUES ('Pusan', '44');
1 row created.
gSQL> DECLARE
    V1 VARCHAR(20);
    V2 VARCHAR(20);
    CURSOR C1 (A1 INTEGER, A2 INTEGER DEFAULT 10)
        IS SELECT * FROM T1 WHERE C2 >= A1 AND C2 <= A2;
BEGIN

```

- Perform a cursor by inputting all parameters.

```

OPEN C1 (10, 50);
    FETCH C1 INTO V1, V2;
    DBMS_OUTPUT.PUT_LINE('V1 = ' || V1 || ' , V2 = ' || V2);
    CLOSE C1;

```

- Perform a cursor by omitting a default parameter (A2).

```

OPEN C1 (10);
    FETCH C1 INTO V1, V2;
    IF C1%NOTFOUND = TRUE
    THEN
        DBMS_OUTPUT.PUT_LINE('NO DATA');
    END IF;
    CLOSE C1;
END;
/
V1 = Seoul , V2 = 24
NO DATA
Anonymous PL block executed.

```

20.2 OPEN

A select statement of a cursor can be performed through OPEN statement after declaration/ definition of the explicit cursor. If it is a SELECT .. FOR UPDATE statement, it locks rows in a result set.

If a cursor OPEN again a CURSOR which is normally OPEN, then an error occurs.

```

DECLARE
  V1 VARCHAR(20);
  V2 VARCHAR(20);
  CURSOR C1 IS SELECT * FROM T1;
BEGIN

  OPEN C1;
  OPEN C1;
END;
/
ERR-HY000(17037): cursor is already open :
  OPEN C1;
  *
ERROR at line 9:

```

If an explicit cursor has a parameter, then it is used as follows.

```

DECLARE
  v1 VARCHAR(20);
  v2 VARCHAR(20);
  cursor c1 (a1 varchar(20) ) return t1%rowtype;
  cursor c1 (a1 varchar(20) ) return t1%rowtype
  is select * from t1 where c1 = a1;
BEGIN
  OPEN c1( 'Seoul' );
  FETCH c1 INTO V1, V2;
  DBMS_OUTPUT.PUT_LINE('V1 = ' || V1 || ' , V2 = ' || V2);

END;
/
V1 = Seoul , V2 = 24
Anonymous PL block executed.

```

For more information, refer to **OPEN Statement**.

20.3 FETCH

If an explicit cursor is normally OPEN, a result can be stored as a PSM variable through a FETCH statement.

- A result is stored in the following PSM variables.
 - SQL data type variable
 - A record type variable which can store a single row
 - An associative array type variable in which a key is specified available to store a single row

The following is an example of fetching by using an SQL data type variable or through %ROWTYPE.

```
DECLARE
V1 VARCHAR(20);
V2 VARCHAR(20);
V3 T1%ROWTYPE;
CURSOR C1 IS SELECT * FROM T1;
BEGIN
OPEN C1;
```

- List of SQL type variables

```
FETCH C1 INTO V1, V2;
DBMS_OUTPUT.PUT_LINE('V1 = ' || V1 || ' , V2 = ' || V2);
```

- Single record variables

```
FETCH C1 INTO V3;
DBMS_OUTPUT.PUT_LINE('V3.C1 = ' || V3.C1 || ' , V3.C2 = ' || V3.C2);
END;
/
V1 = Seoul , V2 = 24
V3.C1 = Pusan , V3.C2 = 44
```

A record type variable used in FETCH should be separately used, and if it is used together with another variable, then an error occurs as follows.

```
gSQL> CREATE TABLE T1
(
  C1 VARCHAR(20),
  C2 VARCHAR(20)
);
```

Table created.

```
gSQL> INSERT INTO T1 VALUES ('Seoul', '24');
```

1 row created.

```
gSQL> INSERT INTO T1 VALUES ('Pusan', '44');
```

1 row created.

```
gSQL> DECLARE
```

```
    V1 VARCHAR(20);
```

```
    V2 VARCHAR(20);
```

```
    V3 T1%ROWTYPE;
```

```
    CURSOR C1 (A1 INTEGER, A2 INTEGER DEFAULT 10)
```

```
        IS SELECT * FROM T1 WHERE C2 >= A1 AND C2 <= A2;
```

```
BEGIN
```

```
    OPEN C1 (10, 50);
```

V3 is a record type and a scalar type return result can not be stored in a record type, so an error occurs.

```
FETCH C1 INTO V1, V3;
```

```
    CLOSE C1;
```

```
END;
```

```
/
```

```
ERR-HY000(17032): PSM compilation error :
```

```
(1) at (10:23): ERR-HY000(17007): invalid expression
```

For more information, refer to **FETCH Statement**.

20.4 CLOSE

It closes a cursor which is normally OPEN. Results and cursor-attributes can not be obtained from a closed cursor. When accessing to a CLOSE cursor and performing fetch, then an INVALID_CURSOR exception.

```
DECLARE
  V1 VARCHAR(20);
  V2 VARCHAR(20);
  CURSOR C1 IS SELECT * FROM T1;
BEGIN

  OPEN C1;
  CLOSE C1;
  BEGIN
    FETCH C1 INTO V1, V2;
  EXCEPTION WHEN INVALID_CURSOR
    THEN DBMS_OUTPUT.PUT_LINE('invalid cursor exception');
  END;
END;
/
invalid cursor exception
Anonymous PL block executed.
```

For more information, refer to [CLOSE Statement](#).

20.5 EXPLICIT CURSOR ATTRIBUTES

Explicit cursor attributes have the information about the current status of an explicit cursor. These attributes can be used both in an expression and a conditional expression.

An explicit cursor attribute is used as the following syntax, and refer to the following table for more information about attributes.

```
Cursor_Name % Attribute_name
Attribute_name := ISOPEN
                | FOUND
                | NOTFOUND
                | ROWCOUNT
```

Table 20-1 Cursor attributes

Attribute	Return type	Description
%ISOPEN	BOOLEAN	It is TRUE only when a cursor is normally open. Otherwise, it is FALSE.
%FOUND	BOOLEAN	It is NULL before FETCH, and it is TRUE when FETCH is normally performed. It is FALSE when data does not exist, and it is NULL after CLOSE.
%NOTFOUND	BOOLEAN	It is the opposite value of %FOUND.
%ROWCOUNT	INTEGER	It is NULL before OPEN, and it is 0 when it is normally OPEN. It increases by 1 whenever FETCH succeeds.

The following is an example of displaying how the value is changed by phase for each cursor attribute.

```
DECLARE
  V1 VARCHAR(20);
  V2 VARCHAR(20);
  CURSOR C1 IS SELECT * FROM T1;
BEGIN

  DBMS_OUTPUT.PUT_LINE('<BEFORE OPEN>');
  DBMS_OUTPUT.PUT_LINE('%ISOPEN   = [' || C1%ISOPEN   || ']');
  DBMS_OUTPUT.PUT_LINE('%FOUND     = [' || C1%FOUND     || ']');
  DBMS_OUTPUT.PUT_LINE('%NOTFOUND  = [' || C1%NOTFOUND  || ']');
  DBMS_OUTPUT.PUT_LINE('%ROWCOUNT = [' || C1%ROWCOUNT || ']');
  OPEN C1;
  DBMS_OUTPUT.PUT_LINE('<AFTER OPEN>');
  DBMS_OUTPUT.PUT_LINE('%ISOPEN   = [' || C1%ISOPEN   || ']');
```

```

DBMS_OUTPUT.PUT_LINE('%FOUND      = [ ' || C1%FOUND      || ' ]');
DBMS_OUTPUT.PUT_LINE('%NOTFOUND = [ ' || C1%NOTFOUND || ' ]');
DBMS_OUTPUT.PUT_LINE('%ROWCOUNT = [ ' || C1%ROWCOUNT || ' ]');
FETCH C1 INTO V1, V2;
DBMS_OUTPUT.PUT_LINE('<AFTER FETCH>');
DBMS_OUTPUT.PUT_LINE('%ISOPEN   = [ ' || C1%ISOPEN   || ' ]');
DBMS_OUTPUT.PUT_LINE('%FOUND     = [ ' || C1%FOUND     || ' ]');
DBMS_OUTPUT.PUT_LINE('%NOTFOUND  = [ ' || C1%NOTFOUND  || ' ]');
DBMS_OUTPUT.PUT_LINE('%ROWCOUNT = [ ' || C1%ROWCOUNT || ' ]');
CLOSE C1;
DBMS_OUTPUT.PUT_LINE('<AFTER CLOSE>>');
DBMS_OUTPUT.PUT_LINE('%ISOPEN   = [ ' || C1%ISOPEN   || ' ]');
DBMS_OUTPUT.PUT_LINE('%FOUND     = [ ' || C1%FOUND     || ' ]');
DBMS_OUTPUT.PUT_LINE('%NOTFOUND  = [ ' || C1%NOTFOUND  || ' ]');
DBMS_OUTPUT.PUT_LINE('%ROWCOUNT = [ ' || C1%ROWCOUNT || ' ]');
END;
/
<BEFORE OPEN>
%ISOPEN   = [FALSE]
%FOUND     = []
%NOTFOUND  = []
%ROWCOUNT = []
<AFTER OPEN>
%ISOPEN   = [TRUE]
%FOUND     = []
%NOTFOUND  = []
%ROWCOUNT = [0]
<AFTER FETCH>
%ISOPEN   = [TRUE]
%FOUND     = [TRUE]
%NOTFOUND  = [FALSE]
%ROWCOUNT = [1]
<AFTER CLOSE>>
%ISOPEN   = [FALSE]
%FOUND     = []
%NOTFOUND  = []
%ROWCOUNT = []

```

Anonymous PL block executed.

20.6 IMPLICIT_CURSOR_ATTRIBUTES

An implicit cursor is a cursor internally processed in a database through a PSM statement, and it has attributes whose name is as same as that of attributes owned by an explicit cursor.

For more information, refer to the following table.

Table 20-2 Implicit cursor attributes

Attribute name	Return type	Description
ISOPEN	BOOLEAN	It is always FALSE because it is internally closed.
FOUND	BOOLEAN	If the data is returned by the previous statement, then it is TRUE. Otherwise, it is FALSE.
NOTFOUND	BOOLEAN	It is the opposite value of FOUND.
ROWCOUNT	INTEGER	It is the number of rows affected by the previous statement.

The following is an example of implicit cursor attributes.

```

gSQL> CREATE TABLE T1
(
  C1 VARCHAR(20),
  C2 VARCHAR(20)
);
Table created.
gSQL> INSERT INTO T1 VALUES ('Seoul', '24');
1 row created.
gSQL> INSERT INTO T1 VALUES ('Pusan', '44');
1 row created.
gSQL> DECLARE
V1 INTEGER;
BEGIN
  SELECT COUNT(*) INTO V1 FROM T1;
  DBMS_OUTPUT.PUT_LINE('COUNT RET    = ' || V1);
  DBMS_OUTPUT.PUT_LINE('SQL%ISOPEN  = ' || SQL%ISOPEN);
  DBMS_OUTPUT.PUT_LINE('SQL%FOUND   = ' || SQL%FOUND);
  DBMS_OUTPUT.PUT_LINE('SQL%NOTFOUND = ' || SQL%NOTFOUND);
  DBMS_OUTPUT.PUT_LINE('SQL%ROWCOUNT = ' || SQL%ROWCOUNT);
END;
/
COUNT RET    = 2
SQL%ISOPEN    = FALSE
SQL%FOUND     = TRUE

```

```
SQL%NOTFOUND = FALSE
```

```
SQL%ROWCOUNT = 1
```

```
Anonymous PL block executed.
```

20.7 CURSOR VARIABLES

A cursor variable is a concept similar to an explicit cursor. However, an explicit cursor is subordinate to a single statement, a cursor variable plays a role as a point indicating one or more cursor. In other words, it can use a cursor by altering SQL syntaxes by using a single cursor variable.

- The followings are what are different from an explicit cursor.
 - It alters one or more SELECT queries and processes them with a cursor.
 - It is possible to assign each cursor variable among cursor variables.
 - It can be used in an expression.
 - It can be used as a parameter of a subprogram and schema-level procedure/ function.
 - It can not have a parameter.

It is automatically closed if a cursor open through a cursor variable gets out of the SCOPE where the cursor is declared. However, if it is used as a parameter of a subprogram and schema_level procedure/ function, then it is valid even when that procedure/ function ends until it gets out of the SCOPE where it was called.



To use a cursor variable as a parameter, a binding-mode of that parameter should be declared as OUT or IN OUT.

A cursor variable can use cursor attributes as same as those of an explicit cursor.

```

DECLARE
  v1 VARCHAR(20);
  v2 VARCHAR(20);
  cv1 SYS_REFCURSOR;
BEGIN
  DBMS_OUTPUT.PUT_LINE('Before Open');
  DBMS_OUTPUT.PUT_LINE('ISOPEN   = ' || cv1%ISOPEN );
  DBMS_OUTPUT.PUT_LINE('FOUND     = ' || cv1%FOUND );
  DBMS_OUTPUT.PUT_LINE('NOTFOUND = ' || cv1%NOTFOUND );
  DBMS_OUTPUT.PUT_LINE('ROWCOUNT = ' || cv1%ROWCOUNT );
  OPEN cv1 FOR SELECT * FROM T1;
  DBMS_OUTPUT.PUT_LINE('After Open');
  DBMS_OUTPUT.PUT_LINE('ISOPEN   = ' || cv1%ISOPEN );
  DBMS_OUTPUT.PUT_LINE('FOUND     = ' || cv1%FOUND );
  DBMS_OUTPUT.PUT_LINE('NOTFOUND = ' || cv1%NOTFOUND );
  DBMS_OUTPUT.PUT_LINE('ROWCOUNT = ' || cv1%ROWCOUNT );

```



```

FETCH cv1 INTO V1, V2;
DBMS_OUTPUT.PUT_LINE('After fetch');
DBMS_OUTPUT.PUT_LINE('ISOPEN   = ' || cv1%ISOPEN );
DBMS_OUTPUT.PUT_LINE('FOUND     = ' || cv1%FOUND );
DBMS_OUTPUT.PUT_LINE('NOTFOUND = ' || cv1%NOTFOUND );
DBMS_OUTPUT.PUT_LINE('ROWCOUNT = ' || cv1%ROWCOUNT );

END;
/
Before Open
ISOPEN   = FALSE
FOUND     =
NOTFOUND =
ROWCOUNT =
After Open
ISOPEN   = TRUE
FOUND     =
NOTFOUND =
ROWCOUNT = 0
After fetch
ISOPEN   = TRUE
FOUND     = TRUE
NOTFOUND = FALSE
ROWCOUNT = 1
Anonymous PL block executed.

```

Cursor variable can be used as a parameter of a subprogram and a schema-level procedure/ function as follows.

```

gSQL> CREATE TABLE T1
(
  C1 VARCHAR(20),
  C2 VARCHAR(20)
);
Table created.
gSQL> INSERT INTO T1 VALUES ('Seoul', '24');
1 row created.
gSQL> INSERT INTO T1 VALUES ('Pusan', '44');
1 row created.
gSQL> DECLARE
  v1 VARCHAR(20);

```

```
v2 VARCHAR(20);
cv1 SYS_REFCURSOR;
PROCEDURE PROC1 ( A_CV1 IN OUT SYS_REFCURSOR )
IS
BEGIN
```

- Open a cursor by using an input parameter cursor variable.

```
OPEN A_CV1 FOR SELECT * FROM T1;
END;
BEGIN
PROC1( cv1 );
```

- Fetch it by using a cursor variable which was used as a parameter.

```
FETCH cv1 INTO V1, V2;
DBMS_OUTPUT.PUT_LINE('V1 = ' || V1 || ' , V2 = ' || V2);

END;
/
V1 = Seoul , V2 = 24
Anonymous PL block executed.
```

For more information, refer to [Cursor Variable Declaration](#).

OPEN and Close Cursor Variables

It can OPEN a cursor through a cursor variable if using an OPEN FOR statement within PSM. Also, it can CLOSE a cursor of a cursor variable through a CLOSE statement as same as an explicit cursor.

If an already open cursor exists in a cursor variable at the time of performing a cursor through an OPEN FOR statement, then that cursor is automatically closed and a new cursor is OPEN.

The following is an example of using a cursor variable.

```
gSQL> CREATE TABLE T1
(
C1 VARCHAR(20),
C2 VARCHAR(20)
);
Table created.
```

```

gSQL> INSERT INTO T1 VALUES ('Seoul', '24');
1 row created.
gSQL> INSERT INTO T1 VALUES ('Pusan', '44');
1 row created.
gSQL> DECLARE
  v1 VARCHAR(20);
  v2 VARCHAR(20);
  cv1 SYS_REFCURSOR;
BEGIN
  OPEN cv1 FOR SELECT * FROM T1;

```

- Fetch with cursor-variable

```

FETCH cv1 INTO V1, V2;

  DBMS_OUTPUT.PUT_LINE('V1 = ' || V1 || ' , V2 = ' || V2);
  CLOSE cv1;
END;
/
V1 = Seoul , V2 = 24
Anonymous PL block executed.

```

For more information, refer to [OPEN FOR Statement](#), [CLOSE Statement](#).

Fetching Data With Cursor Variables

Like as an explicit cursor, it can store the result processed in a database through a fetch statement as a PS M variable.

For more information, refer to [FETCH Statement](#).

Assign Values to Cursor Variables

It is possible to assign a cursor variable each other if RETURN-TYPEs are same. If it is not a cursor variable type, then an error occurs.

It is performed with the following assign statement.

```
target_cursor_variable := source_cursor_variable
```

Assigning a cursor variable makes a cursor pointer indicated by target_cursor_variable indicate a cursor having Source_cursor_variable. Therefore, after it is normally assigned, a cursor already open in a target cursor variable is not valid nor is it accessible. Also, a cursor is internally cleared when getting out of the SCOPE in which a cursor variable is declared.

```
DECLARE
  v1 VARCHAR(20);
  v2 VARCHAR(20);
  cv1 SYS_REFCURSOR;
  cv2 SYS_REFCURSOR;
BEGIN
```

- Open cv1

```
OPEN cv1 FOR SELECT * FROM T1;
```

- Assign cv1 to cv2

```
cv2 := cv1;
```

- Fetch from cv2

```
FETCH cv2 INTO v1, v2;
  DBMS_OUTPUT.PUT_LINE('v1 = ' || v1 || ' , v2 = ' || v2);

END;
/
V1 = Seoul , V2 = 24
```

The following is an example of using the same cursor by assigning after each cursor variable performs OPEN.

```
gSQL> CREATE TABLE T1
(
  C1 VARCHAR(20),
  C2 VARCHAR(20)
);
Table created.
gSQL> INSERT INTO T1 VALUES ('Seoul', '24');
1 row created.
```

```

gSQL> INSERT INTO T1 VALUES ('Pusan', '44');
1 row created.
gSQL> DECLARE
  cv1 SYS_REFCURSOR;
  cv2 SYS_REFCURSOR;
  v1 t1%ROWTYPE;
BEGIN

```

- Each cursor variable OPEN a cursor.

```

OPEN cv1 FOR select * from t1 where c1 = 'Seoul';
OPEN cv2 FOR select * from t1 where c1 = 'Pusan';

```

- Assign cursor-variable
- A cursor of cv2 is not valid any more.

```

cv2 := cv1;

```

- Fetch the result of cv1.

```

FETCH cv2 INTO v1;

  DBMS_OUTPUT.PUT_LINE('C1 = ' || v1.C1 || ' , C2 = ' || v1.C2);
END;
/
C1 = Seoul , C2 = 24
Anonymous PL block executed.

```

21.

Using PSM Subprograms

21.1 Anonymous PL Block

An anonymous PL block is an SQL statement for a one-time execution of a PSM statement instead of storing a PSM statement in the database. An anonymous PL block is a one of a regular SQL provided by GOLDILOCKS, so it is used in the same way as other SQLs in ODBC, JDBC and precompiler which are provided by GOLDILOCKS. A syntax is as same as a syntax of a general basic block. For more information, refer to **Block (BEGIN .. END)**.

```

<<Label>> ❶ (optional)
DECLARE ❷ (optional)
❸ declare items (variables, cursors, types, ...) (optional)
BEGIN ❹ (required)
❺ PSM statements to execute (required)
EXCEPTION ❻ Exception Handling Part (optional)
END;

```

Refer to the following instructions when using an anonymous PL block.

Interface	Instructions for use
in common	A bind parameter can be used unlike a schema-level procedure/ function. It also supports a prepare-execute method.
ODBC	It is used completely same as a general SQL.
JDBC	A CallableStatement class should be used if it has a bind parameter with IN-OUT or OUT attribute. (Refer to CallableStatement .)
Precompiler (gpec)	N/A
Interactive command tool (gsq)	It should notify the end of the statement by entering '/'<Enter> after inputting an anonymous PL block.

21.2 Nested Procedure

A nested procedure is a procedure type subprogram declared within a specific PL block. A nested procedure has a scope which can be referenced only on a declared PL block and its subordinates.

For more information, refer to **Procedure Declaration and Definition**.

```

DECLARE
  PROCEDURE PROC1( A1 INTEGER ) ❶ Define Nested Procedure
  IS
  BEGIN
    DBMS_OUTPUT.PUT_LINE( 'A1 = ' || A1 );
  END;
BEGIN
  PROC1( 100 ); ❷ Call Nested Procedure
END;
/

```

The followings are items available within a nested subprogram.

- An argument variable of a nested subprogram
- A PL block in which a nested subprogram is defined, and variables and various items (type, cursor,...) defined in its superordinate scope.
- A bind parameter when it is an anonymous PL block. (e.g. '?', ':V1')

A nested procedure supports a forward declaration, so it can separately specify a declare statement and a define statement. By using this, a logic of cross call between two nested procedures can be implemented.

```

gSQL> DECLARE
  PROCEDURE PROC1( A1 INTEGER ); ❶ Declare proc1
  PROCEDURE PROC2( A1 INTEGER ) ❷ Define proc2
  IS
  BEGIN
    IF A1 > 0 THEN
      DBMS_OUTPUT.PUT_LINE( '(proc2)A1 = ' || A1 );
      PROC1( A1 -1 ); ❸ Call proc1
    END IF;
  END;
  PROCEDURE PROC1( A1 INTEGER ) ❹ Define proc1
  IS
  BEGIN
    IF A1 > 0 THEN

```

```

        DBMS_OUTPUT.PUT_LINE( '(proc1)A1 = ' || A1 );
        PROC2( A1 -1 ); ⑤ Call proc2
    END IF;
END;
BEGIN
    PROC1(5); ⑥ Call proc1
END;
/

```

(proc1)A1 = 5

(proc2)A1 = 4

(proc1)A1 = 3

(proc2)A1 = 2

(proc1)A1 = 1

Anonymous PL block executed.

GOLDILOCKS PSM limits the maximum subordinate statement depths to 50 to prevent the infinite cross referencing. If it is exceeded, then the following error occurs. (It is also applied same to a nested function, schema-level procedure/ function.)

```

gSQL> DECLARE
    PROCEDURE PROC1( A1 INTEGER ); ① declare proc1
    PROCEDURE PROC2( A1 INTEGER ) ② define proc2
    IS
    BEGIN
        DBMS_OUTPUT.PUT_LINE( 'A1 = ' || A1 );
        PROC1( A1 -1 );
    END;
    PROCEDURE PROC1( A1 INTEGER ) ③ define proc1
    IS
    BEGIN
        DBMS_OUTPUT.PUT_LINE( 'A1 = ' || A1 );
        PROC2( A1 -1 );
    END;
BEGIN
    PROC1(100);
END;
/

```

ERR-42000(16411): maximum number of recursive SQL levels (50) exceeded.

21.3 Nested Function

A nested function is as same as a nested procedure, but it is a subprogram in function form. For more information, refer to [Function Declaration and Definition](#).

```
gSQL> DECLARE
  V1 INTEGER := 0;
  FUNCTION FUNC1( A1 INTEGER )
    RETURN INTEGER
  IS
  BEGIN
    RETURN A1 * 10;
  END;
BEGIN
  V1 := FUNC1( 10 );
  DBMS_OUTPUT.PUT_LINE( 'V1 = ' || V1 );
END;
/
V1 = 100
```

Anonymous PL block executed.

A nested function can be used in all PSM expressions within a visible scope, but is can not be used in an SQL statement.

```
gSQL> DECLARE
  V1 INTEGER := 0;
  FUNCTION FUNC1( A1 INTEGER )
    RETURN INTEGER
  IS
  BEGIN
    RETURN A1 * 10;
  END;
BEGIN
  SELECT FUNC1(10) INTO V1 FROM DUAL;
  DBMS_OUTPUT.PUT_LINE( 'V1 = ' || V1 );
END;
/
```

ERR-HY000(17032): PSM compilation error :

(1) at (10:3): ERR-HY000(17079): a nested function not allowed in executing SQL

21.4 Schema-level Procedure

A schema-level subprogram is an SQL object which has a name and is stored in a database. A schema-level procedure is a schema-level subprogram in procedure form.

Creating Schema-level Procedure

A schema-level procedure is created as follows. A precision and a scale value should be specified if in need.

For more information, refer to **CREATE PROCEDURE**.

```
CREATE OR REPLACE PROCEDURE PROC1( A1 INTEGER, A2 INTEGER )
IS
  V1 INTEGER;
BEGIN
  SELECT COUNT(*)
  INTO V1
  FROM T1
  WHERE T1.I1 >= A1 AND T1.I1 <= A2;
  DBMS_OUTPUT.PUT_LINE( 'V1 = ' || V1 );
END;
/
```

The information about a created schema-level procedure can be found with a INFORMATION_SCHEMA.ROUTINES table.

For more information, refer to **ROUTINES**.

```
gSQL> SELECT SPECIFIC_NAME, ROUTINE_DEFINITION
FROM INFORMATION_SCHEMA.ROUTINES
WHERE SPECIFIC_NAME = 'PROC1';
SPECIFIC_NAME ROUTINE_DEFINITION
-----
PROC1          PROCEDURE "PUBLIC"."PROC1" ( A1 INTEGER, A2 INTEGER )
IS
  V1 INTEGER;
BEGIN
  SELECT COUNT(*)
  INTO V1
```

```

        FROM T1
        WHERE T1.I1 >= A1 AND T1.I1 <= A2;
        DBMS_OUTPUT.PUT_LINE( 'V1 = ' || V1 );
    END;

```

1 row selected.

The information about an argument can be found with a INFORMATION_SCHEMA.PARAMETERS table. For more information, refer to **PARAMETERS**.

```

gSQL> SELECT P.PARAMETER_NAME, P.ORDINAL_POSITION
FROM   INFORMATION_SCHEMA.ROUTINES    R,
       INFORMATION_SCHEMA.PARAMETERS  P
WHERE  R.SPECIFIC_NAME = 'PROC1'
       AND R.SPECIFIC_SCHEMA = P.SPECIFIC_SCHEMA
       AND R.SPECIFIC_NAME = P.SPECIFIC_NAME
ORDER BY P.ORDINAL_POSITION;

```

PARAMETER_NAME	ORDINAL_POSITION
A1	1
A2	2

2 rows selected.

Using Schema-level Procedure

A schema-level procedure is used by an inner statement of other PSM or by a CALL statement. Other PSM statements call a schema-level procedure in the same form of a nested procedure.

```

gSQL> BEGIN
    PROC1( 2, 4 ); ❶ Call schema-level procedure
END;
/
V1 = 3

```

Anonymous PL block executed.

A CALL statement which is an SQL executing the given PSM is executed as follows. For more information, refer to **CALL Statement**.

```
gSQL> CALL PROC1( 2, 4 );
V1 = 3
Procedure Call complete.
```

It supports the following syntax for a procedure to support a procedure call escape sequence used in ODBC or JDBC.

```
{ CALL procedure_name( param1, param2, ... ) }
```

A syntax of a procedure call escape sequence is used like as a general SQL.

```
gSQL> { CALL PROC1(2, 4) };
V1 = 3
Procedure Call complete.
```

gsq which is an interactive command tool of GOLDILOCKS does not support performing a procedure through \EXEC which is the tool's own command.

The following options about a privilege of when executing a schema-level procedure can be specified. If a user except for a definer performs an SQL within PSM according to these options, it may refer to a table with the same name in different schemas according to the definition of that user's schema-path. (A name of the object used when declaring an item (e.g. T1%ROWTYPE) is always interpreted as a definer.)

- AUTHID DEFINER (default): The user is altered to the user created that procedure, then it is performed.
- AUTHID CURRENT_USER: The user is not altered, and it is performed by the current user.

```
CREATE OR REPLACE PROCEDURE "PROC1"( A1 INTEGER, A2 INTEGER )
AUTHID CURRENT_USER
IS
  V1 INTEGER;
BEGIN
  SELECT COUNT(*)
  INTO V1
  FROM T1
  WHERE T1.I1 >= A1 AND T1.I1 <= A2;
  DBMS_OUTPUT.PUT_LINE( 'V1 = ' || V1 );
END;
/
```

Dropping Schema-level Procedure

A schema-level procedure is dropped by the following DROP PROCEDURE statement. For more information, refer to **DROP PROCEDURE**.

```
DROP PROCEDURE PROC1;
```

It also supports IF EXISTS statement like as other DROP statements of GOLDILOCKS.

```
DROP PROCEDURE IF EXISTS PROC1;
```

Recompiling Schema-level Procedure

If an object referenced inside of a schema-level subprogram is altered, then it may affect the corresponding subprogram and should create the execution plan again.

Referenced Object in a Declarative Part or an Argument

If the used object is altered when defining various items in a declarative part or an argument type, then the procedure plan is automatically recompiled.

- An object used in %TYPE, %ROWTYPE
- An object used in an explicit cursor definition statement

If the corresponding procedure is performed for the first time after an object is altered, then the plan is automatically recreated according to the following order.

1. Bring the plan of the corresponding procedure from a plan cache.
2. Search for objects which were altered during validating an object list of that plan.
3. Discard the current plan, and create a new plan from a procedure definition statement stored in a dictionary.
4. Register a newly created plan on a plan cache.
5. Execute the plan.

Referenced Object in an SQL of the Body

An SQL plan used in the body is not stored in a procedure plan, and only the SQL text is stored. When executing a procedure, it creates a plan by compiling the corresponding SQL statement in real time, then executes it. Therefore, an SQL object used within a body does not affect the procedure plan itself.

However, if an object is altered, the number or type of binds which are the existing interfaces of a procedure may be altered, or columns may be dropped. Therefore, an error may occur when executing it if the procedure is not appropriately altered.

21.5 Schema-level Function

A schema-level function is a schema-level subprogram in function form, which is used within an expression.

Creating Schema-level Function

A schema-level function is created as follows. A precision and a scale value of an argument type should be specified if in need.

For more information, refer to **CREATE FUNCTION**.

```
gSQL> CREATE OR REPLACE FUNCTION FUNC1( A1 INTEGER, A2 INTEGER )
RETURN INTEGER
IS
  V1 INTEGER;
BEGIN
  SELECT COUNT(*)
  INTO V1
  FROM T1
  WHERE T1.I1 >= A1 AND T1.I1 <= A2;
  RETURN V1;
END;
/
Function created.
```

Like as a procedure, a created schema-level function is found through **INFORMATION_SCHEMA.ROUTINES** and **INFORMATION_SCHEMA.PARAMETERS** table.

Using Schema-level Function

A schema-level function can be used in all expressions in which a general SQL or an SQL object within **PSM** can be used.

```
gSQL> SELECT FUNC1( 2, 4 ) FROM DUAL;
FUNC1( 2, 4 )
-----
3
```

1 row selected.

It is used as follows within PSM.

```
gSQL> DECLARE
  V1 INTEGER;
BEGIN
  V1 := FUNC1( 2, 4 );
  DBMS_OUTPUT.PUT_LINE( 'V1 = ' || V1 );
END;
/
V1 = 3
Anonymous PL block executed.
```

It can be performed by using CALL statement as follows.

For more information, refer to **CALL Statement**.

```
gSQL> \var V1 INTEGER
gSQL> CALL FUNC1( 2, 4 ) INTO :V1;
Procedure Call complete.
gSQL> \print V1
V1
--
3
```

Like as a schema-level procedure, a procedure call escape sequence statement is also supported.

```
{ ? = CALL function_name( param1, param2, ... ) }
```

```
gSQL> { :V1 = CALL FUNC1( 2, 4 ) };
Procedure Call complete.
gSQL> \print V1
V1
--
3
```

Dropping Schema-level Function

A schema-level function is dropped by the following DROP FUNCTION statement.

For more information, refer to **DROP FUNCTION**.

```
gSQL> DROP FUNCTION FUNC1;  
Function dropped.
```

21.6 Built-in Procedures

GOLDILOCKS PSM provides the following built-in procedures to debug or process the exception when materializing the procedure and the function.

Table 21-1 Built-in procedures

Procedure	Description
DBMS_OUTPUT.ENABLE(buffer_size IN NATIVE_INTEGER := 20000)	It activates a message logging feature to the given buffer size. If the buffer size is not given it is set to 20000 bytes by default. If the feature is already activated then it discards all messages and creates a new buffer.
DBMS_OUTPUT.DISABLE	It deactivates a message logging feature. All messages previously logged are discarded.
DBMS_OUTPUT.SET_LOG(file_path IN VARCHAR(4000))	It simultaneously outputs on the file in a given path when logging a message. If the given path is a relative path (its first letter is not /), then it searches for a target file below a directory corresponding to <SYSTEM_LOGGER_DIR> property.
DBMS_OUTPUT.PUT_LINE(item IN VARCHAR(4000))	It stores a message made with a given expression on a buffer.
DBMS_OUTPUT.GET_LINE(line OUT VARCHAR(4000), status OUT NATIVE_INTEGER)	It returns the oldest single line which is not read among messages stored on a buffer. If there is a message, a status returns 0, if there is not any message it returns 1.
DBMS_STANDARD.RAISE_APPLICATION_ERROR(error_code IN NATIVE_INTEGER, error_message IN VARCHAR(4000), stack_flag IN BOOLEAN := FALSE)	It generates an arbitrary user exception, and error_code should be the value between -20000 and -20999. If it is TRUE, the last stack_flag argument stacks a given error on the existing errors. If it is FALSE, the corresponding error replaces all errors. (It can be omitted, and the default is FALSE when it is omitted.)

```

gSQL> DECLARE
V1 VARCHAR(1024);
V2 INTEGER;
BEGIN
  DBMS_OUTPUT.ENABLE(2000);
  DBMS_OUTPUT.PUT_LINE('TEST MSG');
  DBMS_OUTPUT.GET_LINE( V1, V2);
  DBMS_OUTPUT.PUT_LINE('V1 = ' || v1);
  DBMS_OUTPUT.PUT_LINE('V2 = ' || v2);
END;
/

```

```
V1 = TEST MSG
```

```
V2 = 0
```

```
Anonymous PL block executed.
```

A message logging feature is managed per each section, and gsql (an interactive command tool of GOLD ILOCKS) can turn on or off the message logging feature with a serveroutput option. If any content remains in a message buffer after performing PSM, all are automatically output.

```
gSQL> \set serveroutput on
gSQL> \var msg VARCHAR(4000)
gSQL> \var status NATIVE_INTEGER
gSQL> CALL DBMS_OUTPUT.PUT_LINE( 'aaa' );
aaa
Procedure Call complete.
gSQL> CALL DBMS_OUTPUT.PUT_LINE( 'bbb' );
bbb
Procedure Call complete.
gSQL> CALL DBMS_OUTPUT.GET_LINE( :msg, :status );
Procedure Call complete.
gSQL> \print msg
MSG
----
null
gSQL> \print status
STATUS
-----
1
```

22.

Using SQLs in PSM

22.1 Static SQLs

Static SQLs are SQLs that can be used in PSM, and they are classified as follows.

- SELECT
- INSERT
- UPDATE
- DELETE
- RETURNING INTO
- LOCK TABLE
- COMMIT, ROLLBACK, SAVEPOINT

A static SQL is an extended SQL to perform SQL supported by GOLDILOCKS through PSM variables. This chapter describes features and precautions of a static SQL available only in PSM.

SELECT

A SELECT statement within PSM receives the result returned from the database, and stores the value in a PSM variable specified in the INTO clause. The result set of GOLDILOCKS PSM through SELECT INTO can be stored only in a single row.

It can be specified as follows.

```
SELECT target_list INTO variable_list FROM table_expression
```

For more information, refer to [Data Query Language](#).

The following is an example of storing a value in a variable declared as an SQL data type by using SELECT statement within PSM.

```
DECLARE
  V1 INTEGER;
BEGIN
  DBMS_OUTPUT.PUT_LINE( 'V1 =[' || V1 || ']');
```

- It stores the result in the variable V1 through SELECT INTO.

```
SELECT 1 INTO V1 FROM DUAL;
  DBMS_OUTPUT.PUT_LINE( 'V1 = ' || V1);
END;
```



```

/
V1 =[]
V1 = 1

```

The following is an example of storing value in a variable declared as a record type.

```

DECLARE
  TYPE rec is RECORD (F1 INTEGER, F2 INTEGER );
  var1 rec;
BEGIN
  DBMS_OUTPUT.PUT_LINE( 'Var1.f1 =[ ' || Var1.f1 || ' ]');
  DBMS_OUTPUT.PUT_LINE( 'Var1.f2 =[ ' || Var1.f2 || ' ]');

```

- Store the result in var which is a record type variable.

```

SELECT 1, 2 INTO var1 FROM DUAL;
  DBMS_OUTPUT.PUT_LINE( 'Var1.f1 = ' || Var1.f1);
  DBMS_OUTPUT.PUT_LINE( 'Var1.f2 = ' || Var1.f2);
END;
/
Var1.f1 =[
Var1.f2 =[
Var1.f1 = 1
Var1.f2 = 2

```

If a result set which has two or more results of SELECT statement is returned from the database, then the following error occurs. A user can catch the error by using TOO_MANY_ROWS exception among predefined exceptions.

```

gSQL> CREATE TABLE T1
(
  C1 VARCHAR(20),
  C2 VARCHAR(20)
);
Table created.
gSQL> INSERT INTO T1 VALUES ('Seoul', '24');
1 row created.
gSQL> INSERT INTO T1 VALUES ('Pusan', '44');
1 row created.
gSQL> DECLARE
  v1 VARCHAR(20);
  v2 VARCHAR(20);

```

```

BEGIN
  BEGIN
    SELECT * INTO V1, V2 FROM T1;
  EXCEPTION WHEN TOO_MANY_ROWS
    THEN DBMS_OUTPUT.PUT_LINE( 'SQLCODE=' || SQLCODE);
    DBMS_OUTPUT.PUT_LINE( 'SQLERRM=' || SQLERRM);
  END;
END;
/
SQLCODE=-16289
SQLERRM=[SUNJESOFT][PSM][GOLDILOCKS]into clause can have only one row
Anonymous PL block executed.

```

If a result does not exist in SELECT INTO, then an error occurs. A user can catch the error by using NO_DATA_FOUND exception among predefined exceptions.

```

DECLARE
  V1 T1%ROWTYPE;
BEGIN
  SELECT * INTO V1 FROM T1 WHERE C1 = 'NONE';
END;
/
ERR-HY000(17041): execution fail :
  SELECT * INTO V1 FROM T1 WHERE C1 = 'NONE';
  *
ERROR at line 4:
ERR-HY000(17045): no data found

```



If a result of SELECT INTO statement is stored through a record type in GOLDILOCKS, it can not be used by mixing together with a different type variable. If they are used being mixed together, the following error may occur.

```

DECLARE
  TYPE rec is RECORD (F1 INTEGER, F2 INTEGER );
  var1 rec;
  v1 integer;
BEGIN
  DBMS_OUTPUT.PUT_LINE( 'Var1.f1 =[ ' || Var1.f1 || ' ]');
  DBMS_OUTPUT.PUT_LINE( 'Var1.f2 =[ ' || Var1.f2 || ' ]');
  SELECT 1, 2, 3 INTO Var1, v1 FROM DUAL;

```

```

DBMS_OUTPUT.PUT_LINE( 'Var1.f1 = ' || Var1.f1);
DBMS_OUTPUT.PUT_LINE( 'Var1.f2 = ' || Var1.f2);
END;
/
ERR-HY000(17032): PSM compilation error :
(1) at (9:29): ERR-HY000(17046): variables of record type can not be mixed with other
variables

```

However, it can be used as follows when a user uses a partial field of a record type by mixing with the SQL data type variable.

```

gSQL> CREATE TABLE T1
(
  C1 VARCHAR(20),
  C2 VARCHAR(20)
);
Table created.
gSQL> INSERT INTO T1 VALUES ('Seoul', '24');
1 row created.
gSQL> INSERT INTO T1 VALUES ('Pusan', '44');
1 row created.
gSQL> DECLARE
  v1 t1%ROWTYPE;
  v2 VARCHAR(20);
BEGIN
  SELECT * INTO V1.C1, V2 FROM T1
  WHERE C1 = 'Seoul';

```

- A value is not stored in V1.c2.

```

DBMS_OUTPUT.PUT_LINE('V1.c1 = ' || V1.C1 || ' , V1.c2 = ' || V1.C2);
DBMS_OUTPUT.PUT_LINE('V2 = ' || V2);
END;
/
V1.c1 = Seoul , V1.c2 =
V2 = 24
Anonymous PL block executed.

```

INSERT

An INSERT statement in PSM provides the following expansion features.

- It can store the data in the database by using a user defined record type variable.
- It can store the data in RETURNING INTO clause by using a record type variable.

In PSM, it can inserts the data in the following form through a record type variable.

```
INSERT INTO table_name VALUES record_type_variable
```

For more information, refer to **Inserting Data**.

The following is an example of storing the record in the database by using PSM variable declared as an SQL data type.

```
gSQL>
CREATE TABLE T1
(
  C1 INTEGER,
  C2 INTEGER
);
Table created.
gSQL>
DECLARE
  V1 INTEGER;
  V2 INTEGER;
BEGIN
  V1 := 10;
  V2 := 20;

  INSERT INTO T1 (C1, C2) VALUES (V1, V2);
  COMMIT;
END;
/
Anonymous PL block executed.
gSQL> SELECT * FROM T1;
C1 C2
-- --
10 20
1 row selected.
```

The following is an example of inserting which uses a record type variable declared with %ROWTYPE.

```
gSQL>
CREATE TABLE T1
(
  C1 INTEGER,
  C2 INTEGER
);
Table created.
gSQL>
DECLARE
  V1 T1%ROWTYPE;
BEGIN
  V1.C1 := 10;
  V1.C2 := 20;

  INSERT INTO T1 VALUES V1;
  COMMIT;
END;
/
Anonymous PL block executed.
gSQL> SELECT * FROM T1;
C1 C2
-- --
10 20
1 row selected.
```

For more information, refer to **%ROWTYPE**.

The following is an example of storing the record in the database by using a user defined record type variable.

```
gSQL>
CREATE TABLE T1
(
  C1 INTEGER,
  C2 INTEGER
);
Table created.
gSQL>
DECLARE
  TYPE rec IS RECORD (F1 INTEGER, F2 INTEGER);
```

```

v1 rec;
BEGIN
  V1.F1 := 10;
  V1.F2 := 20;

  INSERT INTO T1 VALUES V1;
  COMMIT;
END;
/
Anonymous PL block executed.
gSQL> SELECT * FROM T1;
C1 C2
-- --
10 20
1 row selected.

```

For more information, refer to [User Defined Record Type](#).



If a record type variable is specified in a form other than PSM insert expansion, then the following error occurs.

```

gSQL>
DECLARE
  TYPE rec IS RECORD (F1 INTEGER, F2 INTEGER);
  v1 rec;
  v2 INTEGER;
BEGIN
  V1.F1 := 10;
  V1.F2 := 20;
  V2 := 30;

  INSERT INTO T1 (c1, c2) VALUES (V1);
  COMMIT;
END;
/
ERR-HY000(17032): PSM compilation error :
(1) at (11:3): ERR-42000(16053): not enough values

```

In the example above, two columns are listed and a variable of a specified VALUES clause is one. Though it is a record type variable, but the number of values to be bound is different, so an error occurs as above.

To use a variable by mixing with a type different from a record type, then it should be specified in a scalar type as follows.

```

gSQL>
DECLARE
  TYPE rec IS RECORD (F1 INTEGER, F2 INTEGER);
  v1 rec;
  v2 INTEGER;
BEGIN
  V1.F1 := 10;
  V1.F2 := 20;
  V2 := 30;

  INSERT INTO T1 (c1, c2) VALUES (V1.F1, V2);
  COMMIT;
END;
/
Anonymous PL block executed.
gSQL> SELECT * FROM T1;
C1 C2
-- --
10 30
1 row selected.

```

UPDATE

The followings are features expanded from PSM.

- It can alter the database value to a value in a record type variable by using SET ROW clause.
- It can store the value of before/ after the alteration as a PSM variable through RETURNING INTO clause.

A record type variable can be used in the following form through an UPDATE expansion feature within PSM.

```
UPDATE table_list SET ROW = Record_type_variable [WHERE condition]
```

For more information, refer to **Updating Data**.

The following is an example of altering the record through a PSM record type variable and UPDATE ... SET ROW clause.

```

gSQL> CREATE TABLE T1
(
  C1 INTEGER,
  C2 INTEGER
);
Table created.
gSQL> INSERT INTO T1 VALUES (1, 1);
1 row created.
gSQL> DECLARE
  V1 T1%ROWTYPE;
BEGIN
  V1.C1 := 10;
  V1.C2 := 20;

  UPDATE T1 SET ROW = V1 WHERE c1 = 1;
  COMMIT;
END;
/
Anonymous PL block executed.
gSQL> SELECT * FROM T1;
C1 C2
-- --
10 20
1 row selected.

```

DELETE

An expansion feature of PSM DELETE is as follows.

- It can store the deleted value as a record type variable through RETURNING INTO.

The following is an example of performing DELETE through PSM variable of SQL data type.

```

gSQL> CREATE TABLE T1
(
  C1 INTEGER,
  C2 INTEGER
);
Table created.
gSQL> INSERT INTO T1 VALUES (1, 1);

```



```
1 row created.
gSQL> DECLARE
  V1 INTEGER;
BEGIN
  V1 := 1;

  DELETE FROM T1 WHERE C1 = V1;
  COMMIT;
END;
/
Anonymous PL block executed.
gSQL> SELECT * FROM T1;
no rows selected.
```

RETURNING INTO

It can store the result of processing DML (INSERT, UPDATE, DELETE) as a PSM variable by using RETURNING INTO clause.

- It has following restrictions when storing the result in RETURNING INTO of PSM.
 - The result returned to the database can be stored only in a single row. (Two or more results can not be stored.)
 - It can not be used together with a different type variable when storing as a record type variable.

INSERT RETURNING INTO

INSERT RETURNING INTO clause stores the result value stored in the database as a PSM variable specified in RETURNING INTO clause.

The following is an example of storing the result of performing *insert* in a PSM variable.

```
gSQL>
DECLARE
  v1 INTEGER;
  v2 INTEGER;
  v3 INTEGER;
  v4 INTEGER;
BEGIN
  V1 := 10;
  V2 := 20;
```

```

INSERT INTO T1 (c1, c2) VALUES (V1, V2)
RETURNING * INTO V3, V4;
DBMS_OUTPUT.PUT_LINE( 'V3 = ' || V3 );
DBMS_OUTPUT.PUT_LINE( 'V4 = ' || V4 );
END;
/
V3 = 10
V4 = 20

```

The following is an example storing the result of a *returning into* by using a record type variable.

```

gSQL>
DECLARE
  v1 INTEGER;
  v2 INTEGER;
  v3 T1%ROWTYPE;
BEGIN
  V1 := 10;
  V2 := 20;

  INSERT INTO T1 (c1, c2) VALUES (V1, V2)
  RETURNING * INTO V3;
  DBMS_OUTPUT.PUT_LINE( 'V3.C1 = ' || V3.C1 );
  DBMS_OUTPUT.PUT_LINE( 'V3.C2 = ' || V3.C2 );
END;
/
V3.C1 = 10
V3.C2 = 20
Anonymous PL block executed.

```

UPDATE RETURNING INTO

UPDATE RETURNING INTO can store the result before/ after the alteration in the database through a PSM variable specified in RETURNING INTO clause.

It stores the result of RETURNING INTO through an SQL type variable as follows.

```

gSQL> CREATE TABLE T1
(
  C1 INTEGER,
  C2 INTEGER

```

```

);
Table created.
gSQL> INSERT INTO T1 VALUES (1, 1);
1 row created.
gSQL> DECLARE
  V1 INTEGER;
  V2 INTEGER;
  V3 INTEGER;
  V4 INTEGER;
BEGIN
  V1 := 1;
  V2 := 2;

```

- It stores the result of when before it is altered by UPDATE in V3 and variable V3.

```

UPDATE T1 SET C2 = V2 WHERE C1 = V1
RETURNING OLD * INTO V3, V4;
DBMS_OUTPUT.PUT_LINE('OLD');
DBMS_OUTPUT.PUT_LINE('V3 = ' || V3);
DBMS_OUTPUT.PUT_LINE('V4 = ' || V4);
ROLLBACK;

```

- It stores the result of when after it is altered by UPDATE in V3 and variable V3.

```

UPDATE T1 SET C2 = V2 WHERE C1 = V1
RETURNING NEW * INTO V3, V4;
DBMS_OUTPUT.PUT_LINE('NEW');
DBMS_OUTPUT.PUT_LINE('V3 = ' || V3);
DBMS_OUTPUT.PUT_LINE('V4 = ' || V4);
END;
/
OLD
V3 = 1
V4 = 1
NEW
V3 = 1
V4 = 2
Anonymous PL block executed.

```

The following is an example of storing the result of RETURNING INTO by using a record type variable.

```

gSQL> CREATE TABLE T1
(
  C1 INTEGER,
  C2 INTEGER
);
Table created.
gSQL> INSERT INTO T1 VALUES (1, 1);
1 row created.
gSQL> DECLARE
  V1 INTEGER;
  V2 INTEGER;
  V3 T1%ROWTYPE;
BEGIN
  V1 := 1;
  V2 := 2;

```

- Store the result in a record type variable (V3).

```

UPDATE T1 SET C2 = V2 WHERE C1 = V1
RETURNING OLD * INTO V3;
DBMS_OUTPUT.PUT_LINE('OLD');
DBMS_OUTPUT.PUT_LINE('V3.C1 = ' || V3.C1);
DBMS_OUTPUT.PUT_LINE('V3.C2 = ' || V3.C2);
ROLLBACK;

```

- Store the result in a record type variable (V3).

```

UPDATE T1 SET C2 = V2 WHERE C1 = V1
RETURNING NEW * INTO V3;
DBMS_OUTPUT.PUT_LINE('NEW');
DBMS_OUTPUT.PUT_LINE('V3.C1 = ' || V3.C1);
DBMS_OUTPUT.PUT_LINE('V3.C2 = ' || V3.C2);
END;
/
OLD
V3.C1 = 1
V3.C2 = 1
NEW
V3.C1 = 1
V3.C2 = 2
Anonymous PL block executed.

```

DELETE RETURNING INTO

DELETE RETURNING INTO can store the data of a row deleted from the database in a PSM variable.

The following is an example of using SQL type variables.

```
gSQL> CREATE TABLE T1
(
  C1 INTEGER,
  C2 INTEGER
);
Table created.
gSQL> INSERT INTO T1 VALUES (1, 1);
1 row created.
gSQL> DECLARE
  V1 INTEGER;
  V2 INTEGER;
  V3 INTEGER;
BEGIN
  V3 := 1;
```

- Store the data of when before DELETE in the variable V1 and V2.

```
DELETE FROM T1 WHERE C1 = V3
RETURNING * INTO V1, V2;
DBMS_OUTPUT.PUT_LINE('V1 = ' || V1 );
DBMS_OUTPUT.PUT_LINE('V2 = ' || V2 );
END;
/
V1 = 1
V2 = 1
Anonymous PL block executed.
```

The following is an example of storing the data of when before DELETE through a record type variable.

```
gSQL> CREATE TABLE T1
(
  C1 INTEGER,
  C2 INTEGER
);
Table created.
gSQL> INSERT INTO T1 VALUES (1, 1);
```

```

1 row created.
gSQL> DECLARE
  V1 T1%ROWTYPE;
  V3 INTEGER;
BEGIN
  V3 := 1;

```

- Store the data of when before DELETE in the variable V3.

```

DELETE FROM T1 WHERE C1 = V3
RETURNING * INTO V1;
DBMS_OUTPUT.PUT_LINE('V1.C1 = ' || V1.C1 );
DBMS_OUTPUT.PUT_LINE('V1.C2 = ' || V1.C2 );
END;
/
V1.C1 = 1
V1.C2 = 1
Anonymous PL block executed.

```

COMMIT, ROLLBACK, SAVEPOINT

COMMIT, ROLLBACK, SAVEPOINT statements permanently store the transaction result which occurred within PSM in the database, or rolls back it to the state of when before the alteration.

COMMIT

COMMIT permanently stores the transaction result in the database. It is used as follows.

```

CREATE TABLE T1
(
  C1 INTEGER,
  C2 INTEGER
);
Table created.
INSERT INTO T1 VALUES (1, 1);
1 row created.
DECLARE
  V3 INTEGER;
BEGIN
  V3 := 1;

```

```

DELETE FROM T1 WHERE C1 = V3;
COMMIT;
END;
/
Anonymous PL block executed.
SELECT * FROM T1;
no rows selected.

```

ROLLBACK

ROLLBACK rolls back the transaction to its previous state. It is used as follows.

```

gSQL> CREATE TABLE T1
(
  C1 INTEGER,
  C2 INTEGER
);
Table created.
gSQL> INSERT INTO T1 VALUES (1, 1);
1 row created.
gSQL> COMMIT;
Commit complete.
gSQL> DECLARE
  V3 INTEGER;
BEGIN
  V3 := 1;

  DELETE FROM T1 WHERE C1 = V3;
  ROLLBACK;
END;
/
Anonymous PL block executed.

```

- Verify if the DELETE ROLLBACK data is normally retrieved in PSM.

```

gSQL> SELECT * FROM T1;
C1 C2
-- --
1  1
1 row selected.

```

SAVEPOINT

SAVEPOINT rolls back a transaction to the user defined location by using ROLLBACK TO SAVEPOINT statement.

```
gSQL> CREATE TABLE T1
(
  C1 INTEGER,
  C2 INTEGER
);
Table created.
gSQL> INSERT INTO T1 VALUES (1, 1);
1 row created.
gSQL> DECLARE
  V1 INTEGER;
BEGIN
  UPDATE T1 SET C2 = 10 WHERE C1 = 1;
  SELECT C2 INTO V1 FROM T1 WHERE C1 = 1;
  DBMS_OUTPUT.PUT_LINE('Before delete: V1 = ' || V1 );
```

- Assign the current location as a SAVEPOINT.

```
SAVEPOINT SV1;
DELETE FROM T1 WHERE C1 = 1;
```

- ROLLBACK it to the savepoint SV1.

```
ROLLBACK TO SAVEPOINT SV1;
```

- Verify if it is normally ROLLBACK to the SAVEPOINT.

```
SELECT C2 INTO V1 FROM T1 WHERE C1 = 1;
DBMS_OUTPUT.PUT_LINE('After Rollback: V1 = ' || V1 );
END;
/
Before delete: V1 = 10
After Rollback: V1 = 10
Anonymous PL block executed.
```

22.2 Dynamic SQL

Unlike a static SQL, the syntax of a dynamic SQL is determined at the time of execution.

In PSM, a dynamic SQL created by a user at run-time can be performed through EXECUTE IMMEDIATE or OPEN FOR statement.

- A dynamic SQL is used in the following cases.
 - When an SQL statement can not be determined when compiling. (e.g. When an SQL statement should be altered according to conditions.)
 - When an SQL which is not supported in a static SQL is performed. (e.g. DDL)
- The syntax of a dynamic SQL is unknown until the time of execution, so a run-time error may occur due to a syntax error, existence of a target object and validation of a user privilege.
- A dynamic SQL can be used in the following PSM statements.
 - **EXECUTE IMMEDIATE Statement**
 - **OPEN FOR Statement**

EXECUTE IMMEDIATE

Various dynamic SQLs can be performed in EXECUTE IMMEDIATE. However, a statement in a form of an SQL extension provided by PSM can not be used.

The statement is provided in the following form.

```
EXECUTE IMMEDIATE 'dynamic sql' [ USING [IN | OUT | INOUT] variable_list] [INTO variable_list]
[RETURNING INTO variable_list]
```

A value stored in a PSM variable can be applied to a database through USING, INTO, RETURNING INTO statements which are provided to an EXECUTE IMMEDIATE statement, or a value can be stored from a database to a PSM variable. The differences of using each statement are as follows.

- USING
 - It uses an IN-mode when applying a value of PSM variable to an SQL.
 - It uses an OUT-mode when storing the result of SQL processing in a PSM variable.
 - Therefore, if uses an OUT-mode, it should be described with PSM variables. (An expression is not available.)
 - An IN-mode is applied when a binding type of the variable specified in USING clause is not specified.
 - It is operated as same as using SELECT INTO clause when a target of SELECT is returned as USING OUT.

- Only a single row can be returned from the database. If two or more results occurs then an error occurs.
- A PSM variable in a USING IN clause can use only a form of scalar type.
- A PSM variable in a USING OUT clause can use a record type, but it can not use it by mixing with another type.
- INTO
 - It is used when storing the result of SELECT which is internally processed in a database using an implicit cursor.
 - It can be used only when executing SELECT clause using a dynamic SQL method. (SELECT INTO clause can not be used.)
 - A PSM variable can be a record-type, but it can not be used by mixing with another type.
- RETURNING INTO
 - It is used when storing the before/ after of the data processed by INSERT/ UPDATE/ DELETE.
 - It can store only a single row.
 - A PSM variable can be a record-type, but it can not be used by mixing with another type.

The following is an example of outputting the SELECT INTO statement result by using a dynamic SQL.

```

gSQL> CREATE TABLE T1
(
  C1 VARCHAR(20),
  C2 VARCHAR(20)
);
Table created.
gSQL> INSERT INTO T1 VALUES ('Seoul', '24');
1 row created.
gSQL> INSERT INTO T1 VALUES ('Pusan', '44');
1 row created.
gSQL> DECLARE
  V1 VARCHAR(20);
  V2 VARCHAR(20);
BEGIN
  EXECUTE IMMEDIATE 'SELECT * INTO ?, ? FROM T1 WHERE C1 = ''Seoul'''
  USING OUT V1, OUT V2;
  DBMS_OUTPUT.PUT_LINE('V1 = ' || V1);
  DBMS_OUTPUT.PUT_LINE('V2 = ' || V2);
END;
/
V1 = Seoul
V2 = 24
Anonymous PL block executed.

```

The following is an example of performing an altering operation and storing the result of when before the alteration in a variable specified in RETURNING INTO.

```

gSQL> CREATE TABLE T1
(
  C1 VARCHAR(20),
  C2 VARCHAR(20)
);
Table created.
gSQL> INSERT INTO T1 VALUES ('Seoul', '24');
1 row created.
gSQL> INSERT INTO T1 VALUES ('Pusan', '44');
1 row created.
gSQL> DECLARE
  V1 VARCHAR(20);
  V2 VARCHAR(20);
  V3 VARCHAR(20);
  V4 VARCHAR(20);
BEGIN
  V1 := 'Daegu';
  V2 := '50';
  EXECUTE IMMEDIATE
    'UPDATE T1 SET C1 = ? , C2 = ? WHERE C1 = ''Seoul'' RETURNING OLD * INTO ?, ?'
  USING V1, V2 RETURNING INTO V3, V4;
  DBMS_OUTPUT.PUT_LINE('V3 = ' || V3);
  DBMS_OUTPUT.PUT_LINE('V4 = ' || V4);
END;
/
V3 = Seoul
V4 = 24
Anonymous PL block executed.

```

For more information, refer to [EXECUTE IMMEDIATE Statement](#).

OPEN FOR, FETCH and CLOSE

When processing a query by using EXECUTE IMMEDIATE, the database can not return one or more results. If an SQL to be processed is a dynamic SQL, and two or more result sets should be fetched, like as a cursor, then use OPEN FOR.

The a dynamic SQL in the following form can be used in OPEN FOR statement.

```
OPEN Cursor_variable FOR dynamic_sql [USING variable_list]
```

The following is an example of performing OPEN FOR statement through a dynamic SQL.

```
gSQL> CREATE TABLE T1
(
  C1 VARCHAR(20),
  C2 VARCHAR(20)
);
Table created.
gSQL> INSERT INTO T1 VALUES ('Seoul', '24');
1 row created.
gSQL> INSERT INTO T1 VALUES ('Pusan', '44');
1 row created.
gSQL> DECLARE
  v1 VARCHAR(20);
  v2 VARCHAR(20);
  v3 VARCHAR(20);
  cv1 SYS_REFCURSOR;
  sqlstr VARCHAR(1024);
BEGIN

  sqlstr := 'SELECT * FROM T1 WHERE C1 >= ?';
  v3 := 'AAAA';
  OPEN cv1 FOR sqlstr USING v3;
  FETCH cv1 INTO v1, v2;
  DBMS_OUTPUT.PUT_LINE('V1 = ' || v1 || ' , V2 = ' || v2);
  CLOSE cv1;
END;
/
V1 = Seoul , V2 = 24
Anonymous PL block executed.
```

- USING clause in OPEN FOR statement has the following constraints.
 - Binding mode
 - Only IN mode is available.
 - Available items
 - PSM variable
 - Value expression whose result is returned as a scalar type

For more information, refer to **OPEN FOR Statement**, **FETCH Statement**, **CLOSE Statement**.

23.

PSM Language Element References

23.1 Assignment Statement

Function

Within a PSM block, it stores a value in a variable or in an out-bind parameter.

Syntax

```
<assignment statement> ::=  
    <assignment target> := <value expression>  
    ;  
<assignment target> ::=  
    collection_variable ( index )  
    | cursor_variable  
    | :host_cursor_variable  
    | out_parameter  
    | :host_variable [ :indicator_variable ]  
    | record_variable . field_name  
    | scalar_variable
```

Invocation and Access Rules

It can be used only within PSM. (e.g. package, procedure, function)

It can be used only in the body section of a PL block.

Syntax Rules and Parameters

- collection_variable
 - It is the variable name of COLLECTION type declared in DECLARE section.
- index
 - It is the key value which selects an element among elements of collection_variable.
- cursor_variable
 - It is the cursor name declared in DECLARE section.
- host_variable

- It is the name of out/ in-out type client-side variable which is transferred from where calling PSM.
- `indicator_variable`
 - It is the indicator variable name to check the NULL value of `host_variable` and to find out the actual length of the value.
- `record_variable`
 - It is the variable name of RECORD type which has already been declared in DECLARE section.
- `field_name`
 - It is the name of a field among fields included in a RECORD type variable.
- `scalar_variable`
 - It is the variable name of a general scalar type which has already been declared in DECLARE section.

Description

Targets of assignment statements are classified into an external bind parameter and an internal PSM variable.

- External parameter
 - Host variable
 - Host cursor variable
- Internal variable
 - Out type function argument
 - Internally declared variable
 - Scalar/ record/ multi-set type
 - A specific field of a record type variable
 - A specific element of multi-set type variable

All variables except for a procedure/ function parameter can have a name assigning a scope.

Examples

The following is an example of using an assignment statement.

- Assignment for PSM internal variable

```
gSQL> DECLARE
  V1 INTEGER := 0;
BEGIN
  FOR I IN 1..10 LOOP
```

```

    V1 := V1 + I;
END LOOP;
DBMS_OUTPUT.PUT_LINE( 'V1 = ' || V1 );
END;
/
V1 = 55
Anonymous PL block executed.

```

- Assignment for a host variable

```

gSQL> \var P1 INTEGER
gSQL>
BEGIN
  :P1 := 100;
END;
/
gSQL> \print P1
P1
---
100
Anonymous PL block executed.

```

Compatibility

The differences between an assignment statement of GOLDILOCKS and that of SQL standard are as follows.

- An assignment statement of the SQL standard defines a singleton variable assignment and a multiple variable assignment, but GOLDILOCKS supports only a singleton variable assignment.
- An assignment statement of the SQL standard starts with SET keyword, but GOLDILOCKS does not use SET keyword.
- An assignment statement of the SQL standard uses an equal operator (=) between a target and a value, but GOLDILOCKS uses :=.

Table 23-1 SQL standard compatibility

Feature ID	Description	Compatibility
P002	Computational completeness	X
P006	Multiple assignment	X

For More Information

Refer to the followings.

- **Scalar Variable Declaration**
- **Record Variable Declaration**
- **COLLECTION Variable Declaration**
- **Cursor Variable Declaration**

23.2 Basic LOOP Statement

Function

It repeatedly performs statements within LOOP until the LOOP is terminated by performing GOTO or EXIT.

Syntax

```
<basic loop statement> ::=  
    LOOP { <SQL procedure statement> ; }... END LOOP [ loop_name ]  
    ;
```

Invocation and Access Rules

It can be used only within PSM. (e.g. package, procedure, function)

It can be used only in the body section of a PL block.

Syntax Rules and Parameters

- loop_name
 - It is the label name of <basic loop statement>.
 - Its role is only a comment, so it does not matter even when it is different from the real label name of <basic loop statement>.

Description

A basic loop statement is repeatedly performs statements within LOOP.

A basic loop statement is a loop-family statement, so it can be a target statement which GOTO, EXIT, and CONTINUE indicates as a label.

Examples

```

DECLARE
  V1 INTEGER := 1;
BEGIN
  LOOP
    DBMS_OUTPUT.PUT_LINE( 'V1 = ' || V1 );
    V1 := V1 + 1;
    EXIT WHEN V1 > 2;
  END LOOP;
END;
/
V1 = 1
V1 = 2
Anonymous PL block executed.

```

Compatibility

<basic loop statement> statement is as same as <loop statement> of the SQL standard.

Table 23-2 SQL standard compatibility

Feature ID	Description	Compatibility
P002	Computational completeness	O

For More Information

Refer to the followings.

- **CONTINUE Statement**
- **EXIT Statement**
- **GOTO Statement**

23.3 Block (BEGIN .. END)

Function

It creates a new scope and defines a variable, a cursor, a type and an exception.

Syntax

```
<PSM block> ::=
    [ DECLARE <declare item>... ] BEGIN <SQL procedure statement list> END
    ;
<declare item> ::=
    <variable declaration>
    | <explicit cursor declaration>
    | <cursor variable declaration>
    | <type declaration>
    | <exception declaration>
<executable statement list> ::=
    [ <label list> ] { <SQL procedure statement> ; }...
<label list> ::=
    { << identifier >> }...
<SQL procedure statement>
    <PSM Static SQL>
    | <PSM Dynamic SQL>
    | <PSM Control Statement>
```

Invocation and Access Rules

It can be used only within PROCEDURE, FUNCTION or an anonymous block.

Syntax Rules and Parameters

- Variable declaration
 - It declares scalar/ record/ array type variables which are to be used in a block.
- Cursor variable declaration
 - It declares a cursor variable to be used in a block.
- Cursor declaration
 - It declares a cursor to be used in a block.
- Type declaration
 - It declares user defined types to be used when declaring a variable within a block.
- Exception declaration
 - It defines exceptions to be processed in an exception processing statement.
- Static SQL
 - It indicates Data Manipulation Language (DML) and Data Control Language (DCL) which can be performed in PSM.
- Dynamic SQL
 - It indicates statements related to dynamic query processing supported by GOLDILOCKS PSM.
- PSM Control Statement
 - It indicates various flow control statements supported by GOLDILOCKS PSM.

Description

<psm block> is a basic component of PSM.

A block can have a declaration part and a exception handling part.

A block can be duplicated, and the duplicated block has a new subordinate variable scope. A superordinate block can not refer to a variable in a subordinate block.

Examples

```
gSQL> <<MAIN>>
DECLARE
  V1 INTEGER := 1;
BEGIN
  DBMS_OUTPUT.PUT_LINE( 'V1 = ' || V1 );
<<SUB1>>
DECLARE
  V1 VARCHAR(10) := 'ABC';
```

```

BEGIN
  DBMS_OUTPUT.PUT_LINE( 'V1 = ' || V1 );
  DBMS_OUTPUT.PUT_LINE( 'SUB1.V1 = ' || SUB1.V1 );
  DBMS_OUTPUT.PUT_LINE( 'MAIN.V1 = ' || MAIN.V1 );
END;
END;
/
V1 = 1
V1 = ABC
SUB1.V1 = ABC
MAIN.V1 = 1
Anonymous PL block executed.

```

Compatibility

<compound statement> of the SQL standard defines ATOMIC /NOT ATOMIC statement which specifies a new savepoint, but GOLDLOCKS does not support it.

Table 23-3 SQL standard compatibility

Feature ID	Description	Remarks
P002	Computational completeness	It does not support ATOMIC statement.

For More Information

Refer to [Overview of PSM](#).

23.4 CASE Statement

Function

It performs a statement list satisfying conditions which returns TRUE among given conditions.

Syntax

```

<case statement> ::=
    <simple case statement>
    | <searched case statement>
    ;
<simple case statement> ::=
    CASE <case operand> <simple case statement when clause>...
    [ <case statement else clause> ]
    END CASE
<searched case statement> ::=
    CASE <searched case statement when clause>...
    [ <case statement else clause> ]
    END CASE
<simple case statement when clause> ::=
    WHEN <when operand>
        THEN <executable statement list>
<searched case statement when clause> ::=
    WHEN <search condition>
        THEN <executable statement list>
  
```

Invocation and Access Rules

It can be used only within PSM. (e.g. package, procedure, function)

It can be used only in the body section of a PL block.

Syntax Rules and Parameters

- Case operand
 - They are all expressions which can be evaluated with a scalar value.
 - However, it can not include a subquery statement.
- When operand
 - It is an expression to compare whether it is as same as <case operand>.
 - However, it can not include a subquery statement.
- Search condition
 - It is a conditional expression to be performed when the evaluation result of <searched case statement> is TRUE.
 - However, it can not include a subquery statement.
- Executable statement list
 - It is a list of all statements which can be performed within PSM.

Description

It performs statements in WHEN clause returning TRUE by evaluating conditions like as IF statement. It evaluates conditional expressions in order, and stops evaluating after finding the TRUE conditional clause.

If the case satisfying the condition does not exist and ELSE clause is not specified, then an error occurs.

Examples

Using a Simple CASE

```
gSQL> DECLARE
V1 integer := 0;
BEGIN
  SELECT 2 INTO V1 FROM DUAL;
  CASE V1 WHEN 0 THEN DBMS_OUTPUT.PUT_LINE ('Result = 0');
          WHEN 1 THEN DBMS_OUTPUT.PUT_LINE ('Result = 1');
          WHEN 2 THEN DBMS_OUTPUT.PUT_LINE ('Result = 2');
          ELSE DBMS_OUTPUT.PUT_LINE ('Result = OTHER');
  END CASE;
END;
/
```

Result = 2

Anonymous PL block executed.

Using a Searched CASE

```

gSQL> DECLARE
V1 integer := 0;
BEGIN
  SELECT 2 INTO V1 FROM DUAL;
  CASE WHEN V1 = 0 THEN DBMS_OUTPUT.PUT_LINE ('Result = 0');
        WHEN V1 = 1 THEN DBMS_OUTPUT.PUT_LINE ('Result = 1');
        WHEN V1 = 2 THEN DBMS_OUTPUT.PUT_LINE ('Result = 2');
        ELSE DBMS_OUTPUT.PUT_LINE ('Result = OTHER');
  END CASE;
END;
/
Result = 2
Anonymous PL block executed.

```

Compatibility

CASE statement of the SQL standard defines the comparison of row type (list type) values, but GOLDILOC KS does not support it.

CASE statement of the SQL standard can define multiple conditions in a list in <when operand> by delimiting them with ',', but GODILOCKS does not support it.

Table 23-4 SQL standard compatibility

Feature ID	Description	Remarks
P002	Computational completeness	It does not support P004, P008.
P004	Extended CASE statement	-
P008	Comma-separated predicates in simple CASE statement	-

23.5 CLOSE Statement

Function

It closes an open cursor.

Syntax

```
<close statement> ::=  
    CLOSE cursor_name  
    ;
```

Invocation and Access Rules

It can be used only within PSM. (e.g. package, procedure, function)

It can be used only in the body section of a PL block.

Syntax Rules and Parameters

- cursor_name
 - It is the name of a cursor to be closed.

Description

It closes an open cursor.

A closed cursor can be opened again by using an open statement.

Examples

```
gSQL> CREATE TABLE T1 ( I1 INTEGER );  
Table created.  
gSQL> COMMIT;  
Commit complete.  
gSQL> DECLARE  
    CURSOR C1 IS SELECT I1 FROM T1;  
    V1 T1%ROWTYPE;  
BEGIN  
    OPEN C1;  
    FETCH C1 INTO V1;  
    CLOSE C1;  
END;  
/  
Anonymous PL block executed.
```

Compatibility

The SQL standard does not define it.

For More Information

Refer to the followings.

- [FETCH Statement](#)
- [OPEN Statement](#)

23.6 Collection Method Invocation

Function

It provides a method which can explore a collection type variable.

Syntax

```
<collection method> ::=  
    variable_name . <method>  
    ;  
<method> ::=  
    first ()  
    | last ()  
    | prior ( expression )  
    | next ( expression )  
    | count ()  
    | exists ( expression )  
    | delete ( expression )
```

Invocation and Access Rules

It can be used only within PSM. (e.g. package, procedure, function)

It can be used only in the body section of a PL block.

Syntax Rules and Parameters

- It can be used only in a variable declared as a collection type.
- FIRST, LAST, COUNT can not have a parameter.
- A parameter should be specified when an object should be specified such as PRIOR, NEXT, EXISTS, DELETE.
- DELETE is operated as same as PSM statement, and it can not return a different variable as a result. (It can not be used in an expression.)

Description

Refer to the following table.

Table 23-5 Function

Name	Function	Return value	Whether to require an argument
FIRST	It returns the smallest key.	A key type specified in INDEX OF	X
LAST	It returns the biggest key.	A key type specified in INDEX OF	X
PRIOR	It returns a key smaller than the input key.	A key type specified in INDEX OF	O
NEXT	It returns a key bigger than the input key.	A key type specified in INDEX OF	O
COUNT	It returns the stored count.	INTEGER	X
DELETE	It deletes a value corresponding to a key.	N/A	O
EXISTS	It returns whether a key exists or not.	BOOLEAN	O

Examples

```

DECLARE
TYPE rec IS TABLE OF VARCHAR(20) INDEX BY VARCHAR(20);
v1 rec;
v2 VARCHAR(20);
BEGIN
  DBMS_OUTPUT.PUT_LINE( '-----');
  DBMS_OUTPUT.PUT_LINE( 'first = ' || v1.first);
  DBMS_OUTPUT.PUT_LINE( 'last = ' || v1.last);
  DBMS_OUTPUT.PUT_LINE( 'prior = ' || v1.prior('aaa'));
  DBMS_OUTPUT.PUT_LINE( 'next = ' || v1.next('aaa'));
  DBMS_OUTPUT.PUT_LINE( 'count = ' || v1.count());
  FOR I IN 1 .. 9
  LOOP
    v1('a' || to_char(i)) := 'a' || to_char(i);
  END LOOP;
  DBMS_OUTPUT.PUT_LINE( '-----');
  DBMS_OUTPUT.PUT_LINE( 'first = ' || v1.first);
  DBMS_OUTPUT.PUT_LINE( 'last = ' || v1.last);
  DBMS_OUTPUT.PUT_LINE( 'count = ' || v1.count());
  DBMS_OUTPUT.PUT_LINE( '-----');

```

```

DBMS_OUTPUT.PUT_LINE( 'Print all from first to last');
v2 := v1.first;
WHILE v2 IS NOT NULL
LOOP
    DBMS_OUTPUT.PUT_LINE('Key= ' || v2 || ',Value=' || v1(v2));
    v2 := v1.next(v2);
END LOOP;
DBMS_OUTPUT.PUT_LINE( '-----');
DBMS_OUTPUT.PUT_LINE( 'Print all from last to first');
v2 := v1.last;
WHILE v2 IS NOT NULL
LOOP
    DBMS_OUTPUT.PUT_LINE('Key= ' || v2 || ',Value=' || v1(v2));
    v2 := v1.prior(v2);
END LOOP;
v1.delete(v1.first());
DBMS_OUTPUT.PUT_LINE('count = ' || v1.count() );
DBMS_OUTPUT.PUT_LINE('first = ' || v1.first() );
END;
/
-----

first =
last =
prior =
next =
count = 0
-----

first = a1
last = a9
count = 9
-----

Print all from first to last
Key= a1,Value=a1
Key= a2,Value=a2
Key= a3,Value=a3
Key= a4,Value=a4
Key= a5,Value=a5
Key= a6,Value=a6
Key= a7,Value=a7
Key= a8,Value=a8
Key= a9,Value=a9

```

```
Print all from last to first
```

```
Key= a9,Value=a9
```

```
Key= a8,Value=a8
```

```
Key= a7,Value=a7
```

```
Key= a6,Value=a6
```

```
Key= a5,Value=a5
```

```
Key= a4,Value=a4
```

```
Key= a3,Value=a3
```

```
Key= a2,Value=a2
```

```
Key= a1,Value=a1
```

```
count = 8
```

```
first = a2
```

```
Anonymous PL block executed.
```

For More Information

Refer to [COLLECTION Variable Declaration](#).

23.7 COLLECTION Variable Declaration

Function

It declares a collection variable.

Syntax

```
<declare record variable> ::=
    variable_name <collectionType>
    ;

<Collection Type Definition> ::=
    TYPE <Type-Name> IS TABLE OF <Element-Type> INDEX BY <Index-Type>
    ;

<Element-Type> ::=
    Built-in SQL Data Type
    | User-Defined Type
    | %TYPE
    | %ROWTYPE

<Index-Type> ::=
    INTEGER
    | LONG
    | CHAR(n)
    | VARCHAR(n)
```

Invocation and Access Rules

It can be used only within PSM. (e.g. package, procedure, function)

It can be used only in the declaration section of a PL block.

Syntax Rules and Parameters

- Type-name
 - It specifies the name of a collection type to be used by a user.
- Element-type
 - It specifies the type of an element to be stored in a collection variable.
- Index-type
 - It specifies the data type of a key stored in a collection variable.

Description

It declares a collection type.

Examples

```
gSQL> DECLARE
TYPE rec IS TABLE OF VARCHAR(20) INDEX BY VARCHAR(20);
v1 rec;
v2 VARCHAR(20);
BEGIN
  DBMS_OUTPUT.PUT_LINE( 'first = ' || v1.first);
  DBMS_OUTPUT.PUT_LINE( 'last = ' || v1.last);
  DBMS_OUTPUT.PUT_LINE( 'prior = ' || v1.prior('aaa'));
  DBMS_OUTPUT.PUT_LINE( 'next = ' || v1.next('aaa'));
  DBMS_OUTPUT.PUT_LINE( 'count = ' || v1.count());
  FOR I IN 1 .. 10
  LOOP
    v1('a' || i) := 'a' || i;
  END LOOP;
  DBMS_OUTPUT.PUT_LINE( 'first = ' || v1.first);
  DBMS_OUTPUT.PUT_LINE( 'last = ' || v1.last);
  DBMS_OUTPUT.PUT_LINE( 'count = ' || v1.count());
  DBMS_OUTPUT.PUT_LINE( 'Print all from first to last');
  v2 := v1.first;
  WHILE v2 IS NOT NULL
  LOOP
    DBMS_OUTPUT.PUT_LINE('Key= ' || v2 || ',Value=' || v1(v2));
```

```
        v2 := v1.next(v2);
    END LOOP;
    DBMS_OUTPUT.PUT_LINE( 'Print all from last to first');
    v2 := v1.last;
    WHILE v2 IS NOT NULL
    LOOP
        DBMS_OUTPUT.PUT_LINE('Key= ' || v2 || ',Value=' || v1(v2));
        v2 := v1.prior(v2);
    END LOOP;
END;
/
first =
last =
prior =
next =
count = 0
first = a1
last = a9
count = 10
Print all from first to last
Key= a1,Value=a1
Key= a10,Value=a10
Key= a2,Value=a2
Key= a3,Value=a3
Key= a4,Value=a4
Key= a5,Value=a5
Key= a6,Value=a6
Key= a7,Value=a7
Key= a8,Value=a8
Key= a9,Value=a9
Print all from last to first
Key= a9,Value=a9
Key= a8,Value=a8
Key= a7,Value=a7
Key= a6,Value=a6
Key= a5,Value=a5
Key= a4,Value=a4
Key= a3,Value=a3
Key= a2,Value=a2
Key= a10,Value=a10
Key= a1,Value=a1
```

Anonymous PL block executed.

Compatibility

The SQL standard does not define it.

For More Information

Refer to [Collection Method Invocation](#).

23.8 CONTINUE Statement

Function

It stops currently performing statement list, and performs the next iteration of a superordinate loop statement.

Syntax

```
<continue statement> ::=  
    CONTINUE [ label_name ] [ WHEN condition ]  
    ;
```

Invocation and Access Rules

It can be used only within PSM. (e.g. package, procedure, function)

It can be used only in the body section of a PL block.

A statement with a target label should be one of the following loop family statements.

- basic loop statement
- for loop statement
- while statement
- forall statement

Syntax Rules and Parameters

- Label name
 - It can have an identifier chain form.
- Condition
 - If it is specified, it returns to a loop statement only when the condition is TRUE.

Description

It stops currently performing statement list, and returns to the superordinate loop statement.

If a label is specified, it returns to the superordinate loop statement of the label name.

If a label is not specified, it returns to the nearest superordinate loop statement.

If multiple superordinate loop statements with the same names exist, then the nearest statement is selected.

It can return to a loop statement (exist in a nested scope) which is visible in the current location.

If a condition is specified, then it returns only when the condition is TRUE.

If a condition is not specified, then it definitely returns.

Examples

```
DECLARE
  V1 INTEGER := 1;
BEGIN
  <<AAA>>
  WHILE V1 <= 10 LOOP
    DBMS_OUTPUT.PUT_LINE( 'V1 = ' || V1 );
    V1 := V1 + 1;
    IF V1 <= 2 THEN
      DBMS_OUTPUT.PUT_LINE( 'CONTINUE' );
      CONTINUE;
    ELSE
      EXIT;
    END IF;
    DBMS_OUTPUT.PUT_LINE( 'END-OF-WHILE' );
  END LOOP AAA;
END;
/
V1 = 1
CONTINUE
V1 = 2
Anonymous PL block executed.
```

Compatibility

<continue statement> statement is similar to <iterate statement> of the SQL standard. However, <iterate statement> statement does not provide WHEN condition feature.

For More Information

Refer to the followings.

- [EXIT Statement](#)
- [GOTO Statement](#)

23.9 Cursor FOR LOOP Statement

Function

It performs loops as many times as the number of rows in the result created by a query or a cursor declared by a user in PSM.

Syntax

```

<Cursor For Loop statement> ::=
    FOR <Variable_Name> IN <Cursor>
    LOOP
        { <SQL procedure statement> ; }...
    END LOOP [ Label_Name ]
    ;
<Cursor> ::=
    < ( Implicit_Cursor_Query ) >
    | < Explicit_Cursor_Name > [ ( [ <actual param> ] ) ]

<Implicit_Cursor_Query> ::=
    SELECT statement
    | SELECT_FOR_UPDATE statement
    | INSERT_RETURNING_QUERY statement
    | UPDATE_RETURNING_QUERY statement
    | DELETE_RETURNING_QUERY statement
<actual param> ::=
    ( expression [ , expression ] .. )

```

Invocation and Access Rules

It can be used only within PSM. (e.g. package, procedure, function)

It can be used only in the body of PSM.

Syntax Rules and Parameters

The variable declared within For~Loop is valid only within that loop scope. (The variable can not be referenced from outside of that Cursor For Loop Block Scope)

When Using Cursor Name

A cursor should already have been declared before performing LOOP by using a cursor name. For more information about an actual param, refer to **OPEN Statement**.

When Using Cursor Query

It can perform only the query which can be internally processed by using an implicit cursor in GOLDILOCK S such as a select and a returning query.

Description

It performs PSM statements within a loop by turning around loops as many time as the number of results created by a cursor.

If a cursor becomes invalid (e.g. closed) during LOOP, it does not perform the loop and it processes it as an error.

If an explicit cursor name is specified and the corresponding cursor is already opened, then it is processed as an error.

The variable to which a result of the cursor specified in FOR LOOP clause is returned is automatically created. (It is created as a row type of the result set to be returned by an execution result of a cursor.)

However, if an alias for a select target expression which is not a column of a specific table among results of a user cursor query is not specified, then an error may occur.

Examples

Using Explicit Cursor

```
DECLARE  
CURSOR c1 IS SELECT * FROM T1;  
BEGIN
```

```

FOR rec IN C1
LOOP
    DBMS_OUTPUT.PUT_LINE( 'RowCount=' || c1%rowcount || ',C1=' || rec.c1 || ', C2=' ||
rec.c2);
    END LOOP;
END;
/
RowCount=1,C1=1, C2=1
RowCount=2,C1=2, C2=2
RowCount=3,C1=3, C2=3
RowCount=4,C1=4, C2=4
RowCount=5,C1=5, C2=5
RowCount=6,C1=6, C2=6
RowCount=7,C1=7, C2=7
RowCount=8,C1=8, C2=8
RowCount=9,C1=9, C2=9
RowCount=10,C1=10, C2=10
Anonymous PL block executed.

```

Using Cursor Query

```

BEGIN
    FOR rec IN (select * from t1)
    LOOP
        DBMS_OUTPUT.PUT_LINE( 'RowCount=' || sql%rowcount || ',C1=' || rec.c1 || ', C2=' ||
rec.c2);
    END LOOP;
END;
/
C1=1, C2=1
C1=2, C2=2
C1=3, C2=3
C1=4, C2=4
C1=5, C2=5
C1=6, C2=6
C1=7, C2=7
C1=8, C2=8
C1=9, C2=9
C1=10, C2=10
Anonymous PL block executed.

```

For More Information

Refer to the followings.

- **Explicit Cursor Declaration and Definition**
- **GOTO Statement**
- **EXIT Statement**

23.10 Cursor Variable Declaration

Function

It declares a cursor variable in DECLARE section of PSM.

Syntax

```
<cursor variable declaration> ::=  
    variable_name <type>  
    ;  
<cursor type definition> ::=  
    TYPE <type_name> IS REF CURSOR [ RETURN <return type> ]  
<return type> ::=  
    <table_name | view_name | cursor_name | cursor_variable > % ROWTYPE  
    | <record_variable_name> % TYPE  
    | <record_type_name>
```

Invocation and Access Rules

It can be used only within PSM. (e.g. package, procedure, function)

It can be used only in the declaration section of PSM.

Syntax Rules and Parameters

Specifying the initial value of a cursor variable or assigning a cursor variable is allowed only between curs or variables.

Description

A cursor variable is operated like as a pointer indicating a cursor which is not dependent on a specific cursor.

Examples

```
DECLARE
TYPE rec IS RECORD (V1 VARCHAR(20), V2 VARCHAR(20));
TYPE cv IS REF CURSOR RETURN rec;
BEGIN
    NULL;
END;
/
Anonymous PL block executed.
```

For More Information

Refer to the followings.

- **OPEN Statement**
- **FETCH Statement**
- **CLOSE Statement**

23.11 DELETE Statement Extension

Function

It can store the result in RETURNING INTO clause by using a record type variable of PSM.

Syntax

```

<PSM delete statement extension: searched> ::=
    DELETE [ FROM ] table_name [ [ AS ] alias_name ]
        [ WHERE <search condition> ]
        [ <result offset clause> ]
        [ <fetch limit clause> ]
        [ <returning into clause> ]
    ;
<delete statement: positioned> ::=
    DELETE [ FROM ] table_name [ [ AS ] alias_name ]
        WHERE CURRENT OF cursor_name
    ;
<result offset clause> ::=
    OFFSET skip_count [ ROW | ROWS ]
<fetch limit clause> ::=
    <fetch first clause>
    | <limit clause>
<fetch first clause> ::=
    FETCH [ FIRST | NEXT ] [ row_count ] [ ROW ONLY | ROWS ONLY ]
<limit clause>
    LIMIT { fetch_row_count | offset_row_count, fetch_row_count | ALL }
<returning into clause> ::=
    { RETURN | RETURNING } { * | { <value expression> [ [AS] alias_name ] } [, ...] } INTO
variable_name [, ...]

```

Invocation and Access Rules

It can be used only within PSM. (e.g. package, procedure, function)

It can be used only in the body section of PSM.

Syntax Rules and Parameters

If a variable to be returned through RETURNING INTO is a record type, then it can not be used by mixing together with a different variable type.

Description

It can store the result in RETURNING INTO clause by using a record type variable of PSM.

Examples

```
gSQL> CREATE TABLE T1( C1 VARCHAR(20), C2 VARCHAR(20));
Table created.
gSQL> COMMIT;
Commit complete.
gSQL> INSERT INTO T1 VALUES ('AAA', 'BBB'), ('BBB', 'CCC'), ('CCC', 'DDD');
3 rows created.
gSQL> COMMIT;
Commit complete.
gSQL> DECLARE
    rec t1%ROWTYPE;
BEGIN
    DELETE FROM T1 WHERE C1 = 'AAA' RETURNING * INTO rec;
    DBMS_OUTPUT.PUT_LINE('SQL%ROWCOUNT=' || SQL%ROWCOUNT);
    DBMS_OUTPUT.PUT_LINE('rec.c1=' || rec.c1 || ', rec.c2=' || rec.c2);
END;
/
SQL%ROWCOUNT=1
rec.c1=AAA, rec.c2=BBB
Anonymous PL block executed.
```

For More Information

Refer to [Deleting Data](#).

23.12 EXCEPTION_INIT Pragma

Function

It defines an internally defined exception within a PL block.

Syntax

```
< PRAGMA EXCEPTION_INIT > ::=  
    PRAGMA EXCEPTION_INIT ( <Exception-Name>, <Internal-ErrorCode> )  
    ;
```

Invocation and Access Rules

It can be used only within PSM. (e.g. package, procedure, function)

It can be used only in the declaration section of PSM.

Syntax Rules and Parameters

A predefined exception can not be used in an exception name which is used as an argument. (A predefined exception name can not be declared.)

An exception name which is used as an argument in the same PL block DECLARE clause should be declared in advance. (Declaration of an exception name in different BLOCK can not be referenced.)

<Internal-ErrorCode> should be an internal error code existing within DB SYSTEM. (SUCCESS code can not be set.)

Description

A user explicitly declares an exception name corresponding to an error code of DB SYSTEM.

Examples

```
gSQL> DECLARE
user_exception_1 EXCEPTION;
PRAGMA EXCEPTION_INIT( user_exception_1, -17001);
BEGIN
  RAISE USER_EXCEPTION_1;
  EXCEPTION WHEN user_exception_1 THEN DBMS_OUTPUT.PUT_LINE('User Exception_1');
END;
/
User Exception_1
Anonymous PL block executed.
```

Compatibility

Error codes are different each other according to a vendor, so it is not compatible each other.

For More Information

Refer to the followings.

- [Exception Declaration](#)
- [Exception Handler](#)

23.13 Exception Declaration

Function

It declares an exception name within a PL block.

Syntax

```
< Exception-Declaration Statement > ::=  
    <Exception-Name> EXCEPTION  
    ;
```

Invocation and Access Rules

It can be used only within PSM. (e.g. package, procedure, function)

It can be used only in the declaration section of PSM.

Syntax Rules and Parameters

It can not declare a predefined exception name.

Duplicated declarations are not allowed in DECLARE clause of the same SCOPE.

Description

A user explicitly declares an exception.

Examples

```
DECLARE  
user_exception_1 EXCEPTION;
```

```
user_exception_2 EXCEPTION;
user_exception_3 EXCEPTION;
BEGIN
  RAISE USER_EXCEPTION_2;
  EXCEPTION WHEN user_exception_1 THEN DBMS_OUTPUT.PUT_LINE('User Exception_1');
           WHEN user_exception_2 THEN DBMS_OUTPUT.PUT_LINE('User Exception_2');
           WHEN user_exception_3 THEN DBMS_OUTPUT.PUT_LINE('User Exception_3');
END;
/
User Exception_2
Anonymous PL block executed.
```

Compatibility

An exception declaration of the standard SQL is as follows, but GOLDILOCKS supports the syntax as above.

```
<condition declaration> ::=
DECLARE <condition name> CONDITION [ FOR <sqlstate value> ]
```

For More Information

Refer to the followings.

- [Exception Declaration](#)
- [EXCEPTION_INIT Pragma](#)

23.14 Exception Handler

Function

It performs an operation defined for an exception which is explicitly occurred by a user or an operation defined for an implicit error due to a DB SYSTEM error occurred during performing PL/ SQL.

Syntax

```

< Exception Handler Statement > ::=
    EXCEPTION < Exception_When_List >
    ;
< Exception_When_List > ::=
    WHEN < Exception_Name_List > THEN <executable statement list> [ WHEN OTHERS THEN
<executable statement list> ]
< Exception_Name_List > ::=
    <Exception_Name> [ { OR <Exception_Name> }... ]

```

Invocation and Access Rules

It can be used within a PL block.

Syntax Rules and Parameters

OTHERS (predefined exception) can not be specified together with another exception name by using OR. Duplicated specifying of OTHERS (predefined exception) is not allowed in an exception handler, and OTHERS should be specified at the last.

Description

Exception Types

Type	Definer	Has error	Has name	Raise implicitly	Raise explicitly
Predefined	System	Yes	Yes	Yes	Optionally
User-defined	User	If user assign	If user assign	No	Yes

A predefined exception has an exception name and an error code which are specified in advance in GOL DILOCKS.

Other exceptions are classified into an internally defined exception and a user-defined exception. An internally defined exception is that a user sets the internal error code name of GOLDILOCKS differently from a predefined exception name, and a user-defined exception is that only the exception name is declared without specifying a separate error code.

Predefined Exception

Table 23-6 Predefined exception type

Name	Description
CASE_NOT_FOUND	It can not satisfy all conditions of CASE WHEN, or ELSE clause is not defined.
DUP_VAL_ON_INDEX	INDEX duplicated error occurred.
INVALID_CURSOR	A cursor status is incorrect.
INVALID_NUMBER	It can not be converted to a number.
NO_DATA_FOUND	SELECT statement returns zero data.
ROWTYPE_MISMATCH	Field types of two RowType variables are different each other.
TOO_MANY_ROWS	It returns two or more rows.
VALUE_ERROR	It is an error such as type mismatch and invalid casting.
ZERO_DIVIDE	It tries dividing by 0.
OTHERS	It includes errors which are not defined in a predefined.

Examples

```
gSQL> DECLARE
V1 INTEGER := 0;
BEGIN
  DBMS_OUTPUT.PUT_LINE('Step1');
  V1 := 1 / 0;
```

```
DBMS_OUTPUT.PUT_LINE('Step2');  
EXCEPTION WHEN OTHERS THEN DBMS_OUTPUT.PUT_LINE( 'Exception V1=' || V1);  
END;  
/  
Step1  
Exception V1=0  
Anonymous PL block executed.
```

Compatibility

It does not support the SQL standard grammar.

For More Information

Refer to the followings.

- [EXCEPTION_INIT Pragma](#)
- [Exception Declaration](#)

23.15 EXECUTE IMMEDIATE Statement

Function

It executes a dynamic SQL within PSM.

Syntax

```

<EXECUTE IMMEDIATE statement> ::=
    EXECUTE IMMEDIATE <dynamic-sql> [ <binding-parameters> ]
    ;
<dynamic-sql> ::=
    single_quote_string
    | psm_variable
<binding-parameters> ::=
    <into-clause>
    | <using-clause>
    | <returning-into-clause>
    | <into-clause> <using-clause>
    | <using-clause> <returning-into-clause>
<into-clause> ::=
    INTO psm_variable [ {, psm_variable} ... ]
<using-clause> ::=
    USING [ <Bind-Type> ] <expression> [ {, [ <Bind-Type> ] <expression>} ... ]
<Bind-Type> ::=
    IN
    | OUT
    | IN OUT
<returning-into-clause> ::=
    RETURNING INTO psm_variable [ {, psm_variable} ... ]

```

Invocation and Access Rules

It can be used only within PSM. (e.g. package, procedure, function)

It can be used only in the body section of a PL block.

Syntax Rules and Parameters

Dynamic SQL

- `single_quote_string`: It is an SQL statement enclosed with a single quote ('). (`double_quote_string` is recognized as a variable in PSM.)
- `Psm-variable`: It is an SQL statement stored in a variable which is used in PSM.

The following is an example of expressing a data by using quote(s) in an SQL statement to be performed.

```
EXECUTE IMMEDIATE 'INSERT INTO t1 VALUES ( 'Tom' ) '; -- Tom
EXECUTE IMMEDIATE 'INSERT INTO t1 VALUES ( 'Tom''House' ) '; -- Tom'House
EXECUTE IMMEDIATE 'INSERT INTO t1 VALUES ( ''''Tom'' ) '; -- 'Tom
EXECUTE IMMEDIATE 'INSERT INTO t1 VALUES ( CHR(39) || 'TOM' ) '; -- 'Tom
```

A marker (? or :V1) is used in a location where a user input a variable in a dynamic SQL. An SQL statement specified in a dynamic SQL should be valid.

INTO Clause

The result of performing a dynamic SQL exists, and it is not bound through a marker, but the result of processing an SQL statement is returned. (It is internally a form of an implicit cursor fetch.)

The syntax is as follows.

```
EXECUTE IMMEDIATE 'SELECT ... FROM .. WHERE ...';
EXECUTE IMMEDIATE 'INSERT ... RETURNING ...';
EXECUTE IMMEDIATE 'UPDATE ... RETURNING ...';
EXECUTE IMMEDIATE 'DELETE ... RETURNING ...';
```

USING Clause

It lists a variable or an expression in USING clause (IN can be omitted.) as many as the number of input variables used in a dynamic SQL.

If the result of performing a dynamic SQL exists, then it lists variables as many as the number of result columns in USING OUT clause. (when returning the results to INTO clause)

The result can be returned in the following syntax by using USING OUT.

```
EXECUTE IMMEDIATE 'SELECT x, y, z INTO :v1, :v2, :v3 ...';
EXECUTE IMMEDIATE 'INSERT INTO ... RETURNING C1, C2 INTO :V1, :V2';
EXECUTE IMMEDIATE 'UPDATE T1 SET .. RETURNING C1, C2 INTO :V1, :V2';
```

```
EXECUTE IMMEDIATE 'DELETE FROM ... RETURNING C1, C2 INTO :V1, :V2';
```

RETURNING Clause

If INSERT/UPDATE/DELETE RETURNING INTO statement is used as a dynamic SQL, the result is returned by binding a variable specified in USING clause in OUT-mode in GOLDILOCKS.

The same result can be returned by using RETURNING-INTO clause for the compatibility with other DBMS.

Other Rules

- DDL/ DCL can not use any BIND clause. (INTO, USING, RETURNING clause)
- It is used as OUT in INTO clause and RETURNING INTO clause, so a separate bind type can not be specified nor it be simultaneously used together.
- IN BIND type can use only a scalar type variable.
- OUT BIND type can use a record type variable, but a scalar type or a record type can not be listed being mixed together.
- A result can not be returned being divided through INTO clause and USING OUT or RETURNING INTO.

Description

- If a dynamic SQL returns the result as a variable specified in INTO clause
 - A query returning two or more results causes TOO_MANY_ROWS exception.
 - If the result is zero, it causes NO_DATA_FOUND exception.
- If a dynamic SQL returns the result as a variable specified in USING or RETURNING clause
 - If two or more variables which are not ARRAY are returned, it causes TOO_MANY_ROWS exception.
 - If the result is zero, an error does not occur.
- The followings are results of which DDL/ DCL performs implicit cursor SQL%Attribute variables.
 - SQL%ROWCOUNT = 0
 - SQL%ISOPEN = FALSE
 - SQL%FOUND = FALSE
 - SQL%NOTFOUND = TRUE
- Other dynamic SQLs store SQL%Attribute values corresponding to the processing results of that SQL statement.

Examples

```

gSQL> DECLARE
V1 INTEGER;
V2 VARCHAR(20);
BEGIN
    V1 := 1;
    V2 := 'abcdef';
    DBMS_OUTPUT.PUT_LINE('#INSERT');
    EXECUTE IMMEDIATE 'insert into t1 values (:a1, :a2)' USING v1, v2;
    EXECUTE IMMEDIATE 'select c1, c2 from t1 where c1 = 1' INTO v1, v2;
    DBMS_OUTPUT.PUT_LINE('C1='|| v1 || ', C2=' || v2);
    V1 := 1;
    V2 := 'xyz';
    DBMS_OUTPUT.PUT_LINE('#UPDATE');
    EXECUTE IMMEDIATE 'update t1 set c2 = :a1 where c1 = :a2' USING V2, V1;
    V1 := 1;
    V2 := '';
    DBMS_OUTPUT.PUT_LINE('#SELECT');
    EXECUTE IMMEDIATE 'select c1, c2 from t1 where c1 = :a1' INTO v1, v2 USING v1;
    DBMS_OUTPUT.PUT_LINE('C1='|| v1 || ', C2=' || v2);
    V1 := 1;
    V2 := '';
    DBMS_OUTPUT.PUT_LINE('#DELETE');
    EXECUTE IMMEDIATE 'delete from t1 where c1 = :a1' USING v1;
END;
/
#INSERT
C1=1, C2=abcdef
#UPDATE
#SELECT
C1=1, C2=xyz
#DELETE
Anonymous PL block executed.

```

23.16 EXIT Statement

Function

It exits a loop statement which has the given label among superordinate loop statements, then performs the next statement.

Syntax

```
<exit statement> ::=  
    EXIT [ label_name ] [ WHEN condition ]  
    ;
```

Invocation and Access Rules

It can be used only within PSM. (e.g. package, procedure, function)

It can be used only in the body section of a PL block.

Syntax Rules and Parameters

- Label name
 - It is a label name of a loop statement to be exited.
 - It can be in an identifier chain form.
- Condition
 - If a condition is specified, then it can exit a loop statement only when that condition is TRUE.

Description

- It stops currently performing statement list and exits a superordinate loop statement.
- A statement with a target label should be one of the following loop family statements.
 - basic loop statement
 - for loop statement

- while statement
- forall statement
- If a label is specified, then it exits a superordinate loop statement which has that label name.
- If a label is not specified, then it exits the nearest superordinate loop statement.
- If multiple superordinate loop statements with the same label names exist, then the nearest statement is selected.
- It can exit only a loop statement (exist in a nested scope) which is visible in the current location.
- If a condition is specified, then it exits only when the condition is TRUE.
- If a condition is not specified, then it definitely exits.

Examples

```
gSQL> DECLARE
  V1 INTEGER := 1;
BEGIN
  <<AAA>>
  WHILE V1 <= 10 LOOP
    DBMS_OUTPUT.PUT_LINE( 'V1 = ' || V1 );
    EXIT;
    V1 := V1 + 1;
  END LOOP AAA;
END;
/
V1 = 1
Anonymous PL block executed.
```

Compatibility

It does not exist in the SQL standard.

23.17 Explicit Cursor Attribute

Function

It returns the status value of a cursor defined in PSM.

Syntax

```
<Explicit cursor attribute> ::=
  cursor_name '%' { ISOPEN | FOUND | NOTFOUND | ROWCOUNT }
```

Invocation and Access Rules

It can be used only in the body section of PSM.

Syntax Rules and Parameters

- Cursor_name
 - It is the name of a cursor whose status value is to be obtained.

Description

- It returns the status value of a given cursor.
 - ISOPEN: It is whether the current cursor is OPEN.
 - FOUND: It is whether the data is returned by the recent fetch.
 - NOTFOUND: It is an opposite of FOUND.
 - ROWCOUNT: It is the number of fetched records after the cursor is recently OPEN.
- The following values are returned according to the cursor status.

Table 23-7 Results according to the performing moment

Attribute name	Before OPEN	After OPEN	After FETCH	After CLOSE
ISOPEN	FALSE	TRUE	TRUE	FALSE

Attribute name	Before OPEN	After OPEN	After FETCH	After CLOSE
FOUND	NULL	NULL	TRUE/FALSE	NULL
NOTFOUND	NULL	NULL	TRUE/FALSE	NULL
ROWCOUNT	NULL	NULL	N (the number)	NULL

Examples

```

gSQL> CREATE TABLE T1 ( I1 INTEGER );
Table created.
gSQL> COMMIT;
Commit complete.
gSQL> DECLARE
    CURSOR C1 IS SELECT * FROM T1;
    V1 INTEGER := 0;
    V2 INTEGER := 0;
    TOTAL INTEGER := 0;
BEGIN
    FOR I IN 1..100 LOOP
        INSERT INTO T1 VALUES( I );
    END LOOP;
    COMMIT;
    IF NOT C1%ISOPEN THEN
        OPEN C1;
    END IF;
    LOOP
        FETCH C1 INTO V1;
        EXIT WHEN C1%NOTFOUND;
        TOTAL := TOTAL + V1;
        V2 := V1;
    END LOOP;
    DBMS_OUTPUT.PUT_LINE( 'COUNT = ' || C1%ROWCOUNT || ' TOTAL = ' || TOTAL );
    CLOSE C1;
END;
/
COUNT = 100 TOTAL = 5050
Anonymous PL block executed.

```

Compatibility

It is not defined in the SQL standard.

23.18 Explicit Cursor Declaration and Definition

Function

It declares a cursor in DECLARE section of PSM.

Syntax

```
<cursor declaration> ::=
    CURSOR cursor_name [ <cursor param spec> ] RETURN rowtype
    ;
<cursor param spec> ::=
    ( <cursor param decl> [ , <cursor param decl> ] .. )
<cursor param decl> ::=
    param_name [ IN ] datatype [ { '=' | DEFAULT } expression ]
<cursor definition> ::=
    CURSOR cursor_name [ <cursor param spec> ] [ RETURN rowtype ]
    IS select_statement
    ;
```

Invocation and Access Rules

It can be used only within PSM. (e.g. package, procedure, function)

It can be used only in the declaration section of a PL block.

Syntax Rules and Parameters

Cursor Name

It is a cursor name to be declared.

The length of a cursor name should be shorter than 128 bytes.

It should be a unique name in that scope.

RowType

It defines a record type of a cursor.

The number of select targets specified when defining a cursor should be same, and the data type should be compatible.

If a rowtype is not specified, then a rowtype which is appropriate to a SELECT target of select_statement specified when defining a cursor is automatically specified.

Param Name

It is a name which distinguishes parameters within a specific cursor.

It should be a unique name in that cursor.

If the name is as same as a name of another variable which can be referenced within a scope, then a parameter of that cursor is preferentially referenced.

Data Type

It specifies the data type of the corresponding parameter.

It can use all built-in types provided by GOLDILOCKS and types defined within PSM.

However, a statement which restricts a scope (precision/ scale) can not be specified in a built-in type, but it is internally specified as the maximum scope of the corresponding data type.

Select Statement

It specifies SELECT or SELECT ... FOR UPDATE statement which is to be performed by a cursor.

It can not use SELECT ... INTO statement.

Description

- <explicit cursor declaration> statement declares or defines a cursor.
 - Cursor declaration: It declares only a name and format of a cursor.
 - Cursor definition: It detailedly defines a name, format of a cursor and SELECT statement to be performed.
- An explicit cursor is used by defining it after declaration. or it can be used by defining it without a declaration.
- When using an explicit cursor by defining it after declaration, then the cursor name, the parameter specification and the record type definition should exactly match.
- A declaration and a definition of an explicit cursor should exist in the same block.
- An explicit cursor is created when the cursor enters the defined block, and it is automatically CLOSED

and deleted when it exits the block.

- 'MAXIMUM_NAMED_CURSOR_COUNT' property restricts the maximum number of explicit cursors which can be created in a specific time.
- The following variables can be used in SELECT statement performed by an explicit cursor.
 - Parameter of the cursor
 - All PSM variables which can be referenced in a scope at the time of declaration. (It is not a scope of the time of open.)
 - External bind parameter (in case of an anonymous PL block)
- An explicit cursor performing SELECT statement has the following properties.
 - IN_SENSITIVE (Changes by another transaction do not affect it.)
 - NON_SCROLLABLE (It can not fetch the previous record again.)
 - READ_ONLY (Only a read operation is available.)
 - WITH-HOLD (A cursor is not automatically closed even though COMMIT/ ROLLBACK is performed.)
- An explicit cursor performing SELECT ... FOR UPDATE statement has the following properties.
 - IN_SENSITIVE (Changes by another transaction do not affect it.)
 - NON_SCROLLABLE (It can not fetch the previous record again.)
 - UPDATABLE (It can UPDATE/DELETE through a cursor location.)
 - WITHOUT-HOLD (A cursor is automatically closed when COMMIT/ ROLLBACK is performed.)

Examples

```
gSQL> CREATE TABLE T1 ( I1 INTEGER, I2 VARCHAR(10) );
Table created.
gSQL> COMMIT;
Commit complete.
gSQL> INSERT INTO T1 VALUES( 1, 'AAA' );
1 row created.
gSQL> INSERT INTO T1 VALUES( 2, 'BBB' );
1 row created.
gSQL> INSERT INTO T1 VALUES( 3, 'CCC' );
1 row created.
gSQL> COMMIT;
Commit complete.
gSQL> DECLARE
    CURSOR C1( A1 INTEGER, A2 VARCHAR ) RETURN T1%ROWTYPE IS SELECT * FROM T1 WHERE I1 = A1 AND
I2 = A2;
    V1 T1%ROWTYPE;
BEGIN
    OPEN C1( 2, 'BBB' );
```

```
FETCH C1 INTO V1;  
DBMS_OUTPUT.PUT_LINE( 'V1.I1 = ' || V1.I1 || ' V1.I2 = ' || V1.I2 );  
CLOSE C1;  
END;  
/  
V1.I1 = 2 V1.I2 = BBB  
Anonymous PL block executed.
```

Compatibility

It is not defined in the SQL standard.

For More Information

Refer to the followings.

- **OPEN FOR Statement**
- **FETCH Statement**
- **CLOSE Statement**

23.19 FETCH Statement

Function

It fetches a single record of OPEN cursor.

Syntax

```
<fetch statement> ::=  
    FETCH cursor_name <into clause>  
    ;  
<into clause> ::=  
    INTO { variable [ , variable ] .. | record }
```

Invocation and Access Rules

It can be used only within PSM. (e.g. package, procedure, function)

It can be used only in the body section of a PL block.

Syntax Rules and Parameters

- Cursor name
 - It is a cursor name to be fetched.
- Variable
 - It is a scalar type variable or a bind parameter which stores a column value among the fetch results.
- Record
 - It is a record type variable to store the entire single record of which is the fetch result.

Description

It fetches a record from an open cursor, then copies the value to a variable specified in INTO clause.

If a cursor is declared only but not defined, then an error occurs.

The cursor should be open.

A variable type given to INTO clause should be compatible with a data type of the fetched record result.

The number of variables given to INTO clause should be as same as the number of the cursor's SELECT targets.

However, if a variable given in INTO clause is a record type, then only a single variable should be specified.

Also, the number of the record variable fields should be as same as the number of SELECT targets.

If a fetch is called when a record to be fetched does not exist, then the value of target variables in INTO clause is not altered.

Examples

```
gSQL> CREATE TABLE T1 ( I1 INTEGER );
Table created.
gSQL> COMMIT;
Commit complete.
gSQL> DECLARE
    CURSOR C1 IS SELECT * FROM T1;
    V1 INTEGER := 0;
    V2 INTEGER := 0;
    CNT INTEGER := 0;
    TOTAL INTEGER := 0;
BEGIN
    FOR I IN 1..100 LOOP
        INSERT INTO T1 VALUES( I );
    END LOOP;
    COMMIT;
    OPEN C1;
    LOOP
        FETCH C1 INTO V1;
        CNT := CNT + 1;
        TOTAL := TOTAL + V1;
        V2 := V1;
    EXIT WHEN V1 = 100;
```

```
END LOOP;  
CLOSE C1;  
DBMS_OUTPUT.PUT_LINE( 'CNT = ' || CNT || ' TOTAL = ' || TOTAL );  
END;  
/  
CNT = 100 TOTAL = 5050  
Anonymous PL block executed.
```

Compatibility

It is not defined in the SQL standard.

For More Information

Refer to the followings.

- [OPEN Statement](#)
- [CLOSE Statement](#)

23.20 FOR LOOP Statement

Function

As long as an index variable has the given value scope, it performs internal statements by increasing or reversing the index variable by 1.

Syntax

```
<for loop statement> ::=  
    FOR index_variable_name IN [ REVERSE ] start_value .. last_value  
    LOOP { <SQL procedure statement> ; }... END LOOP [ loop_name ]  
    ;
```

Invocation and Access Rules

It can be used only within PSM. (e.g. package, procedure, function)

It can be used only in the body section of a PL block.

Syntax Rules and Parameters

- Index variable name
 - It is a variable name to be used as an index in FOR statement. Internally, NATIVE_BIGINT type variable is used.
- Start value
 - It is a start value of an index variable, and it should be an integer type. If a number with a floating point is used, then the number below decimal point is truncated while converting the type.
- Last value
 - It is the last value of an index variable, and it should be an integer type. If a number with a floating point is used, then the number below decimal point is rounded down while converting the type.

Description

for loop statement performs an internal statement list by increasing or decreasing the index variable value from `start_value` to `last_value`.

If `REVERSE` is specified, an index variable value is decreased by 1 from `start_value`, and it terminates execution of *for loop* statement when the variable value becomes smaller than `last_value`.

If `REVERSE` is not specified, an index variable is increased by 1 from `start_value`, and it terminates execution of *for loop* statement when the variable value becomes bigger than `last_value`.

If `start_value` is bigger than `last_value` when `REVERSE` is not specified, or if `start_value` is smaller than `last_value` when `REVERSE` is specified, then an internal statement list is not performed.

Examples

```
gSQL> BEGIN
  FOR I IN 0 .. 10 LOOP
    DBMS_OUTPUT.PUT_LINE( 'I = ' || I );
  END LOOP;
END;
/
2 3 4 5 6 I = 0
I = 1
I = 2
I = 3
I = 4
I = 5
I = 6
I = 7
I = 8
I = 9
I = 10
```

Anonymous PL block executed.

Compatibility

It is not defined in the SQL standard.

For More Information

Refer to the followings.

- [CONTINUE Statement](#)
- [EXIT Statement](#)
- [GOTO Statement](#)

23.21 Function Declaration and Definition

Function

It defines a nested function.

Syntax

```
<nested function statement> ::=  
    FUNCTION func_name [ ( { param_name [IN|OUT|INOUT] datatype [ { := | DEFAULT } init_expr ]  
    } [, ...] ) ]  
        RETURN datatype  
        { IS | AS } <item_declaration> BEGIN <pl_stmt_list> END  
    ;
```

Invocation and Access Rules

It can be used only within PSM. (e.g. package, procedure, function)

It can be used only in the declaration section of a PL block.

Syntax Rules and Parameters

func_name

It is a name of function to be created, and it should be a unique name in a schema.

The length of a function name should be shorter than 128 bytes.

Param Name

It defines a name of an argument to be used in a function.

The name of each argument should be unique in a function.

Bind Type

It specifies a bind type of each argument.
If it is not specified, the default type is *IN*.

Item Declaration

It declares items such as a local variable to be used within a function.
It can declare all items which can be declared in a PL block.

PL Stmt List

It is a body section of a function, and it lists PL statements to be performed.

Description

A nested function is a sub program which can be called only within the corresponding procedure.
Other usages are as same as those of a schema-level function.

Examples

```
gSQL> DECLARE
  V1 INTEGER := 0;
  FUNCTION FUNC1( A1 INTEGER )
    RETURN INTEGER
  IS
  BEGIN
    RETURN A1 * 10;
  END;
BEGIN
  V1 := FUNC1( 10 );
  DBMS_OUTPUT.PUT_LINE( 'V1 = ' || V1 );
END;
/
V1 = 100
```

Anonymous PL block executed.

Compatibility

It is as same as a schema-level function.

For More Information

Refer to `CREATE FUNCTION`.

23.22 GOTO Statement

Function

It tries to jump into the nearest statement which has a given label among statements accessible from the current location.

Syntax

```
<goto statement> ::=  
    GOTO label_name  
    ;
```

Invocation and Access Rules

It can be used only within PSM. (e.g. package, procedure, function)
It can be used only in the body section of a PL block.

Syntax Rules and Parameters

- Label_name
 - It is a label name of a statement in which is to be jumped.
 - It can be in an identifier chain form.

Description

It starts performing by jumping into a statement which has the corresponding label name.
If multiple candidate statements exist, then it jumps into the nearest statement.
It can jump only to a statement (exist in a nested scope) which is visible in the current location.
Both forward jump and backward jump are possible.

Examples

```
gSQL> DECLARE
  V1 INTEGER := 0;
BEGIN
  <<LABEL1>>
  IF V1 > 0 THEN
    GOTO LABEL2;
  END IF;
  V1 := V1 + 1;
  DBMS_OUTPUT.PUT_LINE('a');
  GOTO LABEL1;
  DBMS_OUTPUT.PUT_LINE('b');
  <<LABEL2>>
  DBMS_OUTPUT.PUT_LINE('c');
END;
/
a
c
Anonymous PL block executed.
```

Compatibility

It is not defined in the SQL standard.

For More Information

Refer to the followings.

- [EXIT Statement](#)
- [CONTINUE Statement](#)

23.23 IF Statement

Function

It performs a statement list corresponding to the condition returning TRUE among the given conditions.

Syntax

```
<if statement> ::=  
    IF <search condition> <if statement then clause>  
    [ <if statement elsif clause> ]  
    [ <if statement else clause> ]  
    END IF  
    ;  
<if statement then clause> ::=  
    THEN <executable statement list>  
<if statement elsif clause> ::=  
    ELSIF <search condition> THEN <executable statement list>  
<if statement elsif clause> ::=  
    ELSE <executable statement list>
```

Invocation and Access Rules

It can be used only within PSM. (e.g. package, procedure, function)

It can be used only in the body section of a PL block.

Syntax Rules and Parameters

- Search condition
 - It is an expression which can be finally evaluated as a boolean type.
- Executable statement list
 - It is a list of all statements supported by GOLDILOCKS PSM.

Description

Like as CASE statement, it performs statement lists of IF, ELSIF clauses returning TRUE by evaluating conditions.

If it can not satisfy any condition and <if statement else clause> exists, then it performs the corresponding statement.

ELSIF clauses evaluates conditional expressions in order, and stops evaluating after finding the TRUE conditional clause.

Examples

```
gSQL> DECLARE
  V1 INTEGER := 10;
BEGIN
  IF V1 > 0 THEN
    DBMS_OUTPUT.PUT_LINE( 'POSITIVE' );
  ELSIF V1 = 0 THEN
    DBMS_OUTPUT.PUT_LINE( 'ZERO' );
  ELSE
    DBMS_OUTPUT.PUT_LINE( 'NEGATIVE' );
  END IF;
END;
/
POSITIVE
Anonymous PL block executed.
```

Compatibility

<if statement> statement is as same as a syntax and an operation of the SQL standard.

Table 23-8 SQL standard compatibility

Feature ID	Description	Compatibility
P002	Computational completeness	O

23.24 Implicit Cursor Attribute

Function

It returns the status value of an implicit cursor defined in PSM.

Syntax

```
<Implicit cursor attribute> ::=  
    SQL '%' { ISOPEN | FOUND | NOTFOUND | ROWCOUNT }
```

Invocation and Access Rules

It can be used only within PSM. (e.g. package, procedure, function)

It can be used only in the body section of a PL block.

Description

- It stores the result of SQL statement which was executed just before.
 - ISOPEN: It is whether the cursor is OPEN, and it is always set to FALSE.
 - FOUND: It is whether the data is returned by the SQL result of just before.
 - NOTFOUND: It is an opposite of FOUND.
 - ROWCOUNT: It is the number of records affected by the SQL result of just before.

Examples

```
DECLARE  
V1 INTEGER;  
BEGIN  
    SELECT COUNT(*) INTO V1 FROM T1;  
    DBMS_OUTPUT.PUT_LINE('COUNT RET    = ' || V1);  
    DBMS_OUTPUT.PUT_LINE('SQL%ISOPEN  = ' || SQL%ISOPEN);
```

```
DBMS_OUTPUT.PUT_LINE('SQL%FOUND      = ' || SQL%FOUND);
DBMS_OUTPUT.PUT_LINE('SQL%NOTFOUND = ' || SQL%NOTFOUND);
DBMS_OUTPUT.PUT_LINE('SQL%ROWCOUNT = ' || SQL%ROWCOUNT);
END;
/
COUNT RET      = 0
SQL%ISOPEN      = FALSE
SQL%FOUND        = TRUE
SQL%NOTFOUND     = FALSE
SQL%ROWCOUNT   = 1
Anonymous PL block executed.
```

Compatibility

It is not defined in the SQL standard.

23.25 INSERT Statement Extension

Function

It is an extended feature of an insert statement to input data by specifying record type variable supported in PSM in VALUES clause.

Syntax

```

<PSM Insert Statement Extension Statement> ::=
    INSERT INTO table_name [ ( column_name [ , ... ] ) ]
        <Insert_source>
        [ <Returning_into_clause> ]
    ;
<Insert_source> ::=
    <value-list>
    | <from_subquery>
    | <from_default>
<from subquery> ::=
    <query_expression>
<from default> ::=
    DEFAULT VALUES
<Value-List> ::=
    VALUES <Value_item> [ , ... ]
<value-Item> ::=
    PSM-Record-Type-Variable
    | ( { <value expression> | DEFAULT } [ , ... ] )
<Returning_into_clause> ::=
    [ RETURN | RETURNING ] { * | { <value_expression> [ [AS] alias_name ] } [ , ... ] INTO
variable_name [ , ... ]

```

Invocation and Access Rules

It can be used only within PSM. (e.g. package, procedure, function)

It can be used only in the body section of a PL block.

A PSM insert extension statement can not be used in an original SQL statement of EXECUTE IMMEDIATE.

Syntax Rules and Parameters

It is operated as same as the basic syntax of an insert statement. However, a feature specifying PSM record type variables are added other than a feature consecutively listing existing value expressions in parentheses in value item.

A PSM record type variable should be specified when using a variable without parentheses in Value_Item. When using it in an insert extension statement form, a variable which is not a record type can not be used being mixed.

Description

It stores a record by using a record type variable of PSM other than a general insert statement, or obtains a result through returning into.

For more information about insert, refer to the following example.

Examples

```
gSQL> DECLARE
  rec t1%ROWTYPE;
BEGIN
  rec.i1 := 'AAA';
  rec.i2 := 'BBB';
  rec.i3 := 'CCC';
  INSERT INTO t1 (i1, i2, i3) VALUES rec ;
END;
/
Anonymous PL block executed.
gSQL> SELECT * FROM t1;
I1  I2  I3
---  ---  ---
AAA BBB CCC
```

Compatibility

It is not defined in the SQL standard.

23.26 NULL Statement

Function

It is a statement without any feature.

Syntax

```
<null statement> ::=  
    NULL  
    ;
```

Invocation and Access Rules

It can be used only within PSM. (e.g. package, procedure, function)

It can be used only in the body section of a PL block.

Description

It is a statement without any feature, and used to set a label of a specific location.

Examples

```
gSQL> BEGIN  
    FOR i in 1..10 LOOP  
        DBMS_OUTPUT.PUT_LINE( i );  
        IF i > 5 THEN  
            GOTO label1;  
        END IF;  
    END LOOP;  
<<label1>>  
    NULL;
```



```
END;
```

```
/
```

```
1
```

```
2
```

```
3
```

```
4
```

```
5
```

```
6
```

```
Anonymous PL block executed.
```

Compatibility

It is not defined in the SQL standard.

23.27 OPEN Statement

Function

It executes SELECT statement of a cursor defined in PSM.

Syntax

```
<open statement> ::=  
    OPEN cursor_name [ <actual param spec> ]  
    ;  
<actual param spec> ::=  
    ( expression [ , expression ] .. )
```

Invocation and Access Rules

It can be used only within PSM. (e.g. package, procedure, function)

It can be used only in the body section of a PL block.

Syntax Rules and Parameters

- Cursor_name
 - It is the name of a cursor to be opened.

Description

It executes SELECT or SELECT ... FOR UPDATE statement of a defined cursor.

If a cursor is declared only but is not defined, then an error occurs.

Values of actual parameters should be compatible with the data type of those parameters.

The number of actual parameters should be same as the number of parameters of a cursor.

If it is smaller than the number of parameters of a cursor, then the default value should be specified in all

other parameters.

Examples

```
gSQL> CREATE TABLE T1 ( I1 INTEGER, I2 VARCHAR(10) );
Table created.
gSQL> COMMIT;
Commit complete.
gSQL> INSERT INTO T1 VALUES( 1, 'AAA' );
1 row created.
gSQL> INSERT INTO T1 VALUES( 2, 'BBB' );
1 row created.
gSQL> INSERT INTO T1 VALUES( 3, 'CCC' );
1 row created.
gSQL> COMMIT;
Commit complete.
gSQL> DECLARE
    CURSOR C1( A1 INTEGER := 1, A2 VARCHAR DEFAULT 'AAA') IS SELECT * FROM T1 WHERE I1 = A1 AND
I2 = A2;
    V1 INTEGER;
    V2 VARCHAR(10);
BEGIN
    OPEN C1( 1 );
    FETCH C1 INTO V1, V2;
    DBMS_OUTPUT.PUT_LINE( 'V1 = ' || V1 || ' V2 = ' || V2 );
    CLOSE C1;
END;
/
V1 = 1 V2 = AAA
Anonymous PL block executed.
```

Compatibility

It is not defined in the SQL standard.

For More Information

Refer to the followings.

- **CLOSE Statement**
- **FETCH Statement**

23.28 OPEN FOR Statement

Function

It opens a single cursor by executing SELECT statement through a cursor variable defined in PSM.

Syntax

```
<open statement> ::=  
    OPEN cursor_variable_name FOR <select_query>  
    ;
```

Invocation and Access Rules

It can be used only within PSM. (e.g. package, procedure, function)

It can be used only in the body section of a PL block.

Syntax Rules and Parameters

- Cursor_Variable_name
 - It is a name of cursor_variable.
- Select_query
 - A select query can use both a static SQL and a dynamic SQL.

Description

It executes SELECT or SELECT ... FOR UPDATE statement of a defined cursor variable.

If a cursor previously opened by a cursor variable exists, then that cursor is automatically closed.

Examples

```

gSQL> CREATE TABLE T1 (c1 INTEGER, c2 INTEGER, c3 INTEGER);
Table created.
gSQL> INSERT INTO T1 VALUES (1, 1, 1);
1 row created.
gSQL> INSERT INTO T1 VALUES (2, 2, 2);
1 row created.
gSQL> INSERT INTO T1 VALUES (3, 3, 3);
1 row created.
gSQL> INSERT INTO T1 VALUES (4, 4, 4);
gSQL> DECLARE
cv SYS_REFCURSOR;
rec t1%ROWTYPE;
BEGIN
  OPEN cv FOR SELECT * FROM T1;
  DBMS_OUTPUT.PUT_LINE('After Open> CV%ISOPEN=' || CV%ISOPEN);
  LOOP
    FETCH cv INTO rec;
    EXIT WHEN CV%NOTFOUND;
    DBMS_OUTPUT.PUT_LINE('C1=' || rec.c1 || ', C2=' || rec.c2 || ', c3=' || rec.c3 || ',
RowCount=' || cv%rowcount);
  END LOOP;
  CLOSE cv;
  DBMS_OUTPUT.PUT_LINE('After Close> CV%ISOPEN=' || CV%ISOPEN);
END;
/
After Open> CV%ISOPEN=TRUE
C1=1, C2=1, c3=1, RowCount=1
C1=2, C2=2, c3=2, RowCount=2
C1=3, C2=3, c3=3, RowCount=3
C1=4, C2=4, c3=4, RowCount=4
After Close> CV%ISOPEN=FALSE
Anonymous PL block executed.

```

Compatibility

It is not defined in the SQL standard.

For More Information

Refer to the followings.

- **Cursor Variable Declaration**
- **FETCH Statement**
- **CLOSE Statement**

23.29 Procedure Call

Function

It calls a user-defined procedure, a built-in procedure or a nested procedure.

Syntax

```
<Procedure call> ::=
    proc_name [ ( expr { , expr } ... ) ]
    ;
```

Invocation and Access Rules

It can be used only within PSM. (e.g. package, procedure, function)

It can be used only in the body section of a PL block.

- The following privileges for the corresponding procedure are required to call the user-defined procedure.
 - EXECUTE PROCEDURE
 - (EXECUTE PROCEDURE or CONTROL SCHEMA) ON SCHEMA for the schema to which the procedure belongs
 - EXECUTE ANY PROCEDURE ON DATABASE

Syntax Rules and Parameters

- Proc_name
 - It is a name of a procedure to be executed, and it is used in the following format.

Format	Syntax	Description
Single identifier	procedure_name	It calls the procedure of the given name. It is searched in the following order. 1. nested procedure

Format	Syntax	Description
		2. schema-level procedure
identifier chain	label_name.procedure_name	It calls a nested procedure.
	schema_name.procedure_name	It calls a schema-level procedure.
	package_name.procedure_name	It calls a built-in procedure.

If the given the number and type of arguments which were given in the procedure found first are wrong when searching with the given name (proc_name), then it does not search for another procedure but causes an error.

Description

It calls a user-defined procedure, a built-in procedure or a nested procedure which was defined an advance.

The argument value in which the default value is defined can be omitted when calling.

When using a procedure variable or bind parameter (?, :V1) in an argument which were defines as OUT or IN-OUT, then the returned value is obtained.

Examples

```
gSQL> DECLARE
  PROCEDURE PROC1( A1 INTEGER )
  IS
  BEGIN
    PUT_LINE( 'A1 = ' || A1 );
  END;
BEGIN
  PROC1( 100 );
END;
/
A1 = 100
```

Anonymous PL block executed.

Compatibility

The SQL standard requires to use <call statement>.

23.30 Procedure Declaration and Definition

Function

It defines a nested procedure.

Syntax

```
<nested procedure statement> ::=
    PROCEDURE proc_name [ ( { param_name [IN|OUT|INOUT] datatype [ { := | DEFAULT }
init_expr ] } [, ...] ) ]
    { IS | AS } <item_declaration> BEGIN <pl_stmt_list> END
    ;
```

Invocation and Access Rules

It can be used in PSM declaration section.

Syntax Rules and Parameters

- Proc_name
 - It is a name of a procedure to be created, and it should be a unique name in a schema.
 - The length of a procedure name should be shorter than 128 bytes.
- Param_name
 - It defines a name of an argument to be used by a procedure.
 - A name of each argument should be unique in a procedure.
- Bind_type
 - It specifies a bind type of each argument.
 - If it is not specified, the default type is 'IN'.
- Item_declaration
 - It declares items such as a local variable to be used within a procedure.
 - It can declare all items which can be declared in a PL block.
- PL Stmt list
 - It is a body section of a procedure, and it lists PL statements to be performed.

Description

A nested procedure is a sub program which can be called only within the corresponding procedure. Other usages are as same as those of a schema-level procedure.

Examples

```
gSQL> DECLARE
  PROCEDURE PROC1( A1 INTEGER )
  IS
  BEGIN
    DBMS_OUTPUT.PUT_LINE( 'A1 = ' || A1 );
  END;
BEGIN
  PROC1( 100 );
END;
/
A1 = 100
Anonymous PL block executed.
```

Compatibility

It is as same as a schema-level procedure.

For More Information

Refer to [CREATE PROCEDURE](#).

23.31 RAISE Statement

Function

It explicitly generates a user-defined exception.

Syntax

```
<RAISE Statement> ::=  
    RAISE <Exception-Name>  
    ;
```

Invocation and Access Rules

It can be used only within PSM. (e.g. package, procedure, function)

It can be used only in the body section of a PL block.

Syntax Rules and Parameters

- A name of exception to be raised should be declared in a PL block to which a raise belongs or in DECLARE clause of a superordinate PL block. However, a predefined exception can be raised without a declaration.
- If a raise statement is used within an exception handler, an exception name can be omitted, in this case, the previous exception is spread to the superordinate block.

Description

If it can not be processed in a PL block in which an exception occurred, then it is spread to the superordinate PL block.

If an exception to be raised does not exist in a PL block including RAISE statement, nor does exist in all exception handlers within a superordinate PL block, then an error occurs.

It is spread from a PL block in which RAISE exception occurred to a superordinate PL block until it is proce

ssed, and it can not be spread to an exception handler of subordinate PL block.

Table 23-9 Propagating user exception

Raise exception	Exception handler SCOPE	Exception handler	Whether to spread it to superordinate
User exception without error code	Same scope	X	It spreads "unhandled exception" error to a superordinate scope.
User exception with error code	Superordinate scope	X	It spreads a user exception.
User exception with error code	Same scope	X	It spreads a user defined error code.
User exception with error code	Superordinate scope	X	It spreads a user defined error code.

Examples

```

gSQL> DECLARE
V1 INTEGER;
exception1 EXCEPTION;
exception100 EXCEPTION;
BEGIN
    DBMS_OUTPUT.PUT_LINE('Step1');
    BEGIN
        RAISE exception1;
        DBMS_OUTPUT.PUT_LINE('Step2');
        EXCEPTION WHEN Exception100 THEN DBMS_OUTPUT.PUT_LINE('in Exception');
    END;
    DBMS_OUTPUT.PUT_LINE('Step3');
    EXCEPTION WHEN Exception1 THEN DBMS_OUTPUT.PUT_LINE('out Exception');
    DBMS_OUTPUT.PUT_LINE('Step4');
END;
/
Step1
out Exception
Step4
Anonymous PL block executed.

```

Compatibility

The SQL standard specifies <handler declaration> and <condition declaration>, but it does not support the syntax.

For More Information

Refer to the followings.

- [Exception Handler](#)
- [Exception Declaration](#)

23.32 Record Variable Declaration

Function

It declares a record type variable in DECLARE section.

Syntax

```
<declare record variable> ::=  
    variable_name <recordType>  
    ;  
<recordType> ::=  
    <tableName>%ROWTYPE  
    | USER_DEFINED_DATA_TYPE
```

Invocation and Access Rules

It can be used only within PSM. (e.g. package, procedure, function)

It can be used only in the declaration section of a PL block.

Syntax Rules and Parameters

- Variable_name
 - It is a name of variable to be declared.
 - The length of the variable name should be shorter than 128 bytes.
 - It should be a unique name within a scope (PL block body).
 - A variable with the same name can be declared in a PL block body of nested subordinate.
 - It should be used in scope_name.variable_name form to correctly use the variables of duplicated declaration.
 - When using a variable of duplicated declaration without specifying the scope name, then a variable of the nearest scope is automatically used.
- Record_type
 - It can use %ROWTYPE and user-defined recordType.
 - For more information about the declaration of recordType, refer to **User Defined Record Type**.

Description

- The declared variable has the following features.
 - It should be a unique name within a scope (PL block body).
 - A variable with the same name can be declared in a PL block body of nested subordinate.
 - It should be used in `scope_name.variable_name` form to correctly use the variables of duplicated declaration.
 - When using a variable of duplicated declaration without specifying the scope name, then a variable of the nearest scope is automatically used.
- The declared variable is used in that scope and in its subordinate scope, but '::' is not added unlike an embedded SQL.
- The used variable is operated as a bind parameter (INOUT) for that SQL or a PSM control statement.

Examples

```
gSQL> DECLARE
  TYPE MY_REC1 IS RECORD ( F1 INTEGER, F2 VARCHAR(10) );
  V1 MY_REC1;
BEGIN
  V1.F1 := 1;
  V1.F2 := 'AAA';
  INSERT INTO T1 VALUES( V1.F1, V1.F2 );
END;
/
Anonymous PL block executed.
gSQL> COMMIT;
Commit complete.
gSQL> SELECT * FROM T1;
I1 I2
-- ---
1 AAA
1 row selected.
```

Compatibility

It is not defined in the SQL standard.

23.33 RETURN Statement

Function

It specifies the value of which a function returns, then terminates the function. A procedure does not specify the return value, but terminates the procedure.

Syntax

```
<return statement> ::=  
    RETURN [ return_value_expr ]  
    ;
```

Invocation and Access Rules

It can be used only within PSM. (e.g. package, procedure, function)

It can be used only in the body section of a PL block.

Syntax Rules and Parameters

- Return_value_expr
 - It is an expression of a value to be returned, and it can be specified only when it is a function.

Description

It terminates a currently performing procedure/ function.

For a function, if RETURN statement is terminated without being performed, or if RETURN statement does not have return_value_expr, then an error occurs.

Examples

```
gSQL> CREATE OR REPLACE FUNCTION FUNC1( A1 INTEGER, A2 INTEGER )
RETURN INTEGER
IS
  V1 INTEGER;
BEGIN
  SELECT COUNT(*)
  INTO V1
  FROM T1
  WHERE T1.I1 >= A1 AND T1.I1 <= A2;
RETURN V1;
END;
/
```

Function created.

Compatibility

It is specified in the SQL standard, but conformance rules do not exist.

23.34 RETURNING INTO clause

Function

The data processed in an insert/ update/ delete is returned to a PSM variable.

Syntax

```

<Insert, Delete Returning_into_clause> ::=
    [ RETURN | RETURNING ] { * | { <value_expression> [ [AS] alias_name ] } [, ...] INTO
variable_name [, ...]
<Update returning into clause> ::=
    { RETURN | RETURNING } [ NEW | OLD ] { * | { <value expression> [ [AS] alias_name ] } [,
... ] } INTO Variable [, ...]

```

Invocation and Access Rules

It can be used only within PSM. (e.g. package, procedure, function)

It can be used only in the body section of a PL block.

Syntax Rules and Parameters

A record type variable can not be used being mixed with other types.

Description

It stores before/ after record of processing an insert/ update/ delete statement through returning into.

Examples

```
gSQL> DECLARE
  rec t1%ROWTYPE;
BEGIN
  INSERT INTO t1 VALUES (1, 2, 3) RETURNING * INTO rec ;
  UPDATE T1 SET ROW = rec RETURNING * INTO rec;
  DELETE FROM T1 RETURNING * INTO rec;
END;
/
```

Anonymous PL block executed.

Compatibility

It is not defined in the SQL standard.

23.35 %ROWTYPE Attribute

Function

When declaring a variable, it defines the structure and type as same as those of a specific table, a specific cursor or a result set of a cursor variable.

Syntax

```
<rowtype attribute> ::=  
    <identifier chain> % ROWTYPE
```

Invocation and Access Rules

- It can be used only within PSM. (e.g. package, procedure, function)
- It can be used only in the declaration section of a PL block.
- When declaring a variable, it can be used only in <data type> section.
- When declaring a record type field, then it can not be used in <data type> section. (It does not support complex data type.)

Syntax Rules and Parameters

- Identifier chains are as follows.
 - The name of table, view, synonym to be referenced, or the name of a cursor or a cursor variable

Description

- Search order of the reference targets
 - Cursor or cursor variable
 - Base table, view, or synonym
- Reference scope

- When referring by using a row attribute, only name and type of columns in a result set of a table or a cursor is referenced.
- Therefore, it does not refer to NOT NULL constraint or DEFAULT value settings.

Examples

```
gSQL> CREATE TABLE T1 ( I1 INTEGER NOT NULL, I2 VARCHAR(10) );
Table created.
gSQL> INSERT INTO T1 VALUES( 123, '1234567890' );
1 row created.
gSQL> COMMIT;
Commit complete.
gSQL> DECLARE
  V1 T1%ROWTYPE;
BEGIN
  SELECT * INTO V1.I1, V1.I2 FROM T1;
  DBMS_OUTPUT.PUT_LINE( 'V1.I1 = ' || V1.I1 || ' V1.I2 = ' || V1.I2 );
END;
/
V1.I1 = 123 V1.I2 = 1234567890
Anonymous PL block executed.
```

Compatibility

It is not defined in the SQL standard.

23.36 Scalar Variable Declaration

Function

It declares a scalar variable in the declaration section.

Syntax

```
<declare scalar variable> ::=  
    variable_name <data type> [ <variable initialize clause> ]  
    ;  
<variable initialize clause> ::=  
    [ NOT NULL ] { DEFAULT | := } <value expression>
```

Invocation and Access Rules

It can be used only within PSM. (e.g. package, procedure, function)

It can be used only in the declaration section of a PL block.

Syntax Rules and Parameters

- Variable_name
 - It is a name of variable to be declared.
 - The length of the variable name should be shorter than 128 bytes.
 - It should be a unique name within a scope (PL block body).
 - A variable with the same name can be declared in a PL block body of nested subordinate.
 - It should be used in scope_name.variable_name form to correctly use the variables of duplicated declaration.
 - When using a variable of duplicated declaration without specifying the scope name, then a variable of the nearest scope is automatically used.
- Data_Type
 - It can use all built-in **Data Type** provided in GOLDBLOCKS.
- Value_expression
 - It expresses the initial value to specify in the variable.

- It can use all constants and expressions supported by GOLDBLOCKS except for multi-row functions.

Description

- The declared variable has the following features.
 - It should be a unique name within a scope (PL block body).
 - A variable with the same name can be declared in a PL block body of nested subordinate.
 - It should be used in `scope_name.variable_name` form to correctly use the variables of duplicated declaration.
 - When using a variable of duplicated declaration without specifying the scope name, then a variable of the nearest scope is automatically used.
- The declared variable is used in that scope and in its subordinate scope, but '::' is not added unlike an embedded SQL.
- The used variable is operated as a bind parameter (INOUT) for that SQL or a PSM control statement.

Examples

```
gSQL> CREATE TABLE T1 ( I1 INTEGER, I2 VARCHAR(10) );
Table created.
gSQL> COMMIT;
Commit complete.
gSQL> DECLARE
V1 INTEGER := 100;
V2 INTEGER := -100;
V3 VARCHAR(10) := 'ABC';
BEGIN
  IF V1 > 50 THEN
    INSERT INTO T1 VALUES ( V1, V3 );
  ELSE
    INSERT INTO T1 VALUES ( V2, V3 );
  END IF;
END;
/
Anonymous PL block executed.
gSQL> SELECT * FROM T1;
 I1 I2
--- ---
```

100 ABC

1 row selected.

Compatibility

- The differences between <declare scalar variable> statement of GOLDILOCKS and that of SQL standard are as follows.
 - <SQL variable declaration> of the SQL standard declares a variable in a PL block body (after BEGIN), but GOLDILOCKS declares a variable in a separate declaration section.
 - The SQL standard can declare multiple variables of the same type by using a single DECLARE statement, but GOLDILOCKS can declare only a single variable by using a single statement.
 - The SQL standard uses only DEFAULT syntax when setting the initial value, but GOLDILOCKS can use an assign sign (:=).

23.37 SELECT INTO Statement

Function

A single row is returned through SELECT.

Syntax

```
<select statement: single row> ::=
    SELECT [ <hint clause> ] [ <set quantifier> ] <select list>
        INTO <select target list>
            <table expression>
    ;
<select target list> ::=
    variable_name [, ...]
```

Invocation and Access Rules

It can be used only within PSM. (e.g. package, procedure, function)

It can be used only in the body section of a PL block.

Syntax Rules and Parameters

The rules are as same as those of a select statement except the rules for INTO clause.

Description

- SELECT INTO is used to return a single record.
 - If the number of results is zero, "NO_DATA_FOUND" exception occurs.
 - If the number of results are two or more, "TOO_MANY_ROWS" exception occurs.
- The result can be returned through a record type variable of PSM.
 - When using a record type variable, it can not be used being mixed with other type variables

Examples

```
gSQL> CREATE TABLE T1 (c1 VARCHAR(20), c2 VARCHAR(20));
Table created.
gSQL> INSERT INTO T1 VALUES ('AAA', 'BBB'), ('BBB', 'CCC');
2 rows created.
gSQL> DECLARE
    v1 VARCHAR(20);
    v2 VARCHAR(20);
BEGIN
    SELECT * INTO v1, v2 FROM T1 WHERE c1 = 'AAA';
    DBMS_OUTPUT.PUT_LINE('V1=' || v1 || ', v2=' || v2);
END;
/
V1=AAA, v2=BBB
Anonymous PL block executed.
```

Compatibility

It is not defined in the SQL standard.

23.38 SQLCODE Function

Function

It returns an error code of a statement which was performed just before in PSM.

Syntax

```
<SQLCODE function> ::= SQLCODE
```

Invocation and Access Rules

It can be used only within PSM.

Syntax Rules and Parameters

It does not have a separate argument.

Description

It returns an error code of a statement performed in PL/SQL.

A user-defined exception which does not assign an error code returns to 1 at the time when it is processed by a handler.

When the error is completely processed by an exception handler, it returns to 0.

Examples

```
gSQL> DECLARE  
V1 INTEGER;  
BEGIN
```

```
DBMS_OUTPUT.PUT_LINE('SQLCODE=[ ' || SQLCODE || ' ]');
DBMS_OUTPUT.PUT_LINE('SQLERRM=[ ' || SQLERRM || ' ]');
END;
/
SQLCODE=[0]
SQLERRM=[[SUNJESOFT][PL/SQL][GOLDILOCKS]successful completion]
Anonymous PL block executed.
```

Compatibility

It is not defined in the SQL standard.

23.39 SQLERRM Function

Function

It returns an error message of a statement which was performed just before in PSM.

Syntax

```
<SQLERRM function> ::= SQLERRM
```

Invocation and Access Rules

It can be used only within PSM.

Syntax Rules and Parameters

It does not have a separate argument.

Description

It returns an error message of a statement performed in PL/SQL.

A user-defined exception which does not assign an error code returns to a user-defined exception at the time when it is processed by a handler.

When the error is completely processed by an exception handler, it outputs successful completion message.

Examples

```
gSQL> DECLARE  
V1 INTEGER;
```

```
BEGIN
  DBMS_OUTPUT.PUT_LINE('SQLCODE=[ ' || SQLCODE || ' ]');
  DBMS_OUTPUT.PUT_LINE('SQLERRM=[ ' || SQLERRM || ' ]');
END;
/
SQLCODE=[0]
SQLERRM=[[SUNJESOFT][PL/SQL][GOLDILOCKS]successful completion]
Anonymous PL block executed.
```

Compatibility

It is not defined in the SQL standard.

23.40 %TYPE Attribute

Function

When declaring a variable or defining a specific field of RECORD type, it defines the type as same as the column of a specific table or another variable.

Syntax

```
<type attribute> ::=  
    <identifier chain> % TYPE
```

Invocation and Access Rules

It can be used only within PSM. (e.g. package, procedure, function)

It can be used only in the declaration section of a PL block.

It can be used only for <data type> section when declaring a variable or a field of a record type.

Syntax Rules and Parameters

- Identifier_chain
 - It is the name of a table column to be referenced or of the existing declared variable (or a field of the variable).

Description

Reference scope

The reference scope according to the referenced object types are as follows.

- When the referenced object is a column of a table
 - It refers to the data type of the column.

- It does not refer to a constraint (e.g. NOT NULL) of the column.
- It does not refer to the default initial value of the column.
- When the referenced object is another variable (or a field of a variable)
 - It refers to the data type of the variable (or a field).
 - It refers to a constraint (NOT NULL) of the variable (or a field).
 - It does not refer to the default initial value of the variable (or a field).
- Search order of the referenced target object is as follows.
 1. The name of a variable (or a field)
 2. The name of a column

NOT NULL Constraints Variables References

It does not refer to the initial value when referring to NOT NULL attribute variable, so a new initial value should be specified.

Setting an initial value of a field is not supported when using a type attribute for the field of a current record type variable, so NOT NULL type field can not be referenced.

Examples

```
gSQL> DECLARE
  V1 NUMBER(5,2) := 100.01;
  V2 V1%TYPE;
BEGIN
  DBMS_OUTPUT.PUT_LINE( 'V1 = ' || V1 );
  DBMS_OUTPUT.PUT_LINE( 'V2 = ' || V2 );
END;
/
V1 = 100.01
V2 =
Anonymous PL block executed.
```

Compatibility

It is not defined in the SQL standard.

23.41 UPDATE Statement Extension

Function

A feature altering a record by using a record type variable is added other than a feature consecutively listing the altering target columns of UPDATE statement in PSM.

It stores the result by using a record type variable in UPDATE (searched) RETURNING INTO clause in PSM.

Syntax

```

<update Extension statement : searched> ::=
    UPDATE table_name [ [ AS ] alias_name ]
        <target-list>
        [ WHERE <search condition> ]
        [ <result offset clause> ]
        [ <fetch limit clause> ]
        [ <returning into clause> ]
    ;

<update statement: positioned> ::=
    UPDATE table_name [ [ AS ] alias_name ]
        <Target-List>
        WHERE CURRENT OF cursor_name
    ;

<result offset clause> ::=
    OFFSET skip_count [ ROW | ROWS ]

<fetch limit clause> ::=
    <fetch first clause>
    | <limit clause>

<fetch first clause> ::=
    FETCH [ FIRST | NEXT ] [ row_count ] [ ROW ONLY | ROWS ONLY ]

<limit clause>
    LIMIT { fetch_row_count | offset_row_count, fetch_row_count | ALL }

<returning into clause> ::=
    { RETURN | RETURNING } [ NEW | OLD ] { * | { <value expression> [ [AS] alias_name ] } [,
    ...] } INTO Variable [, ...]

<target-List> ::=
    SET <set clause> [, ...]
  
```

```

    | SET ROW = <psm_variable>
<set clause> ::=
    column_name = { <value expression> | DEFAULT }
    | ( column_name [, ...] ) = ( { <value expression> | DEFAULT } [, ...] )
    | ( column_name [, ...] ) = ( <query expression> )

```

Invocation and Access Rules

It can be used only within PSM. (e.g. package, procedure, function)

It can be used only in the body section of a PL block.

Syntax Rules and Parameters

- <PSM_Variable> to be used in UPDATE SET ROW syntax should be a variable declared as a record type.
- <Variable> to be used in UPDATE RETURNING INTO syntax does not need to be a record type.
 - However, if a record type is specified, then it can not be used being mixed with other data type variables nor can two or more record type variables be listed.

Description

It alters the record or stores the result of RETURNING INTO through a record type variable in PSM.

Examples

```

gSQL> CREATE TABLE T1 (C1 VARCHAR(20), C2 VARCHAR(20));
Table created.
gSQL> INSERT INTO T1 VALUES ('AAA', 'BBB'), ('BBB', 'CCC'), ('CCC', 'DDD');
3 rows created.
gSQL> DECLARE
    v1 t1%ROWTYPE;
    v2 t1%ROWTYPE;
BEGIN
    v1.c1 := '1';
    v1.c2 := '2';

```

```
UPDATE T1 SET ROW = v1 WHERE c1 = 'AAA' RETURNING * INTO v2;  
DBMS_OUTPUT.PUT_LINE('SQL%ROWCOUNT=' || SQL%ROWCOUNT );  
DBMS_OUTPUT.PUT_LINE('v2.c1=' || v2.c1 || ', v2.c2=' || v2.c2);
```

```
END;
```

```
/
```

```
SQL%ROWCOUNT=1
```

```
v2.c1=1, v2.c2=2
```

```
Anonymous PL block executed.
```

```
gSQL> SELECT * FROM T1 ORDER BY C1;
```

```
C1 C2
```

```
--- ---
```

```
1 2
```

```
BBB CCC
```

```
CCC DDD
```

```
3 rows selected.
```

Compatibility

It is not defined in the SQL standard.

23.42 WHILE LOOP Statement

Function

It performs internal statements during <search condition> returns TRUE value.

Syntax

```
<while loop statement> ::=  
    WHILE <search condition>  
    LOOP { <SQL procedure statement> ; }... END LOOP [ loop_name ]  
    ;
```

Invocation and Access Rules

It can be used only within PSM. (e.g. package, procedure, function)

It can be used only in the body section of a PL block.

Syntax Rules and Parameters

- Search conditions are as follows.
 - It is a conditional expression which continues to circle a while loop.
 - It should finally return a boolean type.

Description

while loop statement performs an internal statement list as long as the evaluation result of <search condition> is TRUE.

Examples

```
gSQL> DECLARE
V1 integer := 0;
BEGIN
  WHILE V1 < 10 LOOP
    DBMS_OUTPUT.PUT_LINE( 'V1 = ' || V1 );
    V1 := V1 + 1;
  END LOOP;
END;
/
V1 = 0
V1 = 1
V1 = 2
V1 = 3
V1 = 4
V1 = 5
V1 = 6
V1 = 7
V1 = 8
V1 = 9
```

Anonymous PL block executed.

Compatibility

⟨while loop statement⟩ statement is defined as ⟨while statement⟩ in the SQL standard.

⟨while statement⟩ of the SQL standard performs loop statement as DO ... END WHILE, but GOLDILOCKS performs it as LOOP ... END LOOP.

For More Information

Refer to the followings.

- [CONTINUE Statement](#)
- [EXIT Statement](#)
- [GOTO Statement](#)

24.

PSM SQL References

24.1 ALTER FUNCTION

Function

It compiles a function again.

Syntax

```
<alter function statement> ::=  
    ALTER FUNCTION function_name COMPILE  
    ;
```

Invocation and Access Rules

One of the following privilege is required to perform <alter function statement>.

- The owner of that function
- (ALTER PROCEDURE or CONTROL SCHEMA) ON SCHEMA for the schema to which the function belongs
- ALTER ANY PROCEDURE ON DATABASE

Syntax Rules and Parameters

- function Name
 - It is the function name to be compiled.
 - It can define the schema to which the function belongs, such as schema_name.func_name. If schema_name is omitted, the default schema name of the user performing the statement is used.

Description

It compiles a specified schema-level function again.

Examples

```
gSQL> ALTER FUNCTION FUNC1 COMPILE;  
Function altered.
```

Compatibility

It is a statement altering characteristics specified when performing CREATE in the SQL standard, and a statement recreating a plan of a function in GOLDILOCKS.

Table 24-1 SQL standard compatibility

Feature ID	Description	Compatibility
F381	Extended schema manipulation	O

For More Information

Refer to the followings.

- CREATE FUNCTION
- DROP FUNCTION

24.2 ALTER PROCEDURE

Function

It compiles a procedure again.

Syntax

```
<alter procedure statement> ::=  
    ALTER PROCEDURE proc_name COMPILE  
    ;
```

Invocation and Access Rules

One of the following privilege is required to perform <alter procedure statement>.

- The owner of that procedure
- (ALTER PROCEDURE or CONTROL SCHEMA) ON SCHEMA for the schema to which the procedure belongs
- ALTER ANY PROCEDURE ON DATABASE

Syntax Rules and Parameters

- Proc Name
 - It is the procedure name to be compiled.
 - It can define the schema to which the procedure belongs, such as schema_name.proc_name. If schema_name is omitted, the default schema name of the user performing the statement is used.

Description

It compiles a specified schema-level procedure again.

Examples

```

gSQL> CREATE OR REPLACE PROCEDURE PROC1( A1 INTEGER )
IS
BEGIN
    INSERT INTO T1 VALUES( A1 );
END;
/
ERR-01000(16409): Warning: Routine definition has compilation errors
ERR-HY000(17032): PSM compilation error :
(1) at (5:15): ERR-17053: schema or table object does not exist
Procedure created.
gSQL> CALL PROC1(1);
ERR-HY000(17032): PSM compilation error :
(1) at (5:15): ERR-17053: schema or table object does not exist
gSQL> CREATE TABLE T1( I1 INTEGER );
Table created.
gSQL> COMMIT;
Commit complete.
gSQL> ALTER PROCEDURE PROC1 COMPILE;
Procedure altered.
gSQL> COMMIT;
Commit complete.
gSQL> CALL PROC1(2);
Procedure Call complete.
gSQL> SELECT * FROM T1;
I1
--
2
1 row selected.

```

Compatibility

It is a statement altering characteristics specified when performing CREATE in the SQL standard, and a statement recreating a plan of a procedure in GOLDILOCKS.

Table 24-2 SQL standard compatibility

Feature ID	Description	Compatibility
F381	Extended schema manipulation	O

For More Information

Refer to the followings.

- **CREATE PROCEDURE**
- **DROP PROCEDURE**

24.3 CALL Statement

Function

It performs a schema-level procedure or a function.

Syntax

```

<call statement> ::=
    <sql call statement> | <odbc procedure call escape sequence>
    ;
<sql call statement> ::=
    CALL proc_name [ ( value_expr [ , value_expr ] .. ) ] [ INTO { '?' | { host_param [
indicator_param ] } } ]
<odbc procedure call escape sequence> ::=
    '{' [ ? = ] CALL proc_name [ ( value_expr [ , value_expr ] .. ) ] '}'

```

Invocation and Access Rules

One of the following privilege is required to perform <call statement>.

- The EXECUTE privilege for that procedure
- (EXECUTE PROCEDURE or CONTROL SCHEMA) ON SCHEMA for the schema to which the procedure belongs
- EXECUTE ANY PROCEDURE ON DATABASE

Syntax Rules and Parameters

- proc_name
 - It is a name of a procedure/ function to be executed.
 - It may includes a schema to which the procedure belongs such as Schema_name.Proc_name.
- value_expr
 - It expresses an argument value which were transferred to the procedure. It can use a bind parameter such as '?' or ':V1'.

Description

It executes a schema-level SQL procedure or a function by using specified arguments.

A function of `<sql call statement>` form returns the result value by using a host variable expression or a dynamic bind parameter (?) after INTO clause.

`<odbc procedure call escape sequence>` form is a standard statement to call PROCEDURE in ODBC/ JDBC, and GOLDILOCKS supports this statement in a server. (It can also be used in a tool such as gsql.) A function returns the result value by using assign expressions (? =) at the front.

Examples

Call Procedure

```
gSQL> CREATE OR REPLACE PROCEDURE PROC1
(
  A1 INTEGER
)
IS
BEGIN
  DBMS_OUTPUT.PUT_LINE('A1= ' || A1);
END;
/
Procedure created.
gSQL> \var v1 INTEGER;
gSQL> \exec :v1 := 123;
gSQL> CALL PROC1(:v1);
A1=123
Procedure Call complete.
```

Call Function

```
CREATE OR REPLACE FUNCTION FUNC1
(
  A1 INTEGER
)
RETURN INTEGER
```



```
IS
BEGIN
    return A1;
END;
/
Function created.
gSQL> \var v1 INTEGER;
gSQL> \var v2 INTEGER;
gSQL> \exec :v1 := 123;
gSQL> CALL FUNC1(:v1) INTO :v2;
Procedure Call complete.
gSQL> \print v2;
V2
---
123
```

Compatibility

The SQL standard allows only the call for a PROCEDURE, so it does not define below [INTO] clause.

24.4 CREATE FUNCTION

Function

It defines a schema-level function.

Syntax

```

<create procedure statement> ::=
    CREATE [ OR REPLACE ]
        FUNCTION func_name [ ( { param_name [IN|OUT|INOUT] datatype [ { := | DEFAULT }
init_expr ] } [, ...] ) ]
        RETURN datatype
        [ <func_characteristics> ]
        { IS | AS } <item_declaration> BEGIN <pl_stmt_list> END
;
<func_characteristics> ::=
    DETERMINISTIC | AUTHID CURRENT_USER | AUTHID DEFINER

```

Invocation and Access Rules

The user should satisfy the following conditions to perform <create function statement>.

- One of the following privileges is required to create a function.
 - (CREATE PROCEDURE or CONTROL SCHEMA) ON SCHEMA for the schema to which the function belongs
 - CREATE ANY PROCEDURE ON DATABASE
- If a function already exists when using OR REPLACE clause, then one of the following privileges dropping the existing function is required.
 - The owner of that function
 - (DROP PROCEDURE or CONTROL SCHEMA) ON SCHEMA for the schema to which the function belongs
 - DROP ANY PROCEDURE ON DATABASE
- The user who performed the statement becomes the owner of the created function.

Syntax Rules and Parameters

OR REPLACE

It replaces an existing function when the function already exists.

FUNCTION NAME

It is a name of function to be created, and it should be a unique name in a schema.

It can define the schema to which the function belongs, such as `schema_name.func_name`. If `schema_name` is omitted, the default schema name of the user performing the statement is used.

The length of a function name should be shorter than 128 bytes.

PARAM NAME

It defines a name of an argument to be used in a function.

The name of each argument should be unique in a function.

The length of each argument name should be shorter than 128 bytes.

It does not limit the maximum number of an argument to be used in a single function.

Bind Type

It specifies a bind type of each argument.

If it is not specified, the default type is IN.

Func_Characteristics

It defines options to perform a function. It should be specified only once per a single item.

- **DETERMINISTIC**: The function always returns the same result value when the same argument values are input.
- **AUTHID CURRENT_USER**: SQLs which are being performed during performing a function are interpreted and performed according to an authorization of an invoker.
- **AUTHID DEFINER**: SQLs which are being performed during performing a function are interpreted and performed according to an authorization of a definer.

Item Declaration

It declares items such as a local variable to be used within a function.

It can declare all items which can be declared in a PL block.

PL Stmt List

It is a body section of a function, and it lists PL statements to be performed.

It can not use a bind parameter such as '?' or ':V1'. within a function.

Description

It defines a schema-level SQL function. The created function can be called from all expressions.

The definition of a function can be viewed in ROUTINES table of INFORMATION_SCHEMA. The definition of a function parameter can be viewed in PARAMETERS table of INFORMATION_SCHEMA.

If a function becomes temporarily unstable due to absences of related objects, then it can try to recreate a plan by using <alter function> statement.

The created function can be dropped by using <drop function> statement.

The maximum number of functions to be created is not limited. Therefore, they can be created as many as the storage space is available.

Examples

```
gSQL> CREATE OR REPLACE FUNCTION FUNC1( A1 INTEGER, A2 INTEGER )
RETURN INTEGER
IS
  V1 INTEGER;
BEGIN
  SELECT COUNT(*)
  INTO V1
  FROM T1
  WHERE T1.I1 >= A1 AND T1.I1 <= A2;
RETURN V1;
END;
/
```

Function created.

Compatibility

The SQL standard does not define OR REPLACE clause.

Table 24-3 SQL standard compatibility

Feature ID	Description	Compatibility
T471	Result sets return value	X
T341	Overloading of SQL-invoked functions and SQL-invoked procedures	X
S023	Basic structured types	X
S241	Transform functions	X
S024	Enhanced structured types	X
T571	Array-returning external SQL-invoked functions	X
T572	Multiset-returning external SQL-invoked functions	X
S201	SQL routines on arrays	X
S202	SQL-invoked routines on multisets	X
T323	Explicit security for external routines	X
S231	Structured type locators	X
S232	Array locators	X
S233	Multiset locators	X
T041	Basic LOB data type support	X
S027	Create method by specific method name	X
T041	Basic LOB data type support	X
T324	Explicit security for SQL routines	O
T326	Table functions	X
T651	SQL-schema statements in SQL routines	X
T652	SQL-dynamic statements in SQL routines	O
T653	SQL-schema statements in external routines	X
T654	SQL-dynamic statements in external routines	X
T655	Cyclically dependent routines	X
T272	Enhanced savepoint management	X
T522	Default values for IN parameters of SQL-invoked procedures	O
B121	Routine language Ada	X
B122	Routine language C	X
B123	Routine language COBOL	X
B124	Routine language Fortran	X
B125	Routine language MUMPS	X
B126	Routine language Pascal	X

Feature ID	Description	Compatibility
B127	Routine language PL/I	X
B128	Routine language SQL	O
B129	Routine language Ada: VARCHAR and NUMERIC support	X

For More Information

Refer to the followings.

- **DROP FUNCTION**
- **ALTER FUNCTION**

24.5 CREATE PROCEDURE

Function

It defines a schema-level procedure.

Syntax

```

<create procedure statement> ::=
    CREATE [ OR REPLACE ]
        PROCEDURE proc_name [ ( { param_name [IN|OUT|INOUT] datatype [ { := | DEFAULT }
init_expr ] } [, ...] ) ]
        [ <proc_characteristics> ]
        { IS | AS } <item_declaration> BEGIN <pl_stmt_list> END
    ;
<proc_characteristics> ::=
    AUTHID CURRENT_USER | AUTHID DEFINER

```

Invocation and Access Rules

The user should satisfy the following conditions to perform <create procedure statement>.

- One of the following privileges is required to create a procedure.
 - (CREATE PROCEDURE or CONTROL SCHEMA) ON SCHEMA for the schema to which the procedure belongs
 - CREATE ANY PROCEDURE ON DATABASE
- If a procedure already exists when using OR REPLACE clause, then one of the following privileges dropping the existing procedure is required.
 - The owner of that procedure
 - (DROP PROCEDURE or CONTROL SCHEMA) ON SCHEMA for the schema to which the procedure belongs
 - DROP ANY PROCEDURE ON DATABASE
- The user who performed the statement becomes the owner of the created procedure.

Syntax Rules and Parameters

OR REPLACE

It replaces an existing procedure when the procedure already exists.

PROC NAME

It is a name of procedure to be created, and it should be a unique name in a schema.

It can define the schema to which the procedure belongs, such as `schema_name.proc_name`. If `schema_name` is omitted, the default schema name of the user performing the statement is used.

The length of a procedure name should be shorter than 128 bytes.

PARAM NAME

It defines a name of an argument to be used in a procedure.

The name of each argument should be unique in a procedure.

The length of each argument name should be shorter than 128 bytes.

It does not limit the maximum number of an argument to be used in a single procedure.

Bind Type

It specifies a bind type of each argument.

If it is not specified, the default type is IN.

proc_characteristics

It defines options to perform a procedure. It should be specified only once per a single item.

- AUTHID CURRENT_USER: SQLs which are being performed during performing a procedure are interpreted and performed according to an authorization of an invoker.
- AUTHID DEFINER: SQLs which are being performed during performing a procedure are interpreted and performed according to an authorization of a definer.

Item Declaration

It declares items such as a local variable to be used within a procedure.

It can declare all items which can be declared in a PL block.

PL Stmt List

It is a body section of a procedure, and it lists PL statements to be performed.

It can not use a bind parameter such as '?' or ':V1'. within a procedure.

Description

It defines a schema-level SQL procedure. The created procedure can be called from CALL statement, anonymous block, or other procedure/ function.

The definition of a procedure can be viewed in ROUTINES table of INFORMATION_SCHEMA. The definition of a procedure parameter can be viewed in PARAMETERS table of INFORMATION_SCHEMA.

If a procedure becomes temporarily unstable due to absences of related objects, then it can try to recreate a plan by using <alter procedure> statement.

The created procedure can be dropped by using <drop procedure> statement.

The maximum number of procedures to be created is not limited. Therefore, they can be created as many as the storage space is available.

Examples

```
gSQL> CREATE OR REPLACE PROCEDURE PROC1( A1 INTEGER, A2 INTEGER )
  IS
  V1 INTEGER;
BEGIN
  SELECT COUNT(*)
  INTO V1
  FROM T1
  WHERE T1.I1 >= A1 AND T1.I1 <= A2;
  DBMS_OUTPUT.PUT_LINE( 'V1 = ' || V1 );
END;
/
```

Procedure created.

Compatibility

The SQL standard does not define the following clauses.

Table 24-4 SQL standard compatibility

Feature ID	Description	Compatibility
T471	Result sets return value	X
T341	Overloading of SQL-invoked functions and SQL-invoked procedures	X
S023	Basic structured types	X
S241	Transform functions	X
S024	Enhanced structured types	X
T571	Array-returning external SQL-invoked functions	X
T572	Multiset-returning external SQL-invoked functions	X
S201	SQL routines on arrays	X
S202	SQL-invoked routines on multisets	X
T323	Explicit security for external routines	X
S231	Structured type locators	X
S232	Array locators	X
S233	Multiset locators	X
T041	Basic LOB data type support	X
S027	Create method by specific method name	X
T041	Basic LOB data type support	X
T324	Explicit security for SQL routines	O
T326	Table functions	X
T651	SQL-schema statements in SQL routines	X
T652	SQL-dynamic statements in SQL routines	O
T653	SQL-schema statements in external routines	X
T654	SQL-dynamic statements in external routines	X
T655	Cyclically dependent routines	X
T272	Enhanced savepoint management	X
T522	Default values for IN parameters of SQL-invoked procedures	O
B121	Routine language Ada	X
B122	Routine language C	X
B123	Routine language COBOL	X
B124	Routine language Fortran	X
B125	Routine language MUMPS	X
B126	Routine language Pascal	X
B127	Routine language PL/I	X
B128	Routine language SQL	O
B129	Routine language Ada: VARCHAR and NUMERIC support	X

For More Information

Refer to the followings.

- [DROP PROCEDURE](#)
- [ALTER PROCEDURE](#)

24.6 DROP FUNCTION

Function

It drops a function.

Syntax

```
<drop function statement> ::=  
    DROP FUNCTION [ IF EXISTS ] func_name  
    ;
```

Invocation and Access Rules

One of the following privilege is required to perform <drop function statement>.

- The owner of that function
- (DROP PROCEDURE or CONTROL SCHEMA) ON SCHEMA for the schema to which the function belongs
- DROP ANY PROCEDURE ON DATABASE

Syntax Rules and Parameters

IF EXISTS

Even when the function does not exist, an error does not occur.

FUNC NAME

It is the function name to be dropped.

It can define the schema to which the function belongs, such as schema_name.func_name. If schema_name is omitted, the default schema name of the user performing the statement is used.

Description

It drops a specified schema-level function.

Examples

```
gSQL> CREATE OR REPLACE FUNCTION FUNC1
RETURN INTEGER
IS
    V1 INTEGER;
BEGIN
    V1 := 10;
    RETURN V1;
END;
/
```

Function created.

```
COMMIT;
```

Commit complete.

```
gSQL> DROP FUNCTION FUNC1;
```

Function dropped.

Compatibility

The SQL standard does not define the following clauses.

Table 24-5 SQL standard compatibility

Feature ID	Description	Compatibility
F032	CASCADE drop behavior	X
S024	Enhanced structured types	X

For More Information

Refer to the followings.

- **CREATE FUNCTION**

- ALTER FUNCTION

24.7 DROP PROCEDURE

Function

It drops a procedure.

Syntax

```
<drop procedure statement> ::=  
    DROP PROCEDURE [ IF EXISTS ] proc_name  
    ;
```

Invocation and Access Rules

One of the following privilege is required to perform <drop procedure statement>.

- The owner of that procedure
- (DROP PROCEDURE or CONTROL SCHEMA) ON SCHEMA for the schema to which the procedure belongs
- DROP ANY PROCEDURE ON DATABASE

Syntax Rules and Parameters

IF EXISTS

Even when the procedure does not exist, an error does not occur.

PROC NAME

It is the procedure name to be dropped.

It can define the schema to which the procedure belongs, such as schema_name.proc_name. If schema_name is omitted, the default schema name of the user performing the statement is used.

Description

It drops a specified schema-level procedure.

Examples

```
gSQL> CREATE OR REPLACE PROCEDURE PROC1( A1 INTEGER, A2 INTEGER )
IS
  V1 INTEGER;
BEGIN
  SELECT COUNT(*)
  INTO V1
  FROM T1
  WHERE T1.I1 >= A1 AND T1.I1 <= A2;
  DBMS_OUTPUT.PUT_LINE( 'V1 = ' || V1 );
END;
/
```

Procedure created.

```
COMMIT;
```

Commit complete.

```
gSQL> DROP PROCEDURE PROC1;
```

Procedure dropped.

Compatibility

The SQL standard does not define the following clauses.

Table 24-6 SQL standard compatibility

Feature ID	Description	Compatibility
F032	CASCADE drop behavior	X
S024	Enhanced structured types	X

For More Information

Refer to the followings.

- [CREATE PROCEDURE](#)
- [ALTER PROCEDURE](#)

Part V.

Developer Manual

25. ODBC	2,403
25.1 Overview of GOLDILOCKS ODBC Driver	2,404
Concepts of GOLDILOCKS ODBC Driver	2,404
Overview of ODBC Components	2,404
Using GOLDILOCKS ODBC Driver	2,405
25.2 Data Source Configuration	2,407
DSN Configuration on UNIX	2,407
DSN Configuration on Windows	2,413
25.3 GLOBAL CONNECTION	2,416
Features	2,416
Settings	2,417
Processing GLOBAL CONNECTION	2,418
Constraints	2,420
25.4 Catalog Function	2,422
Using Catalog Data	2,422
Catalog Function on ODBC	2,423
25.5 ODBC API References	2,427
SQLAllocConnect	2,427
SQLAllocEnv	2,428
SQLAllocHandle	2,429
SQLAllocStmt	2,432
SQLBindCol	2,433
SQLBindParameter	2,441
SQLBrowseConnect	2,456
SQLBulkOperations	2,457
SQLCancel	2,458
SQLCancelHandle	2,459
SQLCloseCursor	2,460
SQLColAttribute	2,462
SQLColAttributes	2,468
SQLColumnPrivileges	2,469
SQLColumns	2,473
SQLConnect	2,478
SQLCopyDesc	2,480
SQLDescribeCol	2,481
SQLDescribeParam	2,484
SQLDisconnect	2,486
SQLDriverConnect	2,488
SQLEndTran	2,492

SQLError	2,494
SQLExecDirect	2,495
SQLExecute	2,499
SQLExtendedFetch	2,502
SQLFetch	2,503
SQLFetchScroll	2,511
SQLForeignKeys	2,518
SQLFreeConnect	2,524
SQLFreeEnv	2,525
SQLFreeHandle	2,526
SQLFreeStmt	2,528
SQLGetConnectAttr	2,530
SQLGetConnectOption	2,534
SQLGetCursorName	2,535
SQLGetData	2,537
SQLGetDescField	2,543
SQLGetDescRec	2,559
SQLGetDiagField	2,563
SQLGetDiagRec	2,572
SQLGetEnvAttr	2,575
SQLGetFunctions	2,579
SQLGetGroupCount	2,584
SQLGetGroupIDs	2,586
SQLGetGroupName	2,588
SQLGetInfo	2,590
SQLGetStmtAttr	2,601
SQLGetStmtOption	2,613
SQLGetSuitableGroupID	2,614
SQLGetTypeInfo	2,616
SQLMoreResults	2,623
SQLNativeSql	2,627
SQLNumParams	2,628
SQLNumResultCols	2,631
SQLParamData	2,634
SQLParamOptions	2,636
SQLPrepare	2,637
SQLPrimaryKeys	2,643
SQLProcedureColumns	2,648
SQLProcedures	2,655

SQLPutData	2,660
SQLRowCount	2,665
SQLSetConnectAttr	2,668
SQLSetConnectOption	2,677
SQLSetCursorName	2,678
SQLSetDescField	2,681
SQLSetDescRec	2,704
SQLSetEnvAttr	2,709
SQLSetParam	2,713
SQLSetPos	2,714
SQLSetScrollOptions	2,727
SQLSetStmtAttr	2,728
SQLSetStmtOption	2,742
SQLSpecialColumns	2,743
SQLStatistics	2,750
SQLTablePrivileges	2,757
SQLTables	2,763
SQLTransact	2,769
25.6 XA API References	2,770
Overview	2,770
XA Interface	2,771
Example	2,782
26. JDBC	2,787
26.1 Overview of GOLDILOCKS JDBC Driver	2,788
Concepts of GOLDILOCKS JDBC Driver	2,788
Characteristics	2,788
Supporting Versions	2,790
Examples	2,791
26.2 Feature Specification	2,793
Connection	2,793
Data Manipulation	2,798
Data Retrieval	2,802
ResultSet Scroll	2,803
Using Other Data Types	2,805
Logging	2,809
Viewing Plan Text	2,811
Connection Failover	2,812
Connecting in Direct Attach Mode	2,814
26.3 JDBC API References	2,816

Array	2,816
Blob	2,818
CallableStatement	2,820
Clob	2,838
CommonDataSource	2,840
Connection	2,845
ConnectionPoolDataSource	2,855
DatabaseMetaData	2,856
DataSource	2,889
Driver	2,890
NClob	2,892
ParameterMetaData	2,894
PooledConnection	2,897
PreparedStatement	2,899
Ref	2,912
ResultSet	2,913
ResultSetMetaData	2,950
RowId	2,955
RowSet	2,956
RowSetMetaData	2,966
Savepoint	2,969
SQLData	2,970
SQLXML	2,971
Statement	2,973
Struct	2,983
XAConnection	2,984
XADataSource	2,985
XAResource	2,986
GoldilocksInterval	2,988
GOLDILOCKS Type	2,999
Type Conversion	2,999
27. Embedded SQL	3,005
27.1 Precompiler	3,006
Overview	3,006
Building Application	3,007
Precompiler Options	3,011
27.2 Embedded SQL	3,016
Preprocessing	3,016
Connection	3,022

Transaction	3,024
Host Variables and Datatypes	3,026
Embedded SQL	3,077
Options	3,098
Host Array	3,099
Handling Run-time Errors	3,116
27.3 Advanced Topic	3,130
Embedded Dynamic SQL	3,130
Multithread Application	3,144
C++ Application	3,155
XA	3,156
27.4 Embedded SQL Reference	3,170
EXEC SQL AT	3,171
EXEC SQL ATOMIC INSERT	3,172
EXEC SQL AUTOCOMMIT	3,174
EXEC SQL BEGIN DECLARE SECTION	3,175
EXEC SQL COMMIT RELEASE	3,176
EXEC SQL CONNECT	3,178
EXEC SQL CONTEXT ALLOCATE	3,180
EXEC SQL CONTEXT FREE	3,182
EXEC SQL CONTEXT USE	3,184
EXEC SQL DISCONNECT	3,186
EXEC SQL END DECLARE SECTION	3,187
EXEC SQL FOR	3,188
EXEC SQL GET GROUPID INTO	3,190
EXEC SQL INCLUDE	3,192
EXEC SQL INCLUDE SQLCA	3,193
EXEC SQL OPTION	3,194
EXEC SQL ROLLBACK RELEASE	3,195
EXEC SQL WHENEVER	3,197
28. PDO	3,199
28.1 Overview of PDO	3,200
28.2 Installation /Configuration	3,200
Requirement	3,200
Installation	3,200
28.3 Usage	3,202
Data Source Name (DSN)	3,202
28.4 Examples	3,203
29. PyDBC	3,213

29.1	GOLDILOCKS PyDBC	3,214
	Overview	3,214
	Version	3,214
	Installation	3,214
	Examples	3,215
29.2	API Reference	3,217
	pygoldilocks Module	3,217
	Connection	3,220
	Cursor	3,222
	Row	3,230
29.3	Exception	3,232
29.4	Data Type	3,233
	Transferring Python Parameter to GOLDILOCKS	3,233
	SQL Value Received from GOLDILOCKS	3,234
30.	Ruby	3,237
30.1	Overview	3,238
30.2	Installation	3,238
	Requirement	3,238
	Installing/ Removing	3,238
30.3	Examples	3,239
	Connecting	3,239
	Creating Table	3,240
	Inserting Data	3,240
	Retrieving Data	3,240
	Updating Data	3,241
	Deleting Data	3,242
	Arranging All Created Statement	3,242
	Dropping Table	3,242
	Disconnecting	3,242
30.4	Examples of ActiveRecord	3,242
	Connecting	3,243
	Inserting Data	3,243
	Retrieving Data	3,244
	Updating Data	3,244
	Deleting Data	3,245
31.	Hibernate	3,247
31.1	Overview	3,248
31.2	Interworking with Hibernate	3,248
	Downloading Hibernate	3,248

Interworking with GoldilocksDialect Class	3,248
31.3 Examples	3,249
Configuration	3,249
Examples of Application	3,250

25.

ODBC

25.1 Overview of GOLDILOCKS ODBC Driver

Concepts of GOLDILOCKS ODBC Driver

Open Database Connectivity (ODBC) is a specifications for a database Application Programming Interface (API). Microsoft ODBC version 3.0 is based on International Standards Organization/ International Electro mechanical Commission (ISO/ IEC) and the recommended specifications of Call Level Interface (CLI) of X/ open. ODBC supports the SQL statements by using C library functions. The application implements the ODBC features by calling these functions.

ODBC architecture has four components which perform the following features.

Component	Description
Application	It calls ODBC function which communicated with an ODBC data source and sends an SQL statement and processes the result set.
Driver manager	It manages the communication between an application and all ODBC drivers which are used by the application.
Driver	It processes all ODBC calls from applications, and connects to data source, and submits the SQL statement to the data source in the application, and returns results to the application. If necessary, the driver converts the ODBC SQL sent from the application to the default SQL which is used in the data source.
Data source	It includes all information which the driver needs to access the data in the DBMS.

The following operations can be executed by using ODBC applications.

- Connecting to a data source
- Sending SQL statements to the data source
- Processing the results of an SQL statement in the data source
- Handling errors and messages
- Terminating the connection to the data source

Overview of ODBC Components

GOLDILOCKS ODBC Driver Including Driver Manager

The following is a software architecture of when the driver manager is included in the system. In this case, the application should be linked to the driver manager library.

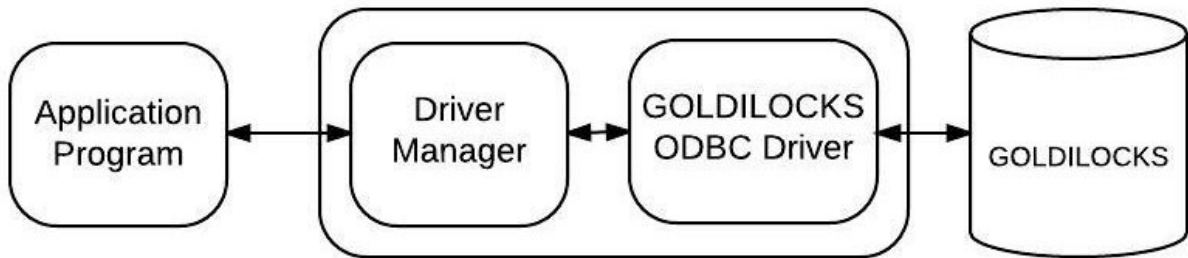
Figure 1 GOLDILOCKS ODBC driver including the driver manager

GOLDILOCKS ODBC Driver Not Including Driver Manager

The following is an architecture of when the application does not include a driver manager and uses GOLDILOCKS ODBC driver. In this case, the application should be linked to GOLDILOCKS ODBC driver library.

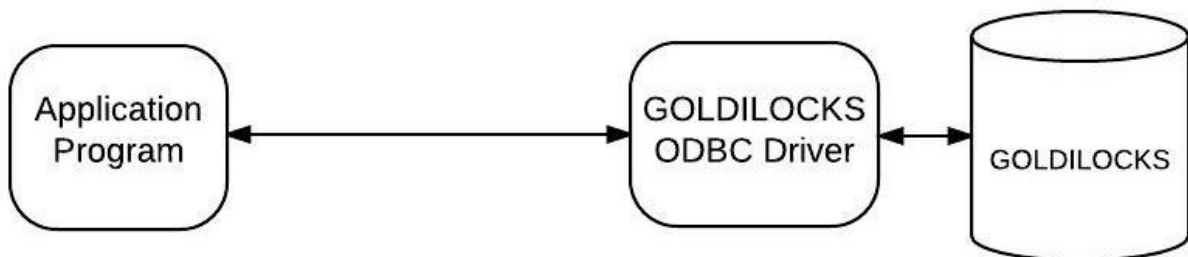
Figure 2 GOLDILOCKS ODBC driver not including the driver manager

Using GOLDILOCKS ODBC Driver

Header File

goldilocks.h file installed on `$GOLDILOCKS_HOME/include` should be included to execute GOLDILOCKS ODBC driver. This file defines constant and type of GOLDILOCKS ODBC driver, and provides a function prototype of GOLDILOCKS ODBC driver function.

Library

The application which does not use a driver manager should be linked to a static or shared version of GOLDILOCKS ODBC driver library.

UNIX

Table 25-1 GOLDILOCKS UNIX ODBC driver libraries

File name	Description
libgoldilocks.a	It is a static version of library including DA and CS.
libgoldilocks.a	It is a static version of DA dedicated library.
libgoldilocksas.so	It is a shared version of DA dedicated library.
libgoldilocksc.a	It is a static version of CS dedicated library.
libgoldilockscs-ul32.so	It is a shared version of 64-bit CS dedicated library recognizing SQLLEN to 4 bytes.
libgoldilockscs-ul64.so	It is a shared version of 64-bit CS dedicated library recognizing SQLLEN to 8 bytes.
libgoldilockscs.so	It is a shared version of 32-bit CS dedicated library.
libgoldilockss.so	It is a shared version of library including DA and CS.

Windows

GOLDILOCKS Windows ODBC driver libraries provide CS libraries only.

Table 25-2 GOLDILOCKS Windows ODBC driver libraries

File name	Description
goldilockscs-ul64.dll	It is a shared version of 64-bit CS dedicated library recognizing SQLLEN to 8 bytes.
goldilockscs.dll	It is a shared version of 32-bit CS dedicated library.
goldilockssetup32.dll	It is a setup library for 32-bit ODBC driver manager.
goldilockssetup64.dll	It is a setup library for 64-bit ODBC driver manager.

25.2 Data Source Configuration

DSN Configuration on UNIX

odbcinst.ini File

odbcinst.ini file is a configuration file for installed ODBC driver.

- unixODBC

```
% odbcinst -j
unixODBC 2.3.2
DRIVERS.....: /etc/odbcinst.ini
SYSTEM DATA SOURCES: /etc/odbc.ini
FILE DATA SOURCES..: /etc/ODBCDataSources
USER DATA SOURCES..: /home/goldilocks/.odbc.ini
SQLULEN Size.....: 8
SQLLEN Size.....: 8
SQLSETPOSIROW Size.: 8
```

- iODBC

```
% iodbc-config --odbcinstini
/etc/odbcinst.ini
```

ODBC Driver Specification

ODBC driver specification section in odbcinst.ini file specifies the driver property values and list. The registered information section is under the driver name in each driver installed.

```
[driver_name]
Description = driver_description
Driver = driver_library_path
Setup = setup_library_path
FileUsage = file_usage
```

The following table describes keywords in the driver specification section.

Keyword	Description
Description	It is a string which describes the driver.

Keyword	Description
Driver	It is a driver library path.
Setup	It is a setup library path.
FileUsage	It is a character which displays how to directly process the file in DSN by the file-based driver.

The following is an example of information of GOLDILOCKS ODBC driver specifications.

```
[GOLDILOCKS ODBC Driver]
Description= GOLDILOCKS ODBC Driver
Driver = /home/goldilocks/home/lib/libgoldilockscs-ul64.so
Setup = /home/goldilocks/home/lib/libgoldilockscs-ul64.so
FileUsage = 0
```

odbc.ini File

odbc.ini file is the configuration file for the DSN connected by the application, and it is divided into a user DSN and system DSN. Typically, a user DSN file is `~/.odbc.ini` file, and a system DSN file is `/etc/odbc.ini`.

- unixODBC

```
% odbcinst -j
unixODBC 2.3.4
DRIVERS.....: /etc/odbcinst.ini
SYSTEM DATA SOURCES: /etc/odbc.ini
FILE DATA SOURCES..: /etc/ODBCDataSources
USER DATA SOURCES..: /home/goldilocks/.odbc.ini
SQLULEN Size.....: 8
SQLLEN Size.....: 8
SQLSETPOSIROW Size.: 8
```

- iODBC

```
% iodbc-config --odbcini
/etc/odbc.ini
```

Data Source Specification

Data source specification section of the odbc.ini file describes DSN.

```
[data_source_name]
Driver = driver_name
PROTOCOL = protocol_type
```



```

CS_MODE = {default | dedicated | shared}
HOST = host_address
PORT = port_no
CHARSET = {SQL_ASCII | UTF8 | UHC | GB18030}
TCP_NODELAY = {0 | 1}
ALTERNATE_SERVERS = (HOST=ADDRESS1:PORT=PORT1,HOST=ADDRESS2:PORT=PORT2)
CONNECTION_RETRY_COUNT = retry_count
CONNECTION_RETRY_DELAY = retry_delay
FAILOVER_TYPE = {CONNECTION | SESSION}
FAILOVER_GRANULARITY = {0 | 1 | 2}
DATE_FORMAT = date_format_string
TIME_FORMAT = time_format_string
TIME_WITH_TIME_ZONE_FORMAT = timetz_format_string
TIMESTAMP_FORMAT = timestamp_format_string
TIMESTAMP_WITH_TIME_ZONE_FORMAT = timestamptz_format_string
CHAR_LENGTH_UNITS = {BYTE | OCTETS | CHAR | CHARACTERS}
ENABLE_SQLDESCRIBEPARAM = {0 | 1}
ENABLE_SQLBINDPARAMETER_CONSISTENCY_CHECK = {0 | 1}
USE_TARGETTYPE = {0 | 1 | 2}
LOCATOR_DSN = locator_dsn_name
LOCATOR_SERVICE = locator_service_name
LOCALITY_AWARE_TRANSACTION = {0 | 1}
LOCALITY_GROUP_POLICY = {0 | 1 | 2}
LOCALITY_GROUP_PATH = group_name1, group_name2, group_name3
LOCALITY_MEMBER_POLICY = {0 | 1 | 2 | 3 | 4}
LOCALITY_MEMBER_PATH = member_name1,member_name2, member_name3
DB_HOME = database_home_path
PACKET_COMPRESSION_THRESHOLD = packet_compression_threshold
[locator_dsn_name]
FILE = location_file_name
HOST = IP address(v4)
PORT = locator_port
CONNECTION_TIMEOUT = second
ALTERNATE_LOCATORS = (HOST=ADDRESS1:PORT=PORT1,HOST=ADDRESS2:PORT=PORT2)

```

The following table describes keywords in the data source specification section.

Table 25-3 Keywords in the data source specification section

Keyword	Description
data_source_name	It is the data source specified in the data source section.
Driver	It is a driver name installed on odbcinstant.ini.

Keyword	Description
PROTOCOL	It is a connection type, which is DA or TCP.
CS_MODE	It sets whether to connect as dedicated mode or shared mode. If it is not set, the default mode is determined depending on the configuration (DEFAULT_CS_MODE) of the listener.
HOST	It is a host IP address.
PORT	It is a connection port number.
TCP_NODELAY	It is a socket TCP_NODELAY option.
UID	It is a user ID.
PWD	It is a user password.
CHARSET	It is a client character set.
ALTERNATE_SERVERS	It is a server list which attempts to connect when the failover occurs. Each servers is separated by a comma (.). To disable the failover feature, set ALTERNATE_SERVERS as a white space.
CONNECTION_RETRY_COUNT	It is the number of times which the driver attempts to connect to the server when the connection fails.
CONNECTION_RETRY_DELAY	It is the server connection retry interval (in seconds) when the connection fails.
FAILOVER_TYPE	<ul style="list-style-type: none"> • CONNECTION: When the connection fails, it is connected to ALTERNATE_SERVERS. • SESSION: When the connection fails or the connection is disconnected during operating the statement, it is connected to ALTERNATE_SERVERS and the statement is restored. The statement is executed after the failover if the connection is disconnected when a transaction is not in progress.
FAILOVER_GRANULARITY	<ul style="list-style-type: none"> • 0: The failover proceeds even when an error occurs. • 1: The failover fails when an error except for SQLExecute (), SQLExecDirect () occurs during the failover). • 2: The failover fails when an error occurs.
DATE_FORMAT	It is a DATE type string.
TIME_FORMAT	It is a TIME type string.
TIME_WITH_TIME_ZONE_FORMAT	It is a TIME WITH TIME ZONE type string.
TIMESTAMP_FORMAT	It is a TIMESTAMP type string.
TIMESTAMP_WITH_TIME_ZONE_FORMAT	It is a TIMESTAMP WITH TIME ZONE type string.
CHAR_LENGTH_UNITS	It is the unit of ColumnSize when ParameterType in SQLBindParameter() is SQL_CHAR, SQL_VARCHAR. <ul style="list-style-type: none"> • BYTE, OCTETS: Byte unit • CHAR, CHARACTERS: Character unit
ENABLE_SQLDESCRIBEPARAM	It determines whether to enable SQLDescribeParam(). <ul style="list-style-type: none"> • 0: The driver does not support SQLDescribeParam(). • 1: The driver returns SQL_VARCHAR for all parameters.
ENABLE_SQLBINDPARAM	It determines whether to check ColumnSize and DecimalDigits in SQLBindParameter()...

Keyword	Description
ETER_CONSISTENCY_CHECK	<ul style="list-style-type: none"> 0: It does not check ColumnSize and DecimalDigits. 1: It checks ColumnSize and DecimalDigits.
USE_TARGETTYPE	<p>It sets the type information which is to be received together when receiving a column type through communication.</p> <ul style="list-style-type: none"> 0: It receives only the column type. 1: It receives the column type and column name. 2: It receives the column type and all information about the column.
LOCATOR_DSN	It is Data Source Name (DSN) which specifies a location information.
LOCATOR_SERVICE	It gets the connection information from a service hint and locator.
LOCALITY_AWARE_TRANSACTION	<p>It determines whether to use GLOBAL CONNECTION.</p> <ul style="list-style-type: none"> 0: It does not use GLOBAL CONNECTION. 1: It uses GLOBAL CONNECTION.
LOCALITY_GROUP_POLICY	<p>It determines how to select a group if neither of groups are available, or two or more groups are available when using GLOBAL CONNECTION.</p> <ul style="list-style-type: none"> 0: It randomly selects the group. 1: It sequentially selects groups which exist in LOCALITY_GROUP_PATH setting. If neither of groups in LOCALITY_GROUP_PATH are not available, it randomly selects the group. 2: It sequentially selects groups. It always selects groups in an order of they are connected to the driver.
LOCALITY_GROUP_PATH	<p>It defines the list of selected groups when the available group is not a single one when using GLOBAL CONNECTION. Each group is distinguished with comma (,).</p> <p>e.g. G1,G2,G3</p>
LOCALITY_MEMBER_POLICY	<p>It determines how to select a member in the selected group when using GLOBAL CONNECTION.</p> <ul style="list-style-type: none"> 0: DML : MASTER / SELECT : MASTER 1: DML : ANY / SELECT : ANY 2: DML : MASTER / SELECT : ANY 3: DML : MASTER / SELECT : SLAVE 4: It sequentially selects members which exist in LOCALITY_MEMBER_PATH setting. If neither of members in LOCALITY_MEMBER_PATH are not available, it uses the MASTER in the selected group.
LOCALITY_MEMBER_PATH	<p>It defines the list of members to be used in the selected group when using GLOBAL CONNECTION. Each member is distinguished with comma (,).</p> <p>e.g. G1N1,G2N1,G3N1,G1N2,G2N2,G3N2</p>
DB_HOME	It sets the home directory of the database. The default value uses \$GOLDILOCKS_HOME environment variable.
PACKET_COMPRESSION_THRESHOLD	It compresses the communication data when the size of the communication data to be sent to the server is bigger than PACKET_COMPRESSION_THRESHOLD. The range of the set value is 32 ~ 2113929216.

Table 25-4 Location

Keyword	Description
FILE	Location file name
HOST	glocator ip address
PORT	glocator port number
CONNECTION_TIMEOUT	Connection timeout with glocator (second)
ALTERNATE_LOCATORS	If glocator does not respond, it gets the connection information by using ALTERNATE_LOCATORS.



- If properties of FILE, HOST, PORT are all set in LOCATOR_DSN, then the FILE property is prior to others. For more information, refer to **Location File**.
- LOCATOR_SERVICE property enables to connect to a server belonging to LOCATOR_SERVICE. Servers other than the connected server become ALTERNATE_SERVERS.
If FAILOVER_TYPE is not set, then FAILOVER_TYPE is a session.
If FAILOVER_GRANULARITY is not set, then FAILOVER_GRANULARITY is 1.
For more information, refer to **glocator** and **gloctl**.

The following is an example of DSN configuration of GOLDILOCKS.

```
[GOLDILOCKS]
Driver = GOLDILOCKS ODBC Driver
PROTOCOL = TCP
CS_MODE = SHARED
HOST = 192.168.0.10
PORT = 22581
CHARSET = UTF8
TCP_NODELAY = 1
ALTERNATE_SERVERS = (HOST=192.168.0.11:PORT=22581,HOST=192.168.0.12:PORT=22581)
CONNECTION_RETRY_COUNT = 3
CONNECTION_RETRY_DELAY = 1
FAILOVER_TYPE = SESSION
FAILOVER_GRANULARITY = 0
DATE_FORMAT = SYYYY-MM-DD
TIME_FORMAT = HH24:MI:SS.FF6
TIME_WITH_TIME_ZONE_FORMAT = HH24:MI:SS.FF6 TZH:TZM
TIMESTAMP_FORMAT = SYYYY-MM-DD HH24:MI:SS.FF6
TIMESTAMP_WITH_TIME_ZONE_FORMAT = SYYYY-MM-DD HH24:MI:SS.FF6 TZH:TZM
CHAR_LENGTH_UNITS = CHARACTERS
```

```

ENABLE_SQLDESCRIBEPARAM = 1
ENABLE_SQLBINDPARAMETER_CONSISTENCY_CHECK = 1
USE_TARGETTYPE = 0
PACKET_COMPRESSION_THRESHOLD = 2113929216
LOCALITY_AWARE_TRANSACTION = 0
LOCALITY_GROUP_POLICY = 0
LOCALITY_GROUP_PATH = G1,G2,G3
LOCALITY_MEMBER_POLICY = 0
LOCALITY_MEMBER_PATH = G1N1,G2N1,G3N1,G1N2,G2N2,G3N2
LOCATOR_DSN = LOCATOR
LOCATOR_SERVICE = S1
[LOCATOR]
FILE = /home/test/.location.ini
HOST = 127.0.0.1
PORT = 42581
ALTERNATE_LOCATORS=(HOST=127.0.0.1:PORT=42582,HOST=127.0.0.1:PORT=42583)

```

DSN Configuration on Windows

ODBC data source manager can add or set up DSN on Windows.

Figure 3 Creating new data source

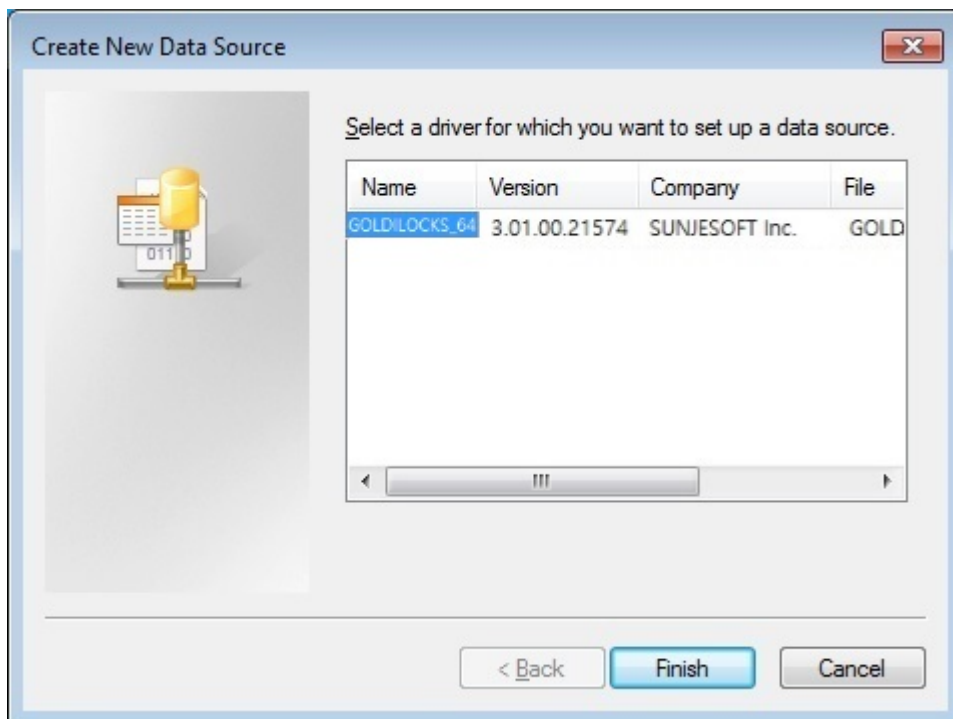
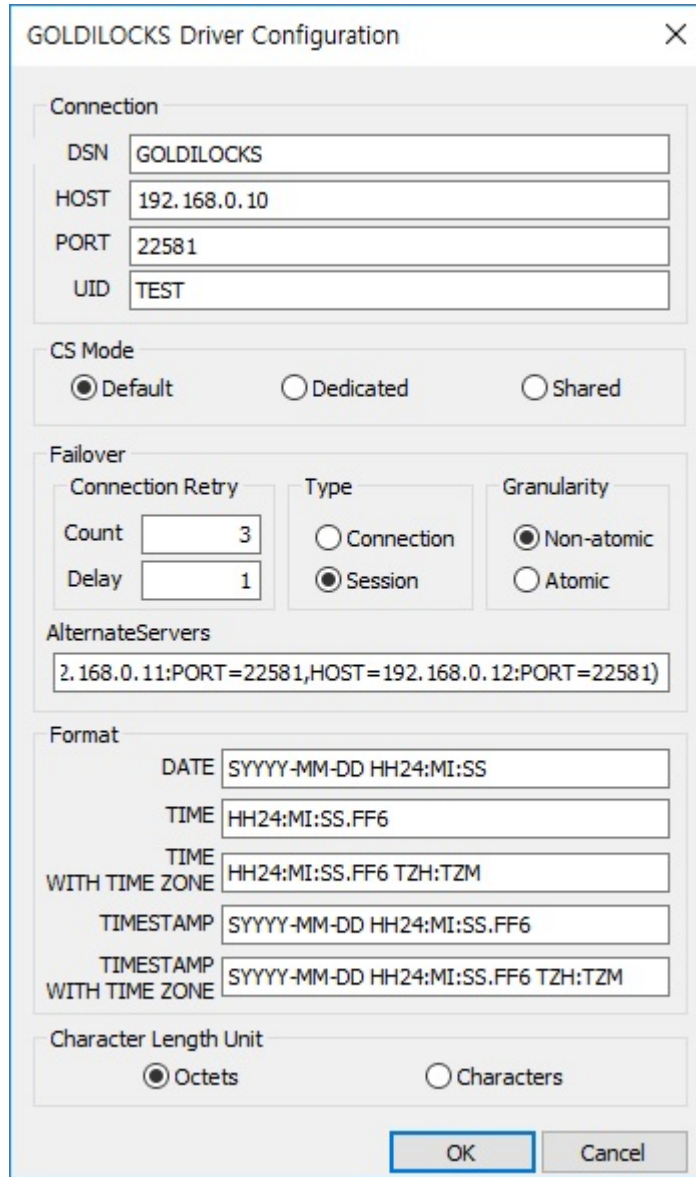

Figure 4 Configuring ODBC driver



The following table describes keywords for DSN configuration.

Table 25-5 Keywords for DSN configuration

Keyword	Description
DSN	It is a data source name.
HOST	It is a host IP address.
PORT	It is a connection port number.
UID	It is a user ID.
CS_MODE	It sets whether to connect as dedicated mode or shared mode. If it is not set, the default mode is determined depending on the configuration (DEFAULT_CS_MODE) of the listener.
ALTERNATE_SERVERS	It is a server list which attempts to connect when the failover occurs. Each servers is separated by a comma (,).

Keyword	Description
	To disable the failover feature, set ALTERNATE_SERVERS as a white space.
CONNECTION_RETRY_COUNT	It is the number of times which the driver attempts to connect to the server when the connection fails.
CONNECTION_RETRY_DELAY	It is the server connection retry interval (in seconds) when the connection fails.
FAILOVER_TYPE	<ul style="list-style-type: none"> • CONNECTION: When the connection fails, it is connected to ALTERNATE_SERVERS. • SESSION: When the connection fails or the connection is disconnected during operating the statement, it is connected to ALTERNATE_SERVERS and the statement is restored. The statement is executed after the failover if the connection is disconnected when a transaction is not in progress.
FAILOVER_GRANULARITY	<ul style="list-style-type: none"> • Non-atomic: The failover proceeds even when an error occurs. • Atomic: The failover fails when an error occurs.
DATE_FORMAT	It is a DATE type string.
TIME_FORMAT	It is a TIME type string.
TIME_WITH_TIME_ZONE_FORMAT	It is a TIME WITH TIME ZONE type string.
TIMESTAMP_FORMAT	It is a TIMESTAMP type string.
TIMESTAMP_WITH_TIME_ZONE_FORMAT	It is a TIMESTAMP WITH TIME ZONE type string.
CHAR_LENGTH_UNITS	<p>It is the unit of ColumnSize when ParameterType in SQLBindParameter() is SQL_CHAR, SQL_VARCHAR.</p> <ul style="list-style-type: none"> • BYTE, OCTETS: Byte unit • CHAR, CHARACTERS: Character unit

25.3 GLOBAL CONNECTION

GLOBAL CONNECTION of which an application selects and performs an appropriate node for a query processing in cluster environment is supported.

Features

Figure 5 GLOBAL CONNECTION

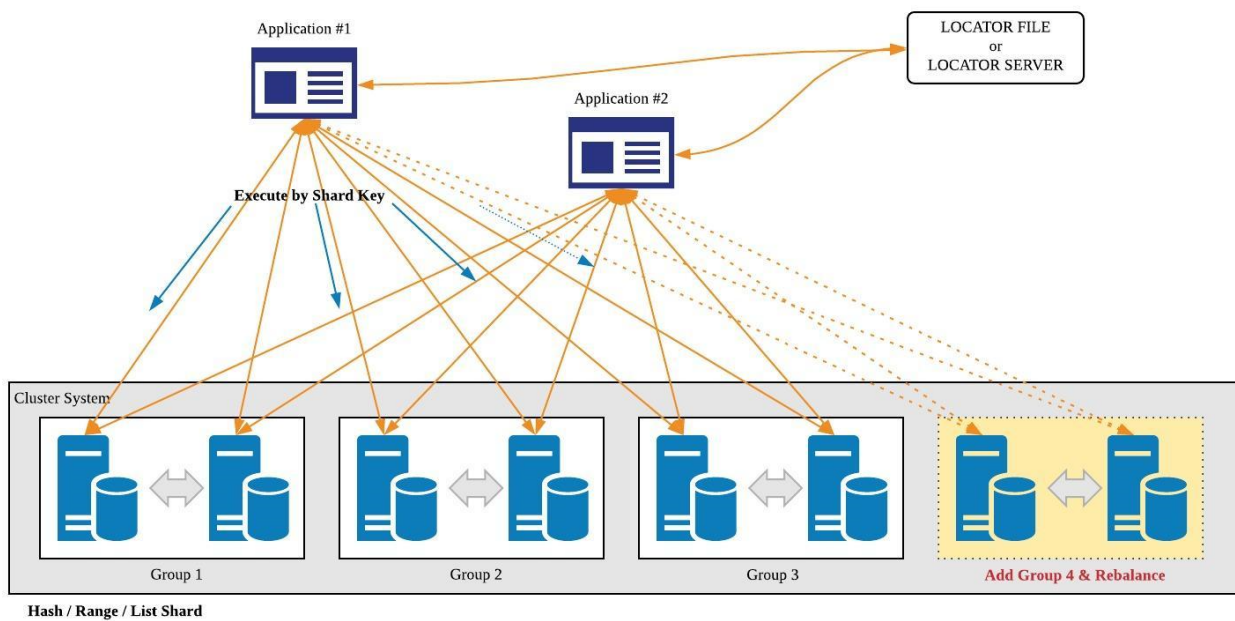

Hash, range, list sharding method use GLOBAL CONNECTION, and the application does not need to be altered at that moment.

When GLOBAL CONNECTION is used, an application connects to all nodes in a cluster system. It automatically selects and executes an appropriate node depending on the given shard key value when executing SQL statement.

Also, the application automatically connects to a new node and operate it when the online scale-out is performed, so a user does not need to care for a new node.

Figure 6 GLOBAL CONNECTION HA (high availability)

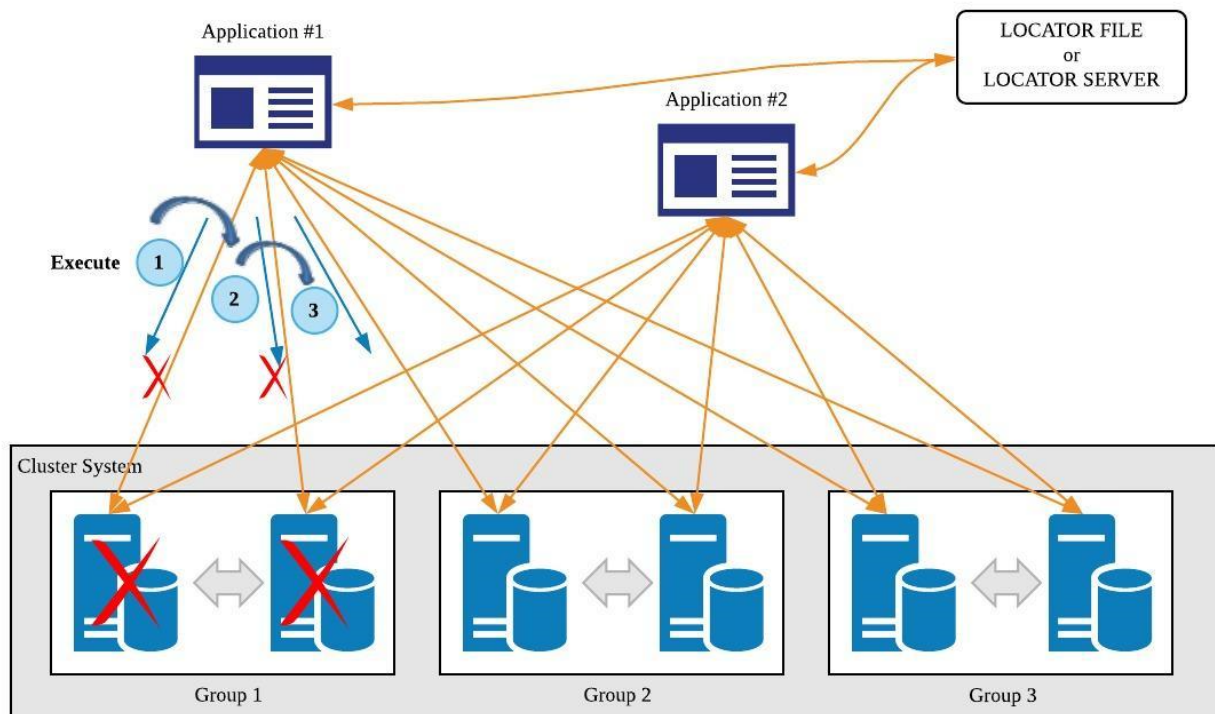

If an error occurs on the selected node when performing SQL, then the SQL is performed through another node in the same group. If errors occur on all nodes in the selected group, then the SQL is performed through another group.

When a node is recovered from an error, the node is automatically connected online. Moreover, a user can make an application connect again by using the following syntax.

```
ALTER SYSTEM RECONNECT GLOBAL CONNECTION
```

Settings

LOCALITY_AWARE_TRANSACTION property should be set together with LOCATOR file or LOCATOR server to use GLOBAL CONNECTION.

- .odbc.ini of when using DSN

```
[GOLDILOCKS]
```

```
HOST = 192.168.0.1
```

```
PORT = 22581
```

```
UID = TEST
```

```
PWD = test
```

```

LOCALITY_AWARE_TRANSACTION = 1
LOCATOR_DSN = LOCATOR
[LOCATOR]
FILE = /home/goldilocks/.location.ini

```

- Using connection string

```

SQLDriverConnect( dbc,
                  NULL,
                  (SQLCHAR*)"HOST=192.168.0.1;PORT=22581;UID=TEST;PWD=test;LOCALITY_AWARE_TRAN
SACTION=1;LOCATOR_HOST=192.168.0.2;LOCATOR_PORT=42581",
                  SQL_NTS,
                  NULL,
                  0,
                  NULL,
                  SQL_DRIVER_NOPROMPT );

```

Processing GLOBAL CONNECTION

Figure 7 Basic steps of applying GLOBAL CONNECTION

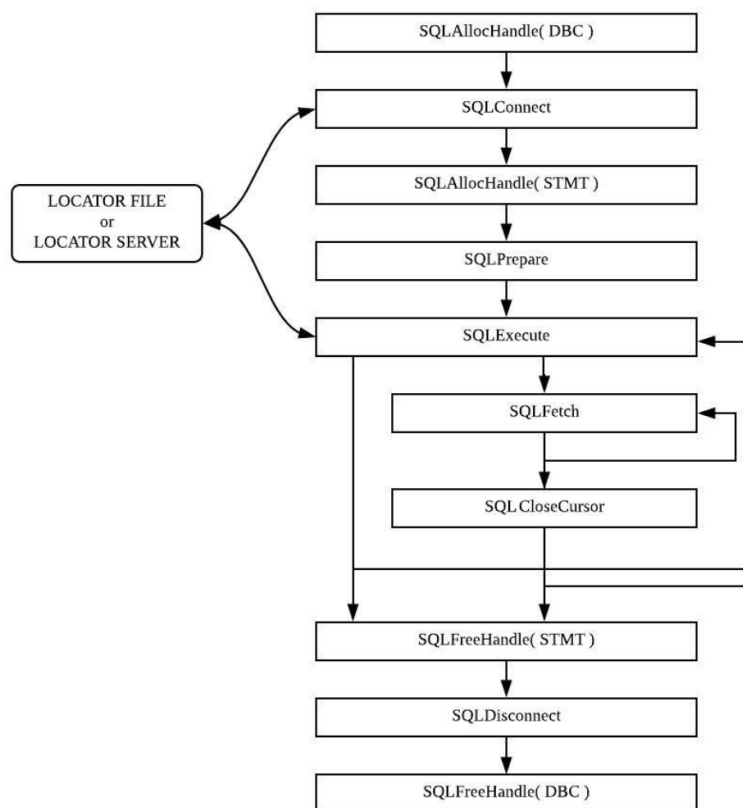

1. `SQLAllocHandle (DBC)`
It allocates a connection handle.
2. `SQLConnect`
It connects to a server which was given server information from a user, and obtains the information about the cluster system. Then builds the cluster system information through LOCATOR file or LOCATOR server, and connects to all nodes of cluster system.
3. `SQLAllocHandle(STMT)`
It allocates a statement to each of all connected nodes.
4. `SQLPrepare`
It prepares to execute SQL in all connected nodes.
5. `SQLExecute`
If the information about the cluster system is not built, an application builds the information about the cluster system through LOCATOR file or LOCATOR server, then connects to all nodes in the cluster system.
When connecting to a new node by adding a node to cluster, all statements of other nodes are equally created in that node, and prepares to execute SQL.

If the information about a sharding key has already built, an application selects an appropriate node and performs a query by using the sharding key information.

If the information about a sharding key is not built, an application builds the sharding key information of the SQL from an arbitrary server, then selects a node and performs a query.

If an error occurs on the selected node, an appropriate node is selected again, then performs a query.

If the information about a sharding key is altered after `SQLExecute`, then it deletes the built information about a sharding key

If the information about the cluster system is altered such as adding or deleting a cluster node after `SQLExecute`, then it deletes the built cluster system information.

6. `SQLFetch`
It brings data from the node on which SQL was executed.
7. `SQLCloseCursor`
It closes a cursor from the node on which SQL was executed.
8. `SQLFreeHandle(STMT)`
It releases a statement from all connected nodes.
9. `SQLDisconnect`
It releases connections with all nodes.

10. SQLFreeHandle(DBC)

It releases a connection handle.

Constraints

When using global connection, a session dependent object, a session dependent clause or a session dependent function can not be used in SQL statement.

Moreover, if SQLs accessing to multiple cluster nodes exist in a single transaction, SQLs in the transaction uses in common the cluster node which is selected by a sharding key of the first SQL.

SQLExecDirect is performed in an arbitrary node.

Session Dependent Object

If a session dependent object is used in an SQL statement, then global connection is not supported.

- Global temporary table

Session Dependent Clause

If a session dependent clause is used in an SQL statement, then global connection is not supported.

- All statement related to @domain

Session Dependent Function and Pseudo Column

If the session dependent information is used in an SQL statement, then global connection is not supported.

- CURRVAL(sequence), sequence.CURRVAL
- UUID()
- VERSION()
- SESSION_ID()
- SESSION_SERIAL()
- USER_ID()
- LAST_IDENTITY_VALUE()
- STATEMENT_VIEW_SCN()
- STATEMENT_VIEW_SCN_GCN()
- STATEMENT_VIEW_SCN_DCN()

- STATEMENT_VIEW_SCN_LCN()
- LOCAL_GROUP_ID()
- LOCAL_MEMBER_ID()
- LOCAL_GROUP_NAME()
- LOCAL_MEMBER_NAME()

25.4 Catalog Function

All databases have schemas of how to store the data in the database. For example, a simple sales order database will have the schemas shown in the following figure, and the ID columns are used to connect the tables.

Figure 8 Schema of sales orders

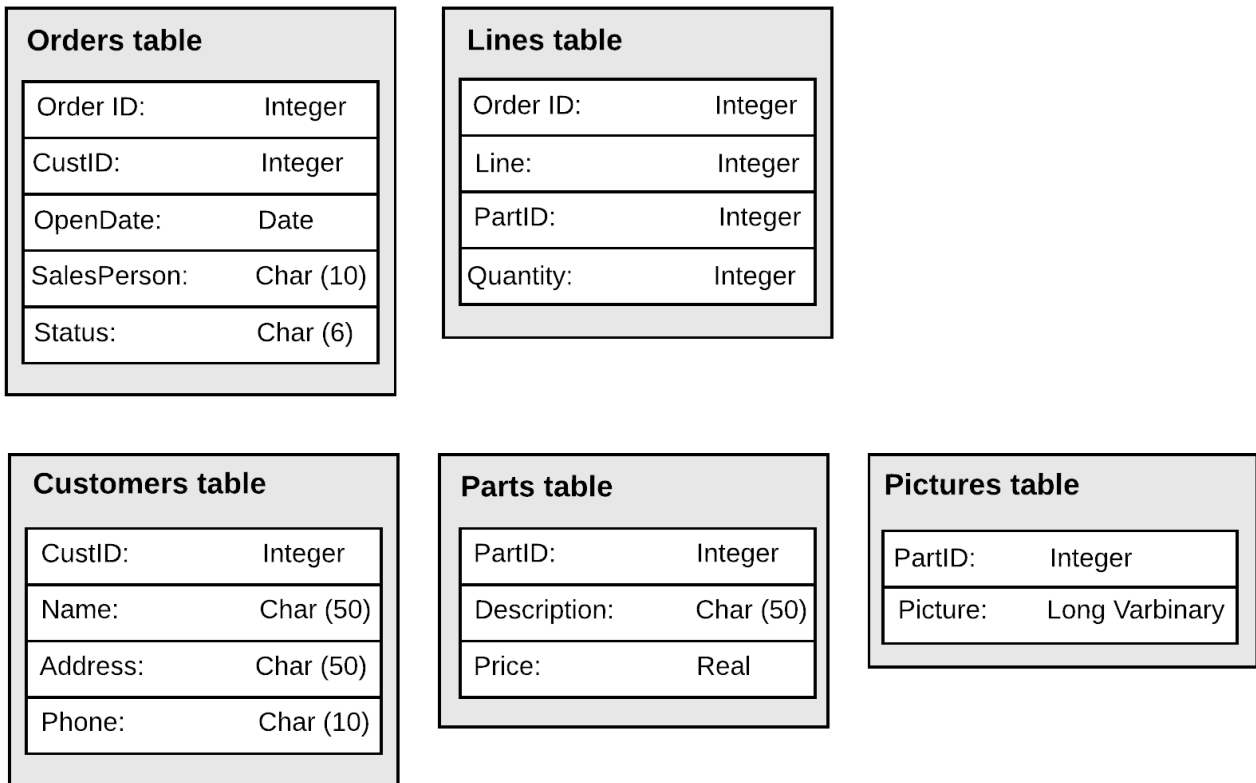

The schema is stored in the set of system tables which is called as a database catalog along with other information such as privileges. This is also known as a data dictionary.

Applications can find this schema by calling the catalog functions. Catalog functions return the information to the result set, and typically they are implemented by SELECT statements for the tables in the catalog.

Using Catalog Data

Applications use catalog data in various ways. The followings are some common usages.

Configuring SQL statements at the time of execution

The vertical applications such as the order input application include the hard-coded SQL statements. The tables and columns used by the application were previously fixed, and the application access these tables. For example, the ordering application typically has one parameterized statement to add a new order to the system.

A general application such as a spreadsheet program using ODBC for collecting the data sometimes configures the SQL statement based on the input from a user at the time of execution. This application may request a user for the format to use tables and columns. However, if the list of tables or columns selected by a user is shown to the application, it will be easier to the user. The application will call catalog functions such as `SQLTables` and `SQLColumns` to configure these lists.

Configuring SQL statements during the development

The application development environments allow the developers to create database queries during developing the program. And then the queries are hard-coded and embedded into the application.

These environments can also create a list of what were selected by the developer by using the `SQLTables` and `SQLColumns`. The environments find out and display the relationships among the tables automatically selected by using `SQLPrimaryKeys` and `SQLForeignKeys`. Then they find out and emphasize the index fields by using `SQLStatistics`, so the developers can create queries effectively.

Configuring a Cursor

The application, driver, middleware which provides a scroll cursor, find out column(s) which is the only column of identifying a row by using `SQLSpecialColumns`. The program can configure a keyset including the values of these columns for the collected rows. The application will use these values to collect the latest data for the rows by scrolling backwards.

Catalog Function on ODBC

ODBC includes the following catalog functions.

Function	Description
<code>SQLTables</code>	It returns a list of catalogs, schemas, tables or table types in the data source.
<code>SQLColumns</code>	It returns a list of columns in one or more tables.
<code>SQLStatistics</code>	It returns a list of statistics for a single table. It also returns a list of indexes linked to the table.
<code>SQLSpecialColumns</code>	It returns a list of columns which is the only column of identifying a row in a table. Also,

Function	Description
	it returns a list of columns in the table, and they are automatically updated.
SQLPrimaryKeys	It returns a list of columns which configure the primary key of a table.
SQLForeignKeys	It returns a list of foreign keys in a table or it returns a list of foreign keys in another table referring that table.
SQLTablePrivileges	It returns a list of privileges associated with one or more tables.
SQLColumnPrivileges	It returns a list of privileges associated with one or more columns in a table.
SQLProcedures	It is not supported by the driver.
SQLProcedureColumns	It is not supported by the driver.
SQLGetTypeInfo	It returns a list of SQL data types supported by the data source. These data types are generally used in CREATE TABLE, ALTER TABLE statements.

Data Returning of Catalog Function

Each catalog function returns the data as a result set. The result set is not different from any other result set. It is usually hard-coded into the driver, or it is created by the predefined statement such as the parameterized SELECT statement stored in the procedure of data source.

The result set for each catalog function is described in *For More Information* paragraph of each function in this user manual. The result set can include the columns specified in the driver after the column selected last besides the listed columns. These columns are described in a user manual for the driver.

The applications bind the columns specified in the driver based on the end of result set. They calculate the number of columns specified in the driver as the number of last columns which are smaller than the number of columns after the required column. This saves the trouble of changing the application when a new column is added in future version or ODBC driver. To operate this schema, drivers should add the columns specified in the new driver before the columns specified in the old driver to prevent changing the row number based on the end of result set.

Even when they include special characters, they do not quote the identifiers returned in the result set. For example, if the Accounts Payable table's identifier quote character which is specified in the driver and returned by SQL GetInfo is a double quotes ("), and the Accounts Payable table has a Customer Name column, then TABLE_NAME column value in the rows which is returned by SQLColumns is Accounts Payable, but it is not "Accounts Payable", and COLUMN_NAME column value is Customer Name, but it is not "Customer Name".

The application collects the names of customers from the Accounts Payable table as follows.

```
SELECT "Customer Name" FROM "Accounts Payable"
```

Catalog functions are based on SQL-like model in connection based on the user name and password, and their data is returned only to the users with the proper privilege. The file password protection which is in

appropriate to this model is defined by the drivers.

Most result set returned by the catalog functions can not be updated, and the application should not expect to change the database schema by updating the data in the result set.

Arguments of Catalog Function

Pattern Value Argument

Some arguments in catalog function accept the search pattern, like as `TableName` argument in `SQLTables`. The arguments accept the search pattern if `SQL_ATTR_METADATA_ID` attribute is set to `SQL_FALSE`. The arguments do not accept the search pattern if `SQL_ATTR_METADATA_ID` attribute is set to `SQL_TRUE`.

Search pattern letters have the following features.

- An underscore(`_`) represents any single character.
- Percent sign (`%`) represents zero or more characters.
- An escape character is specified in the driver and it is used to include the percent sign, underscore, escape character as literals. If an escape character is prior to a non-special character, it does not have any special meaning. But if an escape character is prior to a special character, it is a special character. For example, `"\a"` is treated as two characters consisting of `"\"` and `"a"`, but `"\%"` refers to `"%"`.

An escape character is returned by using `SQL_SEARCH_PATTERN_ESCAPE` option in `SQLGetInfo`. To include that character as a literal in an argument which accepts search patterns, it should be prior to any underscore, percent sign, or escape character.

The following table describes how to use search patterns.

Search pattern	Description
<code>%A%</code>	It is all identifiers which contain A.
<code>ABC_</code>	It is all four letter characters which start with ABC.
<code>ABC\</code>	It assumes the escape character a backslash(<code>\</code>), and the identifier is <code>ABC_</code> .
<code>\%\</code>	It assumes the escape character a backslash(<code>\</code>), and the identifier which start with a backslash(<code>\</code>)



Be cautious when using a escape character in an argument which accepts a search pattern. This is particularly TRUE for the underscore(`_`) which is generally used as the identifier.

It is a common mistake in the application that the value returned by one catalog function is passed to the search pattern argument of another catalog function.

For example, if the application gets `MY_TABLE` table from the result set of `SQLTables` and passes it to `SQLColumns` to retrieve the column list of `MY_TABLE`, then, the application will get the columns of all tables such as `MY_TABLE`, `MY1TABLE`, `MY2TABLE` instead of getting the columns

of MY_TABLE because they match the search pattern MY_TABLE.



ODBC 2.x driver does not support the search pattern for CatalogName argument of SQL tables. ODBC 3.x driver supports the search pattern within the argument if the environment attribute SQL_ATTR_ODBC_VERSION is set to SQL_OV_ODBC3. The argument does not accept the search pattern if this property is set to SQL_OV_ODBC2.

Passing a NULL pointer to the search pattern argument does not force the argument to search. NULL pointer and the search patterns % (any character) are equivalent. However, a zero-length search pattern is matched with an empty string ("").

25.5 ODBC API References

SQLAllocConnect

Conformance

Introduced version: ODBC 1.0

Overview

SQLAllocConnect function is replaced by SQLAllocHandle function in ODBC 3.x.
For more information, refer to [SQLAllocHandle](#).

Syntax

```
SQLRETURN SQLAllocConnect(  
    SQLHENV EnvironmentHandle,  
    SQLHDBC * ConnectionHandlePtr);
```

Arguments

EnvironmentHandle

[Input] It is the environment handle.

ConnectionHandlePtr

[Output] It is the pointer of the connection handle to be newly allocated.

SQLAllocEnv

Conformance

Introduced version: ODBC 1.0

Overview

SQLAllocEnv function is replaced by SQLAllocHandle function in ODBC 3.x.
For more information, refer to [SQLAllocHandle](#).

Syntax

```
SQLRETURN SQLAllocEnv(  
    SQLHENV * EnvironmentHandlePtr);
```

Arguments

EnvironmentHandlePtr

[Output] It is the pointer of the environment handle to be newly allocated.

SQLAllocHandle

Conformance

Introduced version: ODBC 3.0

Standards compliance: ISO 92

Overview

SQLAllocHandle allocates the environment handle, the connection handle, or the statement handle.

Syntax

```
SQLRETURN SQLAllocHandle(  
    SQLSMALLINT   HandleType,  
    SQLHANDLE     InputHandle,  
    SQLHANDLE *   OutputHandlePtr);
```

Arguments

HandleType

[Input] It is the handle type allocated by SQLAllocHandle and it should be one of SQL_HANDLE_DBC, SQL_HANDLE_ENV, SQL_HANDLE_STMT.

InputHandle

[Input] If HandleType is SQL_HANDLE_ENV, it is SQL_NULL_HANDLE.

If HandleType is SQL_HANDLE_DBC, it should be an environment handle.

If it is SQL_HANDLE_STMT, it should be a connection handle.

OutputHandlePtr

[Output] It is the newly allocated handle pointer.

Returns

SQL_SUCCESS, SQL_SUCCESS_WITH_INFO, SQL_INVALID_HANDLE, SQL_ERROR

Diagnosis

SQLSTATE	Error	Description
08003	Connection not open	It is not connected and HandleType is one of SQL_HANDLE_STMT and SQL_HANDLE_DESC.
HY000	General error	It is an error which does not have any specific SQLSTATE.
HY001	Memory allocation error	It is a memory allocation error.
HY009	Invalid use of null pointer	OutputHandlePtr argument is a null pointer.
HY010	Function sequence error	HandleType argument is SQL_HANDLE_DBC, and SQLSetEnvAttr is not called for setting SQL_ODBC_VERSION environment attribute.
HY014	Limit on the number of handles exceeded	It limits the number of allocated handles.
HY092	Invalid attribute/option identifier	HandleType argument is not one of SQL_HANDLE_ENV, SQL_HANDLE_DBC, SQL_HANDLE_STMT, SQL_HANDLE_DESC.
IM001	Driver does not support this function	HandleType argument is SQL_HANDLE_DESC.

Description

SQLAllocHandle is used to allocate the handle for environment, connection, statement, descriptor. When using SQLAllocHandle with *OutputHandlePtr, the driver will overwrite the information on the corresponding handle. The driver manager can not verify whether the handle in *OutputHandlePtr is already used, and it can not know the previously overwritten information.

Allocating Environment Handle

The environment handle provides the global information such as whether the connection handle is valid or active.

For requesting the environment handle, the application calls SQLAllocHandle whose HandleType is SQL_HANDLE_ENV and whose InputHandle is SQL_NULL_HANDLE. The driver allocates memory for the environment information, and passes an allocated handle to *OutputHandle argument. The application passes the value of *OutputHandle to the call requiring the environment handle argument.

After allocating the environment handle, the application should set the attribute of SQL_ATTR_ODBC_VERSION by calling SQLSetEnvAttr. If the attribute is not set when calling SQLAllocHandle for allocating the connection handle, SQLSTATE HY010 (Function sequence error) is returned.

Allocating Connection Handle

The connection handle provides the information such as whether the statement is valid, the descriptor handle is connected, or the transaction currently is opened.

For requesting the connection handle, the application calls `SQLAllocHandle` whose `HandleType` is `SQL_HANDLE_DBC`. `InputHandler` argument is set to the environment handle returned by calling `SQLAllocHandle`. The driver allocates memory for the connection information, and passes an allocated handle to `*OutputHandle` argument. The application passes the value of `*OutputHandle` to the call requiring a connection handle argument.

If the environment attribute of `SQL_ATTR_ODBC_VERSION` is not set before the calling `SQLAllocHandle` which allocates a connection handle, `SQLSTATE HY010`(Function sequence error) is returned.

Allocating Statement Handle

The statement handle provides the information such as the error message, the cursor name and the SQL statement processing status.

For requesting the statement handle, the application connects to the data source and then calls `SQLAllocHandle` before sending the SQL statement. In this call, `HandleType` should be set to `SQL_HANDLE_STMT` and `InputHandler` should be set to the connection handle returned by calling `SQLAllocHandle`. The driver allocates memory for the statement information, and passes the allocated handle to `*OutputHandle` argument. The application passes the value of `*OutputHandle` to the call requiring a statement handle argument.

If the statement handle is allocated, the driver automatically allocates four descriptor sets, and these descriptor handles are allocated to the statement attribute of `SQL_ATTR_APP_ROW_DESC`, `SQL_ATTR_APP_PARAM_DESC`, `SQL_ATTR_IMP_ROW_DESC` and `SQL_ATTR_IMP_PARAM_DESC`. This is called as implicit descriptor allocation.

SQLAllocStmt

Conformance

Introduced version: ODBC 1.0

Overview

SQLAllocStmt function is replaced by SQLAllocHandle function in ODBC 3.x.
For more information, refer to [SQLAllocHandle](#).

Syntax

```
SQLRETURN SQLAllocStmt(  
    SQLHDBC    ConnectionHandle,  
    SQLHSTMT * StatementHandlePtr);
```

Arguments

ConnectionHandle

[Input] It is the connection handle.

StatementHandlePtr

[Output] It is the pointer of the statement handle to be newly allocated.

SQLBindCol

Conformance

Introduced version: ODBC 1.0

Standards compliance: ISO 92

Overview

SQLBindCol binds the application data buffer to the columns in the result set.

Syntax

```
SQLRETURN SQLBindCol(
    SQLHSTMT      StatementHandle,
    SQLUSMALLINT  ColumnNumber,
    SQLSMALLINT   TargetType,
    SQLPOINTER    TargetValuePtr,
    SQLLEN        BufferLength,
    SQLLEN *      StrLen_or_Ind);
```

Arguments

StatementHandle

[Input] It is the statement handle.

ColumnNumber

[Input] It is the column number in the result set to be bound. The number is in ascending order starting from 1.

TargetType

[Input] It is the identifier of C data type of *TargetValuePtr buffer. When retrieving data using SQL Fetch, SQLFetchScroll, SQLSetPos, the driver converts the data into this type.

If TargetType is the interval data type, the default value is the interval leading precision (2), interval seconds precision (6), and it is set in each field of SQL_DESC_DATETIME_INTERVAL_PRECISION and SQL_DESC_PRECISION of ARD. If TargetType argument is SQL_C_NUMERIC, the default value is precision (38), scale (0), and it is set in each field of SQL_DESC_PRECISION and SQL_DESC_SCALE of ARD. If the default precision and scale are not appropriate, the application must explicitly set the descriptor field by calling SQLSetDescField or SQLSetDescRec.

TargetValuePtr

[Delayed Input/Output] It is the data buffer pointer to bind to the column. SQLFetch and SQLFetchScroll return data to this buffer.

If TargetValuePtr is the null pointer, the driver releases the data buffer binding for the column. The application may release the binding of all the columns by calling SQLFreeStmt as SQL_BIND option. The application can release the data buffer binding for the column by setting TargetValuePtr argument as a null pointer and calling SQLBindCol. But if StrLen_or_IndPtr is valid, the length/indicator buffer for the column is still bound.

BufferLength

[Input] It is the length of *TargetValuePtr buffer in bytes.

The driver uses BufferLength in order to avoid writing beyond the end of *TargetValuePtr buffer when returning the variable-length data such as text or binary data. It should be noted that the driver take into account the null terminator when returning the character data in *TargetValuePtr. So, *TargetValuePtr should include the space for a null terminator, otherwise the driver may drop the data. The driver assumes that the buffer is large enough to store data and it ignores BufferLength when returning a fixed-length data structure such as an integer or date. It is important that the application allocates the large buffer for the fixed-length data, otherwise the driver can write beyond the end of the buffer.

StrLen_or_IndPtr

[Delayed Input/Output] It is the pointer to the length/indicator buffer to be bound to the column. SQLFetch and SQLFetchScroll return the value to this buffer.

SQLFetch and SQLFetchScroll return the length of data for the length/indicator buffer, SQL_NO_TOTAL and SQL_NULL_DATA. If there are two separate buffers for the length and indicator, the length buffer may return all values, and the indicator buffer may only return only SQL_NULL_DATA. If StrLen_or_IndPtr is the null pointer, the value of length/indicator is not used and an error occurs when getting the null data.

Returns

SQL_SUCCESS, SQL_SUCCESS_WITH_INFO, SQL_INVALID_HANDLE, SQL_ERROR

Diagnosis

SQLSTATE	Error	Description
07006	Restricted data type attribute violation	ColumnNumber argument is 0, and TargetType argument is neither SQL_C_BOOKMARK nor is SQL_C_VARBOOKMARK.
HY000	General error	It is an error without any specific SQLSTATE.
HY001	Memory allocation error	It is a memory allocation error.
HY003	Invalid application buffer type	The value of TargetType argument is the invalid data type.

SQLSTATE	Error	Description
HY010	Function sequence error	After calling SQLExecute and SQLExecDirect, then SQL_NEED_DATA is returned, and the function is called before sending all data-at-execution variables.
HY090	Invalid string or buffer length	The value of BufferLength argument is smaller than 0.
HYC00	Optional feature not implemented	The driver does not support the SQL data type of the column and the value of TargetType argument and the conversion. The value of ColumnNumber argument is 0, and the driver does not support bookmarks.

Description

SQLBindCol is used to bind columns in the result set to the data buffer and the length/indicator buffers in the application. The application calls SQLFetch and SQLFetchScroll to retrieve the data, and the driver returns the bound column data to the specified buffer.

The application does not bind the column, and the data is retrieved by calling SQLGetData.

Binding Column

The application calls SQLBindCol to bind the column, and passes the column number, the type, the address, the data buffer length and the address of length/indicator buffer.

Though the application binds the buffer by calling SQLBindCol, but the driver accesses them when calling SQLFetch and SQLFetchScroll, so these buffers are delayed when it is used. Therefore, the application should make the pointer set in SQLBindCol to be valid until the data is returned. If the application calls after making the pointer invalid, like when releasing the buffer, the result is not correct.

The binding remains until when it is replaced by a new binding, the column binding is released, or the statement is released.

Releasing Bound Column

To release only one bound column, set the column number to be released as ColumnNumber and call SQLBindCol by setting TargetValue to the null pointer in the application. If ColumnNumber is the column number whose binding is released, SQLBindCol continues returning SQL_SUCCESS.

To release all bound columns, call SQLFreeStmt by setting option to SQL_UNBIND in the application. Or, set SQL_DESC_COUNT field of ARD to 0 to release all bound columns.

Rebinding Column

The application can perform one of two operations to change the binding.

- A new binding is specified for an existing bound column by calling `SQLBindCol`.
- The offset is added to the specified buffer address by calling `SQLBindCol`. For more information, refer to **Binding Offsets**.

Binding Offsets

Binding offset is the value added to the address before the data and length/indicator buffers (specified in `TargetValuePtr` and `StrLen_or_IndPtr`) are dereferenced.

Using binding offset generally has the same effect as rebinding the column by calling `SQLBindCol`. However, the new address of the data and length/indicator buffer are specified when newly calling `SQLBindCol`, but binding offset does not change the address, instead it adds only the offsets to the address. The application can specify a new offset anytime, and the offset is always added to the originally bound address. Especially, if the offset is set to 0 or the statement attribute is set to NULL pointer, the driver uses the originally bound address.

The sum of the originally bound address and the offset should be a valid address, but the offset address to be added does not have to be valid.

Binding Array

If the row set size (the value of `SQL_ATTR_ROW_ARRAY_SIZE` statement attribute) is bigger than 1, the application binds a buffer array instead of a single buffer.

The application can bind an array in two ways as follows.

- Bind an array to each column. Each data structure (array) contains data for a single column, so it is called as **Column-wise Binding**.
- Define a structure containing the entire row data and bind the array of these structures. Each data structure contains data for a single row, so it is called as **Row-wise Binding**.

Each buffer array should have at least as many elements as the row set size.

Column-wise Binding

The application binds the separate data and length/indicator array to each column in column-wise binding.

The application should set `SQL_ATTR_ROW_BIND_TYPE` statement attribute to `SQL_BIND_BY_COLUMN` (default value) to use the column-wise binding. Then, the application performs the following processes for the columns to be bound.

1. It allocates the data buffer array.
2. It allocates the array of length/indicator buffer.



If the application directly records to the descriptors when using the column-wise binding, the separate arrays can be used for length and indicator data.

3. It calls `SQLBindCol` together with the following arguments.
 - `TargetType` is the type of each element of the data buffer array.
 - `TargetValuePtr` is the address of the data buffer array.
 - `BufferLength` is the size of each element of the data buffer array. `BufferLength` is ignored when the data is fixed length data.
 - `StrLen_or_IndPtr` is the address of the length/indicator array.

Row-wise Binding

The application defines a structure which contains the data and length/indicator buffer of each column to be bound in row-wise binding.

The application performs the following processes to use row-wise binding.

1. It defines a structure which contains a row (including both of data and the length/indicator buffer) and allocates an array of the structures.



If the application directly records to the descriptors when using the row-wise binding, the separate fields can be used for length and indicator data.

2. `SQL_ATTR_ROW_BIND_TYPE` statement attribute sets the size of structure including a data row or as the buffer instance size for the result columns to be bound. The length should include the space and structure of all bound columns and the padding of the buffer. It should guarantee to point to the starting position in the same column of the next line when the address of the bound column is increased by the specified length. ANSI C guarantees it by using the `sizeof` operator.
3. It calls `SQLBindCol` together with the following arguments for each column to be bound.
 - `TargetType` is the type of the data buffer member to be bound to the column.
 - `TargetValuePtr` is the address of the data buffer member in the first array element.
 - `BufferLength` is the size of the data buffer member.
 - `StrLen_or_IndPtr` the address of the length/indicator member to be bound.

Buffer Address

The buffer address is an actual address of the data or the length/indicator buffer. The driver calculates the buffer address before writing to the buffer (such as the data collect). It is calculated by the following formula, which uses the address, binding offset, row number specified in TargetValuePtr and StrLen_or_IndicatorPtr.

$$\text{Bound Address} + \text{Binding Offset} + ((\text{Row Number} - 1) \times \text{Element Size})$$

The following table describes the definitions of the formula's variables.

Table 25-6 Formula's variable

Variable	Description
Bound address	The address of data buffer is specified in TargetValuePtr argument of SQLBindCol. The address of length/indicator buffer is specified in StrLen_or_IndicatorPtr argument of SQLBindCol. If the binding address is 0, the data value is not returned, even though the calculated address is not 0.
Binding offset	If row-wise binding is used, this value is stored in the address specified with the SQL_ATTR_ROW_BIND_OFFSET_PTR statement attribute. If column-wise binding is used or the SQL_ATTR_ROW_BIND_OFFSET_PTR statement attribute is a NULL pointer, then the binding offset is 0.
Row number	It is 1-based number of the row in the row set. When fetching a single row, generally the row number is 1.
Element size	It is the element size of binding array. If column-wise binding is used, it is sizeof (SQLLEN) for the length/indicator buffer. The element size of the data buffer of variable length data type is the value of BufferLength argument of SQLBindCol, and the element size of the data buffer of fixed length data type is the size of the data type. If row-wise binding is used, the element size of both the data and the length/indicator buffer are the value of the SQL_ATTR_ROW_BIND_TYPE statement.

Descriptors and SQLBindCol

This chapter describes how SQLBindCol interacts with descriptors.



Calling SQLBindCol for a single statement may affect other statements. It occurs when a resource related to the statement is explicitly allocated and it is related to other statements. The modifications for the descriptor affects all statements related to the descriptor because SQLBindCol modifies the descriptor. If it is not the required behavior, the application should release the relationship between the descriptor and other statements before calling SQLBindCol.

Argument Mapping

Notionally, SQLBindCol performs the following processes in order.

1. It calls SQLGetStmtAttr to obtain ARD handle.
2. It calls SQLGetDescField to obtain the descriptor of SQL_DESC_COUNT field, and if the value in the ColumnNumber argument exceeds the value of SQL_DESC_COUNT, it calls SQLSetDescField to increase the value of SQL_DESC_COUNT to ColumnNumber.
3. It calls SQLSetDescField multiple times to assign values to the following fields of ARD.
 - It sets SQL_DESC_TYPE and SQL_DESC_CONCISE_TYPE to the value of TargetType.
 - Except when TargetType is one of the concise identifiers of a datetime or interval subtype, it respectively sets SQL_DESC_TYPE to SQL_DATETIME or SQL_INTERVAL. It sets SQL_DESC_CONCISE_TYPE to the concise identifier; and sets SQL_DESC_DATETIME_INTERVAL_CODE to the corresponding datetime or interval subcode.
 - It appropriately sets one or more of SQL_DESC_LENGTH, SQL_DESC_PRECISION, SQL_DESC_SCALE, and SQL_DESC_DATETIME_INTERVAL_PRECISION, for TargetType.
 - It sets the SQL_DESC_OCTET_LENGTH field to the value of BufferLength.
 - It sets the SQL_DESC_DATA_PTR field to the value of TargetValue.
 - It sets the SQL_DESC_INDICATOR_PTR field to the value of StrLen_or_Ind.
 - It sets the SQL_DESC_OCTET_LENGTH_PTR field to the value of StrLen_or_Ind.

The variable referenced by StrLen_or_Ind argument is used for both indicator and length information. If the value of column when fetching is null, it stores SQL_NULL_DATA in this variable. Otherwise, it stores the data length in this variable.

Entering a null pointer, and the value of column when fetching is null, then the fetch fails because it cannot return SQL_NULL_DATA.

If SQLBindCol fails, the contents of the descriptor fields which will be set in ARD are not defined, and the value of SQL_DESC_COUNT field of ARD is not updated.

Implicit Initialization of COUNT Field

SQLBindCol sets SQL_DESC_COUNT to the value of the ColumnNumber only when ColumnNumber increase the value of SQL_DESC_COUNT. If the value in the TargetValuePtr argument is a null pointer and the value in the ColumnNumber argument is equal to SQL_DESC_COUNT (when releasing the highest bound column), then SQL_DESC_COUNT is set to the number of the highest remaining bound column.

Caution for SQL_DEFAULT

The application should determine the correct length and starting point of the data in the application buffer to successfully retrieve column data. When the application explicitly specifies an TargetType, application errors are easily detected.

However, when the application specifies a `TargetType` of `SQL_DEFAULT`, `SQLBindCol` can be applied to a column of a different data type from the one data type intended by the application, either from changes to the metadata or by applying the code to a different column. In this case, the application may not always determine the start or length of the fetched column data. This may lead to unreported data errors or memory violations.

SQLBindParameter

Conformance

Introduced version: ODBC 2.0

Standards compliance: ODBC

Overview

SQLBindParameter binds the buffer to the parameter marker of SQL statement.

Syntax

```
SQLRETURN SQLBindParameter(
    SQLHSTMT      StatementHandle,
    SQLUSMALLINT  ParameterNumber,
    SQLSMALLINT   InputOutputType,
    SQLSMALLINT   ValueType,
    SQLSMALLINT   ParameterType,
    SQLULEN       ColumnSize,
    SQLSMALLINT   DecimalDigits,
    SQLPOINTER    ParameterValuePtr,
    SQLLEN        BufferLength,
    SQLLEN *      StrLen_or_IndPtr);
```

Arguments

StatementHandle

[Input] It is the statement handle.

ParameterNumber

[Input] It is the parameter number which is increased sequentially from 1.

InputOutputType

[Input] It is the parameter type.

ValueType

[Input] It is the C data type of the parameter.

ParameterType

[Input] It is the SQL data type of the parameter.

ColumnSize

[Input] It is the size of column or expression of the parameter marker.

DecimalDigits

[Input] It is the number of decimal point of column or expression of the parameter marker.

ParameterValuePtr

[Delayed Input] It is the data buffer pointer of the parameter.

BufferLength

[Input/Output] It is the byte length of ParameterValuePtr buffer.

StrLen_or_IndPtr

[Delayed Input] It is the pointer to the length/indicator of the parameter.

Returns

SQL_SUCCESS, SQL_SUCCESS_WITH_INFO, SQL_ERROR, SQL_INVALID_HANDLE

Diagnosis

Table 25-7 SQLSTATE values

SQLSTATE	Error	Description
07006	Restricted data type attribute violation	ValueType argument data type can not be converted into ParameterType argument data type.
07009	Invalid descriptor index	The value of ParameterNumber argument is smaller than 1.
HY000	General error	It is an error without any specific SQLSTATE.
HY001	Memory allocation error	It is a memory allocation error.
HY003	Invalid application buffer type	The value of ValueType argument is not a valid C data type.
HY004	Invalid SQL data type	The value of ParameterType argument is not a valid SQL data type.
HY009	Invalid argument value	ParameterValuePtr argument and StrLen_or_IndPtr argument are the NULL pointer, and InputOutputType argument is not SQL_PARAM_OUTPUT. InputOutputType argument is SQL_PARAM_OUTPUT, and ParameterValuePtr argument is the NULL pointer, and C type is a character or binary, and BufferLength is greater than 0.
HY010	Function sequence error	SQL_NEED_DATA is returned after calling SQLExecute, SQLExecDirect, and this function is called before sending all data-at-execution variables.
HY021	Inconsistent descriptor information	Descriptor information is inconsistent when the integrity is checked.

SQLSTATE	Error	Description
	Information	
HY090	Invalid string or buffer length	The value of BufferLength is smaller than 0.
HY104	Invalid precision or scale value	The value specified in ColumnSize and DecimalDigits is beyond the SQL data support range of ParameterType argument.
HY105	Invalid parameter type	The value of InputOutputType argument is not valid.
HYC00	Optional feature not implemented	The driver does not support the conversion of values of ValueType argument and ParameterType argument. The value of ParameterType argument is valid but the driver does not support.

Description

The application calls `SQLBindParameter` to bind each parameter marker in an SQL statement. Bindings remain valid until the application calls `SQLBindParameter` again, calls `SQLFreeStmt` with the `SQL_RESET_PARAMS` option, or calls `SQLSetDescField` to set the `SQL_DESC_COUNT` header field of the APD to 0.

ParameterNumber Argument

If `ParameterNumber` is bigger than the value of `SQL_DESC_COUNT` when calling `SQLBindParameter`, `SQLSetDescField` is called to increase the value of `SQL_DESC_COUNT` to `ParameterNumber`.

InputOutputType Argument

The `InputOutputType` argument specifies the type of the parameter. This argument sets the `SQL_DESC_PARAMETER_TYPE` field of the IPD.

`InputOutputType` argument is one of the followings.

- `SQL_PARAM_INPUT`: The parameter marks a parameter in an SQL statement, not in a procedure nor in a `SELECT INTO` statement. For example, the parameters in `INSERT INTO Employee VALUES (?, ?, ?)` are input parameters.
 - When the statement is executed, the driver sends data for the parameter, and the `*ParameterValuePtr` buffer should contain a valid input value, or the `*StrLen_or_IndPtr` buffer should contain `SQL_NULL_DATA`, `SQL_DATA_AT_EXEC`, or the result of the `SQL_LEN_DATA_AT_EXEC` macro.
- `SQL_PARAM_INPUT_OUTPUT`: The parameter marks an input/output parameter in a procedure.
 - When the statement is executed, the driver sends data for the parameter and the `*ParameterValuePtr` buffer should contain a valid input value, or the `*StrLen_or_IndPtr` buffer should contain `SQL_NULL_DATA`, `SQL_DATA_AT_EXEC`, or the result of the `SQL_LEN_DATA_AT_EXEC` macro.
 - After the statement is executed, the driver returns data to the parameter of the application. If the data source does not return a value to an input/output parameter, the driver sets `SQL_NULL_DATA` in `*StrLen_or_IndPtr` buffer.

- **SQL_PARAM_OUTPUT:** The parameter marks the return value of a procedure, or an output parameter in a procedure or SELECT INTO statement. For example, the parameter in SELECT ID INTO ? FROM Employee WHERE NAME = 'Paul' is an output parameter which returns the ID.
 - After the statement is executed, the driver returns data to the parameter, if the ParameterValuePtr and StrLen_or_IndPtr arguments of an application are not null pointers. Otherwise, the driver discards the output value.
 - If the data source can not return a value to an output parameter, the driver sets SQL_NULL_DATA in *StrLen_or_IndPtr buffer.

ValueType Argument

ValueType argument specifies C data type of the parameter. It sets the values of SQL_DESC_TYPE, SQL_DESC_CONCISE_TYPE, SQL_DESC_DATETIME_INTERVAL_CODE fields of APD.

When the ValueType argument is an interval data type,

- SQL_DESC_TYPE field of APD ParameterNumber record is set to SQL_INTERVAL.
- SQL_DESC_CONCISE_TYPE field is set to concise interval data type.
- SQL_DESC_DATETIME_INTERVAL_CODE field is set to subcode of a specific interval data.
- The default value of interval leading precision is (2), and the default value of interval seconds precision is (6), and they are respectively set in SQL_DESC_DATETIME_INTERVAL_PRECISION and SQL_DESC_PRECISION fields of APD.
- If the default precision or scale is not appropriate, the application should explicitly set the descriptor field by calling SQLSetDescField or SQLSetDescRec.

When the ValueType argument is a datetime data type,

- SQL_DESC_TYPE field of ParameterNumber record in APD is set to SQL_DATETIME.
- SQL_DESC_CONCISE_TYPE field is set to the concise date C data type.
- SQL_DESC_DATETIME_INTERVAL_CODE field is set to the sub code of the specific datetime data.

When the ValueType argument is an SQL_C_NUMERIC data type,

- The default precision is (38), the default scale is (0), and they are respectively set in SQL_DESC_PRECISION, SQL_DESC_SCALE fields of APD.
- If the default precision or scale is not appropriate, the application should explicitly set the descriptor field by calling SQLSetDescField or SQLSetDescRec.

ParameterType Argument

ParameterType specifies the SQL data type of the parameter. It sets the values of SQL_DESC_TYPE, SQL_DESC_CONCISE_TYPE, SQL_DESC_DATETIME_INTERVAL_CODE fields of IPD.

When the ParameterType argument is a datetime data type,

- SQL_DESC_TYPE field of IPD is set to SQL_DATETIME.
- SQL_DESC_CONCISE_TYPE field is set to the concise datetime SQL data type.
- SQL_DESC_DATETIME_INTERVAL_CODE field is set to the sub code of the specific datetime data.

When the ParameterType argument is a interval data type,

- SQL_DESC_TYPE field of IPD is set to SQL_INTERVAL.
- SQL_DESC_CONCISE_TYPE field is set to the concise SQL interval data type.
- SQL_DESC_DATETIME_INTERVAL_CODE field is set to the sub code of the specific interval data.
- The interval leading precision is set in SQL_DESC_DATETIME_INTERVAL_PRECISION field of IPD, and the interval second precision is set in SQL_DESC_PRECISION field of IPD.
- If the defaults of SQL_DESC_DATETIME_INTERVAL_PRECISION and SQL_DESC_PRECISION are not appropriate, the application sets it by calling SQLSetDescField.

When the ParameterType argument is an SQL_NUMERIC data type,

- The default precision is (38), the default scale is (0), and they are respectively set in SQL_DESC_PRECISION and SQL_DESC_SCALE fields of IPD.
- If the default precision or scale is not appropriate, the application should explicitly set the descriptors field by calling SQLSetDescField or SQLSetDescRec.

ColumnSize Argument

ColumnSize argument specifies the size of the column or expression corresponding the parameter marker. It sets different fields of the IPD depending on SQL data type of ParameterType.

- If ParameterType is SQL_CHAR, SQL_VARCHAR, SQL_LONGVARCHAR, SQL_BINARY, SQL_VARBINARY, SQL_LONGVARBINARY, concise SQL datetime, or interval data type, it sets the value of ColumnSize in SQL_DESC_LENGTH field of IPD.
- If ParameterType is SQL_DECIMAL, SQL_NUMERIC, SQL_FLOAT, SQL_REAL, or SQL_DOUBLE, it sets the value of ColumnSize in SQL_DESC_PRECISION field of IPD.
- For other data types, ColumnSize argument is ignored.

DecimalDigit Argument

- If ParameterType argument is SQL_TYPE_TIME, SQL_TYPE_TIMESTAMP, SQL_INTERVAL_SECOND, SQL_INTERVAL_DAY_TO_SECOND, SQL_INTERVAL_HOUR_TO_SECOND, or SQL_INTERVAL_MINUTE_TO_SECOND, it sets the value of DecimalDigits in SQL_DESC_PRECISION field of IPD.
- If ParameterType argument is SQL_NUMERIC or SQL_DECIMAL, it sets the value of DecimalDigits in SQL_DESC_SCALE field of IPD.
- For other data types, DecimalDigits argument is ignored.

ParameterValuePtr Argument

When calling `SQLExecute` and `SQLExecDirect`, `ParameterValuePtr` points to the actual data for the parameter. The data type should be in a form specified by `ValueType` argument. This argument sets the `SQL_DESC_DATA_PTR` field of the APD.

If `*StrLen_or_IndPtr` is the result of the `SQL_LEN_DATA_AT_EXEC` (length) macro or `SQL_DATA_AT_EXEC`, then `ParameterValuePtr` is an application-defined pointer value which is related to the parameter. It is returned to the application through `SQLParamData`.

For example, `ParameterValuePtr` might be a non-zero token such as a parameter number, a pointer to data, or a pointer to a structure that the application used to bind input parameters.

If `InputOutputType` argument is `SQL_PARAM_INPUT_OUTPUT` or `SQL_PARAM_OUTPUT`, `ParameterValuePtr` should be a buffer pointer in which the output value is stored.

If the value in the `SQL_ATTR_PARAMSET_SIZE` statement attribute is bigger than 1, `ParameterValuePtr` points to an array. A single SQL statement processes the complete array of input values for an input or input/output parameter and returns an array of output values for an input/output or output parameter.

BufferLength Argument

For character and binary C data, the `BufferLength` argument specifies the length of the `*ParameterValuePtr` buffer (if the value in the `SQL_ATTR_PARAMSET_SIZE` statement attribute is 1), or specifies the length of the element in the `*ParameterValuePtr` array (if the value in the `SQL_ATTR_PARAMSET_SIZE` statement attribute is bigger than 1).

Both when input and output, `BufferLength` is used to determine the position in the array of `*ParameterValuePtr` for. It sets `SQL_DESC_OCTET_LENGTH` field of APD.

For an input/output parameter and an out parameter, `BufferLength` is used to determine whether or not to truncate the output.

- For character C data, if the number of bytes available to return is equal to or bigger than `BufferLength`, the data in `*ParameterValuePtr` is truncated to `BufferLength` minus 1 bytes and it is null-terminated.
- For binary C data, if the number of bytes available to return is equal to or bigger than `BufferLength`, the data in `*ParameterValuePtr` is truncated to `BufferLength` bytes.
- For other C data types, the `BufferLength` argument is ignored.

StrLen_or_IndPtr Argument

The `StrLen_or_IndPtr` argument contains one of the followings when `SQLExecute` or `SQLExecDirect` is called. (This argument sets the `SQL_DESC_OCTET_LENGTH_PTR` and `SQL_DESC_INDICATOR_PTR` of APD.)

- The length of the parameter value stored in *ParameterValuePtr. This is ignored except for character or binary C data.
- SQL_NTS: The parameter value is a null-terminated string.
- SQL_NULL_DATA: The parameter value is NULL.
- The result of the SQL_LEN_DATA_AT_EXEC(length) macro: The data for the parameter will be sent when performing SQLPutData.
 - If the ParameterType argument is SQL_LONGVARBINARY, SQL_LONGVARCHAR, or a long, and SQL_NEED_LONG_DATA_LEN information of SQLGetInfo returns "Y", then the length is the number of bytes of data to be sent for the parameter
 - If SQL_NEED_LONG_DATA_LEN information of SQLGetInfo is "N", length should be a nonnegative value and is ignored.
 - For example, to specify 10,000 bytes of SQL_LONGVARCHAR parameter data to be sent by calling SQLPutData for multiple times, *StrLen_or_IndPtr should be set to SQL_LEN_DATA_AT_EXEC(10000).
- SQL_DATA_AT_EXEC: The data for the parameter will be sent when performing SQLPutData.

If StrLen_or_IndPtr is a null pointer, the driver assumes that all input parameter values are non-NULL and that character and binary data is null-terminated. If InputOutputType is SQL_PARAM_OUTPUT, and ParameterValuePtr and StrLen_or_IndPtr are both null pointers, the driver discards the output value.

If the InputOutputType argument is SQL_PARAM_INPUT_OUTPUT, SQL_PARAM_OUTPUT, then StrLen_or_IndPtr points to SQL_NULL_DATA, the number of bytes available to return in *ParameterValuePtr (excluding the null-termination byte of character data), or SQL_NO_TOTAL (if the number of bytes available to return cannot be determined).

If the value in the SQL_ATTR_PARAMSET_SIZE statement attribute is greater than 1, StrLen_or_IndPtr points to an array of SQLLEN values.

Passing Parameter Values

An application can pass the value for a parameter by calling the *ParameterValuePtr buffer or multiple SQLPutData. Parameters whose data is passed through SQLPutData are known as data-at-execution parameters. These are typically used to send data for SQL_LONGVARBINARY and SQL_LONGVARCHAR parameters, and can be mixed with other parameters.

The application should perform the following process to pass the parameter values.

1. It calls SQLBindParameter for each parameter to bind buffers for the parameter's value (ParameterValuePtr argument) and length/indicator (StrLen_or_IndPtr argument). For data-at-execution parameters, ParameterValuePtr is an application-defined pointer value such as a parameter number or a pointer to data. The value will be returned later and can be used to identify the parameter.
2. It sets values for an input parameter or an input/output parameter in the *ParameterValuePtr and *StrLen_or_IndPtr buffers.

- For normal parameters, the application inputs the parameter value in the *ParameterValuePtr buffer and the length of that value in the *StrLen_or_IndPtr buffer.
 - For data-at-execution parameters, the application inputs the result of the SQL_LEN_DATA_AT_EXEC (length) macro (when calling an ODBC 2.0 driver) in the *StrLen_or_IndPtr buffer.
3. It calls SQLExecute or SQLExecDirect to execute the SQL statement.
 - If data-at-execution parameters do not exist, the process is complete.
 - If any data-at-execution parameters exist, the function returns SQL_NEED_DATA.
 4. It calls SQLParamData to retrieve the application-defined value specified in the ParameterValuePtr argument of SQLBindParameter for the first data-at-execution parameter to be processed. SQLParamData returns SQL_NEED_DATA.



Although data-at-execution parameters resemble data-at-execution columns, the value returned by SQLParamData is different for each.

Data-at-execution parameters are parameters in an SQL statement for which data will be sent to SQLPutData when the statement is executed together with SQLExecDirect or SQLExecute. They are bound with SQLBindParameter.

The value returned by SQLParamData is a pointer value passed to the ParameterValuePtr argument of SQLBindParameter. Data-at-execution columns are columns in a rowset for which data will be sent when a row is updated or added with SQLBulkOperations or updated with SQLSetPos. They are bound with SQLBindCol. The value returned by SQLParamData is the address of the row in the TargetValuePtr* buffer (set by a call to **SQLBindCol) which is to be processed.

5. It calls SQLPutData for one or more times to send data for the parameter. One or more calls are required if the data value is bigger than what is specified in the *ParameterValuePtr buffer of SQLPutData. Multiple SQLPutData calls for the same parameter are allowed only when sending character C data to a column with a character, binary, or data source-specific data type or when sending binary C data to a column with a character, binary, or data source-specific data type.
6. It calls SQLParamData again to signal that all data has been sent for the parameter.
 - If one or more data-at-execution parameters exist, SQLParamData returns SQL_NEED_DATA and processes the application-defined value for the next data-at-execution parameter. The application repeats steps 4 and 5.
 - If data-at-execution parameter does not exist, the process is complete. If the statement was successfully executed, SQLParamData returns SQL_SUCCESS or SQL_SUCCESS_WITH_INFO. If the execution failed, it returns SQL_ERROR. At this point, SQLParamData can be returned by any SQLSTATE. It can also be returned by SQLExecDirect or SQLExecute which is used to execute the statement.
 - Output values for any input/output or output parameters are available in the *ParameterValuePtr and

d *StrLen_or_IndPtr buffers after the application retrieves all result sets generated by the statement.

Calling SQLExecute or SQLExecDirect puts the statement in an SQL_NEED_DATA state. At this point, the application can call only SQLCancel, SQLGetDiagField, SQLGetDiagRec, SQLGetFunctions, SQLParamData, or SQLPutData together with the statement or the connection handle related to the statement.

If it calls any other function for the statement or the connection related to the statement, the function returns SQLSTATE HY010(Function sequence error). The statement is released from the SQL_NEED_DATA state when SQLParamData or SQLPutData returns an error, SQLParamData returns SQL_SUCCESS or SQL_SUCCESS_WITH_INFO, or the statement is canceled.

If the application calls SQLCancel while the driver still needs data for data-at-execution parameters, the driver cancels statement execution. Then the application can call SQLExecute or SQLExecDirect again.

Using Parameter Array

An application prepares a statement together with parameter markers and passes it in an array of parameters in the following two ways.

- One method is for the driver to rely on the array-processing capabilities, in this case the entire statement with the array of parameters is treated as one atomic unit. Oracle is an example of a data source which supports array processing capabilities.
- The other method is for the driver to generate a batch of SQL statements. Each set of parameters in the parameter array is allocated per an SQL statement and is made into a batch, then the batch is executed. Arrays of parameters can not be used in an UPDATE WHERE CURRENT OF statement.

When processing the parameter array, the number of each result sets/ rows are available per each parameter set or the number of each result sets/ rows are available in whole. The SQL_PARAM_ARRAY_ROW_COUNTS option in SQLGetInfo indicates whether the number of rows are available for each set of parameters(SQL_PARC_BATCH) or only a single row is available (SQL_PARC_NO_BATCH).

The SQL_PARAM_ARRAY_SELECTS option in SQLGetInfo indicates whether a result set is available for each set of parameters (SQL_PAS_BATCH) or is available only in one result set(SQL_PAS_NO_BATCH). If the driver does not allow a result set-generating statement to be executed together with an array of parameters, SQL_PARAM_ARRAY_SELECTS returns SQL_PAS_NO_SELECT.

For more information, refer to **SQLGetInfo**.

To support the parameter array, the SQL_ATTR_PARAMSET_SIZE statement attribute is set to specify the number of values for each parameter. If the field is bigger than 1, the SQL_DESC_DATA_PTR, SQL_DESC_INDICATOR_PTR, and SQL_DESC_OCTET_LENGTH_PTR fields of the APD should point to arrays. The number of elements in each array is equal to the value of SQL_ATTR_PARAMSET_SIZE.

The `SQL_DESC_ROWS_PROCESSED_PTR` field of the APD points to a buffer which contains the number of sets of parameters which have been processed, including error sets. Like as each processed parameters set, the driver stores a new value in the buffer. Any number will not be returned if this is a null pointer. When arrays of parameters are used, the value pointed to by the `SQL_DESC_ROWS_PROCESSED_PTR` field of the APD is generated even when `SQL_ERROR` is returned by the setting function. If `SQL_NEED_DATA` is returned, the value pointed to by the `SQL_DESC_ROWS_PROCESSED_PTR` field of the APD is set to the set of parameters which is being processed.

Binding Column-wise Parameter

For column-wise binding, the application binds the separate parameter and length/indicator arrays to each parameter.

For column-wise binding, the application firstly sets the `SQL_ATTR_PARAM_BIND_TYPE` statement attribute to `SQL_PARAM_BIND_BY_COLUMN`. (It is the default value.) The application performs the following processes to use column-wise binding.

1. It allocates the parameter buffer array.
2. It allocates the length/indicator buffer array.



If the application directly records to the descriptors when using the column-wise binding, the separate arrays can be used for length and indicator data.

3. It calls `SQLBindParameter` together with the following arguments.
 - `ValueType` is the C type of a single element in the parameter buffer array.
 - `ParameterType` is the SQL type of the parameter.
 - `ParameterValuePtr` is the address of the parameter buffer array.
 - `BufferLength` is the size of a single element in the parameter buffer array. The `BufferLength` argument is ignored when the data is fixed-length data.

Binding Row-wise Parameter

For row-wise binding, the application defines a structure which contains parameter and length/indicator buffers for each parameter to be bound.

The application performs the following processes to use row-wise binding.

1. It defines a structure to hold a single set of parameters (including both parameter and length/indicator buffers) and allocates an array of these structures.



If the application directly records to the descriptors when using the row-wise binding, the separate fields can be used for length and indicator data.

2. `SQL_ATTR_PARAM_BIND_TYPE` statement attribute sets the size of the structure which contains a single set of parameters or to the size of an instance of a buffer into which the parameters will be bound. The length should include space for all bound parameters. The length should include space for binding parameter and the structure buffer, or should be buffered to ensure the result to point to the beginning of the next parameter when the address of a bound parameter is incremented to the specified length. ANSI C guarantees it by using the `sizeof` operator.
3. It calls `SQLBindParameter` together with the following arguments for each parameter to be bound.
 - `ValueType` is the type of the parameter buffer member to be bound to the column.
 - `ParameterType` is the SQL type of the parameter.
 - `ParameterValuePtr` is the address of the parameter buffer member in the first array element.
 - `BufferLength` is the size of the parameter buffer member.
 - `StrLen_or_IndPtr` is the address of the length/indicator member to be bound.

Error Information

If a driver does not perform parameter arrays as same as batches (the `SQL_PARAM_ARRAY_ROW_COUNTS` option is as same as `SQL_PARC_NO_BATCH`), error situations are handled as if one statement were executed.

If the driver performs parameter arrays as batches, an application can use the `SQL_DESC_ARRAY_STATUS_PTR` header field of the IPD to determine if a parameter of an SQL statement or a parameter in an array of parameters caused `SQLExecDirect` or `SQLExecute` to return an error.

This field contains status information for each row of parameter values. If the field represents that an error occurs, fields in the diagnostic data structure will represent the row and parameter number of the failed parameter. The number of columns in the array will be defined by the `SQL_DESC_ARRAY_SIZE` header field in the APD, and it can be set by the `SQL_ATTR_PARAMSET_SIZE` statement attribute.



The `SQL_DESC_ARRAY_STATUS_PTR` header field in the APD is used to ignore parameters. For more information about ignoring parameters, refer to **Ignoring Parameter Set**.

When `SQLExecute` or `SQLExecDirect` returns `SQL_ERROR`, the elements in the array pointed to by the `SQL_DESC_ARRAY_STATUS_PTR` field in the IPD contain `SQL_PARAM_ERROR`, `SQL_PARAM_SUCCESS`, `SQL_PARAM_SUCCESS_WITH_INFO`, `SQL_PARAM_UNUSED`, or `SQL_PARAM_DIAG_UNAVAILABLE`.

For each element in this array, the diagnostic data structure contains one or more status records. The `SQL_DIAG_ROW_NUMBER` field of the structure represents the row number of the parameter values which c

caused the error. If it is possible to determine the particular parameter in a row of parameters which caused the error, the parameter number will be entered in the SQL_DIAG_COLUMN_NUMBER field.

SQL_PARAM_UNUSED is set when a parameter is not used due to an error because SQLExecute or SQLExecDirect forcibly canceled an earlier parameter. For example, if 50 parameters exist and an error occurred while executing the 40th set of parameters which caused the cancellation by SQLExecute or SQLExecDirect, then SQL_PARAM_UNUSED is set in the status array for parameters from 41 to 50.

SQL_PARAM_DIAG_UNAVAILABLE is set when the driver treats arrays of parameters as a single unit, so it does not generate individual error information of parameter level.

Some errors in the processing of a single set of parameters cause processing of the subsequent sets of parameters in the array to stop. Other errors do not affect the processing of subsequent parameters. The driver defines which errors will stop processing. If processing does not stop, all parameters in the array are processed, SQL_SUCCESS_WITH_INFO is returned as a result of the error, and the buffer defined by SQL_ATTR_PARAMS_PROCESSED_PTR is set to the total number of sets of parameters processed which includes error sets.



ODBC behavior when an error occurs in the processing of an array of parameters is different between ODBC 3.x and ODBC 2.x.

In ODBC 2.x, the function returns SQL_ERROR and stops the processing. The buffer pointed to by the pirow argument of SQLParamOptions contained the number of the error row.

In ODBC 3.x, the function returns SQL_SUCCESS_WITH_INFO, and it may stop or continue processing. If it continues, the buffer specified by SQL_ATTR_PARAMS_PROCESSED_PTR will be set to the value of all parameters processed, including those which resulted in an error. This change in behavior can cause problems for existing applications.

When SQLExecute or SQLExecDirect returns SQL_ERROR or SQL_NEED_DATA before completing the processing of all parameter sets in a parameter array, the status array contains statuses for those parameters which have already been processed.

The location pointed to by the SQL_DESC_ROWS_PROCESSED_PTR field in the IPD contains the row number in the parameter array which caused the SQL_ERROR or SQL_NEED_DATA error code. When an array of parameters is sent to a SELECT statement, the availability of status array values is defined by the driver. They are available after the statement is executed or result sets are fetched.

Ignoring Parameter Set

SQL_DESC_ARRAY_STATUS_PTR field of APD can be used to indicate the binding parameter set which should be ignored in SQL statement. The application should perform the following processes in order that t

he driver directly ignores one or more parameter sets during the execution.

1. It calls `SQLSetDescField` in order that the header field of `SQL_DESC_ARRAY_STATUS_PTR` of APD points to an array of `SQLUSMALLINT` values including the status information. The field also can be set through `SQL_ATTR_PARAM_OPERATION_PTR` of Attribute argument in `SQLSetStmtAttr`, and it allows to set the field without a descriptor handle which is the application.
2. It sets each element of the array defined by `SQL_DESC_ARRAY_STATUS_PTR` of APD to one of the following two values.
 - `SQL_PARAM_IGNORE`: The row is excluded from the execution of the statement.
 - `SQL_PARAM_PROCEED`: The row is included in the execution of the statement.
3. It calls `SQLExecDirect` or `SQLExecute`, and executes the prepared statement. It applies the following rules to the array defined by `SQL_DESC_ARRAY_STATUS_PTR` of APD.
 - The pointer is set to `NULL` by default.
 - If the pointer is `NULL`, all parameter set are used as if all elements are set to `SQL_ROW_PROCEED`.
 - Setting the element to `SQL_PARAM_PROCEED` does not guarantee that the operation would use the specific parameter set.
 - `SQL_PARAM_PROCEED` is defines as 0 in the header file.

An application can set `SQL_DESC_ARRAY_STATUS_PTR` field of APD to refer to the same array as `SQL_DESC_ARRAY_STATUS_PTR` field of IRD. It is very useful when binding the parameters to the row data. The parameters may be ignored depending on the status of row data.

Along with `SQL_PARAM_IGNORE`, the following status codes are to ignore the parameter set in the SQL statement.

- `SQL_ROW_DELETED`
- `SQL_ROW_UPDATED`
- `SQL_ROW_ERROR`

Along with `SQL_PARAM_PROCEED`, the following status codes are to process the parameter set in the SQL statement.

- `SQL_ROW_SUCCESS`
- `SQL_ROW_SUCCESS_WITH_INFO`
- `SQL_ROW_ADDED`

Rebinding Parameter

The application can include many parameters, but if there is a buffer area for calling `SQLExecDirect` or `SQLExecute` which uses only some parameters, rebinding the parameter is particularly useful. The remaining space of buffer area can be used to set the next parameter by modifying the existing binding through off

set.

The `SQL_DESC_BIND_OFFSET_PTR` header field of APD points to the binding offset. If the field is not NULL, the driver dereferences to the pointer. If values of `SQL_DESC_DATA_PTR`, `SQL_INDICATOR_PTR` do not exist, and `SQL_DESC_OCTET_LENGTH_PTR` field is the NULL pointer, then the dereferenced value is added to the fields in the descriptor records during the execution time.

Offset is valid after rebinding. The application can directly modify the offset without calling `SQLSetDescField` or `SQLSetDescRec` to update the descriptor field because `SQL_DESC_BIND_OFFSET_PTR` field is the pointer to offset rather than the offset itself. The pointer is NULL by default.

`SQL_DESC_BIND_OFFSET_PTR` field of ARD can be set by calling `SQLSetDescField` or through `SQL_ATTR_PARAM_BIND_OFFSET_PTR` in Attribute argument of `SQLSetStmtAttr`. The offset binding always adds the value directly to `SQL_DESC_DATA_PTR`, `SQL_DESC_INDICATOR_PTR` and `SQL_DESC_OCTET_LENGTH_PTR`. If offset is changed to another value, the new value is continuously added directly to each descriptor field. The new offset is not added to the previous one.

Descriptor

The way which the parameter is bound is determined by APD and the IPD fields. The arguments in `SQLBindParameter` are used to set the descriptor fields. It is more effective to use the `SQLBindParameter` because the application can call `SQLBindParameter` without obtaining the descriptor handle, but the fields can also be set by the `SQLSetDescField` function.



Calling `SQLBindParameter` for a single statement may affect other statements. It occurs when ARD related to the statement is explicitly allocated and it is related to other statements. The modifications for the field affects all statements related the descriptor because `SQLBindParameter` modifies the fields of ARD. If it is not the required behavior, the application should release the relationship between the descriptor and other statements before calling `SQLBindParameter`.

Notionally, `SQLBindParameter` should perform the following processes.

1. It calls `SQLGetStmtAttr`, and obtains the APD handle.
2. It calls `SQLGetDescField`, and obtains `SQL_DESC_COUNT` field of APD is obtained. If the value of `ColumnNumber` exceeds the value of `SQL_DESC_COUNT`, then it calls `SQLSetDescField` to increase the value of `SQL_DESC_COUNT` to the value of `ColumnNumber`.
3. It calls `SQLSetDescField` multiple times, and sets the values of the following fields of APD.
 - It sets `SQL_DESC_TYPE` and `SQL_DESC_CONCISE_TYPE` to the value of `ValueType`.
 - It excludes `ValueType` if `ValueType` is one of the implied identifiers in datetime or interval sub format. It sets `SQL_DESC_TYPE` to `SQL_DATETIME` or `SQL_INTERVAL`, and it sets `SQL_DESC_CONCI`

SE_TYPE to the implied identifier, and sets SQL_DESC_DATETIME_INTERVAL_CODE to the corresponding datetime or interval subcode.

- It sets SQL_DESC_OCTET_LENGTH field to the value of BufferLength.
 - It sets SQL_DESC_DATA_PTR field to the value of ParameterValue.
 - It sets SQL_DESC_OCTET_LENGTH_PTR field to the value of StrLen_or_Ind.
 - It also sets SQL_DESC_INDICATOR_PTR field to the value of StrLen_or_Ind.
 - StrLen_or_Ind specifies both the indicator information and length of parameter value.
4. It calls SQLGetStmtAttr, and obtains the IPD handle.
 5. It calls SQLGetDescField, and obtains SQL_DESC_COUNT field of IPD. If the value of ColumnNumber exceeds the value of SQL_DESC_COUNT, then it calls SQLSetDescField to increase the value of SQL_DESC_COUNT to the value of ColumnNumber.
 6. It calls SQLSetDescField multiple times, and sets the values of following fields of IPD.
 - It sets SQL_DESC_TYPE and SQL_DESC_CONCISE_TYPE to the value of ParameterType.
 - It excludes ParameterType, if ParameterType is one of the implied identifiers with datetime or interval sub format. It sets SQL_DESC_TYPE to SQL_DATETIME or SQL_INTERVAL, and it sets SQL_DESC_CONCISE_TYPE to the implied identifier, and sets SQL_DESC_DATETIME_INTERVAL_CODE to the corresponding datetime or interval subcode.
 - It sets one or more SQL_DESC_LENGTH, SQL_DESC_PRECISION and SQL_DESC_DATETIME_INTERVAL_PRECISION for ParameterType, properly.
 - It sets SQL_DESC_SCALE to the value of DecimalDigits.

If it failed to call SQLBindParameter, the contents of the descriptor fields to be set in APD are not defined and SQL_DESC_COUNT field of APD is not changed. Additionally, SQL_DESC_LENGTH, SQL_DESC_PRECISION, SQL_DESC_SCALE, and SQL_DESC_TYPE fields of the proper record in IPD are not defined and SQL_DESC_COUNT field of IPD is not changed.

SQLBrowseConnect

It is not supported.

Conformance

Introduced version: ODBC 1.0

Standards compliance: ODBC

Overview

SQLBrowseConnect finds the attribute and its value which are required to connect to the data source, and supports a method for the iterative list.

Syntax

```
SQLRETURN SQLBrowseConnect(  
    SQLHDBC          ConnectionHandle,  
    SQLCHAR *        InConnectionString,  
    SQLSMALLINT      StringLength1,  
    SQLCHAR *        OutConnectionString,  
    SQLSMALLINT      BufferLength,  
    SQLSMALLINT *    StringLength2Ptr);
```

SQLBulkOperations

It is not supported.

Conformance

Introduced version: ODBC 3.0

Standards compliance: ODBC

Overview

SQLBulkOperations performs the massive bookmark operations such as the bulk inserts, and the updates, deletes, fetches through the bookmark.

Syntax

```
SQLRETURN SQLBulkOperations(  
    SQLHSTMT      StatementHandle,  
    SQLUSMALLINT  Operation);
```

SQLCancel

It is not supported.

Conformance

Introduced version: ODBC 1.0

Standards compliance: ISO 92

Overview

SQLCancel cancels the statement in progress.

Use **SQLCancelHandle** function to cancel the connection or statement in progress.

Syntax

```
SQLRETURN SQLCancel(  
    SQLHSTMT    StatementHandle);
```

SQLCancelHandle

It is not supported.

Conformance

Introduced version: ODBC 3.8

Standards compliance: It is not available.

Overview

SQLCancelHandle cancels processing of the connection or the statement.

Syntax

```
SQLRETURN SQLCancelHandle(  
    SQLSMALLINT HandleType,  
    SQLHANDLE Handle);
```

SQLCloseCursor

Conformance

Introduced version: ODBC 3.0

Standards compliance: ISO 92

Overview

SQLCloseCursor closes an open cursor on the statement and discards the remaining results.

Syntax

```
SQLRETURN SQLCloseCursor(  
    SQLHSTMT    StatementHandle);
```

Arguments

StatementHandle

[Input] It is the statement handle.

Returns

SQL_SUCCESS, SQL_SUCCESS_WITH_INFO, SQL_ERROR, SQL_INVALID_HANDLE

Diagnosis

SQLSTATE	Error	Description
24000	Invalid cursor state	Open cursor does not exist on the statement.
HY000	General error	It is an error without any specific SQLSTATE.
HY001	Memory allocation error	It is a memory allocation error.
HY010	Function sequence error	SQL_NEED_DATA is returned after calling SQLExecute, SQLExecDirect, the function is called before sending all data-at-execution parameters.

Description

If open cursor does not exist, `SQLCloseCursor` returns `SQLSTATE 24000`(Invalid cursor state). Calling `SQLCloseCursor` is as same as calling `SQLFreeStmt` with `SQL_CLOSE` option. However, when open cursor does not exist, `SQLCloseCursor` returns `SQLSTATE 24000` (Invalid cursor state), but calling `SQLFreeStmt` does not affect the application.

SQLColAttribute

Conformance

Introduced version: ODBC 3.0

Standards compliance: ISO 92

Overview

SQLColAttribute returns the descriptor information for the result set column. The descriptor information is returned as a string or integer value.

Syntax

```
SQLRETURN SQLColAttribute (  
    SQLHSTMT      StatementHandle,  
    SQLUSMALLINT  ColumnNumber,  
    SQLUSMALLINT  FieldIdentifier,  
    SQLPOINTER    CharacterAttributePtr,  
    SQLSMALLINT   BufferLength,  
    SQLSMALLINT * StringLengthPtr,  
    SQLLEN *      NumericAttributePtr);
```

Arguments

StatementHandle

[Input] It is the statement handle.

ColumnNumber

[Input] It is the record number to retrieve for a field value in IRD. It starts from 1 and corresponds to the column number of result data which sequentially increases. The column can be described in random order.

The number 0 column can be specified to ColumnNumber, but the undefined value is returned except for SQL_DESC_TYPE and SQL_DESC_OCTET_LENGTH.

FieldIdentifier

[Input] It is the descriptor handle. It defines the field retrieved in IRD. (e.g. SQL_COLUMN_TABLE_NAME)

CharacterAttributePtr

[Output] It is the buffer pointer returning the field value when the value of FieldIdentifier field of the ColumnNumber column of IRD is a string. If the field value is not a string, it is not used.

If CharacterAttributePtr is NULL, StringLengthPtr returns the total number of bytes which can be returned. (Except for null-termination character)

BufferLength

[Input] It is the length of *CharacterAttributePtr when FieldIdentifier is defined in ODBC and CharacterAttributePtr points to a string or binary buffer. If FieldIdentifier is defined in ODBC and *CharacterAttributePtr is an integer, it is ignored.

StringLengthPtr

[Output] It is the pointer returning the total number of bytes which can be returned in *CharacterAttributePtr. (Except for null-termination character for the character data)

For the character data, if the number of bytes which can be returned is equal to or bigger than BufferLength, the description information of *CharacterAttributePtr is truncated to the length of BufferLength minus 1, and it is null terminated by the driver.

For other data types, the value of BufferLength is ignored.

NumericAttributePtr

[Output] It is the buffer pointer which returns the field value when the value of FieldIdentifier field of the ColumnNumber column of IRD is a number such as SQL_DESC_COLUMN_LENGTH. If the field value is not a number, it is not used.

Returns

SQL_SUCCESS, SQL_SUCCESS_WITH_INFO, SQL_STILL_EXECUTING, SQL_ERROR, SQL_INVALID_HANDLE

Diagnosis

SQLSTATE	Error	Description
01004	String data, right truncated	*CharacterAttributePtr buffer is not large enough to return the entire string, so the string is truncated. The length of string not truncated is returned to *StringLengthPtr. (The function returns SQL_SUCCESS_WITH_INFO.)
07005	Prepared statement not a cursor-specification	The statement does not return the result set, and FieldIdentifier is not SQL_DESC_COUNT. The column to explain does not exist.
07009	Invalid descriptor index	The value of ColumnNumber argument is bigger than the number of columns in the result set.
HY000	General error	It is an error without any specific SQLSTATE.
HY001	Memory allocation error	It is a memory allocation error.

SQLSTATE	Error	Description
HY010	Function sequence error	This function is called before SQLPrepre, SQLExecDirect, the catalog function. After calling SQLExecute, SQLExecDirect, then SQL_NEED_DATA is returned, and this function is called before sending all data-at-execution variables.
HY090	Invalid string or buffer length	*CharacterAttributePtr is a string, BufferLength is smaller than 0 but it is not SQL_NTS.
HY091	Invalid descriptor field identifier	The value of FieldIdentifier argument is not defined.

Description

SQLColAttribute returns information to *NumericAttributePtr or *CharacterAttributePtr. Integer information is returned as SQLLEN value to *NumericAttributePtr. All other data type information is returned to *CharacterAttributePtr. When information is returned to *NumericAttributePtr, the driver ignores CharacterAttributePtr, BufferLength, StringLengthPtr. When the information is returned to *CharacterAttributePtr, the driver ignores NumericAttributePtr.

SQLColAttribute returns the value in the descriptor field of IRD. The value of FieldIdentifier returned to SQLColAttribute can be obtained by calling SQLGetDescField with appropriate IRD handle.

The following table is the descriptor types returned to SQLColAttribute. The type of NumericAttributePtr is SQLLEN*.

FieldIdentifier	Information return	Description
SQL_DESC_AUTO_UNIQUE_VALUE (ODBC 1.0)	NumericAttributePtr	<ul style="list-style-type: none"> SQL_TRUE: It is an auto increment column. SQL_FALSE: It is neither an auto increment column nor a numeric type.
SQL_DESC_BASE_COLUMN_NAME (ODBC 3.0)	CharacterAttributePtr	<p>It is the default column name for the result set columns. If the default column name does not exist(in case of an expression column), the variable will contain an empty string.</p> <p>This information is returned in the record field of SQL_DESC_BASE_COLUMN_NAME which is the read-only field of IRD.</p>
SQL_DESC_BASE_TABLE_NAME (ODBC 3.0)	CharacterAttributePtr	<p>It is the base table name which contains the column. If the base table name can not be defined or is not applicable the variable contains an empty string.</p> <p>This information is returned in the record field of SQL_DESC_BASE_TABLE_NAME which is the read-only field of IRD.</p>
SQL_DESC_CASE_SENSITIVE (ODBC 1.0)	NumericAttributePtr	<ul style="list-style-type: none"> SQL_TRUE: The column is case-sensitive for sorting or comparisons. SQL_FALSE: The column is neither case-sensitive for sorting or comparison nor is a character.

FieldIdentifier	Information return	Description
SQL_DESC_CATALOG_NAME (ODBC 2.0)	CharacterAttributePtr	It is the catalog of the table containing the column.
SQL_DESC_CONCISE_TYPE (ODBC 1.0)	NumericAttributePtr	It is concise data type. For datetime and interval data, the concise data such as SQL_TYPE_TIME, SQL_INTERVAL_YEAR is returned. This information is returned in the record field of SQL_DESC_CONCISE_TYPE of IRD.
SQL_DESC_COUNT (ODBC 1.0)	NumericAttributePtr	It is the number of columns which can be used in the result set. If column does not exist in the result set, 0 is returned. ColumnNumber argument is ignored. This information is returned in the header field of SQL_DESC_COUNT of IRD.
SQL_DESC_DISPLAY_SIZE (ODBC 1.0)	NumericAttributePtr	It is the maximum number of characters required to display the column.
SQL_DESC_FIXED_PREC_SCALE (ODBC 1.0)	NumericAttributePtr	<ul style="list-style-type: none"> SQL_TRUE: The column has the fixed precision and non-zero scale. SQL_FALSE: The column does not have the fixed precision but it has the non-zero scale.
SQL_DESC_LABEL (ODBC 2.0)	CharacterAttributePtr	It is the column label or title. For example, the column name, EmpName, can be displayed as employee name or alias. If the label does not exist, the column name is returned. If a label or name is not specified to the column, an empty string is returned.
SQL_DESC_LENGTH (ODBC 3.0)	NumericAttributePtr	It is the maximum or actual length of data of the string or binary data type. A fixed length data type is the maximum character length, and a variable-length data type is the actual character length. This value always excludes the null-termination byte of the string at the end. This information is returned in the record field of SQL_DESC_LENGTH of IRD.
SQL_DESC_LITERAL_PREFIX (ODBC 3.0)	CharacterAttributePtr	This VARCHAR (128) record field contains a character or string which the driver recognizes the prefix of the data type. The data type to which a prefix is not applied contains an empty string.
SQL_DESC_LITERAL_SUFFIX (ODBC 3.0)	CharacterAttributePtr	This VARCHAR (128) record field contains a character or string which the driver recognizes the suffix of the data type. The data type to which a suffix is not applied contains an empty string.
SQL_DESC_LOCALIZED_TYPE_NAME (ODBC 3.0)	CharacterAttributePtr	The VARCHAR (128) record field contains the localized (native language) name of data type which is different from the regular name of data type. If the localized name does not exist, an empty string is returned. This field is only for display purposes. The character set of string depends on the locale, and the default is usually the character set of the server.
		It is the column alias of when the column alias is applied. If the column alias

FieldIdentifier	Information return	Description
SQL_DESC_NAME (ODBC 3.0)	CharacterAttributePtr	<p>is not applied, the column name is returned. In both cases, SQL_DESC_UNNAMED is set to SQL_NAMED. If column name or alias does not exist, an empty string is returned, and SQL_DESC_UNNAMED is set to SQL_UNNAMED.</p> <p>This information is returned in the record field of SQL_DESC_NAME of IRD.</p>
SQL_DESC_NULLABLE (ODBC 3.0)	NumericAttributePtr	<ul style="list-style-type: none"> SQL_NULLABLE: The column can have NULL value. SQL_NO_NULLS: The column can not have NULL value. SQL_NULLABLE_UNKNOWN: It is unknown whether NULL value is allowed for the column. <p>This information is returned in the record field of SQL_DESC_NULLABLE of IRD.</p>
SQL_DESC_NUM_PREC_RADIX (ODBC 3.0)	NumericAttributePtr	<p>If the data type of SQL_DESC_TYPE field is the approximate numeric data type, this field contains 2 because SQL_DESC_PRECISION field contains the number of bits. If the data type of SQL_DESC_TYPE field is the exact numeric data type, this field contains 10 because SQL_DESC_PRECISION field contains the number of decimal digits. This field is set to 0 for all non-numeric data types.</p>
SQL_DESC_OCTET_LENGTH (ODBC 3.0)	NumericAttributePtr	<p>It is byte length of string or binary data type. For a fixed-length character or binary data type, it is the actual byte length. For a variable-length character or binary data type, it is the maximum length in bytes. This value does not include null termination.</p> <p>This information is returned in the record field of SQL_DESC_OCTET_LENGTH of IRD.</p>
SQL_DESC_PRECISION (ODBC 3.0)	NumericAttributePtr	<p>It is the precision applicable to the numeric data type. For SQL_TYPE_TIME, SQL_TYPE_TIMESTAMP, all interval data types representing time interval, the value is the applicable fractional seconds precision.</p> <p>This information is returned in the record field of SQL_DESC_PRECISION of IRD.</p>
SQL_DESC_SCALE (ODBC 3.0)	NumericAttributePtr	<p>It is the scale applicable to the numeric data type. For DECIMAL or NUMERIC data type, the scale is defined, and for all other data types, it is not defined.</p> <p>This information is returned in the record field of SQL_DESC_SCALE of IRD.</p>
SQL_DESC_SCHEMA_NAME (ODBC 2.0)	CharacterAttributePtr	<p>It is the schema of a table containing a column.</p>
SQL_DESC_SEARCH		<ul style="list-style-type: none"> SQL_PRED_NONE: The column can not used in WHERE clause. (It is as same as SQL_UNSEARCHABLE of ODBC 2.x.) SQL_PRED_CHAR: The column can be used in WHERE clause but only

FieldIdentifier	Information return	Description
CHABLE (ODBC 1.0)	NumericAttribute Ptr	with the LIKE predicate. (It is as same as SQL_LIKE_ONLY of ODBC 2.x.) <ul style="list-style-type: none"> SQL_PRED_BASIC: Any comparison operator except LIKE can be used in WHERE clause. (It is as same as SQL_EXCEPT_LIKE of ODBC 2.x.) SQL_PRED_SEARCHABLE: The column can be used in WHERE clause to gether with any comparison operator.
SQL_DESC_TABLE_NAME (ODBC 2.0)	CharacterAttribute ePtr	It is the name of table including the column. If the tabe name is unknown, an empty string is returned.
SQL_DESC_TYPE (ODBC 3.0)	NumericAttribute Ptr	It is the numeric value to specify the SQL data type. For datetime or interval data type, the verbose data type such as SQL_DATE TIME or SQL_INTERVAL is returned. This information is returned in the record field of SQL_DESC_TYPE of IRD.
SQL_DESC_TYPE_NAME (ODBC 1.0)	CharacterAttribute ePtr	It is the data type name which is dependent on the data source. (e.g. "CHARACTER", "CHARACTER VARYING", "CHARACTER LONG VARYING")
SQL_DESC_UNNAMED (ODBC 3.0)	NumericAttribute Ptr	It is SQL_NAMED or SQL_UNNAMED. If the column alias or column name is included in the field of SQL_DESC_NAME of IRD, SQL_NAMED is returned, and if there is not a column name or alias, SQL_UNNAME is returned. This information is returned in the record field of SQL_DESC_UNNAMED of IRD.
SQL_DESC_UNSIGNED (ODBC 1.0)	NumericAttribute Ptr	<ul style="list-style-type: none"> SQL_TRUE: The column is neither an unsigned nor is a number. SQL_FALSE: The column is a signed.
SQL_DESC_UPDATABLE (ODBC 1.0)	NumericAttribute Ptr	The column can have the value of SQL_ATTR_READONLY, SQL_ATTR_WRITE, SQL_ATTR_READWRITE_UNKNOWN.

SQLColAttributes

Conformance

Introduced version: ODBC 1.0

Standards compliance: It is not available.

Overview

SQLColAttributes function in ODBC 2.0 was replaced with SQLColAttribute function in ODBC 3.x. For more information, refer to [SQLColAttribute](#).

SQLColumnPrivileges

Conformance

Introduced version: ODBC 1.0

Standards compliance: ODBC

Overview

SQLColumnPrivileges returns a list of columns and related privileges for the specified table as a result set.

Syntax

```
SQLRETURN SQLColumnPrivileges(  
    SQLHSTMT      StatementHandle,  
    SQLCHAR *     CatalogName,  
    SQLSMALLINT   NameLength1,  
    SQLCHAR *     SchemaName,  
    SQLSMALLINT   NameLength2,  
    SQLCHAR *     TableName,  
    SQLSMALLINT   NameLength3,  
    SQLCHAR *     ColumnName,  
    SQLSMALLINT   NameLength4);
```

Arguments

StatementHandle

[Input] It is the statement handle.

CatalogName

[Input] It is the catalog name. CatalogName can not include the string search pattern.

If the SQL_ATTR_METADATA_ID statement attribute is set to SQL_TRUE, CatalogName is treated as a case-insensitive identifier. If it is set to SQL_FALSE, CatalogName is case-sensitive, and it is an ordinary argument literally processed.

NameLength1

[Input] It is the length of *CatalogName.

SchemaName

[Input] It is the schema name. SchemaName can not include the string search pattern.

If the SQL_ATTR_METADATA_ID statement attribute is set to SQL_TRUE, SchemaName is treated as a case-insensitive identifier. If it is set to SQL_FALSE, SchemaName is case-sensitive, and it is an ordinary argument literally processed.

NameLength2

[Input] It is the length of *SchemaName.

TableName

[Input] It is the table name. This argument can not be a null pointer. TableName can not include the string search pattern.

If the SQL_ATTR_METADATA_ID statement attribute is set to SQL_TRUE, TableName is treated as a case-insensitive identifier. If it is set to SQL_FALSE, TableName is case-sensitive, and it is an ordinary argument literally processed.

NameLength3

[Input] It is the length of *TableName.

ColumnName

[Input] It is the string search pattern for the column name.

If the SQL_ATTR_METADATA_ID statement attribute is set to SQL_TRUE, ColumnName is treated as a case-insensitive identifier. If it is set to SQL_FALSE, ColumnName is case-sensitive, and it is a pattern value literally processed.

NameLength4

[Input] It is the length of *ColumnName.

Returns

SQL_SUCCESS, SQL_SUCCESS_WITH_INFO, SQL_STILL_EXECUTING, SQL_ERROR, SQL_INVALID_HANDLE

Diagnosis

SQLSTATE	Error	Description
08S01	Communication link failure	Before the function processing is completed, the connection between the driver and the data source is failed.
24000	Invalid cursor state	SQLFetch, SQLFetchScroll are called and a cursor is open.
HY000	General error	It is an error without specific SQLSTATE.
HY001	Memory allocation error	It is a memory allocation error.
HY009	Invalid use of null pointer	TableName argument is the null pointer. The attribute value of SQL_ATTR_METADATA_ID is SQL_TRUE state

SQLSTATE	Error	Description
		ment, and SchemaName or ColumnName is the null pointer.
HY010	Function sequence error	After calling SQLExecute, SQLExecDirect, then SQL_NEED_DATA is returned, and the function is called before sending all data-at-execution variables.
HY090	Invalid string or buffer length	A name length argument value is smaller than 0 but it is not SQL_NTS.
HYT00	Timeout expired	Before downloading the entire result set from the data source, the query timeout expired. The timeout can be set through SQL_ATTR_QUERY_TIMEOUT of SQLSetStmtAttr.

Description

SQLColumnPrivileges returns the standard result set aligned as TABLE_CAT, TABLE_SCHEM, TABLE_NAME, COLUMN_NAME, PRIVILEGE.

The following table describes the columns in the result set.

Column name	Column number	Data type	Description
TABLE_CAT (ODBC 1.0)	1	VARCHAR	It is the catalog identifier.
TABLE_SCHEM (ODBC 1.0)	2	VARCHAR	It is the schema identifier.
TABLE_NAME (ODBC 1.0)	3	VARCHAR not NULL	It is the table identifier.
COLUMN_NAME (ODBC 1.0)	4	VARCHAR not NULL	It is the column name. It returns an empty string for a column which does not have a name.
GRANTOR (ODBC 1.0)	5	VARCHAR	It is the grantor name.
GRANTEE (ODBC 1.0)	6	VARCHAR not NULL	It is the grantee name.
PRIVILEGE (ODBC 1.0)	7	VARCHAR not NULL	It is the column privilege identifier. It can be one of the followings. <ul style="list-style-type: none"> • SELECT: The grantee is allowed to retrieve the column data. • INSERT: The grantee is allowed to insert the data to the column of the associated table. • UPDATE: The grantee is allowed to update the column data. • REFERENCES: The grantee is allowed to reference the column in the constraints (e.g. unique, referential, table check constraint).

Column name	Column number	Data type	Description
IS_GRANTABLE (ODBC 1.0)	8	VARCHAR	It checks whether the grantee can grant the privilege to other user, and it is specified as "YES", "NO".

SQLColumns

Conformance

Introduced version: ODBC 1.0

Standards compliance: Open Group

Overview

SQLColumns returns a list of column names in the specified table as a result set.

Syntax

```
SQLRETURN SQLColumns(
    SQLHSTMT      StatementHandle,
    SQLCHAR *     CatalogName,
    SQLSMALLINT   NameLength1,
    SQLCHAR *     SchemaName,
    SQLSMALLINT   NameLength2,
    SQLCHAR *     TableName,
    SQLSMALLINT   NameLength3,
    SQLCHAR *     ColumnName,
    SQLSMALLINT   NameLength4);
```

Arguments

StatementHandle

[Input] It is the statement handle.

CatalogName

[Input] It is the catalog name. CatalogName can not include the string search pattern.

If the SQL_ATTR_METADATA_ID statement attribute is set to SQL_TRUE, CatalogName is treated as a case-insensitive identifier. If it is set to SQL_FALSE, CatalogName is case-sensitive, and it is an ordinary argument literally processed.

NameLength1

[Input] It is the length of *CatalogName

SchemaName

[Input] It is the string search pattern for the schema name.

If the `SQL_ATTR_METADATA_ID` statement attribute is set to `SQL_TRUE`, `SchemaName` is treated as a case-insensitive identifier. If it is set to `SQL_FALSE`, `SchemaName` is case-sensitive, and it is an ordinary argument literally processed.

NameLength2

[Input] It is the length of `*SchemaName`.

TableName

[Input] It is the string search pattern for the table name.

If the `SQL_ATTR_METADATA_ID` statement attribute is set to `SQL_TRUE`, `TableName` is treated as a case-insensitive identifier. If it is set to `SQL_FALSE`, `TableName` is case-sensitive, and it is an ordinary argument literally processed.

NameLength3

[Input] It is the length of `*TableName`.

ColumnName

[Input] It is the string search pattern for the column name.

If the `SQL_ATTR_METADATA_ID` statement attribute is set to `SQL_TRUE`, `ColumnName` is treated as a case-insensitive identifier. If it is set to `SQL_FALSE`, `ColumnName` is case-sensitive, and it is a pattern value literally processed.

NameLength4

[Input] It is the length of `*ColumnName`.

Returns

`SQL_SUCCESS`, `SQL_SUCCESS_WITH_INFO`, `SQL_STILL_EXECUTING`, `SQL_ERROR`, `SQL_INVALID_HANDLE`

Diagnosis

SQLSTATE	Error	Description
08S01	Communication link failure	Before the function processing is completed, the connection between the driver and the data source is failed.
24000	Invalid cursor state	<code>SQLFetch</code> , <code>SQLFetchScroll</code> are called and a cursor is open.
HY000	General error	It is an error without any specific SQLSTATE.
HY001	Memory allocation error	It is a memory allocation error.
HY009	Invalid use of null pointer	<code>TableName</code> argument is a null pointer. The attribute value of <code>SQL_ATTR_METADATA_ID</code> statement is <code>SQL_TRUE</code> , <code>SchemaName</code> or <code>ColumnName</code> is a null pointer.
HY010	Function sequence error	After calling <code>SQLExecute</code> , <code>SQLExecDirect</code> , then <code>SQL_NEED_DATA</code> is returned, and the function is called before sending all data-at-execution variables.

SQLSTATE	Error	Description
HY090	Invalid string or buffer length	A name length argument value is smaller than 0 but it is not SQL_NTS.
HYT00	Timeout expired	Before downloading the entire result set from the data source, the query timeout expired. The timeout can be set through SQL_ATTR_QUERY_TIMEOUT of SQLSetStmtAttr.

Description

This function is generally used prior to the execution of statement which retrieves information about the columns of the table or tables in the catalog of the data source. SQLColumns can be used to retrieve all data types returned by SQLTables. By contrast, SQLColAttribute and SQLDescribeCol describe the columns in the result set, and SQLNumResultCols returns the number of columns in the result set.

SQLColumns returns the standard result set sorted as TABLE_CAT, TABLE_SCHEM, TABLE_NAME, ORDINAL_POSITION.

The following table describes the columns in the result set.

Column name	Column number	Data type	Description
TABLE_CAT (ODBC 1.0)	1	VARCHAR	It is the catalog name.
TABLE_SCHEM (ODBC 1.0)	2	VARCHAR	It is the schema name.
TABLE_NAME (ODBC 1.0)	3	VARCHAR not NULL	It is the table name.
COLUMN_NAME (ODBC 1.0)	4	VARCHAR not NULL	It is the column name. It returns an empty string for a column which does not have a name.
DATA_TYPE (ODBC 1.0)	5	SMALLINT not NULL	It is SQL data type. For datetime and interval data types, the column returns the concise data type like SQL_TYPE_DATE, SQL_INTERVAL_YEAR_TO_MONTH.
TYPE_NAME (ODBC 1.0)	6	VARCHAR not NULL	It is the data type name dependent on the data source. (e.g. "CHARACTER", "CHARACTER VARYING", "CHARACTER LONG VARYING")
COLUMN_SIZE (ODBC 1.0)	7	INTEGER	If DATA_TYPE is SQL_CHAR or SQL_VARCHAR, the column includes the maximum number of characters up to length of the column. If it is a datetime data column, it is the number of characters needed for converting the value to the character. If it is a numeric data type, it is the total

Column name	Column number	Data type	Description
0)			number of digits of the column NUM_PREC_RADIX or the number of bits allowed for the column. If it is an interval data type, it is the number of characters needed to be represented by the interval leading precision.
BUFFER_LENGTH (ODBC 1.0)	8	INTEGER	If SQL_C_DEFAULT is specified, it is the byte length of the data to be transmitted to SQLGetData, SQLFetch, SQLFetchScroll.
DECIMAL_DIGITS (ODBC 1.0)	9	SMALLINT	For a positive number, it is the number of significant digits on the right of the decimal point. For a negative number, it is the number of significant digits on the left of the decimal point. For SQL_TYPE_TIME and SQL_TYPE_TIMESTAMP, this column is the number of digits of fractional seconds. For interval data type that contains the second, it is the number of digits right of the decimal point (fractional seconds). The data type that DECIMAL DIGITS can not be applied, returns NULL.
NUM_PREC_RADIX (ODBC 1.0)	10	SMALLINT	For the numeric data type, it is 2 or 10. For 2, COLUMN_SIZE and DECIMAL_DIGITS are the number of bits allowed in the column. For 10, COLUMN_SIZE and DECIMAL_DIGITS are the number of digits allowed in the column. The data type that NUM_PREC_RADIX can not be applied, returns NULL.
NULLABLE (ODBC 1.0)	11	SMALLINT not NULL	<ul style="list-style-type: none"> SQL_NO_NULLS: The column can not have NULL value. SQL_NULLABLE: The column can have NULL value. SQL_NULLABLE_UNKNOWN: It is unknown whether the column is allowed to have NULL value.
REMARKS (ODBC 1.0)	12	VARCHAR	It is the description on the column.
COLUMN_DEFAULT (ODBC 3.0)	13	VARCHAR	It is the default value of column. If the value is enclosed by the quote, the column should be interpreted as a string.
SQL_DATA_TYPE (ODBC 3.0)	14	SMALLINT not NULL	It is the SQL data type of the record field of SQL_DESC_TYPE of IRD. The column is the same as DATA TYPE except the datetime and interval data types. For datetime and interval data types, the column returns the nonconcise data type like SQL_DATE, SQL_INTERVAL, and the specific data type is determined using SQL_DATETIME_SUB column.
SQL_DATETIME_SUB (ODBC 3.0)	15	SMALLINT	It is the sub type code of datetime and interval data types. Other data types return NULL.
CHAR_OCTET_LENGTH (ODBC 3.0)	16	INTEGER	It is the maximum length in bytes of characters or binary data type column. Other data types return NULL.
ORDINAL_POSITION			

Column name	Column number	Data type	Description
POSITION (ODBC 3.0)	17	INTEGER not NULL	It is the column position in the table.
IS_NULLABLE (ODBC 3.0)	18	VARCHAR	<ul style="list-style-type: none">"NO": The column can not contain NULL."YES": The column can contain NULL. If it is unknown whether NULL is allowed, It returns a zero-length string.

SQLConnect

Conformance

Introduced version: ODBC 1.0

Standards compliance: ISO 92

Overview

SQLConnect sets a connection between the driver and the data source. The connection handle refers to a ll information about the connection including status, transaction status and error information.

Syntax

```
SQLRETURN SQLConnect(  
    SQLHDBC      ConnectionHandle,  
    SQLCHAR *    ServerName,  
    SQLSMALLINT  NameLength1,  
    SQLCHAR *    UserName,  
    SQLSMALLINT  NameLength2,  
    SQLCHAR *    Authentication,  
    SQLSMALLINT  NameLength3);
```

Arguments

ConnectionHandle

[Input] It is the connection handle.

ServerName

[Input] It is the data source name.

NameLength1

[Input] It is the length of *ServerName.

UserName

[Input] It is the user identifier.

NameLength2

[Input] It is the length of *UserName.

Authentication

[Input] It is the authentication string (typically password).

NameLength3

[Input] It is the length of *Authentication.

Returns

SQL_SUCCESS, SQL_SUCCESS_WITH_INFO, SQL_ERROR, SQL_INVALID_HANDLE, SQL_STILL_EXECUTING

Diagnosis

SQLSTATE	Error	Description
08001	Client unable to establish connection	The driver can not set a connection with a data source.
08002	Connection name in use	The specified ConnectionHandle is already connected with the data source.
08004	Server rejected the connection	In the state of the setting limits, the data source rejects to establish the connection.
08S01	Communication link failure	Before the function processing is completed, the connection between the driver and the data source is failed.
28000	Invalid authorization specification	The argument value of UserName or Authentication is not correct.
HY000	General error	It is an error without any specific SQLSTATE.
HY001	Memory allocation error	It is a memory allocation error.
HY090	Invalid string or buffer length	The value of NameLength1, NameLength2 or NameLength3 is smaller than 0, but it is not SQL_NTS.
HYT00	Timeout expired	Before connecting to the data source, Login timeout expired. The timeout can be set through SQL_ATTR_LOGIN_TIMEOUT of SQLSetConnectAttr.

Description

The driver searches for the user DSN information in an order of \$HOME/.odbc.ini file and /home/.odbc.ini file which are files set in \$ODBCINI environment variable. If the DSN which was input in the user DSN does not exist, the driver searches for the DSN information in an order of \$ODBCSYSINI/odbc.ini file, /etc/odbc.ini file which is system DSN.

SQLCopyDesc

It is not supported.

Conformance

Introduced version: ODBC 3.0

Standards compliance: ISO 92

Overview

SQLCopyDesc copies the descriptor information from one descriptor handle to another descriptor handle.

Syntax

```
SQLRETURN SQLCopyDesc(  
    SQLHDESC    SourceDescHandle,  
    SQLHDESC    TargetDescHandle);
```

SQLDescribeCol

Conformance

Introduced version: ODBC 1.0

Standards compliance: ISO 92

Overview

SQLDescribeCol returns a column name, type, column size, decimal place, information about null permit in the result set column. The information can be used in the fields of IRD.

Syntax

```
SQLRETURN SQLDescribeCol(  
    SQLHSTMT      StatementHandle,  
    SQLUSMALLINT  ColumnNumber,  
    SQLCHAR *     ColumnName,  
    SQLSMALLINT   BufferLength,  
    SQLSMALLINT * NameLengthPtr,  
    SQLSMALLINT * DataTypePtr,  
    SQLULEN *     ColumnSizePtr,  
    SQLSMALLINT * DecimalDigitsPtr,  
    SQLSMALLINT * NullablePtr);
```

Arguments

StatementHandle

[Input] It is the statement handle.

ColumnNumber

[Input] It is the column number in the result set which is started from 1 and increased sequentially.

ColumnName

[Output] It is the buffer pointer which is terminated by a null and returns the column name. This value can be read in SQL_DESC_NAME field of IRD. If the column name does not exist or the column name is unknown, the driver returns an empty string.

If ColumnName is null, NameLengthPtr returns the total number of bytes returnable. (excluding null-termination character)

BufferLength

[Input] It is the length of *ColumnName.

NameLengthPtr

[Output] It is the buffer pointer which returns the total number of bytes returnable to *ColumnName (excluding the null-termination character). If the returnable length is equal to or bigger than BufferLength, *ColumnName is truncated to the length of BufferLength minus null.

DataTypePtr

[Output] It is the buffer pointer which returns the SQL type of a column. The value can be read in SQL_DESC_CONCISE_TYPE of IRD.

ColumnSizePtr

[Output] It is the buffer pointer which returns the column size of the data source.

DecimalDigitsPtr

[Output] It is the buffer pointer which returns the decimal place of the data source.

NullablePtr

[Output] It is the buffer pointer which returns whether the column allows for null. The value can be read in SQL_DESC_NULLABLE field of IRD. It is one of the followings.

- SQL_NO_NULLS: The column does not allow NULL.
- SQL_NULLABLE: The column allows NULL.
- SQL_NULLABLE_UNKNOWN: The driver can not determine whether the column allows NULL.

Returns

SQL_SUCCESS, SQL_SUCCESS_WITH_INFO, SQL_STILL_EXECUTING, SQL_ERROR, SQL_INVALID_HANDLE

Diagnosis

SQLSTATE	Error	Description
01004	String data, right truncated	*ColumnName is not large enough to return the entire column name, so the column name is truncated. The column length not truncated is returned in *NameLengthPtr. (The function returns SQL_SUCCESS_WITH_INFO.)
07005	Prepared statement not a cursor-specification	The statement does not return a result set, so there is not a column to be explained.
07009	Invalid descriptor index	The value of ColumnNumber argument is bigger than the number of columns in the result set.
08S01	Communication link failure	Before the function processing is completed, the connection between the driver and the data source is failed.

SQLSTATE	Error	Description
HY000	General error	It is an error without any specific SQLSTATE.
HY001	Memory allocation failure	It is a memory allocation error.
HY010	Function sequence error	After calling SQLExecute, SQLExecDirect, then SQL_NEED_DATA is returned, the function is called before sending all data-at-execution variables.
HY090	Invalid string or buffer length	The value of BufferLength argument is smaller than 0.

Description

Generally, the application calls SQLDescribeCol before or after calling SQLExecute related after calling SQL Prepare. Also, the application may call SQLDescribeCol after calling SQLExecDirect.

SQLDescribeParam

Conformance

Introduced version: ODBC 1.0

Standards compliance: ODBC

Overview

SQLDescribeParam returns the description of a parameter marker related to a prepared SQL statement. This information can be used in the fields of the IPD.

Syntax

```
SQLRETURN SQLDescribeParam(  
    SQLHSTMT      StatementHandle,  
    SQLUSMALLINT  ParameterNumber,  
    SQLSMALLINT *  DataTypePtr,  
    SQLULEN *     ParameterSizePtr,  
    SQLSMALLINT *  DecimalDigitsPtr,  
    SQLSMALLINT *  NullablePtr);
```

Arguments

StatementHandle

[Input] It is the statement handle.

ParameterNumber

[Input] It is the parameter marker number which is started from 1 and increased sequentially.

DataTypePtr

[Output] It is the buffer pointer which returns the SQL type of parameter. The value can be read in the record field of SQL_DESC_CONCISE_TYPE of IPD.

ParameterSizePtr

[Output] It is the buffer pointer which returns the size of column or expression for the parameter marker.

DecimalDigitsPtr

[Output] It is the buffer pointer which returns the decimal places of column or expression for the parameter marker.

NullablePtr

[Output] It is the buffer pointer which returns whether the parameter allows for null. The value can be read in SQL_DESC_NULLABLE of IPD. The value is one of the followings.

- SQL_NO_NULLS: The parameter does not allow NULL.
- SQL_NULLABLE: The parameter allows NULL.
- SQL_NULLABLE_UNKNOWN: The driver can not determine whether the parameter allows NULL.

Returns

SQL_SUCCESS, SQL_SUCCESS_WITH_INFO, SQL_STILL_EXECUTING, SQL_ERROR, SQL_INVALID_HANDLE

Diagnosis

SQLSTATE	Error	Description
07009	Invalid descriptor index	The value of ParameterNumber argument is smaller than 1. The value of ParameterNumber argument is bigger than the number of parameters of the related SQL statement.
08S01	Communication link failure	Before the function processing is completed, the connection between the driver and the data source is failed.
HY000	General error	It is an error without any specific SQLSTATE.
HY001	Memory allocation error	It is a memory allocation error.
HY010	Function sequence error	The function is called before SQLPrepare or SQLExecDirect. After calling SQLExecute, SQLExecDirect, then SQL_NEED_DATA is returned, and the function is called before sending all data-at-execution variables.

Description

SQL_VARCHAR should be returned to *DataTypePtr, 4000 should be returned to *ParameterSizePtr, 0 should be returned to *DecimalDigitsPtr, and SQL_NULLABLE should be returned to *NullablePtr because the driver can not provide the exact information of the parameter using the prepared SQL.

SQLDisconnect

Conformance

Introduced version: ODBC 1.0

Standards compliance: ISO 92

Overview

SQLDisconnect closes the connection related to the specific connection handle.

Syntax

```
SQLRETURN SQLDisconnect(  
    SQLHDBC    ConnectionHandle);
```

Argument

ConnectionHandle

[Input] It is the connection handle.

Returns

SQL_SUCCESS, SQL_SUCCESS_WITH_INFO, SQL_ERROR, SQL_INVALID_HANDLE, SQL_STILL_EXECUTING

Diagnosis

SQLSTATE	Error	Description
08003	Connection not open	The connection of ConnectionHandle argument is not open.
25000	Invalid transaction state	The transaction is in progress on the connection of ConnectionHandle argument. The transaction remains active.
HY000	General error	It is an error without any specific SQLSTATE.
HY001	Memory allocation error	It is a memory allocation error.

Description

If the application calls `SQLDisconnect` to the connection handle with an incomplete transaction, the driver returns `SQLSTATE 25000` (Invalid transaction state), the transaction is not changed, and the connection is open. The incomplete transaction is a transaction which is not committed or rolled back by using `SQLEndTran`.

If the application calls `SQLDisconnect` before disconnecting all statements, the driver is disconnected from the data source, then deletes all statements and the descriptor explicitly assigned to the connection handle.

SQLDriverConnect

Conformance

Introduced version: ODBC 1.0

Standards compliance: ODBC

Overview

SQLDriverConnect can replace SQLConnect, and it supports the data source which requires more information of connection than three arguments of SQLConnect.

SQLDriverConnect establishes the connection by using the connection string which includes other information required by the data source name, one or more users, one or more passwords and the data sources.

When the connection is established, SQLDriverConnect returns the completed connection string. The application can use this string when requesting the next connection.

Syntax

```
SQLRETURN SQLDriverConnect(  
    SQLHDBC          ConnectionHandle,  
    SQLHWND          WindowHandle,  
    SQLCHAR *        InConnectionString,  
    SQLSMALLINT      StringLength1,  
    SQLCHAR *        OutConnectionString,  
    SQLSMALLINT      BufferLength,  
    SQLSMALLINT *    StringLength2Ptr,  
    SQLUSMALLINT     DriverCompletion);
```

Arguments

ConnectionHandle

[Input] It is the connection handle.

WindowHandle

[Input] It is the window handle. The application passes the superordinate window handle or a null pointer, and for the null pointer, SQLDriverConnect does not display the dialog box.

InConnectionString

[Input] It is the full connection string, partial connection string or empty string.

StringLength1

[Input] It is the length of *InConnectionString.

OutConnectionString

[Output] It is the buffer pointer of the completed connection string. If it is successfully connected to the target data source, the buffer contains the completed connection string. The application should allocate a buffer with at least 1,024 characters.

If OutConnectionString is NULL, the total number of returnable characters are returned in StringLength2Ptr (excluding null termination character).

BufferLength

[Input] It is the length of *OutConnectionString

StringLength2Ptr

[Output] It is the buffer pointer which returns the total number of returnable characters to *OutConnectionString (excluding null termination character). If the returnable length is equal to or bigger than BufferLength, *OutConnectionString is truncated to the length of BufferLength minus a null-termination character.

DriverCompletion

[Input] It is a flag that indicates whether the driver has to request more information. the value is one of SQL_DRIVER_PROMPT, SQL_DRIVER_COMPLETE, SQL_DRIVER_COMPLETE_REQUIRED, SQL_DRIVER_NOPROMPT.

Returns

SQL_SUCCESS, SQL_SUCCESS_WITH_INFO, SQL_NO_DATA, SQL_ERROR, SQL_INVALID_HANDLE, SQL_S
TILL_EXECUTING

Diagnosis

SQLSTATE	Error	Description
01004	String data, right truncated	*OutConnectionString buffer is not large enough to return the entire connection string, so the connection string is truncated. The connection string length not truncated is returned in *StringLength2Ptr. (The function returns SQL_SUCCESS_WITH_INFO.)
08001	Client unable to establish connection	The driver can not establish a connection with the data source.
08002	Connection name in use	The specified ConnectionHandle is already connected with a data source.

SQLSTATE	Error	Description
08004	Server rejected the connection	In the state of the limits of the setting value, the data source rejects to establish the connection.
08S01	Communication link failure	Before the function processing is completed, the connection between the driver and the data source is failed.
28000	Invalid authorization specification	The user identifier and authentication string of the connection string are not correct.
HY000	General error	It is an error without any specific SQLSTATE.
HY001	Memory allocation error	It is a memory allocation error.
HY090	Invalid string or buffer length	The value of StringLength1 argument is smaller than 0, but it is not SQL_NTS. The value of BufferLength argument is smaller than 0.
HY110	Invalid driver completion	The value of DriverCompletion argument is not one of SQL_DRIVER_PROMPT, SQL_DRIVER_COMPLETE, SQL_DRIVER_COMPLETE_REQUIRED, SQL_DRIVER_NOPROMPT.
HYC00	Optional feature not implemented	The driver does not support the ODBC operation which is required by the application.
HYT00	Timeout expired	Before connecting to the data source, login timeout is expired. The timeout can be set through SQL_ATTR_LOGIN_TIMEOUT of SQLSetConnectAttr.

Description

The syntax of connection string is as follows.

```

connection-string ::= empty-string[;] | attribute[;] | attribute; connection-string
empty-string ::= attribute ::= attribute-keyword=attribute-value | DRIVER={{attribute-value}}
attribute-keyword ::= DSN | PROTOCOL | CS_MODE | HOST | PORT | UID | PWD | ALTERNATE_SERVERS |
FAILOVER_TYPE | FAILOVER_GANULARITY | DATE_FORMAT | TIME_FORMAT | TIME_WITH_TIME_ZONE_FORMAT
| TIMESTAMP_FORMAT | TIMESTAMP_WITH_TIME_ZONE_FORMAT | CHAR_LENGTH_UNITS | CONN_NAME
attribute-value ::= character-string

```

character-string is zero or more characters. attribute-keyword is case-insensitive, and attribute-value may be case-sensitive. The value of DSN keyword does not consist only of white spaces.

The following table describes attribute-keywords.

Keyword	Description
DSN	It is the data source name.
PROTOCOL	It is the connection type (DA, TCP).
CS_MODE	It sets whether to connect with dedicated mode or shared mode. If the setting is not used, the mode is determined depending on the configuration (DE

Keyword	Description
	FAULT_CS_MODE) of listener.
HOST	It is the host IP address.
PORT	It is the connection port number.
TCP_NODELAY	It is a socket TCP_NODELAY option.
UID	It is the user ID.
PWD	It is the password for user ID. If password does not exist, it is an empty string (PWD=;).
ALTERNATE_SERVERS	It is a server list which attempts a connection when the failover occurs, and each server is separated with comma (,). If failover is not used, ALTERNATE_SERVERS is not set.
FAILOVER_TYPE	<ul style="list-style-type: none"> • CONNECTION: When the connection fails, it is connected to ALTERNATE_SERVERS. • SESSION: When the connection fails or the connection is disconnected during operating the statement, it is connected to ALTERNATE_SERVERS and the statement is restored. The statement is executed after the failover if the connection is disconnected when a transaction is not in progress.
FAILOVER_GRANULARITY	<ul style="list-style-type: none"> • 0: Failover proceeds even when an error occurs during the failover. • 1: Failover fails when an error occurs except for SQLExecute(), SQLExecDirect() during the failover. • 2: Failover fails when an error occurs during the failover.
DATE_FORMAT	It is the DATE type format string.
TIME_FORMAT	It is the TIME type format string.
TIME_WITH_TIME_ZONE_FORMAT	It is the TIME WITH TIME ZONE type format string.
TIMESTAMP_FORMAT	It is the TIMESTAMP type format string.
TIMESTAMP_WITH_TIME_ZONE_FORMAT	It is the TIMESTAMP WITH TIME ZONE type format string.
CHAR_LENGTH_UNITS	If ParameterType is one of SQL_CHAR or SQL_VARCHAR in SQLBindParameter(), it is a unit of ColumnSize. <ul style="list-style-type: none"> • BYTE, OCTETS: Bytes unit • CHAR, CHARACTERS: Characters unit
CONN_NAME	It is the connection name used in XA. The specified name is valid only in embedded SQL program, and is ignored in other programs.

SQLEndTran

Conformance

Introduced version: ODBC 3.0

Standards compliance: ISO 92

Overview

SQLEndTran requests a commit or rollback for active transactions of all statements related to the connection.

Syntax

```
SQLRETURN SQLEndTran(  
    SQLSMALLINT  HandleType,  
    SQLHANDLE     Handle,  
    SQLSMALLINT  CompletionType);
```

Arguments

HandleType

[Input] It is the handle identifier. If it is an environment handle it is SQL_HANDLE_ENV, and if it is a connection handle it is SQL_HANDLE_DBC.

Handle

[Input] It is the handle of HandleType which indicates the transaction range.

CompletionType

[Input] It is SQL_COMMIT or SQL_ROLLBACK.

Returns

SQL_SUCCESS, SQL_SUCCESS_WITH_INFO, SQL_ERROR, SQL_INVALID_HANDLE, SQL_STILL_EXECUTING

Diagnosis

SQLSTATE	Error	Description
08003	Connection not o	HandleType is SQL_HANDLE_DBC, and a handle is not connected.

SQLSTATE	Error	Description
	pen	
HY000	General error	It is an error without any specific SQLSTATE.
HY001	Memory allocation error	It is a memory allocation error.
HY010	Function sequence error	After calling SQLExecute, SQLExecDirect, then SQL_NEED_DATA is returned, and the function is called before sending all data-at-execution variables.
HY012	Invalid transaction operation code	The value of CompletionType argument is not one of SQL_COMMIT or SQL_ROLLBACK.
HY092	Invalid attribute/option identifier	The value of HandleType argument is not one of SQL_HANDLE_ENV or SQL_HANDLE_DBC.

Description

If CompletionType is SQL_COMMIT, then SQLEndTran requests the commit for all active transactions of statements related to the connection. If CompletionType is SQL_ROLLBACK, then SQLEndTran requests the rollback for all active transactions of statements related to the connection. If active transaction does not exist, SQLEndTran returns SQL_SUCCESS without affecting the data source.

If the driver is a manual commit mode(The SQL_ATTR_AUTOCOMMIT attribute is set to SQL_AUTOCOMMIT_OFF by calling SQLSetConnectAttr.) and the SQL statement is executed for the current data source, a new transaction implicitly starts.

SQLEndTran does not affect the open cursor related to the connection when committing. The cursor remains on the row pointed before calling SQLEndTran.

SQLEndTran closes all open cursors on all statements when rolling back. SQLEndTran sets the statement to the ready state, and the application does not call SQLPrepare, but it calls SQLExecute.

If an active transaction does not exist, SQLEndTran returns SQL_SUCCESS.

If the driver is an auto commit mode, SQLEndTran always returns SQL_SUCCESS regardless of CompletionType.

SQLException

Conformance

Introduced version: ODBC 1.0

Standards compliance: It is not available.

Overview

SQLException returns an error or status information.

SQLExecDirect

Conformance

Introduced version: ODBC 1.0

Standards compliance: ISO 92

Overview

If `SQLExecDirect` has the parameter in the statement, it executes the statement by using the current value of parameter marker. `SQLExecDirect` is the fastest way of when the statement is executed only once.

Syntax

```
SQLRETURN SQLExecDirect(  
    SQLHSTMT    StatementHandle,  
    SQLCHAR *   StatementText,  
    SQLINTEGER  TextLength);
```

Arguments

StatementHandle

[Input] It is the statement handle.

StatementText

[Input] It is the executed SQL statement.

TextLength

[Input] It is the length of *StatementText.

Returns

SQL_SUCCESS, SQL_SUCCESS_WITH_INFO, SQL_NEED_DATA, SQL_STILL_EXECUTING, SQL_ERROR, SQL_NO_DATA, SQL_INVALID_HANDLE, SQL_PARAM_DATA_AVAILABLE

Diagnosis

SQLSTATE	Error	Description
01004	String data, right truncated	The string or binary data returned to the input/output or output parameters are truncated. The right part of the string is truncated. (The function returns SQL_SUCCESS_WITH_INFO.)
01S02	Option value changed	<p>It is temporarily replaced with a similar value because the attribute value of the specified statement is not suitable for executing the operation. (SQLGetStmtAttr can be called to see which value is temporarily changed.) The replaced value is valid until the cursor is closed, and it is changed to the previous value when the cursor is closed.</p> <p>The statement attributes which can be changed are as follows. SQL_ATTR_CONCURRENCY, SQL_ATTR_CURSOR_TYPE, SQL_ATTR_KEYSET_SIZE, SQL_ATTR_MAX_LENGTH, SQL_ATTR_MAX_ROWS, SQL_ATTR_QUERY_TIMEOUT, SQL_ATTR_SIMULATE_CURSOR.</p> <p>(The function returns SQL_SUCCESS_WITH_INFO.)</p>
07006	Restricted data type attribute violation	<p>The data value identified by ValueType argument of SQLBindParameter can not be converted to the data type identified by ParameterType argument of SQLBindParameter.</p> <p>The data value returned to the parameter of SQL_PARAM_INPUT_OUTPUT or SQL_PARAM_OUTPUT can not be converted to the data type identified by ValueType argument of SQLBindParameter.</p> <p>(If one or more rows are successfully returned, the function returns SQL_SUCCESS_WITH_INFO.)</p>
07007	Restricted parameter value violation	The parameter type is SQL_PARAM_INPUT_OUTPUT, and *StrLen_or_IndPtr of SQLBindParameter is not one of SQL_NULL_DATA, SQL_DEFAULT_PARAMETER, SQL_LEN_DATA_AT_EXEC(len), or SQL_DATA_AT_EXEC.
08S01	Communication link failure	Before the function processing is completed, the connection between the driver and the data source is failed.
22001	String data, right truncation	The string, or binary data is truncated.
22002	Indicator variable required but not supplied	NULL data is bound to the output parameter whose StrLen_or_IndPtr of SQLBindParameter is the null pointer.
24000	Invalid cursor state	<p>The cursor is positioned in StatementHandle through SQLFetch, SQLFetchScroll.</p> <p>The cursor is open but it is not positioned in StatementHandle.</p> <p>*StatementText is the positioned update or delete statement, and the cursor</p>

SQLSTATE	Error	Description
		is positioned before the start or after the end of the result set.
HY000	General error	It is an error without any specific SQLSTATE.
HY001	Memory allocation error	It is a memory allocation error.
HY009	Invalid use of null pointer	*StatementText is the null pointer.
HY010	Function sequence error	After calling SQLExecute, SQLExecDirect, then SQL_NEED_DATA is returned and the function is called before sending all data-at-execution variables.
HY090	Invalid string or buffer length	The argument value of TextLength is smaller than 0, but it is not SQL_NTS. The parameter value set by SQLBindParameter is the null pointer, and the parameter length is not 0, SQL_NULL_DATA, SQL_DATA_AT_EXEC, SQL_DEFAULT_PARAM, or less than SQL_LEN_DATA_AT_EXEC_OFFSET. The parameter value set by SQLBindParameter is not the null pointer, and C data type is SQL_C_BINARY or SQL_C_CHAR, and the parameter length is smaller than 0, but it is not less than SQL_NTS, SQL_NULL_DATA, SQL_DATA_AT_EXEC, SQL_DEFAULT_PARAM, or equal to or less than SQL_LEN_DATA_AT_EXEC_OFFSET.
HYT00	Timeout expired	Before returning the result set from the data source, the query timeout is expired. The timeout can be set through SQL_ATTR_QUERY_TIMEOUT of SQLSetStmtAttr.

Description

The application sends the SQL statement to the data source by calling SQLExecDirect.

The application can include one or more parameter markers in an SQL statement. The application should include a question mark (?) on the appropriate position of SQL statement to include a parameter marker.

If the SQL statement is the SELECT statement and the application connects the cursor with SQLSetCursorName, the driver uses the specified cursor. If the application does not connect the statement and the cursor, then the driver creates a cursor name.

If the data source is the manual commit mode, and the transaction has not yet been started, the driver starts the transaction before sending the SQL statement.

If SQLExecDirect finds the parameter of data-at-execution, it returns SQL_NEED_DATA. The application transmits data by using SQLParamData and SQLPutData.

If SQLExecDirect executes the statement such as searched update, insert, or delete, but rows have not been changed on the data source, then calling SQLExecDirect returns SQL_NO_DATA.

If the attribute value of `SQL_ATTR_PARAMSET_SIZE` statement is bigger than 1, and the SQL statement includes at least one parameter marker character, then `SQLExecDirect` executes the SQL statement once per a parameter set in the array pointed by `ParameterValuePtr` argument of `SQLBindParameter`.

SQLExecute

Conformance

Introduced version: ODBC 1.0

Standards compliance: ISO 92

Overview

If a statement includes a parameter, `SQLExecute` performs the prepared statement by using the current value of the parameter marker.

Syntax

```
SQLRETURN SQLExecute(
    SQLHSTMT    StatementHandle);
```

Arguments

StatementHandle

[Input] It is the statement handle.

Returns

`SQL_SUCCESS`, `SQL_SUCCESS_WITH_INFO`, `SQL_NEED_DATA`, `SQL_STILL_EXECUTING`, `SQL_ERROR`, `SQL_NO_DATA`, `SQL_INVALID_HANDLE`, `SQL_PARAM_DATA_AVAILABLE`

Diagnosis

SQLSTATE	Error	Description
01004	String data, right truncated	The string or binary data returned to the input/output or output parameters are truncated. The right part of the string is truncated. (The function returns <code>SQL_SUCCESS_WITH_INFO</code> .)
01S02	Option value	It is temporarily replaced with a similar value because the attribute value of the specified statement is not suitable for executing the operation. (<code>SQLGetStmtAttr</code> can be called to see which value is temporarily changed.) The replaced value is valid until the cursor is closed, and it is changed to the previous value when the cursor is closed.

SQLSTATE	Error	Description
	changed	<p>The statement attributes which can be changed are as follows. SQL_ATTR_CONCURRENCY, SQL_ATTR_CURSOR_TYPE, SQL_ATTR_KEYSET_SIZE, SQL_ATTR_MAX_LENGTH, SQL_ATTR_MAX_ROWS, SQL_ATTR_QUERY_TIMEOUT, SQL_ATTR_SIMULATE_CURSOR.</p> <p>(The function returns SQL_SUCCESS_WITH_INFO.)</p>
07006	Restricted data type attribute violation	<p>The data value identified by ValueType argument of SQLBindParameter can not be converted to the data type identified by ParameterType argument of SQLBindParameter.</p> <p>The data value returned to the parameter of SQL_PARAM_INPUT_OUTPUT or SQL_PARAM_OUTPUT can not be converted to the data type identified by ValueType argument of SQLBindParameter.</p> <p>(If one or more rows are successfully returned, the function returns SQL_SUCCESS_WITH_INFO.)</p>
07007	Restricted parameter value violation	The parameter type is SQL_PARAM_INPUT_OUTPUT, and *StrLen_or_IndPtr of SQLBindParameter is not one of SQL_NULL_DATA, SQL_DEFAULT_PARAMETER, SQL_LEN_DATA_AT_EXEC(len), or SQL_DATA_AT_EXEC.
08S01	Communication link failure	Before the function processing is completed, the connection between the driver and the data source is failed.
22001	String data, right truncation	The string, or binary data is truncated.
22002	Indicator variable required but not supplied	NULL data is bound to the output parameter whose StrLen_or_IndPtr of SQLBindParameter is the null pointer.
24000	Invalid cursor state	<p>The cursor is positioned in StatementHandle through SQLFetch, SQLFetchScroll.</p> <p>The cursor is open but it is not positioned in StatementHandle.</p> <p>*StatementText is the positioned update or delete statement, and the cursor is positioned before the start or after the end of the result set.</p>
HY000	General error	It is an error without any specific SQLSTATE.
HY001	Memory allocation error	It is a memory allocation error.
HY009	Invalid use of null pointer	*StatementText is the null pointer.
HY010	Function sequence error	After calling SQLExecute, SQLExecDirect, then SQL_NEED_DATA is returned and the function is called before sending all data-at-execution variables.
		The argument value of TextLength is smaller than 0, but it is not SQL_NTS.

SQLSTATE	Error	Description
HY090	Invalid string or buffer length	<p>The parameter value set by SQLBindParameter is the null pointer, and the parameter length is not 0, SQL_NULL_DATA, SQL_DATA_AT_EXEC, SQL_DEFAULT_PARAM, or less than SQL_LEN_DATA_AT_EXEC_OFFSET.</p> <p>The parameter value set by SQLBindParameter is not the null pointer, and C data type is SQL_C_BINARY or SQL_C_CHAR, and the parameter length is smaller than 0, but it is not less than SQL_NTS, SQL_NULL_DATA, SQL_DATA_AT_EXEC, SQL_DEFAULT_PARAM, or equal to or less than SQL_LEN_DATA_AT_EXEC_OFFSET.</p>
HYT00	Timeout expired	Before returning the result set from the data source, the query timeout is expired. The timeout can be set through SQL_ATTR_QUERY_TIMEOUT of SQLSetStmtAttr.

Description

SQLExecute executes the statement prepared by SQLPrepare. The application can call SQLExecute again with the new parameter value after it discards the result of calling SQLExecute.

To execute SELECT statement once or more, the application should call SQLCloseCursor before executing SELECT statement again.

If the data source is a manual commit mode, and the transaction has not yet been started, the driver starts the transaction before sending the SQL statement.

If SQLExecute finds a data-at-execution parameter, it returns SQL_NEED_DATA. The application sends data by using SQLParamData and SQLPutData.

If SQLExecute executes the statement such as searched update, insert, or delete, but rows have not been changed on the data source, calling SQLExecute returns SQL_NO_DATA.

If the attribute value of SQL_ATTR_PARAMSET_SIZE statement is bigger than 1, and the SQL statement includes at least one parameter marker character, then SQLExecute executes the SQL statement once per a parameter set in the array pointed by ParameterValuePtr argument of SQLBindParameter.

SQLExtendedFetch

Conformance

Introduced version: ODBC 1.0.

Standards compliance: It is not available.

Overview

SQLExtendedFetch fetches the specified data set from the result set, and returns it to all bound columns.

Syntax

```
SQLRETURN SQLExtendedFetch(  
    SQLHSTMT          StatementHandle,  
    SQLUSMALLINT      FetchOrientation,  
    SQLLEN            FetchOffset,  
    SQLULEN *         RowCountPtr,  
    SQLUSMALLINT *    RowStatusArray);
```

SQLFetch

Conformance

Introduced version: ODBC 1.0

Standards compliance: ISO 92

Overview

SQLFetch fetches the next row set from the result set, and returns it to all columns bound.

Syntax

```
SQLRETURN SQLFetch(
    SQLHSTMT StatementHandle);
```

Arguments

StatementHandle

[Input] It is the statement handle.

Returns

SQL_SUCCESS, SQL_SUCCESS_WITH_INFO, SQL_NO_DATA, SQL_STILL_EXECUTING, SQL_ERROR, SQL_INVALID_HANDLE

Diagnosis

SQLSTATE	Error	Description
01004	String data, right truncated	The string, binary data returned for the columns are truncated. The right part of the string is truncated.
01S07	Fractional truncation	The data returned for the column is truncated. For numeric data types, the decimal place is truncated. For time, timestamp, interval data types which contain the period component, the decimal place of time is truncated. (The function returns SQL_SUCCESS_WITH_INFO.)
07006	Restricted data type attribute violation	The column data value in the result set can not be converted to the data type specified by TargetType of SQLBindCol.

SQLSTATE	Error	Description
08S01	Communication link failure	Before the function processing is completed, the connection between the driver and the data source is failed.
22002	Indicator variable required but not supplied	StrLen_or_IndPtr (or SQL_DESC_INDICATOR_PTR set by SQLSetDescField or SQLSetDescRec) of SQLBindCol fetches NULL data to the column which is the null pointer.
22003	Numeric value out of range	The integer part (not the decimal place) of the numerical value returned from one or more columns is truncated.
22007	Invalid datetime format	The string in the result set is not the valid date, time, timestamp format.
22012	Division by zero	The result of the arithmetic expression divided by 0 is returned.
22015	Interval field overflow	When the interval C type is specified in the exact numeric or interval SQL data type, the significant figures in the leading field is lost. The value of SQL type can not be expressed to C interval type.
22018	Invalid character value for cast specification	The character not represented as the character set of C buffer is included in the character column of the result set. The C type is the exact or approximate numeric, datetime, interval data type, and if the SQL type is the character data type, the value of the column bound to the C type is not valid.
24000	Invalid cursor state	StatementHandle is executed but the result set related to StatementHandle does not exist.
HY000	General error	It is an error without any specific SQLSTATE.
HY001	Memory allocation error	It is a memory allocation error.
HY010	Function sequence error	The StatementHandle specified is not at the state of running. The function is called without calling SQLExecDirect, SQLExecute, the catalog function. After calling SQLExecute, SQLExecDirect, then SQL_NEED_DATA is returned and the function is called before sending all data-at-execution variables.
HYT00	Timeout expired	Before returning the result set from the data source, the query timeout is expired. The timeout can be set through SQL_ATTR_QUERY_TIMEOUT of SQLSetStmtAttr.

Description

SQLFetch returns the next data set from the result set. SQLFetch can be called while the result set exists, which is after the result set is created and before the cursor is closed. If the column is bound, the data is returned to the column. If the application specifies the pointer to a row status array or specifies the buffer which returns the number of fetched rows, SQLFetch also returns this information. SQLFetch and SQLFetchScroll can be called being mixed together.

Cursor Position

If the result set is generated, the cursor is positioned before the start of result set. SQLFetch fetches the next row set. It is as same as calling SQLFetchScroll which FetchOrientation is set to SQL_FETCH_NEXT.

The attribute of SQL_ATTR_ROW_ARRAY_SIZE statement specifies the number of rows in the row set. If the row set fetched by SQLFetch overlaps with the end of result set, SQLFetch returns a partial row set. If S is the start row of fetched row set, R is the size of row set, L is the last row of result set, $S + R - 1$ is bigger than L, then only the first $L - S + 1$ rows of row set is valid. All remaining rows are empty, and it becomes the SQL_ROW_NOROW state.

After returning SQLFetch, the current row is the first row of row set.

The rules in the following table describes the cursor position according to the conditions in the second table of the session after calling SQLFetch.

Status	The first row of new row set
Before start	1
$\text{CurrRowsetStart} \leq \text{LastResultRow} - \text{RowsetSize}$ [1]	$\text{CurrRowsetStart} + \text{RowsetSize}$ [2]
$\text{CurrRowsetStart} > \text{LastResultRow} - \text{RowsetSize}$ [1]	After end
After end	After end

[1] If the row set size is changed during fetching, the row set size is the row set size used before fetching.

[2] If the row set size is changed during fetching, the row set size is the row set size used in new fetch.

Notation	Description
Before start	The block cursor is positioned before the start of result set. If the first row of new row set is before the start of result set, SQLFetch returns SQL_NO_DATA.
After end	The block cursor is positioned after the end of result set. If the first row of new row set is after the end of result set, SQLFetch returns SQL_NO_DATA.
CurrRowsetStart	It is the first row number of the current row set.
LastResultRow	It is the last row number of result set.
RowsetSize	It is the row set size.

The following is an example of when 100 rows exist in the result set and the row set size is 5, then the following table describes the row set and the return code returned by SQLFetch for the different start position.

Current row set	Return code	New row set	The number of fetched rows
Before start	SQL_SUCCESS	1 to 5	5
1 to 5	SQL_SUCCESS	6 to 10	5
52 to 56	SQL_SUCCESS	57 to 61	5

Current row set	Return code	New row set	The number of fetched rows
91 to 95	SQL_SUCCESS	96 to 100	5
93 to 97	SQL_SUCCESS	98 to 100 4,5 rows of the row status array are set to SQL_ROW_NOROW.	3
96 to 100	SQL_NO_DATA	None	0
99 to 100	SQL_NO_DATA	None	0
After end	SQL_NO_DATA	None	0

Returning the Data in the Bound Column

Like as SQLFetch returns each row, it inserts the data into each bound column in the buffer bound to the column. If the bound column does not exist, SQLFetch does not return any data, but it does not move the cursor forward. Data can be continuously fetched through SQLGetData. If the cursor is a multiple row cursor (SQL_ATTR_ROW_ARRAY_SIZE is bigger than 1.), SQLGetData can be called when after setting InfoType of SQLGetInfo to SQL_FETDATA_EXTENSIONS, or when returning SQL_GD_BLOCK.

For more information, refer to **SQLGetData**.

SQLFetch executes the followings for each bound columns in the row.

1. If data is NULL, the length/indicator buffer is set to SQL_NULL_DATA and the next row is processed. If the data is NULL and the length/indicator buffer is not bound, SQLFetch returns SQLSTATE 22002 (Indicator variable required but not supplied) for the row and the next row to be processed. For more information about how to determine the address of the length/indicator, refer to **Buffer Address** of SQLBindCol. If the column data is not NULL, SQLFetch executes the process number 2.
2. If the attribute of SQL_ATTR_MAX_LENGTH statement is set to non-zero and the column includes the character or binary data, the data is truncated to the length of SQL_ATTR_MAX_LENGTH in bytes.



The attribute of SQL_ATTR_MAX_LENGTH statement is intended to reduce network traffic. It is usually implemented by the data source, and the data is truncated before the data is returned from the network. Drivers and data sources are not required to support it. Therefore, the application should specify the size to cbValueMax argument of SQLBindCol and creates the buffer to guarantee that the data is truncated to the specific size.

3. The data is converted to the format specified in TargetType of SQLBindCol.
4. If the data is converted to the variable length data type such as a string or binary, SQLFetch confirms if the data length exceeds the data buffer length. If the character data (including NULL termination character) exceeds the data buffer length, SQLFetch truncates the data to the data buffer length which is smaller than NULL termination character length. In this case, the data is terminated by NULL. If the binary data length exceeds the data buffer length, SQLFetch truncates the data to the data buffer

length. The data buffer length is specified in `BufferLength` of `SQLBindCol`. `SQLFetch` never truncates the data converted to the fixed length data format because the data buffer length is always equal to the data type length.

5. The converted data (truncated data if possible) is put in the data buffer. For more information about how to determine the data buffer address, refer to **Buffer Address** of `SQLBindCol`.
6. The data length is put in the length/indicator buffer. If both the length pointer and indicator pointer are set in the same buffer (by calling `SQLBindCol`), the valid data length is recorded in the buffer, and `SQL_NULL_DATA` is recorded in the buffer if the data is NULL. If the length/indicator buffer is not bound, `SQLFetch` does not return the length.
 - For the character or binary data, it is the data length before truncated after the data is converted because of too small buffer size. If the driver can not determine the length of too long data after conversion, the length is set to `SQL_NO_TOTAL`. If the data is truncated due to the attribute of `SQL_ATTR_MAXIMUM_LENGTH` statement, this attribute value is put in the length/indicator buffer instead of the actual length. It is because the attribute is designed to truncate the data in the server before conversion. So, the driver can not calculate the actual length.
 - For all other data types, it is the data length after conversion.
7. If the data is truncated without any loss of significant digits during conversion (for example, the real number 1.234 is converted into 1 by truncation.), `SQLFetch` returns `SQLSTATE 01S07` (Fractional truncation) and `SQL_SUCCESS_WITH_INFO`. If the data is truncated because the data buffer length is too small (for example the string "abcdef" is put in the buffer of four bytes.), `SQLFetch` returns `SQLSTATE 01004` (Data truncated) and `SQL_SUCCESS_WITH_INFO`. If the data is truncated because of the attribute of `SQL_ATTR_MAXIMUM_LENGTH` statement, `SQLFetch` returns `SQL_SUCCESS` and it does not return `SQLSTATE 01S07` (Fractional truncation) nor `SQLSTATE 01004` (Data truncated). If the significant digits of data is truncated while the data is converted (for example, the value of `SQL_INTEGER` which is bigger than 100,000 is converted into `SQL_C_TINYINT`.), `SQLFetch` returns `SQLSTATE 22003` (Numeric value out of range), `SQL_ERROR` (if the row set size is 1.) or `SQL_SUCCESS_WITH_INFO` (if the row set size is bigger than 1.).

If `SQLFetch`, `SQL_SUCCESS` of `SQLFetchScroll`, or `SQL_SUCCESS_WITH_INFO` is not returned, then the contents of the bound data buffer and the length/indicator buffer are not defined.

Row Status Array

The row status array is used to return the status of each row set. The array address is specified in the attribute of `SQL_ATTR_ROW_STATUS_PTR` statement. The array should assign the elements as many as specified by the attribute of `SQL_ATTR_ROW_ARRAY_SIZE` statement in the application. The value is set by `SQLFetch`, `SQLFetchScroll`, `SQLBulkOperations` or `SQLSetPos`. If the attribute value of `SQL_ATTR_ROW_STATUS_PTR` statement is the null pointer, the function does not return the row status.

The content of row status buffer is not defined if `SQL_SUCCESS` or `SQL_SUCCESS_WITH_INFO` is not returned by `SQLFetch`, `SQLFetchScroll`.

The following values are returned to the row status array.

The value of row status array	Description
SQL_ROW_SUCCESS	The row is successfully fetched, and it is not changed after the last fetch from the result set.
SQL_ROW_SUCCESS_WITH_INFO	The row is successfully fetched, and it is not changed after the last fetch from the result set. But the warning about the row is returned.
SQL_ROW_ERROR	An error occurs while the row is fetched.
SQL_ROW_UPDATED	The row is successfully fetched, and it is changed after the last fetch from the result set. If the row is fetched again or it is refreshed by SQLSetPos. Status is changed to the new row status.
SQL_ROW_DELETED	It is deleted after the row is fetched last from the result set.
SQL_ROW_NOROW	The row set is overlapped with the end of result set, and returns that there is not a row.

Row Fetch Buffer

The row fetch buffer is used to return the number of fetched rows. When the data is fetched, the row without data due to an error is also included. It is the number of rows which is not SQL_ROW_NOROW value in the row status array. This buffer address is specified in the attribute of SQL_ATTR_ROWS_FETCHED_PTR statement. The buffer is allocated by the application, and it is set by SQLFetch, SQLFetchScroll. If the attribute value of SQL_ATTR_ROWS_FETCHED_PTR statement is the null pointer, the function does not return the number of fetched rows. The application calls SQLGetStmtAttr as the attribute of SQL_ATTR_ROW_NUMBER to determine the number of current rows in the result set.

The content of row fetch buffer is not defined if SQLFetch, SQLFetchScroll does not return SQL_SUCCESS or SQL_SUCCESS_WITH_INFO. If SQL_NO_DATA is returned, the value of row fetch buffer is set to 0.

Error Processing

Errors and warnings can be applied to the individual row or the entire function.

Error and Warning for Entire Function

If the error is applied to the entire function, like as SQLSTATE HYT00 (Timeout expired) or SQLSTATE 24000 (Invalid cursor state), SQLFetch returns SQL_ERROR and the corresponding SQLSTATE. The content of row buffer is not defined and the cursor position is not changed.

If the warning is applied to the entire function, SQLFetch returns SQL_SUCCESS_WITH_INFO and the corresponding SQLSTATE. The warning applied to the entire function is returned before the state is recorded to each row.

Error and Warning for Individual Row

The error such as SQLSTATE 22012 (division by zero) or the warning such as SQLSTATE 01004 (data truncated) is applied to the individual row.

SQLFetch executes the followings.

- It sets the element of row status array to SQL_ROW_ERROR for an error or SQL_ROW_SUCCESS_WITH_INFO for a warning.
- It adds one or more records which includes SQLSTATE for the error or warning.
- It sets the row and column number fields in the status record. If SQLFetch can not determine the row or column number, it sets each number to SQL_ROW_NUMBER_UNKNOWN or SQL_COLUMN_NUMBER_UNKNOWN. If the status record is not applied to the specified column, SQLFetch sets the column number to SQL_NO_COLUMN_NUMBER.

If an error occurs in all rows of the row set (excluding the row in SQL_ROW_NOROW status), SQLFetch returns SQL_ERROR. If an error occurs in some rows, it returns SQL_SUCCESS_WITH_INFO. If the row set size is 1 and an error occurs in the row, SQLFetch returns SQL_ERROR.

Descriptor and SQLFetch

SQLFetch uses the following descriptor fields.

Descriptor field	Descriptor	Field location	Setting
SQL_DESC_ARRAY_SIZE	ARD	header	SQL_ATTR_ROW_ARRAY_SIZE statement attribute
SQL_DESC_ARRAY_STATUS_PTR	IRD	header	SQL_ATTR_ROW_STATUS_PTR statement attribute
SQL_DESC_BIND_OFFSET_PTR	ARD	header	SQL_ATTR_ROW_BIND_OFFSET_PTR statement attribute
SQL_DESC_BIND_TYPE	ARD	header	SQL_ATTR_ROW_BIND_TYPE statement attribute
SQL_DESC_COUNT	ARD	header	ColumnNumber argument of SQLBindCol
SQL_DESC_DATA_PTR	ARD	record	TargetValuePtr argument of SQLBindCol
SQL_DESC_INDICATOR_PTR	ARD	record	StrLen_or_IndPtr argument of SQLBindCol
SQL_DESC_OCTET_LENGTH	ARD	record	BufferLength argument of SQLBindCol
SQL_DESC_OCTET_LENGTH_PTR	ARD	record	StrLen_or_IndPtr argument of SQLBindCol
SQL_DESC_ROWS_PROCESSED_PTR	IRD	record	SQL_ATTR_ROWS_FETCHED_PTR statement attribute
SQL_DESC_TYPE	ARD	record	TargetType argument of SQLBindCol

All descriptor fields can be set through SQLSetDescField.

Separating Length and Indicator Buffer

The application can bind one or two buffers to store the length and indicator value. If the application calls `SQLBindCOL`, `SQL_DESC_OCTET_LENGTH_PTR` and `SQL_DESC_INDICATOR_PTR` field of `ARD` is set in the address passed to `StrLen_or_IndPtr` argument. The application can set the two fields to another addresses by calling `SQLSetDescField` or `SQLSetDescRec`.

`SQLFetch` determines whether the application specifies a separate length and indicator buffer. If the data is not `NULL`, `SQLFetch` sets the indicator buffer to 0, and returns the length to the length buffer. If the data is `NULL`, `SQLFetch` sets the indicator buffer to `SQL_NULL_DATA`, and it does not modify the length buffer.

SQLFetchScroll

Conformance

Introduced version: ODBC 3.0

Standards compliance: ISO 92

Overview

SQLFetchScroll fetches the specified data set from the result set, and returns it to all bound columns.

Syntax

```
SQLRETURN SQLFetchScroll(  
    SQLHSTMT      StatementHandle,  
    SQLSMALLINT   FetchOrientation,  
    SQLLEN        FetchOffset);
```

Arguments

StatementHandle

[Input] It is the statement handle.

FetchOrientation

[Input] It is the fetch type: SQL_FETCH_NEXT, SQL_FETCH_PRIOR, SQL_FETCH_FIRST, SQL_FETCH_LAST, SQL_FETCH_ABSOLUTE, SQL_FETCH_RELATIVE, SQL_FETCH_BOOKMARK

FetchOffset

[Input] It is the number of rows to fetch. The interpretation of this argument depends on the value of FetchOrientation argument.

Returns

SQL_SUCCESS, SQL_SUCCESS_WITH_INFO, SQL_NO_DATA, SQL_STILL_EXECUTING, SQL_ERROR, SQL_INVALID_HANDLE

Diagnosis

SQLSTATE	Error	Description
01004	String data, right truncated	The string, binary data returned for the columns are truncated. The right part of the string is truncated.
01S07	Fractional truncation	The data returned for the column is truncated. For numeric data types, the decimal place is truncated. For time, timestamp, interval data types which contain the period component, the decimal place of time is truncated. (The function returns SQL_SUCCESS_WITH_INFO.)
07006	Restricted data type attribute violation	The column data value in the result set can not be converted to the data type specified by TargetType of SQLBindCol.
08S01	Communication link failure	Before the function processing is completed, the connection between the driver and the data source is failed.
22002	Indicator variable required but not supplied	StrLen_or_IndPtr (or SQL_DESC_INDICATOR_PTR set by SQLSetDescField or SQLSetDescRec) of SQLBindCol fetches NULL data to the column which is the null pointer.
22003	Numeric value out of range	The integer part (not the decimal place) of the numerical value returned from one or more columns is truncated.
22007	Invalid datetime format	The string in the result set is not the valid date, time, timestamp format.
22012	Division by zero	The result of the arithmetic expression divided by 0 is returned.
22015	Interval field overflow	When the interval C type is specified in the exact numeric or interval SQL data type, the significant figures in the leading field is lost. The value of SQL type can not be expressed to C interval type.
22018	Invalid character value for cast specification	The character not represented as the character set of C buffer is included in the character column of the result set. The C type is the exact or approximate numeric, datetime, interval data type, and if the SQL type is the character data type, the value of the column bound to the C type is not valid.
24000	Invalid cursor state	StatementHandle is executed but the result set related to StatementHandle does not exist.
HY000	General error	It is an error without any specific SQLSTATE.
HY001	Memory allocation error	It is a memory allocation error.
HY010	Function sequence error	The StatementHandle specified is not at the state of running. The function is called without calling SQLExecDirect, SQLExecute, the catalog function. After calling SQLExecute, SQLExecDirect, then SQL_NEED_DATA is returned and the function is called before sending all data-at-execution variables.
		The value specified to FetchOrientation argument is not valid.

SQLSTATE	Error	Description
HY106	Fetch type out of range	The attribute value of SQL_ATTR_CURSOR_TYPE statement is SQL_CURSOR_FORWARD_ONLY, and the value of FetchOrientation argument is not SQL_FETCH_NEXT. The attribute value of SQL_ATTR_CURSOR_SCROLLABLE statement is SQL_NONSCROLLABLE, and the value of FetchOrientation argument is not SQL_FETCH_NEXT.
HYT00	Timeout expired	Before returning the result set from the data source, the query timeout is expired. The timeout can be set through SQL_ATTR_QUERY_TIMEOUT of SQLSetStmtAttr.

Description

SQLFetchScroll returns the specified row set in the result set. The row set is set as the absolute or relative position or the bookmark position. SQLFetchScroll can be called while the result set exists, which is after the result set is created and before the cursor is closed. If the column is bound, the data is returned to the column. If the application specifies the pointer to a row status array or specifies the buffer which returns rows fetched, SQLFetchScroll also returns this information. SQLFetch and SQLFetchScroll can be called being mixed together.

Cursor Position

If the result set is created, the cursor is positioned before the start of result set. SQLFetchScroll positions the block cursor according to FetchOrientation argument and FetchOffset argument as follows. The following rules are used to determine the beginning of new row set.

FetchOrientation	Description
SQL_FETCH_NEXT	It returns the next row set. it is as same as calling SQLFetch. SQLFetchScroll ignores the value of FetchOffset.
SQL_FETCH_PRIOR	It returns the previous row set. SQLFetchScroll ignores the value of FetchOffset.
SQL_FETCH_RELATIVE	It returns the row set of FetchOffset at the beginning of current row set.
SQL_FETCH_ABSOLUTE	It returns the row set starting at FetchOffset.
SQL_FETCH_FIRST	It returns the first row set in the result set. SQLFetchScroll ignores the value of FetchOffset.
SQL_FETCH_LAST	It returns the last complete row set in the result set. SQLFetchScroll ignores the value of FetchOffset.
SQL_FETCH_BOOKMARK	It returns the row set of FetchOffset on the bookmark specified by the attribute of SQL_ATTR_FETCH_BOOKMARK_PTR statement.

The attribute of SQL_ATTR_ROW_ARRAY_SIZE statement specifies the number of rows of the row set. If

the row set fetched by SQLFetchScroll overlaps with the end of result set, SQLFetchScroll returns a partial row set. If S is the start row of fetched row set, R is the row set size, L is the last row of result set, $S + R - 1$ is bigger than L , and the first $L - S + 1$ rows of row set is valid. All remaining rows are empty, and it becomes SQL_ROW_NOROW state.

After returning SQLFetchScroll, the current row is the first row of row set.

Cursor Position Rules

The following chapters describe rules for each FetchOrientation. The following notations are used for the rules.

Notation	Meaning
Before start	The block cursor is positioned before the start of result set. If the first row of the new row set is before the start of the result set, SQLFetchScroll returns SQL_NO_DATA.
After end	The block cursor is positioned after the end of result set. If the first row of the new row set is after the end of the result set, SQLFetchScroll returns SQL_NO_DATA.
CurrRowsetStart	It is the first row number of current row set.
LastResultRow	It is the last row number of result set.
RowsetSize	It is the row set size.
FetchOffset	It is the value of FetchOffset argument.
BookmarkRow	It is the row which corresponds to the bookmark specified by the attribute of SQL_ATTR_FETCH_BOOKMARK_PTR statement.

SQL_FETCH_NEXT

The following rule is applied.

State	The first row of the new row set
Before start	1
$\text{CurrRowsetStart} + \text{RowsetSize}[1] \leq \text{LastResultRow}$	$\text{CurrRowsetStart} + \text{RowsetSize}[1]$
$\text{CurrRowsetStart} + \text{RowsetSize}[1] > \text{LastResultRow}$	After end
After end	After end

[1] If the row set size is changed during fetching the row set size is the row set size used before fetching.

SQL_FETCH_PRIOR

The following rule is applied.

State	The first row of the new row set
Before start	Before start
$\text{CurrRowsetStart} = 1$	Before start
$1 < \text{CurrRowsetStart} \leq \text{RowsetSize}[1]$	1

State	The first row of the new row set
$\text{CurrRowsetStart} > \text{RowsetSize}[1]$	$\text{CurrRowsetStart} - \text{RowsetSize}[1]$
After end AND $\text{LastResultRow} < \text{RowsetSize}[1]$	1
After end AND $\text{LastResultRow} \geq \text{RowsetSize}[1]$	$\text{LastResultRow} - \text{RowsetSize} + 1[1]$

[1] If the row set size is changed during fetching, the row set size is the row set size used in new fetch.

SQL_FETCH_RELATIVE

The following rule is applied.

State	The first row of the new row set
(Before start AND $\text{FetchOffset} > 0$) OR (After end AND $\text{FetchOffset} < 0$)	__ [1]
BeforeStart AND $\text{FetchOffset} \leq 0$	Before start
$\text{CurrRowsetStart} = 1$ AND $\text{FetchOffset} < 0$	Before start
$\text{CurrRowsetStart} > 1$ AND $\text{CurrRowsetStart} + \text{FetchOffset} < 1$ AND $ \text{FetchOffset} > \text{RowsetSize}[2]$	Before start
$\text{CurrRowsetStart} > 1$ AND $\text{CurrRowsetStart} + \text{FetchOffset} < 1$ AND $ \text{FetchOffset} \leq \text{RowsetSize}[2]$	1
$1 \leq \text{CurrRowsetStart} + \text{FetchOffset} \leq \text{LastResultRow}$	$\text{CurrRowsetStart} + \text{FetchOffset}$
$\text{CurrRowsetStart} + \text{FetchOffset} > \text{LastResultRow}$	After end
After end AND $\text{FetchOffset} \geq 0$	After end

[1] SQLFetchScroll returns the row set as same as when FetchOrientation is set to SQL_FETCH_ABSOLUTE and it is called.

[2] If the row set size is changed during fetching, the row set size is the row set size used in new fetch.

SQL_FETCH_ABSOLUTE

The following rule is applied.

State	The first row of the new row set
$\text{FetchOffset} < 0$ AND $ \text{FetchOffset} \leq \text{LastResultRow}$	$\text{LastResultRow} + \text{FetchOffset} + 1$
$\text{FetchOffset} < 0$ AND $ \text{FetchOffset} > \text{LastResultRow}$ AND $ \text{FetchOffset} > \text{RowsetSize}[1]$	Before start
$\text{FetchOffset} < 0$ AND $ \text{FetchOffset} > \text{LastResultRow}$ AND $ \text{FetchOffset} \leq \text{RowsetSize}[1]$	1
$\text{FetchOffset} = 0$	Before start
$1 \leq \text{FetchOffset} \leq \text{LastResultRow}$	FetchOffset
$\text{FetchOffset} > \text{LastResultRow}$	After end

[1] If the row set size is changed during fetching, the row set size is the row set size used in new fetch.

SQL_FETCH_FIRST

The following rule is applied.

State	The first row of the new row set
Any	1

SQL_FETCH_LAST

The following rule is applied.

State	The first row of the new row set
$\text{RowsetSize}[1] \leq \text{LastResultRow}$	$\text{LastResultRow} - \text{RowsetSize} + 1[1]$
$\text{RowsetSize}[1] > \text{LastResultRow}$	1

[1] If the row set size is changed during fetching, the row set size is the row set size used in new fetch.

SQL_FETCH_BOOKMARK

The following rule is applied.

State	The first row of the new row set
$\text{BookmarkRow} + \text{FetchOffset} < 1$	Before start
$1 \leq \text{BookmarkRow} + \text{FetchOffset} \leq \text{LastResultRow}$	$\text{BookmarkRow} + \text{FetchOffset}$
$\text{BookmarkRow} + \text{FetchOffset} > \text{LastResultRow}$	After end

Buffer Address

SQLFetchScroll determines the data address and length/indicator buffer address in the same way as SQLFetch. For more information, refer to **Buffer Address** of SQLBindCol.

Row Status Array

SQLFetchScroll sets the row status array in the same way as SQLFetch. For more information, refer to **Row Status Array** of SQLFetch.

Row Fetch Buffer

SQLFetchScroll returns the number of rows fetched in the same way as SQLFetch. For more information, refer to **Row Fetch Buffer** of SQLFetch.

Error Processing

SQLFetchScroll returns the errors and warning in the same way as SQLFetch. For more information, refer to [Error Processing](#) of SQLFetch.

SQLForeignKeys

Conformance

Introduced version: ODBC 1.0

Standards compliance: ODBC

Overview

SQLForeignKeys returns the followings.

- The foreign key list of the specified table (the column in the specified table which refers to the the primary key of another table)
- The foreign key list of another table which refers to the primary key of the specified table

The driver returns each list as the result set.

Syntax

```
SQLRETURN SQLForeignKeys(  
    SQLHSTMT      StatementHandle,  
    SQLCHAR *     PKCatalogName,  
    SQLSMALLINT   NameLength1,  
    SQLCHAR *     PKSchemaName,  
    SQLSMALLINT   NameLength2,  
    SQLCHAR *     PKTableName,  
    SQLSMALLINT   NameLength3,  
    SQLCHAR *     FKCatalogName,  
    SQLSMALLINT   NameLength4,  
    SQLCHAR *     FKSchemaName,  
    SQLSMALLINT   NameLength5,  
    SQLCHAR *     FKTableName,  
    SQLSMALLINT   NameLength6);
```

Arguments

StatementHandle

[Input] It is the statement handle.

PKCatalogName

[Input] It is the primary key table catalog name. PKCatalogName can not include the string search pattern.

If the attribute of SQL_ATTR_METADATA_ID statement is set to SQL_TRUE, then PKCatalogName is treated as a case-insensitive identifier. If it is set to SQL_FALSE, then PKCatalogName is case-sensitive, and it is an ordinary argument literally processed.

NameLength1

[Input] It is the length of *PKCatalogName

PKSchemaName

[Input] It is the primary key table schema name. PKSchemaName can not include the string search pattern.

If the attribute of SQL_ATTR_METADATA_ID statement is set to SQL_TRUE, then PKSchemaName is treated as a case-insensitive identifier. If it is set to SQL_FALSE, then PKSchemaName is case-sensitive, and it is an ordinary argument literally processed.

NameLength2

[Input] It is the length of *PKSchemaName

PKTableName

[Input] It is the primary key table name. PKTableName can not include the string search pattern.

If the attribute of SQL_ATTR_METADATA_ID statement is set to SQL_TRUE, then PKTableName is treated as a case-insensitive identifier. If it is set to SQL_FALSE, then PKTableName is case-sensitive, and it is an ordinary argument literally processed.

NameLength3

[Input] It is the length of *PKTableName

FKCatalogName

[Input] It is the foreign key table catalog name. FKCatalogName can not include the string search pattern.

If the attribute of SQL_ATTR_METADATA_ID statement is set to SQL_TRUE, then FKCatalogName is treated as a case-insensitive identifier. If it is set to SQL_FALSE, then FKCatalogName is case-sensitive, and it is an ordinary argument literally processed.

NameLength4

[Input] It is the length of *FKCatalogName

FKSchemaName

[Input] It is the foreign key table schema name. FKSchemaName can not include the string search pattern.

If the attribute of SQL_ATTR_METADATA_ID statement is set to SQL_TRUE, FKSchemaName is treated as a case-insensitive identifier. If it is set to SQL_FALSE, FKSchemaName is case-sensitive, and it is an ordinary argument literally processed.

NameLength5

[Input] It is the length of *FKSchemaName

FKTableName

[Input] It is the foreign key table name. FKTableName can not include the string search pattern.

If the attribute of SQL_ATTR_METADATA_ID statement is set to SQL_TRUE, then FKTableName is treated as a case-insensitive identifier. If it is set to SQL_FALSE, FKTableName is case-sensitive, and it is an ordinary argument literally processed.

NameLength6

[Input] It is the length of *FKTableName

Returns

SQL_SUCCESS, SQL_SUCCESS_WITH_INFO, SQL_STILL_EXECUTING, SQL_ERROR, SQL_INVALID_HANDLE

Diagnosis

SQLSTATE	Error	Description
08S01	Communication link failure	Before the function processing is completed, the connection between the driver and the data source is failed.
24000	Invalid cursor state	SQLFetch, SQLFetchScroll are called and a cursor is open.
HY000	General error	It is an error without any specific SQLSTATE.
HY001	Memory allocation error	It is a memory allocation error.
HY009	Invalid use of null pointer	The PKTableName argument and FKTableName argument are the null pointer. The attribute value of SQL_ATTR_METADATA_ID statement is SQL_TRUE, and the arguments of PKSchemaName, FKSchemaName, PKTableName or FKTableName are the null pointer.
HY010	Function sequence error	After calling SQLExecute, SQLExecDirect, then SQL_NEED_DATA is returned and the function is called before sending all data-at-execution variables.
HY090	Invalid string or buffer length	A name length argument value is smaller than 0, but it is not SQL_NTS.
HYT00	Timeout expired	Before returning the result set from the data source, the query timeout is expired. The timeout can be set through SQL_ATTR_QUERY_TIMEOUT of SQLSetStmtAttr.

Description

If *PKTableName includes the table name, SQLForeignKeys returns a result set which includes the primary key of the specified table and all foreign keys referring it. The foreign key list of another table does not include the foreign key pointing to the unique constraint on the specified table.

If *FKTableName includes the table name, SQLForeignKeys returns the result set which contains the foreign key in the specified table pointing to the primary key of another table, and returns its primary key of another table which is referenced by them.

If both *PKTableName and *FKTableName include the table name, SQLForeignKeys returns the foreign key of the table specified in *FKTableName which refers to the primary key of the table specified in *PKTableName. The key should be one.

SQLForeignKeys returns the standard result set. If the foreign key related to the primary key is requested, the result set is sorted as FKTABLE_CAT, FKTABLE_SCHEM, FKTABLE_NAME, KEY_SEQ. If the primary key related to the foreign key is requested, the result set is sorted as PKTABLE_CAT, PKTABLE_SCHEM, PKTABLE_NAME, KEY_SEQ.

The following table describes the columns of result set.

Column name	Column number	Data type	Description
PKTABLE_CAT (ODBC 1.0)	1	VARCHAR	It is the primary key table catalog name.
PKTABLE_SCHEM (ODBC 1.0)	2	VARCHAR	It is the primary key table schema name.
PKTABLE_NAME (ODBC 1.0)	3	VARCHAR not NULL	It is the primary key table name.
PKCOLUMN_NAME (ODBC 1.0)	4	VARCHAR not NULL	It is the primary key column name. The driver returns an empty string for a column which does not have a name.
FKTABLE_CAT (ODBC 1.0)	5	VARCHAR	It is the foreign key table catalog name.
FKTABLE_SCHEM (ODBC 1.0)	6	VARCHAR	It is the foreign key table schema name.
FKTABLE_NAME (ODBC 1.0)	7	VARCHAR not NULL	It is the foreign key table name.
FKCOLUMN		VARCHAR not NULL	It is the foreign key column name. The driver returns an empty string for

Column name	Column number	Data type	Description
_NAME (ODBC 1.0)	8	not NULL	is a column which does not have a name.
KEY_SEQ (ODBC 1.0)	9	SMALLINT not NULL	It is the column sequential number of the key starting from 1.
UPDATE_RULE (ODBC 1.0)	10	SMALLINT	<p>It is the operation applied to the foreign key when the SQL operation is UPDATE. (The referenced table has the primary key, and the referring table has the foreign key.)</p> <ul style="list-style-type: none"> • SQL_CASCADE: If the primary key of referencing table is updated, the foreign key of the referring table is also updated. • SQL_NO_ACTION: If a row in the referring table does not corresponds to the referenced table when updating the primary key of the referenced table, the update is rejected. If the foreign key update of the referring table does not exist as the value of the primary key of the referenced table, the update is rejected. • SQL_SET_NULL: If one or more rows in the referenced table are updated in a way that one or more components of the primary key are changed, the components of the foreign key in the referring table which corresponds to the changed components of the primary key are set to NULL in all matching rows of the referring table. • SQL_SET_DEFAULT: If one or more rows in the referenced table are updated in a way that one or more components of the primary key are changed, the components of the foreign key in the referring table which corresponds to the changed components of the primary key are set to the default value in all matching rows of the referring table.
DELETE_RULE (ODBC 1.0)	11	SMALLINT	<p>It is the operation applied to the foreign key when the SQL operation is DELETE. (The referenced table has the primary key, and the referring table has the foreign key.)</p> <ul style="list-style-type: none"> • SQL_CASCADE: If the primary key of referenced table is deleted, the foreign key of the referring table is also deleted. • SQL_NO_ACTION: If a row in the referring table does not corresponds to the referenced table when deleting the primary key of the referenced table, the update is rejected. • SQL_SET_NULL: If one or more rows of the referenced table are deleted, each components of the foreign key of the referring table is set to NULL in all matching rows of the referring table. • SQL_SET_DEFAULT: If one or more rows of the referenced table a

Column name	Column number	Data type	Description
			re deleted, each component of the foreign key of the referencing table is set to the applicable default in all matching rows of the referencing table.
FK_NAME (ODBC 2.0)	12	VARCHAR	It is the foreign key name.
PK_NAME (ODBC 2.0)	13	VARCHAR	It is the primary key name.
DEFERRABILITY (ODBC 3.0)	14	SMALLINT	SQL_INITIALLY_DEFERRED, SQL_INITIALLY_IMMEDIATE, SQL_NOT_DEFERRABLE.

SQLFreeConnect

Conformance

Introduced version: ODBC 1.0

Standards compliance: It is not available.

Overview

SQLFreeConnect function is replaced with SQLFreeHandle function in ODBC 3.x.

For more information, refer to **SQLFreeHandle**.

SQLFreeEnv

Conformance

Introduced version: ODBC 1.0

Standards compliance: It is not available.

Overview

SQLFreeEnv function is replaced with SQLFreeHandle function in ODBC 3.x.

For more information, refer to **SQLFreeHandle**.

SQLFreeHandle

Conformance

Introduced version: ODBC 3.0

Standards compliance: ISO 92

Overview

SQLFreeHandle releases the resources related to the specified environment, connection, statement, and descriptor handles.

Syntax

```
SQLRETURN SQLFreeHandle(  
    SQLSMALLINT  HandleType,  
    SQLHANDLE     Handle);
```

Arguments

HandleType

[Input] It is the handle type to be released by using SQLFreeHandle. It should be one of SQL_HANDLE_DBC, SQL_HANDLE_DESC, SQL_HANDLE_ENV, SQL_HANDLE_STMT.

If HandleType is not one of the values above, SQLFreeHandle returns SQL_INVALID_HANDLE.

Handle

[Input] It is the handle to be released.

Returns

SQL_SUCCESS, SQL_ERROR, SQL_INVALID_HANDLE.

If SQLFreeHandle returns SQL_ERROR, the handle is still valid.

Diagnosis

SQLSTATE	Error	Description
HY000	General error	It is an error without any specific SQLSTATE.
HY001	Memory allocatio	It is a memory allocation error.

SQLSTATE	Error	Description
	n error	
HY010	Function sequence error	<p>HandleType argument is SQL_HANDLE_ENV, and at least one connection is assigned or connected. Before calling SQLFreeHandle whose HandleType argument is SQL_HANDLE_ENV, SQLDisconnect and SQLFreeHandle argument whose HandleType argument is SQL_HANDLE_DBC should be called.</p> <p>HandleType argument is SQL_HANDLE_DBC, the function is called before SQLDisconnect is called.</p> <p>HandleType argument is SQL_HANDLE_STMT, after calling SQLExecute, SQLExecDirect, then SQL_NEED_DATA is returned and the function is called before sending all data-at-execution variables.</p>

Description

SQLFreeHandle is used to release the environment, connection, statement, descriptor handles. After the handle is released, the application can not use the released handle.

Releasing the Environment Handle

Before calling SQLFreeHandle whose HandleType is SQL_HANDLE_ENV, the application should call SQLFreeHandle whose HandleType is SQL_HANDLE_DBC for all connection allocated from the environment. Otherwise, SQLFreeHandle returns SQL_ERROR, and the environment and active connection remain valid.

Releasing the Connection Handle

Before calling SQLFreeHandle whose HandleType is SQL_HANDLE_DBC, if the handle is connected, the application should call SQLDisconnect. Otherwise, SQLFreeHandle returns SQL_ERROR, and the connection remains valid.

Releasing the Statement Handle

SQLFreeHandle whose HandleType is SQL_HANDLE_STMT, releases all resources allocated by calling SQLAllocHandle whose HandleType is SQL_HANDLE_STMT. If the application calls SQLFreeHandle with the remaining statement, the remaining result is deleted. When the application releases the statement handle, the driver releases the four auto allocation descriptors related to the statement.

SQLDisconnect automatically deletes all statements and descriptors which are opened for the connection.

SQLFreeStmt

Conformance

Introduced version: ODBC 1.0

Standards compliance: ISO 92

Overview

SQLFreeStmt stops the processing related to the specified statement, closes an open cursor, removes the remaining result or selectively releases all resources connected to the statement handle.

Syntax

```
SQLRETURN SQLFreeStmt(  
    SQLHSTMT      StatementHandle,  
    SQLUSMALLINT Option);
```

Arguments

StatementHandle

[Input] It is the statement handle.

Option

[Input] It is one of the following options.

- **SQL_CLOSE**: It closes the cursor related to StatementHandle, and deletes the remaining result. The application executes SELECT statement with the same or different parameter values, and it can open cursor again later. If the cursor is not open, this option does not affect the application. SQLCloseCursor also closes the cursor.
- **SQL_DROP**: This option is not used any more.
- **SQL_UNBIND**: It releases all column buffers bound with SQLBindCol for the specified StatementHandle, and sets SQL_DESC_COUNT field of ARD to 0.
- **SQL_RESET_PARAMS**: It releases all parameter buffers set to SQLBindParameter for the specified StatementHandle, and sets SQL_DESC_COUNT field of APD to 0.

Returns

SQL_SUCCESS, SQL_SUCCESS_WITH_INFO, SQL_ERROR, SQL_INVALID_HANDLE

Diagnosis

SQLSTATE	Error	Description
HY000	General error	It is an error without any specific SQLSTATE.
HY001	Memory allocation error	It is a memory allocation error.
HY010	Function sequence error	After calling SQLExecute, SQLExecDirect, then SQL_NEED_DATA is returned and the function is called before sending all data-at-execution variables.
HY092	Option type out of range	The value of option argument is not SQL_CLOSE, SQL_DROP, SQL_UNBIND, SQL_RESET_PARAMS.

Description

Calling SQLFreeStmt with SQL_CLOSE option is as same as calling of SQLCloseCursor. However, if an open cursor does not exist, calling SQLFreeStmt with SQL_CLOSE option does not affect the application. SQLCloseCursor returns SQLSTATE 24000 (Invalid cursor state).

SQLGetConnectAttr

Conformance

Introduced version: ODBC 3.0

Standards compliance: ISO 92

Overview

SQLGetConnectAttr returns the current setting of the connection attribute.

Syntax

```
SQLRETURN SQLGetConnectAttr(  
    SQLHDBC      ConnectionHandle,  
    SQLINTEGER   Attribute,  
    SQLPOINTER   ValuePtr,  
    SQLINTEGER   BufferLength,  
    SQLINTEGER * StringLengthPtr);
```

Arguments

ConnectionHandle

[Input] It is the connection handle.

Attribute

[Input] It is the attribute to be searched

ValuePtr

[Output] It is a memory pointer which returns the current setting value of the attribute specified by Attribute.

If ValuePtr is null, StringLengthPtr returns the total number of bytes returnable (excluding the null-termination character).

BufferLength

[Input] If Attribute is a defined field in ODBC and ValuePtr points to the string or binary buffer, this argument should be the length of *ValuePtr. If Attribute is a defined field in ODBC and *ValuePtr is an integer, this argument is ignored.

StringLengthPtr

[Output] It is the pointer which returns the total number of bytes returnable in *Value_Ptr (excluding null-termination byte for character data)

For the character data, if the number of returnable bytes is equal to or bigger than BufferLength, *ValuePtr is truncated to length of BufferLength minus 1, and it is null terminated by the driver.

Returns

SQL_SUCCESS, SQL_SUCCESS_WITH_INFO, SQL_NO_DATA, SQL_ERROR, SQL_INVALID_HANDLE

Diagnosis

SQLSTATE	Error	Description
01004	String data, right truncated	The data truncated to the length of BufferLength minus null-termination character is returned to *ValuePtr. The length of string not truncated is returned to *StringLengthPtr. (The function returns SQL_SUCCESS_WITH_INFO.)
08003	Connection not open	The Attribute value required on the connection status is specified.
08S01	Communication link failure	Before the function processing is completed, the connection between the driver and the data source is failed.
HY000	General error	It is an error without any specific SQLSTATE.
HY001	Memory allocation error	It is a memory allocation error.
HY090	Invalid string or buffer length	*ValuePtr is a string, and BufferLength is smaller than 0 but it is not SQL_NTS.
HY092	Invalid attribute/option identifier	The Attribute argument value is not valid.
HYC00	Optional feature not implemented	The Attribute argument value is valid but it is not supported by the driver.

Description

If an attribute specifies the attribute which returns the string, ValuePtr should have the pointer to the string buffer. The maximum length of the returned string including null-termination character is BufferLength in bytes.

Attribute	The description of ValuePtr
SQL_ATTR_ACCESS_MODE (ODBC 1.0)	It is the SQLINTEGER value. SQL_MODE_READ_ONLY is used as the indicator of the connection which does not request the update. This mode is used for the transaction management, the optimization, and the lock plan of the driver or data source.

Attribute	The description of ValuePtr
	The default value is SQL_MODE_READ_WRITE.
SQL_ATTR_AUTOCOMMIT (ODBC 1.0)	<p>It is SQLINTEGER value which specifies whether to use auto commit or manual commit.</p> <ul style="list-style-type: none"> • SQL_AUTOCOMMIT_ON: It is the default value. The driver uses the auto commit mode. Each statement is immediately committed after execution. When SQL_ATTR_AUTOCOMMIT is set to SQL_AUTOCOMMIT_ON, the open transaction is committed to the connection to change from the manual commit mode to the auto commit mode. • SQL_AUTOCOMMIT_OFF: The driver uses the manual commit mode, and the application should explicitly commit or rollback with SQLEndTrans.
SQL_ATTR_CHARACTERSET	It is the character set string of the driver.
SQL_ATTR_DATABASE_CHARACTERSET	It is the character set string of the data source.
SQL_ATTR_DATE_FORMAT	It is the DATE format string of the driver.
SQL_ATTR_LOGIN_TIMEOUT (ODBC 1.0)	It is the waiting time (in seconds) for a login request with SQLINTEGER value. If ValuePtr is 0, timeout is not used, and the connection attempt indefinitely wait.
SQL_ATTR_METADATA_ID (ODBC 3.0)	<p>It is SQLINTEGER value which determines the string argument of the catalog function.</p> <p>If it is SQL_TRUE, the string argument of catalog function is treated as an identifier, and it is case-insensitive. If the string is not separated by a delimiter, the driver removes all leading or trailing spaces and the string is capitalized. If the string is separated by a delimiter, the driver removes all leading or trailing spaces and the string between delimiters remains literally. If one of the arguments is set to the null pointer, the function returns SQL_ERROR and SQLSTATE HY009 (Invalid use of null pointer).</p> <p>If it is SQL_FALSE, the string argument of catalog function is not treated as an identifier. It may or may not include a search string pattern depending on the string argument.</p> <p>The default value is SQL_FALSE.</p> <p>SQL_ATTR_METADATA_ID can also be set in the statement level.</p>
SQL_ATTR_TIMESTAMP_FORMAT	It is the TIMESTAMP format string of the driver.
SQL_ATTR_TIMESTAMP_WITH_TIMEZONE_FORMAT	It is the TIMESTAMP WITH TIME ZONE format string of the driver.
SQL_ATTR_TIMEZONE	It is the timezone string of the driver.
SQL_ATTR_TIME_FORMAT	It is the TIME format string of the driver.
SQL_ATTR_TIME_WITH_TIMEZONE_FORMAT	It is the TIME WITH TIME ZONE format string of the driver.

Attribute	The description of ValuePtr
MEZONE_FORMAT	
SQL_ATTR_TXN_ISOLATION (ODBC 1.0)	It is 32-bit mask which sets the isolation level for the current connection.

SQLGetConnectOption

Conformance

Introduced version: ODBC 1.0

Standards compliance: It is not available.

Overview

SQLGetConnectOption function is replaced with SQLGetConnectAttr function in ODBC 3.x.
For more information, refer to [SQLGetConnectAttr](#).

SQLGetCursorName

Conformance

Introduced version: ODBC 1.0

Standards compliance: ISO 92

Overview

SQLGetCursorName returns the specified statement and related cursor name.

Syntax

```
SQLRETURN SQLGetCursorName(  
    SQLHSTMT      StatementHandle,  
    SQLCHAR *     CursorName,  
    SQLSMALLINT   BufferLength,  
    SQLSMALLINT * NameLengthPtr);
```

Arguments

StatementHandle

[Input] It is the statement handle.

CursorName

[Output] It is the buffer pointer which returns the cursor name

If CursorName is NULL, NameLengthPtr returns the returnable byte length (excluding the null-termination character)

BufferLength

[Input] It is the length of *CursorName.

NameLengthPtr

[Output] It is the memory pointer for the length of bytes returnable to *CursorName (excluding the null-termination character). If the returnable byte length is equal to or bigger than it, *sCursorName is truncated to the length of BufferLength minus 1.

Returns

SQL_SUCCESS, SQL_SUCCESS_WITH_INFO, SQL_ERROR, SQL_INVALID_HANDLE

Diagnosis

SQLSTATE	Error	Description
01004	String data, right truncated	*CursorName buffer is not large enough to return the entire cursor name, so the cursor name is truncated. The length of cursor name not truncated is returned to *NameLengthPtr. (The function returns SQL_SUCCESS_WITH_INFO.)
HY000	General error	It is an error without any specific SQLSTATE.
HY001	Memory allocation error	It is a memory allocation error.
HY010	Function sequence error	After calling SQLExecute, SQLExecDirect, then SQL_NEED_DATA is returned and the function is called before sending all data-at-execution variables.
HY090	Invalid string or buffer length	The value of BufferLength argument is smaller than 0.

Description

The cursor name is used only in positioned update and positioned delete statements. (e.g. UPDATE table-name ...WHERE CURRENT OF cursor-name) If the cursor name is not set with SQLSetCursorName in the application, the driver generates the cursor name starting with SQL_CUR.

SQLGetCursorName can re-set the cursor name, if the statement is the assigned or ready state.

The cursor name which is explicitly or implicitly set is valid until the related statement is deleted by calling SQLFreeHandle whose HandleType is SQL_HANDLE_STMT.

SQLGetData

Conformance

Introduced version: ODBC 1.0

Standards compliance: ISO 92

Overview

SQLGetData retrieves a column data in the result set, and it can be called multiple times to retrieve the variable length data.

Syntax

```
SQLRETURN SQLGetData(
    SQLHSTMT      StatementHandle,
    SQLUSMALLINT  Col_or_Param_Num,
    SQLSMALLINT   TargetType,
    SQLPOINTER    TargetValuePtr,
    SQLLEN        BufferLength,
    SQLLEN *      StrLen_or_IndPtr);
```

Arguments

StatementHandle

[Input] It is the statement handle.

Col_or_Param_Num

[Input] It is the column number for retrieving the column data from the returned data. Result set columns are numbered in increasing order, starting from 1.

TargetType

[Input] It is the C data type identifier of *TargetValuePtr buffer.

If TargetType is SQL_ARD_TYPE, the driver uses the type identifier specified in SQL_DESC_CONCISE_TYPE field of ARD.

TargetValuePtr

[Output] It is the buffer pointer to which the data is returned

TargetValuePtr can not be NULL.

BufferLength

[Input] It is the byte length of *TargetValuePtr buffer.

When the driver returns the variable length data such as string or binary data, it uses BufferLength to avoid writing beyond the end of *TargetValuePtr buffer. Be cautious when returning character data to *TargetValuePtr because the driver calculates the null-termination character. Therefore, *TargetValuePtr should include the space for the null-termination character. Otherwise, the driver can truncate the data.

When the driver returns the fixed length data such as integer or date structure, the driver assumes that the buffer is large enough to store the data, and it ignores BufferLength. Therefore, the application should allocate the buffer which is large enough to the fixed length data. If not, the driver can write beyond the end of buffer.

SQLGetData returns SQLSTATE HY090(Invalid string or buffer length), if BufferLength is smaller than 0.

StrLen_or_IndPtr

[Output] It is the buffer pointer which returns the length or indicator value. If the argument is the null pointer, the length and indicator values are not returned, and an error occurs when fetching NULL data.

SQLGetData can return SQL_NO_TOTAL, SQL_NULL_DATA, and the data length which can be returned to the length/indicator buffer.

Returns

SQL_SUCCESS, SQL_SUCCESS_WITH_INFO, SQL_NO_DATA, SQL_STILL_EXECUTING, SQL_ERROR, SQL_INVALID_HANDLE

Diagnosis

SQLSTATE	Error	Description
01004	String data, right truncated	All data for the column specified as Col_or_Param_Num can not be retrieved by a single function call. The length of the remaining data in the specified column is returned to *StrLen_or_IndPtr before calling SQL_NO_TOTAL or SQLGetData. (The function returns SQL_SUCCESS_WITH_INFO.)
01S07	Fractional truncation	The data returned for one or more column is truncated. For numeric data types, the decimal place is truncated. For time, timestamp, interval data types which contain the period component, the decimal place of time is truncated. (The function returns SQL_SUCCESS_WITH_INFO.)
07006	Restricted data type attribute violation	The column data value in the result set can not be converted to the C data type specified by TargetType.
	Invalid descriptor	Col_or_Param_Num argument value is bigger than the number of columns i

SQLSTATE	Error	Description
07009	index	n the result set.
08S01	Communication link failure	Before the function processing is completed, the connection between the driver and the data source is failed.
22002	Indicator variable required but not supplied	StrLen_or_IndPtr is the null pointer, and the returned data is NULL.
22003	Numeric value out of range	The integer part (not the decimal place) of the numerical value returned from one or more columns is truncated.
22007	Invalid datetime format	The string in the result set is not the valid date, time, timestamp format.
22012	Division by zero	The result of the arithmetic expression divided by 0 is returned.
22015	Interval field overflow	When the interval C type is specified in the exact numeric or interval SQL data type, the significant figures in the leading field is lost. The value of SQL type can not be expressed to C interval type.
22018	Invalid character value for cast specification	The character not represented as the character set of C buffer is included in the character column of the result set. The C type is the exact or approximate numeric, datetime, interval data type, and if the SQL type is the character data type, the value of the column bound to the C type is not valid.
24000	Invalid cursor state	The function is called without calling SQLFetch or SQLFetchScroll. StatementHandle is executed but result set related to StatementHandle does not exist. The cursor is open by calling SQLFetch or SQLFetchScroll, but the cursor is pointing to before the start or after the end of result set.
HY000	General error	It is an error without any specific SQLSTATE.
HY001	Memory allocation error	It is a memory allocation error.
HY003	Program type out of range	TargetType argument value is not valid.
HY009	Invalid use of null pointer	TargetValuePtr argument is the null pointer.
HY010	Function sequence error	The specified StatementHandle is not in executed state. The function is called without calling SQLExecDirect, SQLExecute, the catalog function. After calling SQLExecute, SQLExecDirect, then SQL_NEED_DATA is returned and the function is called before sending all data-at-execution variables.
HY090	Invalid string or buffer length	BufferLength argument value is smaller than 0.

Description

SQLGetData returns the data of the specified column, and it can be called only after one or more rows are fetched from the result set of SQLFetch or SQLFetchScroll. When the variable length data is too large to be returned with a single call SQLGetData (because of application restrictions), SQLGetData can partially retrieve it.

Using SQLGetData

If TargetType argument is the interval data type, the default value is interval leading precision(2), interval seconds precision(6), and it is set to SQL_DESC_DATETIME_INTERVAL_PRECISION field and SQL_DESC_PRECISION field of ARD each. If TargetType argument is the SQL_C_NUMERIC data type, the default value is precision(38), scale(0), and it is set to SQL_DESC_PRECISION field and SQL_DESC_SCALE field of ARD each. If the default precision and scale are not appropriate, the application should explicitly set the descriptor field by calling SQLSetDescField or SQLSetDescRec.

Partial Retrieving of Variable Length Data

SQLGetData can partially retrieve the variable length data whose SQL data type is SQL_CHAR, SQL_VARCHAR, SQL_LONGVARCHAR, SQL_WCHAR, SQL_WVARCHAR, SQL_WLONGVARCHAR, SQL_BINARY, SQL_VARBINARY, SQL_LONGVARBINARY.

The application continuously calls SQLGetData multiple times for the same column to partially retrieve the data of the column. SQLGetData returns the next part of the data at each call. The applications should reassemble the parts, being careful to remove the null-termination character in the middle of the character data. If more data should be returned, SQLGetData returns SQL_SUCCESS_WITH_INFO, SQLSTATE 01004 (Data truncated). If the last part of data is returned, SQL_SUCCESS is returned.

SQLGetData can not be used for returning the part of fixed length data. If SQLGetData is called once or more for a column which contains the fixed-length data, SQL_NO_DATA is returned after the first call.

Retrieving Data Using SQLGetData

SQLGetData performs the following processes to return the data for the specified column.

1. If all data is returned to the column, SQL_NO_DATA is returned.
2. If the data is NULL, *StrLen_or_IndPtr is set to SQL_NULL_DATA. If the data is NULL and *StrLen_or_IndPtr is the null pointer, SQLGetData returns SQLSTATE 22002 (Indicator variable required but not supplied).

If the column data is not NULL, SQLGetData performs the third process.

3. If the attribute of SQL_ATTR_MAX_LENGTH statement is set to non-zero value or the column contains the string or binary data or SQLGetData is not called for the column before, then the data is truncated to length of SQL_ATTR_MAXLENGTH bytes.



The attribute of SQL_ATTR_MAX_LENGTH statement is used to reduce the network traffic. It is generally implemented by the data source, and it truncates the data before returning the data via the network. The driver and the data source are not required to support it. Therefore, the application should allocate a buffer of the proper size, and specify the size of BufferLength argument to guarantee that the data is truncated to the specific size.

4. The data is converted to the data type specified in TargetType. The default precision and scale values for the data type are given to the data. If TargetType is SQL_ARD_TYPE, the data type in SQL_DESC_CONCISE_TYPE field of ARD is used. The data provides the precision and scale of SQL_DESC_DATETIME_INTERVAL_PRECISION field, SQL_DESC_PRECISION field, SQL_DESC_SCALE field of ARD depending on the data type of SQL_DESC_CONCISE_TYPE field. If all default precisions and scales are not appropriate, the application should explicitly set the descriptor field by calling SQLSetDescField or SQLSetDescRec.
5. If the data is converted to the variable length data type such as the string or binary, SQLGetData checks whether the data length exceeds BufferLength (including the null-termination character). If the data length exceeds BufferLength, SQLGetData truncates the data to the length of BufferLength minus the null-termination character. If the binary data length exceeds the data buffer length, SQLGetData truncates it to the length of BufferLength bytes.
If the null-termination character is not stored in the provided data buffer, SQLGetData returns SQL_SUCCESS_WITH_INFO and SQLSTATE 01004.
SQLGetData does not truncate the data converted to the fixed length data type. In this case, the length of *TargetValuePtr is always assumed as the size of the data type.
6. It stores the converted data in *TargetValuePtr. Be cautious that SQLGetData can not return data out of line.
7. The data length is stored in *StrLen_or_IndPtr. If StrLen_or_IndPtr is the null pointer, SQLGetData does not return the length.
 - For the string and binary data, it is the length after conversion and before truncated to BufferLength. If the driver can not check the data length after conversion (it can happen when it is a long data type), it returns SQL_SUCCESS_WITH_INFO, and it sets the length to SQL_NO_TOTAL. (The last call of SQLGetData should return the value of data length which is neither 0 nor is SQL_NO_TOTAL) If the data is truncated by the attribute of SQL_ATTR_MAX_LENGTH statement, the attribute value is stored in *StrLen_or_IndPtr. It is because the data is designed to be passed on the server before the attribute is converted, and the driver can not know the actual length. When SQLGetData is continuously called multiple times for the same column, this is the data length available at the beginning of the current call. In other words, the length is reduced due to each subsequent calls.
 - For all other data types, this is the data length after conversion. In other words, it is the size of the type to which data is converted.
8. If the data is truncated without loss of the default value (for example, the real number 1.234 is truncated to an integer 1 when converted), or if it is truncated because BufferLength is too small (e.g. the

string "abcdef" is stored in the buffer of 4-byte length) during data conversion, then SQLGetData returns SQLSTATE 01004 (Data truncated) and SQL_SUCCESS_WITH_INFO. If the data is truncated without loss of the default value due to the attribute of SQL_ATTR_MAX_LENGTH statement, SQLGetData returns SQL_SUCCESS but it does not return SQLSTATE 01004 (Data truncated).

If SQLGetData does not return SQL_SUCCESS nor SQL_SUCCESS_WITH_INFO (When SQLGetData is called for the bound column) the contents of bound data buffer, and the length/indicator buffer are not defined.

If SQLGetData is continuously called, it retrieves the data from the last column requested. The previous offset is not valid.

The following is an example.

```
SQLGetData(icol=n), SQLGetData(icol=m), SQLGetData(icol=n)
```

The second call SQLGetData(icol=n) retrieves the data starting from the column n. All offsets of the data are not valid any more due to the previous SQLGetData call.

SQLGetData and Descriptor

SQLGetData does not directly interact with any descriptor field.

If targetType is SQL_ARD_TYPE, the data type of SQL_DESC_CONCISE_TYPE field of ARD is used. If targetType is SQL_ARD_TYPE or SQL_C_DEFAULT, the precisions and scales of SQL_DESC_DATETIME_INTERVAL_PRECISION field, SQL_DESC_PRECISION field, and SQL_DESC_SCALE field of ARD are given according to the data type of SQL_DESC_CONCISE_TYPE field.

SQLGetDescField

Conformance

Introduced version: ODBC 3.0

Standards compliance: ISO 92

Overview

SQLGetDescField returns the current setting or value of a single field of descriptor record.

Syntax

```
SQLRETURN SQLGetDescField(  
    SQLHDESC      DescriptorHandle,  
    SQLSMALLINT   RecNumber,  
    SQLSMALLINT   FieldIdentifier,  
    SQLPOINTER    ValuePtr,  
    SQLINTEGER    BufferLength,  
    SQLINTEGER *  StringLengthPtr);
```

Arguments

DescriptorHandle

[Input] It is the descriptor handle.

RecNumber

[Input] It is the descriptor record of information which the application tries to find. If FieldIdentifier argument is the header field, RecNumber is ignored. If RecNumber is equal to or less than SQL_DESC_COUNT, and the row does not include the data for the column or parameter, SQLGetDescField returns the default value of field.

FieldIdentifier

[Input] It is the descriptor field to which the value is returned.

ValuePtr

[Output] It is the buffer pointer which returns the descriptor information. The data type is dependent on the value of FieldIdentifier.

If ValuePtr is the integer type, the application should use SQLULEN buffer initialized to 0.

If ValuePtr is null, StringLengthPtr returns the number of the total returnable bytes (excluding null-

termination character).

BufferLength

[Input] If FieldIdentifier field is defined in ODBC and ValuePtr points to the string or binary buffer, the argument should be the length of *ValuePtr. If FieldIdentifier field is defined in ODBC and *ValuePtr is an integer, the argument is ignored.

StringLengthPtr

[Output] It is the pointer which returns the number of the total returnable bytes from *ValuePtr (excluding null-termination byte for the character data).

Returns

SQL_SUCCESS, SQL_SUCCESS_WITH_INFO, SQL_ERROR, SQL_NO_DATA, SQL_INVALID_HANDLE

If RecNumber is bigger than the number of current descriptor records, SQL_NO_DATA is returned.

If DescriptorHandle is IRD handle and the statement is in the ready state or executing state but associated cursor does not exist, SQL_NO_DATA is returned.

Diagnosis

SQLSTATE	Error	Description
01000	General Warning	It is the driver-specific informational message. (The function returns SQL_SUCCESS_WITH_INFO.)
01004	String data, right truncated	The buffer length of *ValuePtr is shorter than the value length of descriptor field, so it is truncated. The remaining length of descriptor field is returned in *StringLengthPtr. (The function returns SQL_SUCCESS_WITH_INFO.)
07009	Invalid descriptor index	RecNumber argument is set to 0, and the status attribute of SQL_ATTR_USE_BOOKMARKS is set to SQL_UB_OFF, and DescriptorHandle argument is a IRD handle. FieldIdentifier argument is the record field, RecNumber argument is 0, and DescriptorHandle argument is a IPD handle. RecNumber argument is smaller than 0.
08S01	Communication link failure	Before the function processing is completed, the connection between the driver and the data source is failed.
HY000	General error	It is an error without any specific SQLSTATE.
HY001	Memory allocation error	It is a memory allocation error.
HY007	Associated statement is not prepared	DescriptorHandle is related to a IRD handle, and the related handle is not in the preparation state or executing state.
		It is the DescriptorHandle related to StatementHandle for the asynchronous performance function which is still being executed while it is called.

SQLSTATE	Error	Description
HY010	Function sequence error	It is the DescriptorHandle related to StatementHandle which SQLExecute, SQLExecDirect, SQLBulkOperations, SQLSetPos are called and SQL_NEED_DATA is returned. The asynchronously executing function is called for the connection handle related to DescriptorHandle, and it is still being executed even when SQLGetDescField is called.
HY013	Memory management error	The size of buffer used as an argument is smaller than 0, or it can not access the memory.
HY021	Inconsistent descriptor information	SQL_DESC_TYPE and SQL_DESC_DATETIME_INTERVAL_CODE field are not the valid format for ODBC SQL type, SQL type of the specific driver (for IPD) or ODBC C type (for APD or ARD).
HY090	Invalid string or buffer length	*Valueptr is the string, and BufferLength is smaller than 0.
HY091	Invalid descriptor field Identifier	FieldIdentifier is not the field defined in ODBC, and it is not the implemented value. FieldIdentifier is not defined for DescriptorHandle.
HY117	Connection is suspended due to unknown transaction state. Only disconnect and read-only functions are allowed.	For more information about the suspended state, refer to SQLEndTran .
HYT01	Connection timeout expired	The connection is expired before the data source responds to the request. The time limit can be set via SQL_ATTR_CONNECTION_TIMEOUT of SQLSetStmtAttr.
IM001	Driver does not support this function	The driver related to DescriptorHandle does not support the function.

Description

The application can call SQLGetDescField to return a single field value of the descriptor record. Calling SQLGetDescField returns the settings for all fields of all descriptor types including the header field, record fields, and bookmarks field. The application can obtain the multiple field settings in an arbitrary order in the same or another descriptor by repeatedly calling SQLGetDescField. SQLGetDescField can be called to return the driver definition descriptor field.

For the performance reason, the application should not call SQLGetDescField for IRD before executing the statement.

Multiple field settings for the size of name, data type, column or parameter data can be retrieved by calling SQLGetDescRec once. SQLGetStmtAttr can be called to return a single field settings in the descriptor header.

ader which is the statement attribute. `SQLColAttribute`, `SQLDescribeCol`, `SQLDescribeParam` return the records or book mark fields.

When the application calls `SQLGetDescField` to retrieve the undefined field value for a particular descriptor type, the function returns `SQL_SUCCESS` but the returned field value is not defined. For example, calling `SQLGetDescField` for `SQL_DESC_NAME` field of APD/ARD or calling `SQLGetDescField` for `SQL_DESC_NULLABLE` field returns `SQL_SUCCESS`, but the field value is not defined.

When the application calls `SQLGetDescField` to retrieve the field value whose particular descriptor is defined but any settings such as default value are not defined, then the function returns `SQL_SUCCESS` but the returned field value is not defined.

Header Field

Each descriptor consists of the following fields.

SQL_DESC_ALLOC_TYPE[All]

It is the header field which is read-only `SQLSMALLINT`. It specifies whether the descriptor is automatically assigned by the driver or it is explicitly assigned by the application. The application can read the field but can not modify it. When the descriptor is automatically allocated by the driver, the field is set to `SQL_DESC_ALLOC_AUTO` by the driver.

SQL_DESC_ARRAY_SIZE[Application descriptors]

It is the header field which is `SQLULEN` in ARD. It specifies the number of rows in the row set. This is the number of rows returned by the operation caused by calling `SQLFetch`, `SQLFetchScroll`, `SQLBulkOperations` or `SQLSetPos`.

It is the header field which is `SQLULEN` in APD. It specifies the number of values of each parameter. The default value of the field is 1. If `SQL_DESC_ARRAY_SIZE` is bigger than 1, `SQL_DESC_DATA_PTR`, `SQL_DESC_INDICATOR_PTR`, `SQL_DESC_OCTET_LENGTH_PTR` of APD or ARD points to the array. The constant of each array is equal to the field value.

This field in ARD can be set by calling `SQLSetStmtAttr` together with `SQL_ATTR_ROW_ARRAY_SIZE` attribute. The field in APD can also be set by calling `SQLSetStmtAttr` together with `SQL_ATTR_PARAMETER_ARRAY_SIZE`.

SQL_DESC_ARRAY_STATUS_PTR[All]

For each descriptor type, the header field which is `SQLUSMALLINT*` points to the array of `SQLUSMALLINT` value. The arrays are named as row status array (IRD), parameter status array (IPD), row operation array (ARD), parameter operation array (APD).

This header field in IRD points to the row status array which contains the status value after calling `SQLBulkOperations`, `SQLFetch`, `SQLFetchScroll`, or `SQLSetPos`. The application allocates `SQLUSMALLINT` array, and this field should point to the array. The field is generally the NULL pointer. The driver will create an array unless `SQL_DESC_ARRAY_STATUS_PTR` is set to the NULL pointer.



If the application sets the elements of row status array pointed by `SQL_DESC_ARRAY_STATUS_PTR` field of IRD, then the operation of driver is not defined.

The array is initialized and created by calling `SQLBulkOperations`, `SQLFetch`, `SQLFetchScroll` or `SQLSetPos`. If this call does not return `SQL_SUCCESS` or `SQL_SUCCESS_WITH_INFO`, then the content of array pointed by the field is not defined.

Elements in the array can contain the following values.

- `SQL_ROW_SUCCESS`: The row is successfully retrieved, and it is not updated since the last retrieving.
- `SQL_ROW_SUCCESS_WITH_INFO`: The row is successfully retrieved, and it is not updated since the last return. However, the warning for the row is returned.
- `SQL_ROW_ERROR`: An error occurs during retrieving the row.
- `SQL_ROW_UPDATED`: The row is successfully retrieved, and it is updated since the last retrieving. If the row is retrieved again, the state is `SQL_ROW_SUCCESS`.
- `SQL_ROW_DELETED`: The row is deleted since the last retrieving.
- `SQL_ROW_ADDED`: The row is entered by `SQLBulkOperations`. If the row is retrieved again, the state is `SQL_ROW_SUCCESS`.
- `SQL_ROW_NOROW`: The row set and the last of result set are overlapped. And a row is not returned corresponding to the elements of row status array.

This field of IRD can be set by calling `SQLSetStmtAttr` together with `SQL_ATTR_ROW_STATUS_PTR` attribute.

`SQL_DESC_ARRAY_STATUS_PTR` field of IRD is valid only after `SQL_SUCCESS` or `SQL_SUCCESS_WITH_INFO` is returned. If the return code is not one of these, the thing pointed by `SQL_DESC_ROWS_PROCESSED_PTR` is not defined.

This header field in IPD calls `SQLExecute` or `SQLExecDirect` and then points to the parameter status array which includes each parameter status information. If `SQLExecute` or `SQLExecDirect` is called and `SQL_SUCCESS` or `SQL_SUCCESS_WITH_INFO` is not returned, then the content of array pointed by this field is not defined. The application allocates `SQLUSMALLINT` array, and this field should point the array. The driver will create an array if `SQL_DESC_ARRAY_STATUS_PTR` field is not set to the NULL pointer.

Elements in the array can contain the following values.

- `SQL_PARAM_SUCCESS`: SQL statement was successfully executed for this parameter set.
- `SQL_PARAM_SUCCESS_WITH_INFO`: SQL statement was successfully executed for this parameter set, but there is a warning information available to the diagnostic data structure.
- `SQL_PARAM_ERROR`: An error occurred when processing the parameter set. Additional error information is in the diagnostic data structure.
- `SQL_PARAM_UNUSED`: An error occurred while processing some previous parameters, or it is not used because `SQL_PARAM_IGNORE` is set in the parameter set of the array pointed by `SQL_DESC_ARRA`

Y_STATUS_PTR field of APD.

- SQL_PARAM_DIAG_UNAVAILABLE: The diagnostic information can not be used. For example, the driver treats the array of the parameter as one and does not generate the level of the error information.

This field in IPD can be set by calling SQLSetStmtAttr together with SQL_ATTR_PARAM_STATUS_PTR attribute.

In ARD, the corresponding field points to the row operation array for the values set by the application to determine whether or not to ignore the row in SQLSetPos operation.

Elements in the array can contain the following values.

- SQL_ROW_PROCEED: The row is included in the bulk operation which uses SQLSetPos. (This setting does not guarantee that the operation occurs on the row. If the row has SQL_ROW_ERROR state of the row status array of IRD, the driver can not implement the operation for the row.)
- SQL_ROW_IGNORE: The row is excluded from the bulk operation which uses SQLSetPos.

If elements of the array is not set, all rows are included in the bulk operation. If the value of SQL_DESC_ARRAY_STATUS_PTR field of ARD is the NULL pointer, all rows are included in the bulk operation. It is translated as same as when the pointer points to a valid array and all elements of the array are SQL_ROW_PROCEED. When all elements in the array are set to SQL_ROW_IGNORE, the values in the row status array for the ignored rows are not updated.

This field in ARD can also be set by calling SQLSetStmtAttr together with SQL_ATTR_ROW_OPERATION_PTR attribute.

When SQLExecute or SQLExecDirect is called, this header field in ARD points to the parameter operation array of the values set by the application to indicate whether or not to ignore the parameter set.

Elements in the array can contain the following values.

- SQL_PARAM_PROCEED: The parameter set is included in calling SQLExecute or SQLExecDirect.
- SQL_PARAM_IGNORE: The parameter set is not included in calling SQLExecute or SQLExecDirect.

If elements of the array are not set, all parameter sets of the array are used to call SQLExecute or SQLExecDirect. If the value of SQL_DESC_ARRAY_STATUS_PTR field of APD is the NULL pointer, all parameter set are used. It is read as same as when the pointer points to the valid array, or the array whose all elements are SQL_PARAM_PROCEED.

This field in APD can also be set by calling SQLSetStmtAttr together with SQL_ATTR_PARAM_OPERATION_PTR attribute.

SQL_DESC_BIND_OFFSET_PTR[Application descriptors]

This header field is SQLLEN* and it points to the binding offset. It is set to the NULL pointer by default. If this field is not the NULL pointer, the driver dereferences the pointer and each value of the d

ferred field which has non-NULL value of the descriptor record (SQL_DESC_DATA_PTR_, SQL_DESC_INDICATOR_PTR and SQL_DESC_OCTET_LENGTH_PTR) at fetching time, and uses a new pointer value when binding.

The binding offset is always directly added to SQL_DESC_DATA_PTR field, SQL_DESC_INDICATOR_PTR field and SQL_DESC_OCTET_LENGTH_PTR field. If the offset value is changed to another value, the new value is directly and continuously added as each descriptor field value. The new offset is not added to the previous offset value of the field.

It is the deferred field. This field is not used at the time of setting, but it is used by the driver when the data buffer address is checked.

This field in ARD can be set by calling SQLSetStmtAttr together with SQL_ATTR_ROW_BIND_OFFSET_PTR attribute.

For more information, refer to [SQLFetchScroll](#) or [SQLBindParameter](#).

SQL_DESC_BIND_TYPE[Application descriptors]

This header field is SQLINTEGER and is used to set the binding direction.

This field in ARD specifies the binding direction when SQLFetchScroll or SQLFetch is called on the related statement handle.

This field can be set to SQL_BIND_BY_COLUMN(default) to select the column-wise binding for the columns.

The field in ARD can be set by calling SQLSetStmtAttr together with SQL_ATTR_ROW_BIND_TYPE attribute.

The field specifies the binding direction used in the dynamic parameter.

This field may be set to SQL_BIND_BY_COLUMN(default) to select the column-wise binding for the parameter.

This field can be set by calling SQLSetStmtAttr together with SQL_ATTR_PARAM_BIND_TYPE attribute.

SQL_DESC_COUNT[All]

This header field is SQLSMALLINT and specifies the 1-based index of the top-level record which includes the data. When the driver sets the data structure to the descriptor, SQL_DESC_COUNT should be set to display the number of important records. It is not required to specify how many space to reserve for the record when the application allocates instances of data structure. Like as the application specifies the contents of the records, the driver performs the requested operation for the descriptor handle to guarantee displaying the sufficient size of the data structure.

It is not the number of all data column or all parameters which SQL_DESC_COUNT is bound to, but it is the number of top-level records. If the binding of the top-level column or parameter is released, SQL_DESC_COUNT is changed to the number of next top-level columns or parameters. If the binding of the top-level column, the column which is smaller than the parameter, or parameters is released (if TargetValuePtr argument is set to the NULL pointer, and SQLBindCol is called, or if Paramete

rValuePtr argument is set to the NULL pointer and SQLBindParameter is called), SQL_DESC_COUNT is not changed. If the added column or parameter is bound with bigger number than the number of top level records which includes the data, the driver automatically increases the value of SQL_DESC_COUNT field. If the binding for all columns is released by calling SQLFreeStmt with the SQL_UNBIND option, SQL_DESC_COUNT in ARD and IRD is set to 0. If SQLFreeStmt is called with the SQL_RESET_PARAMS option, SQL_DESC_COUNT fields in APD and IPD is set to 0.

The value of SQL_DESC_COUNT is explicitly set by calling SQLSetDescField in the application. If the value of SQL_DESC_COUNT is explicitly decreased, the records which have the value bigger than the new value of SQL_DESC_COUNT are effectively removed. If the value of SQL_DESC_COUNT field of ARD is set to 0, all buffers are released except for the bound bookmark column. The number of records of the field Of ARD does not include the bound bookmark column. The only way to release the binding of book mark column is to set SQL_DESC_DATA_PTR to NULL pointer.

SQL_DESC_ROWS_PROCESSED_PTR[Implementation descriptors]

This header field is SQLULEN* of IRD, and points to the buffer. The buffer includes the number of rows returned after calling SQLFetch or SQLFetchScroll, and the number of rows or number of errors affected by calling SQLBulkOperations or SQLSetPos and executing the bulk operation.

This header field is SQLINTEGER* of IPD and points to the buffer which includes the processed parameter set or the number of errors. If it is NULL pointer, the number is not returned.

SQL_DESC_ROWS_PROCESSED_PTR is valid only after calling SQLFetch or SQLFetchScroll(IRD) or after SQL_SUCCESS or SQL_SUCCESS_WITH_INFO is returned by calling SQLExecute, SQLExecDirect or SQLParamData(IPD). If the functions above do not return SQL_SUCCESS or SQL_SUCCESS_WITH_INFO, then the buffer contents are not defined and the buffer value is set to 0 until SQL_NO_DATA is returned.

The field in ARD can be set by calling SQLSetStmtAttr together with SQL_ATTR_ROWS_FETCHED_PTR attribute. ARD can be set by calling SQL_ATTR_PARAMS_PROCESSED_PTR.

The buffer pointed by this field is allocated by the application. It is the deferred output buffer defined by the driver. NULL pointer is set by default.

Record Field

Each descriptor includes one or more records consisting of the fields which define the column data or dynamic parameter depending on the descriptor type. Each record is a complete specification of a single column or parameter.

SQL_DESC_AUTO_UNIQUE_VALUE[IRDs]

This record field is read-only SQLINTEGER. It is SQL_TRUE if the column is automatically increased. Otherwise, it is SQL_FALSE. The auto-increment column does not need to be read-only.

SQL_DESC_BASE_COLUMN_NAME[IRDs]

This record field is read-only SQLCHAR*. It includes the default column name of the result set column. If the default column name does not exist, the field should include an empty string.

SQL_DESC_TABLE_NAME[IRDs]

This record field is read-only SQLCHAR*. It includes the base table name of the result set column. If the base table name is not defined or used, the field should include an empty string.

SQL_DESC_CASE_SENSITIVE[Implementation descriptors]

This record field is read-only SQLINTEGER. It includes SQL_TRUE if the column or parameter is case-sensitive when sorting or comparing columns or parameters, but it includes SQL_FALSE if the column or parameter is case-insensitive or non-character column.

SQL_DESC_CATALOG_NAME[IRDs]

This record field that is read-only SQLCHAR*. It includes the catalog of the base table which includes the column. If the column is an expression or a part of a view, the return value is dependent on the driver. If the data source does not support the catalog nor does it check the catalog, the field should include an empty string.

SQL_DESC_CONCISE_TYPE[AII]

This header field is SQLSMALLINT. It specifies the simple format for the data types which includes datetime and interval data types.

The value of SQL_DESC_CONCISE_TYPE field, SQL_DESC_TYPE field and SQL_DESC_DATETIME_INTERVAL_CODE field are interdependent. If time is set in one of the fields, it should be set on other fields as well. SQL_DESC_CONCISE_TYPE can be set by calling SQLBindCol, SQLBindParameter or SQLSetDescField. SQL_DESC_TYPE is set by calling SQLSetDescField or SQLSetDescRec.

If SQL_DESC_CONCISE_TYPE is set as the simple data types except for the interval or datetime data type, then SQL_DESC_TYPE field is set to the same value, and SQL_DESC_DATETIME_INTERVAL_CODE field is set to 0.

If SQL_DESC_CONCISE_TYPE is set as the simple datetime or interval data type, then SQL_DESC_TYPE field is set to the detailed type (SQL_DATETIME or SQL_INTERVAL), and SQL_DESC_DATETIME_INTERVAL_CODE field is set to the proper subcode.

SQL_DESC_DATETIME_INTERVAL_CODE[AII]

This record field is SQLSMALLINT. It includes the subcode which specifies the datetime or interval data type when SQL_DESC_TYPE field is SQL_DATETIME or SQL_INTERVAL. It is the same for both SQL and C support it, the code includes the data type name such as "TYPE" or "C_TYPE" for datetime type, "CODE" replaced from "INTERVAL" or "C_INTERVAL" for interval types.

If SQL_DESC_TYPE and SQL_DESC_CONCISE_TYPE of the application descriptor are set to SQL_C_DEFAULT and the descriptor is not related to the statement handle, then the content of SQL_DESC_DATETIME_INTERVAL_CODE is not defined.

This field can set the datetime data types listed in the following table.

Datetime type	DATETIME_INTERVAL_CODE
SQL_TYPE_DATE SQL_C_TYPE_DATE	SQL_CODE_DATE

Datetime type	DATETIME_INTERVAL_CODE
SQL_TYPE_TIME SQL_C_TYPE_TIME	SQL_CODE_TIME
SQL_TYPE_TIMESTAMP SQL_C_TYPE_TIMESTAMP	SQL_CODE_TIMESTAMP

This field can set the interval data types listed in the following table.

Interval type	DATETIME_INTERVAL_CODE
SQL_INTERVAL_DAY SQL_C_INTERVAL_DAY	SQL_CODE_DAY
SQL_INTERVAL_DAY_TO_HOUR SQL_C_INTERVAL_DAY_TO_HOUR	SQL_CODE_DAY_TO_HOUR
SQL_INTERVAL_DAY_TO_MINUTE SQL_C_INTERVAL_DAY_TO_MINUTE	SQL_CODE_DAY_TO_MINUTE
SQL_INTERVAL_DAY_TO_SECOND SQL_C_INTERVAL_DAY_TO_SECOND	SQL_CODE_DAY_TO_SECOND
SQL_INTERVAL_HOUR SQL_C_INTERVAL_HOUR	SQL_CODE_HOUR
SQL_INTERVAL_HOUR_TO_MINUTE SQL_C_INTERVAL_HOUR_TO_MINUTE	SQL_CODE_HOUR_TO_MINUTE
SQL_INTERVAL_HOUR_TO_SECOND SQL_C_INTERVAL_HOUR_TO_SECOND	SQL_CODE_HOUR_TO_SECOND
SQL_INTERVAL_MINUTE SQL_C_INTERVAL_MINUTE	SQL_CODE_MINUTE
SQL_INTERVAL_MINUTE_TO_SECOND SQL_C_INTERVAL_MINUTE_TO_SECOND	SQL_CODE_MONUTE_TO_SECOND
SQL_INTERVAL_MONTH SQL_C_INTERVAL_MONTH	SQL_CODE_MONTH
SQL_INTERVAL_SECOND SQL_C_INTERVAL_SECOND	SQL_CODE_SECOND
SQL_INTERVAL_YEAR SQL_C_INTERVAL_YEAR	SQL_CODE_YEAR
SQL_INTERVAL_YEAR_TO_MONTH SQL_C_INTERVAL_YEAR_TO_MONTH	SQL_CODE_YEAR_TO_MONTH

SQL_DESC_DATETIME_INTERVAL_PRECISION[All]

This SQLINTEGER record field includes the interval leading precision if SQL_DESC_TYPE field is SQL_INTERVAL. When SQL_DESC_DATETIME_INTERVAL_CODE field is set to the interval data type, the field sets the default interval leading precision.

SQL_DESC_DISPLAY_SIZE[IRDs]

This read-only SQLINTEGER record field contains the maximum number of characters required to show the data from the column.

SQL_DESC_FIXED_PREC_SCALE[Implementation descriptors]

This read-only SQLSMALLINT record field sets SQL_TRUE if the column is the exact numeric column and it has non-zero scale and the fixed precision. Otherwise, it sets SQL_FALSE.

SQL_DESC_INDICATOR_PTR[Application descriptors]

This SQLLEN* record field in ARD represents the indicator variable. The variable includes SQL_NULL_DATE if the column value is NULL. For APD, the indicator variable is set to SQL_NULL_DATA to specify a dynamic factor as NULL, otherwise the variable is zero.

If SQL_DESC_INDICATOR_PTR field of ARD is NULL pointer, the driver prevents the information returned for whether the column is NULL. If the column is NULL and SQL_DESC_INDICATOR_PTR is NULL pointer, SQLSTATE 22002(Indicator variable required but not supplied) is returned when the driver creates the buffer after calling SQLFetch or SQLFetchScroll. If calling SQLFetch or SQLFetchScroll does not return SQL_SUCCESS or SQL_SUCCESS_WITH_INFO, the buffer content is not defined.

SQL_DESC_INDICATOR_PTR field determines whether to set the field represented by SQL_DESC_OCTET_LENGTH_PTR. If the column value is NULL, the driver sets the indicator variable to SQL_NULL_DATA. The field represented by SQL_DESC_OCTET_LENGTH_PTR is not set at that moment. If NULL is not returned while retrieving the data, the buffer represented by SQL_DESC_INDICATOR_PTR is set to 0, and the buffer represented by SQL_DESC_OCTET_LENGTH_PTR sets the data length.

If SQL_DESC_INDICATOR_PTR field of APD is NULL pointer, the application can not use the descriptor record to specify the argument as NULL.

This field is the deferred field. It is not used when the driver is set, but it is used when the driver displays NULL possibility (ARD) or determines the NULL possibility (APD).

SQL_DESC_LABEL[IRDs]

This read-only SQLCHAR* record field includes the label or mark of a column. If the column does not have label, then the variable contains the column name. If the column is not named or it can not use the label, then the variable includes an empty string.

SQL_DESC_LENGTH[AII]

This SQLULEN record field is the maximum length or actual length of the string or binary data in bytes. It is the maximum length of fixed length data type data or the actual length of variable length data type data. The value always excludes NULL termination character at the end of string. If its data type is SQL_TYPE_DATE, SQL_TYPE_TIME, SQL_TYPE_TIMESTAMP or SQL interval data type, the field has the string length of when datetime or interval value is rewritten to string.

The field value is different from the value of "length" defined in ODBC 2.x.

SQL_DESC_LITERAL_PREFIX[IRDs]

This read-only SQLCHAR* record field includes the characters recognized as a suffix by the character or the driver. The variable contains the empty string for the data type whose character suffix can

not be converted.

SQL_DESC_LOCAL_TYPE_NAME[Implementation descriptors]

This read-only SQLCHAR* record field includes the localized name in the data type, and it could be different from the regular name in the data type. If the localized name does not exist, an empty string is returned. The field is only for the purpose of displaying.

SQL_DESC_NAME[Implementation descriptor]

This SQLCHAR* record field includes the field alias in the row descriptor. If the column alias is not applied, the column name is returned. In some cases, the driver sets SQL_DESC_UNNAMED field to SQL_NAMED when setting SQL_DESC_NAME field. If neither column name nor column alias exist, the driver returns the empty string of SQL_DESC_NAME field, and sets SQL_DESC_UNNAME field to SQL_UNNAMED.

The application can set SQL_DESC_NAME field of IPD for an alias to specify the parameter name or stored named procedure parameter. SQL_DESC_NAME field of IRD is the read-only field. If the application tries to set this field, SQLSTATE HY091 (invalid descriptor field identifier) will be returned.

For IPD, if the driver does not support the named parameter, the field is not defined. If the driver supports the named parameter and specifies the parameter, the name of the parameter is returned to this field.

SQL_DESC_NULLABLE[Implementation descriptors]

For IRD, this read-only SQLSMALLINT record field is SQL_NULLABLE if the column has NULL, otherwise it is SQL_NO_NULLS. If it is unknown whether the column allows NULL, it is SQL_NULLABLE_UNKNOWN. The field exists particularly for the column in the result set.

For IPD, The field is always set to SQL_NULLABLE because the dynamic parameter can always be NULL and it can not be set by the application.

SQL_DESC_NUM_PREC_RADIX[AII]

This SQLINTEGER field has the value of 2 when SQL_DESC_TYPE field is the approximate numeric data type. It is because SQL_DESC_PRECISION field includes the number of bits. The field has the value of 10 when SQL_DESC_TYPE field is the exact numeric data type and SQL_DESC_PRECISION contains the number of decimal places. The field sets 0 for a non-numeric data type.

SQL_DESC_OCTET_LENGTH[AII]

This SQLLEN record field includes the length in bytes of a string or binary data type. For the fixed length character or binary data, it is the actual length in bytes. For the variable length character or binary data, it is the maximum length in bytes. The value does not include the empty string of NULL termination character for the implementation descriptor, and it includes the empty string of NULL termination character for the application descriptor. For the application data, the field contains the buffer size. For APD, the field is defined only for the output or input/output parameters.

SQL_DESC_OCTET_LENGTH_PTR[Application descriptors]

The SQLLEN* record field points to the variable including the total length in bytes of the dynamic argument (parameter descriptor) or the binding column values (row descriptor).

This value is ignored for all arguments excluding the string or binary data in APD. If the field is SQL_DESC_DATA_PTR, the dynamic argument should be terminated with NULL. The application sets the variable including the macro result of SQL_DATA_AT_EXEC or SQL_LEN_DATA_AT_EXEC in this record field of APD to indicate that the bound parameter is to be a data parameter at the run-time. If one or more fields exist, SQL_DESC_DATA_PTR can be set as the value which identifies the parameter required by the application, and which is helpful to determine the parameter.

If OCTET_LENGTH_PTR field of ARD is NULL pointer, the driver does not return the column length. If SQL_DESC_OCTET_LENGTH_PTR of APD is NULL pointer, the driver assumes that the string and binary values are terminated by NULL. (Binary values should not be terminated by NULL, but the length should be given to avoid data interruption.)

If SQLFetch or SQLFetchScroll which fills the buffer pointed by the field does not return SQL_SUCCESS or SQL_SUCCESS_WITH_INFO, the buffer content is not defined. It is the deferred field. The field is not immediately used, but it is used later when the driver displays or determines the data length in octet.

SQL_DESC_PARAMETER_TYPE[IRDs]

This SQLSMALLINT record field sets the input parameter to SQL_PARAM_INPUT, the input/output parameter to SQL_PARAM_INPUT_OUTPUT, the output parameter to SQL_PARAM_OUTPUT, the stream input/output parameter to SQL_PARAM_INPUT_OUTPUT_STREAM or the stream output parameter to SQL_PARAM_OUTPUT_STREAM. It is set to SQL_PARAM_INPUT by default.

SQL_DESC_PRECISION[AII]

This SQLSMALLINT record field includes the number of valid integers for the exact numeric data types, and it includes the number of bits in mantissa (the binary precision) for the approximate numeric data types. Or, it contains the number of valid integer of the fractional seconds parts of the SQL_TYPE_TIME, SQL_TYPE_TIMESTAMP, or SQL_INTERVAL_SECOND data type. The field is not defined for all other data types.

The field value is different from the "precision" value defined in ODBC 2.x.

SQL_DESC_ROWVER[Implementation descriptors]

This SQLSMALLINT record field indicates whether the column is automatically updated by DBMS when the row is updated (for example, "timestamp" in SQL Server). The record field value is set to SQL_TRUE for the row versioning column, otherwise it is set to SQL_FALSE. The column attribute is similar to setting and calling SQL_ROWVER in IdentifierType argument of SQLSpecialColumn to determine whether to automatically update column.

SQL_DESC_SCALE[AII]

This SQLSMALLINT record field includes the number of decimal places defined in the decimal and numeric data types. The field is not defined for all other data types.

The field value is different from the "scale" value defined in ODBC 2.x.

SQL_DESC_SCHEMA_NAME[IRDs]

This read-only SQLCHAR* record field includes the schema name of the base table that includes the column. If the column is an expression or a part of the view, the return value is dependent on the

driver. If the data source does not support the schema or can not identify the schema name, then this variable contains an empty string.

SQL_DESC_SEARCHABLE[IRDS]

This read-only SQLSMALLINT record field sets one of the following values.

- If the column can not be used in WHERE clause, it is SQL_PRED_NONE. (It is as same as SQL_UNSEARCHABLE in ODBC 2.X.)
- If the column can only be used with LIKE predicate in WHERE clause, it is SQL_PRED_CHAR.
- If the column can be used with all comparison operators except for LIKE in WHERE clause, it is SQL_PRED_BASIC. (It is as same as the value of SQL_EXCEPT_LIKE in ODBC 2.x.)
- If the column can be used with any comparison operator in WHERE clause, it is SQL_PRED_SEARCHABLE.

SQL_DESC_TABLE_NAME[IRDS]

This read-only SQLCHAR* record field includes the base table name which includes column. The return value is dependent on the driver if the column is an expression or a part of the view.

SQL_DESC_TYPE[AII]

This SQLSMALLINT record field includes an abbreviated SQL data types or C data types for all data types except for the interval and datetime data types. The field specifies SQL_DATETIME or SQL_INTERVAL for datetime and interval data types.

Whenever this field includes SQL_DATETIME or SQL_INTERVAL, SQL_DESC_DATETIME_INTERVAL_CODE field should include the appropriate subcode in the implied format. For datetime data types, SQL_DESC_TYPE includes SQL_DATETIME, and SQL_DESC_DATETIME_INTERVAL_CODE field includes the subcode that specifies the datetime data type. For interval data types, SQL_DESC_TYPE includes SQL_INTERVAL, and SQL_DESC_DATETIME_INTERVAL_CODE field includes the subcode that specifies the interval data type.

The values of SQL_DESC_TYPE and SQL_DESC_CONCISE_TYPE field are interdependent. When one of the fields is set, the other field should also be set. SQL_DESC_TYPE can be set by calling SQLSetDescField or SQLSetDescRec. SQL_DESC_CONCISE_TYPE can be set by calling SQLBindCol, SQLBindParameter or SQLSetDescField.

If SQL_DESC_TYPE is set to the implied data type other than the interval or datetime data type, SQL_DESC_CONCISE_TYPE field is set to the same value and SQL_DESC_DATETIME_INTERVAL_CODE is set to 0.

If SQL_DESC_TYPE is set to the long data type of datetime or interval data type (SQL_DATETIME or SQL_INTERVAL), SQL_DESC_DATETIME_INTERVAL_CODE field is set to the appropriate subcode, SQL_DESC_CONCISE_TYPE may be set to a value corresponding to the implied data type. If SQL_DESC_TYPE is set to one of the implied datetime or interval data type, SQLSTATE HY021 (Inconsistent descriptor information) is returned.

When SQL_DESC_TYPE is set by calling SQLBindCol, SQLBindParameter or SQLSetDescField, the next fields are set to the default values in the following table. The values of remaining fields in the sa

me record are not defined.

SQL_DESC_TYPE value	Setting other fields implicitly
SQL_CHAR, SQL_VARCHAR, SQL_C_CHAR, SQL_C_VARCHAR	SQL_DESC_LENGTH is set to 1. SQL_DESC_PRECISION is set to 0.
SQL_DATETIME	If SQL_DESC_DATETIME_INTERVAL_CODE is set to SQL_CODE_DATE or SQL_CODE_TIME, SQL_DESC_PRECISION is set to 0. If SQL_DESC_TIMESTAMP is set, SQL_DESC_PRECISION is set to 6.
SQL_DECIMAL, SQL_NUMERIC, SQL_C_NUMERIC	SQL_DESC_SCALE is set to 0. SQL_DESC_PRECISION is set to the implemented precision of each data type.
SQL_FLOAT, SQL_C_FLOAT	SQL_DESC_PRECISION is set to the default precision implemented in SQL_FLOAT.
SQL_INTERVAL	When SQL_DESC_DATETIME_INTERVAL_CODE is set to the interval data type, SQL_DESC_DATETIME_INTERVAL_PRECISION is set to 2 (default interval leading precision). When the interval has the part of seconds, SQL_DESC_PRECISION is set to 6 (the default interval seconds precision).

When the application sets the descriptor field by calling not `SQLSetDescRec` but `SQLSetDescField`, the application should define the data type firstly. Therefore other fields in the previous table are implicitly set. If it is not allowed to implicitly set any value, the application explicitly sets the value by calling `SQLSetDescField` or `SQLSetDescRec`.

SQL_DESC_TYPE_NAME[Implementation descriptors]

This read-only `SQLCHAR*` record field includes the data source dependent type name ("CHAR", "VARCHAR", etc.). If the data type name is unknown, the variable includes an empty string.

SQL_DESC_UNNAMED[Implementation descriptors]

If `SQL_DESC_NAME` field is set, the `SQLSMALLINT` record field in the row descriptor is set to one of `SQL_NAME` or `SQL_UNNAMED` by the driver. If `SQL_DESC_NAME` field does not include the column alias or if the column alias does not apply, the driver sets `SQL_DESC_UNNAMED` field to `SQL_UNNAMED`. If the application sets `SQL_DESC_NAME` field of IPD to the parameter name or alias, the driver sets `SQL_DESC_UNNAMED` field of IPD to `SQL_NAMED`. If neither column name nor does alias exist, the driver sets `SQL_DESC_UNNAMED` field of IPD to `SQL_UNNAMED`.

The application sets `SQL_DESC_UNNAMED` field of IPD to `SQL_UNNAMED`. If the application tries to set `SQL_DESC_UNNAMED` field of IPD to `SQL_NAMED`, the driver returns `SQLSTATE HY091` (Invalid descriptor field identifier). `SQLSTATE HY091` (Invalid descriptor field identifier) is returned if the read-only application tries to set `SQL_DESC_UNNAMED` field of IRD.

SQL_DESC_UNSIGNED[Implementation descriptors]

This read-only SQLSMALLINT record field is set to SQL_TRUE, if the column type is the unsigned or non-numeric data type. It is set to SQL_FALSE, if the column type is the signed data type.

SQL_DESC_UPDATABLE[IRDs]

The read-only SQLSMALLINT record field is set to one of the following values.

- If the result set column is read-only, it is SQL_ATTR_READ_ONLY.
- If the result set column is read and write, it is SQL_ATTR_WRITE.
- If the updatability for the result set column is unknown, it is SQL_ATTR_READWRITE_UNKNOWN.

SQL_DESC_UPDATABLE explains the updatability of the result set column (the column is not in the base table). The updatability of the column in the primary table which is a base of the result set columns may be different from the value in this field. The updatability is based on the data type, the user privileges and the result set definition. If it is not sure that the column can be updated, SQL_ATTR_READWRITE_UNKNOWN should be returned.

SQL_DESC_CHAR_LENGTH_UNITS[AIs]

This SQLSMALLINT record field indicates the length units of the column whose SQL types are SQL_CHAR, SQL_VARCHAR and SQL_LONGVARCHAR.

- SQL_CLU_CHARACTERS: The length unit is CHARACTER. For example, the length of data "문자열" is 3 if the encoding method is UHC(Unified Hangul Code).
- SQL_CLU_OCTETS: The length unit is OCTETS. For example, the length of data "문자열" is 6 if the encoding method is UHC(Unified Hangul Code).
- SQL_CLU_NONE: The length unit is undefined. It is the value which is returned for the SQL types excluding the SQL types listed above.

SQLGetDescRec

Conformance

Introduced version: ODBC 1.0

Standards compliance: ISO 92

Overview

SQLGetDescRec returns the current value or setting for the multiple fields of the descriptor record. The returned field describes the name, the data type, the column size or the argument data.

Syntax

```
SQLRETURN SQLGetDescRec(
    SQLHDESC      DescriptorHandle,
    SQLSMALLINT   RecNumber,
    SQLCHAR *     Name,
    SQLSMALLINT   BufferLength,
    SQLSMALLINT * StringLengthPtr,
    SQLSMALLINT * TypePtr,
    SQLSMALLINT * SubTypePtr,
    SQLLEN *      LengthPtr,
    SQLSMALLINT * PrecisionPtr,
    SQLSMALLINT * ScalePtr,
    SQLSMALLINT * NullablePtr);
```

Arguments

DescriptorHandle

[Input] It is the descriptor handle.

RecNumber

[Input] It is the descriptor record of the information which the application wants to retrieve. The record number 0 is set as the bookmark record and the descriptor record starts from 1. If RecNumber is equal to or smaller than SQL_DESC_COUNT, but the data for the column or parameter is not included in the row, SQLGetDescField returns the default value of the field.

Name

[Output] It is the buffer pointer which returns SQL_DESC_NAME for the descriptor record. If Name is NULL, StringLengthPtr returns the buffer length of Name (including null-termination character).

BufferLength

[Input] It is the length of name buffer.

StringLengthPtr

[Output] It is the pointer which returns the number of characters returnable in *Name buffer excluding null-termination character. If the number of characters are equal to or bigger than BufferLength, the data of *Name is truncated to BufferLength minus the length of a null-termination character, and is null-terminated.

TypePtr

[Output] It is the buffer pointer which returns the value of SQL_DESC_TYPE for the descriptor field.

SubTypePtr

[Output] It is the buffer pointer which returns the value of SQL_DESC_DATETIME_INTERVAL_CODE field for the record of SQL_DATETIME or SQL_INTERVAL type.

LengthPtr

[Output] It is the buffer pointer which returns the value of SQL_DESC_OCTET_LENGTH field for the descriptor field.

PrecisionPtr

[Output] It is the pointer which returns the value of SQL_DESC_PRECISION field for the descriptor record.

ScalePtr

[Output] It is the pointer which returns the value of SQL_DESC_SCALE field for the descriptor record.

NullablePtr

[Output] It is the pointer which returns the value of SQL_DESC_NULLABLE field for the descriptor record.

Returns

SQL_SUCCESS, SQL_SUCCESS_WITH_INFO, SQL_ERROR, SQL_NO_DATA, SQL_INVALID_HANDLE

If RecNumber is bigger than the number of current descriptor records, SQL_NO_DATA is returned. If DescriptorHandle is the IRD handle and the statement is on the preparation or execution state but related cursor does not exist, then SQL_NO_DATA is returned.

Diagnosis

SQLSTATE	Error	Description
01000	General Warning	It is a specific information message of the driver. (The function returns SQL_SUCCESS_WITH_INFO.)
01004	String data, right truncated	The length of *ValuePtr buffer is shorter than the length of the descriptor field value, so the length is truncated. The remaining length of the descriptor field is returned to *StringLengthPtr. (The function returns SQL_SUCCESS_WITH_INFO.)
07009	Invalid descriptor index	The fieldIdentifier argument is the record field, and the value of RecNumber argument is set to 0, and DescriptorHandle argument is the IPD handle. RecNumber argument is set to 0, and SQL_ATTR_USE_BOOKMARKS attribute is set to SQL_UB_OFF, and DescriptorHandle argument is the IRD handle. RecNumber argument is smaller than 0.
08S01	Communication link failure	Before the function processing is completed, the connection between the driver and the data source is failed.
HY000	General error	It is an error without any specific SQLSTATE.
HY001	Memory allocation error	It is a memory allocation error.
HY007	Associated statement is not prepared	DescriptorHandle is related to the IRD handle, and the related statement handle is not on the preparation or execution state.
HY010	Function sequence error	StatementHandle related to DescriptorHandle asynchronously executes the function and it is still executing the function when called. After calling SQLExecute, SQLExecDirect, then SQL_NEED_DATA is returned and the function is called before sending all data-at-execution variables. The function for the connection handle related to DescriptorHandle is called, and it is still executing when SQLGetDescRec is called.
HY013	Memory management error	The buffer size used as the argument is smaller than 0, or it can not access the memory.
HY117	Connection is suspended due to unknown transaction state. Only disconnect and read-only functions are allowed.	For more information about the suspended state, refer to SQLEndTran function.
HYT01	Connection timeout expired	The connection is expired before the data source responds to the request. The timeout can be set via SQL_ATTR_CONNECTION_TIMEOUT of SQLSetStmtAttr.
IM001	Driver does not support this function	The driver related to DescriptorHandle does not support the function.

Description

The application can call `SQLGetDescRec` to retrieve the following descriptor field value for a column or parameter.

- `SQL_DESC_NAME`
- `SQL_DESC_TYPE`
- `SQL_DESC_DATETIME_INTERVAL_CODE`
- `SQL_DESC_OCTET_LENGTH`
- `SQL_DESC_PRECISION`
- `SQL_DESC_SCALE`
- `SQL_DESC_NULLABLE`

`SQLGetDescRec` does not retrieve the header field value.

The application can set the argument corresponding to the null pointer field so that it prevents the return for the field setting.

When the application retrieves the value of the undefined field for the specific descriptor type by calling `SQLGetDescRec`, the function returns `SQL_SUCCESS`, but the return value for the field is not defined. For example, if `SQLGetDescRec` is called for `SQL_DESC_NAME` field or `SQL_DESC_NULLABLE` field of APD or ARD, then `SQL_SUCCESS` is returned but the field value is not defined.

When the application calls `SQLGetDescRec` to retrieve the value of the field which is defined as the specific descriptor type but is not set as the default, the function returns `SQL_SUCCESS`, but the field value is not defined. For more information, refer to **Initializing Descriptor Field** of `SQLSetDescField`.

Each field value can be retrieved separately by calling `SQLGetDescField`. For more information about the descriptor header or the fields in the record, refer to **SQLSetDescField**.

SQLGetDiagField

Conformance

Introduced version: ODBC 3.0

Standards compliance: ISO 92

Overview

SQLGetDiagField returns the current value of the record fields in the diagnostic data structure which contains an error, warning, and status information.

Syntax

```
SQLRETURN SQLGetDiagField(  
    SQLSMALLINT    HandleType,  
    SQLHANDLE      Handle,  
    SQLSMALLINT    RecNumber,  
    SQLSMALLINT    DiagIdentifier,  
    SQLPOINTER     DiagInfoPtr,  
    SQLSMALLINT    BufferLength,  
    SQLSMALLINT *  StringLengthPtr);
```

Arguments

HandleType

[Input] It is the handle type identifier which requires diagnostics. The identifier should be one of the followings.

- SQL_HANDLE_DBC
- SQL_HANDLE_DESC
- SQL_HANDLE_ENV
- SQL_HANDLE_STMT

Handle

[Input] It is the handle for the diagnostic data structure, of the type pointed by HandleType. If HandleType is SQL_HANDLE_ENV, the Handle can be the shared or non-shared environment handle.

RecNumber

[Input] It indicates the state record of the information found by the application. The status record starts from 1. If DiagIdentifier points any field of the diagnostic header, RecNumber is ignored. Otherwise, RecNumber should be bigger than 0.

DiagIdentifier

[Input] It refers to the diagnostic field whose value is returned. For more information, refer to **DiagIdentifier Argument** in the Description section.

DiagInfoPtr

[Output] It is the buffer pointer to which return the diagnostic information. The data type depends on the value of DiagIdentifier. If DiagInfoPtr is an integer type, the application should use the SQLULEN buffer and initialize it to 0 before calling the function because some drivers record only the lower 32-bits or 16-bits of the buffer and leave the upper bits intact. If DiagInfoPtr is NULL, StringLengthPtr returns the total number of returnable bytes excluding null-termination character in the buffer pointed by DiagInfoPtr.

BufferLength

[Input] If DiagIdentifier is the ODBC defined diagnosis, and DiagInfoPtr points to the string or binary buffer, the argument should be the length of DiagInfoPtr. If DiagIdentifier is the ODBC defined diagnosis field, and DiagInfoPtr is a number, BufferLength is ignored. If the value of DiagInfoPtr is the Unicode string (When calling SQLGetDiagFieldW), BufferLength should be an even number. If DiagIdentifier is a driver defined field, the application refers to the field characteristic to the driver manager by setting BufferLength argument. BufferLength can have the following values.

- If DiagInfoPtr is a string buffer pointer, BufferLength is the string length or SQL_NTS.
- If DiagInfoPtr is a binary buffer pointer, the application stores the macro result of SQL_LENG_BINARY_ATTR(length) in BufferLength. A negative number is stored in BufferLength.
- If DiagInfoPtr is not a string or binary buffer pointer, BufferLength should have the value of SQL_IS_POINTER.
- If *DiagInfoPtr is the fixed length data type, BufferLength is one of SQL_IS_INTEGER, SQL_IS_INTEGER, SQL_IS_SMALLINT, or SQL_IS_USMALLINT.

StringLengthPtr

[Output] It is the buffer pointer which returns the total length of bytes excluding the null-termination character which is returned to DiagInfoPtr for the character data. If the returnable length in bytes is equal to or bigger than BufferLength, the text in DiagInfoPtr is truncated to the length of BufferLength minus null-termination character.

Returns

SQL_SUCCESS, SQL_SUCCESS_WITH_INFO, SQL_ERROR, SQL_INVALID_HANDLE, SQL_NO_DATA

Diagnosis

SQLGetDiagField does not post the diagnostic record. The result of the return value is used as follows.

- SQL_SUCCESS: The function successfully returns the diagnosis information.
- SQL_SUCCESS_WITH_INFO: The data in the diagnostic field is truncated because *DiagInfoPtr is too small to store the requested diagnosis field. The application should compare BufferLength to the actual byte number stored in *StringLengthPtr to check whether the truncation occurred.
- SQL_INVALID_HANDLE: The handle is not valid for a type indicating HandleType.
- SQL_ERROR: One of the followings occurs.
 - DiagIdentifier argument does not have the valid value.
 - DiagIdentifier argument is one of SQL_DIAG_CURSOR_ROW_COUNT, SQL_DIAG_DYNAMIC_FUNCTION, SQL_DIAG_DYNAMIC_FUNCTION_CODE, SQL_DIAG_ROW_COUNT, and Handle is not the statement handle.
 - When DiagIdentifier refers to the diagnosis record field, RecNumber is a negative number or 0. RecNumber is ignored for the header field.
 - The requested value is a string, and BufferLength is smaller than 0.
 - If an asynchronous notification is used, the asynchronous execution of handle is not completed.
- SQL_NO_DATA: RecNumber is bigger than the number of diagnosis records for the handle specified in Handle. If the diagnosis record for handle does not exist, then the function returns SQL_NO_DATA for RecNumber of any positive number.

Description

The application generally calls SQLGetDiagField for one of the three purposes.

- To obtain specific error or warning information when a function returns SQL_ERROR or SQL_SUCCESS_WITH_INFO (SQLBrowseConnect function returns SQL_NEED_DATA.)
- To obtain the number of rows in the data source when insert, delete, or update operations were performed with a call to SQLExecute, SQLExecDirect, SQLBulkOperations or SQLSetPos. Or, to obtain the number of rows which exist in the current open cursor, if the driver can provide this information.
- To obtain the information of which function is executed by a calling SQLExecDirect or SQLExecute

Whenever the function is called, all ODBC functions can post 0 or more diagnosis records. Therefore, the application can call SQLGetDiagField after calling all functions. There is no limitation on the number of diagnosis records which can be stored at a time. SQLGetDiagField retrieves the diagnosis data structure specified in Handle and the most recent related diagnosis information. If the application calls another ODBC function instead of SQLGetDiagField or SQLGetDiagRec, diagnostic information obtained by the previous call of the same handle can be lost.

As long as SQLGetDiagField returns SQL_SUCCESS, the application can read the diagnosis record by increasing RecNumber. The number of state records is displayed on the header field of SQL_DIAG_NUMBER. Calling SQLGetDiagField does not affect the header and record field. As long as a function except for the d

Diagnostic function is not called, the application can retrieve a record field by calling `SQLGetDiagField` again using the same handle.

The application can call `SQLGetDiagField` anytime to return any diagnostic fields. If Handle is not the statement handle, `SQL_DIAG_CURSOR_ROW_COUNT` or `SQL_DIAG_ROW_COUNT` is excluded because it returns `SQL_ERROR`. If any diagnosis field is not defined, calling `SQLGetDiagField` returns `SQL_SUCCESS` and the undefined value.

API call other than the function executed asynchronously causes HY010 (Function sequence error). However, the error code is not retrieved before the asynchronous processing is completed.

HandleType Argument

Each handle type has the related diagnosis information, and `HandleType` argument refers to the handle type.

Some headers and record fields are not returned for the environment, connection, statement, descriptor handles. The handles which are not applicable are described in the following Header Fields and Record Fields tables.

If `HandleType` is `SQL_HANDLE_ENV`, the handle can be the shared or non-shared environment handle.

A specific header diagnosis field of the driver is not related to the environment handle.

The diagnosis header defined for the descriptor handle is only `SQL_DIAG_NUMBER` and `SQL_DIAG_RETURNCODE`.

DiagIdentifier Argument

The argument is the field identifier required in the diagnosis data structure. If `RecNumber` is equal to or bigger than 1, the data in the field is the diagnostic information returned by the function. If `RecNumber` is 0, the field is in the header of the diagnostic data structure, and it has the data related to the function call returning the diagnostic information, not the specific information.

The driver may define a driver-specific header and record fields in the diagnosis data structure.

ODBC 3.x application which uses ODBC 2.x driver can call `SQLGetDiagField` when `DiagIdentifier` argument is `SQL_DIAG_CLASS_ORIGIN`, `SQL_DIAG_CLASS_SUBCLASS_ORIGIN`, `SQL_DIAG_CONNECTION_NAME`, `SQL_DIAG_MESSAGE_TEXT`, `SQL_DIAG_NATIVE`, `SQL_DIAG_NUMBER`, `SQL_DIAG_RETURNCODE`, `SQL_DIAG_SERVER_NAME`, `SQL_DIAG_SQLSTATE`, and it returns `SQL_ERROR` for other diagnostic fields.

Header Field

DiagIdentifier	Return type	Returns
		This field contains the number of rows in the cursor. Its meaning depends on the information type of <code>SQLGetInfo</code> . The information type is <code>SQL_DYNAMI</code>

DiagIdentifier	Return type	Returns
SQL_DIAG_CURSOR_ROW_COUNT	SQLLEN	C_CURSOR_ATTRIBUTES2, SQL_FORWARD_ONLY_CURSOR_ATTRIBUTES2, SQL_KEYSET_CURSOR_ATTRIBUTES2, SQL_STATIC_CURSOR_ATTRIBUTES2, and it refers to the number of rows which can be used in each cursor type. (It is in SQL_CA2_CRC_EXACT and SQL_CA2_CRC_APPROXIMATE bits.) This field content is defined after calling the statement handle, SQLExecute, SQLExecDirect, or SQLMoreResults. SQLGetDiagField returns SQL_ERROR if DiagIdentifier is the statement handle except for SQL_DIAG_CURSOR_ROW_COUNT.
SQL_DIAG_DYNAMIC_FUNCTION	SQLCHAR *	It is a string which describes the SQL statements executing the basic function. The field content is defined after calling SQLExecute, SQLExecDirect, or SQLMoreResults. Calling SQLGetDiagField returns SQL_ERROR if DiagIdentifier is the statement handle except for SQL_DIAG_DYNAMIC_FUNCTION.
SQL_DIAG_DYNAMIC_FUNCTION_CODE	SQLINTEGER	It is the numeric code which describes the SQL statement executing the basic function. The field content is defined after calling SQLExecute, SQLExecDirect, or SQLMoreResults. Calling SQLGetDiagField returns SQL_ERROR if DiagIdentifier is the statement handle except for SQL_DIAG_DYNAMIC_FUNCTION_CODE.
SQL_DIAG_NUMBER	SQLINTEGER	It is the number of records which are in the usable state of the specified handles.
SQL_DIAG_RETURNCODE	SQLRETURN	It is the code returned by the function. The driver does not need to implement SQL_DIAG_RETURNCODE, and it is implemented by the driver manager. If the handle is not called by any function, SQL_SUCCESS is returned for SQL_DIAG_RETURNCODE.
SQL_DIAG_ROW_COUNT	SQLLEN	It is the number of rows which are affected by the INSERT, DELETE, UPDATE statement executed by SQLExecute, SQLExecDirect, SQLBulkOperations, or SQLSetPos. It is defined by the driver after cursor specification is executed. The field content is defined only for the statement handle. Calling SQLGetDiagField returns SQL_ERROR if DiagIdentifier is the statement handle except for SQL_DIAG_ROW_COUNT. The field data is also returned to RowCountPtr of SQLRowCount. The row count returned to SQLRowCount among data of this field remains the same until statement is set back to the prepared or allocated state, but it is set again after calling the non-diagnostic function.

Record Field

DiagIdentifier	Return type	Returns
SQL_DIAG_CLASSES_ORIGIN	SQLCHAR *	It is a string representing the document which defines the class of SQLSTATE value in this record. This value is ISO 9075 for all SQLSTATE defined by the Open Group and the ISO call level interface. This value is ODBC 3.0 for the s

DiagIdentifier	Return type	Returns
		pecified ODBC SQLSTATE (for All SQLSTATE classes having IM).
SQL_DIAG_COLUMN_NUMBER	SQLINTEGER	<p>If SQL_DIAG_ROW_NUMBER is the valid row number in the row set or parameter set, this field is a value representing the column number of result set or parameter number of parameter sets. The result set column number always starts from 1. If the state record is related to the bookmark column, the field can be 0. The parameter number starts from 1.</p> <p>If the state record is not related to the column number or to the parameter number, the value can be SQL_NO_COLUMN_NUMBER. If the driver can not determine the column number or parameter number related to the record, the field value is SQL_COLUMN_NUMBER_UNKNOWN.</p> <p>The field content is defined only for the statement handle.</p>
SQL_DIAG_CONNECTION_NAME	SQLCHAR *	It is the string representing the connection name related to the diagnostic record. The field is the driver definition. The field is a zero-length string for the diagnosis which is not related to any server and the environment handle related to the diagnostic data structure.
SQL_DIAG_MESSAGE_TEXT	SQLCHAR *	It is an information message about the error or warning.
SQL_DIAG_NATIVE	SQLINTEGER	It is the driver/ data source-specific native error code. If native error code does not exist, the driver returns 0.
SQL_DIAG_ROW_NUMBER	SQLLEN	<p>This field contains the row number in the row set or the parameter number in the parameter set which is related to the state record. The row number and parameter number start from 1. If the state record is not related to the row number or parameter number, the field value is SQL_NO_ROW_NUMBER. If the driver can not determine the row number or parameter number related to the record, the field value is SQL_ROW_NUMBER_UNKNOWN.</p> <p>The field content is defined only for the statement handle.</p>
SQL_DIAG_SERVER_NAME	SQLCHAR *	It is the string representing the server name related to the diagnostic record. It is as same as the value returned by calling SQLGetInfo with SQL_DATA_SOURCE_NAME option. The field is a zero-length string for the diagnosis which is not related to any server and the environment handle related to the diagnostic data structure.
SQL_DIAG_SQLSTATE	SQLCHAR *	It is SQLSTATE diagnostic code of the five characters.
SQL_DIAG_SUBCLASS_ORIGIN	SQLCHAR *	<p>It is the string of the same format and valid value with SQL_DIAG_CLASS_ORIGIN which is defines the subclass part of the SQLSTATE code.</p> <p>The specific ODBC SQLSTATE codes in ODBC 3.0 are as follows. 01S00, 01S01, 01S02, 01S06, 01S07, 07S01, 08S01, 21S01, 21S02, 25S01, 25S02, 25S03, 42S01, 42S02, 42S11, 42S12, 42S21, 42S22, HY095, HY097, HY098, HY099, HY100, HY101, HY105, HY107, HY109, HY110, HY111,</p>

DiagIdentifier	Return type	Returns
		HYT00, HYT01, IM001, IM002, IM003, IM004, IM005, IM006, IM007, IM008, IM010, IM011, IM012.

Dynamic Function Field Value

SQL statement executed	Value of SQL_DIAG_DYNAMIC_FUNCTION	Value of SQL_DIAG_DYNAMIC_FUNCTION_CODE
alter-domain-statement	"ALTER DOMAIN"	SQL_DIAG_ALTER_DOMAIN
alter-table-statement	"ALTER TABLE"	SQL_DIAG_ALTER_TABLE
assertion-definition	"CREATE ASSERTION"	SQL_DIAG_CREATE_ASSERTION
character-set-definition	"CREATE CHARACTER SET"	SQL_DIAG_CREATE_CHARACTER_SET
collation-definition	"CREATE COLLATION"	SQL_DIAG_CREATE_COLLATION
create-index-statement	"CREATE INDEX"	SQL_DIAG_CREATE_INDEX
create-table-statement	"CREATE TABLE"	SQL_DIAG_CREATE_TABLE
create-view-statement	"CREATE VIEW"	SQL_DIAG_CREATE_VIEW
cursor-specification	"SELECT CURSOR"	SQL_DIAG_SELECT_CURSOR
delete-statement-positioned	"DYNAMIC DELETE CURSOR"	SQL_DIAG_DYNAMIC_DELETE_CURSOR
delete-statement-searched	"DELETE WHERE"	SQL_DIAG_DELETE_WHERE
domain-definition	"CREATE DOMAIN"	SQL_DIAG_CREATE_DOMAIN
drop-assertion-statement	"DROP ASSERTION"	SQL_DIAG_DROP_ASSERTION
drop-character-set-stmt	"DROP CHARACTER SET"	SQL_DIAG_DROP_CHARACTER_SET
drop-collation-statement	"DROP COLLATION"	SQL_DIAG_DROP_COLLATION
drop-domain-statement	"DROP DOMAIN"	SQL_DIAG_DROP_DOMAIN
drop-index-statement	"DROP INDEX"	SQL_DIAG_DROP_INDEX
drop-schema-statement	"DROP SCHEMA"	SQL_DIAG_DROP_SCHEMA
drop-table-statement	"DROP TABLE"	SQL_DIAG_DROP_TABLE
drop-translation-statement	"DROP TRANSLATION"	SQL_DIAG_DROP_TRANSLATION
drop-view-statement	"DROP VIEW"	SQL_DIAG_DROP_VIEW
grant-statement	"GRANT"	SQL_DIAG_GRANT
insert-statement	"INSERT"	SQL_DIAG_INSERT
ODBC-procedure-extension	"CALL"	SQL_DIAG_CALL
revoke-statement	"REVOKE"	SQL_DIAG_REVOKE
schema-definition	"CREATE SCHEMA"	SQL_DIAG_CREATE_SCHEMA
translation-definition	"CREATE TRANSLATION"	SQL_DIAG_CREATE_TRANSLATION
update-statement-positioned	"DYNAMIC UPDATE CURSOR"	SQL_DIAG_DYNAMIC_UPDATE_CURSOR
update-statement-searched	"UPDATE WHERE"	SQL_DIAG_UPDATE_WHERE
Unknown	empty string	SQL_DIAG_UNKNOWN_STATEMENT

Sequence of Status Record

The state record is sequentially located according to the row number and diagnostic type. The driver manager determines the final step of returning the created state record.

If the diagnostic record is posted by the driver manager and the driver, the driver manager is responsible for determining the order of the diagnostic records.

If two or more state records exist, the order of the record is determined first by the row number. The following rules are applied to determine the order of the diagnostic record by the row.

- The record not corresponding to any row because SQL_NO_ROW_NUMBER is defined as -1, is positioned in front of the record corresponding to the particular row.
- The record which does not know the row number because SQL_ROW_NUMBER_UNKNOWN is defined as -2 is positioned in front of all the other records.
- For all record which are related to a particular row, the records are sorted by the value of SQL_DIAG_ROW_NUMBER. All errors and warnings for the first row are listed, and then all the errors and warnings for the next row are sequentially listed.



If SQLSTATE 01S01 is returned by the ODBC 2.x driver, or SQLSTATE 01S01 is returned by the ODBC 3.x driver when calling SQLExtendedFetch or when calling SQLSetPos for the cursor in SQLExtendedFetch, then the ODBC 3.x driver manager does not require the state record in a diagnosis queue.

Within each row, or for all rows which do not correspond to the row or which do not know the row number or which have the row number as same as SQL_NO_ROW_NUMBER, the first record listed is determined by using the set of ordering rules. After the first record, the order of other records which affect the row is not defined. The application can not assume that an error precedes a warning after the first record. The application should check the complete diagnostic data structure to get the complete information about the failed function call.

The following rules are used to determine the first record in the row. The highest grade record is the first record. The record source (driver manager, driver, gateway, etc.) does not affect the determination of the record ranks.

- Errors state record describing the error has the highest grade. The following rules are applied to align the errors.
 - The record which refers to the transaction failure or possible transaction failure has a higher grade than any other record.
 - If two or more records describe the same error condition, SQLSTATE defined in the Open Group CLI specifications(Class 03 ~ HZ) has a higher grade than SQLSTATE defined in ODBC and the driver.

- Implementation-defined No Data Values state record which describes No Data values (class 02) defined by the driver has the second highest rank.
- Warnings state record(class 01) describing the warning has the lowest grade. If two or more records describe the same error condition, SQLSTATE defined in the Open Group CLI specifications has a higher grade than SQLSTATE defined in ODBC and the driver.

SQLGetDiagRec

Conformance

Introduced version: ODBC 3.0

Standards compliance: ISO 92

Overview

SQLGetDiagRec returns the current value of the record field of the diagnostic data source (related to the specified handle) which contains an error, warning, state information.

Syntax

```
SQLRETURN SQLGetDiagRec(  
    SQLSMALLINT    HandleType,  
    SQLHANDLE      Handle,  
    SQLSMALLINT    RecNumber,  
    SQLCHAR *      SQLState,  
    SQLINTEGER *   NativeErrorPtr,  
    SQLCHAR *      MessageText,  
    SQLSMALLINT    BufferLength,  
    SQLSMALLINT *  TextLengthPtr);
```

Arguments

HandleType

[Input] It is the handle type identifier of which diagnosis is required. The identifier should be one of the followings.

- SQL_HANDLE_DBC
- SQL_HANDLE_DESC
- SQL_HANDLE_ENV
- SQL_HANDLE_STMT

Handle

[Input] It is the handle for the diagnosis data structure of the type pointed by HandleType. If HandleType is SQL_HANDLE_ENV, the handle can be the shared or non-shared environment handle.

RecNumber

[Input] It indicates the state record of the information found by the application. The number of the state record starts from 1.

SQLState

[Output] It is the buffer pointer which returns five character SQLSTATE code for the diagnostic record RecNumber. The first two characters indicate a class and the next three characters indicate a subclass. The information is in the SQL_DIAG_SQLSTATE diagnostic field.

NativeErrorPtr

[Output] It is the buffer pointer which returns the specific native error code to the data source. The information is in the diagnostic field SQL_DIAG_NATIVE.

MessageText

[Output] It is the buffer point which returns the diagnostic message text string. The information is in the SQL_DIAG_MESSAGE_TEXT diagnostic field.

If MessageText is NULL, TextLegnthPtr returns the total number of returnable characters (excluding null-termination character) to the buffer pointed by MessageText.

BufferLength

[Input] It is the length of characters within *MessageText buffer. Diagnostic message text does not have the maximum length.

TextLegnthPtr

[Output] It is the buffer pointer to which the total number of characters returnable to *MessageText is returned (excluding null-termination character). If the number of returnable characters is bigger than BufferLength, the diagnostic message text of *MessageText is truncated to the length of BufferLength minus null-termination character.

Returns

SQL_SUCCESS, SQL_SUCCESS_WITH_INFO, SQL_ERROR, SQL_INVALID_HANDLE

Diagnosis

SQLGetDiagRec does not post the diagnostic record. It uses the result of the return value as follows.

- SQL_SUCCESS: The function successfully returns the diagnosis information.
- SQL_SUCCESS_WITH_INFO: *MessageText buffer is too small to store the requested diagnosis message. The diagnostic record is not generated. The application should compare BufferLength to the actual byte number stored in *StringLengthPtr to check whether the truncation occurred.
- SQL_INVALID_HANDLE: The handle is not valid for a type indicating HandleType.
- SQL_ERROR: One of the followings occurs.
 - RecNumber argument is the negative number or 0.

- BufferLength is smaller than 0.
- If an asynchronous notification is used, the asynchronous execution of handle is not completed.
- SQL_NO_DATA: RecNumber is bigger than the number of diagnosis records for the handle specified in Handle. If the diagnosis record for handle does not exist, then the function returns SQL_NO_DATA for RecNumber of any positive number.

Description

When the ODBC function returns SQL_ERROR or SQL_SUCCESS_WITH_INFO, generally the application calls SQLGetDiagRec. However, the application can call the SQLGetDiagRec after any function is called because any ODBC function can post zero or more diagnostic records. The application can call SQLGetDiagRec several times to return some or all records in the diagnostic data structure. ODBC does not have limit on the number of diagnostic records which can be stored at a time.

SQLGetDiagRec can not be used to return the header field of the diagnostic data structure. (RecNumber should be bigger than 0.) The application should call SQLGetDiagField instead of SQLGetDiagRec.

SQLGetDiagRec retrieves only the handle specified to Handle and the latest related diagnostic information. If the application calls any other ODBC function (excluding SQLGetDiagRec, SQLGetDiagField, SQLERROR), diagnostic information from the previous call of the same handle is lost.

The application can repeatedly retrieve the diagnostic record by increasing RecNumber as long as SQLGetDiagRec returns SQL_SUCCESS. SQLGetDiagRec call do not affect the header and record fields. If intervention of other function does not exist except for SQLGetDiagRec, SQLGetDiagField, SQLERROR, then the application can call SQLGetDiagRec again to retrieve the field in the record. The application can retrieve the total number of diagnostic records available by calling SQLGetDiagField to retrieve the value of the SQL_DIAG_NUMBER field, and calling SQLGetDiagRec several times.

HandleType Argument

Each handle type has the related diagnosis information, and HandleType argument refers to the Handle type.

Some header and record fields are not returned for the environment, connection, statement, descriptor handles. In the header field and record field table of **SQLGetDiagField**, the inappropriate handles in the field are described.

If HandleType is SQL_HANDLE_SENV which indicates the shared environment handle, then calling SQLGetDiagRec returns SQL_INVALID_HANDLE. If HandleType is SQL_HANDLE_ENV, then the handle can be the shared or non-shared environment handle.

SQLGetEnvAttr

Conformance

Introduced version: ODBC 3.0

Standards compliance: ISO 92

Overview

SQLGetEnvAttr returns the current settings of the environment attributes.

Syntax

```
SQLRETURN SQLGetEnvAttr(  
    SQLHENV      EnvironmentHandle,  
    SQLINTEGER   Attribute,  
    SQLPOINTER  ValuePtr,  
    SQLINTEGER   BufferLength,  
    SQLINTEGER * StringLengthPtr);
```

Arguments

EnvironmentHandle

[Input] It is the environment handle.

Attribute

[Input] It is the attribute to be retrieved.

ValuePtr

[Output] It is the buffer pointer in which to return the current attribute value specified by Attribute. If ValuePtr is NULL, StringLengthPtr returns the total number of bytes returnable to the buffer pointed by ValuePtr (excluding null-termination character).

BufferLength

[Input] If ValuePtr points to a string, the argument should be the length of *ValuePtr. If ValuePtr is an integer, BufferLength is ignored. If *ValuePtr (when SQLGetEnvAttrW is called) is a unicode string, BufferLength should be an even number. If the attribute value is not a string, BufferLength is not used.

StringLengthPtr

[Output] It is the buffer pointer to which the total number of bytes to be returned to *ValuePtr (excluding null-termination character) is returned. If ValuePtr is the null pointer, the length is not returned. If the attribute value is a string and the number of bytes returnable is equal to or bigger than BufferLength, *ValuePtr is truncated to the length of BufferLength minus the length of a null-termination character and is a null-terminated by the driver.

Returns

SQL_SUCCESS, SQL_SUCCESS_WITH_INFO, SQL_NO_DATA, SQL_ERROR, SQL_INVALID_HANDLE

Diagnosis

SQLSTATE	Error	Description
01000	General Warning	It is the driver-specific informational message. (The function returns SQL_SUCCESS_WITH_INFO.)
01004	String data, right truncated	The data returned to *ValuePtr is truncated to the length of BufferLength minus null-termination character. The remaining length of string is returned to *StringLengthPtr. (The function returns SQL_SUCCESS_WITH_INFO.)
HY000	General error	It is an error without any specific SQLSTATE.
HY001	Memory allocation error	It is a memory allocation error.
HY010	Function sequence error	SQL_ATTR_ODBC_VERSION is not set through SQLSetEnvAttr. If SQLAllocHandleStd is used, then SQL_ATTR_ODBC_VERSION does not need to be explicitly set.
HY013	Memory management error	The size of buffer used as an argument is smaller than 0 or it can not access the memory.
HY092	Invalid attribute/option identifier	The value specified in attribute argument is not valid for ODBC version supported by the driver.
HY117	Connection is suspended due to unknown transaction state. Only disconnect and read-only functions are allowed.	For more information about the suspended state, refer to SQLEndTran .
HYC00	Optional feature not implemented	The value specified in attribute argument is valid for ODBC environment of ODBC version supported by the driver, but it is not supported by the driver.
IM001	Driver does not support this function	The driver related to DescriptorHandle does not support the function.

Description

The driver-specific environment attributes does not exist. If Attribute specifies the attribute which returns a string, ValuePtr should be the buffer pointer whose string is returned. The maximum string length including the null-termination character is the BufferLength in bytes.

SQLGetEnvAttr can be called at any point between the allocation and release of the environment handle. All environment attributes successfully allocated by the application for the environment are maintained until SQLFreeHandle is called with Handletype of SQL_HANDLE_ENV in EnvironmentHandle. It is recommended to use only one environment handle.



SQL_ATTR_OUTPUT_NTS environment attributes are supported by the application which complies with standards. If SQLGetEnvAttr is called, ODBC 3.x driver manager always returns SQL_TRUE for the attribute. SQL_ATTR_OUTPUT_NTS is set to SQL_TRUE only by calling SQLSetEnvAttr.

The following table describes attribute list which can be queried through SQLGetEnvAttr.

Attribute	ValuePtr Content
SQL_ATTR_CONNECTION_POOLING (ODBC 3.8)	It is not supported by the driver.
SQL_ATTR_CP_MATCH (ODBC 3.0)	It is not supported by the driver.
SQL_ATTR_ODBC_VERSION (ODBC 3.0)	<p>It is 32-bit integer which indicates whether a particular feature is operated as ODBC 2.x or ODBC 3.x. The following values are used to set the attribute.</p> <p>SQL_OV_ODBC3_80 = The driver manager or driver performs the following ODBC 3.8 behaviors.</p> <ul style="list-style-type: none"> The driver expects and returns ODBC 3.x code values for DATE, TIME, TIMESTAMP. The driver returns ODBC 3.x SQLSTATE codes when SQLError, SQLGetDiagField or SQLGetDiagRec is called. CatalogName argument of SQLTables allows the pattern matching. <p>SQL_OV_ODBC3 = The driver manager or driver performs the following ODBC 3.x behaviors.</p> <ul style="list-style-type: none"> The driver expects and returns ODBC 3.x code values for DATE, TIME, TIMESTAMP. The driver returns ODBC 3.x SQLSTATE codes when SQLError, SQLGetDiagField or SQLGetDiagRec is called. CatalogName argument of SQLTables allows the pattern matching. The driver manager does not support C data type extensibility.

Attribute	ValuePtr Content
	<p>SQL_OV_ODBC2 = The driver manager or driver performs the following ODBC 2.x behaviors. It is very helpful when ODBC 2.x applications operate in the ODBC 3.x driver.</p> <ul style="list-style-type: none"> • The driver expects and returns ODBC 2.x code values for DATE, TIME, TIMESTAMP. • The driver returns ODBC 2.x SQLSTATE codes when SQLError, SQLGetDiagField or SQLGetDiagRec is called. • CatalogName argument of SQLTables does not allow the pattern matching. • The driver manager does not support C data type extensibility. <p>An application should set this environment attribute before it calls any function which has an SQLHENV argument or a function which returns SQLSTATE HY010 (Function sequence error). The driver should specify whether the additional operations for the environmental flag exists.</p>
SQL_ATTR_OUTPUT_NTS (ODBC 3.0)	It is not supported by the driver.

SQLGetFunctions

Conformance

Introduced version: ODBC 1.0

Standards compliance: ISO 92

Overview

SQLGetFunctions returns information whether the driver supports the given ODBC function. The function is implemented by the driver manager or the driver. If the driver implements SQLGetFunctions, the driver manager will call the function in the driver.

Syntax

```
SQLRETURN SQLGetFunctions(
    SQLHDBC          ConnectionHandle,
    SQLUSMALLINT     FunctionId,
    SQLUSMALLINT *   SupportedPtr);
```

Arguments

ConnectionHandle

[Input] It is the connection handle.

FunctionId

[Input] It is the #define value which identifies the ODBC function related to SQL_API_ODBC3_ALL_FUNCTIONS or SQL_API_ALL_FUNCTIONS. SQL_API_ODBC3_ALL_FUNCTIONS is used in ODBC 3.x application to determine to support the function in ODBC 3.x and in earlier version. SQL_API_ALL_FUNCTIONS is used in ODBC 2.x to determine whether to support the function in ODBC 2.x and in earlier version.

For more information about the value list of #define which identifies the ODBC function, refer to the table in the description section.

SupportedPtr

[Output] If FunctionId identifies the single ODBC, SupportedPtr points to the single SQLUSMALLINT value. If the specified function is supported by the driver, it is SQL_TRUE. Otherwise, it is SQL_FALSE.

If FunctionId is SQL_API_ODBC3_ALL_FUNCTIONS, SupportedPtr points to the SQLSMALLINT array

which has the number of elements equal to `SQL_API_ODBC3_ALL_FUNCTIONS_SIZE`. The array is managed by the driver manager as 4000-bit bitmap which can be used to determine to support the function in ODBC 3.x or in earlier version. `SQL_FUNC_EXISTS` macro is called to check whether the function is supported. ODBC 3.x application can call `SQLGetFunctions` by using `SQL_API_ODBC3_ALL_FUNCTIONS` in preparation for ODBC 2.x or ODBC 3.x.

If `FunctionId` is `SQL_API_ALL_FUNCTIONS`, `SupportedPtr` points to the array with 100 elements. The array is indexed by `#define` value used by the `FunctionId` to identify each ODBC function, and several elements are reserved without being used. If the function in ODBC 2.x or earlier version is supported by the driver, the element is `SQL_TRUE`. If the ODBC function is not supported by the driver or it is not the ODBC function, the element is `SQL_FALSE`.

The array that is returned to `*SupportedPtr` uses the 0-based indexing.

Returns

`SQL_SUCCESS`, `SQL_SUCCESS_WITH_INFO`, `SQL_ERROR`, `SQL_INVALID_HANDLE`

Diagnosis

SQLSTATE	Error	Description
01000	General Warning	It is the driver-specific informational message. (The function returns <code>SQL_SUCCESS_WITH_INFO</code> .)
08S01	Communication link failure	Before the function processing is completed, the connection between the driver and the data source is failed.
HY000	General error	It is an error without any specific SQLSTATE.
HY001	Memory allocation error	It is a memory allocation error.
HY010	Function sequence error	<p><code>SQLGetFunctions</code> is called before <code>SQLConnect</code>, <code>SQLBrowseConnect</code>, <code>SQLDriverConnect</code>.</p> <p><code>SQLBrowseConnect</code> is called for <code>ConnectionHandle</code>, and <code>SQL_NEED_DATA</code> is returned.</p> <p><code>SQLGetfunction</code> is called before <code>SQLBrowseConnect</code> returns <code>SQL_SUCCESS_WITH_INFO</code> or <code>SQL_SUCCESS</code>.</p> <p><code>SQLExecute</code>, <code>SQLExecDirect</code>, <code>SQLMoreResults</code> is called for <code>ConnectionHandle</code>, and <code>SQL_PARAM_DATA_AVAILABLE</code> is returned. The function is called, before the data retrieves all streamed parameters.</p>
HY013	Memory management error	The size of buffer used as an argument is smaller than 0, or it can not access the memory.
HY095	Function type out of range	<code>FunctionId</code> value is not valid.

SQLSTATE	Error	Description
HY117	Connection is suspended due to unknown transaction state. Only disconnect and read-only functions are allowed.	For more information about the suspended state, refer to SQLEndTran .
HYT01	Connection timeout expired	The connection is expired before the data source response to the request. The connection timeout interval can be set to SQL_ATTR_CONNECTION_TIMEOUT through SQLSetConnectAttr .
IM001	Driver does not support this function	The driver related to DescriptorHandle does not support the function.

Description

SQLGetFunctions returns the supported **SQLGetFunctions**, **SQLDataSources**, **SQLDrivers**. This is because the function is implemented in the driver manager. If an unicode function exist, the driver manager maps the ANSI function corresponding to the Unicode function. If an ANSI function exist, the driver manager maps the unicode function corresponding to the ANSI function.

The following is the list of valid values for **FunctionId** for the functions which comply with ISO 92 standards compliance level.

- **SQL_API_SQLALLOCHANDLE**
- **SQL_API_SQLBINDCOL**
- **SQL_API_SQLCANCEL**
- **SQL_API_SQLCLOSECURSOR**
- **SQL_API_SQLCOLATTRIBUTE**
- **SQL_API_SQLCONNECT**
- **SQL_API_SQLCOPYDESC**
- **SQL_API_SQLDATASOURCES**
- **SQL_API_SQLDESCRIBECOL**
- **SQL_API_SQLDISCONNECT**
- **SQL_API_SQLDRIVERS**
- **SQL_API_SQLENDTRAN**
- **SQL_API_SQLEXECDIRECT**
- **SQL_API_SQLEXECUTE**
- **SQL_API_SQLFETCH**
- **SQL_API_SQLFETCHSCROLL**
- **SQL_API_SQLFREEHANDLE**
- **SQL_API_SQLFREESTMT**

- SQL_API_SQLGETCONNECTATTR
- SQL_API_SQLGETCURSORNAME
- SQL_API_SQLGETDATA
- SQL_API_SQLGETDESCFIELD
- SQL_API_SQLGETDESCREC
- SQL_API_SQLGETDIAGFIELD
- SQL_API_SQLGETDIAGREC
- SQL_API_SQLGETENVATTR
- SQL_API_SQLGETFUNCTIONS
- SQL_API_SQLGETINFO
- SQL_API_SQLGETSTMTATTR
- SQL_API_SQLGETTYPEINFO
- SQL_API_SQLNUMRESULTCOLS
- SQL_API_SQLPARAMDATA
- SQL_API_SQLPREPARE
- SQL_API_SQLPUTDATA
- SQL_API_SQLROWCOUNT
- SQL_API_SQLSETCONNECTATTR
- SQL_API_SQLSETCURSORNAME
- SQL_API_SQLSETDESCFIELD
- SQL_API_SQLSETDESCREC
- SQL_API_SQLSETENVATTR
- SQL_API_SQLSETSTMTATTR

The following is the list of valid values for FunctionId for the functions which comply with open group standard compliance level.

- SQL_API_SQLCOLUMNS
- SQL_API_SQLSPECIALCOLUMNS
- SQL_API_SQLSTATISTICS
- SQL_API_SQLTABLES

The following is the list of valid values for FunctionId for the functions which comply with ODBC standard compliance level.

- SQL_API_SQLBINDPARAMETER
- SQL_API_SQLBROWSECONNECT
- SQL_API_SQLBULKOPERATIONS^[1]
- SQL_API_SQLCOLUMNPRIVILEGES
- SQL_API_SQLDESCRIBEPARAM
- SQL_API_SQLDRIVERCONNECT
- SQL_API_SQLFOREIGNKEYS

- SQL_API_SQLMORERESULTS
- SQL_API_SQLNATIVESQL
- SQL_API_SQLNUMPARAMS
- SQL_API_SQLPRIMARYKEYS
- SQL_API_SQLPROCEDURECOLUMNS
- SQL_API_SQLPROCEDURES
- SQL_API_SQLSETPOS
- SQL_API_SQLTABLEPRIVILEGES

[1] When operating with ODBC 2.x driver, SQLBulkOperations is supported and returned only when the both of the followings are true. ODBC 2.x driver supports SQLSetPos, and the SQL_POS_OPERATIONS information type returns SQL_POS_ADD bit as set.

The valid value of FunctionId for the functions introduced after ODBC 3.8 is SQL_API_SQLCANCELHANDLE. [2]

[2] SQLCancelHandle is returned only when the driver supports both of SQLCancel and SQLCancelHandle. If SQLCancel is supported but SQLCancelHandle is not supported, the application can still call SQLCancelHandle for the statement handle, because it is mapped to SQLCancel.

SQL_FUNC_EXISTS Macro

SQL_FUNC_EXISTS (SupportedPtr, FunctionID) macro is used to call SQLGetFunctions to SQL_API_ODBC3_ALL_FUNCTIONS by using FunctionId argument and to check the function supported in ODBC 3.x or in the earlier version. The application uses SQL_FUNC_EXISTS by setting SupportedPtr transferred from SQLGetFunctions to SupportedPtr argument and by setting the FunctionID argument to the #define for the function. If the function is supported, SQL_FUNC_EXISTS returns SQL_TRUE. Otherwise, it returns SQL_FALSE.



When operating with ODBC 2.x driver, ODBC 3.x driver manager returns SQL_TRUE for SQLAllocHandle and SQLFreeHandle. It is because SQLAllocHandle is mapped to SQLAllocEnv, SQLAllocConnect or SQLAllocStmt, and SQLFreeHandle is mapped to SQLFreeEnv, SQLFreeConnect or SQLFreeStmt. However, although SQLFreeHandle returns SQL_TRUE, SQLFreeHandle whose SQL_HANDLE_DESC is used as HandleType argument is not supported. It is because function mapped to ODBC 2.x function for this case does not exist.

SQLGetGroupCount

Conformance

Standards compliance: It is not available.

Overview

SQLGetGroupCount returns the number of cluster groups.

Syntax

```
SQLRETURN SQLGetGroupCount(
    SQLHDBC      ConnectionHandle,
    SQLINTEGER * GroupCountPtr );
```

Arguments

ConnectionHandle

[Input] It is the connection handle.

GroupCountPtr

[Output] It is the number of cluster groups.

Returns

SQL_SUCCESS, SQL_NO_DATA, SQL_ERROR, SQL_INVALID_HANDLE

Diagnosis

SQLSTATE	Error	Description
08003	Connection not open	ConnectionHandle is not in a connected state.
08S01	Communication link failure	Before the function processing is completed, the connection between the driver and the data source is failed.
HY010	Function sequence error	This function should be called only when the connection property SQL_ATTR_LOCALITY_AWARE_TRANSACTION is set.

Description

SQLGetGroupCount can be called only when the connection property SQL_ATTR_LOCALITY_AWARE_TRANSACTION is set.

SQLGetGroupIDs

Conformance

Standards compliance: It is not available.

Overview

SQLGetGroupIDs returns IDs of cluster groups.

Syntax

```
SQLRETURN SQLGetGroupIDs(  
    SQLHDBC      ConnectionHandle,  
    SQLINTEGER * GroupIDArray );
```

Arguments

ConnectionHandle

[Input] It is the connection handle.

GroupIDArray

[output] It is the array of cluster group IDs.

Returns

SQL_SUCCESS, SQL_NO_DATA, SQL_ERROR, SQL_INVALID_HANDLE

Diagnosis

SQLSTATE	Error	Description
08003	Connection not open	ConnectionHandle is not in a connected state.
08S01	Communication link failure	Before the function processing is completed, the connection between the driver and the data source is failed.
HY010	Function sequence error	This function should be called only when the connection property SQL_ATTR_LOCALITY_AWARE_TRANSACTION is set.

Description

SQLGetGroupID can be called only when the connection property SQL_ATTR_LOCALITY_AWARE_TRANSACTION is set.

The number of elements of GroupIDArray should be as same as the number of cluster groups which are returned by SQLGetGroupCount.

SQLGetGroupName

Conformance

Standards compliance: It is not available.

Overview

SQLGetGroupName returns the name of the cluster group which corresponds to GroupID.

Syntax

```
SQLRETURN SQLGetGroupName(  
    SQLHDBC      ConnectionHandle,  
    SQLINTEGER   GroupID,  
    SQLCHAR      * GroupName,  
    SQLSMALLINT  BufferLength,  
    SQLSMALLINT * NameLengthPtr );
```

Arguments

ConnectionHandle

[Input] It is the connection handle.

GroupID

[Input] It is the cluster group ID.

GroupName

[output] It is the buffer pointer which returns the name of the cluster group which is terminated with null.

BufferLength

[Input] It is the length of *GroupName.

NameLengthPtr

[Output] It is the buffer pointer which returns the total number of bytes returnable to *ColumnName (excluding the null-termination character). If the returnable length is equal to or bigger than BufferLength, *ColumnName is truncated to the length of BufferLength minus null.

Returns

SQL_SUCCESS, SQL_SUCCESS_WITH_INFO, SQL_NO_DATA, SQL_ERROR, SQL_INVALID_HANDLE

Diagnosis

SQLSTATE	Error	Description
01004	String data, right truncated	The size of *GroupName is not large enough to return the name of the cluster group, so the name of the cluster group is truncated. The length of the cluster name which is not truncated is returned in *NameLengthPtr. (The function returns SQL_SUCCESS_WITH_INFO.)
08003	Connection not open	ConnectionHandle is not in a connected state.
08S01	Communication link failure	Before the function processing is completed, the connection between the driver and the data source is failed.
HY010	Function sequence error	This function should be called only when the connection property SQL_ATTR_LOCALITY_AWARE_TRANSACTION is set.

Description

SQLGetGroupIDs can be called only when the connection property SQL_ATTR_LOCALITY_AWARE_TRANSACTION is set.

SQLGetInfo

Conformance

Introduced version: ODBC 1.0

Standards compliance: ISO 92

Overview

SQLGetInfo returns the general information on the connection associated with the driver and the data source.

Syntax

```
SQLRETURN SQLGetInfo(  
    SQLHDBC          ConnectionHandle,  
    SQLUSMALLINT     InfoType,  
    SQLPOINTER       InfoValuePtr,  
    SQLSMALLINT      BufferLength,  
    SQLSMALLINT *    StringLengthPtr);
```

Arguments

ConnectionHandle

[Input] It is the connection handle.

InfoType

[Input] It is the information type.

InfoValuePtr

[Output] It is the buffer pointer whose information is returned. According to InfoType requested, one of the following information will be returned. Null termination character, SQLUSMALLINT value, SQLINTEGER bit mask, SQLINTEGER flag, SQLINTEGER binary value, or SQLULEN value.

If InfoType argument is SQL_DRIVER_HDESC or SQL_DRIVER_HSTMT, InfoValuePtr argument is input and output.

If InfoValuePtr is NULL, StringLengthPtr returns the total number of returnable bytes to the buffer pointed by InfoValuePtr (null termination character is excluded).

BufferLength

[Input] It is the length of *InfoValuePtr buffer. If *InfoValuePtr is not a string or InfoValuePtr is the null pointer, BufferLength argument is ignored. The driver assumes the size of *InfoValuePtr as SQLUSMALLINT or SQLINTEGER according to InfoType. (When SQLGetInfoW is called) if InfoValuePtr is a unicode string, BufferLength must be an even number. Otherwise SQLSTATE HY090 is returned.

StringLengthPtr

[Output] It is the buffer pointer which returns the total number of bytes returnable to *InfoValuePtr (excluding null-termination character for the character data).

If the number of bytes returnable for the character is equal to or bigger than BufferLength, the information in *InfoValuePtr is truncated to the length of BufferLength in byte (excluding null-termination character) and is null terminated by the driver.

BufferLength is ignored for the data of the other data types, and the driver assumes the size of *InfoValuePtr as SQLUSMALLINT or SQLINTEGER according to InfoType.

Returns

SQL_SUCCESS, SQL_SUCCESS_WITH_INFO, SQL_ERROR, or SQL_INVALID_HANDLE

Diagnosis

SQLSTATE	Error	Description
01000	General Warning	It is the driver-specific informational message. (The function returns SQL_SUCCESS_WITH_INFO.)
01004	String data, right truncated	The buffer length of *InfoValuePtr is not large enough to return all required information, so the information is truncated. The length of untruncated information is returned to *StringLengthPtr. (The function returns SQL_SUCCESS_WITH_INFO.)
08003	Connection not open	The connection should be open for the type of information requested in InfoType. SQL_ODBC_VER which is the reserved information in ODBC can be returned without open connection.
08S01	Communication link failure	Before the function processing is completed, the connection between the driver and the data source is failed.
HY000	General error	It is an error without any specific SQLSTATE.
HY001	Memory allocation error	It is a memory allocation error.
HY010	Function sequence error	SQLExecute, SQLExecDirect, or SQLMoreResults is called for StatementHandle, and SQL_PARAM_DATA_AVAILABLE is returned. The function is called, before the data retrieves all streamed parameters.
HY013	Memory management error	The size of buffer used as an argument is smaller than 0, or it can not access the memory.

SQLSTATE	Error	Description
HY024	Invalid attribute value	The InfoType argument is SQL_DRIVER_HSTMT, and the value pointed by InfoValuePtr is an invalid statement handle. The InfoType argument is SQL_DRIVER_HDESC, the value pointed by InfoValuePtr is an invalid descriptor handle.
HY090	Invalid string or buffer length	The value for BufferLength argument is smaller than 0. The value for BufferLength argument is an odd number, and *InfoValuePtr is the unicode data type.
HY096	Information type out of range	The value specified in InfoType argument is not valid for ODBC version which is supported by the driver.
HY117	Connection is suspended due to unknown transaction state. Only disconnect and read-only functions are allowed.	For more information about the suspended state, refer to SQLEndTran .
HYC00	Optional field not implemented	The value specified in InfoType is the specific driver value which is not supported by the driver.
HYT01	Connection timeout expired	The connection is expired before the data source responds to the request. The timeout can be set via SQL_ATTR_CONNECTION_TIMEOUT of SQLSetStmtAttr.
IM001	Driver does not support this function	The driver which is related to DescriptorHandle does not support the function.

Description

The currently defined information types will be described in the following sections. The range of information types is reserved by ODBC. The driver developer should reserve the values for the driver-specific use of their own from Open Group. SQLGetInfo does not perform unicode conversion or thunking for InfoTypes defined by the driver. The information type returned to *InfoValuePtr is determined according to InfoTypes requested.

SQLGetInfo returns one of the following five types.

- Null-termination string
- SQLUSMALLINT value
- SQLUINTEGER bit mask
- SQLUINTEGER value
- SQLUINTEGER binary value

The application should cast according to the value returned in *InfoValuePtr.

The driver should return a value for each information type defined in the following table. If the information type is not applied to the driver or the data source, the driver has to return one of the following values.

Character string ("Y" or "N")

"N"

Character string (not "Y" or "N")

Empty string

SQLUSMALLINT

0

SQLUIINTEGER bit mask or SQLUIINTEGER binary value

0L

For example, if the data source does not support the procedure, SQLGetInfo returns the following value for the value of InfoType related to the procedure.

SQL_PROCEDURES

"N"

SQL_ACCESSIBLE_PROCEDURES

"N"

SQL_MAX_PROCEDURE_NAME_LEN

0

SQL_PROCEDURE_TERM

Empty string

SQLGetInfo returns SQLSTATE HY096 for the value of InfoType which is in the range of information type reserved for use by ODBC but which is not defined by the ODBC version supported by the driver. The driver compiles and calls SQLGetInfo as the SQL_DRIVER_ODBC_VER information type of an application to determine the ODBC version. SQLGetInfo returns SQLSTATE HYC00 for the value of InfoType which is in the range of reserved information type for the separate use of the driver but which is not supported by the driver.

Calling all SQLGetInfo should be open for connection, except for InfoType which returns the driver manager version is SQL_ODBC_VER.

Driver Information

The following values of InfoType argument return ODBC information such as an active statement, data source name, interface standards compliance level.

- SQL_ACTIVE_ENVIRONMENTS
- SQL_ASYNC_DBC_FUNCTIONS
- SQL_ASYNC_MODE
- SQL_ASYNC_NOTIFICATION
- SQL_BATCH_ROW_COUNT
- SQL_BATCH_SUPPORT
- SQL_DATA_SOURCE_NAME
- SQL_DRIVER_AWARE_POOLING_SUPPORTED
- SQL_DRIVER_HDBC
- SQL_DRIVER_HDESC
- SQL_DRIVER_HENV
- SQL_DRIVER_HLIB
- SQL_DRIVER_HSTMT
- SQL_DRIVER_NAME
- SQL_DRIVER_ODBC_VER
- SQL_DRIVER_VER
- SQL_DYNAMIC_CURSOR_ATTRIBUTES1
- SQL_DYNAMIC_CURSOR_ATTRIBUTES2
- SQL_FORWARD_ONLY_CURSOR_ATTRIBUTES1
- SQL_FORWARD_ONLY_CURSOR_ATTRIBUTES2
- SQL_FILE_USAGE
- SQL_GETDATA_EXTENSIONS
- SQL_INFO_SCHEMA_VIEWS
- SQL_KEYSET_CURSOR_ATTRIBUTES1
- SQL_KEYSET_CURSOR_ATTRIBUTES2
- SQL_MAX_ASYNC_CONCURRENT_STATEMENTS
- SQL_MAX_CONCURRENT_ACTIVITIES
- SQL_MAX_DRIVER_CONNECTIONS
- SQL_ODBC_INTERFACE_CONFORMANCE
- SQL_ODBC_STANDARD_CLI_CONFORMANCE
- SQL_ODBC_VER
- SQL_PARAM_ARRAY_ROW_COUNTS
- SQL_PARAM_ARRAY_SELECTS
- SQL_ROW_UPDATES
- SQL_SEARCH_PATTERN_ESCAPE
- SQL_SERVER_NAME
- SQL_STATIC_CURSOR_ATTRIBUTES1
- SQL_STATIC_CURSOR_ATTRIBUTES2



When performing SQLGetInfo, the driver can improve the performance by minimizing the number of requests or of the number of transmitting information from the server.

DBMS Product Information

The following values of InfoType argument return information on the DBMS product such as DBMS name and information.

- SQL_DATABASE_NAME
- SQL_DBMS_NAME
- SQL_DBMS_VER

Data Source Information

The following values of InfoType argument return information on the data source such as cursor characteristics and transaction features.

- SQL_ACCESSIBLE_PROCEDURES
- SQL_ACCESSIBLE_TABLES
- SQL_BOOKMARK_PERSISTENCE
- SQL_CATALOG_TERM
- SQL_COLLATION_SEQ
- SQL_CONCAT_NULL_BEHAVIOR
- SQL_CURSOR_COMMIT_BEHAVIOR
- SQL_CURSOR_ROLLBACK_BEHAVIOR
- SQL_CURSOR_SENSITIVITY
- SQL_DATA_SOURCE_READ_ONLY
- SQL_DEFAULT_TXN_ISOLATION
- SQL_DESCRIBE_PARAMETER
- SQL_MULT_RESULT_SETS
- SQL_MULTIPLE_ACTIVE_TXN
- SQL_NEED_LONG_DATA_LEN
- SQL_NULL_COLLATION
- SQL_PROCEDURE_TERM
- SQL_SCHEMA_TERM
- SQL_SCROLL_OPTIONS
- SQL_TABLE_TERM
- SQL_TXN_CAPABLE
- SQL_TXN_ISOLATION_OPTION
- SQL_USER_NAME

Supported SQL

The following values of InfoType argument return Information on the SQL statements supported by the data source.

- SQL_AGGREGATE_FUNCTIONS
- SQL_ALTER_DOMAIN
- SQL_ALTER_SCHEMA
- SQL_ALTER_TABLE
- SQL_ANSI_SQL_DATETIME_LITERALS
- SQL_CATALOG_LOCATION
- SQL_CATALOG_NAME
- SQL_CATALOG_NAME_SEPARATOR
- SQL_CATALOG_USAGE
- SQL_COLUMN_ALIAS
- SQL_CORRELATION_NAME
- SQL_CREATE_ASSERTION
- SQL_CREATE_CHARACTER_SET
- SQL_CREATE_COLLATION
- SQL_CREATE_DOMAIN
- SQL_CREATE_SCHEMA
- SQL_CREATE_TABLE
- SQL_CREATE_TRANSLATION
- SQL_DDL_INDEX
- SQL_DROP_ASSERTION
- SQL_DROP_CHARACTER_SET
- SQL_DROP_COLLATION
- SQL_DROP_DOMAIN
- SQL_DROP_SCHEMA
- SQL_DROP_TABLE
- SQL_DROP_TRANSLATION
- SQL_DROP_VIEW
- SQL_EXPRESSIONS_IN_ORDERBY
- SQL_GROUP_BY
- SQL_IDENTIFIER_CASE
- SQL_IDENTIFIER_QUOTE_CHAR
- SQL_INDEX_KEYWORDS
- SQL_INSERT_STATEMENT
- SQL_INTEGRITY
- SQL_KEYWORDS
- SQL_LIKE_ESCAPE_CLAUSE
- SQL_NON_NULLABLE_COLUMNS

- SQL_SQL_CONFORMANCE
- SQL_OJ_CAPABILITIES
- SQL_ORDER_BY_COLUMNS_IN_SELECT
- SQL_OUTER_JOINS
- SQL_PROCEDURES
- SQL_QUOTED_IDENTIFIER_CASE
- SQL_SCHEMA_USAGE
- SQL_SPECIAL_CHARACTERS
- SQL_SUBQUERIES
- SQL_UNION

SQL Restrictions

The following values of the InfoType argument return restrictions applied to identifiers and clauses in SQL statements, such as the maximum lengths of identifiers and the maximum number of columns in a select list. Restriction can be imposed by the driver or data source.

- SQL_MAX_BINARY_LITERAL_LEN
- SQL_MAX_CATALOG_NAME_LEN
- SQL_MAX_CHAR_LITERAL_LEN
- SQL_MAX_COLUMN_NAME_LEN
- SQL_MAX_COLUMNS_IN_GROUP_BY
- SQL_MAX_COLUMNS_IN_INDEX
- SQL_MAX_COLUMNS_IN_ORDER_BY
- SQL_MAX_COLUMNS_IN_SELECT
- SQL_MAX_COLUMNS_IN_TABLE
- SQL_MAX_CURSOR_NAME_LEN
- SQL_MAX_IDENTIFIER_LEN
- SQL_MAX_INDEX_SIZE
- SQL_MAX_PROCEDURE_NAME_LEN
- SQL_MAX_ROW_SIZE
- SQL_MAX_ROW_SIZE_INCLUDES_LONG
- SQL_MAX_SCHEMA_NAME_LEN
- SQL_MAX_STATEMENT_LEN
- SQL_MAX_TABLE_NAME_LEN
- SQL_MAX_TABLES_IN_SELECT
- SQL_MAX_USER_NAME_LEN

Scalar Function Information

The following values of InfoType argument return information on the scalar functions supported by the data source or driver.

- SQL_CONVERT_FUNCTIONS
- SQL_NUMERIC_FUNCTIONS
- SQL_STRING_FUNCTIONS
- SQL_SYSTEM_FUNCTIONS
- SQL_TIMEDATE_ADD_INTERVALS
- SQL_TIMEDATE_DIFF_INTERVALS
- SQL_TIMEDATE_FUNCTIONS

Conversion Information

The following values of InfoType argument return the list of SQL data types of which the data source can be converted to the specified SQL data type with CONVERT scalar function.

- SQL_CONVERT_BIGINT
- SQL_CONVERT_BINARY
- SQL_CONVERT_BIT
- SQL_CONVERT_CHAR
- SQL_CONVERT_DATE
- SQL_CONVERT_DECIMAL
- SQL_CONVERT_DOUBLE
- SQL_CONVERT_FLOAT
- SQL_CONVERT_INTEGER
- SQL_CONVERT_INTERVAL_YEAR_MONTH
- SQL_CONVERT_INTERVAL_DAY_TIME
- SQL_CONVERT_LONGVARBINARY
- SQL_CONVERT_LONGVARCHAR
- SQL_CONVERT_NUMERIC
- SQL_CONVERT_REAL
- SQL_CONVERT_SMALLINT
- SQL_CONVERT_TIME
- SQL_CONVERT_TIMESTAMP
- SQL_CONVERT_TINYINT
- SQL_CONVERT_VARBINARY
- SQL_CONVERT_VARCHAR

Added Information Type in ODBC 3.x

The following values of InfoType argument are added to ODBC 3.x.

- SQL_ACTIVE_ENVIRONMENTS
- SQL_AGGREGATE_FUNCTIONS
- SQL_ALTER_DOMAIN

- SQL_ALTER_SCHEMA
- SQL_ANSI_SQL_DATETIME_LITERALS
- SQL_ASYNC_DBC_FUNCTIONS
- SQL_ASYNC_MODE
- SQL_ASYNC_NOTIFICATION
- SQL_BATCH_ROW_COUNT
- SQL_BATCH_SUPPORT
- SQL_CATALOG_NAME
- SQL_COLLATION_SEQ
- SQL_CONVERT_INTERVAL_YEAR_MONTH
- SQL_CONVERT_INTERVAL_DAY_TIME
- SQL_CREATE_ASSERTION
- SQL_CREATE_CHARACTER_SET
- SQL_CREATE_COLLATION
- SQL_CREATE_DOMAIN
- SQL_CREATE_SCHEMA
- SQL_CREATE_TABLE
- SQL_CREATE_TRANSLATION
- SQL_CURSOR_SENSITIVITY
- SQL_DDL_INDEX
- SQL_DESCRIBE_PARAMETER
- SQL_DM_VER
- SQL_DRIVER_AWARE_POOLING_SUPPORTED
- SQL_DRIVER_HDESC
- SQL_DROP_ASSERTION
- SQL_DROP_CHARACTER_SET
- SQL_DROP_COLLATION
- SQL_DROP_DOMAIN
- SQL_DROP_SCHEMA
- SQL_DROP_TABLE
- SQL_DROP_TRANSLATION
- SQL_DROP_VIEW
- SQL_DYNAMIC_CURSOR_ATTRIBUTES1
- SQL_DYNAMIC_CURSOR_ATTRIBUTES2
- SQL_FORWARD_ONLY_CURSOR_ATTRIBUTES1
- SQL_FORWARD_ONLY_CURSOR_ATTRIBUTES2
- SQL_INFO_SCHEMA_VIEWS
- SQL_INSERT_STATEMENT
- SQL_KEYSET_CURSOR_ATTRIBUTES1
- SQL_KEYSET_CURSOR_ATTRIBUTES2
- SQL_MAX_ASYNC_CONCURRENT_STATEMENTS

- SQL_MAX_IDENTIFIER_LEN
- SQL_PARAM_ARRAY_ROW_COUNTS
- SQL_PARAM_ARRAY_SELECTS
- SQL_STATIC_CURSOR_ATTRIBUTES1
- SQL_STATIC_CURSOR_ATTRIBUTES2
- SQL_XOPEN_CLI_YEAR

Renamed Information Type in ODBC 3.x

The following values of InfoType argument are renamed for ODBC 3.x.

- SQL_ACTIVE_CONNECTIONS: SQL_MAX_DRIVER_CONNECTIONS
- SQL_ACTIVE_STATEMENTS: SQL_MAX_CONCURRENT_ACTIVITIES
- SQL_MAX_OWNER_NAME_LEN: SQL_MAX_SCHEMA_NAME_LEN
- SQL_MAX_QUALIFIER_NAME_LEN: SQL_MAX_CATALOG_NAME_LEN
- SQL_ODBC_SQL_OPT_IEF: SQL_INTEGRITY
- SQL_OWNER_TERM: SQL_SCHEMA_TERM
- SQL_OWNER_USAGE: SQL_SCHEMA_USAGE
- SQL_QUALIFIER_LOCATION: SQL_CATALOG_LOCATION
- SQL_QUALIFIER_NAME_SEPARATOR: SQL_CATALOG_NAME_SEPARATOR
- SQL_QUALIFIER_TERM: SQL_CATALOG_TERM
- SQL_QUALIFIER_USAGE: SQL_CATALOG_USAGE

Deprecated Information Type in ODBC 3.x

The following InfoType argument values are information types which are deprecated in ODBC 3.x driver but are still supported for compatibility with ODBC 2.x applications.

- SQL_FETCH_DIRECTION
- SQL_LOCK_TYPES
- SQL_ODBC_API_CONFORMANCE
- SQL_ODBC_SQL_CONFORMANCE
- SQL_POS_OPERATIONS
- SQL_POSITIONED_STATEMENTS
- SQL_SCROLL_CONCURRENCY
- SQL_STATIC_SENSITIVITY

SQLGetStmtAttr

Conformance

Introduced version: ODBC 3.0

Standards compliance: ISO 92

Overview

SQLGetStmtAttr returns the current setting of the statement attribute.

Syntax

```
SQLRETURN SQLGetStmtAttr(  
    SQLHSTMT      StatementHandle,  
    SQLINTEGER    Attribute,  
    SQLPOINTER    ValuePtr,  
    SQLINTEGER    BufferLength,  
    SQLINTEGER *  StringLengthPtr);
```

Arguments

StatementHandle

[Input] It is the statement handle.

Attribute

[Input] It is the attribute to be retrieved.

ValuePtr

[Output] It is the buffer pointer in which to return the attribute value specified in Attribute. If ValuePtr is NULL, StringLengthPtr returns the total number of bytes returnable to the buffer pointed by ValuePtr (excluding null-termination character).

BufferLength

[Input] If Attribute is the attribute defined in ODBC and ValuePtr points to a string or binary buffer, the argument is the length of *ValuePtr. If Attribute is the attribute defined in ODBC and *ValuePtr is an integer, BufferLength is ignored. If *ValuePtr (when SQLGetStmtAttrW is called) is a unicode string, BufferLength should be an even number.

If Attribute is the driver defined attribute, the application displays the attribute characteristic to the driver manager by setting BufferLength argument. BufferLength has one of the following values.

- If *ValuePtr is a string pointer, BufferLength is the string length or SQL_NTS.
- If *ValuePtr is a binary buffer pointer, the application stores SQL_LEN_BINARY_ATTR (length) macro result in BufferLength. It stores a negative number in BufferLength.
- If *ValuePtr is a pointer of the value other than a string or a binary string, BufferLength has the value of SQL_IS_POINTER.
- If *ValuePtr has the fixed length data type, BufferLength has SQL_IS_INTEGER or SQL_IS_UNSIGNED.

StringLengthPtr

[Output] It is the buffer pointer which returns the total number of bytes returnable to *ValuePtr (excluding null-termination character). If ValuePtr is null, the length is not returned. If the attribute value is a string and the bytes returnable is equal to or bigger than BufferLength, the data in *ValuePtr is truncated to the length of BufferLength minus the null-termination character, and it is null-terminated by the driver).

Returns

SQL_SUCCESS, SQL_SUCCESS_WITH_INFO, SQL_ERROR, SQL_INVALID_HANDLE

Diagnosis

SQLSTATE	Error	Description
01000	General warning	It is the driver-specific informational message. (The function returns SQL_SUCCESS_WITH_INFO.)
01004	String data, right truncated	The data returned to *ValuePtr is truncated to the length of BufferLength minus null-termination character. The untruncated string value is returned in *StringLengthPtr. (The function returns SQL_SUCCESS_WITH_INFO.)
24000	Invalid cursor state	Attribute argument is SQL_ATTR_ROW_NUMBER, and the cursor is not open or the cursor is positioned before or after the result set.
HY000	General error	It is an error without any specific SQLSTATE.
HY001	Memory allocation error	It is a memory allocation error.
HY010	Function sequence error	<p>The asynchronously executing function is called for the connection handle related to StatementHandle, and this function is still being executed when SQLGetStmtAttr is called.</p> <p>The asynchronously executing function is called for StatementHandle, and is still being executed when the function is called.</p> <p>SQLExecute, SQLExecDirect, SQLBulkOperation or SQLSetPos are called for StatementHandle, and SQL_NEED_DATA is returned. This function</p>

SQLSTATE	Error	Description
		n is called before data is sent for all data-at-execution parameters or columns.
HY013	Memory management error	The size of buffer used as an argument is smaller than 0, or it can not access the memory.
HY090	Invalid string or buffer length	*ValuePtr is a string, and BufferLength is smaller than 0 but it is not equal to SQL_NTS.
HY092	Invalid attribute/option identifier	The specified value of Attribute argument is not valid for ODBC version supported by the driver.
HY109	Invalid cursor position	Attribute argument is SQL_ATTR_ROW_NUMBER, and the row is deleted or can not be retrieved.
HY117	Connection is suspended due to unknown transaction state. Only disconnect and read-only functions are allowed.	For more information about the suspended state, refer to SQLEndTran .
HYC00	Optional field not implemented	The value specified in attribute argument is valid ODBC statement attribute in ODBC version supported by the driver, but it is not supported by the driver.
HYT01	Connection timeout expired	The connection is expired before the data source responds to the request. The timeout can be set via SQL_ATTR_CONNECTION_TIMEOUT of SQLSetStmtAttr.
IM001	Driver does not support this function	The driver which is related to DescriptorHandle does not support the function.

Description

SQLGetStmtAttr returns the statement attribute value specified in Attribute to *ValuePtr. The value returned can be the SQLULEN value or null-termination string. If the value is SQLULEN, some drivers write the lower 32 bits or 16 bits of the buffer and keep the upper bits as they are. Therefore, the application should use the buffer of SQLULEN and initialize it to 0 before the function is called. Also BufferLength and StringLengthPtr are not used. If the value is the null termination string, the application specifies the maximum string length of BufferLength argument, and the driver returns the string length to *StringLengthPtr buffer.

If an application which is operated with ODBC 2.x driver wants to call SQLGetStmtAttr, SQLGetStmtAttr should be mapped to the SQLGetStmtOption of the driver manager.

The following statement can be retrieved by SQLGetStmtAttr but it can not set by SQLSetStmtAttr because the attributes are read-only.

- SQL_ATTR_IMP_PARAM_DESC

- SQL_ATTR_IMP_ROW_DESC
- SQL_ATTR_ROW_NUMBER

Statement Attributes

The following table describes currently defined attributes and its introduced ODBC version.

Attribute	ValuePtr contents
SQL_ATTR_APP_PARAM_DESC (ODBC 3.0)	<p>It is the APD handle for the time after calling SQLExecute and SQLExecDirect on the statement handle. The initial value of this attribute is the descriptor implicitly allocated when the statement is initially allocated. If the value of this attribute is set to the descriptor which is originally allocated by SQL_NULL_DESC or the handle, an explicitly allocated APD handle which is previously related to the statement handle is detached from it and the statement handle is returned to the implicitly allocated APD handle.</p> <p>This attribute can not be set to a descriptor handle which is implicitly allocated for another statement, nor set to another descriptor handle which is implicitly allocated for the same statement. The implicitly allocated descriptor handles cannot be related to a statement or a descriptor handle.</p>
SQL_ATTR_APP_ROW_DESC (ODBC 3.0)	<p>It is the ARD handle for the next fetches of the statement handle. The initial value of the attribute is the descriptor implicitly allocated when the statement is initially allocated. If the attribute is set to SQL_NULL_DESC or to the descriptor allocated by the handle, ARD handle which is explicitly allocated and related to the previous statement is detached and the statement handle is returned to ARD handle implicitly allocated.</p> <p>The attribute can not be set to a descriptor handle which is implicitly allocated for another statement, nor set to another descriptor handle which is implicitly set on the same statement. The implicitly allocated descriptor handle can not be related to a statement or descriptor handle.</p>
SQL_ATTR_ASYNC_ENABLE (ODBC 1.0)	It is not supported by the driver.
SQL_ATTR_ASYNC_STMT_EVENT (ODBC 3.8)	It is not supported by the driver.
SQL_ATTR_ASYNC_STMT_PCALLBACK (ODBC3.8)	It is not supported by the driver.
SQL_ATTR_ASYNC_STMT_PCONTEXT (ODBC 3.8)	It is not supported by the driver.
	<ul style="list-style-type: none"> • SQLULEN: It is the value which specifies the concurrency of cursor. • SQL_CONCUR_READ_ONLY: The cursor is read-only, and the update is not allowed.

Attribute	ValuePtr contents
SQL_ATTR_CONCURRENCY (ODBC 2.0)	<ul style="list-style-type: none"> • SQL_CONCUR_LOCK: The cursor uses the locking of the minimum level which is enough to complete update the row. • SQL_CONCUR_POWER: The cursor uses the concurrency which controls and compares the row version such as SQLBase ROWID or Sybase TIMESTAMP. • SQL_CONCUR_VALUES: The cursor uses the concurrency which controls and compares the value. <p>The default value of SQL_ATTR_CONCURRENCY is SQL_CONCUR_READ_ONLY.</p> <p>If the Attribute of SQL_ATTR_CURSOR_TYPE is changed to the value not supported by SQL_ATTR_CONCURRENCY, then the value of SQL_ATTR_CONCURRENCY is changed at the execution time, and the warning will be issued when SQLExecDirect or SQLPrepare is called.</p> <p>If SQL_ATTR_CONCURRENCY is changed to SQL_CONCUR_READ_ONLY, while the driver supports and executes SELECT FOR UPDATE statement, then an error is returned. If SQL_ATTR_CONCURRENCY value is changed to SQL_ATTR_CURSOR_TYPE value supported by the driver or the value not supported, SQL_ATTR_CURSOR_TYPE value is changed at the execution time, SQLSTATE 01S02 (Option value changed) is issued when SQLExecDirect or SQLPrepare is executed.</p> <p>If the specified concurrency is not supported in the data source, the driver replaces it with another concurrency and returns SQLSTATE 01S02 (Option value changed). The driver replaces SQL_CONCUR_VALUES with SQL_CONCUR_ROWVER, or vice versa. Also SQL_CONCUR_LOCK is replaced with SQL_CONCUR_ROWVER, SQL_CONCUR_VALUES in order. The validity of the replaced value is not confirmed until the execution time.</p>
SQL_ATTR_CURSOR_SCROLLABLE (ODBC 3.0)	<ul style="list-style-type: none"> • SQL_NONSCROLLABLE: It is the default value. The scroll cursor is not required in the statement handle. If the application calls SQLFetchScroll on the handle, the only valid value of FetchOrientation is SQL_FETCH_NEXT. • SQLULEN: It is the value which specifies the required support level of the application. Setting the attribute affects the following SQLExecDirect and SQLExecute. • SQL_SCROLLABLE: The scroll cursor is required in the statement handle. When SQLFetchScroll is called, the application positions the cursor in a mode except sequential mode and specify a valid value of FetchOrientation.
SQL_ATTR_CURSOR_SENSITIVITY	<ul style="list-style-type: none"> • SQL_UNSPECIFIED: It is the default value. It is unspecified what the cursor type is and whether cursors on the statement handle can view the changes made to a result set by another cursor. The cursor of the statement handle probably view is none, some, or all. • SQLULEN: It is the value which determines whether the cursor of the statement handle can view a change in the result set generated by another cursor. Setting

Attribute	ValuePtr contents
(ODBC 3.0)	<p>the attribute affects the following SQLExecDirect and SQLExecute. The application can read the attribute again to obtain the initial state or state most recently set by the application.</p> <ul style="list-style-type: none"> • SQL_INSENSITIVE: All cursors of the statement handle can not view the reflection of any changes made by another cursor and they can view only the results. The insensitive cursor is read-only. It corresponds to a static cursor with a read-only concurrency. • SQL_SENSITIVE: All cursors of the statement handle can view all changes in the result set.
SQL_ATTR_CURSOR_TYPE (ODBC 2.0)	<ul style="list-style-type: none"> • SQLULEN: It is the value which specifies the cursor type. • SQL_CURSOR_FORWARD_ONLY: The cursor can only move forward. • SQL_CURSOR_KEYSET_DRIVEN: The driver stores and uses keys as many as the number of rows specified in SQL_ATTR_KEYSET_SIZE which is the statement attribute. • SQL_CURSOR_DYNAMIC: The driver stores and uses the key for the row in the row set. <p>The default value is SQL_CURSOR_FORWARD_ONLY. The attribute can not be specified in the prepared SQL statement.</p> <p>If the specified cursor type is not supported by the data source, then the driver replaces it with other type and returns SQLSTATE 01S02 (Option value changed). The driver replaces a mixed or dynamic cursor with a key set-driven or static cursor. The driver replaces a key set-driven cursor with a static cursor.</p>
SQL_ATTR_ENABLE_AUTO_IPD (ODBC 3.0)	It is not supported by the driver.
SQL_ATTR_FETCH_BOOKMARK_PTR (ODBC 3.0)	It is not supported by the driver.
SQL_ATTR_IMP_PARAM_DESCRIPTOR (ODBC 3.0)	<p>It is the handle of IPD. This attribute value is the descriptor allocated when the statement is initially allocated. The application can not set the attribute.</p> <p>The attribute can be retrieved by calling SQLGetStmtAttr, but it can not be set via SQLSetStmtAttr.</p>
SQL_ATTR_IMP_ROW_DESCRIPTOR (ODBC 3.0)	<p>It is the handle of IRD. This attribute value is the descriptor allocated when the statement is initially allocated. The application can not set the attribute.</p> <p>The attribute can be retrieved by calling SQLGetStmtAttr, but it can not be set via SQLSetStmtAttr.</p>
SQL_ATTR_KEYSET_SIZE	

Attribute	ValuePtr contents
(ODBC 2.0)	It is not supported by the driver.
SQL_ATTR_MAX_LENGTH (ODBC 1.0)	It is not supported by the driver.
SQL_ATTR_MAX_ROWS (ODBC 1.0)	<ul style="list-style-type: none"> • SQLULEN: It is the value which corresponds to the maximum number of rows which are returned from SELECT statement. If *ValuePtr is equal to 0, the driver returns all rows. <p>The attribute is intended to reduce the network traffic. Notionally it is applied when the result set is generated, it limits the result set of the first ValuePtr row. If the number of rows in the result set are bigger than ValuePtr, then the result set is reduced.</p> <p>SQL_ATTR_MAX_ROWS includes those which are applied to all result set of the statement and returned by the catalog function.</p> <p>SQL_ATTR_MAX_ROWS sets the maximum number of the cursor rows.</p> <p>If SQL_ATTR_MAX_ROWS can not be guaranteed to be correctly implemented (if the result set size limit can not be implemented in the data source), then the driver should not imitate SQL_ATTR_MAX_ROWS operation for SQLFetch or SQLFetchScroll.</p> <p>The driver defines whether to apply SQL_ATTR_MAX_ROWS to the statements except for SELECT statement(such as the catalog functions).</p> <p>The attribute can be set in the open cursor. However, it does not immediately bring the effect. In this case, the driver returns SQLSTATE 01S02 (Option value changed) and sets the attribute to its original value.</p>
SQL_ATTR_METADATA_ID (ODBC 3.0)	<ul style="list-style-type: none"> • SQLULEN: It is the value which determines how to treat the string arguments of the catalog functions. <p>If it is SQL_TRUE, the catalog functions treat the string arguments as the identifiers. In this case, it is not case sensitive. The driver removes the trailing spaces and converts to uppercase for the string whose scope is not defined. The driver removes the leading and trailing spaces and literally takes the string between the delimiters for the string whose scope is defined. If one of the arguments is set to NULL pointer, the function returns SQL_ERROR and SQLSTATE HY009 (Invalid use of null pointer).</p> <p>If it is SQL_FALSE, the catalog functions do not treat the string arguments as the identifiers. In this case, it is case sensitive. The arguments may or may not include a string search pattern depending on the argument.</p> <p>The default value is SQL_FALSE.</p> <p>The list of values of TableType argument of SQLTables is not affected by the attribute.</p> <p>SQL_ATTR_METADATA_ID can be set on the connection level.(SQL_ATTR_METADATA_ID</p>

Attribute	ValuePtr contents
	<p>A_ID and SQL_ATTR_ASYNC_ENABLE are unique and they are the statement attributes and connection attributes.)</p> <p>For more information, refer to Arguments of Catalog Function.</p>
SQL_ATTR_NOSCAN (ODBC 1.0)	It is not supported by the driver.
SQL_ATTR_PARAM_BIND_OFFSET_PTR (ODBC 3.0)	<ul style="list-style-type: none"> SQLULEN*: It is the value which points to the offset to add a pointer to change the dynamic parameter binding. If the field is not NULL, the driver dereferences the pointer, and additionally it dereferences each value of the deferred fields in the descriptor record(SQL_DESC_DATA_PTR, SQL_DESC_INDICATOR_PTR, SQL_DESC_OCTET_LENGTH_PTR) and it uses the new pointer values when bound. It is set to NULL by default. <p>The bind offset is always directly added to SQL_DESC_DATA_PTR, SQL_DESC_INDICATOR_PTR, SQL_DESC_OCTET_LENGTH_PTR fields. If the offset is changed to another value, the new value is directly added to the descriptor field value. The new offset will not be added to any previous offset value in the field.</p> <p>SQL_DESC_BIND TYPE field in APD header is set by setting this statement attribute.</p>
SQL_ATTR_PARAM_BIND_TYPE (ODBC 3.0)	<ul style="list-style-type: none"> SQLULEN: It is the value which refers to the binding direction used in the dynamic parameter. <p>This field is set to SQL_PARAM_BIND_BY_COLUMN which selects the column-wise binding. (default value)</p> <p>The field is set to the instance of the buffer to be bound to the structure length or dynamic parameter set to select the row-wise binding. This length should include the space for all bound parameters and the structure padding, or the address of the binding parameter is increased to the specified length, then the result should be buffered to point to the beginning of the next parameter. The sizeof operation of ANSI C guarantees this behavior.</p> <p>SQL_DESC_BIND_TYPE field in APD header is set by setting this statement attribute.</p>
SQL_ATTR_PARAM_OPERATION_PTR (ODBC 3.0)	<ul style="list-style-type: none"> SQLUSMALLINT*: It is the value which points to the array of SQLSMALLINT values used to ignore the parameter while executing the SQL statement. Each value is SQL_PARAM_PROCEED(to execute the parameter) or SQL_PARAM_IGNORE(to ignore the parameter). <p>The parameter set can be ignored during processing by setting the status value of the array pointed by SQL_DESC_ARRAY_STATUS_PTR in APD. The parameter set is processed when the status value is SQL_PARAM_PROCEED or the array elements are not set.</p> <p>The statement attribute can be set to a NULL pointer and the driver does not return the status value of the parameter. The attribute can be set at any time but the new value</p>

Attribute	ValuePtr contents
	<p>e is not used until SQLExecDirect or SQLExecute is called.</p> <p>The attribute is ignored if bound parameter does not exist.</p> <p>SQL_DESC_ARRAY_STATUS_PTR field in APD header is set by setting this statement attribute.</p>
<p>SQL_ATTR_PARAM_STATUS_PTR (ODBC 3.0)</p>	<ul style="list-style-type: none"> • SQLUSMALLINT*: It is the value points to SQLUSMALLINT array which includes the status information value of each row parameter value after calling SQLExecute or SQLExecDirect. The field is required only when PARAMSET_SIZE is bigger than 1. The status value can include other values. • SQL_PARAM_SUCCESS: SQL statement is successfully executed for the parameter set • SQL_PARAM_SUCCESS_WITH_INFO: SQL statement is successfully executed for the parameter set but the warning information exists in the diagnostic data structure. • SQL_PARAM_ERROR: An error occurs when processing the parameter set. The additional error information is in the diagnostic data structure. • SQL_PARAM_UNUSED: The parameter set is not used because some previous parameter set caused an error which interrupts the processing, or the parameter set of the array specified by SQL_ATTR_PARAM_OPERATION_PTR is set to SQL_PARAM_IGNORE. • SQL_PARAM_DIAG_UNAVAILABLE: The driver treats the parameter array as a uniform unit because the error information level is not generated. <p>The statement attribute can be set to a NULL pointer and the driver does not return the status value of the parameter. The attribute can always be set. But the new value is not used until SQLExecDirect or SQLExecute is called. The attribute may affect the operation that the parameter outputs in the driver.</p> <p>SQL_DESC_ARRAY_STATUS_PTR field of IPD header is set by setting this statement attribute.</p>
<p>SQL_ATTR_PARAMS_PROCESSED_PTR (ODBC 3.0)</p>	<ul style="list-style-type: none"> • SQLULEN*: It is the record field pointing to the buffer in which to return the number of parameter sets processed and it includes the error set. If it is a NULL pointer, any number will not be returned. <p>SQL_DESC_ROWS_PROCESSED_PTR field of IPD is set by setting this statement attribute.</p> <p>If SQLExecDirect or SQLExecute which will fill the buffer specified in this attribute does not return SQL_SUCCESS or SQL_SUCCESS_WITH_INFO, the buffer content is not defined.</p>

Attribute	ValuePtr contents
SQL_ATTR_PARAMSET_SIZE (ODBC 3.0)	<ul style="list-style-type: none"> SQLULEN: It is the value which specifies the number of each parameter values. If SQL_ATTR_PARAMSET_SIZE is bigger than 1, then SQL_DESC_DATA_PTR, SQL_DESC_INDICATOR_PTR, SQL_DESC_OCTET_LENGTH_PTR of APD points to the array. Each array constant is equal to the field value. <p>If binding parameter does not exist, this attribute is ignored.</p> <p>SQL_DESC_ARRAY_SIZE field of APD header is set by setting the statement attribute.</p>
SQL_ATTR_QUERY_TIMEOUT (ODBC 1.0)	<ul style="list-style-type: none"> SQLULEN: It is the value which value in seconds which wait for the SQL statement to execute before returning to the application. If ValuePtr is 0(default value), the timeout does not occur. <p>If the specified timeout value exceeds the maximum value of the data source or it is smaller than the minimum value, then SQLSetStmtAttr replaces the value and returns SQLSTATE 01S02 (Option value changed).</p> <p>Even if SELECT statement is timed out, SQLCloseCursor does not need to be called when reuse the statement.</p> <p>It is valid to set the query timeout of the statement attribute for both synchronous and asynchronous mode.</p>
SQL_ATTR_RETRIEVE_DATA (ODBC 2.0)	<p>It is not supported by the driver.</p>
SQL_ATTR_ROW_ARRAY_SIZE (ODBC 3.0)	<ul style="list-style-type: none"> SQLULEN: It is the value which points to the number of rows returned by calling each SQLFetch or SQLFetchScroll. It is also the number of rows of the bookmark array used in a bulk bookmark operation in SQLBulkOperations. The default value is 1. <p>If the specified row set size exceeds the row set size supported by the data source, the driver replaces the value and returns SQLSTATE 01S02 (option value changed).</p> <p>SQL_DESC_ARRAY_SIZE field of ARD header is set by setting this statement attribute.</p>
SQL_ATTR_ROW_BIND_OFFSET_PTR (ODBC 3.0)	<ul style="list-style-type: none"> SQLULEN: It is the value which points to the offset added to pointers to change binding of the column data. If the field is not NULL, the driver dereferences the pointer and adds the value dereferenced to each field of the descriptor record (SQL_DESC_DATA_PTR, SQL_DESC_INDICATOR_PTR, SQL_DESC_OCTET_LENGTH_PTR), and it uses the new pointer value when binding occurs. The default value is NULL. <p>SQL_DESC_BIND_OFFSET_PTR field of ARD header is set by setting the statement attribute.</p>
	<ul style="list-style-type: none"> SQLULEN: It is the value which sets the binding direction when SQLFetch or SQL

Attribute	ValuePtr contents
SQL_ATTR_ROW_BIND_TYPE (ODBC 1.0)	<p>FetchScroll is called in the related statement. If SQL_BIND_BY_COLUMN is set, the column-wise binding is selected. If the structure or result column sets the length for an instance of the buffer bound, then the row-wise binding is selected.</p> <p>If the length is specified and the address of the all columns and bound columns are increased to the specified length, then all columns should include enough space for the structure or the buffer padding. The behavior is guaranteed when sizeof operator is used with the structure or union in ANSI C.</p> <p>The column-wise binding is the default binding direction of SQLFetch and SQLFetchScroll.</p> <p>SQL_DESC_BIND_TYPE field of ARD header is set by setting this statement attribute.</p>
SQL_ATTR_ROW_NUMBER (ODBC 2.0)	<ul style="list-style-type: none"> SQLULEN: It is the current row order in the entire result set. If the number of the current rows can not be determined or the the current row does not exist, then the driver returns 0. <p>The attribute can be retrieved by calling SQLGetStmtAttr. It can not be set by calling SQLSetStmtAttr.</p>
SQL_ATTR_ROW_OPERATION_PTR (ODBC 3.0)	<p>It is not supported by the driver.</p>
SQL_ATTR_ROW_STATUS_PTR (ODBC 3.0)	<ul style="list-style-type: none"> SQLUSMALLINT*: It is the value which points to SQLUSMALLINT array containing the status values after calling SQLFetch or SQLFetchScroll. The array has the elements as many as the number of rows in the row set. <p>The statement attribute can be set to a NULL pointer, and in this case the driver does not return the row status value. The attribute can be set at any time but the new value is not used until the next SQLBulkOperations, SQLFetch, SQLFetchScroll or SQLSetPos is called.</p> <p>SQL_DESC_ARRAY_STATUS_PTR field of IRD header is set by setting the statement attribute.</p> <p>The attribute is mapped to rgbRowStatus array of SQLExtendedFetch in ODBC 2.x driver.</p>
SQL_ATTR_ROWS_FETCHED_PTR (ODBC 3.0)	<ul style="list-style-type: none"> SQLULEN*: It points to the buffer which returns the number of collected rows after calling SQLFetch or SQLFetchScroll. The number of rows are determined by calling SQLSetPos by setting SQL_REFRESH in operation argument, or determined by processing the bulk operation via SQLBulkOperations. The number of rows include the error rows. <p>SQL_DESC_ROWS_PROCESSED_PTR field of IRD header is set by setting the statement attribute.</p>

Attribute	ValuePtr contents
	<p data-bbox="480 255 600 284">t attribute.</p> <p data-bbox="480 338 1442 450">If calling SQLFetch or SQLFetchScroll which fills in the buffer pointed by the attribute does not return SQL_SUCCESS or SQL_SUCCESS_WITH_INFO, the buffer content is not defined.</p>
SQL_ATTR_SIMULATE_CURSOR (ODBC 2.0)	It is not supported by the driver.
SQL_ATTR_USE_BOOKMARKS (ODBC 2.0)	It is not supported by the driver.

SQLGetStmtOption

Conformance

Introduced version: ODBC 1.0

Standards compliance: It is not available.

Overview

In ODBC 3.x, SQLGetStmtOption function is replaced with SQLGetStmtAttr function.

For more information, refer to [SQLGetStmtAttr](#).

SQLGetSuitableGroupID

Conformance

Standards compliance: It is not available.

Overview

SQLGetSuitableGroupID returns the ID of the cluster group which is the most suitable for the prepared statement to perform in cluster system.

Syntax

```
SQLRETURN SQLGetSuitableGroupID(
    SQLHSTMT      StatementHandle,
    SQLINTEGER *  GroupIDPtr );
```

Arguments

ConnectionHandle

[Input] It is the connection handle.

GroupIDPtr

[Output] It is the ID of the cluster group.

Returns

SQL_SUCCESS, SQL_ERROR, SQL_INVALID_HANDLE

Diagnosis

SQLSTATE	Error	Description
08S01	Communication link failure	Before the function processing is completed, the connection between the driver and the data source is failed.
HY010	Function sequence error	This function is called before SQLPrepare. This function should be called only when the connection property SQL_ATTR_LOCALITY_AWARE_TRANSACTION is set.

Description

SQLGetSuitableGroupID can be called only when the connection property SQL_ATTR_LOCALITY_AWARE_TRANSACTION is set and the statement is prepared.

SQLGetSuitableGroupID returns the ID of the cluster group which is the most suitable for the prepared statement to perform in cluster system by using the current value of the parameter marker when the parameter exists in the statement. If the cluster group which is the most suitable for the prepared statement to perform can not be determined, then it returns SQL_INVALID_GROUP_ID(-1).

SQLGetTypeInfo

Conformance

Introduced version: ODBC 1.0

Standards compliance: ISO 92

Overview

SQLGetTypeInfo returns the information of data type supported by the data source. The driver returns information in the form of SQL result set. Data types are used for Data Definition Language (DDL).

Syntax

```
SQLRETURN SQLGetTypeInfo(  
    SQLHSTMT      StatementHandle,  
    SQLSMALLINT   DataType);
```

Arguments

StatementHandle

[Input] It is the statement handle for the result set.

DataType

[Input] It is the SQL data type. It is data type or the specified driver SQL data type. SQL_ALL_TYPES specifies that the information about all data types should be returned.

Returns

SQL_SUCCESS, SQL_SUCCESS_WITH_INFO, SQL_STILL_EXECUTING, SQL_ERROR, SQL_INVALID_HANDLE

Diagnosis

SQLSTATE	Error	Description
01000	General Warning	It is the driver-specific informational message. (The function returns SQL_SUCCESS_WITH_INFO.)
		It is temporarily replaced with the similar value because the specified statement attribute is invalid due to implementation working condition. Th

SQLSTATE	Error	Description
01S02	Option value changed	<p>e replaced value is valid for StatementHandle until the cursor is closed.</p> <p>The updatable statement attributes are as follows. SQL_ATTR_CONCURRENCY, SQL_ATTR_CURSOR_TYPE, SQL_ATTR_KEYSET_SIZE, SQL_ATTR_MAX_LENGTH, SQL_ATTR_MAX_ROWS, SQL_ATTR_QUERY_TIMEOUT, SQL_ATTR_SIMULATE_CURSOR. (The function returns SQL_SUCCESS_WITH_INFO.)</p>
08S01	Communication link failure	Before the function processing is completed, the connection between the driver and the data source is failed.
24000	Invalid cursor state	<p>The cursor is open in StatementHandle, and SQLFetch or SQLFetchScroll is called.</p> <p>If SQLFetch or SQLFetchScroll returns SQL_NO_DATA, the driver returns this error. If SQLFetch or SQLFetchScroll does not return SQL_NO_DATA, the driver manager returns this error.</p> <p>The result set is open in StatementHandle, but SQLFetch or SQLFetchScroll is not called.</p>
40001	Serialization failure	The transaction is rolled back due to a resource deadlock of other transactions.
40003	Statement completion unknown	The related connection fails during the function execution and the status of the transaction is not able to be checked.
HY000	General error	It is an error without any specific SQLSTATE.
HY001	Memory allocation error	It is a memory allocation error.
HY004	Invalid SQL data type	The value which is specified in DataType argument is neither ODBC SQL data type identifier supported by the driver nor the driver-specific data type identifier.
HY008	Operation canceled	<p>Asynchronous processing for StatementHandle is available and SQLCancel or SQLCancelHandle is called on StatementHandle before the function is called and completed. Then this function is called again on StatementHandle.</p> <p>SQLCancel or SQLCancelHandle is called on StatementHandle from other thread in the multithreaded application before the function is called and completed.</p>
HY010	Function sequence error	<p>The asynchronously executing function is called for the connection handle related to StatementHandle, but it is still being asynchronously executed when SQLGetStmtAttr is called.</p> <p>The asynchronously executing function is called for the StatementHandle, it is still being asynchronously executed when the function is called.</p> <p>SQLExecute, SQLExecDirect, SQLBulkOperation or SQLSetPos is called f</p>

SQLSTATE	Error	Description
		or StatementHandle, and SQL_NEED_DATA is returned. This function is called before data is sent for all data-at-execution parameters or columns.
HY013	Memory management error	The size of buffer used as an argument is smaller than 0, or it can not access the memory.
HY117	Connection is suspended due to unknown transaction state. Only disconnect and read-only functions are allowed.	For more information about the suspended state, refer to SQLEndTran .
HYC00	Optional field not implemented	The combination for the current setting of SQL_ATTR_CONCURRENCY and SQL_ATTR_CURSOR_TYPE statement attributes is not supported by the driver or by the data source. SQL_ATTR_USE_BOOKMARKS statement attribute is not set in SQL_UB_VARIABLE, and SQL_ATTR_CURSOR_TYPE statement attribute is set to the cursor type for the bookmark which is not supported by the driver.
HYT00	Timeout expired	Before the data source returns the result set, the query timeout period is expired. The timeout can be set via SQL_ATTR_QUERY_TIMEOUT of SQLSetStmtAttr.
HYT01	Connection timeout expired	The connection is expired before the data source responds to the request. The timeout can be set via SQL_ATTR_CONNECTION_TIMEOUT of SQLSetStmtAttr.
IM001	Driver does not support this function	The driver which is related to DescriptorHandle does not support the function.
IM017	Polling is disabled in asynchronous notification mode	Whenever using the notification model, polling can not be used.
Im018	SQLCompleteAsync has not been called to complete the previous asynchronous operation on this handle.	If the previous function call for the handle returns SQL_STILL_EXECUTING and if the notification mode is activated, then SQLCompleteAsync should be called for the handle to do post processing and complete the operation.

Description

SQLGetTypeInfo returns the same result as the standard result set, and it is sorted to be closely mapped to the data types corresponding to the DATA_TYPE, ODBC SQL data type. The data types defined by the data source takes precedence over user defined data types. Therefore, the sorting order can be generalized in the ascending order and whose first order is DATA TYPE and then TYPE_NAME though the order is not always consistent.

For example, if the data source defines an INTEGER and COUNTER data types and COUNTER is automatically increased, and the user defined data type WHOLENUM is defined, then INTEGER, WHOLENUM and C

COUNTER will be returned in order. The result is because WHOLENUM is closely mapped to SQL_INTEGER and ODBC SQL data type. On the other hand, even though the automatic increasing data types are supported by the data source, they are not mapped closely with ODBC SQL data types.

If DataType argument is valid for ODBC version supported by the driver but the driver does not support it, then an empty result set is returned.

The following column names are changed in ODBC 3.x. The column name change does not affect the compatibility with the previous version because the application is bound by the column number.

ODBC 2.0 column	ODBC 3.x column
PRECISION	COLUMN_SIZE
MONEY	FIXED_PREC_SCALE
AUTO_INCREMENT	AUTO_UNIQUE_VALUE

In ODBC 3.x, the following columns are added to the result set returned by SQLGetTypeInfo.

- SQL_DATA_TYPE
- INTERVAL_PRECISION
- SQL_DATETIME_SUB
- NUM_PREC_RADIX

The following table lists the columns in the result set. The additional row after column 19 (INTERVAL_PRECISION) is defined by the driver. The applications should get access to a specific driver column by performing the countdown from the end of the result set instead of specifying an explicit ordinal position.



SQLGetTypeInfo may not return for all data types. For example, the driver may not return the user defined data type. The application can use the valid data types regardless of returning SQLGetTypeInfo. Data types returned by SQLGetTypeInfo are supported by the data source. They are intended to be used in Data Definition Language (DDL). The driver can return the data types used in the result set other than the data types that returned by SQLGetTypeInfo. The driver may use the data types which are not supported by the data source in generating the result set for the catalog function.

Column name	Column number	Data type	Comment
TYPE_NAME (ODBC 2.0)	1	Varchar not NULL	It is data source-dependent data type name. For example, it is "CHAR()", "VARCHAR()", "MONEY", "LONG VARBINARY", or "CHAR () FOR BIT DATA". The application should use this name in CREATE TABLE and ALTER TABLE statements.
DATA_TYPE	2	Smallint not	It is SQL data type. It can be the ODBC SQL data type or driver specific SQL data. For DATETIME or INTERVAL data type, the column returns th

Column name	Column number	Data type	Comment
(ODBC 2.0)		NULL	e simple data type (such as SQL_TYPE_TIME or SQL_INTERVAL_YEAR_TO_MONTH).
COLUMN_SIZE (ODBC 2.0)	3	Integer	It is the maximum column size for the data type supported by the server. For numeric data, it is the maximum precision. For string data, it returns a length of characters. For datetime data types, it returns a length of represented characters. For interval data, it returns the length of characters in the character representation of the interval literal. NULL is returned for data types whose column size is not applicable.
LITERAL_PREFIX (ODBC 2.0)	4	Varchar	A character or string is used as a prefix. For example, a single quote (') is for a character, Ox, or binary data type. NULL is returned for a data type which can not be used as a prefix.
LITERAL_SUFFIX (ODBC 2.0)	5	Varchar	A character or string is used as the termination character. For example, a single mark (') is for the character data type. NULL is returned for data types that can not be used as a suffix.
CREATE_PARAMS (ODBC 2.0)	6	Varchar	It is a keyword list corresponding to each parameter (separated by commas) which is specified by the application in parentheses when the name which is returned to TYPE_NAME is used. Keywords in the list can be length, precision, or scale. They are listed as the order in which the grammar uses keywords. For example, CREATE_PARAMS for DECIMAL can be "precision, scale". CREATE_PARAMS for VARCHAR can be the same "length". If parameter does not exist for defining data type, NULL is returned (e.g. INTERGER). The driver provides CREATE_PARAMS text in the language of the country/region.
NULLABLE (ODBC 2.0)	7	Smallint not NULL	It is whether the data type accepts NULL. SQL_NO_NULLS does not accept NULL as a data type. SQL_NULLABLE does accept NULL as a data type. SQL_NULLABLE_UNKNOWN do not know whether the column accepts NULL.
CASE_SENSITIVE (ODBC 2.0)	8	Smallint not NULL	It is whether the character data type is case-sensitive in sorting and comparison. It is SQL_TRUE if the data type is a character data type and it is case-sensitive. It is SQL_FALSE if the data type is not a character data type or it is case-insensitive.
SEARCHABLE (ODBC 2.0)	9	Smallint not NULL	It is how the data type is used in a WHERE clause. If a column can not be used in WHERE clause, it is SQL_PRED_NONE. (It is as same as the value of SQL_UNSEARCHABLE in ODBC 2.x.) If a column can be used only with LIKE condition in WHERE clause, it is SQL_PRED_CHAR. (It is as same as the value of SQL_LIKE_ONLY in ODBC 2.x.) If a column can be used with all comparison operators except LIKE condition in WHERE clause, it is SQL_PRED_BASIC. (It is as same as the val

Column name	Column number	Data type	Comment
			ue of SQL_ALL_EXCEPT_LIKE in ODBC 2.x.) If a column can be used with all comparison operators in WHERE clause, it is SQL_SEARCHABLE.
UNSIGNED_ATTRIBUTE (ODBC 2.0)	10	Smallint	It is whether the data type is signed. If a data type is unsigned, it is SQL_TRUE. If a data type is signed, it is SQL_FALSE. If the attribute can not be used in data type or it is not a numeric data type NULL is returned.
FIXED_PRECISION_SCALE (ODBC 2.0)	11	Smallint not NULL	It is whether the data type (specific data source) has a predefined fixed precision and scale. If the data type has a predefined fixed precision and scale, it is SQL_TRUE. If the data type does not have predefined fixed precision and scale, it is SQL_FALSE.
AUTO_INCREMENT_VALUE (ODBC 2.0)	12	Smallint	It is whether data type is automatically increased. If the data type is automatically increased, it is SQL_TRUE. If the data type is not automatically increased, it is SQL_FALSE If the attribute can not be used in data type or it is not a numeric data type, NULL is returned. The application can insert the value in the column having this attribute, but can not typically update the value of the column. When insertion occurs in the automatically increased column, a unique value is inserted in the column. The increment is not defined but is data source-specific. The application should not assume that the auto-increment column starts at a specific point or it is increased by a certain value.
LOCAL_TYPE_NAME (ODBC 2.0)	13	Varchar	It is a localized version of the data type name dependent on the data source. If the localized name is not supported by the data source, NULL is returned. The name is used for display only, like as a dialog box.
MINIMUM_SCALE (ODBC 2.0)	14	Smallint	It is the minimum scale of the data type on the data source. If the data type is a fixed Scale, MINIMUM_SCALE and MAXIMUM_SCALE columns have this value. For example, SQL_TYPE_TIMESTAMP column has the fixed scale for fractional seconds. NULL is returned if scale can not be used.
MAXIMUM_SCALE (ODBC 2.0)	15	Smallint	It is the maximum scale of the data type on the data source. If scale can not be used, NULL is returned. If the maximum scale is not separately defined on the data source, but it is defined as same as the maximum precision, then the column has the same value as COLUMN_SIZE.
SQL_DATA_TYPE (ODBC 3.0)	16	Smallint NOT NULL	It is the value of SQL data type which appears in SQL_DESC_TYPE field of the descriptor. The column is as same as DATA_TYPE column except for INTERVAL and DATETIME data types. SQL_DATA_TYPE field in the result set returns SQL_INTERVAL or SQL_DATETIME for INTERVAL and DATETIME data types, and SQL_DATETIME_SUB field returns the sub-co

Column name	Column number	Data type	Comment
			de for INTERVAL or DATETIME data types.
SQL_DATETIME_SUB (ODBC 3.0)	17	Smallint	If a value of SQL_DATE_TYPE is SQL_DATETIME or SQL_INTERVAL, this column has the sub code of DATETIME/ INTERVAL. For other data types, the field is NULL. For INTERVAL or DATETIME data types, SQL_DATE_TYPE of the result set returns SQL_INTERVAL or SQL_DATETIME, SQL_DATETIME_SUB field returns the sub code for INTERVAL or DATETIME data type.
NUM_PREC_RADIX (ODBC 3.0)	18	Integer	If the data type is an approximate numeric type, the column has the value 2 to indicate that the COLUMN_SIZE specifies the number of bits. For the exact numeric type, the column has the value 10 to indicate that COLUMN_SIZE specifies decimal values. Otherwise, this column is NULL.
INTERVAL_PRECISION (ODBC 3.0)	19	Smallint	For INTERVAL data type, the column has the value of "INTERVAL leading precision". Otherwise, the column has NULL.

Attribute information can be applied to a particular column in the result set or the data type. SQLGetTypeInfo returns information about the attributes related to a data type. SQLColAttribute returns information about the attributes related to a column in the result set.

SQLMoreResults

Conformance

Introduced version: ODBC 1.0

Standards compliance: ODBC

Overview

SQLMoreResults checks that more results are available in the statements including SELECT, UPDATE, INSERT, or DELETE statement, and if so, the processing for the results is initialized.

Syntax

```
SQLRETURN SQLMoreResults(
    SQLHSTMT    StatementHandle);
```

Argument

StatementHandle

[Input] It is the statement handle.

Returns

SQL_SUCCESS, SQL_SUCCESS_WITH_INFO, SQL_STILL_EXECUTING, SQL_NO_DATA, SQL_ERROR, SQL_INVALID_HANDLE, SQL_PARAM_DATA_AVAILABLE

Diagnosis

SQLSTATE	Error	Description
01000	General Warning	It is the driver-specific informational message. (The function returns SQL_SUCCESS_WITH_INFO.)
01S02	Option value changed	The value of the statement attribute is changed while the batch is being processed. (The function returns SQL_SUCCESS_WITH_INFO.)
08S01	Communication link failure	Before the function processing is completed, the connection between the driver and the data source is failed.
40001	Serialization failure	The transaction is rolled back due to a resource deadlock of other transactions.

SQLSTATE	Error	Description
40003	Statement completion unknown	The related connection is failed during the function execution, and the status of transaction can not be checked.
HY000	General error	It is an error without any specific SQLSTATE.
HY001	Memory allocation error	It is a memory allocation error.
HY008	Operation canceled	Asynchronous processing for StatementHandle is available and SQLCancel or SQLCancelHandle is called on StatementHandle before the function is called and completed. Then this function is called again on StatementHandle. SQLCancel or SQLCancelHandle is called on StatementHandle from other thread in the multithreaded application before the function is called and completed.
HY010	Function sequence error	The asynchronously executing function is called for the connection handle related to StatementHandle, but it is still being asynchronously executed when SQLMoreResultsr is called. The asynchronously executing function is called for the StatementHandle, it is still being asynchronously executed when the function is called. SQLExecute, SQLExecDirect, SQLBulkOperation or SQLSetPos is called for StatementHandle, and SQL_NEED_DATA is returned. This function is called before data is sent for all data-at-execution parameters or columns.
HY013	Memory management error	The size of buffer used as an argument is smaller than 0, or it can not access the memory.
HY117	Connection is suspended due to unknown transaction state. Only disconnect and read-only functions are allowed.	For more information about the suspended state, refer to SQLEndTransaction .
HYT01	Connection timeout expired	The connection is expired before the data source responds to the request. The timeout can be set via SQL_ATTR_CONNECTION_TIMEOUT of SQLSetStmtAttr.
IM001	Driver does not support this function	The driver which is related to DescriptorHandle does not support the function.
IM017	Polling is disabled in asynchronous notification mode	Whenever using the notification model, polling can not be used.
Im018	SQLCompleteAsync has not been called to complete the previous asynchronous operation on this handle.	If the previous function call for the handle returns SQL_STILL_EXECUTING and if the notification mode is activated, then SQLCompleteAsync should be called for the handle to do post processing and complete the operation.

Description

SELECT statement returns the result set. UPDATE, INSERT, and DELETE statements return the number of rows affected.

If one of these statements are batched or an array of parameters are passed or in progress, then multiple result sets or the number of rows can be returned.

The batch is processed, and the application is positioned in the first result set. The application can call SQLBindCol, SQLBulkOperations, SQLFetch, SQLGetData, SQLFetchScroll, SQLSetPos and all the meta data functions as if a single result set exists for the first or subsequent result sets. When SQLMoreResults is executed as the first result set, the application calls SQLMoreResults to move to the next result set. If another result set or its number is available, SQLMoreResults returns SQL_SUCCESS and initializes the result set or performs the aggregate for the additional operations. If any count row generation statement appears between the result set generation statements, the row generation statement can be sent to SQLMoreResults call. If SQLMoreResults is called for UPDATE, INSERT, or DELETE statement, the application can call SQLRowCount.

If a current result set with un fetched rows exists, SQLMoreResults discards the result set and generates the next result set or aggregates it. If all result sets are processed, SQLMoreResults returns SQL_NO_DATA. For some drivers, the output parameter and the return value can not be used until all result sets and row aggregation are processed. In this case, the output parameter and return value can be used after SQLMoreResults returned SQL_NO_DATA.

All bindings made for the previous result set still remains valid. If the column structure is different from the result set, then calling SQLFetch or SQLFetchScroll can cause an error or truncation. To prevent it, the application should call SQLBindCol for the explicit rebinding. The application can call SQLFreeStmt with SQL_UNBIND option to release the binding for all column buffers.

The statement attribute values such as the cursor type, cursor concurrency, key set size, or maximum length can be changed while the application calls SQLMoreResults and performs the batch processing. SQLMoreResults can return SQL_SUCCESS_WITH_INFO and SQLSTATE 01S02 (Option value has changed).

If SQLCloseCursor or SQLFreeStmt is called with an SQL_CLOSE option, then the number of available rows such as all the result set and batch processing result is discarded. The statement handle returns one of the assigned state and prepared state. When the batch is processed and the statement handle is executed, then SQLCancel is called to cancel the asynchronously executing function. If SQLCancel is executed successfully, all asynchronous status results which are generated by the batch processing, and the number of rows can be discarded. The statement handle returns one of the assigned state and prepared state.

If the batch or procedure of the statement mixes SELECT, UPDATE, INSERT, DELETE statements with other SQL statements, these statements does not affect SQLMoreResults.

If a searched update, insert or delete statement in batch statements does not affect to any row of the data source, `SQLMoreResults` returns `SQL_SUCCESS`. It is different from the case of when `SQLExecDirect`, `SQLExecute`, or `SQLParamData` returns `SQL_NO_DATA`. If the application calls `SQLRowCount` to retrieve the number of rows after `SQLMoreResults` does not affect any row, then `SQLRowCount` may return `SQL_NO_DATA`.

Availability of the Number of Rows

If the batch processing includes the statement for consecutive multiple row aggregate generation, the row aggregation can be rolled up to a single row. For example, if a batch includes five `INSERT` statements, the particular data source can return the five individual rows. Some other data sources return a single row that represents the sum of the total five individual rows.

If a batch processing includes the combination of the result set generation and row aggregate generation statement, then the number of rows may not be available.

The driver operation for the availability of the number of rows is listed in `SQL_BATCH_ROW_COUNT` information type used via `SQLGetInfo` call. For example, if the batch processing includes two `INSERT` statements and `SELECT` statement followed by the other `SELECT` statement, then the following cases are available.

- The number of rows corresponding to the two `INSERT` statements can not be used. The first call of `SQLMoreResults` is located in the result set of the second `SELECT` statement.
- The number of rows corresponding to the two `INSERT` statements can be individually used. (`SQLGetInfo` does not return `SQL_BRC_ROLLED_UP` bit for `SQL_BATCH_ROW_COUNT` information type.) The first call of `SQLMoreResults` is located in the number of rows of the first `INSERT` statement, and the second call is positioned in the number of rows of the second `INSERT` statement. The third call may be located in result set of the second `SELECT` statement.
- The number of rows corresponding to the two `INSERT` statements is rolled up to a single available row. (Calling `SQLGetInfo` returns `SQL_BRC_ROLLED_UP` bit for `SQL_BATCH_ROW_COUNT` information type.) The first `SQLMoreResults` may be located overlapping with the number of rows, and the second `SQLMoreResults` may be located in the result set of the second `SELECT` statement.

A specific driver makes the number of rows available only for the explicit batch processing.

SQLNativeSql

It is not supported.

Conformance

Introduced version: ODBC 1.0

Standards compliance: ODBC

Overview

SQLNativeSql returns the SQL string modified by the driver. SQLNativeSql does not execute SQL statement.

Syntax

```
SQLRETURN SQLNativeSql(  
    SQLHDBC      ConnectionHandle,  
    SQLCHAR *    InStatementText,  
    SQLINTEGER   TextLength1,  
    SQLCHAR *    OutStatementText,  
    SQLINTEGER   BufferLength,  
    SQLINTEGER * TextLength2Ptr);
```

SQLNumParams

Conformance

Introduced version: ODBC 1.0

Standards compliance: ISO 92

Overview

SQLNumParams returns the number of parameters in the SQL statement.

Syntax

```
SQLRETURN SQLNumParams(
    SQLHSTMT      StatementHandle,
    SQLSMALLINT * ParameterCountPtr);
```

Arguments

StatementHandle

[Input] It is the statement handle.

ParameterCountPtr

[Output] It is the buffer pointer to which the number of parameters of the statement is to be returned.

Returns

SQL_SUCCESS, SQL_SUCCESS_WITH_INFO, SQL_STILL_EXECUTING, SQL_ERROR, SQL_INVALID_HANDLE

Diagnosis

SQLSTATE	Error	Description
01000	General warning	It is the driver-specific informational message. (The function returns SQL_SUCCESS_WITH_INFO.)
08S01	Communication link failure	Before the function processing is completed, the connection between the driver and the data source is failed.
HY000	General error	It is an error without any specific SQLSTATE.
HY001	Memory allocation error	It is a memory allocation error.

SQLSTATE	Error	Description
HY008	Operation canceled	<p>Asynchronous processing for StatementHandle is available and SQLCancel or SQLCancelHandle is called on StatementHandle before the function is called and completed. Then this function is called again on StatementHandle.</p> <p>SQLCancel or SQLCancelHandle is called on StatementHandle from other thread in the multithreaded application before the function is called and completed.</p>
HY010	Function sequence error	<p>The function is called in StatementHandle before calling SQLPrepare or SQLExecDirect.</p> <p>The asynchronously executing function is called for the connection handle related to StatementHandle, but it is still being asynchronously executed when SQLNumParams is called.</p> <p>The asynchronously executing function is called for the StatementHandle, it is still being asynchronously executed when the function is called.</p> <p>SQLExecute, SQLExecDirect, SQLBulkOperation or SQLSetPos is called for StatementHandle, and SQL_NEED_DATA is returned. This function is called before data is sent for all data-at-execution parameters or columns.</p>
HY013	Memory management error	The internal memory can not be accessed or the available memory size is small.
HY117	Connection is suspended due to unknown transaction state. Only disconnect and read-only functions are allowed.	For more information about the suspended state, refer to SQLEndTran .
HYT01	Connection timeout expired	The connection is expired before the data source responds to the request. The timeout can be set via SQL_ATTR_CONNECTION_TIMEOUT of SQLSetStmtAttr.
IM001	Driver does not support this function	The driver which is related to StatementHandle does not support the function.
IM017	Polling is disabled in asynchronous notification mode	Whenever using the notification model, polling can not be used.
IM018	SQLCompleteAsync has not been called to complete the previous asynchronous operation on this handle.	If the previous function call for the handle returns SQL_STILL_EXECUTING and if the notification mode is activated, then SQLCompleteAsync should be called for the handle to do post processing and complete the operation.

Description

SQLNumParams can be called only after SQLPrepare is called.

If the statement related to StatementHandle does not have any parameter, then SQLNumParams sets *ParameterCountPtr to 0.

The number of parameters which are returned by SQLNumParams is as same as the value of SQL_DESC_COUNT field of IPD.

SQLNumResultCols

Conformance

Introduced version: ODBC 1.0

Standards compliance: ISO 92

Overview

SQLNumResultCols returns the number of columns in the result set.

Syntax

```
SQLRETURN SQLNumResultCols(
    SQLHSTMT      StatementHandle,
    SQLSMALLINT * ColumnCountPtr);
```

Arguments

StatementHandle

[Input] It is the statement handle.

ColumnCountPtr

[Output] It is the buffer pointer to which the number of columns in the result set is to be returned. The number does not include the bookmark column.

Returns

SQL_SUCCESS, SQL_SUCCESS_WITH_INFO, SQL_STILL_EXECUTING, SQL_ERROR, SQL_INVALID_HANDLE

Diagnosis

SQLSTATE	Error	Description
01000	General warning	It is the driver-specific informational message. (The function returns SQL_SUCCESS_WITH_INFO.)
08S01	Communication link failure	Before the function processing is completed, the connection between the driver and the data source is failed.
HY000	General error	It is an error without any specific SQLSTATE.
	Memory allocation error	

SQLSTATE	Error	Description
HY001	or	It is a memory allocation error.
HY008	Operation canceled	Asynchronous processing for StatementHandle is available and SQLCancel or SQLCancelHandle is called on StatementHandle before the function is called and completed. Then this function is called again on StatementHandle. SQLCancel or SQLCancelHandle is called on StatementHandle from other thread in the multithreaded application before the function is called and completed.
HY010	Function sequence error	The function is called in StatementHandle, before SQLPrepare or SQLExecuteDirect is called. The asynchronously executing function is called for the connection handle related to StatementHandle, but it is still being asynchronously executed when SQLNumResultsCols is called. The asynchronously executing function is called for the StatementHandle, it is still being asynchronously executed when the function is called. SQLExecute, SQLExecuteDirect, SQLBulkOperation or SQLSetPos is called for StatementHandle, and SQL_NEED_DATA is returned. This function is called before data is sent for all data-at-execution parameters or columns.
HY013	Memory management error	The internal memory can not be accessed or the available memory size is small.
HY117	Connection is suspended due to unknown transaction state. Only disconnect and read-only functions are allowed.	For more information about the suspended state, refer to SQLEndTran .
HYT01	Connection timeout expired	The connection is expired before the data source responds to the request. The timeout can be set via SQL_ATTR_CONNECTION_TIMEOUT of SQLSetStmtAttr.
IM001	Driver does not support this function	The driver which is related to DescriptorHandle does not support the function.
IM017	Polling is disabled in a synchronous notification mode	Whenever using the notification model, polling can not be used.
IM018	SQLCompleteAsync has not been called to complete the previous asynchronous operation	If the previous function call for the handle returns SQL_STILL_EXECUTING and if the notification mode is activated, then SQLCompleteAsync should be called for the handle to do post processing and complete the operation.

SQLSTATE	Error	Description
	on on this handle.	

Description

SQLNumResultCols is successfully called only when the statement is in the prepared, executed, positioned state.

If the statement related to StatementHandle does not return the column, then SQLNumResultCols sets *ColumnCountPtr to 0.

The number of rows returned by SQLNumResultCols is as same as the value of SQL_DESC_COUNT field of IRD.

SQLParamData

Conformance

Introduced version: ODBC 1.0

Standards compliance: ISO 92

Overview

SQLParamData is used together with SQLPutData to provide the parameters at the statement execution time.

Syntax

```
SQLRETURN SQLParamData(
    SQLHSTMT      StatementHandle,
    SQLPOINTER *  ValuePtrPtr);
```

Returns

SQL_SUCCESS, SQL_SUCCESS_WITH_INFO, SQL_NEED_DATA, SQL_NO_DATA, SQL_STILL_EXECUTING, SQL_ERROR, SQL_INVALID_HANDLE, SQL_PARAM_DATA_AVAILABLE

Diagnosis

SQLSTATE	Error	Description
01000	General warning	It is the driver-specific informational message. (The function returns SQL_SUCCESS_WITH_INFO.)
08S01	Communication link failure	Before the function processing is completed, the connection between the driver and the data source is failed.
HY000	General error	It is an error without any specific SQLSTATE.
HY001	Memory allocation error	It is a memory allocation error.
HY010	Function sequence error	The previous function is not SQLExecute nor is SQLExecDirect which returns SQL_NEED_DATA. The previous function is SQLParamData.
HY013	Memory management error	The internal memory can not be accessed or the available memory size is small.

SQLSTATE	Error	Description
HYT01	Connection time out expired	The connection is expired before the data source responds to the request. The timeout can be set via SQL_ATTR_CONNECTION_TIMEOUT of SQLSetStmtAttr.

If SQLParamData is called to transfer the data for a parameter, then it can return SQLSTATE of SQLExecute or SQLExecDirect.

Description

The driver returns SQL_NEED_DATA when the application calls SQLExecute or SQLExecDirect which requires data-at-execution. The application calls SQLParamData to determine the data to be transferred. If the driver needs the parameter data, then the value of *ValuePtr entered by the application is returned. The application can use the value to determine the parameter data requested by the driver.

The application calls SQLPutData as many times as necessary to transfer data-at-execution parameter. The application calls SQLParamData again after all parameter data is transferred. When SQLParamData returns SQL_NEED_DATA again, the application should call SQLPutData to transfer the other parameter data again. If all parameter data are transferred, then SQLParamData returns SQL_SUCCESS or SQL_SUCCESS_WITH_INFO and the value of *ValuePtr is not defined and the SQL statement can be executed.

SQLParamOptions

Conformance

Introduced version: ODBC 1.0

Standards compliance: It is not available.

Overview

SQLParamOptions function in ODBC 2.0 is replace with `SQLSetStmtAttr` in ODBC 3.x.

SQLPrepare

Conformance

Introduced version: ODBC 1.0

Standards compliance: ISO 92

Overview

SQLPrepare prepares the SQL string for execution.

Syntax

```
SQLRETURN SQLPrepare(
    SQLHSTMT      StatementHandle,
    SQLCHAR *     StatementText,
    SQLINTEGER    TextLength);
```

Arguments

StatementHandle

[Input] It is the statement handle.

StatementText

[Input] It is the SQL text string.

TextLength

[Input] It is the length of *StatementText in characters.

Returns

SQL_SUCCESS, SQL_SUCCESS_WITH_INFO, SQL_STILL_EXECUTING, SQL_ERROR, SQL_INVALID_HANDLE

Diagnosis

SQLSTATE	Error	Description
01000	General warning	It is the driver-specific informational message. (The function returns SQL_SUCCESS_WITH_INFO.)
		It is temporarily replaced with the similar value because the specified statem

SQLSTATE	Error	Description
01S02	Option value changed	<p>ent attribute is invalid due to implementation working condition. (SQLGetStmtAttr can be called to see which value is temporarily changed.) The replaced value is valid for StatementHandle until the cursor is closed, and it is changed to the previous value when the cursor is closed.</p> <p>The updatable statement attributes are as follows. SQL_ATTR_CONCURRENCY, SQL_ATTR_CURSOR_TYPE, SQL_ATTR_KEYSET_SIZE, SQL_ATTR_MAX_LENGTH, SQL_ATTR_MAX_ROWS, SQL_ATTR_QUERY_TIMEOUT, SQL_ATTR_SIMULATE_CURSOR. (The function returns SQL_SUCCESS_WITH_INFO.)</p>
21S01	Insert value list does not match column list	INSERT statement is in *StatementText, and the number of values to be inserted do not match the derived table.
21S02	Degree of derived table does not match column list	CREATE view statement is in *StatementText, and the number of specified names are not as same as the derived table defined by the query specifications.
22018	Invalid character value for cast specification	The SQL statement which includes a string or parameter is in *StatementText, and the value is not compatible with the data type of related table column.
22019	Invalid escape character	StatementText argument includes LIKE predicate such as ESCAPE in WHERE clause, and a control character length of ESCAPE is not 1.
22025	Invalid escape sequence	StatementText argument includes "LIKE pattern value ESCAPE escape character" in WHERE clause, and the pattern value control character is neither "%" nor is "-".
24000	Invalid cursor state	The cursor is open in StatementHandle, and SQLFetch or SQLFetchScroll is called.
34000	Invalid cursor name	*StatementText includes the positioned DELETE or positioned UPDATE, and the cursor referenced by the prepared statement is not open.
3D000	Invalid catalog name	The catalog name specified in StatementText is not valid.
3F000	Invalid schema name	The schema name specified in StatementText is not valid.
42000	Syntax error or access violation	<p>*StatementText includes an SQL statement which is not preparable or it includes a syntax error.</p> <p>*StatementText includes a user without required privileges in a statement.</p>
42S01	Base table or view already exists	*StatementText includes CREATE TABLE or CREATE VIEW statement, and the specified table name or the view name already exists.
		<p>*StatementText includes DROP TABLE or DROP VIEW statement, and the specified table name or view name does not exist.</p> <p>*StatementText includes ALTER TABLE statement, and the specified table name does not exist.</p>

SQLSTATE	Error	Description
42S02	Base table or view not found	<p>*StatementText includes CREATE VIEW statement, and the table name or view name defined does not exist in the query specifications.</p> <p>*StatementText includes CREATE INDEX statement, and the specified table name does not exist.</p> <p>*StatementText includes GRANT or REVOKE statement, and the specified table name or view name does not exist.</p> <p>*StatementText includes SELECT statement, and the table or view name specified does not exist.</p> <p>*StatementText includes DELETE, INSERT or UPDATE statement, and the specified table name does not exist.</p> <p>*StatementText includes CREATE TABLE statement, and the table (refers to other tables) whose constraint is specified does not exist.</p>
42S11	Index already exists	CREATE INDEX statement is in *StatementText, and the specified INDEX name already exists.
42S12	Index not found	DROP INDEX statement is in *StatementText, and the specified INDEX name does not exist.
42S21	Column already exist	ALTER TABLE statement is in *StatementText, and the specified column in ADD clause is not unique or it identifies the existing column in the base table.
42S22	Column not found	<p>CREATE INDEX statement is in *StatementText, and one or more column names do not exist in the specified column list.</p> <p>GRANT or REVOKE statement is in *StatementText, and the specified column name does not exist.</p> <p>SELECT, DELETE or UPDATE statement is in *StatementText, and the specified column name does not exist.</p> <p>CREATE TABLE statement is in *StatementText, the column whose constraint is specified does not exist.</p>
HY000	General error	It is an error without any specific SQLSTATE.
HY001	Memory allocation error	It is a memory allocation error.
HY008	Operation cancelled	<p>Asynchronous processing for StatementHandle is available and SQLCancel or SQLCancelHandle is called on StatementHandle before the function is called and completed. Then, this function is called again on StatementHandle.</p> <p>SQLCancel or SQLCancelHandle is called on StatementHandle from another</p>

SQLSTATE	Error	Description
		thread in the multithreaded application before the function is called and completed.
HY009	Invalid use of null pointer	StatementText is a NULL pointer.
HY010	Function sequence error	<p>The function is called in StatementHandle before calling SQLPrepare or SQLExecDirect.</p> <p>The asynchronously executing function is called for the connection handle related to StatementHandle, but it is still being asynchronously executed when SQLPrepare is called.</p> <p>The asynchronously executing function is called for the StatementHandle, it is still being asynchronously executed when the function is called.</p> <p>SQLExecute, SQLExecDirect, SQLBulkOperation or SQLSetPos is called for StatementHandle, and SQL_NEED_DATA is returned. This function is called before data is sent for all data-at-execution parameters or columns.</p>
HY013	Memory management error	The internal memory can not be accessed or the available memory size is small.
HY090	Invalid string or buffer length	TextLength is equal to or smaller than 0, or it is not as same as SQL_NTS.
HY117	Connection is suspended due to unknown transaction state. Only disconnect and read-only functions are allowed.	For more information about the suspended state, refer to SQLEndTran .
HYC00	Optional feature not implemented	The concurrency set is not valid for the defined cursor type. SQL_ATTR_USE_BOOKMARKS statement attribute is set to SQL_UB_VARIABLE, and SQL_ATTR_CURSOR_TYPE statement attribute is set to the cursor type for the bookmark that is not supported by the driver.
HYT00	Timeout expired	The query timeout is expired before getting the result set from the data source. The timeout can be set via SQL_ATTR_QUERY_TIMEOUT of SQLSetStmtAttr.
HYT01	Connection timeout expired	The connection is expired before the data source responds to the request. The timeout can be set via SQL_ATTR_CONNECTION_TIMEOUT of SQLSetStmtAttr
IM001	Driver does not support this function	The driver which is related to StatementHandle does not support the function.
	Polling is disabled in asynchronous	

SQLSTATE	Error	Description
IM017	s notification mode	Whenever using the notification model, polling can not be used.
IM018	SQLCompleteAsync has not been called to complete the previous asynchronous operation on this handle.	If the previous function call for the handle returns SQL_STILL_EXECUTING and if the notification mode is activated, then SQLCompleteAsync should be called for the handle to do post processing and complete the operation.

Description

The application calls SQLPrepare to send the SQL statements to the data source for preparation. The application can include one or more parameter markers in the SQL statement. The application describes the question mark (?) at an appropriate position in the SQL string to include the parameter marker.



If the application uses SQLPrepare to prepare, or uses SQLExecute to submit COMMIT or ROLLBACK statement, then it is impossible to interoperate between DBMS products.

The driver can update the statement to use the SQL types used by the data source, and pass it to the data source for the preparation. Especially, the driver updates the extended bit string which is used to define the SQL statement for a particular function. In the driver, the statement handle is similar to the statement identifier in the embedded SQL code. If the data source supports statement identifiers, the driver can send a statement identifier and parameter values to the data source.

After the statement is prepared, the application uses the statement handle to refer to the statement in the later function calls. The prepared statement related to the statement handle can be executed again with calling SQLExecute until the application releases the statement by calling SQLFreeStmt with SQL_DROP option or the statement handle uses one of SQLPrepare, SQLExecDirect or catalog function(SQLColumns, SQLTables, etc.). Once the application prepares the statement, information about the format of the result set may be requested. For some implementations, after SQLPrepare, calling of SQLDescribeCol or SQLDescribeParam is not as effective as calling after SQLExecute or SQLExecDirect.

The driver can not return a syntax error or access violation when the application calls SQLPrepare. The driver can handle all syntax errors and access violations, or it can handle only syntax errors, or it can not handle all syntax errors nor does return access violations. The application should be able to handle these conditions when calling a subsequent related functions (the subsequent functions such as SQLNumResultCols, SQLDescribeCol, SQLColAttribute, SQLExecute).

According to the features of the driver and data source, parameter information (such as the data type) can be checked when the statement is prepared (when all parameters are bound) or is executed (when all parameters are not bound).

The application should release the binding of all parameters previously applied to the SQL statement before preparing the new SQL statement in the same statement. It can prevent an error whose previous parameter information is applied to the new statement.



Committing a transaction by explicitly calling `SQLEndTran` or by working in autocommit mode, can cause the data source to delete the access plans for all statements on a connection. For more information, refer to `SQL_CURSOR_COMMIT_BEHAVIOR` and `SQL_CURSOR_ROLLBACK_BEHAVIOR` information types in **`SQLGetInfo`**.

SQLPrimaryKeys

Conformance

Introduced version: ODBC 1.0

Standards compliance: ODBC

Overview

SQLPrimaryKeys returns the column name consists of the primary key of a table. The driver returns information as a result set. The function does not support returning the primary key from the multiple tables in a single call.

Syntax

```
SQLRETURN SQLPrimaryKeys(
    SQLHSTMT      StatementHandle,
    SQLCHAR *     CatalogName,
    SQLSMALLINT   NameLength1,
    SQLCHAR *     SchemaName,
    SQLSMALLINT   NameLength2,
    SQLCHAR *     TableName,
    SQLSMALLINT   NameLength3);
```

Arguments

StatementHandle

[Input] It is the statement handle.

CatalogName

[Input] It is the catalog name. If the driver supports the catalog only for a few tables, an empty string ("") indicates the table with no catalog. CatalogName can not include the string search pattern.

If SQL_ATTR_METADATA_ID is set to SQL_TRUE, CatalogName is treated as an identifier, and it is not case sensitive. If it is set to SQL_FALSE, CatalogName is treated as an ordinary argument literal, and it is case sensitive.

NameLength1

[Input] It is the length of *CatalogName in characters.

SchemaName

[Input] It is the schema name. If the driver supports the schema only for a few tables, an empty string ("") indicates the table with no schema. SchemaName can not include the string search pattern.

If SQL_ATTR_METADATA_ID is set to SQL_TRUE, SchemaName is treated as an identifier, and it is not case sensitive. If it is set to SQL_FALSE, SchemaName is treated as a pattern value string, and it is not case sensitive.

NameLength2

[Input] It is the length of *SchemaName in characters.

TableName

[Input] It is the table name. The argument can not be a null pointer. TableName can not include the string search pattern.

If SQL_ATTR_METADATA_ID is set to SQL_TRUE, TableName is treated as an identifier, and it is not case sensitive. If it is set to SQL_FALSE, TableName is treated as an ordinary literal, and it is not case sensitive.

NameLength3

[Input] It is the length of *TableName in characters.

Returns

SQL_SUCCESS, SQL_SUCCESS_WITH_INFO, SQL_STILL_EXECUTING, SQL_ERROR, SQL_INVALID_HANDLE

Diagnosis

SQLSTATE	Error	Description
01000	General warning	It is the driver-specific informational message. (The function returns SQL_SUCCESS_WITH_INFO.)
08S01	Communication link failure	Before the function processing is completed, the connection between the driver and the data source is failed.
24000	Invalid cursor state	SQLFetch or SQLFetchScroll is called, and the cursor is open. SQLFetch or SQLFetchScroll is not called, but the cursor is open.
40001	Serialization failure	The transaction is rolled back due to a resource deadlock of other transactions.
40003	Statement completion unknown	The related connection fails during the function execution and the status of the transaction is not able to be checked.
HY000	General error	It is an error without any specific SQLSTATE.
HY001	Memory allocation error	It is a memory allocation error.
		Asynchronous processing for StatementHandle is available and SQLCancel or SQLCancelHandle is called on StatementHandle before the function is called a

SQLSTATE	Error	Description
HY008	Operation canceled	<p>nd completed. Then this function is called again on StatementHandle.</p> <p>SQLCancel or SQLCancelHandle is called on StatementHandle from another thread in the multithreaded application before this function is called and completed.</p>
HY009	Invalid use of null pointer	<p>TableName argument is a null pointer.</p> <p>SQL_ATTR_METADATA_ID statement attribute is set to SQL_TRUE, and CatalogName argument is a null pointer.</p> <p>SQLGetInfo with the SQL_CATALOG_NAME information type returns that catalog names are supported.</p> <p>SQL_ATTR_METADATA_ID statement attribute is set to SQL_TRUE, and SchemaName argument is a null pointer.</p>
HY010	Function sequence error	<p>The asynchronously executing function is called for the connection handle related to StatementHandle, and this function is still being executed when SQLPrimaryKeys is called.</p> <p>SQLExecute, SQLExecDirect, or SQLMoreResults is called for StatementHandle, and SQL_PARAM_DATA_AVAILABLE is returned. This function is called before the data is checked for all connected parameters.</p> <p>The asynchronously executing function is called for StatementHandle, and is still being executed when this function is called.</p> <p>SQLExecute, SQLExecDirect, SQLBulkOperation or SQLSetPos is called for StatementHandle, and SQL_NEED_DATA is returned. This function is called before data is sent for all data-at-execution parameters or columns.</p>
HY013	Memory management error	The internal memory can not be accessed or the available memory size is small.
HY090	Invalid string or buffer length	<p>A name length argument value is smaller than 0 but it is not as same as SQL_NTS. The name argument is not a null pointer.</p> <p>A name length argument value is bigger than the maximum length corresponding to the name.</p>
HY117	Connection is suspended due to unknown transaction state. Only disconnect and read-only functions are allowed.	For more information about the suspended state, refer to SQLEndTran .
		The catalog is specified, but the driver or the data source does not support the catalog.

SQLSTATE	Error	Description
HYC00	Optional feature not implemented	<p>The schema is specified, but the driver or the data source does not support the schema.</p> <p>The combination of current setting of SQL_ATTR_CONCURRENCY and SQL_ATTR_CURSOR_TYPE statement attributes is not supported by the driver or data source.</p> <p>SQL_ATTR_USE_BOOKMARKS statement attribute is set to SQL_UB_VARIABLE, and SQL_ATTR_CURSOR_TYPE statement attribute is set to the cursor type for the bookmark that is not supported by the driver.</p>
HYT00	Timeout expired	The query timeout is expired before getting the result set from the data source. The timeout can be set via SQL_ATTR_QUERY_TIMEOUT of SQLSetStmtAttr.
HYT01	Connection timeout expired	The connection is expired before the data source responds to the request. The timeout can be set via SQL_ATTR_CONNECTION_TIMEOUT of SQLSetStmtAttr.
IM001	Driver does not support this function	The driver which is related to StatementHandle does not support the function.
IM017	Polling is disabled in asynchronous notification mode	Whenever using the notification model, polling can not be used.
IM018	SQLCompleteAsync has not been called to complete the previous asynchronous operation on this handle.	If the previous function call for the handle returns SQL_STILL_EXECUTING and if the notification mode is activated, then SQLCompleteAsync should be called for the handle to do post processing and complete the operation.

Description

SQLPrimaryKeys returns the result as the standard result set sorted by TABLE_CAT, TABLE_SCHEM, TABLE_NAME, and KEY_SEQ. For more information about how to use this information, refer to **Using Catalog Data**.

The names in the following columns are changed in ODBC 3.x. The column name change does not affect compatibility with the previous version because the application binds by the column number.

ODBC 2.0 column	ODBC 3.x column
TABLE_QUALIFIER	TABLE_CAT
TABLE_OWNER	TABLE_SCHEM

SQLGetInfo is called together with SQL_MAX_CATALOG_NAME_LEN, SQL_MAX_SCHEMA_NAME_LEN,

SQL_MAX_TABLE_NAME_LEN, and SQL_MAX_COLUMN_NAME_LEN options to determine the actual column length of TABLE_CAT, TABLE_SCHEM, TABLE_NAME, and COLUMN_NAME.



For more information about general use, arguments, and the returned data of the ODBC catalog functions, refer to **Catalog Function**.

The following table is a column list in the result set. An additional column after the column 6 can be defined by the driver. The application should access the related column by counting down from the end in the result set rather than by explicitly specifying the position. For more information, refer to **Data Returning of Catalog Function**.

Column name	Column number	Data type	Description
TABLE_CAT (ODBC 1.0)	1	Varchar	It is the primary key table catalog name. If it can not be used in the data source, it is NULL. If the driver supports the catalog only for some tables, such as when the drive retrieves the data from another DBMS, it returns an empty string ("") for the table which does not have a catalog.
TABLE_SCHEM (ODBC 1.0)	2	Varchar	It is the primary key table schema name. If it can not be used in the data source, it is NULL. If the driver supports the schema only for some table, such as when the drive retrieves the data from another DBMS, it returns an empty string ("") for the table which does not have a schema.
TABLE_NAME (ODBC 1.0)	3	Varchar not NULL	It is the primary key table name.
COLUMN_NAME (ODBC 1.0)	4	Varchar not NULL	It is the primary key column name. The driver returns an empty string for a column which does not have a name.
KEY_SEQ (ODBC 1.0)	5	Smallint not NULL	It is the column sequence number of the key (starting from 1).
PK_NAME (ODBC 2.0)	6	Varchar	It is the primary key name. If it can not be applied to the data source, it is NULL.

SQLProcedureColumns

Conformance

Introduced version: ODBC 1.0

Standards compliance: ODBC

Overview

SQLProcedureColumns returns the list of input output parameters and the columns which configure the result set of the specified procedure. The driver returns information as the result set for the specified statement.

Syntax

```
SQLRETURN SQLProcedureColumns(  
    SQLHSTMT      StatementHandle,  
    SQLCHAR *     CatalogName,  
    SQLSMALLINT   NameLength1,  
    SQLCHAR *     SchemaName,  
    SQLSMALLINT   NameLength2,  
    SQLCHAR *     ProcName,  
    SQLSMALLINT   NameLength3,  
    SQLCHAR *     ColumnName,  
    SQLSMALLINT   NameLength4);
```

Arguments

StatementHandle

[Input] It is the statement handle.

CatalogName

[Input] It is the name of the procedure catalog. If the driver does not support the catalog, it returns an empty string ("") and the procedure does not include catalog. CatalogName can not include the string search pattern.

If SQL_ATTR_METADATA_ID is set to SQL_TRUE, CatalogName is treated as an identifier, and it is not case sensitive. If it is set to SQL_FALSE, CatalogName is treated as an ordinary argument literal, and it is case sensitive. For more information, refer to Arguments of Catalog Function.

NameLength1

[Input] It is the length of *CatalogName in characters.

SchemaName

[Input] It is the name of procedure schema. It is the string search pattern for the schema name. If the driver does not support the schema, it returns an empty string ("") and the procedure does not include the schema. SchemaName can not include the string search pattern.

If SQL_ATTR_METADATA_ID is set to SQL_TRUE, SchemaName is treated as an identifier, and it is not case sensitive. If it is set to SQL_FALSE, SchemaName is treated as a pattern value string argument, and it is case sensitive.

NameLength2

[Input] It is the length of *SchemaName in characters.

ProcName

[Input] It is the procedure name. This argument can not be a null pointer. ProcName can not include the string search pattern.

If SQL_ATTR_METADATA_ID is set to SQL_TRUE, ProcName is treated as an identifier, and it is not case sensitive. If it is set to SQL_FALSE, ProcName is treated as an ordinary literal, and it is not case sensitive.

NameLength3

[Input] It is the length of *ProcName in characters.

ColumnName

[Input] It is the column name. This argument can not be a null pointer. ColumnName can not include the string search pattern.

If SQL_ATTR_METADATA_ID is set to SQL_TRUE, ColumnName is treated as an identifier, and it is not case sensitive. If it is set to SQL_FALSE, ColumnName is treated as an ordinary literal, and it is not case sensitive.

NameLength4

[Input] It is the length of *ColumnName in characters.

Returns

SQL_SUCCESS, SQL_SUCCESS_WITH_INFO, SQL_STILL_EXECUTING, SQL_ERROR, SQL_INVALID_HANDLE

Diagnosis

SQLSTATE	Error	Description
01000	General warning	It is the driver-specific informational message. (The function returns SQL_SUCCESS_WITH_INFO.)

SQLSTATE	Error	Description
08S01	Communication link failure	Before the function processing is completed, the connection between the driver and the data source is failed.
24000	Invalid cursor state	<p>The cursor is open in StatementHandle, and SQLFetch or SQLFetchScroll is called.</p> <p>If SQLFetch or SQLFetchScroll returns SQL_NO_DATA, the driver returns this error. If SQLFetch or SQLFetchScroll does not return SQL_NO_DATA, the driver manager returns this error.</p> <p>The result set is open in StatementHandle, but SQLFetch or SQLFetchScroll is not called.</p>
40001	Serialization failure	The transaction is rolled back due to a resource deadlock of other transactions.
40003	Statement completion unknown	The related connection fails during the function execution and the status of the transaction is not able to be checked.
HY000	General error	It is an error without any specific SQLSTATE.
HY001	Memory allocation error	It is a memory allocation error.
HY009	Invalid use of null pointer	<p>TableName argument is a null pointer.</p> <p>SQL_ATTR_METADATA_ID statement attribute is set to SQL_TRUE, and CatalogName argument is a null pointer.</p> <p>SQLGetInfo with the SQL_CATALOG_NAME information type returns that catalog names are supported.</p> <p>SQL_ATTR_METADATA_ID statement attribute is set to SQL_TRUE, and SchemaName, ProcName or ColumnName argument is a null pointer.</p>
HY010	Function sequence error	<p>The asynchronously executing function is called for the connection handle related to StatementHandle, and this function is still executing when SQLProcedureColumns is called.</p> <p>SQLExecute, SQLExecDirect, or SQLMoreResults is called for StatementHandle, and SQL_PARAM_DATA_AVAILABLE is returned. This function is called before the data is checked for all connected parameters.</p> <p>SQLExecute, SQLExecDirect, SQLBulkOperation or SQLSetPos is called for StatementHandle, and SQL_NEED_DATA is returned. This function is called before data is sent for all data-at-execution parameters or columns.</p> <p>The asynchronously executing function is called for StatementHandle, and is still being executed when this function is called.</p>
HY090	Invalid string or buffer	A name length argument value is smaller than 0 but it is not as same as SQL_NTS.

SQLSTATE	Error	Description
	r length	A name length argument value is bigger than the maximum length corresponding to the name.
HY117	Connection is suspended due to unknown transaction state. Only disconnect and read-only functions are allowed.	For more information about the suspended state, refer to SQLEndTran .
HYC00	Optional feature not implemented	<p>The catalog is specified, but the driver or the data source does not support the catalog.</p> <p>The schema is specified, but the driver or the data source does not support the schema.</p> <p>The combination of current setting of SQL_ATTR_CONCURRENCY and SQL_ATTR_CURSOR_TYPE statement attributes is not supported by the driver or data source.</p> <p>SQL_ATTR_USE_BOOKMARKS statement attribute is set to SQL_UB_VARIABLE, and SQL_ATTR_CURSOR_TYPE statement attribute is set to the cursor type for the bookmark that is not supported by the driver.</p>
HYT00	Timeout expired	The query timeout is expired before getting the result set from the data source. The timeout can be set via SQL_ATTR_QUERY_TIMEOUT of SQLSetStmtAttr .
HYT01	Connection timeout expired	The connection is expired before the data source responds to the request. The timeout can be set via SQL_ATTR_CONNECTION_TIMEOUT of SQLSetStmtAttr .
IM001	Driver does not support this function	The driver which is related to StatementHandle does not support the function.
IM017	Polling is disabled in asynchronous notification mode	Whenever using the notification model, polling can not be used.
IM018	SQLCompleteAsync has not been called to complete the previous asynchronous operation on this handle.	If the previous function call for the handle returns SQL_STILL_EXECUTING and if the notification mode is activated, then SQLCompleteAsync should be called for the handle to do post processing and complete the operation.

Description

SQLProcedureColumns returns the list of input output parameters and the columns which configure the result set of the specified procedure. The driver returns information as the result set for the specified statement.

SQLProcedureColumns returns the results as a standard result set, sorted in an order of PROCEDURE_CAT, PROCEDURE_SCHEM, PROCEDURE_NAME, COLUMN TYPE. Column names are returned in an order of each parameter name (in call order) and the name of each column in the result set returned by the procedure.

SQLGetInfo is called together with SQL_MAX_CATALOG_NAME_LEN, SQL_MAX_SCHEMA_NAME, SQL_MAX_PROCEDURE_NAME_LEN options in an application to determine the actual column length of PROCEDURE_CAT, PROCEDURE_SCHEM, PROCEDURE_NAME, COLUMN_NAME.

The names in the following columns are changed in ODBC 3.x. The column name change does not affect compatibility with the previous version because the application binds by the column number.

ODBC 2.0 column	ODBC 3.x column
PROCEDURE_QUALIFIER	PROCEDURE_CAT
PROCEDURE_OWNER	PROCEDURE_SCHEM
PRECISION	COLUMN_SIZE
LENGTH	BUFFER_LENGTH
SACLE	DECIMAL_DIGITS
RADIX	NUM_PREC_RADIX

In ODBC 3.x, the following columns are added to the result set returned by SQLProcedureColumns.

- COLUMN_DEF
- DATETIME_CODE
- CHAR_OCTET_LENGTH
- ORDINAL_POSITION
- IS_NULLABLE

The following table lists the columns in the result set. The additional row after column 19 (IS_NULLABLE) is defined by the driver. The applications should get access to a specific driver column by performing the countdown from the end of the result set instead of specifying an explicit ordinal position.

Column name	Column number	Data type	Description
PROCEDURE_CAT (ODBC)	1	Varchar	It is the procedure catalog name. If it can not be used in the data source, it is NULL. If the driver supports the catalog only for some tables, suc

Column name	Column number	Data type	Description
C 2.0)			has when the driver retrieves the data from another DBMS, it returns an empty string ("") for the table which does not have a catalog.
PROCEDURE_SCHEM (ODBC 2.0)	2	Varchar	It is the procedure schema name. If it can not be used in the data source, it is NULL. If the driver supports the schema only for some table, such as when the driver retrieves the data from another DBMS, it returns an empty string ("") for the table which does not have a schema.
PROCEDURE_NAME (ODBC 2.0)	3	Varchar not NULL	It is the procedure name. If the procedure does not have a name, then it returns an empty string.
COLUMN_NAME (ODBC 2.0)	4	Varchar not NULL	It is the procedure column name. If the procedure does not have a name, then the driver returns an empty string.
COLUMN_TYPE (ODBC 2.0)	5	Smallint not NULL	It defines the procedure types. <ul style="list-style-type: none"> SQL_PARAM_TYPE_UNKNOWN: The procedure column type is not known. (ODBC 1.0) SQL_PARAM_INPUT: The procedure column is an input parameter. (ODBC 1.0) SQL_PARAM_INPUT_OUTPUT: The procedure column is an input/output parameter. (ODBC 1.0) SQL_PARAM_OUTPUT: The procedure column is an output parameter. (ODBC 2.0) SQL_RETURN_VALUES: The procedure column is a return value of the procedure. (ODBC 2.0) SQL_RESULT_COL: The procedure column is a column of result set. (ODBC 1.0)
DATA_TYPE (ODBC 1.0)	6	Smallint not NULL	It is SQL data type. For datetime and interval data type, this column returns a concise data type such as SQL_TYPE_DATE, SQL_INTERVAL_YEAR_TO_MONTH.
TYPE_NAME (ODBC 2.0)	7	Varchar not NULL	It is the name of a data source dependent data type. For example, it is CHAR(), VARCHAR(), MONEY, LONG VARBINARY or CHAR () FOR BIT DATA. An application should use this name in CREATE TABLE and ALTER TABLE statement.
COLUMN_SIZE (ODBC 2.0)	8	Integer	It is the maximum column size of the data type supported by the server. The maximum precision is returned for the numeric data type, string data type returns the character length, DATETIME data type returns the length of expressed character, INTERVAL data type returns the character length of literal INTERVAL character, and the datatype to which the column size is not applicable returns NULL.
BUFFER_LENGTH (ODBC 1.0)	9	Integer	It is the byte length transferred from SQLGetData or SQLFetch operation when SQL_C_DEFAULT is specified. The size of numeric data can be different from that of the data stored in the data source. For a string or a binary data, this value is as same as COLUMN_SIZE column.

Column name	Column number	Data type	Description
DECIMAL_DIGITS (ODBC 1.0)	10	Smallint	It is the fractional digit in a column of the data source. If the decimal place of the data type can not be applicable, it returns NULL.
NUM_PREC_RADIX (ODBC 2.0)	11	Smallint	It is 2 or 10 for a numeric data type. If it is 2, COLUMN_SIZE and DECIMAL_DIGITS are number of bits allowed for a column. If it is 10, COLUMN_SIZE and DECIMAL_DIGITS are number of digits allowed for a column. The data type to which NUM_PREC_RADIX can not be applicable returns NULL.
NULLABLE (ODBC 2.0)	12	Smallint not NULL	It is whether the data type allows NULL value. If it is SQL_NULLABLE, the data type allows NULL value. If it is SQL_NO_NULLS, the data type does not allow NULL value. If it is SQL_NULLABLE_UNKNOWN, it is unknown if the column allows NULL value.
REMARKS (ODBC 2.0)	13	Varchar	It is a description about the procedure column.
COLUMN_DEFAULT (ODBC 3.0)	14	Varchar	It is the default value of a column. If this value is enclosed in double quotes, then this column should be interpreted as a string.
SQL_DATA_TYPE (ODBC 3.0)	15	Smallint not NULL	It is the SQL data type value appears in the SQL_DESC_TYPE field of a descriptor. This column is as same as DATA_TYPE column, except for INTERVAL and DATETIME data type. For INTERVAL and DATETIME data types, SQL_DATA_TYPE field in the result set returns SQL_INTERVAL or SQL_DATETIME, and SQL_DATETIME_SUB field returns the subcode for INTERVAL or DATETIME data type.
SQL_DATETIME_SUB (ODBC 3.0)	16	Smallint	It is the subtype code of datetime and interval data types. It returns NULL for other data types.
CHAR_OCTET_LENGTH (ODBC 3.0)	17	Integer	It is the maximum length in byte of character or binary data type column. It returns NULL for other data types.
ORDINAL_POSITION (ODBC 3.0)	18	Integer not NULL	It is the column location in a table.
IS_NULLABLE (ODBC 3.0)	19	Varchar	<ul style="list-style-type: none"> "YES": A column can include NULL. "NO": A column can not include NULL. It returns a string whose length is 0 when it is unknown whether to allow NULL.

SQLProcedures

Conformance

Introduced version: ODBC 1.0

Standards compliance: ODBC

Overview

SQLProcedures returns the list of procedure names stored in the specified data source. Procedure is a general term used to describe a named object which can be called by using the executable object or input and output parameter.

Syntax

```
SQLRETURN SQLProcedures(
    SQLHSTMT      StatementHandle,
    SQLCHAR *     CatalogName,
    SQLSMALLINT   NameLength1,
    SQLCHAR *     SchemaName,
    SQLSMALLINT   NameLength2,
    SQLCHAR *     ProcName,
    SQLSMALLINT   NameLength3);
```

Arguments

StatementHandle

[Input] It is the statement handle.

CatalogName

[Input] It is the name of the procedure catalog. If the driver does not support the catalog, it returns an empty string ("") and the procedure does not include catalog. CatalogName can not include the string search pattern.

If SQL_ATTR_METADATA_ID is set to SQL_TRUE, CatalogName is treated as an identifier, and it is not case sensitive. If it is set to SQL_FALSE, CatalogName is treated as an ordinary argument literal, and it is case sensitive. For more information, refer to **Arguments of Catalog Function**.

NameLength1

[Input] It is the length of *CatalogName in characters.

SchemaName

[Input] It is the name of procedure schema. The string search pattern for the schema name. If the driver does not support the schema, it returns an empty string ("") and the procedure does not include the schema. SchemaName can not include the string search pattern.

If SQL_ATTR_METADATA_ID is set to SQL_TRUE, SchemaName is treated as an identifier, and it is not case sensitive. If it is set to SQL_FALSE, SchemaName is treated as a pattern value string argument, and it is case sensitive.

NameLength2

[Input] It is the length of *SchemaName in characters.

ProcName

[Input] It is the procedure name. This argument can not be a null pointer. ProcName can not include the string search pattern.

If SQL_ATTR_METADATA_ID is set to SQL_TRUE, ProcName is treated as an identifier, and it is not case sensitive. If it is set to SQL_FALSE, ProcName is treated as a pattern value string argument, and it is case sensitive.

NameLength3

[Input] It is the length of *ProcName in characters

Returns

SQL_SUCCESS, SQL_SUCCESS_WITH_INFO, SQL_STILL_EXECUTING, SQL_ERROR, SQL_INVALID_HANDLE.

Diagnosis

SQLSTATE	Error	Description
01000	General warning	It is the driver-specific informational message. (The function returns SQL_SUCCESS_WITH_INFO.)
08S01	Communication link failure	Before the function processing is completed, the connection between the driver and the data source is failed.
24000	Invalid cursor state	The cursor is open in StatementHandle, and SQLFetch or SQLFetchScroll is called. If SQLFetch or SQLFetchScroll returns SQL_NO_DATA, the driver returns this error. If SQLFetch or SQLFetchScroll does not return SQL_NO_DATA, the driver manager returns this error. The result set is open in StatementHandle, but SQLFetch or SQLFetchScroll is not called.
		The transaction is rolled back due to a resource deadlock of other transaction

SQLSTATE	Error	Description
40001	Serialization failure	s.
40003	Statement completion unknown	The related connection fails during the function execution and the status of the transaction is not able to be checked.
HY000	General error	It is an error without any specific SQLSTATE.
HY001	Memory allocation error	It is a memory allocation error.
HY009	Invalid use of null pointer	<p>TableName argument is a null pointer.</p> <p>SQL_ATTR_METADATA_ID statement attribute is set to SQL_TRUE, and CatalogName argument is a null pointer.</p> <p>SQLGetInfo with the SQL_CATALOG_NAME information type returns that catalog names are supported.</p> <p>SQL_ATTR_METADATA_ID statement attribute is set to SQL_TRUE, and SchemaName, ProcName or ColumnName argument is a null pointer.</p>
HY010	Function sequence error	<p>The asynchronously executing function is called for the connection handle related to StatementHandle, and this function is still being executed when SQLProcedureColumns is called.</p> <p>SQLExecute, SQLExecDirect, or SQLMoreResults is called for StatementHandle, and SQL_PARAM_DATA_AVAILABLE is returned. This function is called before the data is checked for all connected parameters.</p> <p>The asynchronously executing function is called for StatementHandle, and is still being executed when this function is called.</p> <p>SQLExecute, SQLExecDirect, SQLBulkOperation or SQLSetPos is called for StatementHandle, and SQL_NEED_DATA is returned. This function is called before data is sent for all data-at-execution parameters or columns.</p>
HY013	Memory management error	The internal memory can not be accessed or the available memory size is small.
HY090	Invalid string or buffer length	<p>A name length argument value is smaller than 0 but it is not as same as SQL_NTS.</p> <p>A name length argument value is bigger than the maximum length corresponding to the name.</p>
HY117	Connection is suspended due to unknown transaction state. Only disconnect and read-only functions are allowed.	For more information about the suspended state, refer to SQLEndTran .
		The catalog is specified, but the driver or the data source does not support th

SQLSTATE	Error	Description
HYC00	Optional feature not implemented	<p>e catalog.</p> <p>The schema is specified, but the driver or the data source does not support the schema.</p> <p>The combination of current setting of SQL_ATTR_CONCURRENCY and SQL_ATTR_CURSOR_TYPE statement attributes is not supported by the driver or data source.</p> <p>SQL_ATTR_USE_BOOKMARKS statement attribute is set to SQL_UB_VARIABLE, and SQL_ATTR_CURSOR_TYPE statement attribute is set to the cursor type for the bookmark that is not supported by the driver.</p>
HYT00	Timeout expired	The query timeout is expired before getting the result set from the data source. The timeout can be set via SQL_ATTR_QUERY_TIMEOUT of SQLSetStmtAttr.
HYT01	Connection timeout expired	The connection is expired before the data source responds to the request. The timeout can be set via SQL_ATTR_CONNECTION_TIMEOUT of SQLSetStmtAttr.
IM001	Driver does not support this function	The driver which is related to StatementHandle does not support the function.
IM017	Polling is disabled in asynchronous notification mode	Whenever using the notification model, polling can not be used.
IM018	SQLCompleteAsync has not been called to complete the previous asynchronous operation on this handle.	If the previous function call for the handle returns SQL_STILL_EXECUTING and if the notification mode is activated, then SQLCompleteAsync should be called for the handle to do post processing and complete the operation.

Description

SQLProcedures lists all procedures in the requested range. A user may or may not have privileges to execute these procedures. Refer SQL_ACCESSIBLE_PROCEDURES of SQLGetInfo to check accessibility. If a user selects the procedure which can not be executed, the application should be able to handle the situation. SQLProcedures returns the standard result set, and it is sorted in an order of PROCEDURE_CAT, PROCEDURE_SCHEMA, PROCEDURE_NAME

The following column names are changed in ODBC 3.x. The column name change does not affect the compatibility with the previous version because the application binds by the column number.

ODBC 2.0 column	ODBC 3.x column
-----------------	-----------------

ODBC 2.0 column	ODBC 3.x column
PROCEDURE_QUALIFIER	PROCEDURE_CAT
PROCEDURE_OWNER	PROCEDURE_SCHEM

SQLGetInfo is called together with SQL_MAX_CATALOG_NAME_LEN, SQL_MAX_SCHEMA_NAME, SQL_MAX_PROCEDURE_NAME_LEN options in an application to determine the actual column length of PROCEDURE_CAT, PROCEDURE_SCHEM, PROCEDURE_NAME, COLUMN_NAME

The following table lists the columns in the result set. The additional row after column 8 (PROCEDURE_TYPE) is defined by the driver. The applications should get access to a specific driver column by performing the countdown from the end of the result set instead of specifying an explicit ordinal position.

Column name	Column number	Data type	Comments
PROCEDURE_CAT (ODBC 2.0)	1	Varchar	It is the procedure catalog name. If it can not be used in the data source, it is NULL. If the driver supports the catalog only for some tables, such as when the drive retrieves the data from another DBMS, it returns an empty string ("") for the table which does not have a catalog.
PROCEDURE_SCHEM (ODBC 2.0)	2	Varchar	It is the procedure schema identifier. If it can not be used in the data source, it is NULL. If the driver supports the schema only for some table, such as when the drive retrieves the data from another DBMS, it returns an empty string ("") for the table which does not have a schema.
PROCEDURE_NAME (ODBC 2.0)	3	Varchar not null	It is the procedure identifier.
REMARK (ODBC 2.0)	4	Varchar	It is the description on the procedure.
PROCEDURE_TYPE (ODBC 2.0)	5	Smallint	It defines a procedure type. <ul style="list-style-type: none"> SQL_PT_UNKNOWN: Where the procedure returns the value or not is unknown. SQL_PT_PROCEDURE: The returned object is a procedure. In other words, a return value does not exist. SQL_PT_FUNCTION: The returned object is a function. In other words, a return value exists.

SQLPutData

Conformance

Introduced version: ODBC 1.0

Standards compliance: ISO 92

Overview

SQLPutData allows the application to transfer a parameter to the driver or transfer the data to a column at statement execution time.

The function can be used to transfer a character or binary data value in parts to a column with a character, binary, or data source specific data type (For example, the parameter of SQL_LONGVARBINARY or SQL_LONGVARCHAR types).

Even if the default driver does not support unicode, SQLPutData supports the binding to Unicode C data types.

Syntax

```
SQLRETURN SQLPutData(  
    SQLHSTMT    StatementHandle,  
    SQLPOINTER  DataPtr,  
    SQLLEN      StrLen_or_Ind);
```

Arguments

StatementHandle

[Input] It is the statement handle.

DataPtr

[Input] It is the buffer pointer which includes the actual data for the parameter or column. The data should be the C data types specified by ValueType argument of SQLBindParameter (parameter data) or TargetType argument of SQLBindCol (column data).

StrLen_or_Ind

[Input] It is the length of *DataPtr. It specifies the amount of data transferred to SQLPutData call. The amount of data can be varied depending on each call to the given parameter or the column. StrLen_or_Ind is ignored if one of the following conditions is not satisfied.

- StrLen_or_Ind is SQL_NTS, SQL_NULL_DATA, or SQL_DEFAULT_PARAM.

- The C data type that is specified in `SQLBindParameter` or `SQLBindCol` is `SQL_C_CHAR` or `SQL_C_BINARY`.
- The C data type is `SQL_C_DEFAULT`, and the default C data type for the specified SQL data type is `SQL_C_CHAR` or `SQL_C_BINARY`.

For all other types of C data, if `StrLen_or_Ind` is not `SQL_NULL_DATA` or `SQL_DEFAULT_PARAM`, the driver determines that the size of `*DataPtr` is the size of C data type specified in `ValueType` or `TargetType`, and transfers the entire data value.

Returns

`SQL_SUCCESS`, `SQL_SUCCESS_WITH_INFO`, `SQL_STILL_EXECUTING`, `SQL_ERROR`, `SQL_INVALID_HANDLE`

Diagnosis

SQLSTATE	Error	Description
01000	General warning	It is the driver-specific informational message. (The function returns <code>SQL_SUCCESS_WITH_INFO</code> .)
01004	String data, right truncated	The string or binary data returned to the input/output or output parameters are truncated. If a string is truncated, the right part of the string is truncated. (The function returns <code>SQL_SUCCESS_WITH_INFO</code> .)
07006	Restricted data type attribute violation	The data value identified by the <code>ValueType</code> argument in <code>SQLBindParameter</code> for the bound parameter can not be converted to the data type identified by the <code>ParameterType</code> argument in <code>SQLBindParameter</code> .
07S01	Invalid use of default parameter	The parameter value set in <code>SQLBindParameter</code> is <code>SQL_DEFAULT_PARAM</code> , and the corresponded parameter does not have the default value.
08S01	Communication link failure	Before the function processing is completed, the connection between the driver and the data source is failed.
22001	String data, right truncation	The string or binary data is truncated. <code>SQL_NEED_LONG_DATA_LEN</code> information type is "Y" in <code>SQLGetInfo</code> , and more data is transferred for a long parameter than is specified with <code>StrLen_or_IndPtr</code> argument in <code>SQLBindParameter</code> . <code>SQL_NEED_LONG_DATA_LEN</code> information type is "Y" in <code>SQLGetInfo</code> , and more data is transferred for a long column than is specified in the buffer length corresponding to the data rows which are added or updated with <code>SQLBulkOperation</code> or updated with <code>SQLSetPos</code> .
22003	Numeric value out of range	The bound numeric parameter or the data which is transferred to the column causes the truncation for the numeric value when the related table column is allocated. The numeric value which is returned for the input/output parameter or output parameter is truncated.

SQLSTATE	Error	Description
22007	Invalid datetime format	<p>The data sent for a parameter or column which is bound to a date, time, or timestamp structure is invalid for each type.</p> <p>An input/output or output parameter is bound to a date, time, or timestamp C structure, and a value in the returned parameter is invalid for each type. (The function returns SQL_SUCCESS_WITH_INFO.)</p>
22008	Datetime field overflow	DATETIME expression is not valid for the bound DATE, TIME or TIMESTAMP C structure.
22012	Division by zero	An arithmetic expression calculated for an input/output or output parameter is in divided by zero.
22015	Interval field overflow	<p>The significant digits are lost due to the data transfer for an exact numeric or interval column or parameter to an interval SQL data type.</p> <p>The data transferred to one or more INTERVAL columns or parameters is converted into a numeric data type, but it can not be expressed as a numeric data type.</p> <p>The data transferred for the column or parameter data is assigned to INTERVAL SQL type, but it can not be expressed as the value of C type in INTERVAL SQL type.</p> <p>The significant digits of the data transferred for the exact number or the INTERVAL C column or parameter are lost.</p> <p>The data transferred for the column or parameter data is assigned to INTERVAL C type, but it can not be expressed as INTERVAL data structure.</p>
22018	Invalid character value for cast specification	<p>The character not represented as the character set of C buffer is included in the character column of the result set.</p> <p>The C type is the exact or approximate numeric, datetime, interval data type, and if the SQL type is the character data type, then the value of the column bound to the C type is invalid.</p>
HY000	General error	It is an error without any specific SQLSTATE.
HY001	Memory allocation error	It is a memory allocation error.
HY008	Operation canceled	<p>Asynchronous processing for StatementHandle is available and SQLCancel or SQLCancelHandle is called on StatementHandle before the function is called and completed. Then, this function is called again on StatementHandle.</p> <p>SQLCancel or SQLCancelHandle is called on StatementHandle from other thread in the multithreaded application before this function is called and completed.</p>
HY009	Invalid use of null	DataPtr argument is a null pointer, and StrLen_or_Ind argument is neither S

SQLSTATE	Error	Description
	pointer	QL_DEFAULT_PARAM nor SQL_NULL_DATA.
HY010	Function sequence error	<p>The previous function is not a call to SQLPutData or SQLParamData.</p> <p>The asynchronously executing function is called for the connection handle related to StatementHandle, but it is still being asynchronously executed when SQLPrimaryKeys is called.</p> <p>The asynchronously executing function is called for StatementHandle, but it is still being asynchronously executed when the function is called.</p> <p>SQLExecute, SQLExecDirect, SQLBulkOperation or SQLSetPos is called for StatementHandle, and SQL_NEED_DATA is returned. This function is called before data is sent for all data-at-execution parameters or columns.</p>
HY013	Memory management error	The internal memory can not be accessed or the available memory size is small.
HY019	Non-character and non-binary data sent in pieces	SQLPutData is called for the parameter or column one or more times, and it is not used to transfer the character C data to a column with the character, the binary or the data source-specific data type, or to transfer the binary C data to a column with the character, the binary or the data source-specific data type.
HY020	Attempt to concatenate a null value	SQLPutData is called once or more after SQL_NEED_DATA is returned, and StrLen_or_Ind argument includes SQL_NULL_DATA or SQL_DEFAULT_PARAM in one of these calls.
HY090	Invalid string or buffer length	DataPtr argument is not a null pointer, and StrLen_or_Ind is not equal to SQL_NTS or SQL_NULL_DATA, or is smaller than 0.
HY117	Connection is suspended due to unknown transaction state. Only disconnect and read-only functions are allowed.	For more information about the suspended state, refer to SQLEndTran .
HYT01	Connection timeout expired	The connection is expired before the data source responds to the request. The timeout can be set via SQL_ATTR_CONNECTION_TIMEOUT of SQLSetStmtAttr.
IM001	Driver does not support this function	The driver related to StatementHandle does not support the function.
IM017	Polling is disabled in asynchronous notification mode	Whenever using the notification model, polling can not be used.
	SQLCompleteAsy	

SQLSTATE	Error	Description
IM018	nc has not been called to complete the previous asynchronous operation on this handle.	If the previous function call for the handle returns SQL_STILL_EXECUTING and if the notification mode is activated, then SQLCompleteAsync should be called for the handle to do post processing and complete the operation.

Description

SQLPutData can be called to provide data-at-execution data for two uses. One is to use it as parameter data when calling SQLExecute or SQLExecDirect. The other is to use it as column data when updating or adding a row by calling SQLBulkOperations, or when updating a row by calling SQLSetPos.

When the application calls SQLParamData to determine which data should be transferred, the driver returns an indicator that the application can use to determine which parameter data to send or where column data can be found. The function also returns SQL_NEED_DATA which is an indicator to the application that it should call SQLPutData to transfer the data. In the DataPtr argument to SQLPutData, the application passes a pointer to the buffer including the actual data for the parameter or column.

When the driver returns SQL_SUCCESS for SQLPutData, the application calls SQLParamData again. For transferring more data, SQLParamData returns SQL_NEED_DATA, and the application calls SQLPutData again. If all data-at-execution data are transferred, SQL_SUCCESS is returned. And then the application calls SQLParamData again. If the driver returns SQL_NEED_DATA and another marker in *ValuePtrPtr, then it requests the data for other parameter or column and calls SQLPutData again. If the driver returns SQL_SUCCESS, then all data-at-execution data are transferred, and the SQL statement can be executed or SQLBulkOperations or SQLSetPos can be processed.



The application is allowed to use SQLPutData only when the character C data or binary C data is transferred to the character, binary or data source specific data type. If SQLPutData is called once or more under different conditions, SQL_ERROR and SQLSTATE HY019 are returned. (Non-character and non-binary data sent in pieces)

SQLRowCount

Conformance

Introduced version: ODBC 1.0

Standards compliance: ISO 92

Overview

SQLRowCount returns the number of rows which are affected by UPDATE, INSERT, or DELETE statement. (SQL_ADD, SQL_UPDATE_BY_BOOKMARK or SQL_DELETE_BY_BOOKMARK operation in SQLBulkOperations. Or SQL_UPDATE or SQL_DELETE operation in SQLSetPos)

Syntax

```
SQLRETURN SQLRowCount(
    SQLHSTMT StatementHandle,
    SQLLEN * RowCountPtr);
```

Arguments

StatementHandle

[Input] It is the statement handle.

RowCountPtr

[Output] It is the buffer pointer to which the number of rows is to be returned. For UPDATE, INSERT, DELETE statements, for the SQL_ADD, SQL_UPDATE_BY_BOOKMARK, SQL_DELETE_BY_BOOKMARK operations in SQLBulkOperations, and for the SQL_UPDATE or SQL_DELETE operations in SQLSetPos, the value returned to *RowCountPtr is the number of rows affected by the request. Or, it is -1 if the number of affected rows is not available.

When SQLExecute, SQLExecDirect, SQLBulkOperations, SQLSetPos or SQLMoreResults is called, SQL_DIAG_ROW_COUNT field of the diagnostic data structure is set to the number of rows, and the number of rows are cached in a way that depends on the implementation. SQLRowCount returns the number of cached rows. The number of cached rows are valid until when the statement handle is set again in the prepared or assigned state, or when the statement is executed again or when SQLCloseCursor is called. If SQL_DIAG_ROW_COUNT field is set and the function is called, then SQL_DIAG_ROW_COUNT field is set to 0 by calling any function, and the return value by SQLRowCount can be different from the value in SQL_DIAG_ROW_COUNT field.

For other statements and functions, the driver can define the value returned in *RowCountPtr. For

example, some data source can return the number of rows returned by SELECT statement before rows are patched.

Returns

SQL_SUCCESS, SQL_SUCCESS_WITH_INFO, SQL_ERROR, SQL_INVALID_HANDLE

Diagnosis

SQLSTATE	Error	Description
01000	General warning	It is the driver-specific informational message. (The function returns SQL_SUCCESS_WITH_INFO.)
HY000	General error	It is an error without any specific SQLSTATE.
HY001	Memory allocation error	It is a memory allocation error.
HY010	Function sequence error	<p>The asynchronously executing function is called for the connection handle related to StatementHandle, and this function is still being executed when SQLRowCount is called.</p> <p>SQLExecute, SQLExecDirect, SQLMoreResults is called for StatementHandle, and SQL_PARAM_DATA_AVAILABLE is returned. The function is called before data is retrieved for all streamed parameters.</p> <p>The function is called for StatementHandle, before SQLExecute, SQLExecDirect, SQLBulkOperations, or SQLSetPos is called.</p> <p>The asynchronously executing function is called for StatementHandle, and this function is still being executed when this function is called.</p> <p>SQLExecute, SQLExecDirect, SQLBulkOperation or SQLSetPos are called for StatementHandle, and SQL_NEED_DATA is returned. This function is called before data is sent for all data-at-execution parameters or columns.</p>
HY013	Memory management error	The internal memory can not be accessed or the available memory size is small.
HY117	Connection is suspended due to unknown transaction state. Only disconnect and read-only functions are allowed.	For more information about the suspended state, refer to SQLEndTran .
HYT00	Timeout expired	The query timeout is expired before getting the entire result set from the data source. The timeout can be set via SQL_ATTR_QUERY_TIMEOUT of SQLSetStmtAttr.
HYT01	Connection timeout expired	The connection is expired before the data source responds to the request. The timeout can be set via SQL_ATTR_CONNECTION_TIMEOUT of SQLSet

SQLSTATE	Error	Description
	red	StmtAttr.
IM001	Driver does not support this function	The driver which is related to StatementHandle does not support the function.

Description

If the last SQL statement executed for the statement handle is not UPDATE, INSERT, DELETE, or if an operation argument of the previous SQLBulkOperations call is not SQL_ADD, SQL_UPDATE_BY_BOOKMARK, SQL_DELETE_BY_BOOKMARK or if an operation argument of the previous SQLSetPos call is not SQL_UPDATE, SQL_DELETE, then the value of *RowCountPtr is defined by the driver.

SQLSetConnectAttr

Conformance

Introduced version: ODBC 3.0

Standards compliance: ISO 92

Overview

SQLSetConnectAttr sets the attribute which controls the connection.

Syntax

```
SQLRETURN SQLSetConnectAttr(  
    SQLHDBC      ConnectionHandle,  
    SQLINTEGER   Attribute,  
    SQLPOINTER   ValuePtr,  
    SQLINTEGER   StringLength);
```

Arguments

ConnectionHandle

[Input] It is the connection handle.

Attribute

[Input] It is the attribute for setting.

ValuePtr

[Input] It is the pointer of the value related to attribute. According to the value of attribute, ValuePtr can be an unsigned integer or it points to a null-termination string. The integer type of attribute argument may not be the fixed length data type. For more information, refer to the Description section.

StringLength

[Input] If attribute is the ODBC-defined attribute and ValuePtr points to the string or binary buffer, then the argument should be the length of *ValuePtr. For string data, the argument should include the number of bytes of the string.

If attribute is the ODBC-defined attribute and ValuePtr is an integer, then StringLength is ignored.

If attribute is the driver-defined attribute, then the application indicates the attribute characteristics set by StringLength argument to the driver manager. StringLength may have one of the following v

alues:

- If ValuePtr is a string pointer, StringLength is the string length or SQL_NTS.
- If ValuePtr is a binary buffer pointer, the application stores the result of SQL_LEN_BINARY_ATTR (length) macro which is a negative value in StringLength.
- If ValuePtr is neither string pointer nor binary buffer pointer, StringLength must have SQL_IS_POINTER.
- If ValuePtr contains the fixed length value, StringLength is SQL_IS_INTEGER or SQL_IS_UINTEGER.

Returns

SQL_SUCCESS, SQL_SUCCESS_WITH_INFO, SQL_ERROR, SQL_INVALID_HANDLE, SQL_STILL_EXECUTING

Diagnosis

SQLSTATE	Error	Description
01000	General warning	It is the driver-specific informational message. (The function returns SQL_SUCCESS_WITH_INFO.)
01S02	Option value changed	The value specified in ValuePtr is not supported by the driver and it is replaced with a similar value. (The function returns SQL_SUCCESS_WITH_INFO.)
08002	Connection name in use	Attribute argument is SQL_ATTR_ODBC_CURSORS, and the driver is already connected to the data source.
08003	Connection not open	Attribute value is assigned to request an open connection, but ConnectionHandle is not in a connected state.
08S01	Communication link failure	Before the function processing is completed, the connection between the driver and the data source is failed.
24000	Invalid cursor state	Attribute argument is SQL_ATTR_CURRENT_CATALOG, and the result set is deferred.
25000	Illegal operation while in a local transaction	The local transaction is connected while attempting to connect the distributed transaction by setting of the connection attribute SQL_ATTR_ENLIST_IN_DTC. The connection to the distributed transaction is already enlisted. The connection to the distributed transaction is already enlisted, the local transaction is started by setting SQL_ATTR_AUTOCOMMIT to SQL_AUTOCOMMIT_OFF.
3D000	Invalid catalog name	Attribute argument is SQL_ATTR_CURRENT_CATALOG and the specified catalog name is not valid.
HY000	General error	It is an error without any specific SQLSTATE.
HY001	Memory allocation	It is a memory allocation error.

SQLSTATE	Error	Description
	n error	
HY008	Operation cancelled	<p>The asynchronous processing is activated for ConnectionHandle. The SQLSetConnectAttr function is called, and before it completes execution, the SQLCancelHandle function is called on the ConnectionHandle, and then the SQLSetConnectAttr function is called again on the ConnectionHandle.</p> <p>Or, SQLSetConnectAttr function is called, and before it completes execution, SQLCancelHandle is called on the ConnectionHandle from a different thread in a multithread application.</p>
HY009	Invalid use of null pointer	Attribute argument identifies the connection attribute which requires the string value, and ValuePtr argument is a null pointer.
HY010	Function sequence error	<p>The asynchronously executing function is called for the statementHandle related to ConnectionHandle, and this function is still being executed when SQLSetConnectAttr is called.</p> <p>The asynchronously executing function is called for the ConnectionHandle, and this function is still being executed when this function is called.</p> <p>SQLExecute, SQLExecDirect, SQLMoreResults is called for one of StatementHandle related to ConnectionHandle, and SQL_PARAM_DATA_AVAILABLE is returned. The function is called before data is retrieved for all streamed parameters.</p> <p>SQLExecute, SQLExecDirect, SQLBulkOperation or SQLSetPos are called for StatementHandle related to ConnectionHandle, and SQL_NEED_DATA is returned. This function is called before data is sent for all data-at-execution parameters or columns.</p> <p>SQLBrowseConnect is called for ConnectionHandle, and SQL_NEED_DATA is returned. The function is called before SQLBrowseConnect returns SQL_SUCCESS_WITH_INFO or SQL_SUCCESS.</p>
HY011	Attribute cannot be set now	Attribute argument is SQL_ATTR_TXN_ISOLATION, and the transaction is open.
HY013	Memory management error	The internal memory can not be accessed or the available memory size is small.
HY024	Invalid attribute value	<p>The specified Attribute value is assigned, and the invalid value is specified to ValuePtr.</p> <p>Attribute argument is SQL_ATTR_TRACEFILE or SQL_ATTR_TRANSLATE_LIB, and ValuePtr is an empty string.</p>
HY090	Invalid string or buffer length	ValuePtr is a string and StringLength argument is smaller than 0 but it is not SQL_NTS.
	Driver does not support connectio	The application tries to activate asynchronous execution with SQL_ATTR_AS

SQLSTATE	Error	Description
HY114	n-level asynchronous function execution	YNC_DBC_FUNCTIONS_ENABLE when the driver does not support asynchronous connection.
HY117	Connection is suspended due to unknown transaction state. Only disconnect and read-only functions are allowed.	For more information about the suspended state, refer to SQLEndTran .
HY121	Cursor Library and Driver-Aware Pooling cannot be enabled at the same time	It is not supported by the driver.
HYC00	Optional feature not implemented	The value specified for Attribute argument is valid for the ODBC connection or the statement attribute for the version supported by the driver, but it is not supported by the driver.
HYT01	Connection timeout expired	The connection is expired before the data source responds to the request. The timeout can be set via SQL_ATTR_CONNECTION_TIMEOUT of SQLSetStmtAttr.
IM001	Driver does not support this function	The driver which is related to ConnectionHandle does not support the function.
IM009	Unable to load translation DLL	The driver can not load the transaction DDL specified for the connection. The error can be returned only when attribute is SQL_ATTR_TRANSLATE_LIB.
IM017	Polling is disabled in asynchronous notification mode	Whenever using the notification model, polling can not be used.
IM018	SQLCompleteAsync has not been called to complete the previous asynchronous operation on this handle.	If the previous function call for the handle returns SQL_STILL_EXECUTING and if the notification mode is activated, then SQLCompleteAsync should be called for the handle to do post processing and complete the operation.
S1118	Driver does not support asynchronous notification	SQL_ATTR_ASYNC_DBC_EVENT is set but the asynchronous notification is not supported by the driver.

Description

The application can call `SQLSetConnectAttr` at any time between the connection is assigned and released. All connections and the statement attributes set by the application for connection are maintained until `SQLFreeHandle` is called. For example, if an application calls `SQLSetConnectAttr` before connecting to a data source, the attribute is maintained even when `SQLSetConnectAttr` fails in the driver when the application connects to the data source. If the application sets the driver-specific attribute then the attribute is maintained even when the application connects to a different driver.



The feature to set the statement attribute at the connection level by `SQLSetConnectAttr` call is not used in ODBC 3.x. ODBC 3.x application should not set the statement attribute at the connection level. ODBC 3.x application can not set the statement attributes except for `SQL_ATTR_METADATA_ID` and `SQL_ATTR_ASYNC_ENABLE` attributes at the connection level. The two attributes are both the connection attribute and statement attribute and they can be set at the connection level or statement level. If ODBC 3.x driver operates with ODBC 2.x application which sets the ODBC 2.x statement option at the connection level, the ODBC 3.x driver is required to support it.

Some connection attributes can be set only before the connection is made, and some other attributes can be set only after the connection is made. The following table describes these connection attributes.

Attribute	Whether it is set before or after connection
<code>SQL_ATTR_ACCESS_MODE</code>	Either[1]
<code>SQL_ATTR_ASYNC_DBC_EVENT</code>	Either
<code>SQL_ATTR_ASYNC_DBC_FUNCTIONS_ENABLE</code>	Either[4]
<code>SQL_ATTR_ASYNC_DBC_PCALLBACK</code>	Either
<code>SQL_ATTR_ASYNC_DBC_PCONTEXT</code>	Either
<code>SQL_ATTR_ASYNC_ENABLE</code>	Either[2]
<code>SQL_ATTR_AUTO_IPD</code>	Either
<code>SQL_ATTR_AUTOCOMMIT</code>	Either[5]
<code>SQL_ATTR_CONNECTION_DEAD</code>	After
<code>SQL_ATTR_CONNECTION_TIMEOUT</code>	Either
<code>SQL_ATTR_CURRENT_CATALOG</code>	Either[1]
<code>SQL_ATTR_DBC_INFO_TOKEN</code>	After
<code>SQL_ATTR_ENLIST_IN_DTC</code>	After
<code>SQL_ATTR_LOGIN_TIMEOUT</code>	Before
<code>SQL_ATTR_METADATA_ID</code>	Either
<code>SQL_ATTR_OLDPWD</code>	Before
<code>SQL_ATTR_ODBC_CURSORS</code>	Before
<code>SQL_ATTR_PACKET_SIZE</code>	Before

Attribute	Whether it is set before or after connection
SQL_ATTR_QUIET_MODE	Either
SQL_ATTR_TRACE	Either
SQL_ATTR_TRACEFILE	Either
SQL_ATTR_TRANSLATE_LIB	After
SQL_ATTR_TRANSLATE_OPTION	After
SQL_ATTR_TXN_ISOLATION	Either ^[3]

[1] SQL_ATTR_ACCESS_MODE and SQL_ATTR_CURRENT_CATALOG can be set before and after the connection according to the driver. But the application which uses multiple drivers should set before the connection because these changes are not supported after the connection depending on the driver.

[2] SQL_ATTR_ASYNC_ENABLE should be set before the statement is activated.

[3] SQL_ATTR_TXN_ISOLATION can be set only when there is not any open transaction on the connection. Some connection attributes is supported by replacing with the similar value if the data source does not support the value specified by *ValuePtr. In this case, the driver returns SQL_SUCCESS_WITH_INFO and SQLSTATE 01S02 (Option value changed). For example, if Attribute is SQL_ATTR_PACKET_SIZE and *ValuePtr exceeds the maximum packet size, the driver replaces it with the maximum packet size, the application calls SQLSetConnectAttr to check the replaced value.

[4] If SQL_ATTR_ASYNC_DBC_FUNCTIONS_ENABLE is set before the connection is open, the driver manager sets the driver attribute when the driver is loaded while SQLBrowseConnect, SQLConnect, or SQLDriverConnect is called. Before SQLBrowseConnect, SQLConnect, or SQLDriverConnect is called, the driver manager does not know which driver is connected and does not know whether the driver supports the asynchronous operation for connection. Therefore, the driver manager returns SQL_SUCCESS. However if the driver does not support the asynchronous operation for connection, then calling SQLBrowseConnect, SQLConnect, or SQLDriverConnect will fail.

[5] If SQL_ATTR_AUTOCOMMIT is set to FALSE and API returns SQL_ERROR, the application should call SQLEndTran (SQL_ROLLBACK) to guarantee the transaction consistency.

Information type in *ValuePtr buffer depends on the specified attribute. SQLSetConnectAttr accepts one of the null-termination character or integer value as attribute information. The character string indicated to by the ValuePtr argument of SQLSetConnectAttr has StringLength bytes length.

If the length is defined in the attribute, StringLength argument is ignored as is the case of all attributes introduced in ODBC 2.x or the previous version.

Attribute	ValuePtr contents
	It is an SQLINTEGER value. SQL_MODE_READ_WRITE is the default value. SQL_MODE_READ_ONLY is used in the driver or data source as an indicator of which the conn

Attribute	ValuePtr contents
SQL_ATTR_ACCESS_MODE (ODBC 1.0)	Action is not requested to support SQL statement which causes update to occur. The mode can be used to optimize the proper lock strategy, transaction management or other area for the driver or the data source. The driver is not required to prevent such information which is sent to the data source. The behavior of the driver and data source when asked to process SQL statements which are not read-only during a read-only connection is implementation-defined.
SQL_ATTR_ASYNC_DBC_EVENT (ODBC 3.8)	It is not supported by the driver.
SQL_ATTR_ASYNC_DBC_FUNCTIONS_ENABLE (ODBC 3.8)	<p>It is an SQLINTEGER value which activates or deactivates asynchronous execution of selected functions on the connection handle.</p> <ul style="list-style-type: none"> • SQL_ASYNC_DBC_ENABLE_ON: It activates an asynchronous operation for the function related to the specified connection. • SQL_ASYNC_DBC_ENABLE_OFF: It deactivates an asynchronous operation for the function related to the specified connection. <p>SQL_ATTR_ASYNC_DBC_FUNCTIONS_ENABLE setting is always synchronous. (SQL_STILL_EXECUTING is not returned.)</p> <p>Asynchronous execution of the statement is activated by SQL_ATTR_ASYNC_ENABLE.</p>
SQL_ATTR_ASYNC_DBC_CALLBACK (ODBC 3.8)	It is not supported by the driver.
SQL_ATTR_ASYNC_DBC_CONTEXT (ODBC 3.8)	It is not supported by the driver..
SQL_ATTR_ASYNC_ENABLE (ODBC 3.0)	It is not supported by the driver.
SQL_ATTR_AUTO_IPD (ODBC 3.0)	It is not supported by the driver.
SQL_ATTR_AUTOCOMMIT (ODBC 1.0)	<p>It is an SQLINTEGER value which specifies whether to use the auto-commit or manual commit mode.</p> <ul style="list-style-type: none"> • SQL_AUTOCOMMIT_OFF: The driver uses the manual commit mode, and the application should explicitly commit or rollback the transaction with SQLEndTran. • SQL_AUTOCOMMIT_ON: The driver uses the auto-commit mode. Each statement is immediately executed and committed. All open transactions in the connection are committed when SQL_ATTR_AUTOCOMMIT is set to SQL_AUTOCOMMIT_ON. <p>Some data sources remove the access plan at the time of when the statement is committed to the connection and close the cursor. It may occur in auto commit mode after each non-query statements are executed or after the cursor is closed for the query. For more information, refer to SQL_CURSOR_COMMIT_BEHAVIOR and SQL_CURSOR_ROLLBACK_BEHAVIOR information type of SQLGetInfo.</p>

Attribute	ValuePtr contents
	<p>The batch can be executed in auto commit mode in two ways. The entire batch can be treated as the automatic processing unit, or each statement in a batch can be treated as the automatic processing unit. A particular data source may support both of these ways or it may select one and support it. The driver defines the entire batch or each statement in the batch processing can be treated as the automatic processing unit.</p>
SQL_ATTR_CONNECTION_DEAD(ODBC 3.5)	It is not supported by the driver.
SQL_ATTR_CONNECTION_TIMEOUT (ODBC 3.0)	It is not supported by the driver.
SQL_ATTR_CURRENT_CATALOG (ODBC 2.0)	It is not supported by the driver.
SQL_ATTR_DBC_INFO_TO_KEN (ODBC 3.8)	It is not supported by the driver.
SQL_ATTR_ENLIST_IN_DTC (ODBC 3.0)	It is not supported by the driver.
SQL_ATTR_LOGIN_TIMEOUT (ODBC 1.0)	<p>It is SQLINTEGER value corresponding to a wait time, in seconds, until the login request is completed before returning to the application. The default value depends on the driver. If ValuePtr is 0, the time limit is deactivated and the connection attempt will indefinitely wait.</p> <p>If the specified login request timeout exceeds the maximum login time limit, then the driver replaces the value and returns SQLSTATE 01S02 (Option value changed).</p>
SQL_ATTR_METADATA_ID (ODBC 3.0)	<p>It is SQLINTEGER value which determines how to handle the string argument of the catalog function. The default value is SQL_FALSE.</p> <p>If it is SQL_TRUE, string argument of the catalog function is regarded as an identifier and it is not case-sensitive. For a non-delimited string, the driver removes all trailing spaces and changes the string to uppercase. For a delimited string, the driver removes leading or trailing spaces and still has the character between delimiters. If one of these arguments is a null pointer, the function returns SQL_ERROR and SQLSTATE HY009 (Invalid use of null pointer).</p> <p>If it is SQL_FALSE, string argument of the catalog function is not regarded as an identifier and it is case-sensitive. So it may be processed as a string pattern according to the argument, or not.</p> <p>TableType argument of SQLTables which has the value list is not affected by the attribute.</p> <p>SQL_ATTR_METADATA_ID can be set in the statement step. (It is the unique connection attribute in the statement attribute.)</p>

Attribute	ValuePtr contents
	For more information, refer to Arguments of Catalog Function .
SQL_ATTR_OLDPWD	It is SQLPOINTER for the previous encrypted string. The value is write only, and it should be set prior to connecting to the server.
SQL_ATTR_ODBC_CURSORS (ODBC 2.0)	It is not supported by the driver.
SQL_ATTR_PACKET_SIZE (ODBC 2.0)	It is not supported by the driver.
SQL_ATTR_QUIET_MODE (ODBC 2.0)	It is not supported by the driver.
SQL_ATTR_TRACE (ODBC 1.0)	It is not supported by the driver.
SQL_ATTR_TRACEFILE (ODBC 1.0)	It is not supported by the driver.
SQL_ATTR_TRANSLATE_LIB (ODBC 1.0)	It is not supported by the driver.
SQL_ATTR_TRANSLATE_OPTION (ODBC 1.0)	It is not supported by the driver.
SQL_ATTR_TXN_ISOLATION (ODBC 1.0)	<p>It is 32-bit bit mask for setting the transaction isolation level for the current connection. The application should call <code>SQLEndTran</code> by using this option before calling <code>SQLSetConnectAttr</code> to commit or rollback all open transactions on connection.</p> <p>The valid value for ValuePtr can be determined by calling <code>SQLGetInfo</code> with InfoType which is equal to <code>SQL_TXN_ISOLATION_OPTIONS</code>.</p> <p>For more information about the transaction isolation level, refer to <code>SQL_DEFAULT_TXN_ISOLATION</code> information type of SQLGetInfo.</p>

[1] The function can be asynchronously called only when the descriptor is the implementation descriptor, but not the application descriptor.

SQLSetConnectOption

Conformance

Introduced version: ODBC 1.0

Standards compliance: It is not available.

Overview

ODBC 2.0 function `SQLSetConnectOption` is replaced with `SQLSetConnectAttr` in ODBC 3.x. For more information, refer to `SQLSetConnectAttr`.

SQLSetCursorName

Conformance

Introduced version: ODBC 1.0

Standards compliance: ISO 92

Overview

SQLSetCursorName connects the cursor name to the activated statement. If the application does not call SQLSetCursorName, then the driver generates the cursor name which is necessary to the SQL statement processing.

Syntax

```
SQLRETURN SQLSetCursorName(  
    SQLHSTMT      StatementHandle,  
    SQLCHAR *     CursorName,  
    SQLSMALLINT   NameLength);
```

Arguments

StatementHandle

[Input] It is the statement handle.

CursorName

[Input] It is the cursor name. A cursor name should not contain leading or trailing spaces for efficient processing, and if the cursor name includes a limited identifier, then the delimiter should be positioned on the first letter of the cursor name.

NameLength

[Input] It is the string length of *CursorName.

Returns

SQL_SUCCESS, SQL_SUCCESS_WITH_INFO, SQL_ERROR, SQL_INVALID_HANDLE

Diagnosis

SQLSTATE	Error	Description
01000	General warning	It is the driver-specific informational message. (The function returns SQL_SUCCESS_WITH_INFO.)
01004	String data, right truncated	The cursor name length exceeds the maximum, and only the string of the maximum allowable number is used.
24000	Invalid cursor state	The statement corresponding to StatementHandle is already running or it is in use as the to a positioning cursor.
34000	Invalid cursor name	The cursor name specified in *CursorName exceeds the maximum value of the driver, or it is not valid because it is started with SQLCUR or SQL_CUR.
3C000	Duplicate cursor name	The name specified in *CursorName already exists.
HY000	General error	It is an error without any specific SQLSTATE.
HY001	Memory allocation error	It is a memory allocation error.
HY009	Invalid use of null pointer	CursorName argument is a NULL pointer.
HY010	Function sequence error	<p>The asynchronously executing function is called for the connection handle related to StatementHandle, and this function is still being executed when SQLSetCursorName is called.</p> <p>SQLSetCursorName function is called and the asynchronously executing function is called for StatementHandle.</p> <p>SQLExecute, SQLExecDirect, SQLBulkOperation or SQLSetPos are called for StatementHandle, and SQL_NEED_DATA is returned. This function is called before data is sent for all data-at-execution parameters or columns.</p>
HY013	Memory management error	The internal memory can not be accessed or the available memory size is small.
HY090	Invalid string or buffer length	NameLength argument is smaller than 0. (It is not SQL_NTS.)
HY117	Connection is suspended due to unknown transaction state. Only disconnect and read-only functions are allowed.	For more information about the suspended state, refer to SQLEndTran .
HYT01	Connection timeout expired	The connection timeout period is expired before the data source responds to the request. The timeout can be set through SQL_ATTR_CONNECTION_TIMEOUT of SQLSetConnectAttr.
IM001	Driver does not support this function	The driver does not support the function.

Description

The cursor name is used for positioning update statements and positioning delete statements. (e.g. UPDATE table-name ... WHERE CURRENT OF cursor-name). If the application does not define the cursor name by calling `SQLSetCursorName` in the execution of query statement, then the driver generates the name which starts with `SQL_CUR` and does not exceed a length of 18 characters.

All cursor names should be unique within a connection. The maximum length of the cursor name is defined in the driver. For maximum interoperability, it is recommended that the application limit the cursor name of more than 18 characters. In ODBC 3.x, if the cursor name is enclosed in double quotes ("), it is considered to be case sensitive and it is not allowed by SQL syntax or it can include the specially treated characters like space or reserved word. The case-sensitive cursor name should be enclosed with double quotes (") identifier.

The cursor name remains until the related statement is deleted by using `SQLFreeHandle`. `SQLSetCursorName` can be called to rename a cursor on a statement when the cursor is in an allocated or prepared state.

SQLSetDescField

Conformance

Introduced version: ODBC 3.0

Standards compliance: ISO 92

Overview

SQLSetDescField sets the value of a single field of the descriptor record.

Syntax

```
SQLRETURN SQLSetDescField(  
    SQLHDESC      DescriptorHandle,  
    SQLSMALLINT   RecNumber,  
    SQLSMALLINT   FieldIdentifier,  
    SQLPOINTER    ValuePtr,  
    SQLINTEGER    BufferLength);
```

Arguments

DescriptorHandle

[Input] It is the descriptor handle.

RecNumber

[Input] It points to the descriptor record including a field which the application seeks to set. The descriptor records are numbered from 0 and the record number 0 is the bookmark record. RecNumber argument is ignored for the header field.

FieldIdentifier

[Input] It indicates the descriptor field to be set.

ValuePtr

[Input] It describes a buffer which contains the descriptor information or integer value. The data type depends on the value of FieldIdentifier. If ValuePtr is an integer value, it can be considered to be 8 bytes (SQLLEN), 4 bytes (SQLINTEGER), 2 bytes (SQLSMALLINT) according to the value of FieldIdentifier argument.

BufferLength

[Input] If FieldIdentifier is the ODBC defined field and ValuePtr points to the string or binary buffer, the argument should be the length of *ValuePtr. The argument should contain the number of bytes of the string for the string data.

If FieldIdentifier is the ODBC defined field and ValuePtr is an integer, BufferLength is ignored.

If FieldIdentifier is the driver defined field, the application describes the attribute features to the driver manager by setting BufferLength argument. BufferLength can have the following values.

- If ValuePtr is a string buffer pointer, BufferLength is the string length or SQL_NTS.
- If ValuePtr is a binary buffer pointer, the application stores the result of SQL_LEN_BINARY_ATTR (length) macro in BufferLength. BufferLength stores the negative value.
- If ValuePtr includes the fixed length value, BufferLength is one of SQL_IS_INTEGER, SQL_IS_UTINTEGER, SQL_IS_SMALLINT or SQL_IS_USMALLINT.

Returns

SQL_SUCCESS, SQL_SUCCESS_WITH_INFO, SQL_ERROR, SQL_INVALID_HANDLE

Diagnosis

SQLSTATE	Error	Description
01000	General warning	It is the driver-specific informational message. (The function returns SQL_SUCCESS_WITH_INFO.)
01S02	Option value changed	The driver does not support the value specified in *ValuePtr (if the value of ValuePtr is an integer.), or *ValuePtr is not valid on the implementation conditions, so the driver replaces it with a similar value. (The function returns SQL_SUCCESS_WITH_INFO.)
07009	Invalid descriptor index	<p>When FieldIdentifier argument is a record field, and RecNumber argument is 0, then DescriptorHandle argument refers to IPD handle.</p> <p>RecNumber argument is smaller than 0, and DescriptorHandle argument refers to ARD or APD.</p> <p>RecNumber argument is bigger than the maximum of the column or parameter supported by the data source, and DescriptorHandle argument refers to APD or ARD.</p> <p>FieldIdentifier argument is SQL_DESC_COUNT, and *ValuePtr argument is smaller than 0.</p> <p>RecNumber argument is equal to 0, and DescriptorHandle argument refers to APD which is implicitly assigned. (This error does not occur f</p>

SQLSTATE	Error	Description
		or the explicitly assigned application descriptor because it is unknown the application descriptor is APD or ARD until the execution time.)
08S01	Communication link failure	Before completing the function processing, the connection between the driver and the data source is failed.
22001	String data, right truncated	FieldIdentifier argument is SQL_DESC_NAME, and BufferLength argument has the value which is bigger than SQL_MAX_IDENTIFIER_LEN.
HY000	General error	It is an error without any specific SQLSTATE.
HY001	Memory allocation error	It is a memory allocation error.
HY010	Function sequence error	<p>The asynchronously executing function is called for DescriptorHandle related to StatementHandle, and this function is still being executed when SQLSetDescField is called.</p> <p>SQLExecute, SQLExecDirect, SQLBulkOperations or SQLSetPos is called on StatementHandle related to DescriptorHandle, and SQL_NEED_DATA is returned.</p> <p>The function is called before all data of the column or parameter are sent at the execution time.</p> <p>The asynchronously executing function is called for connection handle related to DescriptorHandle, and this function is still being executed when SQLSetDescField is called.</p> <p>SQLExecute, SQLExecDirect or SQLMoreResults is called for one of the statement handles related to DescriptorHandle, and SQL_PARAM_DATA_AVAILABLE is returned. The function is called before retrieving data for all streamed parameters.</p>
HY013	Memory management error	The internal memory can not be accessed or the available memory size is small.
HY016	Cannot modify an implementation row descriptor	DescriptorHandle argument is related to IRD, and FieldIdentifier argument is not SQL_DESC_ARRAY_STATUS_PTR nor SQL_DESC_ROWS_PROCESSED_PTR.
HY021	Inconsistent descriptor information	<p>SQL_DESC_TYPE and SQL_DESC_DATETIME_INTERVAL_CODE fields are not a valid ODBC SQL type, valid driver-specific SQL type or a valid ODBC C type.</p> <p>Descriptor information is not consistent when checking the integrity.</p>
HY090	Invalid string or buffer length	<p>*ValuePtr is a string and BufferLength is smaller than 0. (It is not SQL_NTS.)</p> <p>When the driver is the ODBC 2.x driver and the descriptor is ARD and ColumnNumber argument is set to 0, then the value specified in BufferLength is not 4.</p>
		The value specified in FieldIdentifier argument is not the value of OD

SQLSTATE	Error	Description
HY091	Invalid descriptor field identifier	BC defined field or the implementation defined value. FieldIdentifier argument is invalid for DescriptorHandle argument. FieldIdentifier argument is the ODBC defined field and it is read-only.
HY092	Invalid attribute/option identifier	The *ValuePtr value is invalid for FieldIdentifier argument. FieldIdentifier argument is SQL_DESC_UNNAMED, and ValuePtr is SQL_NAMED.
HY105	Invalid parameter type	The value specified in SQL_DESC_PARAMETER_TYPE field is invalid. (Refer to InputOutputType Argument in SQLBindParameter.)
HY117	Connection is suspended due to unknown transaction state. Only disconnect and read-only functions are allowed.	For more information about the suspended state, refer to SQLEndTran .
HYT01	Connection timeout expired	The connection timeout period expired before the response to the data request. The connection timeout period be set via SQL_ATTR_CONNECTION_TIMEOUT of SQLSetConnectAttr.
IM001	Driver does not support this function	The driver does not support the function.

Description

The application can call SQLSetDescField to set any descriptor field one at a time. One call sets a single field in a single descriptor. The function can be called for setting any field in any descriptor type if the field can be set.



If calling SQLSetDescField fails, the descriptor record contents identified by RecNumber argument is undefined.

Other functions can be called to set multiple descriptor fields with a single call. SQLSetDescRec function can set various fields which affect the data type and the binding column or the parameter buffer. (SQL_DESC_TYPE, SQL_DESC_DATETIME_INTERVAL_CODE, SQL_DESC_OCTET_LENGTH, SQL_DESC_PRECISION, SQL_DESC_SCALE, SQL_DESC_DATA_PTR, SQL_DESC_OCTET_LENGTH_PTR, SQL_DESC_INDICATOR_PTR)

SQLBindCol or SQLBindParameter can be used to completely set the columns and parameters. These functions can set a group of descriptor field with a single function call.

SQLSetDescField can be called to change the binding buffer by adding the offset to the binding points. (SQL_DESC_DATA_PTR, SQL_DESC_INDICATOR_PTR, SQL_DESC_OCTET_LENGTH_PTR) It allows the application change the binding buffers without calling SQLBindCol or SQLBindParameter like as SQL_DESC_DATA_TYPE changes SQL_DESC_DATA_PTR without changing other fields.

If the application calls SQLSetDescField to set any field other than SQL_DESC_COUNT or deferred fields (SQL_DESC_DATA_PTR, SQL_DESC_OCTET_LENGTH_PTR, SQL_DESC_INDICATOR_PTR), then the record binding can be released.

The descriptor header fields is set by calling SQLSetDescField with appropriate FieldIdentifier. Many header fields are the statement attributes, so they can be set by calling SQLSetStmtAttr. It allows the application to set the descriptor field first without obtaining the descriptor handle. When the header field is set by calling SQLSetDescField, RecNumber argument is ignored.

RecNumber which is 0 is used to set the bookmark field.



The statement attribute SQL_ATTR_USE_BOOKMARKS should be set before calling SQLSetDescField to set the bookmark fields. It is not necessary but is strongly recommended.

Order of Setting Descriptor Fields

When setting the descriptor fields by calling SQLSetDescField, the application should follow the specified order.

1. The application should preferentially set SQL_DESC_TYPE, SQL_DESC_CONCISE_TYPE or SQL_DESC_DATETIME_INTERVAL_CODE field.
2. After one of these fields is set, the application can set the attributes of the data types and the driver can set the data type setting fields to appropriate default values for the data types. Automatic default setting of the type attribute fields ensures that the descriptor is always ready to use after the application specifies the data types. When the application explicitly sets the data type attribute, the default attribute will be overwritten.
3. After setting one of the fields in step 1 and setting the data type attribute, the application can set SQL_DESC_DATA_PTR. It prompts the consistency check of the descriptor fields. If the application sets SQL_DESC_DATA_PTR field after changing the data type or attribute, the driver sets SQL_DESC_DATA_PTR to a NULL pointer and releases the record binding. It forces the application to sequentially complete the appropriate procedures before the descriptor record is able to be used.

Initializing Descriptor Field

When a descriptor is allocated, the descriptor fields can be initialized to the default value or it can be initialized to the value which does not have default or is not defined in the descriptor type. The following table describes the initialization of each field of each descriptor type. D refers to the initialization field with th

e default value. ND refers to the initialization field without default. The number refers that the default value of field is a number. The table also indicates whether the field is read/write or read-only.

The field of IRD can have the default value after the statement is prepared or executed and IRD is generated, and it is not when the statement handle or descriptor is allocated. Any access attempt to the IRD field returns an error until IRD is generated.

Some descriptor fields are defined for one or more, but not for all descriptor types (ARD, IRD, APD, IPD). If a field is not defined in the descriptor type, it is not required for the function which uses the descriptor.

The accessible fields by SQLGetDescField are not necessarily possible to be set with SQLSetDescField. The fields which can be set by SQLSetDescField are listed in the following table.

The following table describes the initialization of the header fields.

Header field name	Format	R/W	Default value
SQL_DESC_ALLOC_TYPE	SQLSMALLINT	ARD: R APD: R IRD: R IPD: R	ARD: SQL_DESC_ALLOC_AUTO for implicit or SQL_DESC_ALLOC_USER for explicit APD: SQL_DESC_ALLOC_AUTO for implicit or SQL_DESC_ALLOC_USER for explicit IRD: SQL_DESC_ALLOC_AUTO IPD: SQL_DESC_ALLOC_AUTO
SQL_DESC_ARRAY_SIZE	SQLULEN	ARD: R/W APD: R/W IRD: Unused IPD: Unused	ARD:[1] APD:[1] IRD: Unused IPD: Unused
SQL_DESC_ARRAY_STATUS_PTR	SQLUSMALLINT*	ARD: R/W APD: R/W IRD: R/W IPD: R/W	ARD: Null ptr APD: Null ptr IRD: Null ptr IPD: Null ptr
SQL_DESC_BIND_OFFSET_PTR	SQLLEN*	ARD: R/W APD: R/W IRD: Unused IPD: Unused	ARD: Null ptr APD: Null ptr IRD: Unused IPD: Unused
SQL_DESC_BIND_TYPE	SQLINTEGER	ARD: R/W APD: R/W IRD: Unused IPD: Unused	ARD: SQL_BIND_BY_COLUMN APD: SQL_BIND_BY_COLUMN IRD: Unused IPD: Unused
SQL_DESC_COUNT	SQLSMALLINT	ARD: R/W APD: R/W IRD: R IPD: R/W	ARD: 0 APD: 0 IRD: D IPD: 0
SQL_DESC_ROWS_P	SQLULEN	ARD: Unused APD: Unused	ARD: Unused APD: Unused

Header field name	Format	R/W	Default value
ROCESSED_PTR	*	RD: R/W IPD: R/W	IRD: Null ptr IPD: Null ptr

[1] Fields are defined only when IPD is automatically generated by the driver. Otherwise, they are not defined. When the application tries to set the fields, SQLSTATE HY091 (Invalid descriptor field identifier) will be returned.

The following table describes the initialization of the record fields.

Record field name	Format	R/W	Default value
SQL_DESC_AUTO_UNIQUE_VALUE	SQLINTEGER	ARD: Unused APD: Unused IRD: R IPD: Unused	ARD: Unused APD: Unused IRD: D IPD: Unused
SQL_DESC_BASE_COLUMN_NAME	SQLCHAR *	ARD: Unused APD: Unused IRD: R IPD: Unused	ARD: Unused APD: Unused IRD: D IPD: Unused
SQL_DESC_BASE_TABLE_NAME	SQLCHAR *	ARD: Unused APD: Unused IRD: R IPD: Unused	ARD: Unused APD: Unused IRD: D IPD: Unused
SQL_DESC_CASE_SENSITIVE	SQLINTEGER	ARD: Unused APD: Unused IRD: R IPD: R	ARD: Unused APD: Unused IRD: D IPD: D[1]
SQL_DESC_CATALOG_NAME	SQLCHAR *	ARD: Unused APD: Unused IRD: R IPD: Unused	ARD: Unused APD: Unused IRD: D IPD: Unused
SQL_DESC_CHAR_LENGTH_UNITS	SQLSMALLINT	ARD: Unused APD: Unused IRD: Unused IPD: W	ARD: Unused APD: Unused IRD: ND IPD: Unused
SQL_DESC_CONCISE_TYPE	SQLSMALLINT	ARD: R/W APD: R/W IRD: R IPD: R/W	ARD: SQL_C_ DEFAULT APD: SQL_C_ DEFAULT IRD: D IPD: ND
SQL_DESC_DATA_PTR	SQLPOINTER	ARD: R/W APD: R/W IRD: Unused IPD: Unused	ARD: Null ptr APD: Null ptr IRD: Unused IPD: Unused[2]

Record field name	Format	R/W	Default value
SQL_DESC_DATETIME_INTERVAL_CODE	SQLSMALLINT	ARD: R/W APD: R/W IRD: R IPD: R/W	ARD: ND APD: ND IRD: D IPD: ND
SQL_DESC_DATETIME_INTERVAL_PRECISION	SQLINTEGER	ARD: R/W APD: R/W IRD: R IPD: R/W	ARD: ND APD: ND IRD: D IPD: ND
SQL_DESC_DISPLAY_SIZE	SQLLEN	ARD: Unused APD: Unused IRD: R IPD: Unused	ARD: Unused APD: Unused IRD: D IPD: Unused
SQL_DESC_FIXED_PREC_SCALE	SQLSMALLINT	ARD: Unused APD: Unused IRD: R IPD: R	ARD: Unused APD: Unused IRD: D IPD: D[1]
SQL_DESC_INDICATOR_PTR	SQLLEN *	ARD: R/W APD: R/W IRD: Unused IPD: Unused	ARD: Null ptr APD: Null ptr IRD: Unused IPD: Unused
SQL_DESC_LABEL	SQLCHAR *	ARD: Unused APD: Unused IRD: R IPD: Unused	ARD: Unused APD: Unused IRD: D IPD: Unused
SQL_DESC_LENGTH	SQLULEN	ARD: R/W APD: R/W IRD: R IPD: R/W	ARD: ND APD: ND IRD: D IPD: ND
SQL_DESC_LITERAL_PREFIX	SQLCHAR *	ARD: R/W APD: R/W IRD: R IPD: R/W	ARD: Unused APD: Unused IRD: D IPD: Unused
SQL_DESC_LITERAL_SUFFIX	SQLCHAR *	ARD: Unused APD: Unused IRD: R IPD: Unused	ARD: Unused APD: Unused IRD: D IPD: Unused
SQL_DESC_LOCAL_TYPE_NAME	SQLCHAR *	ARD: Unused APD: Unused IRD: R IPD: R	ARD: Unused APD: Unused IRD: D IPD: D[1]
SQL_DESC_NAME	SQLCHAR *	ARD: Unused APD: Unused IRD: R	ARD: Unused APD: Unused IRD: D

Record field name	Format	R/W	Default value
		IPD: R/W	IPD: D[1]
SQL_DESC_NULLABLE	SQLSMALLINT	ARD: Unused APD: Unused IRD: R IPD: R	ARD: ND APD: ND IRD: D IPD: ND
SQL_DESC_NUM_PREC_RADIX	SQLINTEGER	ARD: R/W APD: R/W IRD: R IPD: R/W	ARD: ND APD: ND IRD: D IPD: ND
SQL_DESC_OCTET_LENGTH	SQLLEN	ARD: R/W APD: R/W IRD: R IPD: R/W	ARD: ND APD: ND IRD: D IPD: ND
SQL_DESC_OCTET_LENGTH_PTR	SQLLEN *	ARD: R/W APD: R/W IRD: Unused IPD: Unused	ARD: Null ptr APD: Null ptr IRD: Unused IPD: Unused
SQL_DESC_PARAMETER_TYPE	SQLSMALLINT	ARD: Unused APD: Unused IRD: Unused IPD: R/W	ARD: Unused APD: Unused IRD: Unused IPD: D=SQL_PARAM_INPUT
SQL_DESC_PRECISION	SQLSMALLINT	ARD: R/W APD: R/W IRD: R IPD: R/W	ARD: ND APD: ND IRD: D IPD: ND
SQL_DESC_ROWVER	SQLSMALLINT	ARD: Unused APD: Unused IRD: R IPD: R	ARD: Unused APD: Unused IRD: ND IPD: ND
SQL_DESC_SCALE	SQLSMALLINT	ARD: R/W APD: R/W IRD: R IPD: R/W	ARD: ND APD: ND IRD: D IPD: ND
SQL_DESC_SCHEMA_NAME	SQLCHAR *	ARD: Unused APD: Unused IRD: R IPD: Unused	ARD: Unused APD: Unused IRD: D IPD: Unused
SQL_DESC_SEARCHABLE	SQLSMALLINT	ARD: Unused APD: Unused IRD: R IPD: Unused	ARD: Unused APD: Unused IRD: D IPD: Unused
		ARD: Unused	ARD: Unused

Record field name	Format	R/W	Default value
SQL_DESC_TABLE_NAME	SQLCHAR *	APD: Unused IRD: R IPD: Unused	APD: Unused IRD: D IPD: Unused
SQL_DESC_TYPE	SQLSMALLINT	ARD: R/W APD: R/W IRD: R IPD: R/W	ARD: SQL_C_DEFAULT APD: SQL_C_DEFAULT IRD: D IPD: ND
SQL_DESC_TYPE_NAME	SQLCHAR *	ARD: Unused APD: Unused IRD: R IPD: R	ARD: Unused APD: Unused IRD: D IPD: D ^[1]
SQL_DESC_UNNAMED	SQLSMALLINT	ARD: Unused APD: Unused IRD: R IPD: R/W	ARD: ND APD: ND IRD: D IPD: ND
SQL_DESC_UNSIGNED	SQLSMALLINT	ARD: Unused APD: Unused IRD: R IPD: R	ARD: Unused APD: Unused IRD: D IPD: D ^[1]
SQL_DESC_UPDATABLE	SQLSMALLINT	ARD: Unused APD: Unused IRD: R IPD: Unused	ARD: Unused APD: Unused IRD: D IPD: Unused

^[1]Fields are defined only when IPD is automatically generated by the driver. Otherwise, they are not defined. When the application tries to set the fields, SQLSTATE HY091 (Invalid descriptor field identifier) will be returned.

^[2]SQL_DESC_DATA_PTR field of IPD is set to force check the consistency. In the subsequent SQLGetDescField or SQLGetDescRec call, the driver does not need to return the value which SQL_DESC_DATA_PTR is set to.

FieldIdentifier Argument

FieldIdentifier argument indicates the descriptor field to be set. Descriptor consists of a descriptor header and a header field described in the following header field. Descriptor records consists of the record fields described in the following header field.

Header Field

Each descriptor consists of the following fields.

SQL_DESC_ALLOC_TYPE[All] (read-only)

This read-only SQLSMALLINT header field specifies whether the descriptor is automatically allocated by the driver or explicitly allocated by the application. The application can obtain this field but cannot update it. The field is set to SQL_DESC_ALLOC_AUTO by the driver when the descriptor is automatically allocated by the driver.

SQL_DESC_ARRAY_SIZE[Application descriptors]

This SQLLEN header field in ARD specifies the number of rows in a row set. This is the number of rows to be returned by calling SQLFetch, SQLFetchScroll, or to be operated by calling SQLBulkOperations or SQLSetPos.

The header field in APD, SQLULEN, specifies the number of parameters.

The default value of the field is 1. If SQL_DESC_ARRAY_SIZE is bigger than 1, SQL_DESC_DATA_PTR, SQL_DESC_INDICATOR_PTR and SQL_DESC_OCTET_LENGTH_PTR of APD or ARD points to an array. The constant of each array is equal to the field value.

The field in ARD can be set by calling SQLSetStmtAttr with SQL_ATTR_ROW_ARRAY_SIZE attribute. The field in APD can be set by calling SQLSetStmtAttr with SQL_ATTR_PARAMSET_SIZE attribute.

SQL_DESC_ARRAY_STATUS_PTR[All]

SQLSMALLINT* header field for each descriptor type points to an array of SQLUSMALLINT value. The arrays are named such as row status array (IRD), parameter status array (IPD), row operation array (ARD), parameter operation array (APD).

The header field in IRD points to the row status array which includes the status value after calling SQLBulkOperations, SQLFetch, SQLFetchScroll, or SQLSetPos. The application allocates the SQLUSMALLINT array and makes the field to point to the array. The field is a NULL pointer by default. The driver will create an array if SQL_DESC_ARRAY_STATUS_PTR field is not set to a NULL pointer.



If the application sets the elements of the row status array pointed by SQL_DESC_ARRAY_STATUS_PTR of IRD, the driver operation is not defined.

The array is initially populated by calling SQLBulkOperations, SQLFetch, SQLFetchScroll or SQLSetPos. If the call does not return SQL_SUCCESS or SQL_SUCCESS_WITH_INFO, the content of array pointed by the field is undefined. Elements of the array may contain the following values.

- SQL_ROW_SUCCESS: The row is successfully fetched, and it is not changed since the last fetch.
- SQL_ROW_SUCCESS_WITH_INFO: The row is successfully fetched, and it is not changed since the last fetch, but the warning for the row is returned.
- SQL_ROW_ERROR: An error occurs while the row is fetched.
- SQL_ROW_UPDATED: The row is successfully fetched, and it is updated since the last fetch. If the row is fetched again, the state is SQL_ROW_SUCCESS.
- SQL_ROW_DELETED: The row is deleted since the last fetch.
- SQL_ROW_ADDED: The row is inserted by SQLBulkOperations. If the row is fetched again, the state is

SQL_ROW_SUCCESS.

- SQL_ROW_NOROW: The row set is overlapped with the end of the result set. And any row is not returned corresponding to elements of the row status array.

This field of IRD can be set by calling `SQLSetStmtAttr` with `SQL_ATTR_ROW_STATUS_PTR` attribute.

`SQL_DESC_ARRAY_STATUS_PTR` field of IRD is valid after `SQL_SUCCESS` or `SQL_SUCCESS_WITH_INFO` is returned. If the return code is not one of these, anything pointed by `SQL_DESC_ROWS_PROCESSED_PTR` is not defined.

This header field in IPD indicates the parameter status array which includes status information of each parameter after calling `SQLExecute` or `SQLExecDirect`. If `SQLExecute` or `SQLExecDirect` is called and `SQL_SUCCESS` or `SQL_SUCCESS_WITH_INFO` is not returned, then the content of the array which is pointed by the field is not defined. The application allocates `SQLUSMALLINT` array, the field should point to the array. The driver will create an array if `SQL_DESC_ARRAY_STATUS_PTR` field is not set to a NULL pointer. Elements in the array contain the following values.

- `SQL_PARAM_SUCCESS`: The SQL statement is successfully executed for the parameter set.
- `SQL_PARAM_SUCCESS_WITH_INFO`: The SQL statement is successfully executed for the parameter set, but there is a warning information available to the diagnostic data structure.
- `SQL_PARAM_ERROR`: An error occurs to process the parameter set. The additional error information is in the diagnostic data structure.
- `SQL_PARAM_UNUSED`: This parameter is not used because some previous parameter set causes an error which aborts further processing, or `SQL_PARAM_IGNORE` is set to the parameter set in the array specified by `SQL_DESC_ARRAY_STATUS_PTR` field of APD.
- `SQL_PARAM_DIAG_UNAVAILABLE`: The diagnostic information can not be used. For example, the driver does not generate the level of error information by treating the array of the parameter as single one.

This field in IPD can be set by calling `SQLSetStmtAttr` with `SQL_ATTR_PARAM_STATUS_PTR` attribute.

In ARD, this field points to the row operation array for the value set by the application to determine whether the row is ignored in `SQLSetPos` operation. Elements of the array may contain the following values.

- `SQL_ROW_PROCEED`: The row is included in bulk operation using `SQLSetPos`. (This setting does not guarantee that the operation occurs on the row. If the row has `SQL_ROW_ERROR` state of IRD row status array, the driver will not be able to perform the operation for the row.)
- `SQL_ROW_IGNORE`: The row is excluded from the bulk operation using `SQLSetPos`.

If an element in the array is not set, all rows are included in the bulk operation. If the value of `SQL_DESC_ARRAY_STATUS_PTR` field of ARD is a NULL pointer, all rows are included in the bulk operation. It means that the pointer points to a valid array and all elements of the array are `SQL_ROW_PROCEED`. If all elements in an array are set to `SQL_ROW_IGNORE`, the values in the row status array are not updated for the ignored row.

This field in ARD also can be set by calling `SQLSetStmtAttr` with `SQL_ATTR_ROW_OPERATION_PTR` attribute.

This header field in ARD indicates the parameter operation array of the values which can be set by the application to determine whether the parameter set is ignored when `SQLExecute` or `SQLExecDirect` is called. Elements of the array may contain the following values.

- `SQL_PARAM_PROCEED`: The parameter set is included in `SQLExecute` or `SQLExecDirect` call.
- `SQL_PARAM_IGNORE`: The parameter set is not included in `SQLExecute` or `SQLExecDirect` call.

If an element in the array is not set, all parameter sets of the array are used to call `SQLExecute` or `SQLExecDirect`. If the value of `SQL_DESC_ARRAY_STATUS_PTR` field of APD is a NULL pointer, all parameter sets are used. It is interpreted as if the pointer points to the valid array and all elements of the array are `SQL_PARAM_PROCEED`.

This field in APD can be set by calling `SQLSetStmtAttr` with `SQL_ATTR_PARAM_OPERATION_PTR` attribute.

SQL_DESC_BIND_OFFSET_PTR[Application descriptors]

This `SQLLEN*` header field indicates the offset of the binding. It is set as a NULL pointer by default. If the field is not a NULL pointer, the driver dereferences the pointer and adds the dereferenced value to each of the deferred fields which has a non-null value in the descriptor record (`SQL_DESC_DATA_PTR`, `SQL_DESC_INDICATOR_PTR` and `SQL_DESC_OCTET_LENGTH_PTR`), and uses a new pointer value when binding.

The binding offset is always directly added to `SQL_DESC_DATA_PTR`, `SQL_DESC_INDICATOR_PTR` and `SQL_DESC_OCTET_LENGTH_PTR` fields. If the offset is changed to the other value, the new value is continuously and directly added as each descriptor field value.

The field is a deferred field. The field is not used at the time to be set and it is used later by the driver when the addresses of the data buffers are needed to be checked.

This field in ARD can be set by calling `SQLSetStmtAttr` with `SQL_ATTR_ROW_BIND_OFFSET_PTR` attribute. This field in APD can be set by calling `SQLSetStmtAttr` with `SQL_ATTR_PARAM_BIND_OFFSET_PTR` attribute.

For more information, refer to [SQLFetchScroll](#) or [SQLBindParameter](#).

SQL_DESC_BIND_TYPE[Application descriptors]

This `SQLINTEGER` header field is used to set the binding direction.

This field in ARD specifies the binding direction when `SQLFetchScroll` or `SQLFetch` is called in the related statement handle.

This field is set to `SQL_BIND_BY_COLUMN`(default) to select the column-wise binding for the column.

This field in ARD can be set by calling `SQLSetStmtAttr` with `SQL_ATTR_ROW_BIND_TYPE` attribute.

This field specifies the binding direction to be used in the Dynamic parameters.

This field is set to `SQL_BIND_BY_COLUMN`(default) to select the column-wise binding for the parameter.

This field can be set by calling `SQLSetStmtAttr` with `SQL_ATTR_PARAM_BIND_TYPE` attribute.

SQL_DESC_COUNT[All]

This header field of `SQLSMALLINT` specifies a 1-based index of the best record including the data. When the driver sets the data structure to the descriptor, `SQL_DESC_COUNT` should be set to display how many of the important records. The application does not need to specify the amount of space reserved for the records when allocating instances of the data structure. Like as the application specifies the contents of the records, the driver performs the requested operation to ensure that the descriptor handle indicates the data structure of sufficient size.

`SQL_DESC_COUNT` is not the number of all bound data columns or the number of parameters but is the number of highest-numbered records. If the binding of the highest-numbered column or parameter is released, `SQL_DESC_COUNT` is changed to the number of the next highest-numbered columns or parameters. If the binding of column or parameter which is smaller than the number of highest-numbered columns or parameters is released(when `TargetValuePtr` argument is set to a NULL pointer and `SQLBindCol` is called, or when `ParameterValuePtr` argument is set to a NULL pointer and `SQLBindParameter` is called.) `SQL_DESC_COUNT` is not changed. If columns or parameters to be added are bound with the number which is bigger than the highest-numbered record including the data, the driver automatically increases the value of `SQL_DESC_COUNT` field. If the binding for all columns are released by calling `SQLFreeStmt` with `SQL_UNBIND` option, `SQL_DESC_COUNT` field in `ARD` or `IRD` is set to 0. If `SQLFreeStmt` is called as `SQL_RESET_PARAMS` option, `SQL_DESC_COUNT` fields in `APD` and `IPD` are set to 0.

`SQL_DESC_COUNT` value can be explicitly set by calling `SQLSetDescField` in the application. If `SQL_DESC_COUNT` value is clearly reduced, all records having a bigger value than the new `SQL_DESC_COUNT` value are effectively deleted. If the value of `SQL_DESC_COUNT` field of `ARD` is clearly set to 0, all buffers are released except for the bound bookmark column. The number of records in the field of `ARD` do not include the bound bookmark column. The only way to release the bound bookmark column is set `SQL_DESC_DATA_PTR` to a NULL pointer.

SQL_DESC_ROWS_PROCESSED_PTR[Implementation descriptors]

This `SQLULEN*` header field in `IRD` points to the buffers which include the number of rows fetched after `SQLFetch` or `SQLFetchScroll` is called, or the number of rows and errors affected in the bulk operation performed by calling `SQLBulkOperations` or `SQLSetPos`.

This `SQLINTEGER*` header field of `IPD` points to the buffers which include the number of parameter set and errors processed. If it is a NULL pointer, it will not return the number.

`SQL_DESC_ROWS_PROCESSED_PTR` is valid only after `SQL_SUCCESS` or `SQL_SUCCESS_WITH_INFO` has been returned after calling `SQLFetch` or `SQLFetchScroll` (for an `IRD` field) or `SQLExecute`, `SQLExecDirect`, or `SQLParamData` (for an `IPD` field). If the functions does not return `SQL_SUCCESS` or `S`

SQL_SUCCESS_WITH_INFO, the buffer content is not defined and the buffer value is set to 0 until SQL_NO_DATA is returned.

This field in ARD can be set by calling SQLSetStmtAttr with SQL_ATTR_ROWS_FETCHED_PTR attribute. This field in APD can be set by calling SQLSetStmtAttr with SQL_ATTR_PARAMS_PROCESSED_PTR attribute.

The buffer which is pointed by this field is allocated by the application. It is the deferred output buffer set by the driver. A NULL pointer is set by default.

Record Field

Each descriptor includes at least one record consisting of the fields which defines one of the columns of data or dynamic parameters depending on the descriptor type. Each record is a complete specification of a single column or parameter.

SQL_DESC_AUTO_UNIQUE_VALUE[IRDs] (read-only)

This read-only SQLINTEGER record field has SQL_TRUE if it is auto-increment column. Otherwise, it has the SQL_FALSE. The field is read-only but it does not necessarily need to be read-only, if it is auto-increment column.

SQL_DESC_BASE_COLUMN_NAME[IRDs] (read-only)

This read-only SQLCHAR* record field includes the base column name of the result set column. If the base column name does not exist, the field includes an empty string.

SQL_DESC_TABLE_NAME[IRDs] (read-only)

This read-only SQLCHAR* record field includes the base table name of the result set column. If the base table name can not be defined or not available, the field includes an empty string.

SQL_DESC_CASE_SENSITIVE[Implementation descriptors] (read-only)

This read-only SQLINTEGER record field is SQL_TRUE if columns or parameters is case-sensitive when sorting and comparing. It is SQL_FALSE if it is case-insensitive or the column with non-character.

SQL_DESC_CATALOG_NAME[IRDs] (read-only)

This read-only SQLCHAR* record field includes the catalog of the base table including the column. If the column is a part of an expression or view, the return value depends on the driver. If the data source does not support or the catalog can not be determined, the field includes an empty string.

SQL_DESC_CHAR_LENGTH_UNITS[IPD]

This SQLSMALLINT record field describes the unit of SQL_DESC_LENGTH. (SQL_CLU_NONE/ SQL_CHARACTERS/ SQL_CLU_OCTETS)

SQL_DESC_CONCISE_TYPE[AII]

This SQLSMALLINT header field specifies a simplified form for all data types including datetime and interval data types.

The values of SQL_DESC_CONCISE_TYPE, SQL_DESC_TYPE and SQL_DESC_DATETIME_INTERVAL_CODE fields are interdependent. If time is set in a field, it should be set in others fields as well. SQL

_DESC_CONCISE_TYPE can be set by calling SQLBindCol, SQLBindParameter or SQLSetDescField. SQL_DESC_TYPE can be set by calling SQLSetDescField or SQLSetDescRec.

If SQL_DESC_CONCISE_TYPE is set to a concise data type except for the interval or datetime data type, SQL_DESC_TYPE field is set to the same value and SQL_DESC_DATETIME_INTERVAL_CODE field is set to 0.

If SQL_DESC_CONCISE_TYPE is set to a concise interval or datetime data type, SQL_DESC_TYPE field is set to a detailed data type (SQL_DATETIME or SQL_INTERVAL), and SQL_DESC_DATETIME_INTERVAL_CODE field is set to the appropriate sub code.

SQL_DESC_DATETIME_INTERVAL_CODE[All]

This SQLSMALLINT record field includes the sub code for specifying datetime or interval data type if SQL_DESC_TYPE field is SQL_DATETIME or SQL_INTERVAL. It is same for both SQL and C. The code includes the data type name with CODE which is replaced with TYPE or C_TYPE of datetime types, INTERVAL or C_INTERVAL of interval types.

If SQL_DESC_TYPE and SQL_DESC_CONCISE_TYPE of the application descriptor are set to SQL_C_DEFAULT and the descriptor is not related to the statement handle, the content of SQL_DESC_DATETIME_INTERVAL_CODE is not defined.

This field can set the datetime data types which is listed in the following table.

Datetime type	DATETIME_INTERVAL_CODE
SQL_TYPE_DATE/ SQL_C_TYPE_DATE	SQL_CODE_DATE
SQL_TYPE_TIME/ SQL_C_TYPE_TIME	SQL_CODE_TIME
SQL_TYPE_TIME_WITH_TIMEZONE/ SQL_C_TYPE_TIME_WITH_TIMEZONE	SQL_CODE_TIME_WITH_TIMEZONE
SQL_TYPE_TIMESTAMP/ SQL_C_TYPE_TIMESTAMP	SQL_CODE_TIMESTAMP
SQL_TYPE_TIMESTAMP_WITH_TIMEZONE/ SQL_C_TYPE_TIMESTAMP_WITH_TIMEZONE	SQL_CODE_TIMESTAMP_WITH_TIMEZONE

This field can set the interval data types which is listed in the following table.

Interval type	DATETIME_INTERVAL_CODE
SQL_INTERVAL_DAY/ SQL_C_INTERVAL_DAY	SQL_CODE_DAY
SQL_INTERVAL_DAY_TO_HOUR/ SQL_C_INTERVAL_DAY_TO_HOUR	SQL_CODE_DAY_TO_HOUR
SQL_INTERVAL_DAY_TO_MINUTE/ SQL_C_INTERVAL_DAY_TO_MINUTE	SQL_CODE_DAY_TO_MINUTE
SQL_INTERVAL_DAY_TO_SECOND/ SQL_C_INTERVAL_DAY_TO_SECOND	SQL_CODE_DAY_TO_SECOND

Interval type	DATETIME_INTERVAL_CODE
SQL_INTERVAL_HOUR/ SQL_C_INTERVAL_HOUR	SQL_CODE_HOUR
SQL_INTERVAL_HOUR_TO_MINUTE/ SQL_C_INTERVAL_HOUR_TO_MINUTE	SQL_CODE_HOUR_TO_MINUTE
SQL_INTERVAL_HOUR_TO_SECOND/ SQL_C_INTERVAL_HOUR_TO_SECOND	SQL_CODE_HOUR_TO_SECOND
SQL_INTERVAL_MINUTE/ SQL_C_INTERVAL_MINUTE	SQL_CODE_MINUTE
SQL_INTERVAL_MINUTE_TO_SECOND/ SQL_C_INTERVAL_MINUTE_TO_SECOND	SQL_CODE_MINUTE_TO_SECOND
SQL_INTERVAL_MONTH/ SQL_C_INTERVAL_MONTH	SQL_CODE_MONTH
SQL_INTERVAL_SECOND/ SQL_C_INTERVAL_SECOND	SQL_CODE_SECOND
SQL_INTERVAL_YEAR/ SQL_C_INTERVAL_YEAR	SQL_CODE_YEAR
SQL_INTERVAL_YEAR_TO_MONTH/ SQL_C_INTERVAL_YEAR_TO_MONTH	SQL_CODE_YEAR_TO_MONTH

SQL_DESC_DATETIME_INTERVAL_PRECISION[All]

This SQLINTEGER record field includes interval leading precision if SQL_DESC_TYPE field is SQL_INTERVAL. When SQL_DESC_DATETIME_INTERVAL_CODE field is set to interval data type, the field is set to the default interval leading precision.

SQL_DESC_DISPLAY_SIZE[IRDs] (read-only)

This read-only SQLINTEGER record field includes the maximum number of characters required to display the data from the column.

SQL_DESC_FIXED_PREC_SCALE[Implementation descriptors] (read-only)

This read-only SQLSMALLINT record field is set to SQL_TRUE if the column is an exact numeric column and it has the non-zero scale and the fixed precision. Otherwise, it is set to SQL_FALSE.

SQL_DESC_INDICATOR_PTR[Application descriptors]

This SQLLEN* record field in ARD indicates the indicator variable. The variable contains SQL_NULL_DATE if the column value is NULL. In APD, the indicator variable is set to SQL_NULL_DATA to specify a dynamic argument to NULL. Otherwise, the variable is 0.

If SQL_DESC_INDICATOR_PTR field of ARD is a NULL pointer, the driver is prevented from returning the information about whether the column is NULL. If the column is NULL and SQL_DESC_INDICATOR_PTR is a NULL pointer, SQLSTATE 22002 (Indicator variable required but not supplied) is returned when the driver tries to create a buffer after calling SQLFetch or SQLFetchScroll. If SQLFetch or SQLFetchScroll call does not return SQL_SUCCESS or SQL_SUCCESS_WITH_INFO, the buffer content is not defined.

SQL_DESC_INDICATOR_PTR field defines whether to set the field indicated by SQL_DESC_OCTET_LENGTH_PTR. If the column data value is NULL, the driver sets the indicator variable to SQL_NULL_DATA. The field indicated by SQL_DESC_OCTET_LENGTH_PTR is not set at that time. If the NULL value is not encountered during the fetch, the buffer indicated by SQL_DESC_INDICATOR_PTR is set to 0, and the buffer indicated by SQL_DESC_OCTET_LENGTH_PTR is set to the data length.

If SQL_DESC_INDICATOR_PTR field of APD is a NULL pointer, the application can not use the descriptor record to specify the arguments as NULL.

It is a deferred field. The field is not used when it is set but it is used when the driver describes the possibility of NULL (for ARD) or determines the possibility of NULL (for APD).

SQL_DESC_LABEL[IRDS] (read-only)

This read-only SQLCHAR* record field includes the column label or cover. If the column does not have its label, the variable includes the column name. If the column is not named or can not use its label, the variable includes an empty string.

SQL_DESC_LENGTH[AI]

This SQLULEN record field is a maximum length or actual length of the string, or binary data type in bytes. It is the actual length of fixed length data types or the maximum length of variable-length data types. The value always excludes NULL termination character at the end of the string. If the data type of the value is SQL_TYPE_DATE, SQL_TYPE_TIME, SQL_TYPE_TIMESTAMP or SQL interval data type, the field has the length of characters when the datetime or interval value is represented by string again.

This field value may be different from the value of the length defined in ODBC 2.x.

SQL_DESC_LITERAL_PREFIX[IRDS] (read-only)

This read-only SQLCHAR* record field includes the characters or character which the driver recognizes as a suffix. The variable includes an empty string for the data type to which the character suffix is not applicable.

SQL_DESC_LOCAL_TYPE_NAME[Implementation descriptors] (read-only)

This read-only SQLCHAR* record field includes a localized name for the data type which may be different from the regular name of the data type. If the localized name does not exist, then an empty string is returned. The field is only for the display purpose.

SQL_DESC_NAME[Implementation descriptor]

This SQLCHAR* record field includes the alias of the field in the row descriptor. If the alias of a column is not applied, the column name is returned. In either case, the driver sets SQL_DESC_UNNAMED field to SQL_NAMED when setting SQL_DESC_NAME. If column name or its alias does not exist, then the driver returns an empty string of SQL_DESC_NAME field and sets SQL_DESC_UNNAMED field to SQL_UNNAMED.

The application can set SQL_DESC_NAME field of IPD to a parameter name or alias to specify stored procedure parameters by name. SQL_DESC_NAME field of IRD is a read-only field. If the application tries to set the field, SQLSTATE HY091 (Invalid descriptor field identifier) is returned.

For IPD, if the driver does not support the named parameters, the field is not defined. If the driver supports the named parameters and it can explain the parameters, the parameter name is returned in this field.

SQL_DESC_NULLABLE[Implementation descriptors] (read-only)

For IRD, if the column of this read-only SQLSMALLINT record field is allowed to be NULL, it is SQL_NULLABLE. If NULL is not allowed, it is SQL_NO_NULLS. If the column is unknown whether or not to allow NULL, it is SQL_NULLABLE_UNKNOWN. The field exists particularly for a column in the result set.

For IPD, this field is always set to SQL_NULLABLE because the dynamic parameters are always allowed to have NULL and can not be set by the application.

SQL_DESC_NUM_PREC_RADIX[All]

This SQLINTEGER record field has the value of 2 when SQL_DESC_TYPE field is the approximate numeric data type. Because SQL_DESC_PRECISION field includes the number of the bits. The field has the value of 10 when SQL_DESC_TYPE field has the exact numeric data type because SQL_DESC_PRECISION field includes the number of decimal places. The field sets 0 for a non-numeric data type.

SQL_DESC_OCTET_LENGTH[All]

This SQLLEN record field includes the length in bytes of a string or binary data type. For the fixed length character or binary data type, it is the actual length (in bytes). For the variable length character or binary data type, it is the maximum length (in bytes). The value does not include a space of null-termination character for the implementation descriptor but it includes a space of null-termination character for the application descriptor. For the application data, the field contains the buffer size. For APD, the field is defined only for the output or input/output parameters.

SQL_DESC_OCTET_LENGTH_PTR[Application descriptors]

This SQLLEN* record field points to a variable which includes the total length in bytes of the dynamic argument (for parameter descriptor) or the bound column value (for row descriptors).

For APD, the value is ignored for all argument except for the string and binary. If the field is SQL_NULLS, the dynamic argument should be null-terminated. The application sets the variable which includes the result of SQL_DATA_AT_EXEC or SQL_LEN_DATA_AT_EXEC macro at execution time in the record field of APD to indicate that it is a bound parameter to be data-at-execution parameter. If one or more of such fields exist, SQL_DESC_DATA_PTR can be set to a value identifying the parameter to help the application determine which parameter is being requested.

If OCTET_LENGTH_PTR field of ARD is a NULL pointer, the driver does not return the column length information. If SQL_DESC_OCTET_LENGTH_PTR of APD is a NULL pointer, the driver assumes that the string and binary values are null-terminated. (Binary values should not be null-terminated, but a length should be given to avoid data interruption.)

If SQLFetch or SQLFetchScroll which fills the buffer pointed by the field does not return SQL_SUCCESS or SQL_SUCCESS_WITH_INFO, the buffer content is not defined. It is the deferred field. The field is not immediately used, but it is used later when the driver indicates or determines the octet length of the data.

SQL_DESC_PARAMETER_TYPE[IRDs]

This SQLSMALLINT record field is set to SQL_PARAM_INPUT for the input parameters, to SQL_PARAM_INPUT_OUTPUT for the input/output parameters, to SQL_PARAM_OUTPUT for the output parameters, to SQL_PARAM_INPUT_OUTPUT_STREAM for the stream input/output parameters or to SQL_PARAM_OUTPUT_STREAM for the stream output parameters. The default is SQL_PARAM_INPUT.

SQL_DESC_PRECISION[All]

This SQLSMALLINT record field includes the number of effective integer for the exact numeric type, and the number of bits of mantissa (binary precision) for the approximate numeric type. Or, it includes the number of digits in fractional seconds part of SQL_TYPE_TIME, SQL_TYPE_TIMESTAMP, or SQL_INTERVAL_SECOND data type. The field is undefined for all other data types.

The field value may be different from the value of the precision defined in ODBC 2.x.

SQL_DESC_ROWVER[Implementation descriptors] (read-only)

This SQLSMALLINT record field indicates whether the column is automatically updated by DBMS when the row is updated (e.g. timestamp of SQL server). The value of record field is set to SQL_TRUE if the column is the versioning column. Otherwise, it is set to SQL_FALSE. The column attribute is similar to calling SQLSpecialColumns with IdentifierType of SQL_ROWVER to determine whether to automatically update the column.

SQL_DESC_SCALE[All]

This SQLSMALLINT record field includes the number of decimal places defined in the decimal and numeric data types. The field is not defined for all other data types.

The field value may be different from the value of the scale defined in ODBC 2.x.

SQL_DESC_SCHEMA_NAME[IRDs] (read-only)

This read-only SQLCHAR* record field includes the schema name of the base table including the column. The return value is driver-dependent if the column is a part of a expression or view. If the data source does not support the schema or can not identify the schema name, then this variable contains an empty string.

SQL_DESC_SEARCHABLE[IRDs] (read-only)

This read-only SQLSMALLINT record field sets one of the following values.

- It is set to SQL_PRED_NONE if the column can not be used in WHERE clause. (It is as same as SQL_UNSEARCHABLE of ODBC 2.X.)
- It is set to SQL_PRED_CHAR if the column can be used in a WHERE clause but only with the LIKE predicate.
- It is set to SQL_PRED_BASIC if the column can be used with all comparison operators except for LIKE in WHERE clause. (It is as same as SQL_EXCEPT_LIKE of ODBC 2.x.)
- It is set to SQL_PRED_SEARCHABLE if the column can be used with all comparison operators in WHERE clause.

SQL_DESC_TABLE_NAME[IRDS] (read-only)

This read-only SQLCHAR* record field includes the base table name containing this column. The return value is driver-dependent if the column is an expression or a part of view.

SQL_DESC_TYPE[All]

This SQLSMALLINT record field includes an abbreviated SQL or C data types for all data types except for the datetime or interval data type. The field specifies SQL_DATETIME or SQL_INTERVAL for datetime or interval data type.

Whenever the field includes SQL_DATETIME or SQL_INTERVAL, SQL_DESC_DATETIME_INTERVAL_CODE field should include the appropriate server code of the concise form. SQL_DESC_TYPE includes SQL_DATETIME for the datetime data type, and SQL_DESC_DATETIME_INTERVAL_CODE field includes the sub code specifying the datetime data type. SQL_DESC_TYPE includes SQL_INTERVAL for the interval data type and SQL_DESC_DATETIME_INTERVAL_CODE field includes the sub code specifying the interval data type.

The values of SQL_DESC_TYPE and SQL_DESC_CONCISE_TYPE fields are interdependent. The other field should be set when one of the fields is set. SQL_DESC_TYPE can be set by calling SQLSetDescField or SQLSetDescRec. SQL_DESC_CONCISE_TYPE can be set by calling SQLBindCol, SQLBindParameter or SQLSetDescField.

If SQL_DESC_TYPE is set to the concise data type which is not interval nor datetime data type, SQL_DESC_CONCISE_TYPE field is set to the same value and SQL_DESC_DATETIME_INTERVAL_CODE field is set to 0.

If SQL_DESC_TYPE is set to the verbose data type of the datetime or interval data type (SQL_DATETIME or SQL_INTERVAL) and SQL_DESC_DATETIME_INTERVAL_CODE field is set to the appropriate sub code, SQL_DESC_CONCISE_TYPE field is set to the value corresponding to the concise data type. When trying to set SQL_DESC_TYPE to one of the concise datetime or interval data types, SQLSTATE HY021 (Inconsistent descriptor information) will be returned.

If SQL_DESC_TYPE field is set by calling SQLBindCol, SQLBindParameter or SQLSetDescField, the following fields are set to the default values described in the following table. The remaining field values of the same record are undefined.

SQL_DESC_TYPE value	Other fields implicitly set
SQL_CHAR, SQL_VARCHAR, SQL_C_CHAR, SQL_C_VARCHAR	SQL_DESC_LENGTH is set to 1. SQL_DESC_PRECISION is set to 0.
SQL_DATETIME	When SQL_DESC_DATETIME_INTERVAL_CODE is set to SQL_CODE_DATE or SQL_CODE_TIME, SQL_DESC_PRECISION is set to 0. When it is set to SQL_DESC_TIMESTAMP, SQL_DESC_PRECISION is set to 6.
SQL_DECIMAL, SQL_NUMERIC,	SQL_DESC_SCALE is set to 0. SQL_DESC_PRECISION is set to the implementation-defined precision for each data type.

SQL_DESC_TYPE value	Other fields implicitly set
SQL_C_NUMERIC	
SQL_FLOAT, SQL_C_FLOAT	SQL_DESC_PRECISION is set to the implementation-defined precision for SQL_FLOAT.
SQL_INTERVAL	If SQL_DESC_DATETIME_INTERVAL_CODE is set to interval data type, SQL_DESC_DATETIME_INTERVAL_PRECISION is set to 2 (default interval leading precision). When interval has the part of seconds, SQL_DESC_PRECISION is set to 6 (default interval seconds precision).

When the application sets the field of the descriptor by calling `SQLSetDescField` not `SQLSetDescRec`, the application should firstly define the data type. When doing like this, the other fields described in the table above are implicitly set. If any value is not allowed to set implicitly, the application can call `SQLSetDescField` or `SQLSetDescRec` to set the value explicitly.

SQL_DESC_TYPE_NAME[Implementation descriptors] (read-only)

This read-only `SQLCHAR*` record field includes the data source dependent type name (CHAR, VARCHAR etc.). If the data type name is unknown, the variable contains an empty string.

SQL_DESC_UNNAMED[Implementation descriptors]

If `SQL_DESC_NAME` field is set, the `SQLSMALLINT` record field in the row descriptor is set to one of `SQL_NAME` or `SQL_UNNAMED` by the driver. If `SQL_DESC_NAME` field includes the column alias or the column alias is not used, the driver sets `SQL_DESC_UNNAMED` field to `SQL_NAMED`. If the application sets `SQL_DESC_NAME` field of IPD to the parameter name or alias, the driver sets `SQL_DESC_UNNAMED` of IPD to `SQL_NAMED`. If column name or alias does not exist, the driver sets `SQL_DESC_UNNAMED` field to `SQL_UNNAMED`.

The application sets `SQL_DESC_UNNAMED` field of IPD to `SQL_UNNAMED`. If the application tries to set `SQL_DESC_UNNAMED` field of IPD to `SQL_NAMED`, the driver returns `SQLSTATE HY091` (Invalid descriptor field identifier). If the application tries to set `SQL_DESC_UNNAMED` field of IRD (read-only), `SQLSTATE HY091` (Invalid descriptor field identifier) will be returned.

SQL_DESC_UNSIGNED[Implementation descriptors] (read-only)

The read-only `SQLSMALLINT` record field is set to `SQL_TRUE` if the column type is the unsigned or non-numeric, or it is set to `SQL_FALSE` if the column type is signed.

SQL_DESC_UPDATABLE[IRDs] (read-only)

This read-only `SQLSMALLINT` record field is set to one of the following values.

- It is set to `SQL_ATTR_READ_ONLY` if the result set column is read-only.
- It is set to `SQL_ATTR_WRITE` if the result set column is read and write.
- It is set to `SQL_ATTR_READWRITE_UNKNOWN` if the updatability of the result set column is unknown.

`SQL_DESC_UPDATABLE` describes the updatability of the column (It is not the column in the base t

able.) in the result set. The updatability of the column in the base table whose result set columns are based on can be different from the value in the field. The updatability of the column is based on the definition of the data type, user privilege and result set itself. If the updatability of the column is unsure, `SQL_ATTR_READWRITE_UNKNOWN` should be returned.

SQL_DESC_CHAR_LENGTH_UNITS[Alls] (read-only)

This `SQLSMALLINT` record field indicates the length unit of the column whose SQL type is `SQL_CHAR`, `SQL_VARCHAR` and `SQL_LONGVARCHAR`.

- `SQL_CLU_CHARACTERS`: The length unit is CHARACTER. For example, data of "문자열" refers to the length of 3, if the encoding type is UHC(Unified Hangul Code).
- `SQL_CLU_OCTETS`: The length unit is OCTETS. For example, data of "문자열" refers to the length of 6, if the encoding type is UHC(Unified Hangul Code).
- `SQL_CLU_NONE`: The length unit is undefined. It is the value returned for SQL type except for the SQL types listed above.

Consistency Check

Concurrency check is automatically implemented by the driver each time the application passes the value to `SQL_DESC_DATA_PTR` of `ARD`, `APD`, or `IPD`. If anything of the fields is inconsistent with other fields, `SQLSetDescField` will return `SQLSTATE HY021` (Inconsistent descriptor information). For more information, refer to **Consistency Check** of `SQLSetDescRec`.

SQLSetDescRec

Conformance

Introduced version: ODBC 3.0

Standards compliance: ISO 92

Overview

SQLSetDescRec function sets the multiple descriptor fields affecting the buffer bound to a data type or column or parameter data.

Syntax

```
SQLRETURN SQLSetDescRec(  
    SQLHDESC      DescriptorHandle,  
    SQLSMALLINT   RecNumber,  
    SQLSMALLINT   Type,  
    SQLSMALLINT   SubType,  
    SQLLEN        Length,  
    SQLSMALLINT   Precision,  
    SQLSMALLINT   Scale,  
    SQLPOINTER    DataPtr,  
    SQLLEN *      StringLengthPtr,  
    SQLLEN *      IndicatorPtr);
```

Arguments

DescriptorHandle

[Input] It is the descriptor handle. IRD handle can not be set.

RecNumber

[Input] It indicates the descriptor record including the fields to be set. The descriptor record starts from 0, and the 0 record is a bookmark record. The argument should be equal to or bigger than 0. If RecNumber is bigger than SQL_DESC_COUNT, then SQL_DESC_COUNT is changed to RecNumber value.

Type

[Input] It is the value which sets SQL_DESC_TYPE field for the descriptor record.

SubType

[Input] It is the value which sets SQL_DESC_DATETIME_INTERVAL_CODE field for a record type of SQL_DATETIME or SQL_INTERVAL.

Length

[Input] It is the value which sets SQL_DESC_OCTET_LENGTH field for the descriptor record.

Precision

[Input] It is the value which sets SQL_DESC_PRECISION field for the descriptor record.

Scale

[Input] It is the value which sets SQL_DESC_SCALE field for the descriptor record.

DataPtr

[Deferred Input or Output] It is the value which sets SQL_DESC_DATA_PTR field for the descriptor record. DataPtr can be set to a NULL pointer.

DataPtr argument can be set to a NULL pointer to set SQL_DESC_DATA_PTR field to a NULL pointer. If the handle in DescriptorHandle argument is related to ARD, it unbinds the column.

StringLengthPtr

[Deferred Input or Output] It is the value which sets SQL_DESC_OCTET_LENGTH_PTR field for the descriptor record. StringLengthPtr can be set to a NULL pointer to set SQL_DESC_OCTET_LENGTH_PTR field to a NULL pointer.

IndicatorPtr

[Deferred Input or Output] It is the value which sets SQL_DESC_INDICATOR_PTR field of the descriptor record. IndicatorPtr can be set to a NULL pointer to set SQL_DESC_INDICATOR_PTR to a NULL pointer.

Returns

SQL_SUCCESS, SQL_SUCCESS_WITH_INFO, SQL_ERROR, SQL_INVALID_HANDLE

Diagnosis

SQLSTATE	Error	Description
01000	General warning	It is the driver-specific informational message. (The function returns SQL_SUCCESS_WITH_INFO.)
07009	Invalid descriptor index	RecNumber argument is set to 0, and DescriptorHandle refers to the IPD handle. RecNumber argument is bigger than the maximum number of columns or parameters supported by the data source, and DescriptorHandle argument is APD, IPD or ARD.

SQLSTATE	Error	Description
		RecNumber argument is 0, and DescriptorHandle argument refers to the implicitly allocated APD. (The error does not occur for the explicitly assigned application descriptor. This is because it is unknown whether the explicitly allocated application descriptor is APD or ARD until the execution time.)
08S01	Communication link failure	Before the function processing is completed, the connection between the driver and the data source is failed.
HY000	General error	It is an error without specific SQLSTATE, and the error message returned by SQLGetDiagRec in *MessageText buffer describes error message and its cause.
HY001	Memory allocation error	The driver can not allocate the memory required for execution or completion of the function.
HY010	Function sequence error	The asynchronously executing function is called for StatementHandle related to DescriptorHandle, and this function is still being executed when SQLSetDescRec is called.
HY013	Memory management error	The function is not executed because the underlying memory object can not be accessed because of the low memory condition.
HY016	Cannot modify an implementation row descriptor	DescriptorHandle argument is related to IRD.
HY021	Inconsistent descriptor information	The Type field, or other field related to SQL_DESC_TYPE field of the descriptor is not valid or consistent.
HY090	Invalid string or buffer length	The driver is set to ODBC 2.x driver, and the descriptor is set to ARD, and ColumnNumber argument is set to 0 and the value specified in BufferLength argument is not 4.
HY117	Connection is suspended due to unknown transaction state. Only disconnect and read-only functions are allowed	For more information about the suspended state, refer to SQLEndTran .
HYT01	Connection timeout expired	The connection timeout period is expired before the data source response to the request. The connection timeout interval can be set via SQL_ATTR_CONNECTION_TIMEOUT of SQLSetConnectAttr.
IM001	Driver does not support this function	The driver does not support the function.

Description

The application can call `SQLSetDescRec` to set the following fields for a column or parameter.

- `SQL_DESC_TYPE`
- `SQL_DESC_DATETIME_INTERVAL_CODE` (For the record of `SQL_DATETIME` or `SQL_INTERVAL` type)
- `SQL_DESC_OCTET_LENGTH`
- `SQL_DESC_PRECISION`
- `SQL_DESC_SCALE`
- `SQL_DESC_DATA_PTR`
- `SQL_DESC_OCTET_LENGTH_PTR`
- `SQL_DESC_INDICATOR_PTR`



If calling `SQLSetDescRec` fails, the content of the descriptor record identified by `RecNumber` argument is not defined.

When binding a column or parameter, `SQLSetDescRec` allows to change the multiple fields which affect the binding without calling `SQLBindCol`, `SQLBindParameter` or calling `SQLSetDescField` multiple times. `SQLSetDescRec` can set the descriptor fields which are not related to the current statement. `SQLBindParameter` can set more fields than `SQLSetDescRec`, and it can set the fields of APD and IPD with a single call and it does not require a descriptor handle.



The `SQL_ATTR_USE_BOOKMARKS` statement attribute should be set before calling `SQLSetDescRec` with `RecNumber` argument of 0 to set bookmark fields. It is not necessary but is strongly recommended.

Consistency Check

The consistency check is automatically implemented by the driver whenever the application sets `SQL_DESC_DATA_PTR` field of APD, ARD, or IPD. If any of the fields is not consistent with other fields, `SQLSetDescRec` will return `SQLSTATE HY021`. (Inconsistent descriptor information)

Whenever the application sets `SQL_DESC_DATA_PTR` field of APD, ARD or IPD, the driver checks the value of `SQL_DESC_TYPE` field, and checks if the values applicable to that `SQL_DESC_TYPE` field is valid and consistent. The check is implemented when `SQLBindParameter` or `SQLBindCol` is called or whenever `SQLSetDescRec` is called to APD, ARD or IPD. The consistency check includes the following descriptor fields.

- `SQL_DESC_TYPE` field should be one of the valid ODBC C, SQL type or the driver-specific SQL type. `SQL_DESC_CONCISE_TYPE` field should be one of the valid ODBC C, SQL Type or the driver-specific SQL type, and it includes the simplified datetime and interval types.
- If `SQL_DESC_TYPE` record field is `SQL_DATETIME` or `SQL_INTERVAL`, `SQL_DESC_DATETIME_INTERVAL`

L_CODE field should be one of the valid datetime or interval codes. (For more information refer to the description of SQL_DESC_DATETIME_INTERVAL_CODE field in **SQLSetDescField**.)

- If SQL_DESC_TYPE field is a NUMERIC type, SQL_DESC_PRECISION and SQL_DESC_SCALE fields are checked whether they are valid.
- If SQL_DESC_CONCISE_TYPE field is the time or timestamp data type an interval type with a seconds component, or one of the interval data types with a time component, SQL_DESC_PRECISION field is checked whether it is a valid second precision.
- If SQL_DESC_CONCISE_TYPE is an interval data type, SQL_DESC_DATETIME_INTERVAL_PRECISION field is checked to be a valid interval leading precision value.

SQL_DESC_DATA_PTR field of IPD is not generally set. The application can do so to force the consistency check for the IPD fields. Consistency check can not be executed in IRD. The value of SQL_DESC_DATA_PTR field of IPD is not actually stored and it can not be retrieved via SQLGetDescField or SQLGetDescRec. The setting is made only to force the consistency check.

SQLSetEnvAttr

Conformance

Introduced version: ODBC 3.0

Standards compliance: ISO 92

Overview

SQLSetEnvAttr sets the environment management attributes.

Syntax

```
SQLRETURN SQLSetEnvAttr(  
    SQLHENV     EnvironmentHandle,  
    SQLINTEGER  Attribute,  
    SQLPOINTER  ValuePtr,  
    SQLINTEGER  StringLength);
```

Arguments

EnvironmentHandle

[Input] It is the environment handle.

Attribute

[Input] They are listed in **Description**.

ValuePtr

[Input] It is a pointer to the value which is related to an attribute. Depending on the value of Attribute, ValuePtr points to a 32 bit integer value or null-terminated character.

StringLength

[Input] If ValuePtr points to the string or binary buffer, the argument should be the length of *ValuePtr. The argument should include the number of bytes in string for the character string data.

If ValuePtr is an integer, StringLength is ignored.

Returns

SQL_SUCCESS, SQL_SUCCESS_WITH_INFO, SQL_ERROR, SQL_INVALID_HANDLE

Diagnosis

SQLSTATE	Error	Description
01000	General warning	It is the driver-specific informational message. (The function returns SQL_SUCCESS_WITH_INFO.)
01S02	Option value changed	The driver does not support the value specified in ValuePtr and replaces it with a similar value. (The function returns SQL_SUCCESS_WITH_INFO.)
HY000	General error	It is an error without specific SQLSTATE, and the error message returned by SQLGetDiagRec in *MessageText buffer describes error message and its cause.
HY001	Memory allocation error	The driver can not allocate the memory required for execution or completion of the function.
HY009	Invalid use of null pointer	The attribute argument identifies an environment attribute which requires a string value, and ValuePtr argument is a NULL pointer.
HY010	Function sequence error	The connection handle is allocated to EnvironmentHandle. SQL_ATTR_ODBC_VERSION is not set to SQLSetEnvAttr, Attribute is different from SQL_ATTR_ODBC_VERSION. If SQLAllocHandleStd is used, SQL_ATTR_ODBC_VERSION does not need to be explicitly specified.
HY013	Memory management error	The function is not executed because the underlying memory object cannot be accessed because of the low memory condition.
HY024	Invalid attribute value	Considering the specified attribute value, the value of ValuePtr is not valid.
HY090	Invalid string or buffer length	StringLength argument is smaller than 0. (It is not SQL_NTS.)
HY092	Invalid attribute/option identifier	The specified value of attribute argument is not valid in ODBC version supported by the driver.
HY117	Connection is suspended due to unknown transaction state. Only disconnect and read-only functions are allowed	For more information about the suspended state, refer to SQLEndTran .
HYC00	Optional feature not implemented	The specified value of attribute argument is valid for the ODBC environment attribute supported by the driver but it is not supported by the driver. An attribute argument is SQL_ATTR_OUTPUT_NTS, and ValuePtr is SQL_FALSE.

Description

The application can call `SQLSetEnvAttr` only when connection handle allocated to the environment handle does not exist. The environment attributes which is set by the application persist until `SQLFreeHandle` is called to the environment handle. It is recommended to allocate and use only one environment handle.

The information format set through `ValuePtr` is dependent on the specified attribute. `SQLSetEnvAttr` accepts one attribute information of two different formats which are the null-termination string or 32 bits integer value. Each attribute format is described in the description of the attribute.

The driver-specific environment attributes does not exist.

The connection attribute can not be set with `SQLSetEnvAttr`. If it is tried, `SQLSTATE HY092` (Invalid attribute/option identifier) will be returned.

Attribute	ValuePtr contents
SQL_ATTR_CONNECTION_POOLING (ODBC 3.8)	It is not supported by the driver.
SQL_ATTR_CP_MATCH (ODBC 3.0)	It is not supported by the driver.
SQL_ATTR_ODBC_VERSION (ODBC 3.0)	<p>32-bit integer which indicates whether a particular feature is operated as ODBC 2.x or ODBC 3.x. The following values are used to set the attribute.</p> <ul style="list-style-type: none"> • SQL_OV_ODBC3_80: The driver manager and driver exhibit the following ODBC 3.8 behaviors. <ul style="list-style-type: none"> ◦ The driver expects and returns ODBC 3.x code value for DATE, TIME, TIMESTAMP. ◦ The driver returns ODBC 3.x SQLSTATE codes when <code>SQLError</code>, <code>SQLGetDiagField</code> or <code>SQLGetDiagRec</code> is called. ◦ <code>CatalogName</code> argument of <code>SQLTables</code> allows the pattern search. • SQL_OV_ODBC3: The driver manager and driver exhibit the following ODBC 3.x behaviors. <ul style="list-style-type: none"> ◦ The driver expects and returns ODBC 3.x code value for DATE, TIME, TIMESTAMP. ◦ The driver returns ODBC 3.x SQLSTATE codes when <code>SQLError</code>, <code>SQLGetDiagField</code> or <code>SQLGetDiagRec</code> is called. ◦ <code>CatalogName</code> argument of <code>SQLTables</code> allows the pattern search. ◦ The driver manager does not support the extensibility of C data types. • SQL_OV_ODBC2: The driver manager and driver exhibit the following ODBC 2.x behaviors. It is very useful when the ODBC 2.x application operates in ODBC 3.x. <ul style="list-style-type: none"> ◦ The driver expects and returns ODBC 2.x code value for DATE, TIME, TIMESTAMP. ◦ The driver returns ODBC 2.x SQLSTATE codes when <code>SQLError</code>, <code>SQLGetDiagField</code>

Attribute	ValuPtr contents
	<p>eld or SQLGetDiagRec is called.</p> <ul style="list-style-type: none"> ◦ CatalogName argument of SQLTables does not allow the pattern search. ◦ The driver manager does not support the extensibility of C data types. <p>The application should set the environment attribute value before calling any function which has SQLHENV argument, or it returns SQLSTATE HY010 (Function sequence error). It is driver-specific whether additional behavior exists for these environmental flags.</p>
SQL_ATTR_OUTPUT_NTS (ODBC 3.0)	It is not supported by the driver.

SQLSetParam

Conformance

Introduced version: ODBC 1.0

Standards compliance: It is not available.

Overview

ODBC 1.0 function `SQLSetParam` is replaced with ODBC 2.0 function `SQLBindParameter`. For more information, refer to [SQLBindParameter](#).

SQLSetPos

Conformance

Introduced version: ODBC 1.0

Standards compliance: ODBC

Overview

SQLSetPos sets the cursor position in the row set and allows the application to update the data in the row set or to update or delete the data in the result set.

Syntax

```
SQLRETURN SQLSetPos(  
    SQLHSTMT      StatementHandle,  
    SQLSETPOSIROW RowNumber,  
    SQLUSMALLINT  Operation,  
    SQLUSMALLINT  LockType);
```

Arguments

StatementHandle

[Input] It is the statement handle.

RowNumber

[Input] It is the row position in the row set which is specified with Operation argument to implement the operation. If RowNumber is 0, the operation is applied to all rows in the row set.

For more information, refer to **Description** section.

Operation

[Input] The operations to perform are SQL_POSITION, SQL_REFRESH, SQL_UPDATE, SQL_DELETE.

SQL_ADD value of Operation argument is not used in ODBC 3.x any more. The ODBC 2.x driver will be required to support SQL_ADD for the backward compatibility. This feature is replaced by calling SQLBulkOperations with operation of SQL_ADD. When ODBC 3.x application is performed with ODBC 2.x driver, the driver manager maps a call of SQLBulkOperations with an operation of SQL_ADD to a call of SQLSetPos with an operation of SQL_ADD.

For more information, refer to **Description** section.

LockType

[Input] The way to lock the row is specified after implementing the operation specified in Operation argument.

SQL_LOCK_NO_CHANGE, SQL_LOCK_EXCLUSIVE, SQL_LOCK_UNLOCK

For more information, refer to **Description** section.

Returns

SQL_SUCCESS, SQL_SUCCESS_WITH_INFO, SQL_NEED_DATA, SQL_STILL_EXECUTING, SQL_ERROR, SQL_INVALID_HANDLE

Diagnosis

SQLSTATE	Error	Description
01000	General warning	It is the driver-specific informational message. (The function returns SQL_SUCCESS_WITH_INFO.)
01001	Cursor operation conflict	Operation argument is SQL_DELETE or SQL_UPDATE. One or more rows are deleted/ updated, or any row is not deleted/ updated. Operation argument is SQL_DELETE or SQL_UPDATE, and optimistic concurrency causes the operation failure. (The function returns SQL_SUCCESS_WITH_INFO.)
01004	String data, right truncation	Operation argument is SQL_REFRESH, and string or binary data returned for a column(s) with a data type of SQL_C_CHAR or SQL_C_BINARY truncates n on white space character or non-NULL binary data.
01S01	Error in row	RowNumber argument is 0, and an error occurred in one or more rows while the operation which is specified in operation argument is executed. (If an error occurs on one or more, but not all, rows of a multirow operation, SQL_SUCCESS_WITH_INFO is returned. If an error occurs on a single row operation, SQL_ERROR is returned) (If the driver is ODBC 2.x and the cursor library is not used, then this SQLSTATE occurs only when SQLSetPos is called after SQLExtendedFetch.)
01S07	Fractional truncation	If an operation argument is SQL_REFRESH and the buffer type of the application is not SQL_C_CHAR or SQL_C_BINARY, and the data returned to the application buffer for one or more columns are truncated. For the numeric data types, the fractional parts of the number are truncated. For time, timestamp, and interval data types including a time component, the fractional parts of the time are truncated.
07006	Restricted data type attribute violation	The column data value of the result set can not be converted to the data type specified in TargetType when SQLBindCol is called.

SQLSTATE	Error	Description
	tion	
07009	Invalid descriptor index	Operation argument is SQL_REFRESH or SQL_UPDATE, and the column value which is bigger than the number of columns in the result set is bound.
21S02	Degree of derived table does not match column list	Operation argument is SQL_UPDATE, and updatable column does not exist because all bound column are released, read-only or the value in bound length/indicator buffer is SQL_COLUMN_IGNORE.
22001	String data, right truncation	Operation argument is SQL_UPDATE, and the assignment of a character or binary value to a column causes the truncation of a non empty string (for character), or non-null string (for binary) or bytes.
22003	Numeric value out of range	<p>Operation argument is SQL_UPDATE, and the assignment of a numeric value to a column in the result set causes the truncation of whole part of the number.</p> <p>Operation argument is SQL_REFRESH, and returning the numeric value for one or more bound column causes the loss of significant digits.</p>
22007	Invalid datetime format	<p>Operation argument is SQL_UPDATE, and the assignment of date or timestamp value to a column in the result set causes the year, month, day field to be out of range.</p> <p>Operation argument is SQL_REFRESH, and returning date or timestamp value for one or more bound column causes the year, month, day field to be out of range.</p>
22008	Date/time field overflow	<p>Operation argument is SQL_UPDATE, and the performance of datetime arithmetic on data being sent to a column in the result set causes a datetime field (the year, month, day, hour, minute, or second field) of the result being outside the permissible range of values for the field, or being invalid based on the Gregorian calendar's natural rules for datetimes.</p> <p>Operation argument is SQL_REFRESH, and the performance of datetime arithmetic on data being retrieved from the result set causes a datetime field (the year, month, day, hour, minute, or second field) of the result being outside the permissible range of values for the field, or being invalid based on the Gregorian calendar's natural rules for datetimes.</p>
22015	Interval field overflow	<p>The Operation argument is SQL_UPDATE, and assigning an exact numeric or interval C type to an interval SQL data type causes a loss of significant digits.</p> <p>The Operation argument is SQL_UPDATE, and when assigning to an interval SQL type, representation of the value of the C type does not exist in the interval SQL type.</p> <p>The Operation argument is SQL_REFRESH, and assigning from an exact nu</p>

SQLSTATE	Error	Description
		<p>meric or interval SQL type to an interval C type causes a loss of significant digits in the leading field.</p> <p>The Operation argument is SQL_REFRESH, and when assigning to an interval C type, representation of the value of the SQL type does not exist in the interval C type.</p>
22018	Invalid character value for cast specification	<p>Operation argument is SQL_REFRESH, and C type is the exact or approximate numeric, datetime or interval data types. The SQL type of the column is a character data type. And the column value is not a valid character for the bound C type.</p> <p>Operation argument is SQL_UPDATE, and the SQL type is the exact or approximate numeric, datetime or interval data type. The C type of the column is SQL_C_CHAR. And the column value is not a valid character for the bound SQL type.</p>
23000	Integrity constraint violation	Operation argument is SQL_DELETE or SQL_UPDATE, and it violates the integrity constraints.
24000	Invalid cursor state	<p>StatementHandle is in the executed state but the result is not related to StatementHandle.</p> <p>The cursor is open to StatementHandle, but SQLFetch or SQLFetchScroll is not called.</p> <p>The cursor is open to StatementHandle and SQLFetch or SQLFetchScroll is called. But the cursor is positioned before the starting point of the result set or after the end of the result set.</p> <p>Operation argument is SQL_DELETE, SQL_REFRESH or SQL_UPDATE.</p>
40001	Serialization failure	The transaction is rolled back due to a resource deadlock with another transactions.
40003	Statement completion unknown	The connection is failed during the function execution, and the status of transaction can not be determined.
42000	Syntax error or access violation	<p>The driver can not lock the rows as needed to implement the operation requested in the operation argument.</p> <p>The driver can not lock the rows as requested in the LockType argument.</p>
44000	WITH CHECK OPTION violation	Operation argument is SQL_UPDATE, and update on a viewed table or the table derived from the viewed table which was created by specifying WITH_CHECK_OPTION is performed to prevent the existence of one or more rows affected by the update in the viewed table.
HY000	General error	It is an error without specific SQLSTATE, and the error message returned by SQLGetDiagRec in *MessageText buffer describes error message and its cause.

SQLSTATE	Error	Description
HY001	Memory allocation error	The driver can not allocate the memory required for execution or completion of the function.
HY008	Operation cancelled	<p>The asynchronous processing is activated for StatementHandle. SQLCancel or SQLCancelHandle is called on StatementHandle before the function is called and completed, and the function is called again on StatementHandle.</p> <p>The function is called, and before it completed execution, SQLCancel or SQLCancelHandle is called on the StatementHandle from a different thread in a multithread application.</p>
HY010	Function sequence error	<p>The asynchronously executing function is called for the StatementHandle when SQLSetPos was executed, and this function is still being executed when SQLSetPos is called.</p> <p>SQLExecute, SQLExecDirect or SQLMoreResults is called for StatementHandle, and SQL_PARAM_DATA_AVAILABLE is returned, and the function is called before the data was retrieved from the streamed parameters.</p> <p>The asynchronously executing function is called for the StatementHandle, and this function is still being executed when this function is called.</p> <p>SQLExecute, SQLExecDirect or SQLMoreResults is executed in StatementHandle, and SQL_NEED_DATA is returned, and the function is executed before all data is sent.</p> <p>The driver is ODBC 2.x, and SQLSetPos is called in StatementHandle after SQLFetch is called.</p>
HY011	Attribute cannot be set now	The driver version is ODBC 2.x, SQL_ATTR_ROW_STATUS_PTR statement attribute is set, and SQLSetPos is called before SQLFetch, SQLFetchScroll or SQLExtendedFetch is called at the time.
HY013	Memory management error	The function is not executed because the underlying memory object can not be accessed because of the low memory condition.
HY090	Invalid string or buffer length	Operation argument is SQL_UPDATE.
HY092	Invalid attribute identifier	<p>The value which is specified in Operation argument is not valid.</p> <p>The value which is specified in LockType argument is not valid.</p> <p>Operation argument is SQL_UPDATE or SQL_DELETE, and SQL_ATTR_CONCURRENCY statement attribute is SQL_ATTR_CONCUR_READ_ONLY.</p>
HY107	Row value out of range	The value which is specified in RowNumber argument is bigger than the number of rows in the row set.
		The cursor can not be positioned in the row set because the cursor which is

SQLSTATE	Error	Description
HY109	Invalid cursor position	<p>related to StatementHandle is set to forward-only. For more information, refer to the description of SQL_ATTR_CURSOR_TYPE attribute of SQLSetStmtAttr.</p> <p>Operation argument is SQL_UPDATE, SQL_DELETE or SQL_REFRESH, and the row which is identified by RowNumber argument is deleted or returned.</p> <p>RowNumber argument is 0, and operation argument is SQL_POSITION.</p> <p>SQLSetPos is called after SQLBulkOperations is called and before SQLFetchScroll or SQLFetch is called.</p>
HY117	Connection is suspended due to unknown transaction state. Only disconnect and read-only functions are allowed.	For more information about the suspended state, refer to SQLEndTran .
HYC00	Optional feature not implemented	The driver or data source does not support the operation requested in operation argument or LockType argument.
HYT00	Timeout expired	The query timeout period is expired before returning the entire result set from the data source. The timeout can be set via SQL_ATTR_QUERY_TIMEOUT of SQLSetStmtAttr.
HYT01	Connection timeout expired	The connection is expired before the data source responds to the request. The timeout can be set via SQL_ATTR_CONNECTION_TIMEOUT of SQLSetStmtAttr.
IM001	Driver does not support this function	The driver which is related to StatementHandle does not support the function.
IM017	Polling is disabled in asynchronous notification mode	Whenever using the notification model, polling can not be used.
IM018	SQLCompleteAsync has not been called to complete the previous asynchronous operation on this handle.	If the previous function call for the handle returns SQL_STILL_EXECUTING and if the notification mode is activated, SQLCompleteAsync should be called for the handle to do post processing and complete the operation.

Description

RowNumber Argument

RowNumber argument specifies the number of rows in the row set affected by the operation implementation specified in Operation argument. If RowNumber is 0, it is applied to all rows in the row set. RowNumber should be from 0 up to the number of rows in the row set.

The array is 0-based 0 in C language but the RowNumber is 1-based. For example, when updating the fifth row in the row set, the application updates the row set buffer of the array index 4, but RowNumber specifies to 5.

All operations position the cursor on the row specified by RowNumber. The following operation requires the cursor position.

- Positioned update or delete statements
- Calling SQLGetData
- Calling SQLSetPos with the SQL_DELETE, SQL_REFRESH or SQL_UPDATE option

Operation Argument

Operation argument supports the following operations. The application calls SQLGetInfo with the information type of SQL_DYNAMIC_CURSOR_ATTRIBUTES1, SQL_FORWARD_ONLY_CURSOR_ATTRIBUTES1, SQL_KEYSET_CURSOR_ATTRIBUTES1 or SQL_STATIC_CURSOR_ATTRIBUTES1 (depending on the cursor type.) to verify the options supported by the data source.

Operation argument	Operation
SQL_POSITION	The driver positions the cursor at the row specified in RowNumber. The content of row status array which is pointed by SQL_ATTR_ROW_OPERATION_PTR statement attribute is ignored by SQL_POSITION.
SQL_REFRESH	It is not supported by the driver.
SQL_UPDATE	It is not supported by the driver.
SQL_DELETE	It is not supported by the driver.

LockType Argument

LockType argument provides the method for the application to control the concurrency. In most case, the data source which provides the concurrency level and transaction supports SQL_BLOCK_NO_CHANGE value to LockType argument.

LockType argument specifies the lock state of rows after executing SQLSetPos. If the driver can not lock the row either to perform the requested operation or to satisfy the LockType argument, it returns SQL_ERROR and SQLSTATE 42000(Syntax error or access violation).

Although LockType argument is specified in a statement, it is applied to all statements of the same privileges on the connection. The special lock which is acquired by a statements on the connection can be unlocked by another statement on the same connection.

A row locked through SQLSetPos remains locked until the application calls SQLSetPos for the row with LockType set to SQL_LOCK_UNLOCK, or until the application calls SQLFreeHandle for the statement or SQLFreeStmt with the SQL_CLOSE option. When the driver supports the transaction, the row lock through SQLSetPos is unlocked when the application commits or rolls back the transaction on the connection by calling SQLEndTran. (If the cursor is closed when a transaction is committed or rolled back as indicated by the of SQL_CURSOR_COMMIT_BEHAVIOR and SQL_CURSOR_ROLLBACK_BEHAVIOR information types returned by SQLGetInfo.)

LockType argument supports the following lock types. The application calls SQLGetInfo with the SQL_DYNAMIC_CURSOR_ATTRIBUTES1, SQL_FORWARD_ONLY_CURSOR_ATTRIBUTES1, SQL_KEYSET_CURSOR_ATTRIBUTES1 or SQL_STATIC_CURSOR_ATTRIBUTES1 information type to verify the lock supported by the data source.

LockType argument	Lock type
SQL_LOCK_NO_CHANGE	The driver or data source ensures the locking or unlocking of the same row as it was before SQLSetPos is called. The value of LockType does not allow explicit row-level locking so that any lock required by the current concurrency and transaction isolation levels can be used.
SQL_LOCK_EXCLUSIVE	The driver or data source performs the exclusive lock on a row. The statement on other connection or in other application can not be used to acquire any locks on the row.
SQL_LOCK_UNLOCK	The driver or data source releases the lock.

When the update and delete operations are performed in SQLSetPos, the application uses the following LockType argument.

- An application calls SQLSetPos with operation set to SQL_REFRESH, and LockType set to SQL_LOCK_EXCLUSIVE to guarantee that the row is not updated after it is retrieved.
- If the application sets LockType to SQL_LOCK_NO_CHANGE, the driver guarantees the update or delete operation only when the application specifies SQL_CONCUR_LOCK for SQL_ATTR_CONCURRENCY statement attribute.
- If the application specifies SQL_CONCUR_ROWVER or SQL_CONCUR_VALUES for SQL_ATTR_CONCURRENCY statement attribute, the driver compares the version or value of the row and denies the operation when the row is changes since the application fetched the row.
- If the application specifies SQL_CONCUR_READ_ONLY for SQL_ATTR_CONCURRENCY statement attribute, the driver denies any update or delete operation.

For more information about SQL_ATTR_CONCURRENCY statement attribute, refer to [SQLSetStmtAttr](#).

Status and Operation Array

The following status and operation arrays are used when `SQLSetPos` is called.

- The row status array includes the status value of each row data in the row set. The driver sets the status value in the array after calling `SQLFetch`, `SQLFetchScroll`, `SQLBulkOperations` or `SQLSetPos`. The array is pointed to by `SQL_ATTR_ROW_STATUS_PTR` statement attribute.
- The row operation array includes each row value in the row set which indicates whether `SQLSetPos` call for the bulk operation is ignored or performed. Each element in the array sets one of `SQL_ROW_PROCEED` or `SQL_ROW_IGNORE`. The array is pointed to by `SQL_ATTR_ROW_OPERATION_PTR` statement attribute.

The number of elements in the status and operation array should be equal to the number of rows in the row set (as defined by the `SQL_ATTR_ROW_ARRAY_SIZE` statement attribute).

For more information about the row status array, refer to [SQLFetch](#).

For more information about the row operation array, refer to [Ignoring Rows in the Bulk Operation](#).

Using SQLSetPos

The application should perform the following steps before using `SQLSetPos`.

1. If the application calls `SQLSetPos` with operation set to `SQL_UPDATE`, call `SQLBindCol` (or `SQLSetDescRec`) for each column to specify its data type and bind buffers for the column's data and length.
2. If the application calls `SQLSetPos` with operation set to `SQL_DELETE` or `SQL_UPDATE`, call `SQLColAttribute` to make sure that the columns to be deleted or updated are updatable.
3. The result set is generated by calling `SQLExecDirect`, `SQLExecute` or the catalog function.
4. The data is retrieved by calling `SQLFetch` or `SQLFetchScroll`.

Deleting Data Using SQLSetPos

An application calls `SQLSetPos` with `RowNumber` set to the number of the row to delete and calls operation set to `SQL_DELETE`, to delete data by using `SQLSetPos`.

After the data is deleted, the driver changes the value in the implementation row status array for the appropriate row to `SQL_ROW_DELETED` (or `SQL_ROW_ERROR`).

Updating Data Using SQLSetPos

The application can pass the data to the column through one of the bound buffer or once or more `SQLPutData` calls. Columns whose data is passed with `SQLPutData` are known as data-at-execution columns. Usually it may be used to transfer data to `SQL_LONGVARBINARY` and `SQL_LONGVARCHAR` and it can be mixed with other columns.

Updating Data Using SQLSetPos in Application

1. Place value in the data and length/indicator buffer bound with SQLBindCol.
 - For general columns, the application positions the new column value in *TargetValuePtr buffer and the value length in *StrLen_or_IndPtr buffer. If the row should not be updated, the application positions SQL_ROW_IGNORE in the row element in the row operation array.
 - For data-at-execution columns, the application positions an application-defined value, such as the column number, in the *TargetValuePtr buffer. The value can be used later to identify the column. The application positions the macro result of SQL_LEN_DATA_AT_EXEC(length) in *StrLen_or_IndPtr buffer. If the SQL data type of the column is SQL_LONGVARIABLE, SQL_LONGVARIABLE_CHAR or the source-defined long data type and the driver returns Y to SQL_NEED_LONG_DATA information type of SQLGetInfo, length is the number of bytes to be sent to the parameter. Otherwise, it is not a negative and it should be ignored.
2. Call SQLSetPos with the operation argument set to SQL_UPDATE to update the row of data.
 - If data-at-execution columns do not exist, the processing is completed.
 - If data-at-execution columns exist, the function returns SQL_NEED_DATA and proceeds the step 3.
3. Call SQLParamData to retrieve the address of *TargetValuePtr buffer for the first data-at-execution column to be processed. SQLParamData returns SQL_NEED_DATA. The application retrieves the application-defined value in *TargetValuePtr buffer.



- Though data-at-execution parameter is similar to the data-at-execution column, but each value which is returned by SQLParamData is different.
- Data-at-execution parameters are parameters in an SQL statement for which data will be sent with SQLPutData when the statement is executed with SQLExecDirect or SQLExecute. They are bound to SQLBindParameter or SQLSetDescRec by setting the descriptors. The value which is returned by SQLParamData is the 32 bits value and it is sent to SQLBindParameter of ParameterValuePtr argument.
- Data-at-execution columns are columns in a row set for which data will be sent with SQLPutData when a row is updated with SQLSetPos. They are bound with SQLBindCol. The value returned by SQLParamData is the address of the row in the *TargetValuePtr buffer which is being processed.

4. Call SQLPutData once or more times to transfer data to the column. If all data values can not be returned in *TargetValuePtr buffer specified in SQLPutData, multiple calls are needed. Only when the character data of C language is sent to the column with a character, binary or a data source data type, or when the binary data of C language is sent to to the column with a character, binary or a data so

urce data type, then multiple calls of SQLPutData are allowed for the same column.

5. Call SQLParamData again to indicate all data are sent to the column.
 - If more data-at-execution columns exist, then SQLParamData returns SQL_NEED_DATA and the address of the TargetValuePtr buffer for the next data-at-execution column to be processed. The application repeats the steps 4 and 5.
 - If data-at-execution columns do not exist any more, then the processing is completed. If the statement is successfully executed, SQLParamData returns SQL_SUCCESS or SQL_SUCCESS_WITH_INFO. If execution is failed, SQL_ERROR is returned. At this point, SQLParamData returns any SQLSTATE which can be returned by SQLSetPos.

If the data is updated, the driver changes the value in the implementation row status array for the appropriate row to SQL_ROW_UPDATED.

If the operation is canceled or an error occurs in SQLParamData or SQLPutData, after SQLSetPos returns SQL_NEED_DATA and before data is transferred for all data-at-execution columns, the application can call only SQLCancel, SQLGetDiagField, SQLGetDiagRec, SQLGetFunctions, SQLParamData, or SQLPutData for the statement or the connection related to the statement. At this point, if another function is called, SQL_ERROR and SQLSTATE HY010 (Function sequence error) are returned.

If the application calls SQLCancel while the driver still needs the data of data-at-execution columns, the driver cancels the operation. The application can call SQLSetPos again later. Cancellation does not affect the cursor state or the current cursor position.

When SELECT-list of the query specification related to the cursor includes one or more references in the same column, the driver defines whether an error occurs or the driver ignores the duplicated reference and implements the requested operation.

Executing the Bulk Operation

If the RowNumber argument is 0, the driver performs the operation specified in the operation argument for every row in the rowset which has a value of SQL_ROW_PROCEED in its field in the row operation array pointed to by SQL_ATTR_ROW_OPERATION_PTR statement attribute. This is a valid value of the RowNumber argument for an operation argument of SQL_DELETE, SQL_REFRESH, or SQL_UPDATE, but not SQL_POSITION. SQLSetPos with an operation of SQL_POSITION and a RowNumber equal to 0 will return SQLSTATE HY109 (Invalid cursor position).

If an error occurs in the entire row set, such as SQLSTATE HYT00 (Timeout expired), the driver returns SQL_ERROR and the appropriate SQLSTATE. The contents of the row set buffers are undefined, and the cursor position is unchanged.

If an error occurs in a single row, the driver performs the followings.

- It sets the row element in the row status array pointed by SQL_ATTR_ROW_STATUS_PTR statement a

tribute to SQL_ROW_ERROR.

- It adds one or more SQLSTATE to an error in the error queue, and sets SQL_DIAG_ROW_NUMBER field of the diagnostic data structure.

If the driver completes the remaining row operation in the row set after an error or warning is processed, SQL_SUCCESS_WITH_INFO is returned. Therefore, the error queue includes zero or more SQLSTATE for the rows which return the errors. The driver stops the operation after processing an error or warning and returns SQL_ERROR.

If the driver returns a warning such as SQLSTATE 01004 (Data truncated), then the driver returns a warning applied to the entire row set or unknown rows in the row set before returning the error information which is applied to a specific row. It returns warnings for specific rows together with other error information about those rows.

If RowNumber is 0 and operation is SQL_UPDATE, SQL_REFRESH or SQL_DELETE, then the number of rows on which SQLSetPos operates is set by SQL_ATTR_ROWS_FETCHED_PTR statement attribute.

If RowNumber is 0 and the operation is SQL_DELETE, SQL_REFRESH or SQL_UPDATE, then the current row after the operation is as same as the row before the operation.

Ignoring Rows in the Bulk Operation

The row operation array can be used to specify the row which should be ignored in the current row set during the bulk operation with SQLSetPos. The application should perform the following steps to make the driver ignore one or more rows in the driver during the bulk operation.

1. It calls SQLSetStmtAttr to set the SQL_ATTR_ROW_OPERATION_PTR statement attribute to point to an array of SQLUSMALLINTs. This field can also be set by calling SQLSetDescField to set the SQL_DESC_ARRAY_STATUS_PTR header field of the ARD, which requires that an application obtains the descriptor handle.
2. It sets each element in the row operation array to one of the following values.
 - Setting to SQL_ROW_IGNORE it indicates that the row is excluded in the bulk operation.
 - Setting to SQL_ROW_PROCEED it indicates that the row is included in the bulk operation.
3. It performs the bulk operation by calling SQLSetPos.

The following rules are applied to the row operation array.

- SQL_ROW_IGNORE and SQL_ROW_PROCEED affect only bulk operations using SQLSetPos with an operation of SQL_DELETE or SQL_UPDATE. They do not affect calling SQLSetPos with an operation of SQL_REFRESH or SQL_POSITION.
- The pointer is set to NULL by default.
- If the pointer is NULL, then all rows are updated like as all elements are set to SQL_ROW_PROCEED.
- Setting the element to SQL_ROW_PROCEED does not guarantee occurrence of the operation in a par

ticular row. If a certain row in the row set has the `SQL_ROW_ERROR` status, the driver can not update that row regardless of whether the application specified `SQL_ROW_PROCEED`. The application should always check the row status array to see whether the operation was successful.

- `SQL_ROW_PROCEED` is defined as 0 in the header file. The application can initialize the row operation array to 0 to process all rows.
- If the n-th element of the row status array is set to `SQL_ROW_IGNORE` and the bulk update or delete operation is executed by calling `SQLSetPos`, the n-th row in the row set remains unchanged after calling `SQLSetPos`.
- The application should automatically set a read-only column to `SQL_ROW_IGNORE`.

Ignoring Columns in the Bulk Operation

The application can set the value in the bound length/indicator buffer to `SQL_COLUMN_IGNORE` so that it can avoid unnecessary processing diagnostics caused by attempting to update one or more read-only columns. For more information, refer to [SQLBindCol](#).

SQLSetScrollOptions

Conformance

Introduced version: ODBC 1.0

Standards compliance: It is not available.

Overview

SQLSetScrollOptions function in ODBC 2.0 is replaced with calling SQLGetInfo and SQLSetStmtAttr in ODBC 3.x.



When the driver manager maps SQLSetScrollOptions for the application which operates with ODBC 3.x driver which does not support SqlSetScrollOptions, the driver manager sets SQL_ROW_SET_SIZE statement option, not the SQL_ATTR_ROW_ARRAY_SIZE statement attribute in Rows etSize argument of SQLSetScrollOptins. As a result, SQLSetScrollOptions can not be used by an application when fetching multiple rows by calling SQLFetch or SQLFetchScroll, and it can be used only when fetching multiple rows by calling SQLExtendedFetch.

SQLSetStmtAttr

Conformance

Introduced version: ODBC 3.0

Standards compliance: ISO 92

Overview

SQLSetStmtAttr sets the attributes related to the statements.

Syntax

```
SQLRETURN SQLSetStmtAttr(  
    SQLHSTMT      StatementHandle,  
    SQLINTEGER    Attribute,  
    SQLPOINTER    ValuePtr,  
    SQLINTEGER    StringLength);
```

Arguments

StatementHandle

[Input] It is the statement handle.

Attribute

[Input] It is the option to be set. For more information, refer to the **Description** section.

ValuePtr

[Input] It is the value which is related to the attribute. ValuePtr can be one of the followings according to the attribute value.

- ODBC descriptor handle
- SQLINTEGER value
- SQLULEN value
- One of the following pointers
 - Null-termination character string
 - Binary buffer
 - SQLLEN, SQLULEN, SQLUSMALLINT values or the array of values
 - Driver-defined value

If Attribute argument is the driver-specific value, ValuePtr may be an integer.

StringLength

[Input] If an attribute is an ODBC-defined attribute and ValuePtr points to a string or binary buffer, the argument is the length of *ValuePtr. If Attribute is a driver-defined attribute and ValuePtr is an integer, the argument is ignored. StringLength may have one of the following values.

If Attribute is a driver-defined attribute, the application indicates the nature of the attribute to the driver manager by setting StringLength argument.

- If ValuePtr is a string pointer, Stringlength is the string length or SQL_NTS.
- If ValuePtr is a binary buffer, the application stores SQL_LEN_BINARY_ATTR (length) macro result in StringLength. StringLength has a negative value.
- If ValuePtr is a pointer of a different value other than a string or a binary buffer, StringLength must have SQL_IS_POINTER value.
- If ValuePtr includes a fixed length value, StringLength is SQL_IS_INTEGER or SQL_IS_UIINTEGER.

Returns

SQL_SUCCESS, SQL_SUCCESS_WITH_INFO, SQL_ERROR, SQL_INVALID_HANDLE

Diagnosis

SQLSTATE	Error	Description
01000	General warning	It is the driver-specific informational message. (The function returns SQL_SUCCESS_WITH_INFO.)
01S02	Option value changed	It is temporarily replaced with a similar value because the driver does not support the value specified in ValuePtr or the value specified in ValuePtr is invalid due to the implementation working conditions. (SQLGetStmtAttr can be called to see which value is temporarily replaced.) The replaced value is valid for the StatementHandle until the cursor is closed, and it is changed to the previous value when the cursor is closed. The statement attributes which can be changed are as follows. SQL_ATTR_CONCURRENCY, SQL_ATTR_CURSOR_TYPE, SQL_ATTR_KEYSET_SIZE, SQL_ATTR_MAX_LENGTH, SQL_ATTR_MAX_ROWS, SQL_ATTR_QUERY_TIMEOUT, SQL_ATTR_ROW_ARRAY_SIZE, SQL_ATTR_SIMULATE_CURSOR. (The function returns SQL_SUCCESS_WITH_INFO.)
08S01	Communication link failure	Before the function processing is completed, the connection between the driver and the data source is failed.
24000	Invalid cursor state	Attribute is SQL_ATTR_CONCURRENCY, SQL_ATTR_CURSOR_TYPE, SQL_ATTR_SIMULATE_CURSOR or SQL_ATTR_USE_BOOKMARKS, and the cursor is open.

SQLSTATE	Error	Description
HY000	General error	It is an error without specific SQLSTATE, and the error message returned by SQLGetDiagRec in *MessageText buffer describes error message and its cause.
HY001	Memory allocation error	The driver can not allocate the memory required for execution or completion of the function.
HY009	Invalid use of null pointer	The statement attribute which is identified by Attribute argument requires the string attribute, and ValuePtr argument is a NULL pointer.
HY010	Function sequence error	<p>The asynchronously executing function is called for the connection handle related to StatementHandle, and this function is still being executed when SQLSetStmtAttr is called.</p> <p>SQLExecute, SQLExecDirect or SQLMoreResults are called for StatementHandle, and SQL_PARAM_DATA_AVAILABLE is returned. This function is called before the data is returned for the streamed parameters.</p> <p>The asynchronously executing function is called for StatementHandle, and is still being executed when the function is called.</p> <p>SQLExecute, SQLExecDirect, SQLBulkOperation or SQLSetPos are called for StatementHandle, and SQL_NEED_DATA is returned. This function is called before data is sent for all data-at-execution parameters or columns.</p>
HY011	Attribute cannot be set now	Attribute is SQL_ATTR_CONCURRENCY, SQL_ATTR_CURSOR_TYPE, SQL_ATTR_SIMULATE_CURSOR or SQL_ATTR_USE_BOOKMARKS, and the statement is prepared.
HY013	Memory management error	The function is not executed because the underlying memory object can not be accessed because of the low memory condition.
HY017	Invalid use of an automatically allocated descriptor handle	<p>Attribute argument is SQL_ATTR_IMP_ROW_DESC or SQL_ATTR_IMP_PARAM_DESC.</p> <p>Attribute argument is SQL_ATTR_APP_ROW_DESC or SQL_ATTR_APP_PARAM_DESC, and the value in ValuePtr is an implicitly allocated descriptor handle other than the handle originally allocated for the ARD or APD.</p>
HY024	Invalid attribute value	<p>Considering the specified Attribute value, the value in ValuePtr is invalid. (The driver manager returns this SQLSTATE only for the statement attribute and connection which allows the separate set such as SQL_ATTR_ACCESS_MODE or SQL_ATTR_ASYNC_ENABLE. The driver should verify the value in ValuePtr for other connection and statement attribute.)</p> <p>Attribute argument is SQL_ATTR_APP_ROW_DESC or SQL_ATTR_APP_PARAM_DESC, and ValuePtr is an explicitly allocated descriptor handle which is not on the same connection as the StatementHandle argument.</p>
HY090	Invalid string or buffer length	*ValuePtr is a string and StringLength is smaller than 0. (It is not SQL_NTS.)

SQLSTATE	Error	Description
HY092	Invalid attribute/ option identifier	The value specified for the Attribute argument is invalid for the version of ODBC supported by the driver. The value which is specified in Attribute is the read-only attribute.
HY117	Connection is suspended due to unknown transaction state. Only disconnect and read-only functions are allowed	For more information about the suspended state, refer to SQLEndTran .
HYC00	Optional feature not implemented	The value which is specified in Attribute argument is valid in ODBC version supported by the driver but it is not supported by the driver. Attribute argument is SQL_ATTR_ASYNC_ENABLE. When SQLGetInfo is called in InforType with SQL_ASYNC_MODE, then SQL_AM_CONNECTION is returned. Attribute argument is SQL_ATTR_ENABLE_AUTO_IPD, and the value of SQL_ATTR_AUTO_IPD connection attribute is SQL_FALSE.
HYT01	Connection timeout expired	The connection timeout period is expired before the data source response to the request. The connection timeout period can be set via SQLSetConnectAttr of SQL_ATTR_CONNECTION_TIMEOUT.
IM001	Driver does not support this function	The driver does not support the function.
S1118	Driver does not support asynchronous notification	When calling SQLSetStmtAttr to set SQL_ATTR_ASYNC_STMT_EVENT the driver does not support the asynchronous notification.

Description

The statement attribute is updated by calling SQLSetStmtAttr or it remains effective until the statement is deleted by SQLFreeHandle. Calling SQLFreeStmt with SQL_CLOSE, SQL_UNBIND or SQL_RESET_PARAMS option does not reset the statement attribute.

Some statements attributes is replaces with a similar value if the driver does not support the value specified in ValuePtr. The driver returns SQL_SUCCESS_WITH_INFO and SQLSTATE 01S02 (Option value changed) for these cases. For example, if attribute is SQL_ATTR_CONCURRENCY and ValuePtr is SQL_CONCURRENCE_VALUES and the data source does not support it, the driver replace it with SQL_CONCURRENCE_VALUES and returns SQL_SUCCESS_WITH_INFO. The application calls SQLGetStmtAttr to obtain the replaced value.

The format of information set with ValuePtr depends on the value specified in Attribute. SQLSetStmtAttr

accepts one of attribute information types such as a different character string or integer. Each type is described in the description of the attribute. The type is applied to the information returned for each attribute in `SQLGetStmtAttr`. The length of the character string pointed to by the `ValuePtr` argument of `SQLSetStmtAttr` is `StringLength`.



- The feature whose statement attribute is set at the connection level by calling `SQLSetConnectAttr` may disappear in ODBC 3.x. The ODBC 3.x application should not set the statement attribute at the connection level. The ODBC 3.x statement attribute can not be set at the connection level except for `SQL_ATTR_METADATA_ID`, and `SQL_ATTR_ASYNC_ENABLE` attribute is both the connection attribute and the statement attribute, and it can be set at the connection level and the statement level.
- ODBC 3.x driver requires the option feature which sets the driver version to ODBC 2.x at the connection level if the driver should operate with the ODBC 2.x application.

Statement Attribute to Set the Descriptor Field

Many statement attributes correspond to the header fields of the descriptor. Setting these attributes is the same result with setting the descriptor fields. Setting fields by calling `SQLSetStmtAttr` rather than calling `SQLSetDescField` has the advantage that a descriptor handle does not have to be obtained for the function call.



Calling `SQLSetStmtAttr` in a single statement may affect other statements. It happens when APD or ARD is explicitly assigned to the statement and it is related to other statements. `SQLSetStmtAttr` is applied to all statements related to this descriptor because it modifies APD or ARD. If it is not required operation, the application should separate this descriptor with other statements (by calling `SQLSetStmtAttr` to set the `SQL_ATTR_APP_ROW_DESC` or `SQL_ATTR_APP_PARAM_DESC` field to a different descriptor handle) before calling `SQLSetStmtAttr` again.

When the descriptor field is set as a result of the corresponding statement attribute being set, the field is set only for the applicable descriptors which are currently related to the statement identified by the `StatementHandle` argument, and the attribute setting does not affect any descriptor of the related statement in the future. When the descriptor field which is related to the statement handle is set to `SQLSetDescField`, the corresponding statement attribute is also set. If an explicitly allocated descriptor is dissociated from a statement, a statement attribute which corresponds to a header field will revert to the value of the field in the implicitly allocated descriptor.

When the statement is allocated, four descriptor handles are automatically allocated and is related to the statement. Explicitly allocated descriptor handles can be associated with the statement by calling `SQLAllocHandle` with an `HandleType` of `SQL_HANDLE_DESC` to allocate a descriptor handle and then calling `SQLS`

etStmtAttr to associate the descriptor handle with the statement.

The following is the statement attributes corresponding to the descriptor header field.

Statement attribute	Header field	Description
SQL_ATTR_PARAM_BIND_OFFSET_PTR	SQL_DESC_BIND_OFFSET_PTR	APD
SQL_ATTR_PARAM_BIND_TYPE	SQL_DESC_BIND_TYPE	APD
SQL_ATTR_PARAM_OPERATION_PTR	SQL_DESC_ARRAY_STATUS_PTR	APD
SQL_ATTR_PARAM_STATUS_PTR	SQL_DESC_ARRAY_STATUS_PTR	IPD
SQL_ATTR_PARAMS_PROCESSED_PTR	SQL_DESC_ROWS_PROCESSED_PTR	IPD
SQL_ATTR_PARAMSET_SIZE	SQL_DESC_ARRAY_SIZE	APD
SQL_ATTR_ROW_ARRAY_SIZE	SQL_DESC_ARRAY_SIZE	ARD
SQL_ATTR_ROW_BIND_OFFSET_PTR	SQL_DESC_BIND_OFFSET_PTR	ARD
SQL_ATTR_ROW_BIND_TYPE	SQL_DESC_BIND_TYPE	ARD
SQL_ATTR_ROW_OPERATION_PTR	SQL_DESC_ARRAY_STATUS_PTR	ARD
SQL_ATTR_ROW_STATUS_PTR	SQL_DESC_ARRAY_STATUS_PTR	IRD
SQL_ATTR_ROWS_FETCHED_PTR	SQL_DESC_ROWS_PROCESSED_PTR	IRD

Statement Attributes

The following table describes currently defined attributes and the version of ODBC in which they were introduced.

Attribute	ValuePtr contents
SQL_ATTR_APP_PARAM_DESC (ODBC 3.0)	It is not supported by the driver.
SQL_ATTR_APP_ROW_DESC (ODBC 3.0)	It is not supported by the driver.
SQL_ATTR_ASYNC_ENABLE (ODBC 1.0)	It is not supported by the driver.
SQL_ATTR_ASYNC_STMT_EVENT (ODBC 3.8)	It is not supported by the driver.
SQL_ATTR_ASYNC_STMT_PCALLBACK (ODBC3.8)	It is not supported by the driver.
SQL_ATTR_ASYNC_STMT_PCONTEXT (ODBC 3.8)	It is not supported by the driver.
SQL_ATTR_ATOMIC_EXEC	SQLUSMALLINT: It is whether an atomic insert operation is operable.

Attribute	ValuePtr contents
UTION	<ul style="list-style-type: none"> • SQL_ATOMIC_EXECUTION_OFF • SQL_ATOMIC_EXECUTION_ON
SQL_ATTR_CONCURRENC Y (ODBC 2.0)	<p>The default value of SQL_ATTR_CONCURRENCY is SQL_CONCUR_READ_ONLY.</p> <ul style="list-style-type: none"> • SQLULEN: It is the value which specifies the cursor concurrency. <ul style="list-style-type: none"> ◦ SQL_CONCUR_READ_ONLY: The cursor is read-only and the update is not allowed. ◦ SQL_CONCUR_LOCK: The cursor uses the minimum level locking enough to completely update the row. ◦ SQL_CONCUR_ROWVER: The cursor uses the concurrency to control and compare the row version, such as SQLBase ROWID or Sybase TIMESTAMP. ◦ SQL_CONCUR_VALUES: The cursor uses the concurrency to control and compare the values. <p>If SQL_ATTR_CURSOR_TYPE attribute is changed to the value which is not supported in SQL_ATTR_CONCURRENCY, the value of SQL_ATTR_CONCURRENCY may be changed at the execution time and a warning may occur when SQLExecDirect or SQLPrepare is called.</p> <p>While the driver supports SELECT FOR UPDATE statement and the statement is executed, an error occurs if SQL_ATTR_CONCURRENCY is changed to SQL_CONCUR_READ_ONLY. If SQL_ATTR_CONCURRENCY value is changed to SQL_ATTR_CURSOR_TYPE value which is supported by the driver, or to the value not supported by the driver, SQL_ATTR_CURSOR_TYPE value is changed at the execution time, and SQLSTATE 01S02 (Option value changed) may be returned when SQLExecDirect or SQLPrepare is executed.</p> <p>If the specified concurrency is not supported by the data source, the driver replaces it with other concurrency and returns SQLSTATE 01S02 (Option value changed). The driver replaces SQL_CONCUR_VALUES with SQL_CONCUR_ROWVER, or reverse. Also, SQL_CONCUR_LOCK is replaced with SQL_CONCUR_ROWVER, SQL_CONCUR_VALUES order. The validity of the replaced value is not confirmed until the execution time.</p>
SQL_ATTR_CURSOR_SCROLLABLE (ODBC 3.0)	<ul style="list-style-type: none"> • SQLULEN: It is the value specifying the required support level of the application. Setting the attribute affects the next SQLExecDirect and SQLExecute. <ul style="list-style-type: none"> ◦ SQL_NONSCROLLABLE: It is the default value. The scroll cursor is not required to the statement handle. If the application calls SQLFetchScroll to the handle, the only valid value of FetchOrientation is SQL_FETCH_NEXT. ◦ SQL_SCROLLABLE: The scroll cursor is required to the statement handle. When SQLFetchScroll is called, the application positions the cursor on the mode except the sequential mode and the valid value of FetchOrientation may be specified.
	<ul style="list-style-type: none"> • SQLULEN: The value which determines whether the cursor of the statement handle can view the change in the result set generated by the other cursor. Setting t

Attribute	ValuePtr contents
SQL_ATTR_CURSOR_SENSITIVITY (ODBC 3.0)	<p>The field affects the next calls of SQLExecDirect and SQLExecute. The application can read again the attribute value to obtain the initial state or its latest state set by the application.</p> <ul style="list-style-type: none"> ◦ SQL_UNSPECIFIED: It is the default value. It is unspecified what the cursor type is and whether cursors on the statement handle make visible the changes made to a result set by another cursor. The cursor of the statement handle can probably view none, some, or all such changes. ◦ SQL_INSENSITIVE: All cursors of the statement handle can view only the result but they can not view any changes made by the other cursor. The insensitive cursor is read-only. It corresponds to a static cursor with a read-only concurrency. ◦ SQL_SENSITIVE: It allows all cursors of the statement handle can view all of the changes in the result set generated by the other cursor.
SQL_ATTR_CURSOR_TYPE (ODBC 2.0)	<ul style="list-style-type: none"> • SQLULEN: It is the value which specifies the cursor type. <ul style="list-style-type: none"> ◦ SQL_CURSOR_FORWARD_ONLY: The cursor can only move forward. ◦ SQL_CURSOR_KEYSET_DRIVEN: The driver stores and uses the keys as many as the number of rows specified in SQL_ATTR_KEYSET_SIZE statement attribute. ◦ SQL_CURSOR_DYNAMIC: The driver stores and uses the key for only the row in the row set. <p>The default value is SQL_CURSOR_FORWARD_ONLY. The attribute can not be specified in the prepared SQL statement.</p> <p>If the specified cursor type is not supported by the data source, the driver replaces it with the other type and returns SQLSTATE 01S02 (Option value changed. The driver replaces the mixed or dynamic cursor with the keyset-driven or static cursor. The driver replaces a keyset-driven cursor with a static cursor.</p>
SQL_ATTR_ENABLE_AUTO_IPD (ODBC 3.0)	It is not supported by the driver.
SQL_ATTR_EXPLAIN_PLAN_OPTION	SQLUSMALLINT: Whether to create the plan information. <ul style="list-style-type: none"> • SQL_EXPLAIN_PLAN_OFF: Plan information is not generated. • SQL_EXPLAIN_PLAN_ON: The SQL statement is performed and plan information is generated. • SQL_EXPLAIN_PLAN_ONLY: The SQL statement is not performed and plan information is generated.
SQL_ATTR_EXPLAIN_PLAN_TEXT	It is the generated plan string. (read-only)
SQL_ATTR_FETCH_BOOKMARK_PTR (ODBC 3.0)	It is not supported by the driver.
SQL_ATTR_FETCH_FAILOV	SQLUSMALLINT: It is whether to use fetch failover.

Attribute	ValuePtr contents
ER	<ul style="list-style-type: none"> SQL_FETCH_FAILOVER_OFF: It does not use fetch failover. SQL_FETCH_FAILOVER_ON: It uses fetch failover.
SQL_ATTR_IMP_PARAM_DESCRIPTOR (ODBC 3.0)	It is not supported by the driver.
SQL_ATTR_IMP_ROW_DESCRIPTOR (ODBC 3.0)	It is not supported by the driver.
SQL_ATTR_KEYSET_SIZE (ODBC 2.0)	It is not supported by the driver.
SQL_ATTR_MAX_LENGTH (ODBC 1.0)	It is not supported by the driver.
SQL_ATTR_MAX_ROWS (ODBC 1.0)	<ul style="list-style-type: none"> SQLULEN: It is the value corresponding to the maximum number of rows returned by SELECT statement. If *ValuePtr is equal to 0, the driver returns all rows. <p>The purpose of this attribute is to reduce the network traffic. Notionally, it is applied when the result set is generated, and it limits the result set of the first ValuePtr rows. If the number of rows in the result set are bigger than ValuePtr, the result set is reduced.</p> <p>SQL_ATTR_MAX_ROWS is applied to all result set of the statement including those which are returned by the catalog functions. SQL_ATTR_MAX_ROWS sets the maximum number of cursor rows.</p> <p>If it is not sure if the SQL_ATTR_MAX_ROWS is to be properly implemented (If the limit of the result set size can not be implemented in the data source), the driver should not emulate the SQL_ATTR_MAX_ROWS operation for SQLFetch or SQLFetchScroll.</p> <p>The driver defines whether SQL_ATTR_MAX_ROWS is applied to the statements except for SELECT statement (such as the catalog functions).</p> <p>The attribute value is set on the cursor which is open. But it would not be immediately effective. In this case, the driver returns SQLSTATE 01S02 (Option value changed) and sets the attribute to its original value.</p>
SQL_ATTR_METADATA_ID	<ul style="list-style-type: none"> SQLULEN: It is the value which specifies the way to process the string arguments of the catalog functions. <p>If it is SQL_TRUE, catalog functions treat a string argument as an identifier. It is not case-sensitive. The driver removes the trailing spaces of the string whose range is not determined and converts them to uppercase. The driver removes the leading and trailing spaces of the strings whose range is determined and takes the string literally between delimiters. If one of the argument is set to a NULL pointer, the function returns SQL_ERROR and SQLSTATE HY009. (Invalid use of null pointer).</p>

Attribute	ValuePtr contents
(ODBC 3.0)	<p>If it is SQL_FALSE, catalog functions does not treat a string argument as an identifier. It is case-sensitive. They can either include a string search pattern or not, depending on the argument.</p> <p>The default value is SQL_FALSE.</p> <p>It is the TableType argument of SQLTables which takes a list of values, is not affected by this attribute.</p> <p>SQL_ATTR_METADATA_ID can be set in the connection level. (SQL_ATTR_METADATA_ID and SQL_ATTR_ASYNC_ENABLE are unique, and they are the statement attributes and at the same time they are the connection attributes.)</p> <p>For more information, refer to Arguments of Catalog Function.</p>
SQL_ATTR_NOSCAN (ODBC 1.0)	<p>It is not supported by the driver.</p>
SQL_ATTR_PARAM_BIND_OFFSET_PTR (ODBC 3.0)	<ul style="list-style-type: none"> SQLULEN*: It is the value which indicates the offset added to a pointer to change the binding of the dynamic parameters. If the field is not NULL, the driver dereferences the pointer and adds the dereferenced value to each of the deferred fields in the descriptor record (SQL_DESC_DATA_PTR, SQL_DESC_INDICATOR_PTR, and SQL_DESC_OCTET_LENGTH_PTR), and it uses a new pointer value when binding. The default value is set to NULL. <p>The bind offset is always directly added to SQL_DESC_DATA_PTR, SQL_DESC_INDICATOR_PTR, SQL_DESC_OCTET_LENGTH_PTR fields. If the offset is changed to a different value, the new value is still directly added to the descriptor field value. A new offset is not added to the field value plus previous offsets.</p> <p>Setting this statement attribute sets the SQL_DESC_BIND_OFFSET_PTR field in the APD header.</p>
SQL_ATTR_PARAM_BIND_TYPE (ODBC 3.0)	<ul style="list-style-type: none"> SQLULEN: It represents the binding direction used for the dynamic parameter. <p>The field is set to SQL_PARAM_BIND_BY_COLUMN which is for the column-wise binding. (The default value)</p> <p>To select the row-wise binding, the field is set to the structure length or the buffer instance which is bound to the dynamic parameter set. If the length includes the space for the padding of all the bound parameter and structure or the address of the bound parameter is increased to the specified length, the result should be buffered to point to the beginning of the next parameter. Using sizeof operator of ANSI C guarantees this operation.</p> <p>Setting this statement attribute sets the SQL_DESC_BIND_TYPE field in the APD head</p>

Attribute	ValuePtr contents
SQL_ATTR_PARAM_OPERATION_PTR (ODBC 3.0)	<p>er.</p> <ul style="list-style-type: none"> SQLUSMALLINT*: It is the value which points to an array of SQLUSMALLINT values used to ignore the parameter while executing the SQL statement. Each value is SQL_PARAM_PROCEED (to execute the parameter) or SQL_PARAM_IGNORE (to ignore the parameter). <p>The parameter set can be ignored during the process if it sets the status value of the array pointed by SQL_DESC_ARRAY_STATUS_PTR in APD. The parameter set is processed only if the status value is SQL_PARAM_PROCEED or the the array element is not set.</p> <p>The statement attribute can be set to a NULL pointer. In this case, the driver does not return the parameter status value. The attribute can be set at any time, but a new value is not used until the next SQLExecDirect or SQLExecute is called.</p> <p>If the bound parameter does not exist, the attribute is ignored.</p> <p>Setting this statement attribute sets the SQL_DESC_ARRAY_STATUS_PTR field in the APD header.</p>
SQL_ATTR_PARAM_STATUSES_PTR (ODBC 3.0)	<ul style="list-style-type: none"> SQLUSMALLINT*: It is the value which points to SQLUSMALLINT array value including the status information value of each of the rows of the parameter value after calling SQLExecute or SQLExecDirect. The field is required only when PARAMSET_SIZE is bigger than 1. The status value may include the following values. <ul style="list-style-type: none"> SQL_PARAM_SUCCESS: The SQL statement is successfully executed for the parameter set. SQL_PARAM_SUCCESS_WITH_INFO: The SQL statement is successfully executed for the parameter set, but warning information is in the diagnostic data structure. SQL_PARAM_ERROR: An error occurs when processing the parameter set. Additional error information is in the diagnostic data structure. SQL_PARAM_UNUSED: The parameter set is not used because some previous parameter set caused an error which aborted further processing, or because SQL_PARAM_IGNORE is set for the parameter set in the array specified by the SQL_ATTR_PARAM_OPERATION_PTR. SQL_PARAM_DIAG_UNAVAILABLE: The driver treats the parameter arrays in a monolithic unit because it does not generate the error information level. <p>The statement attribute can be set to a NULL pointer, and the driver does not return the status value of the parameter. The attribute can be set at any time. But a new value is not used until the next SQLExecDirect or SQLExecute is called. Setting the attribute can affect the operation that outputs the parameter to the driver.</p> <p>Setting this statement attribute sets the SQL_DESC_ARRAY_STATUS_PTR field in the APD header.</p>

Attribute	ValuePtr contents
SQL_ATTR_PARAMS_PROCESSED_PTR (ODBC 3.0)	<ul style="list-style-type: none"> SQLULEN*: It is the record field which points to the buffer returning the number of parameter sets processed and it includes the error set. If it is a NULL pointer, it is not returned. <p>Setting this statement attribute sets SQL_DESC_ROWS_PROCESSED_PTR field of IPD header.</p> <p>If SQLExecDirect or SQLExecute that fills the buffer specified in the attribute does not return SQL_SUCCESS or SQL_SUCCESS_WITH_INFO, the buffer content is not defined.</p>
SQL_ATTR_PARAMSET_SIZE (ODBC 3.0)	<ul style="list-style-type: none"> SQLULEN: It is the value which specifies the number of each of the parameter values. If SQL_ATTR_PARAMSET_SIZE is bigger than 1, SQL_DESC_DATA_PTR, SQL_DESC_INDICATOR_PTR, SQL_DESC_OCTET_LENGTH_PTR of APD point to the array. Each array constant is equal to the value of the field. <p>If the bound parameter does not exist, the attribute is ignored.</p> <p>Setting this statement attribute sets SQL_DESC_ARRAY_SIZE field of APD header.</p>
SQL_ATTR_QUERY_TIMEOUT (ODBC 1.0)	<ul style="list-style-type: none"> SQLULEN: The value of seconds that waits before the SQL statement is executed and returned to the application. If ValuePtr is 0 (the default value), timeout does not occur. <p>If the specified time out value exceeds the maximum value of the data source or smaller than the minimum value of the data source, SQLSetStmtAttr replaces the value and returns SQLSTATE 01S02 (Option value changed).</p> <p>Even if SELECT statement is timeout the application does not need to call SQLCloseCursor to reuse the statement.</p> <p>Setting the query timeout of the statement attribute is valid for both synchronous and asynchronous modes.</p>
SQL_ATTR_RETRIEVE_DATA (ODBC 2.0)	<p>It is not supported by the driver.</p>
SQL_ATTR_ROW_ARRAY_SIZE (ODBC 3.0)	<ul style="list-style-type: none"> SQLULEN: It is the value which specifies the number of rows returned by calling SQLFetch or SQLFetchScroll. It is also the number of rows of the bookmark array which is used in the bulk bookmark operation of SQLBulkOperations. The default value is 1. <p>If the specified row set size exceeds the maximum row set size supported by the data source, the driver replaces the value and returns SQLSTATE 01S02 (Option value changed).</p> <p>Setting this statement attribute sets SQL_DESC_ARRAY_SIZE field of ARD header.</p>

Attribute	ValuePtr contents
SQL_ATTR_ROW_BIND_OFFSET_PTR (ODBC 3.0)	<ul style="list-style-type: none"> SQLULEN: It is the value which points the added offset value to indicate the change of the column data binding. If the field is not NULL, the driver dereferences the pointer and adds the dereference value to each field in the descriptor record (SQL_DESC_DATA_PTR, SQL_DESC_INDICATOR_PTR, SQL_DESC_OCTET_LENGTH_PTR) and uses a new pointer value when it is bound. The default value is NULL. <p>Setting this statement attribute sets SQL_DESC_BIND_OFFSET_PTR field of ARD header.</p>
SQL_ATTR_ROW_BIND_TYPE (ODBC 1.0)	<ul style="list-style-type: none"> SQLULEN: It is the value which sets the binding direction when SQLFetch or SQLFetchScroll is called in the related statement. If SQL_BIND_BY_COLUMN value is set, the column-wise binding is selected. If the value to length of a structure or an instance of a buffer into which result columns will be bound is set, the row-wise binding is selected. <p>If a length is specified, they should include space for all bound columns and any padding of the structure or buffer to ensure that when the address of a bound column is increased as the specified length, the result will point to the beginning of the same column in the next row. Using sizeof operator with the structure or union of ANSI C guarantees this operation.</p> <p>The column-wise binding is the default binding direction of SQLFetch and SQLFetchScroll.</p> <p>Setting this statement attribute sets SQL_DESC_BIND_TYPE field of ARD header.</p>
SQL_ATTR_ROW_NUMBER (ODBC 2.0)	<p>It is not supported by the driver.</p>
SQL_ATTR_ROW_OPERATION_PTR (ODBC 3.0)	<p>It is not supported by the driver.</p>
SQL_ATTR_ROW_STATUS_PTR (ODBC 3.0)	<ul style="list-style-type: none"> SQLUSMALLINT*: It is the value which points to the SQLUSMALLINT array including the row status values after calling SQLFetch or SQLFetchScroll. The array has the elements as many as the number of rows included in the row set. <p>The statement attribute can be set to a NULL pointer, and the driver does not return the row status values in this case. The attribute can be set at any time, but a new value is not used until the next call of SQLBulkOperations, SQLFetch, SQLFetchScroll or SQLSetPos.</p> <p>Setting this statement attribute sets SQL_DESC_ARRAY_STATUS_PTR of IRD header.</p> <p>The attribute is mapped to rgbRowStatus array of SQLExtendedFetch in ODBC 2.x driver.</p>

Attribute	ValuePtr contents
SQL_ATTR_ROWS_FETCHED_PTR (ODBC 3.0)	<ul style="list-style-type: none"> SQLULEN*: It points to the buffer which returns the number of rows fetched after calling SQLFetch or SQLFetchScroll. It is the number of rows affected by a bulk operation performed by a call to SQLSetPos with an operation argument of SQL_REFRESH, or it is the number of rows affected by a bulk operation performed by SQLBulkOperations. The number of rows includes the error rows. <p>Setting this statement attribute sets SQL_DESC_ROWS_PROCESSED_PTR field of the IORD header.</p> <p>When SQLFetch or SQLFetchScroll is called to fill the buffer pointed by the attribute, the contents of the buffer are not defined if SQL_SUCCESS or SQL_SUCCESS_WITH_INFO is not returned.</p>
SQL_ATTR_SIMULATE_CURSOR (ODBC 2.0)	It is not supported by the driver.
SQL_ATTR_USE_BOOKMARKS (ODBC 2.0)	It is not supported by the driver.

SQLSetStmtOption

Conformance

Introduced version: ODBC 1.0

Standards compliance: It is not available.

Overview

SQLSetStmtOption function in ODBC 2.0 is replaced with SQLSetStmtAttr in ODBC 3.x.

For more information, refer to [SQLSetStmtAttr](#).

SQLSpecialColumns

Conformance

Introduced version: ODBC 1.0

Standards compliance: It is open group.

Overview

SQLSpecialColumns function retrieves the following information for a column in the specified table.

- The optimal column set that uniquely identifies a row in the table
- The columns which are automatically updated when a row value is updated by the transaction

Syntax

```
SQLRETURN SQLSpecialColumns(  
    SQLHSTMT      StatementHandle,  
    SQLSMALLINT   IdentifierType,  
    SQLCHAR *     CatalogName,  
    SQLSMALLINT   NameLength1,  
    SQLCHAR *     SchemaName,  
    SQLSMALLINT   NameLength2,  
    SQLCHAR *     TableName,  
    SQLSMALLINT   NameLength3,  
    SQLSMALLINT   Scope,  
    SQLSMALLINT   Nullable);
```

Arguments

StatementHandle

[Input] It is the statement handle.

IdentifierType

[Input] It is the column type to return. It should be one of the following values.

- SQL_BEST_ROWID: It returns the optimal column or set of columns that, by retrieving values from the column(s), allows any row in the specified table to be uniquely identified. The column may be a pseudo column for the special purpose (ROWID of ORACLE, TID of INGRES), a general column or a column of a unique index on the table.

- **SQL_ROWVER:** It returns the column or columns in the specified table, if any, which are automatically updated by the data source when any value in the row is updated by any transaction. (such as in SQLBase ROWID or Sybase TIMESTAMP).

CatalogName

[Input] It is the table catalog. If the driver does not support the catalog, an empty string ("") is returned and the tables do not have a catalog. The catalog name can not include a string search pattern.

If **SQL_ATTR_METADATA_ID** is set to **SQL_TRUE**, **CatalogName** is treated as an identifier and it is not case-sensitive. If it is set to **SQL_FALSE**, **CatalogName** is generally treated as a string argument and it is case-sensitive. For more information, refer to **Arguments of Catalog Function**.

NameLength1

[Input] It is the length of *CatalogName string.

SchemaName

[Input] It is name of the table schema. It is the string search pattern for the schema name. If the driver does not support the schema, it returns an empty string ("") and the tables do not have a schema. **SchemaName** can not include a string search pattern.

If **SQL_ATTR_METADATA_ID** is set to **SQL_TRUE**, **SchemaName** is treated as an identifier and it is not case-sensitive. If it is set to **SQL_FALSE**, **SchemaName** is an ordinary argument, it is treated literally and it is case-sensitive.

NameLength2

[Input] It is the length of *SchemaName string.

TableName

[Input] It is name of the table. The argument can not be a NULL pointer. The table name can not include a string search pattern.

If **SQL_ATTR_METADATA_ID** is set to **SQL_TRUE**, **TableName** is treated as an identifier and it is not case-sensitive. If it is set to **SQL_FALSE**, **TableName** is an ordinary argument, it is treated literally, and it is case-sensitive.

NameLength3

[Input] It is the length of *TableName string.

Scope

[Input] It is minimum required scope of the rowid. The returned ROWID scope may be of a bigger scope. The value should be one of the followings.

- **SQL_SCOPE_CURROW:** The rowid is guaranteed to be valid only while it is positioned on that row. If it is updated or deleted by another transaction, the used ROWID is not retrieved.
- **SQL_SCOPE_TRANSACTION:** The rowid is guaranteed to be valid while the current transaction is maintained.
- **SQL_SCOPE_SESSION:** The rowid is guaranteed to be valid while the session is maintained. (It across the transaction boundaries.)

Nullable

[Input] It checks that the particular column can have NULL value. It should be one of the followings.

- SQL_NO_NULLS: A particular column can not have NULL value. Some drivers do not support SQL_NO_NULLS and they will return an empty result set if SQL_NO_NULLS is specified. The application should be prepared this case and request SQL_NO_NULLS only if it is required.
- SQL_NULLABLE: A particular column can have NULL value.

Returns

SQL_SUCCESS, SQL_SUCCESS_WITH_INFO, SQL_STILL_EXECUTING, SQL_ERROR, SQL_INVALID_HANDLE

Diagnosis

SQLSTATE	Error	Description
01000	General warning	It is the driver-specific informational message. (The function returns SQL_SUCCESS_WITH_INFO.)
08S01	Communication link failure	Before the function processing is completed, the connection between the driver and the data source is failed.
24000	Invalid cursor state	A cursor is open on the StatementHandle, and SQLFetch or SQLFetchScroll had been called. This error is returned by the Driver Manager if SQLFetch or SQLFetchScroll does not return SQL_NO_DATA, and is returned by the driver if SQLFetch or SQLFetchScroll returns SQL_NO_DATA. A cursor is open on the StatementHandle, but SQLFetch or SQLFetchScroll is not called.
40001	Serialization failure	The transaction is rolled back due to a resource deadlock of other transactions.
40003	Statement completion unknown	The related connection is failed while executing this function, and the state of the transaction cannot be determined.
HY000	General error	It is an error without specific SQLSTATE, and the error message returned by SQLGetDiagRec in *MessageText buffer describes error message and its cause.
HY001	Memory allocation error	The driver can not allocate the required memory for execution or completion of the function.
HY008	Operation canceled	Asynchronous processing for StatementHandle is available and SQLCancel or SQLCancelHandle is called on StatementHandle before the function is called and completed. Then this function is called again on StatementHandle. SQLCancel or SQLCancelHandle is called on StatementHandle from other

SQLSTATE	Error	Description
		er thread in the multithreaded application before the function is called and completed.
HY009	Invalid use of null pointer	<p>The TableName argument is a null pointer.</p> <p>The SQL_ATTR_METADATA_ID statement attribute is set to SQL_TRUE, the CatalogName argument is a null pointer, and the SQL_CATALOG_NAME InfoType returns that catalog names are supported.</p> <p>The SQL_ATTR_METADATA_ID statement attribute is set to SQL_TRUE, and the SchemaName argument is a null pointer.</p>
HY010	Function sequence error	<p>The asynchronously executing function is called for the connection handle related to StatementHandle, and this function is still being executed when SQLSpecialColumns is called.</p> <p>SQLExecute, SQLExecDirect, SQLMoreResults is called for StatementHandle, and SQL_PARAM_DATA_AVAILABLE is returned. The function is called, before the data is retrieved for all streamed parameters.</p> <p>The asynchronously executing function is called for StatementHandle, and is still being executed when this function is called.</p> <p>SQLExecute, SQLExecDirect, SQLBulkOperation or SQLSetPos are called for StatementHandle, and SQL_NEED_DATA is returned. This function is called before data is sent for all data-at-execution parameters or columns.</p>
HY013	Memory management error	The function is not executed because the underlying memory object cannot be accessed because of the low memory condition.
HY090	Invalid string or buffer length	<p>The value of a length arguments is smaller than 0 but it is not SQL_NTS.</p> <p>The value of a length arguments exceeds the maximum length value for the corresponding name.</p>
HY097	Column type out of range	An invalid IdentifierType value is specified.
HY098	Scope type out of range	An invalid scope value is specified.
HY099	Nullable type out of range	An invalid nullable value is specified.
HY117	Connection is suspended due to unknown transaction state. Only disconnect and read-only functions are allowed.	For more information about the suspended state, refer to SQLEndTran .

SQLSTATE	Error	Description
HYC00	Optional feature not implemented	<p>A catalog is specified, and the driver or data source does not support catalogs.</p> <p>A schema is specified, and the driver or data source does not support schemas.</p> <p>A string search pattern is specified, and all or one of the catalog name, table schema, table name, data source does not support it.</p> <p>The combination of the current settings of the SQL_ATTR_CONCURRENCY and SQL_ATTR_CURSOR_TYPE statement attributes is not supported by the driver or data source.</p> <p>The SQL_ATTR_USE_BOOKMARKS statement attribute is set to SQL_UB_VARIABLE, and the SQL_ATTR_CURSOR_TYPE statement attribute is set to a cursor type for which the driver does not support bookmarks.</p>
HYT00	Timeout expired	The query timeout period is expired before the data source returns the requested result. The time limit can be set via SQLSetStmtAttr of SQL_ATTR_CONNECTION_TIMEOUT.
HYT01	Connection timeout expired	The connection timeout period is expired before the data source responds to the request. The connection time limit can be set via SQLSetConnectAttr of SQL_ATTR_CONNECTION_TIMEOUT.
IM001	Driver does not support this function	The driver does not support the function.
IM017	Polling is disabled in a synchronous notification mode	Whenever using the notification model, polling can not be used.
IM018	SQLCompleteAsync had not been called to complete the previous asynchronous on this handle.	If the previous function call for the handle returns SQL_STILL_EXECUTING and if the notification mode is activated, then SQLCompleteAsync should be called for the handle to do post processing and complete the operation.

Description

If IdentifierType argument is SQL_BEST_ROWID, SQLSpecialColumns returns a column or the column which uniquely identifies each row of the table. The column can be used in select-list or WHERE clause. SQLColumns returns various information of the table column, but it is not necessary to return the column which uniquely identifies each row nor does return a column automatically updated when any value in a row is updated by the transaction. For example, SQLColumns does not return ROWID which is the pseudo column of Oracle. It is the reason that SQLSpecialColumns is used to return information of particular column. For more information, refer to **Using Catalog Data**.



For more information about the general use, arguments, and returned data of ODBC catalog functions, refer to **Catalog Function**.

If column to uniquely identify each row in the table does not exist, `SQLSpecialColumns` does not return any column. Then, `SQL_NO_DATA` is returned when `SQLFetch` or `SQLFetchScroll` is called in the statement.

The characteristics which are specified in `IdentifierType`, scope, nullable arguments are not supported by the data source, `SQLSpecialColumn` returns an empty result set.

If `SQL_ATTR_METADATA_ID` attribute is set to `SQL_TRUE`, then `CatalogName`, `SchemaName`, `TableName` arguments are treated as identifiers and they can not use a `NULL` pointer. (For more information, refer to **Arguments of Catalog Function**.)

`SQLSpecialColumns` function returns a standard result set which is sorted by `SCOPE`.

The following columns are renamed in ODBC 3.x. Changing column name does not affect the backward compatibility because applications bind by column number.

ODBC 2.0 column	ODBC 3,x column
PRECISION	COLUMN_SIZE
LENGTH	BUFFER_LENGTH
SCALE	DECIMAL_DIGITS

`SQLGetInfo` function can be called with `SQL_MAX_COLUMN_NAME_LEN` option in the application to determine the actual length of `COLUMN_NAME` column.

The following table lists the columns in the result set. The additional columns beyond the column 8 (`PSEUDO_COLUMN`) can be defined by the driver. The application should count from the end of the result set rather than specifying an explicit position to access the columns defined by the driver. For more information, refer to **Data Returning of Catalog Function**.

Column name	Column number	Data type	Description
SCOPE (ODBC 1.0)	1	Smallint	It is the actual scope of ROWID. It includes one of <code>SQL_SCOPE_CURROW</code> , <code>SQL_SCOPE_TRANSACTION</code> , or <code>SQL_SCOPE_SESSION</code> . If <code>IdentifierType</code> is <code>SQL_ROWVER</code> , <code>NULL</code> is returned. For more information about each value, refer to scope in Syntax .
COLUMN_NAME (ODBC 1.0)	2	Varchar not NULL	It is the column name. If the column does not have a name, the driver returns an empty string.
DATA_TYPE (ODBC 1.0)	3	Smallint not NULL	It is SQL data type. It may be the ODBC SQL data type or the SQL data type specified in the driver. All ODBC SQL data types are valid. For more information about SQL data types specified in the driver, refer to the documentation of the driver.

Column name	Column number	Data type	Description
TYPE_NAME (ODBC 1.0)	4	Varchar not NULL	It is name of the data source-dependent data type. e.g. CHAR, VARCHAR, MONEY, LONG VARBINARY, CHAR() FOR BIT DATA, etc.
COLUMN_SIZE (ODBC 1.0)	5	Integer	It is the column size in the data source.
BUFFER_LENGTH (ODBC 1.0)	6	Integer	It is the length in bytes of data transferred on an SQLGetData or SQLFetch operation if SQL_C_DEFAULT is specified. The numeric data may be different from the size of the data stored in the data source. The value is as same as COLUMN_SIZE for a string or binary data.
DECIMAL_DIGITS (ODBC 1.0)	7	Smallint	It is the number of decimal places of the column in the data source. NULL is returned if the number of decimal places can not be applied.
PSEUDO_COLUMN (ODBC 2.0)	8	Smallint	It displays whether the column is the pseudo-column such as Oracle ROWID. <ul style="list-style-type: none"> SQL_PC_UNKNOWN SQL_PC_NOT_PSEUDO SQL_PC_PSEUDO <p>The pseudo-column is not allowed to quote an identifier in quotation marks returned in SQLFetchInfo for maximum interoperability.</p>

After the application retrieves the SQL_BEST_ROWID value. The application can use the retrieved values to reselect the row within the defined scope. It guarantees that SELECT statement returns either *no rows* or *one row*.

If the application does not find the row when the row is re-queried based on ROWID or the column, it is assumed that the row is deleted or the ROWID column is changed. Although ROWID is not changed, the other column of the row may be updated.

The columns which are returned for the column type SQL_BEST_ROWID are very useful when the application need to move forward or backward within a result set to retrieve the most recent data among the row set. The column(s) of ROWID are not updated while it is positioned on that row.

The ROWID columns remain valid even when the cursor is not positioned on the row. The application can determine it by checking the SCOPE column in the result set.

SQLStatistics

Conformance

Introduced version: ODBC 1.0

Standards compliance: ISO 92

Overview

SQLStatistics retrieves a list of statistics about a single table and the indexes related to the table. The driver returns the information as a result set.

Syntax

```
SQLRETURN SQLStatistics(  
    SQLHSTMT      StatementHandle,  
    SQLCHAR *     CatalogName,  
    SQLSMALLINT   NameLength1,  
    SQLCHAR *     SchemaName,  
    SQLSMALLINT   NameLength2,  
    SQLCHAR *     TableName,  
    SQLSMALLINT   NameLength3,  
    SQLUSMALLINT  Unique,  
    SQLUSMALLINT  Reserved);
```

Arguments

StatementHandle

[Input] It is the statement handle.

CatalogName

[Input] It is the catalog name. If the driver does not support the catalog, an empty string ("") is returned and the tables do not have a catalog. The catalog name can not include a string search pattern.

If SQL_ATTR_METADATA_ID is set to SQL_TRUE, CatalogName is treated as an identifier and it is not case-sensitive. If it is set to SQL_FALSE, CatalogName is treated as an ordinary argument, it is treated literally, and it is case-sensitive. For more information, refer to **Arguments of Catalog Function**.

NameLength1

[Input] It is the length of *CatalogName string.

SchemaName

[Input] It is the schema name. If the driver does not support the schema, an empty string ("") is returned and the tables do not have a schema.

If SQL_ATTR_METADATA_ID is set to SQL_TRUE, SchemaName is treated as an identifier and it is not case-sensitive. If it is set to SQL_FALSE, SchemaName is treated as an ordinary argument, it is treated literally, and it is case-sensitive.

NameLength2

[Input] It is the length of *SchemaName string.

TableName

[Input] It is the table name. The argument can not be a NULL pointer. TableName does not include a string search pattern .

If SQL_ATTR_METADATA_ID is set to SQL_TRUE, SchemaName is treated as an identifier and it is not case-sensitive. If it is set to SQL_FALSE, SchemaName is treated as an ordinary argument, it is treated literally, and it is case-sensitive.

NameLength3

[Input] It is the length of *TableName string.

Unique

[Input] It is the index type. It can be SQL_INDEX_UNIQUE or SQL_INDEX_ALL.

Reserved

[Input] The importance of CARDINALITY and PAGES columns is displayed in the result set. The following options affect only the results of CARDINALITY and PAGES columns. The index information is returned even when CARDINALITY and PAGES are not returned.

- SQL_ENSURE: It requests the driver to unconditionally search for statistics. (The driver which complies with Open Group standards, but does not support the ODBC extension can not support SQL_ENSURE.)
- SQL_QUICK: If it is readily available from the server, it requests the driver to unconditionally search for CARDINALITY and PAGES. The driver does not guarantee that the retrieved value is the current value. (The application which is registered in Open Group will always get SQL_QUICK from ODBC 3.x-compliant drivers.)

Returns

SQL_SUCCESS, SQL_SUCCESS_WITH_INFO, SQL_STILL_EXECUTING, SQL_ERROR, SQL_INVALID_HANDLE

Diagnosis

SQLSTATE	Error	Description
01000	General warning	It is the driver-specific informational message. (The function returns SQL_SUCCESS_WITH_INFO.)
08S01	Communication link failure	Before the function processing is completed, the connection between the driver and the data source is failed.
24000	Invalid cursor state	<p>The cursor is open in StatementHandle, and SQLFetch or SQLFetchScroll is called.</p> <p>If SQLFetch or SQLFetchScroll does not return SQL_NO_DATA, the driver manager returns this error. If SQLFetch or SQLFetchScroll returns SQL_NO_DATA, the driver returns this error.</p> <p>The cursor is open in StatementHandle, but SQLFetch or SQLFetchScroll is not called.</p>
40001	Serialization failure	The transaction is rolled back due to a resource deadlock of other transactions.
40003	Statement completion unknown	The related connection fails during the function execution and the status of the transaction is not able to be checked.
HY000	General error	It is an error without specific SQLSTATE, and the error message returned by SQLGetDiagRec in *MessageText buffer describes error message and its cause.
HY001	Memory allocation error	The driver can not allocate the memory required for execution or completion of the function.
HY008	Operation canceled	<p>Asynchronous processing for StatementHandle is available and SQLCancel or SQLCancelHandle is called on StatementHandle before the function is called and completed. Then this function is called again on StatementHandle.</p> <p>SQLCancel or SQLCancelHandle is called on StatementHandle from other thread in the multithreaded application before the function is called and completed.</p>
HY009	Invalid use of null pointer	<p>TableName argument is the null pointer.</p> <p>The SQL_ATTR_METADATA_ID statement attribute is set to SQL_TRUE, the CatalogName argument is a null pointer, and the SQL_CATALOG_NAME InfoType returns that catalog names are supported.</p> <p>The SQL_ATTR_METADATA_ID statement attribute is set to SQL_TRUE, and the SchemaName argument is a null pointer.</p>
		The asynchronously executing function is called for the connection handle related to StatementHandle, and this function is still being executed when SQLStatistics is called.

SQLSTATE	Error	Description
HY010	Function sequence error	<p>SQLExecute, SQLExecDirect, SQLMoreResults is called for StatementHandle, and SQL_PARAM_DATA_AVAILABLE is returned. The function is called, before the data retrieves all streamed parameters.</p> <p>The asynchronously executing function is called for StatementHandle, and is still being executed when the function is called.</p> <p>SQLExecute, SQLExecDirect, SQLBulkOperation or SQLSetPos are called for StatementHandle, and SQL_NEED_DATA is returned. This function is called before data is sent for all data-at-execution parameters or columns.</p>
HY013	Memory management error	The function is not executed because the underlying memory object cannot be accessed because of the low memory condition.
HY090	Invalid string or buffer length	<p>A name length argument value is smaller than 0, but it is not SQL_NTS.</p> <p>A single value of the name length arguments exceeds the maximum length.</p>
HY100	Uniqueness option type out of range	The invalid unique value is specified.
HY101	Accuracy option type out of range	The invalid reserved value is specified.
HY117	Connection is suspended due to unknown transaction state. Only disconnect and read-only functions are allowed.	For more information about the suspended state, refer to SQLEndTran .
HYC00	Optional feature not implemented	<p>A catalog is specified, and the driver or data source does not support catalogs.</p> <p>A schema is specified, and the driver or data source does not support schemas.</p> <p>A string search pattern is specified, and the catalog name, table schema, table name, data source does not support it.</p> <p>The combination of the current settings of the SQL_ATTR_CONCURRENCY and SQL_ATTR_CURSOR_TYPE statement attributes is not supported by the driver or data source.</p> <p>The SQL_ATTR_USE_BOOKMARKS statement attribute is set to SQL_UB_VARIABLE, and the SQL_ATTR_CURSOR_TYPE statement attribute is</p>

SQLSTATE	Error	Description
		set to a cursor type for which the driver does not support bookmarks.
HYT00	Timeout expired	The query timeout period is expired before the data source returns the requested result. The time limit can be set via SQLSetStmtAttr of SQL_ATTR_CONNECTION_TIMEOUT.
HYT01	Connection timeout expired	The connection timeout period is expired before the data source responds to the request. The connection time limit can be set via SQLSetConnectAttr of SQL_ATTR_CONNECTION_TIMEOUT.
IM001	Driver does not support this function	The driver does not support the function.
IM017	Polling is disabled in a synchronous notification mode	Whenever using the notification model, polling can not be used.
IM018	SQLCompleteAsync has not been called to complete the previous asynchronous operation on this handle.	If the previous function call for the handle returns SQL_STILL_EXECUTING and if the notification mode is activated, then SQLCompleteAsync should be called for the handle to do post processing and complete the operation.

Description

SQLStatistics returns information of a table as a standard result set sorted by NON_UNIQUE, TYPE, INDEX_QUALIFIER, INDEX_NAME, ORDINAL_POSITION. The result set combines the table statistics information (CARDINALITY and PAGES row of the result set) along with information for each index. For more information, refer to **Using Catalog Data**.

SQLGetInfo is called with SQL_MAX_CATALOG_NAME_LEN, SQL_MAX_SCHEMA_NAME_LEN, SQL_MAX_TABLE_NAME_LEN, SQL_MAX_COLUMN_NAME_LEN to determine the actual length of TABLE_CAT, TABLE_SCHEM, TABLE_NAME, COLUMN_NAME rows in the application.



For more information about the general use, arguments, and returned data of ODBC catalog functions, refer to **Catalog Function**.

The following columns are renamed in ODBC 3.x. Changing column name does not affect the backward compatibility because applications bind by column number.

ODBC 2.0 column	ODBC 3.x column
TABLE_QUALIFIER	TABLE_CAT
TABLE_OWNER	TABLE_SCHEM
SEQ_IN_INDEX	ORDINAL_POSITION
COLLATION	ASC_OR_DESC

The following table lists the columns in the result set. The additional columns beyond the column 13 (FILTER_CONDITION) can be defined by the driver. The application should count from the end of the result set rather than specifying an explicit position to access the columns defined by the driver. For more information, refer to **Data Returning of Catalog Function**.

Column name	Column number	Data type	Description
TABLE_CAT (ODBC 1.0)	1	Varchar	It is the catalog name. If the data source can not be converted, it is NULL. If the driver does not support the catalog, an empty string ("") is returned and the tables do not have the catalog.
TABLE_SCHEM (ODBC 1.0)	2	Varchar	It is the schema name. If it is not applicable to the data source, it is NULL. If the driver does not support the schema, an empty string ("") is returned and the tables do not have the schema.
TABLE_NAME (ODBC 1.0)	3	Varchar not NULL	It is the table name to which the statistics or index is applied.
NON_UNIQUE (ODBC 1.0)	4	Smallint	It indicates whether the duplication of the index value is allowed. <ul style="list-style-type: none"> SQL_TRUE: The index values may not be unique. SQL_FALSE: The index values should be unique. If TYPE is SQL_TABLE_STAT, NULL is returned.
INDEX_QUALIFIER (ODBC 1.0)	5	Varchar	It is an identifier which executes DROP INDEX and specifies the index name. If it is the data source which does not support the index rules or TYPE is SQL_TABLE_STAT, then NULL is returned. If a non-NULL value is returned in the row, the value is used to define the index identified in DROP INDEX. Otherwise, the TABLE_SCHEM should be used to qualify the index name.
INDEX_NAME (ODBC 1.0)	6	Varchar	It is the index name. If TYPE is SQL_TABLE_STAT, NULL is returned.
TYPE (ODBC 1.0)	7	Smallint not NULL	It is the information type to be returned. <ul style="list-style-type: none"> SQL_TABLE_STAT: It indicates statistics for the table. (in CARDINALITY or PAGES row) SQL_INDEX_BTREE: It indicates B-Tree index. SQL_INDEX_CLUSTERED: It indicates the cluster index. SQL_INDEX_CONTENT: It indicates the content of the index. SQL_INDEX_HASHED: It indicates the hash index. SQL_INDEX_OTHER: It indicates other types of index.
ORDINAL_POSITION (ODBC 1.0)	8	Smallint	It is the row order on the index (starting from 1). If TYPE is SQL_TABLE_STAT, NULL is returned.
COLUMN_NAME			It is the column name. If the row is an expression such as SALARY + BE

Column name	Column number	Data type	Description
AME (ODBC 1.0)	9	Varchar	NEFITS, the expression is returned. If the expression is unknown, an empty string is returned. If TYPE is SQL_TABLE_STAT, NULL is returned.
ASC_OR_DESC (ODBC 1.0)	10	Char(1)	It is the column sorting sequence. A is ascending, and D is descending. If the row sorting sequence is not supported in the data source or TYPE is SQL_TABLE_STAT, then NULL is returned.
CARDINALITY (ODBC 1.0)	11	Integer	The cardinality of the table or index. If TYPE is SQL_TABLE_STAT, it is the number of rows of the table. If TYPE is not SQL_TABLE_STAT, it is the number of unique values of the index. If the value can not be used from the data source, NULL is returned.
PAGES (ODBC 1.0)	12	Integer	It is the number of pages stored in the index or table. If TYPE is SQL_TABLE_STAT, it is the number of pages of the table. If TYPE is not SQL_TABLE_STAT, it is the number of pages of the index. If the value of the data source can not be used or converted, then NULL is returned.
FILTER_CONDITION (ODBC 2.0)	13	Varchar	If the index is the filtered index such as SALARY > 30000, it is the filter condition. If the filter condition can not be determined, it is an empty string. If it is not an index, the filtered index can not be determined or TYPE is SQL_TABLE_STAT.

If the row in the result set corresponds to the table, the driver sets TYPE to SQL_TABLE_STAT, and sets NON_UNIQUE, INDEX_QUALIFIER, INDEX_NAME, ORDINAL_POSITION, COLUMN and ASC_OR_DESC to NULL. If CARDINALITY or PAGES can not be used in the data source, the driver sets them to NULL.

SQLTablePrivileges

Conformance

Introduced version: ODBC 1.0

Standards compliance: ODBC

Overview

SQLTablePrivileges returns the table list and the privileges related to each table. The driver returns the information in the form of the result set in the specified statement.

Syntax

```
SQLRETURN SQLTablePrivileges(
    SQLHSTMT      StatementHandle,
    SQLCHAR *     CatalogName,
    SQLSMALLINT   NameLength1,
    SQLCHAR *     SchemaName,
    SQLSMALLINT   NameLength2,
    SQLCHAR *     TableName,
    SQLSMALLINT   NameLength3);
```

Arguments

StatementHandle

[Input] It is the statement handle for the search results.

CatalogName

[Input] It is the table catalog. If the driver does not support the catalog, an empty string ("") is returned and the tables do not have a catalog. The catalog name can not include a string search pattern .

If SQL_ATTR_METADATA_ID is set to SQL_TRUE, CatalogName is treated as an identifier and it is not case-sensitive. If it is set to SQL_FALSE, CatalogName is treated as an ordinary argument, it is treated literally, and it is case-sensitive. For more information, refer to **Arguments of Catalog Function**.

NameLength1

[Input] It is the string length of *CatalogName.

SchemaName

[Input] It is a string search pattern for the schema name. If the driver does not support the schema, an empty string ("") is returned and the tables do not have a schema.

If SQL_ATTR_METADATA_ID is set to SQL_TRUE, SchemaName is treated as an identifier and it is not case-sensitive. If it is set to SQL_FALSE, SchemaName is treated as a pattern value string argument and it is case-sensitive.

NameLength2

[Input] It is the string length of *SchemaName.

TableName

[Input] It is table name string search pattern .

If SQL_ATTR_METADATA_ID is set to SQL_TRUE, TableName is treated as an identifier and it is not case-sensitive. If it is set to SQL_FALSE, TableName is treated as a pattern value string argument and it is case-sensitive.

NameLength3

[Input] It is the string length of *TableName.

Returns

SQL_SUCCESS, SQL_SUCCESS_WITH_INFO, SQL_STILL_EXECUTING, SQL_ERROR, SQL_INVALID_HANDLE

Diagnosis

SQLSTATE	Error	Description
01000	General warning	It is the driver-specific informational message. (The function returns SQL_SUCCESS_WITH_INFO.)
08S01	Communication link failure	Before the function processing is completed, the connection between the driver and the data source is failed.
24000	Invalid cursor state	A cursor is open on the StatementHandle, and SQLFetch or SQLFetchScroll had been called. This error is returned by the driver manager if SQLFetch or SQLFetchScroll does not return SQL_NO_DATA, and is returned by the driver if SQLFetch or SQLFetchScroll returns SQL_NO_DATA. A cursor is open on the StatementHandle, but SQLFetch or SQLFetchScroll is not called.
40001	Serialization failure	The transaction is rolled back due to a resource deadlock of other transactions.
40003	Statement completion unknown	The related connection fails during the function execution and the status of the transaction is not able to be checked.

SQLSTATE	Error	Description
HY000	General error	It is an error without specific SQLSTATE, and the error message returned by SQLGetDiagRec in *MessageText buffer describes error message and its cause.
HY001	Memory allocation error	The driver can not allocate the memory required for execution or completion of the function.
HY008	Operation canceled	Asynchronous processing for StatementHandle is available and SQLCancel or SQLCancelHandle is called on StatementHandle before the function is called and completed. Then this function is called again on StatementHandle. SQLCancel or SQLCancelHandle is called on StatementHandle from other thread in the multithreaded application before the function is called and completed.
HY009	Invalid use of null pointer	SQL_ATTR_METADATA_ID statement attribute is set to SQL_TRUE, and CatalogName argument is a null pointer. SQL_CATALOG_NAME InfoType returns that catalog names are supported. SQL_ATTR_METADATA_ID statement attribute is set to SQL_TRUE, and SchemaName or TableName argument is a null pointer.
HY010	Function sequence error	The asynchronously executing function is called for the connection handle related to StatementHandle, and this function is still being executed when SQLTablePrivileges is called. SQLExecute, SQLExecDirect or SQLMoreResults are called for StatementHandle, and SQL_PARAM_DATA_AVAILABLE is returned. This function is called before data is retrieved for all streamed parameters. The asynchronously executing function is called for StatementHandle, and is still being executed when the function is called. SQLExecute, SQLExecDirect, SQLBulkOperation or SQLSetPos are called for StatementHandle, and SQL_NEED_DATA is returned. This function is called before data is sent for all data-at-execution parameters or columns.
HY013	Memory management error	The function is not executed because the underlying memory object can not be accessed because of the low memory condition.
HY090	Invalid string or buffer length	The value of a length arguments is smaller than 0 but it is not SQL_NTS. The value of a length arguments exceeds the maximum length value for the corresponding name.
HY117	Connection is suspended due to unknown transaction state. Only	For more information about the suspended state, refer to SQLEndTran .

SQLSTATE	Error	Description
	disconnect and read-only functions are allowed.	
HYC00	Optional feature not implemented	<p>A catalog is specified, and the driver or data source does not support catalogs.</p> <p>A schema is specified, and the driver or data source does not support schemas.</p> <p>A string search pattern is specified, and the catalog name, table schema, table name, data source does not support it.</p> <p>The combination of the current settings of the SQL_ATTR_CONCURRENCY and SQL_ATTR_CURSOR_TYPE statement attributes is not supported by the driver or data source.</p> <p>The SQL_ATTR_USE_BOOKMARKS statement attribute is set to SQL_UB_VARIABLE, and the SQL_ATTR_CURSOR_TYPE statement attribute is set to a cursor type for which the driver does not support bookmarks.</p>
HYT00	Timeout expired	The query timeout period is expired before the data source returns the requested result. The time limit can be set via SQLSetStmtAttr of SQL_ATTR_CONNECTION_TIMEOUT.
HYT01	Connection timeout expired	The connection timeout period is expired before the data source responds to the request. The connection time limit can be set via SQLSetConnectAttr of SQL_ATTR_CONNECTION_TIMEOUT.
IM001	Driver does not support this function	The driver does not support the function.
IM017	Polling is disabled in a synchronous notification mode	Whenever using the notification model, polling can not be used.
IM018	SQLCompleteAsync has not been called to complete the previous asynchronous operation on this handle.	If the previous function call for the handle returns SQL_STILL_EXECUTING and if the notification mode is activated, then SQLCompleteAsync should be called for the handle to do post processing and complete the operation.

Description

SchemaName and TableName arguments accept search patterns. For more information about valid search patterns, refer to **Pattern Value Argument**.

SQLTablePrivileges returns the result as a standard result set sorted by TABLE_CAT, TABLE_SCHEM, TABLE_NAME, PRIVILEGE, GRANTEE.

SQLGetInfo function is called with SQL_MAX_CATALOG_NAME_LEN, SQL_MAX_SCHEMA_NAME_LEN, SQL_MAX_TABLE_NAME_LEN to determine the actual length of TABLE_CAT, TABLE_SCHEM, TABLE_NAME columns in the application.



For more information about the general use, arguments, and returned data of ODBC catalog functions, refer to **Catalog Function**.

The following columns are renamed in ODBC 3.x. Changing column name does not affect the backward compatibility because applications bind by column number.

ODBC 2.0 column	ODBC 3.x column
TABLE_QUALIFIER	TABLE_CAT
TABLE_OWNER	TABLE_SCHEM

The following table lists the columns in the result set. The additional columns beyond the column 7 (IS_GRANTABLE) can be defined by the driver. The application should count from the end of the result set rather than specifying an explicit position to access the columns defined by the driver. For more information, refer to **Data Returning of Catalog Function**.

Column name	Column number	Data type	Description
TABLE_CAT (ODBC 1.0)	1	Varchar	It is the catalog name. If the data source can not be converted, it is NULL. If the driver does not support the catalog, an empty string ("") is returned and the tables do not have the catalog.
TABLE_SCHEM (ODBC 1.0)	2	Varchar	It is the schema name. If it is not applicable to the data source, it is NULL. If the driver does not support the schema, an empty string ("") is returned and the tables do not have the schema.
TABLE_NAME (ODBC 1.0)	3	Varchar not NULL	It is the table name.
GRANTOR (ODBC 1.0)	4	Varchar	It is the user name who grants the privilege. If it is not applicable to the data source, it is NULL. For all rows in which the value in the GRANTEE column is the owner of the object, the GRANTOR column is _SYSTEM.
GRANTEE (ODBC 1.0)	5	Varchar not NULL	It is the user name to whom the privilege is granted.
			The table privilege. It is one of the followings or the a data source-specific privilege. <ul style="list-style-type: none"> • SELECT: Grantee is allowed to retrieve one or more columns in a table.

Column name	Column number	Data type	Description
PRIVILEGE (ODBC 1.0)	6	Varchar not NULL	<ul style="list-style-type: none"> • INSERT: Grantee is allowed to insert new rows containing data for one or more columns into a table. • UPDATE: Grantee is allowed to update one or more columns in a table. • DELETE: Grantee is allowed to delete the data of a table. • REFERENCES: Grantee is allowed to refer to one or more columns in a table within constraints. (e.g. unique, referential, Table constraints check) <p>The scope of action allowed to grantee who is given the table privilege depends on the data source. For example, the UPDATE privilege permits the grantee to update all columns in a table on one data source and only the columns for which the grantor has the UPDATE privilege on another data source.</p>
IS_GRANTABLE (ODBC 1.0)	7	Varchar	<p>It indicates whether GRANTEE can give other user the privilege and it is YES or NO. If it is not applicable to the data source or unknown, it is NULL.</p> <p>The privilege is grantable or not grantable, and it can not be both of them.</p> <p>The result set that SQLColumnPrivileges returns does not include the two rows which all columns except for IS_GRANTABLE have the same value.</p>

SQLTables

Conformance

Introduced version: ODBC 1.0

Standards compliance: Open group

Overview

SQLTables returns the table list, catalog, or schema name, table type stored in the specified data source. The driver returns the information as a result set.

Syntax

```
SQLRETURN SQLTables(
    SQLHSTMT      StatementHandle,
    SQLCHAR *     CatalogName,
    SQLSMALLINT   NameLength1,
    SQLCHAR *     SchemaName,
    SQLSMALLINT   NameLength2,
    SQLCHAR *     TableName,
    SQLSMALLINT   NameLength3,
    SQLCHAR *     TableType,
    SQLSMALLINT   NameLength4);
```

Arguments

StatementHandle

[Input] It is the statement handle for the search results.

CatalogName

[Input] It is the catalog name. If SQL_ODBC_VERSION environment attribute is SQL_OV_ODBC3, CatalogName argument accepts a search pattern. If the driver supports catalogs only for a few tables, for example, the driver retrieves the data from another DBMS, an empty string ("") indicates that the table does not have a catalog.

If SQL_ATTR_METADATA_ID statement attribute is set to SQL_TRUE, CatalogName is treated as an identifier and it is not case-sensitive. If it is set to SQL_FALSE, CatalogName is a pattern value argument, it is treated literally and it is case-sensitive. For more information, refer to **Arguments of Catalog Function**.

NameLength1

[Input] It is the string length of *CatalogName.

SchemaName

[Input] It is the string search pattern for the schema name. An empty string ("") such as CatalogName indicates that the table does not have schema. The argument processing depends on SQL_ATTR_METADATA_ID statement attribute such as CatalogName.

NameLength2

[Input] It is the character length of *SchemaName.

TableName

[Input] It is the string search pattern for the table name. Also, the argument processing depends on SQL_ATTR_METADATA_ID statement attribute such as CatalogName.

NameLength3

[Input] It is the character length of *TableName.

TableType

[Input] It is the matched table type list.

SQL_ATTR_METADATA_ID statement attribute does not affect TableType argument. TableType is the value list argument, regardless of setting of SQL_ATTR_METADATA_ID.

NameLength4

[Input] It is the character length of *TableType.

Returns

SQL_SUCCESS, SQL_SUCCESS_WITH_INFO, SQL_STILL_EXECUTING, SQL_ERROR, SQL_INVALID_HANDLE

Diagnosis

SQLSTATE	Error	Description
01000	General warning	It is the driver-specific informational message. (The function returns SQL_SUCCESS_WITH_INFO.)
08S01	Communication link failure	Before the function processing is completed, the connection between the driver and the data source is failed.
24000	Invalid cursor state	A cursor is open on the StatementHandle, and SQLFetch or SQLFetchScroll had been called. This error is returned by the Driver Manager if SQLFetch or SQLFetchScroll does not return SQL_NO_DATA, and is returned by the driver if SQLFetch or SQLFetchScroll returns SQL_NO_DATA. A cursor is open on the StatementHandle, but SQLFetch or SQLFetchSc

SQLSTATE	Error	Description
		roll is not called.
40001	Serialization failure	The transaction is rolled back due to a resource deadlock of other transactions.
40003	Statement completion unknown	The related connection is failed while executing this function, and the state of the transaction cannot be determined.
HY000	General error	It is an error without specific SQLSTATE, and the error message returned by SQLGetDiagRec in *MessageText buffer describes error message and its cause.
HY001	Memory allocation error	The driver can not allocate the required memory for execution or completion of the function.
HY008	Operation canceled	Asynchronous processing for StatementHandle is available and SQLCancel or SQLCancelHandle is called on StatementHandle before the function is called and completed. Then this function is called again on StatementHandle. SQLCancel or SQLCancelHandle is called on StatementHandle from other thread in the multithreaded application before the function is called and completed.
HY009	Invalid use of null pointer	SQL_ATTR_METADATA_ID statement attribute is set to SQL_TRUE, and CatalogName argument is a null pointer. SQL_CATALOG_NAME InfoType returns that catalog names are supported. SQL_ATTR_METADATA_ID statement attribute is set to SQL_TRUE, and SchemaName or TableName argument is a null pointer.
HY010	Function sequence error	The asynchronously executing function is called for the connection handle related to StatementHandle, and this function is still being executed when SQLTables is called. SQLExecute, SQLExecDirect, SQLMoreResults is called for StatementHandle, and SQL_PARAM_DATA_AVAILABLE is returned. The function is called, before the data for all streamed parameters is retrieved. The asynchronously executing function is called for StatementHandle, and is still being executed when SQLTables function is called. SQLExecute, SQLExecDirect, SQLBulkOperation or SQLSetPos are called for StatementHandle, and SQL_NEED_DATA is returned. This function is called before data is sent for all data-at-execution parameters or columns.
HY013	Memory management error	The function is not executed because the underlying memory object can not be accessed because of the low memory condition.
HY090	Invalid string or buffer length	The value of a length arguments is smaller than 0 but it is not SQL_NTS.

SQLSTATE	Error	Description
		The value of a length arguments exceeds the maximum length value for the corresponding name.
HY117	Connection is suspended due to unknown transaction state. Only disconnect and read-only functions are allowed	For more information about the suspended state, refer to <i>SQLEndTran</i> .
HYC00	Optional feature not implemented	<p>A catalog is specified, and the driver or data source does not support catalogs.</p> <p>A schema is specified, and the driver or data source does not support schemas.</p> <p>A string search pattern is specified, and the catalog name, table schema, table name, data source does not support it.</p> <p>The combination of the current settings of the <i>SQL_ATTR_CONCURRENCY</i> and <i>SQL_ATTR_CURSOR_TYPE</i> statement attributes is not supported by the driver or data source.</p> <p>The <i>SQL_ATTR_USE_BOOKMARKS</i> statement attribute is set to <i>SQL_UB_VARIABLE</i>, and the <i>SQL_ATTR_CURSOR_TYPE</i> statement attribute is set to a cursor type for which the driver does not support bookmarks.</p>
HYT00	Timeout expired	The query timeout period is expired before the data source returns the requested result. The time limit can be set via <i>SQLSetStmtAttr</i> of <i>SQL_ATTR_CONNECTION_TIMEOUT</i> .
HYT01	Connection timeout expired	The connection timeout period is expired before the data source responds to the request. The connection time limit can be set via <i>SQLSetConnectAttr</i> of <i>SQL_ATTR_CONNECTION_TIMEOUT</i> .
IM001	Driver does not support this function	The driver does not support the function.
IM017	Polling is disabled in a synchronous notification mode	Whenever using the notification model, polling can not be used.
IM018	<i>SQLCompleteAsync</i> has not been called to complete the previous asynchronous operation on this handle.	If the previous function call for the handle returns <i>SQL_STILL_EXECUTING</i> and if the notification mode is activated, then <i>SQLCompleteAsync</i> should be called for the handle to do post processing and complete the operation.

Description

SQLTables lists all tables in the requested scope. The user may have the SELECT privilege on the tables, or not. The application checks the accessibility as follows.

- SQL_ACCESSIBLE_TABLES information type is checked by calling SQLGetInfo.
- The privilege on each table is checked by calling SQLTablePrivileges.

Otherwise, the application should deal with the situation that the user performs a select statement without SELECT privilege.

SchemaName and TableName arguments can use the search pattern. If SQL_ODBC_VERSION is SQL_OV_ODBC3, then CatalogName argument can also use the search pattern. For more information about valid search pattern, refer to **Pattern Value Argument**.



For more information about the general use, arguments, and returned data of ODBC catalog functions, refer to **Catalog Function**.

The particular meaning of CatalogName, SchemaName, TableName, TableType arguments of SQLTables is defined as follows to support the enumeration of catalog, schema, and table types.

- If CatalogName is SQL_ALL_CATALOGS and SchemaName and TableName are the empty string, the result set includes a valid catalog for the data source. (All columns except for TABLE_CAT column include NULL.)
- If SchemaName is SQL_ALL_SCHEMAS and CatalogName and TableName are the empty string, the result set includes a valid schema for the data source. (All columns except for TABLE_SCHE column include NULL.)
- If TableType is SQL_ALL_TABLE_TYPES and CatalogName, SchemaName, and TableName are the empty string, the result set includes a valid table type for the data source. (All columns except for TABLE_TYPE column include NULL.)

If TableType is not an empty string, it should include a list of comma-separated values for the types of interest. Each value can be enclosed in single quote (') or unquoted such as 'TABLE', 'VIEW' or TABLE, VIEW. An application should always specify the table type in uppercase. The driver should convert the table type to whatever case is needed by the data source. If the data source does not support the specified table type, SQLTables does not return any data result for that type.

SQLTables returns the result as a standard result set ordered by TABLE_TYPE, TABLE_CAT, TABLE_SCHE, TABLE_NAME. For more information, refer to **Using Catalog Data**.

SQLGetInfo is called with SQL_MAX_CATALOG_NAME_LEN, SQL_MAX_SCHEMA_NAME_LEN, SQL_MAX_TABLE_NAME_LEN to determine the actual length of TABLE_CAT, TABLE_SCHEM, TABLE_NAME column in the application.

The following columns are renamed in ODBC 3.x. Changing column name does not affect the backward compatibility because applications bind by column number.

ODBC 2.0 column	ODBC 3.x column
TABLE_QUALIFIER	TABLE_CAT
TABLE_OWNER	TABLE_SCHEM

The following table lists the columns in the result set. The additional columns beyond the column 5 (REMARKS) can be defined by the driver. The application should count from the end of the result set rather than specifying an explicit position to access the columns defined by the driver.

For more information, refer to **Data Returning of Catalog Function**.

Column name	Column number	Data type	Description
TABLE_CAT (ODBC 1.0)	1	Varchar	It is the catalog name. If it is not applicable to the data source, it is NULL. If the driver does not support the catalog, an empty string ("") is returned and the tables do not have the catalog.
TABLE_SCHEMA (ODBC 1.0)	2	Varchar	It is the schema name. If it is not applicable to the data source, it is NULL. If the driver does not support the schema, an empty string ("") is returned and the tables do not have the schema.
TABLE_NAME (ODBC 1.0)	3	Varchar	It is the table name.
TABLE_TYPE (ODBC 1.0)	4	Varchar	It is the table type name. It is one of "TABLE", "VIEW", "SYSTEM TABLE", "GLOBAL TEMPORARY", "LOCAL TEMPORARY", "ALIAS", "SYNONYM" or the name specified in the data source. The meaning of "ALIAS" and "SYNONYM" is driver-specific.
REMARKS (ODBC 1.0)	5	Varchar	It is the description for the table.

SQLTransact

Conformance

Introduced version: ODBC 1.0

Standards compliance: It is not available.

Overview

SQLTransact function in ODBC 2.x is replaced with `SQLEndTran` in ODBC 3.x.

For more information, refer to [SQLEndTran](#).

25.6 XA API References

Overview

X/Open XA is the standards for distributed transaction processing defined in X/Open. Typically, it prescribes the interface between a multi-transaction manager and a local resource manager. XA describes what is needed for the resource manager to process the transaction.

GOLDILOCKS XA is implemented based on X/Open CAE document, Distributed Transaction Processing: The XA Specification (<http://www.opengroup.org/public/catalog/c193.htm>).

X/Open DTP (Distributed Transaction Processing) model defines the transaction management between different heterogeneous computer databases.

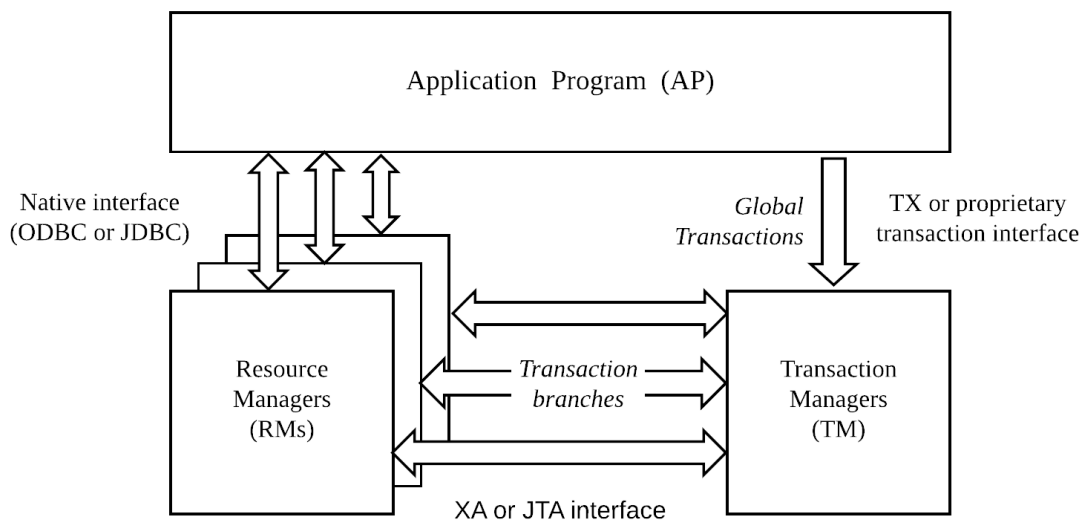

- **Application Program (AP):** It defines the work consisting of transactions.
- **Resource Managers (RM):** It manages the shared resources accessed by a distributed transaction. It means a database management system, such as GOLDILOCKS.
- **Transaction Manager (TM):** It assigns ID(XID) of a distributed transaction, and manages the progress of a distributed transaction, and has the responsibility for the termination and recovery of a distributed transaction.

AP is a program developed by using the precompiler or ODBC. AP does not directly use the XA interface, and it uses the native interface of RM, or it controls the transaction by using TX interface provided by TM.

XA Interface

XA interface is the interface specification between RM and TM. GOLDILOCKS does not provide a separate library for XA interface, and it is included in the ODBC libraries provided by GOLDILOCKS.

switch_t Structure

It is a structure which includes information about the entry point for XA interface and information about RM.

xa_switch_t provided by GOLDILOCKS is goldilocks_xa_switch.

Variable name	Description
char name[RMNAMESZ]	It is RM name.
long flags	It is the option provided in RM. <ul style="list-style-type: none"> MIGRATE option is not supported. (It is set to TMNOMIGRATE.)
long version	It is RM version.
int (*xa_open_entry)(char *, int, long);	It is xa_open function pointer.
int (*xa_close_entry)(char *, int, long);	It is xa_close function pointer.
int (*xa_start_entry)(XID *, int, long);	It is xa_start function pointer.
int (*xa_end_entry)(XID *, int, long);	It is xa_end function pointer.
int (*xa_rollback_entry)(XID *, int, long);	It is xa_rollback function pointer.
int (*xa_prepare_entry)(XID *, int, long);	It is xa_prepare function pointer.
int (*xa_commit_entry)(XID *, int, long);	It is xa_commit function pointer.
xint (*xa_recover_entry)(XID *, long, int, long);	It is xa_recover function pointer.
int (*xa_forget_entry)(XID *, int, long);	It is xa_forget function pointer.
int (*xa_complete_entry)(int *, int *, int, long);	It is xa_complete function pointer. <ul style="list-style-type: none"> It is not provided in GOLDILOCKS.

ODBC Functions Related to XA

It describes the functions which are added to use the XA interface besides the standard ODBC.

SQLGetXaSwitch

It gets xa_switch_t provided by ODBC function.

```
xa_switch_t * SQLGetXaSwitch( void );
```

Return

It returns a pointer to sw_switch_t structure provided by ODBC. NULL can not be returned.

SQLGetXaConnectionHandle

It gets the connection handle related to the current XA session.

```
SQLHANDLE SQLGetXaConnectionHandle( void );
```

Return

If the connected XA session exist at the corresponding thread, it returns the related connection handle. Otherwise, it returns NULL.

XA Functions

It describes the details for XA related functions of `xa_switch_t` structure.

`xa_open`

It connects to RM.



It is ignored if it is already connected in the thread which called `xa_open`.

```
int xa_open(
    char * xa_info,
    int   rmid,
    long  flags );
```

Arguments

`xa_info`

[Input] It is a string which includes the access information, and the maximum length is 256 bytes. For more information, refer to `InConnectionString` of `SQLDriverConnect`.

`rmid`

[Input] It is the unique ID of RM to be connected. The argument is ignored.

`flags`

[Input] It is connection flag. It should be set to `TMNOFLAGS`.

Diagnosis

Return value	Description
<code>XA_OK</code>	The operation is normally performed.
<code>XAER_RMFAIL</code>	It occurs when RM can not be used.
<code>XAER_RMERR</code>	RM can not perform the operation in a transaction branch due to lack of resources.
<code>XAER_INVAL</code>	It occurs when passing the abnormal argument.

xa_close

It terminates the connection of RM, and releases the connection handle.

```
int xa_close(  
    char * xa_info,  
    int   rmid,  
    long  flags );
```

Arguments

xa_info

[Input] It is a string which includes the access information, and the argument is ignored.

rmid

[Input] It is the unique ID of RM to be connected. The argument is ignored.

flags

[Input] It is the termination flag. The argument is ignored.

Diagnosis

Return value	Description
XA_OK	The operation is normally performed.
XAER_RMFAIL	It occurs when RM can not be used.
XAER_RMERR	RM can not perform the operation in a transaction branch due to lack of resources.
XAER_INVAL	It occurs when passing the abnormal argument.

xa_start

It creates a new transaction branch or starts the existing transaction branch.

```
int xa_start(
    XID *  xid,
    int   rmid,
    long  flags );
```

Arguments

xid

[Input] It is the transaction ID to be started.

rmid

[Input] It is the unique ID of RM to be connected. The argument is ignored.

flags

[Input] It is the start flag.

flags can use the following values.

- **TMASYNC**: It starts a transaction branch in asynchronous mode. (It is not supported.)
- **TMNOFLAGS**: FLAG is not used and the appropriate flag should be specified if flag is not used.
- **TMNOWAIT**: If the specified transaction branch is used by another session, XA_RETRY error is returned without waiting.
- **TMRESUME**: The previously suspended transaction branch is continued. It can not be used with TMJOIN.
- **TMJOIN**: It is connected to an existing transaction branch. It can not be used with TMRESUME.

Diagnosis

Return value	Description
XA_OK	The operation is normally performed.
XAER_RMFAIL	It occurs when the session in use is abnormally terminated.
XAER_RMERR	RM can not perform the operation in a transaction branch due to lack of resources.
XAER_PROTO	It occurs when the execution order does not fit into XA protocol.
XAER_INVAL	It occurs when passing the abnormal argument.
XAER_DUPID	The transaction branch with the same XID already exists.
XAER_NOTA	The transaction branch specified as XID does not exist. It may occur when TMRESUME or TMJOIN is used.
XA_RETRY	It occurs when the specified transaction branch is already used by another session. It may occur when using TMNOWAIT.
XAER_OUTSIDE	The local transaction is already in progress in the session.

Return value	Description
XA_RBROLLBACK	The transaction branch is set to rollback-only.

xa_end

It terminates the transaction branch operation.

```
int xa_end(
    XID *  xid,
    int   rmid,
    long  flags );
```

Arguments

xid

[Input] It is the transaction ID to be terminated.

rmid

[Input] It is the unique ID of RM to be connected. The argument is ignored.

flags

[Input] It is the job termination flag.

flags can use the following values.

- **TMFAIL:** It indicates that the operation failed. It can not be used with TMSUSPEND or TMSUCCESS, and it changes the status of the transaction branch to rollback-only.
- **TMMIGRATE:** It is restarted in connection with another branch. (It is not supported.)
- **TMSUCCESS:** It indicates that the operation is successfully terminated. It can not be used with TMSUSPEND or TMFAIL.
- **TMSUSPEND:** The transaction branch is suspended and terminated.

Diagnosis

Return value	Description
XA_OK	The operation is normally performed.
XAER_RMFAIL	It occurs when the session in use is abnormally terminated.
XAER_RMERR	RM can not perform the operation in a transaction branch due to lack of resources.
XA_NOMIGRATE	MIGRATE flag is not supported.
XAER_PROTO	It occurs when the execution order does not fit into XA protocol.
XAER_INVALID	It occurs when passing the abnormal argument.
XAER_NOTA	The transaction branch specified as XID does not exist.

xa_prepare

It prepares to commit the transactions corresponding to XID. It is the first phase of Two-phase Commit Protocol (2PC).

```
int xa_prepare(
    XID * xid,
    int rmid,
    long flags );
```

Arguments

xid

[Input] It is the transaction ID to be prepared.

rmid

[Input] It is the unique ID of RM to be connected. The argument is ignored.

flags

[Input] It is the prepare flag. TMNOFLAGS should be set.

Diagnosis

Return value	Description
XA_OK	The operation is normally performed.
XAER_RMFAIL	It occurs when the session in use is abnormally terminated.
XAER_RMERR	RM can not perform the operation in a transaction branch due to lack of resources.
XA_PROTO	It occurs when the execution order does not fit into XA protocol.
XA_RDONLY	The transaction branch is the read-only transaction.
XAER_NOTA	The transaction branch specified as XID does not exist.
XA_RBROLLBACK	The transaction branch is set to rollback-only.

xa_commit

It commits the transactions corresponding to XID. It is the second phase of Two-phase Commit Protocol (2PC).

```
int xa_commit(
    XID * xid,
    int rmid,
    long flags );
```

Arguments

xid

[Input] It is the transaction ID to be committed.

rmid

[Input] It is the unique ID of RM to be connected. The argument is ignored.

flags

[Input] It is the commit flag.

flags can use the following values.

- **TMNOFLAGS**: It means that FLAG is not used, and if any flag is not used, the appropriate flag should be specified.
- **TMONEPHASE**: It performs One Phase Commit (1PC).

Diagnosis

Return value	Description
XA_OK	The operation is normally performed.
XAER_RMFAIL	It occurs when the session in use is abnormally terminated.
XAER_RMERR	RM can not perform the operation in a transaction branch due to lack of resources.
XA_PROTO	It occurs when the execution order does not fit into XA protocol.
XA_RDONLY	The transaction branch is the read-only transaction.
XAER_NOTA	The transaction branch specified as XID does not exist.
XA_RBROLLBACK	The transaction branch is set to rollback-only.

xa_rollback

It rolls back the transaction corresponding to XID.

```
int xa_rollback(  
    XID *  xid,  
    int   rmid,  
    long  flags );
```

Arguments

xid

[Input] It is the transaction ID to be rolled back.

rmid

[Input] It is the unique ID of RM to be connected. The argument is ignored.

flags

[Input] It is rollback flag. TMNOFLAGS should be set.

Diagnosis

Return value	Description
XA_OK	The operation is normally performed.
XAER_RMFAIL	It occurs when the session in use is abnormally terminated.
XAER_RMERR	RM can not perform the operation in a transaction branch due to lack of resources.
XA_HEURRB	The transaction branch is already rolled back heuristically. (heuristic rollback)
XA_HEURCOM	The transaction branch is already committed heuristically. (heuristic commit)
XAER_NOTA	The transaction branch specified as XID does not exist.

xa_recover

It gets a list of transactions which are heuristically committed or rolled back.

```
int xa_recover(
    XID * xids,
    long count,
    int rmid,
    long flags );
```

Arguments

xids

[Output] It is the list of transactions which are heuristically committed or rolled back.

count

[Input] It refers to the array size of xids.

rmid

[Input] It is the unique ID of RM to be connected. The argument is ignored.

flags

[Input] It is the recover flag.

flags can use the following values.

- TMSTARTSCAN: It starts to scan, or it starts again from the beginning.
- TMENDSCAN: It terminates the scan.
- TMNOFLAGS: If it is used after TMSTARTSCAN, the following list is obtained. XA_PROTO error occurs if TMNOFLAGS is used from the beginning.

Diagnosis

Return value	Description
>= 0	It is the number of returned XIDs. (The array size that is valid in xids.)
XAER_RMFAIL	It occurs when the session in use is abnormally terminated.
XAER_RMERR	RM can not perform the operation in a transaction branch due to lack of resources.
XA_PROTO	It occurs when the execution order does not fit into XA protocol.

xa_forget

It deletes the information about transactions which are heuristically committed or rolled back.

```
int xa_forget(
    XID *  xid,
    int   rmid,
    long  flags );
```

Arguments

xid

[Input] It is the transaction ID to be deleted.

rmid

[Input] It is the unique ID of RM to be connected. The argument is ignored.

flags

[Input] It is the delete flag. TMNOFLAGS should be set.

Diagnosis

Return value	Description
XA_OK	The operation is normally performed.
XAER_RMFAIL	It occurs when the session in use is abnormally terminated.
XAER_RMERR	RM can not perform the operation in a transaction branch due to lack of resources.
XAER_PROTO	It occurs when the execution order does not fit into XA protocol.
XAER_INVALID	It occurs when passing the abnormal argument.
XAER_NOTA	The transaction branch specified by XID does not exist.

Example

The following is a simple example of connecting to GOLDILOCKS and performing Two-phase Commit after inserting/ retrieving/ updating/ deleting the record. The complete code for the following example is in \$GOLDILOCKS_HOME/sample/ODBC/SAMPLE_XA.c.

1. SQLGetXaSwitch()
Obtain xa switch_t structure for using XA interface.
2. SQLAllocHandle()
Obtain ODBC environment handle.

- SQLSetEnvAttr sets attributes which govern aspects of environments.

```
GOLDILOCKS_SQL_TRY( SQLSetEnvAttr( sEnv,
                                SQL_ATTR_ODBC_VERSION,
                                (SQLPOINTER)SQL_OV_ODBC3,
                                0 ) );

if( (sXaSwitch->xa_open_entry)(
    "DSN=GOLDILOCKS;UID=test;PWD=test",
    0,
    TMNOFLAGS ) != XA_OK )
{
    GOLDILOCKS_SQL_THROW( GOLDILOCKS_FINISH_LABEL );
}

sState = 2;
sDbc = SQLGetXaConnectionHandle();
sXid.formatID = 0;
sXid.gtrid_length = 2;
sXid.bqual_length = 1;
memcpy( sXid.data,
        "100",
        sXid.gtrid_length + sXid.bqual_length );

if( (sXaSwitch->xa_start_entry)( &sXid, 0, TMNOFLAGS ) != XA_OK )
{
    GOLDILOCKS_SQL_THROW( GOLDILOCKS_FINISH_LABEL );
}
```

- If SQL_SUCCESS which is an insert function succeeds

```
GOLDILOCKS_SQL_TRY( testInsert( sDbc ) );
```

- If SQL_SUCCESS which is a select function succeeds

```
GOLDILOCKS_SQL_TRY( testSelect( sDbc ) );
```

- If SQL_SUCCESS which is an update function succeeds

```
GOLDILOCKS_SQL_TRY( testUpdate( sDbc ) );
```

- If SQL_SUCCESS which is a delete function succeeds

```

GOLDILOCKS_SQL_TRY( testDelete( sDbc ) );

    if( (sXaSwitch->xa_end_entry)( &sXid, 0, TMSUCCESS ) != XA_OK )
    {
        GOLDILOCKS_SQL_THROW( GOLDILOCKS_FINISH_LABEL );
    }

    if( (sXaSwitch->xa_prepare_entry)( &sXid, 0, TMNOFLAGS ) != XA_OK )
    {
        GOLDILOCKS_SQL_THROW( GOLDILOCKS_FINISH_LABEL );
    }

    if( (sXaSwitch->xa_commit_entry)( &sXid, 0, TMNOFLAGS ) != XA_OK )
    {
        GOLDILOCKS_SQL_THROW( GOLDILOCKS_FINISH_LABEL );
    }

    sState = 1;
    if( (sXaSwitch->xa_close_entry)( "", 0, TMNOFLAGS ) != XA_OK )
    {
        GOLDILOCKS_SQL_THROW( GOLDILOCKS_FINISH_LABEL );
    }
    sDbc = NULL;

```

- SQLFreeHandleEnv releases resources which are related to an environment.

```

sState = 0;
    GOLDILOCKS_SQL_TRY( SQLFreeHandle( SQL_HANDLE_ENV,
                                        sEnv ) );

    sEnv = NULL;
    return EXIT_SUCCESS;
GOLDILOCKS_FINISH;
    if( sDbc != NULL )
    {
        PrintDiagnosticRecord( SQL_HANDLE_DBC, sDbc );
    }
    if( sEnv != NULL )
    {
        PrintDiagnosticRecord( SQL_HANDLE_ENV, sEnv );
    }
    switch( sState )

```

```
{
```

- Case 2: SQLDisconnect closes the connection which is related to a specific connection handle.

```
(void)(sXaSwitch->xa_close_entry)( "", 0, TMNOFLAGS );
```

- Case 1: SQLFreeHandleEnv releases resources which are related to an environment.

```
(void)SQLFreeHandle( SQL_HANDLE_ENV, sEnv );  
    sEnv = NULL;  
    default:  
        break;  
}  
return EXIT_FAILURE;  
}
```

26.

JDBC

26.1 Overview of GOLDBLOCKS JDBC Driver

Concepts of GOLDBLOCKS JDBC Driver

GOLDBLOCKS provides GOLDBLOCKS JDBC driver (excluding some features) which complies with standard JDBC 4.0 based on TCP/IP connection. The user can use various transaction features and data query features by using GOLDBLOCKS JDBC driver and connecting to GOLDBLOCKS in Java program. GOLDBLOCKS JDBC driver is written and built based on JDK 1.6. Therefore, it supports JDBC 4.0 features. The driver can be used by adding `$GOLDBLOCKS_HOME/lib/goldlocks6.jar` file to the class path.

For a user who uses the lower versions of Java (JDK 1.4, JDK 1.5), `goldlocks4` and `goldlocks5.jar` which are the implementation of JDBC 3.0 are also supported. The number after `goldlocks` refers to the JDK version. For more information, refer to **Supporting Versions**.

GOLDBLOCKS JDBC complies with most of JDBC standard specifications, and it also supports non-standard API methods and classes to provide some unique features. For more information about non-standard methods, refer to each class API of **JDBC API References** or **Using Other Data Types**.

Characteristics

- **Type-4 JDBC Driver**

GOLDBLOCKS JDBC is a JDBC Type-4 type which is implemented only with pure Java. A user can use a JDBC driver only with jar file without any additional libraries. Also, it is faster and reliable than JDBC-ODBC Bridge type, and it has better portability than Type-2 using Native API.

- **JDBC Standard Compliance**

GOLDBLOCKS JDBC can recycle most of other existing JDBC programs without changing because it complies with the JDBC standard. The connection, various statements and ResultSet features can be used without modifying. However, the connection URL and property name, the name of driver class to be loaded should be changed to suit GOLDBLOCKS. And the non-standard features and types are usable with the separate classes and methods API.

- **Supporting Various Java Versions**

GOLDBLOCKS JDBC driver supports four files such as `goldlocks7.jar`, `goldlocks6.jar`, `goldlocks5.jar`, `goldlocks4.jar`, so that a user can select and use the file appropriate for user's Java run-time environment. Because each jar file was built based on JDK 1.7, JDK 1.6, JDK 1.5, JDK 1.4, it complies with each JDBC 4.1, JD

BC 4.0, JDBC 3.0, JDBC 3.0 specifications.

- **Flexible Version Compatibility with the Server**

Refer to the protocol version for the compatibility with the server and the JDBC driver. If the protocol version of server is higher than that of the JDBC driver, it can be connected.

- **API Support for Connection Pooling**

JDBC connection object is a resource which is expensive to generate. Therefore, the JDBC standard define a pooling system for it, and ConnectionPoolDataSource and PooledConnection are its interfaces. GOLDILOCKS JDBC implements these interfaces and provides the pooling facility in third party middleware products.

- **Supporting XA API**

A user can perform the global transaction work by implementing XA interface which is the global transaction standard. And a user can perform the various XA features complying with a standard by using XAResource which is JDBC interface.

- **GOLDILOCKS-specific Data Type**

GOLDILOCKS uses the data types which are not provided by the JDBC standard. For example, they are Interval related type, the type with time zone information such as Timestamp with time zone, etc. The driver provides a way to obtain or insert these types to DB.

- **Server-based Powerful Cursor Scroll Feature**

Other JDBC drivers cache the row set in the driver for ResultSet scroll, so uses excessively memory of a client application program. For example, if the cursor is open by scroll insensitive and the rows are patched up to the last, all rows are cached in the driver, and the entire table resides in the client memory. It causes the out of memory error and the excessive use of client memory resource.

However, GOLDILOCKS supports the cursor scroll feature within the server, and clients may have lightweight, fast and reliable performance.

- **Efficient Use of Resources**

Because GOLDILOCKS minimizes the memory which maintains the row information compared to other JDBC drivers and it does not use Java objects as possible. It can avoid the excessive garbage collection, and perform fast and reliable table scanning with less memory.

- **Accurate and Extensive Metadata**

Because DatabaseMetaData interface of JDBC standard is faithfully and accurately implemented, it is easy to be linked with various DB tools. In addition, the usability is increased by retrieving DB meta information through various system views.

- **Powerful Logging**

Various logging features are provided to monitor the usual JDBC API calls and network usage as well as the problem. If the logging-related features are specified in the connection URL, a user can leave the content log to the console or files. Three types of logging exist, which are logging for JDBC method call recording, logging for protocol sending and receiving, logging for the SQL statement used.

- **Connection Failover**

Connection failover is supported on JDBC driver level to continuously use an existing connection by automatically reconnecting to the previously registered alternate server when the connection with the execution on GOLDILOCKS server fails or is disconnected. A user can use connection failover feature as an existing JDBC program without any exception handling in preparation for the broken connection.

- **Connectivity between server and direct attach**

Other than TCP/IP based connection, it can be connected with direct attach method interworking with a process as same as the server. Like as ODBC connection supports direct attach method and Client/Server method, GOLDILOCKS JDBC driver also provides both methods. JDBC program connected with direct attach does not communicate with TCP/IP, but it can use the server features in jvm by directly interworking with the server process. The performance is doubled or more than the JDBC program connected with TCP/IP.

Supporting Versions

GOLDILOCKS JDBC versions

GOLDILOCKS JDBC version information can be viewed when executing goldilocks6.jar file as follows.

```
shell>java -jar goldilocks6.jar
GOLDILOCKS JDBC Driver 1.0 Protocol-1.3.1, JDBC4.0 compiled with JDK1.6
```

The examples above describe that current GOLDILOCKS JDBC Driver version is 1.0, and the protocol version is 1.3.1, and JDBC standard version is 4.0 and it is built in JDK 1.6. The driver version is displayed apart from GOLDILOCKS product version, and it goes up whenever the function is strengthened. For more information about JDBC driver version, refer to **getDriverMajorVersion**, **getDriverMinorVersion**, **getDriverVersion**

on of DatabaseMetaData.

Protocol version determines compatibility with the server, and the driver can interwork with the server if the protocol version is equal to or lower than the server protocol version. The server supports all clients API of the lower protocol version.

goldilocks6.jar was built in JDK 1.6 which complies with JDBC 4.0 standard. Therefore, if the user's java environment is higher than JDK 1.6, goldilocks6.jar is used. However, if Java JDK 1.7 or higher is used, goldilocks6.jar can be used but API or classes of JDBC 5.0 can not be used.

goldilocks5.jar or goldilocks4.jar should be used if Java of JDK 1.5 or 1.4 environment is used. Both of them comply with JDBC 3.0 standard.

Examples

Setting Class Path

CLASSPATH should be set to use GOLDBLOCKS JDBC driver.

```
export CLASSPATH=.:$GOLDBLOCKS_HOME/lib/goldilocks6.jar
```

Or, add a suitable jar file for the user's Java execution environment to the path.

Loading Driver Class

The driver class can be loaded as follows.

```
Class.forName("sunje.goldilocks.jdbc.GoldilocksDriver");
```

The example above is the conventional method of using JDBC, and it is the method of dynamically loading the driver class and registering in DriverManager and getting the connection. Nowadays, the way to get the connection through DataSource is used more. For more information, refer to the corresponding class in [JDBC API References](#).

Getting Connection

The following code is used to get the connection.

```
Connection con = DriverManager.getConnection(
    "jdbc:goldilocks://127.0.0.1:22581/test", "TEST", "test");
```

The connection URL should be started with "jdbc:goldilocks:" to use GOLDBLOCKS JDBC. The next is the I

IP address and port number of the server and "/test" which is the final part of URL is the DB name. The current GOLDILOCKS does not specifically check the DB name because it does not support multi DB. A user connected URL may be obtained again through `DatabaseMetaData.getURL()`.

It connects in Direct Attach (D/A) mode when setting IP to 0.0.0.0, and a port to 0. Or, the connecting protocol, *da*, can be used instead of ip:port. In other words, both of the following two URL enables connecting in D/A mode.

```
"jdbc:goldilocks://0.0.0.0:0/test"  
"jdbc:goldilocks:da/test"
```

Username and password should respectively use the account and password for DB.

Using Statement and ResultSet

Statement and ResultSet are used in the same way as other JDBC programs.

```
Statement stmt = con.createStatement();  
ResultSet rs = stmt.executeQuery("SELECT NAME, ADDRESS FROM EMP");  
while (rs.next())  
{  
    System.out.println("name = " + rs.getString(1));  
    System.out.println("address = " + rs.getString(2));  
}  
rs.close();  
stmt.close();
```

26.2 Feature Specification

Connection

Connection Using DriverManager

The traditional way to get a connection is to use DriverManager.

```
Connection con = DriverManager.getConnection(url_string, user_name, password);
```

url_string has the following three types.

```
jdbc:goldilocks://[ip address]:[port_no]/[db_name]
```

```
jdbc:goldilocks:da/[db_name]
```

```
jdbc:goldilocks:locator//[ip address]:[port_no][, [ip address]:[port_no] ]*/[db_name]
```

Both of IPv4, IPv6 are available for IP address, and port_no refers to the port number set. db_name is not used for the current connection so it can have any name. However, it can not be omitted. The following is an example of URL.

```
String url_string = "jdbc:goldilocks://127.0.0.1:22581/test";
```

IP "0.0.0.0" and port 0 are used as a special address for D/A connection. For more information about D/A mode, refer to **Connecting in Direct Attach Mode**.

user_name and password refer to GOLDILOCKS account.

The following method is used for various property settings except for the getConnection() method above.

```
Properties prop = new Properties();
prop.setProperty("user", user_name);
prop.setProperty("password", password);
Connection con = DriverManager.getConnection(url_string, prop);
```

A locator keyword can be added to url_string to obtain the server connection information from glocator instead of using the connection property. In this case, ip address and port_no is considered as the connection information of glocator.

The following is an example of using the locator keyword to the connection statement.

```
String url_string =
"jdbc:goldilocks:locator//127.0.0.1:42581,127.0.0.1:42582/test?locator_service=S1";
```

The first connection information (127.0.0.1:42581) is the connection information of glocator, and the later connection information is processed as ALTERNATE_LOCATORS property such as 127.0.0.1:42582.

The following is the property setting which has the meaning as same as the url_string above.

```
String url_strng = "jdbc:goldilocks://0.0.0.0:0/test";
Properties prop = new Properties();
prop.setProperty("locator_host", "127.0.0.1");
prop.setProperty("locator_port", "42581");
prop.setProperty("alternate_locators", "127.0.0.1:42582");
prop.setProperty("locator_service", "S1");
Connection con = DriverManager.getConnection(url_string, prop);
```

The property list which can be used for the connection is known through getPropertyInfo() method of GoldilocksDriver. For more information, refer to **Table 26-1 Connection property**.

The login timeout of the connection object which is created by DriverManager and the logger uses the value registered in DriverManager. The logger is used by all JDBC interfaces generated from the connection object. Each connection object is not allowed to have an individual logger.

Connection Using DataSource

The JDBC standard recommends to use DataSource rather than the previous DriverManager. It is because DataSource is a single interface to access any data source, and it can individually set the values related to the various data sources, and may remotely send a DataSource object literally.

A connection object can be obtained through DataSource as follows.

```
import sunje.goldilocks.jdbc.GoldilocksDataSource;
GoldilocksDataSource ds = new GoldilocksDataSource();
ds.setServerName("127.0.0.1");
ds.setPortNumber(22581);
ds.setDatabaseName("test");
ds.setUser("TEST");
ds.setPassword("test");
Connection con = ds.getConnection();
```

GoldilocksDataSource classes should be used to create a DataSource object.

Then, various connection information should use setter method which is not DataSource standard API. For more information, refer to **DataSource**.

When using DriverManager, the login timeout and the logger should be globally set. However, when using DataSource, the login timeout and the logger can be individually set.

```
ds.setLoginTimeout(10);
ds.setLogWriter(out);
```

Interworking with Middleware

It is necessary to know the name of the class which implements XADataSource, ConnectionPoolDataSource interface to interwork with middleware such as Weblogic, JBoss, etc. GOLDLOCKS provides Goldilocks XADataSource, GoldilocksConnectionPoolDataSource for sunje.goldilocks.jdbc package. Both classes offer the various setter methods such as GoldilocksDataSource.

```
import sunje.goldilocks.jdbc.GoldilocksXADataSource;
GoldilocksXADataSource ds = new GoldilocksXADataSource();
ds.setServerName("127.0.0.1");
ds.setPortNumber(22581);
ds.setDatabaseName("test");
ds.setUser("TEST");
ds.setPassword("test");
XAConnection con = ds.getXAConnection();
```

Connection Property

Table 26-1 Connection property

Name	Mandatory/optional	Valid value	Description
alternate_servers	Optional	IP:PORT[,IP:PORT]+	It is the list of alternate servers for failover. It is delimited by comma (,).
batch_count	Optional	Any integer	It is the number of the batch jobs which can be processed in a single protocol transmission and reception. The default value is 1,000. If the value is too small, too much frequent network communication causes poor performance of the batch processing. If the value is too large, the server memory is increased because the session stacks the execution results.
connection_retry_count	Optional	Any integer	It stores the number of retries to connect. The default value is 0, then it does not retry to connect.
connection_retry_delay	Optional	Any integer	It stores the delay before the connection retry in seconds when trying to connect again. The default value is 3.
date_format	Optional	Any string	It is the character format which is used to interconvert between date and string inside the driver.

Name	Mandatory/optional	Valid value	Description
da_buffer_size	Optional	Any integer	It sets the size of a buffer which sends and receives data when fetching and binding while connected in direct attach mode. The default value is 100000.
decoding_replacement	Optional	Any string	It is the character replacing a byte value which can not be decoded when decoding a byte array into a string. The default value is ?.
failover_granularity	Optional	{"0", "1", "2"}	It determines whether failover is successful. non-atomic(0), atomic(1), 2 are not yet supported. When an error occurs for the existing prepared statements in the prepare process during failover, if it is 0, then it proceeds the failover, and if it is 1, it determines that the failover fails. The default value is 0.
failover_type	Optional	{"connection", "session"}	It determines the failover types. <ul style="list-style-type: none"> • Connection: Failover is used only when connecting to server. • Session: Failover is used when connecting to server as well as communicating with the server like execution. The default value is session.
format_grammar	Optional	{"db", "java"}	It determines whether the property string such as date_format is the GOLDLOCKS syntax or the syntax used in SimpleDateFormat of java. The default value is db.
global_logger	Optional	{"console"}	It specifies the logging target. Currently only console is available. Only the first specified one is valid.
home_dir	Optional	Any string	It specifies a home directory of a cluster server. The default value is null.
keep_alive	Optional	{"on", any}	It determines whether to set the keep_alive as the socket property of the connection. Using the property, the connection remains by periodically sending and receiving ack inside TCP socket. LAN cable error detection can forcibly cut off the connection.
locator_connection_timeout	Optional	Any integer	It is the time of waiting for receiving a packet from locator.
locator_file	Optional	Any string	It is a location file.
locator_host	Optional	IP address	It is host address of locator.
locator_port	Optional	Port no	It is port of locator.
locator_service	Optional	Any string	It is the service name to obtain the server connection information.
lzeros	Optional	Any integer	When a numeric is expressed as a string and the number of zeros following the decimal point exceeds this value, it is expressed in exponent notation. The default value is 15.
new_password	Optional	Any string	It can change the account password by using old_password pr

Name	Mandatory/optional	Valid value	Description
			operty together.
old_password	Optional	Any string	It can change the account password by using new_password property together.
packet_compression_threshold	Optional	Any integer	It compresses the communication data to be sent to the server when the data size is bigger than packet_compression_threshold. The property range is 32 ~ 2113929216.
password	Mandatory	Any string	It is user account password.
program	Optional	Any string	It is program description.
protocol_log	Optional	{"on", any}	It determines whether to log sending and receiving a protocol. The default value is "" (not).
query_log	Optional	{"on", any}	It determines whether to log a query. The default value is "" (not).
role	Optional	{"", "SYSDBA", "ADMIN"}	It specifies the account role. The default value is "".
session_type	Optional	{"1", "2", "3"} or {"dedicate", "shared", "default"} }	It is one of dedicated/ shared/ default. (It is selected by DB when it is set to default.)
time_format	Optional	Any string	It is the character format which is used to interconvert between time and string inside the driver.
timestamp_format	Optional	Any string	It is the character format which is used to interconvert between timestamp and string inside the driver.
timetz_format	Optional	Any string	It is the character format which is used to interconvert between time with timezone and string inside the driver.
timestamptz_format	Optional	Any string	It is the character format which is used to interconvert between timestamp with timezone and string inside the driver.
trace_log	Optional	{"on", any}	It determines whether to log the trace. The default value is "" (not).
tzeros	Optional	Any integer	When a numeric is expressed as a string and the number of zeros in digit goes beyond this value, it is expressed in exponent notation. The default value is 15.
user	Mandatory	Any string	It is user account name.
use_targettype	Optional	{"0", "1", "2"}	It is the information which is to be received together when receiving a column type through communication. <ul style="list-style-type: none"> • 0: none • 1: name • 2: all



- locator_file is applied prior to locator_host and locator_port. For more information about locator_file, refer to **Location File**.
- locator_service property enables the access to the server belonging to locator_service. For more information, refer to **glocator** and **gloctl**.

Data Manipulation

Data Manipulation Using Statement

Various SQL statements can be executed by using statement objects. Statement object can be obtained from the connection object as follows.

```
Connection con = DriverManager.getConnection(...);
Statement stmt = con.createStatement();
```

Various DML or DDL statements can be executed by using the execute method of the created statement object, and the executeUpdate method.

```
stmt.executeUpdate("create table emp ( id varchar(20), name varchar(30), age integer )");
stmt.executeUpdate("insert into emp values ('1234560000', 'Yuna', 24)");
int updated = stmt.executeUpdate("delete from emp where age > " + age);
```

The difference between execute and executeUpdate methods is only the return values. The execute method indicates whether the executed SQL statement returns ResultSet. The executeUpdate method returns the number of updated rows. The execute method can be used for both of DML and SELECT statements, but it throws SQLException if the executeUpdate method is used for SELECT statement.



Direct-execution refers to execution of SQL statement by using statement. It is the method of performing the prepare operation (parsing, validation, optimization) and execution for the SQL statement at a time. On the other hand, prepare-execution refers to the method of preparing the operation, then repeating the execution. Direct-execution repeatedly performs prepare and execution operation every time it is performed, so prepare-execution is more efficient when repeatedly performing the SQL statement.

Data Manipulation Using PreparedStatement

The JDBC standard provides PreparedStatement interface which can use a parameter for data manipulation, and it enables a user to run it more efficiently. In addition, PreparedStatement quickly perform the re

peated operation of the SQL statement because performs the prepare operation for the SQL statement only once.

```

Connection con = DriverManager.getConnection(...);
PreparedStatement pstmt = con.prepareStatement(
    "insert into emp values (?, ?, ?)");
pstmt.setString(1, "55544123000");
pstmt.setString(2, "Gildong");
pstmt.setInt(3, 32);
pstmt.executeUpdate();
pstmt.setString(1, "1357924680");
pstmt.setString(2, "Dooli");
pstmt.setInt(3, 41);
pstmt.executeUpdate();

```

After preparing the SQL statement as shown in the lines 2-3, the data is bound and performed. Prepared Statement which is prepared once, can bind and execute repeatedly.

If the binding is omitted and execute() is performed, the previously bound values are used.

```

pstmt.setString(1, "333555777000");
pstmt.setString(2, "Kang");
pstmt.setInt(3, 55);
pstmt.executeUpdate();
pstmt.setString(1, "245778884440");
pstmt.executeUpdate();

```

When the value is not bound to the second, third parameters as shown in line 6 but immediately executed, the value, "Kang" and 55, which was previously bound, is used. If the previously bound value does not exist, it throws SQLException.

All bound values are deleted by using clearParameters().

```

pstmt.setString(1, "333555777000");
pstmt.setString(2, "Kang");
pstmt.setInt(3, 55);
pstmt.executeUpdate();
pstmt.clearParameters();
pstmt.setString(1, "245778884440");
pstmt.executeUpdate();

```

After deleting parameters in line 5, if the value is bound only to the first parameter and executed (line 7), then it throws SQLException.

The main reason to use `PreparedStatement` is because it can bind the data of various types. It is inconvenient to handle the data of the type such as binary or timestamp because the value can be expressed only in the character string when using `Statement`. Therefore, it is more convenient to bind all types by using `PreparedStatement`.

```
pstmt.setTimestamp(1,
    new Timestamp(Calendar.getInstance().getTimeInMillis()));
pstmt.setCharacterStream(2, new StringReader(BIG_STRING));
pstmt.setObject(3, someObj, Types.LONGVARCHAR);
pstmt.setObject(4, otherObj);
```

In the sample above, lines 1 ~ 2 binds `java.sql.Timestamp` object. The binding type (It is `GOLDILOCKS` type of the data when the data is sent to the server) is `TIMESTAMP`. For more information about the binding type which is determined by the various setter methods, refer to the corresponding API of **PreparedStatement**.

Line 3 binds a reader object, and it is bound as `LONG VARCHAR` type internally.

Line 4 binds the object of Java object type, and explicitly notifies that the type is `LONG VARCHAR`. For more information about `GOLDILOCKS` type which is mapped to the type of `Types`, refer to **Table 26-3 SQL types → GOLDILOCKS types**.

Line 5 literally binds the Java object type, and it is bound to the corresponding `GOLDILOCKS` data type according to the class type. For more information about mapping between class types and `GOLDILOCKS` data types, refer to **Table 26-2 Java objects → GOLDILOCKS types**.

Batch Execution Using Statement

The different SQL statements can be executed as the batch job by using `addBatch()` and `executeBatch()` of `Statement`.

```
stmt.addBatch("insert into emp values ("12345", "Jake", 22)");
stmt.addBatch("insert into salary values ("12345", 5000)");
stmt.addBatch("update members set total_count=total_count+1 where age=22");
stmt.executeBatch();
```

Likewise, different SQL statements may be performed through a single `executeBatch()` method. However, this does not mean that the method call executes three statements in the server, gathers the results, sends the results to the JDBC driver with a single protocol. Internally, three times of protocol transmission, execution in the server and result transmission are performed. In other words, it does not have a big performance advantage.

After performing `executeBatch()`, all registered jobs are deleted.

Even if an error occurs during execution, all registered jobs are performed until it is completed. Whether an error occurs or not can be known by the value of the returned `int []` type. In other words, if `int []` has `EXECUTE_FAILED` value, it means that the job is failed.

Batch Execution Using PreparedStatement

More powerful batch operation can be performed by using `addBatch()` and `executeBatch()` methods of `PreparedStatement`.

```
PreparedStatement pstmt = con.prepareStatement("insert into emp values (?, ?, ?)");
pstmt.setString(1, "12345000");
pstmt.setString(2, "John");
pstmt.setInt(3, 33);
pstmt.addBatch();
pstmt.setString(1, "222333555");
pstmt.setString(2, "Henry");
pstmt.setInt(3, 24);
pstmt.addBatch();
int[] inserted = pstmt.executeBatch();
```

The example above is a process of inserting two rows. The values configuring the two rows are bound through `addBatch()`, and then if `executeBatch()` is called, the bound value and the protocol for execution are sent to the server and executed. It is more efficient than the batch execution of `Statement` and the performance is faster because communication occurs only when `executeBatch()` is called.

The new value should be bound to execute `executeBatch()` again because the bound values are deleted after executing `executeBatch()`. `clearBatch()` does not have to be explicitly called to delete the registered job after execution.

Even if an error occurs during execution, all registered jobs are performed until it is completed. Whether an error occurs or not can be known by the value of the returned `int []` type. In other words, if `int []` has `EXECUTE_FAILED` value, it means that the job is failed.

`GOLDILOCKS JDBC` provides a separate method which is `executeBatchAtomic()` in addition to `executeBatch()`. `executeBatch()` performs the execution as many as the number of the registered jobs in the server, but the response time is fast because `executeBatchAtomic()` performs the execution at once with the registered job (the bound values). However, if any one fails, everything fails as it can be seen from the name which is atomic. Therefore, the return type is not `int[]`, but `int`.

```
...
int inserted = ((GoldilocksPreparedStatement)pstmt).executeBatchAtomic();
```

Data Retrieval

Getting Column Values

The data can be retrieved through ResultSet object which is obtained by executeQuery () of the Statement or PreparedStatement.

```
...
ResultSet rs = pstmt.executeQuery();
while(rs.next())
{
    String id = rs.getString(1);
    String name = rs.getString(2);
    int age = rs.getInt(3);
    ...
}
```

The contents of the column can be obtained through various getter methods in the ResultSet after retrieving the data in the table. The data in the table is sent to JDBC drivers in the original form of GOLDILOCKS data type, and it is converted to an appropriate Java data type according to the types of getter methods called by a user and it is transmitted to the user. For more information about type conversion mapping of GOLDILOCKS data type and getter method, refer to **Table 26-4 Whether supporting getter method for GOLDILOCKS type - 1**.

If GOLDILOCKS data type can not be converted to the type of getter, it throws SQLException.

Closing ResultSet

The ResultSet which is used up can release the resources through close(). Even if a user does not explicitly call close(), the followings bring the result as same as when calling close() of ResultSet.

- When superordinate statement is closed
- When superordinate connection is closed
- When executeQuery() of Statement is called again
- When an error occurs during fetching

The two ResultSets which are created from a single statement can not be remained simultaneously in the third case above. Only the ResultSet object which is created by the last executeQuery() is valid.

Fetch Size

JDBC can specify the number of rows fetched at once from the server through `setFetchSize(int rows)` of `Statement`. The default value of the `ResultSet` property of `GOLDILOCKS` is 0. 0 automatically determines the number of rows fetched by the server. For forward only, it is the maximum number of rows fetched in a communication packet. For scrollable, it is fixed to 100. If the value is too large, the amount of memory used by JDBC `ResultSet` becomes large. If the value is too small, the communication is frequently executed.

The value is mainly used in a scrollable `ResultSet` because it is not sensitive even when it is scroll sensitive while moving within the row cache of `ResultSet`. If the value is set too large, the latest information about the changes of rows can not be known.

Field Size Limit

JDBC may limit the maximum length of the column through `setMaxFieldSize(int size)` of `Statement`. The maximum length can be limited for the types of `CHAR`, `VARCHAR`, `LONG VARCHAR`, `BINARY`, `VARBINARY`, and `LONG VARBINARY`. The data bigger than the length is truncated. The default value is 0, and the maximum length is not limited in this case.

This property is ignored for other types such as `INTEGER`, `DATE`, etc..

ResultSet Scroll

Getting Scrollable ResultSet

There are two kinds of scrollable `ResultSet`, which are scroll sensitive and scroll insensitive. Scroll sensitive is the cursor type which can view the values changed by the transaction itself or other transaction while traversing the `ResultSet`, but scroll insensitive is not. `GOLDILOCKS` server supports both of the scroll types, and those facilities can be used by JDBC.

```
Statement stmt = con.createStatement(ResultSet.TYPE_SCROLL_SENSITIVE,
                                     ResultSet.CONCUR_READ_ONLY);
ResultSet rs = stmt.executeQuery("select id, name, age from emp");
```

If the `ResultSet` type is `TYPE_SCROLL_INSENSITIVE` when creating statement as line 1, `ResultSet` which is created from the statement object is scroll sensitive cursor. However, the current `GOLDILOCKS` does not support the updatable `ResultSet`.

The type should be set to `TYPE_SCROLL_INSENSITIVE` to obtain scroll insensitive `ResultSet`. The default value is `TYPE_FORWARD_ONLY`.

However, even it is a scroll sensitive `ResultSet`, a user can not know the latest value or whether it is chang

ed, when moving within the row cache of ResultSet. The row should be fetched again from the server to find out the latest value or whether it is changed.

Scrolling

JDBC API provides the following methods to scroll the cursor.

```
public boolean next() throws SQLException;
public boolean previous() throws SQLException;
public boolean first() throws SQLException;
public boolean last() throws SQLException;
public boolean absolute(int rows) throws SQLException;
public boolean relative(int rows) throws SQLException;
public void beforeFirst() throws SQLException;
public void afterLast() throws SQLException;
```

`next()` is the method which can be used for forward only or scrollable ResultSet, and it sets the cursor position to the next row. If the row can be read at the moved position, it is true. Otherwise, it is false. Other methods can be used only for scrollable ResultSet.

`previous()` moves the cursor to the previous row, `first()` moves the cursor to the first row, `last()` moves the cursor to the last row, `absolute()` moves the cursor to the absolute position and `relative()` moves the cursor to the relative position from the current position. `beforeFirst()` moves the cursor to before the first row. `afterLast()` moves the cursor to after the last row.

```
rs.afterLast();
while (rs.previous())
{
    String id = rs.getString(1);
    String name = rs.getString(2);
    int age = rs.getInt(3);
    ...
}
```

The code above will query backwards from the last row to the first row.

The current cursor position can be known by the following method.

```
public int getRow() throws SQLException;
```

Scrolling Principle

The ResultSet scroll is easy to use, but it may cause poor performance without knowing internal operating principles. Scrolling is performed in result cache within ResultSet of JDBC driver, but it is performed on the server in case when the range exceeds the cache, so the communication may occur. Therefore, it should be used carefully to prevent the poor performance.

The internal default value of the fetch size of scrollable ResultSet is 100 (the external default value is 0 and it can be changed through setFetchSize() method). It means that the number of rows that are fetched to JDBC driver at once are 100. The row cache of ResultSet consists of 100 rows, and the cursor position of ResultSet should be changed if the row position to be moved is in the cache. However, if it is not in the cache, the row at the position where to be moved should be got from the server. At this time, it is necessary to know how to get the row set including the row to be moved.

For example, if the ResultSet has rows from 1 to 100 and the current cursor position is at 100, calling next() will fetch rows 101 through 200 from the server because the next row does not exist in the cache. On the other hand, the rows from 101 to 200 are in ResultSet cache, and it is not appropriate to fetch rows from 100 to 199 from the server by calling previous() if the current cursor position is 101 row. When this approach is used, row should be fetched from the server whenever previous() is called. However, GOLDILOCKS fetches the rowset which includes the corresponding last row from the server when it is required to fetch the row from the server due to calling previous() to prevent this inefficiency. For example, when it is necessary to fetch row of the number 100 by calling previous(), GOLDILOCKS fetches the rows from 1 to 100. Then it is fetched in favor of previous().

The rule is generalized as follows.

- If the position to be moved is after the current position, 100 rows (the fetch size) after that position are fetched.
- If the position to be moved is before the current position, 100 rows before that position are fetched.
- When moved with first(), the first 100 rows are fetched.
- When moved with last(), the last 100 rows are fetched.

When moved backward, the fetch is performed in favor of next(). When moved forward, the fetch is performed in favor of previous(). This is also applied to absolute() and relative().

Using Other Data Types

Interval Type

GOLDILOCKS supports the following 13 types related to interval.

- interval year

- interval month
- interval year to month
- interval day
- interval hour
- interval minute
- interval second
- interval minute to second
- interval hour to minute
- interval hour to second
- interval day to hour
- interval day to minute
- interval day to second

`sunje.goldilocks.jdbc.GoldilocksInterval` object is created and the insert operation is executed by `setObject()` of `PreparedStatement` to insert the interval data into a table using JDBC.

`GoldilocksInterval` object can be created by using `createIntervalXXX` which is the static method of `GoldilocksInterval`.

```
import sunje.goldilocks.jdbc.GoldilocksInterval;
...
GoldilocksInterval interval = GoldilocksInterval.createIntervalDayToSecond(2, 6, "2
08:23:54.560843");
PreparedStatement pstmt = con.prepareStatement("insert into interval_table values (?,?)");
pstmt.setString(1, someId);
pstmt.setObject(2, interval);
pstmt.executeUpdate();
```

For more information about `createIntervalXXX` method, refer to **`GoldilocksInterval`**. Likewise, `GoldilocksInterval` is created and it is bound via `setObject`. Or, a type is explicitly specified as follows.

```
import sunje.goldilocks.jdbc.GoldilocksTypes;
...
pstmt.setObject(2, interval, GoldilocksTypes.INTERVAL_DAY_TO_SECOND);
```

The data may be inserted by using a character string without `GoldilocksInterval` object.

```
pstmt.setObject(2, "2 08:23:54.560843", GoldilocksTypes.INTERVAL_DAY_TO_SECOND);
```

In this case, a `GoldilocksInterval` object is created within JDBC driver and bound to a host variable. Or it may be bound as a string by using `setString()` method.

```
pstmt.setString(2, "2 08:23:54.560843");
```

The string is literally sent to the server when using this method, and the string is converted to Interval day to second type and inserted in the server.

getObject() or getString() of ResultSet queries the Interval type from the DB.

```
import sunje.goldilocks.jdbc.GoldilocksInterval;
ResultSet rs = stmt.executeQuery("select interval_value from some_table");
while (rs.next())
{
    GoldilocksInterval interval = (GoldilocksInterval)rs.getObject(1);
    System.out.println("type = " + interval.getTypeName() +
        ", value = " + interval.toString());
}
```

The data of GoldilocksInterval type can be retrieved via getObject() of ResultSet. GoldilocksInterval class provides getter like getYear(), getHour(), etc. that return various time data. For more information about getter API, refer to **GoldilocksInterval**.

Time with Time Zone and Timestamp with Time Zone Types

Concerning time, GOLDILOCKS provides not only SQL standard types such as Date, Time, Timestamp but also Time with time zone and Timestamp with time zone types.

```
CREATE TABLE SAMPLE_TABLE ( C1 TIME WITH TIME ZONE,
                             C2 TIMESTAMP WITH TIME ZONE );
```

GOLDILOCKS JDBC provides setTimeTimeZone(int colIndex, Time time, Calendar timezone) method and setTimestampTimeZone(int colIndex, Timestamp time, Calendar timezone) method in GoldilocksPreparedStatement class to insert the data of Time with time zone and Timestamp with time zone types. For more information about specifications refer to **setTimeTimeZone** and **setTimestampTimeZone**.

The data can be inserted via existing setTime() and setTimestamp() methods, but the time zone value of the column is unconditionally set to the local time zone of Java execution environment. Therefore, setTimeTimeZone() or setTimestampTimeZone should be used to insert various time zone information.

Time, Timestamp data can be inserted with the given time zone value via setTimeTimeZone and setTimestampTimeZone.

```
import sunje.goldilocks.jdbc.GoldilocksPreparedStatement;
PreparedStatement pstmt = con.prepareStatement(
    "INSERT INTO SAMPLE_TABLE VALUES (?, ?, ?, ?)");
```

```

Calendar now = Calendar.getInstance();
Calendar usNow = Calendar.getInstance(TimeZone.getTimeZone("GMT-8"));
Time t = new Time(now.getTimeInMillis());
Timestamp ts = new Timestamp(now.getTimeInMillis());
pstmt.setTime(1, t);
pstmt.setTimestamp(2, ts);
pstmt.executeUpdate();
((GoldilocksPreparedStatement)pstmt).setTimeTimeZone(1, t, now);
((GoldilocksPreparedStatement)pstmt).setTimestampTimeZone(2, ts, now);
pstmt.executeUpdate();
((GoldilocksPreparedStatement)pstmt).setTimeTimeZone(1, t, usNow);
((GoldilocksPreparedStatement)pstmt).setTimestampTimeZone(2, ts, usNow);
pstmt.executeUpdate();

```

Line 11, 12 binds the column to time type and timestamp type. Each value of t and ts is sent to the server and the default time zone value is inserted to DB column in the server.

On the other hand, line 15, 16 binds the column to time with time zone type and timestamp with time zone type, and is sent to the server together with time zone information. As a result, if the time zone settings of a server and a client are same, the rows which are inserted by lines 11~13 and 15~17 are same.

Line 19, 20 inserts time zone information of GMT-8 time zone.

There are two ways to query data, which are time with time zone and timestamp with time zone. One is the way to get data as char from the server, and the other is the way to get data of the corresponding type by JDBC and to obtain as time or as timestamp object.

```

ResultSet rs = stmt.executeQuery("select c1, cast(c1 as char(33)), c2, cast(c2 as char(33))
from sample_table");
while (rs.next())
{
    System.out.println("c1 = " + rs.getTime(1).toString());
    System.out.println("c1 as char = " + rs.getString(2));
    System.out.println("c2 = " + rs.getTimestamp(3).toString());
    System.out.println("c2 as char = " + rs.getString(4));
}

```

When executing the code above, the results are as follows.

```

c1 = 12:35:26
c1 as char = 12:35:26.052000 +09:00
c2 = 2014-03-27 12:35:26.052
c2 as char = 2014-03-27 12:35:26.052000 +09:00

```



```

c1 = 12:35:26
c1 as char = 12:35:26.052000 +09:00
c2 = 2014-03-27 12:35:26.052
c2 as char = 2014-03-27 12:35:26.052000 +09:00
c1 = 12:35:26
c1 as char = 19:35:26.052000 -08:00
c2 = 2014-03-27 12:35:26.052
c2 as char = 2014-03-26 19:35:26.052000 -08:00

```

Logging

Logging Types

When developing a project by using JDBC, it is helpful in many ways for JDBC driver to leave various logs. GOLDILOCKS provides the facility to log the useful information even during operation, as well as the project development.

There are three types of log, which are trace log, protocol log and query log.

Trace log leaves information every time when JDBC API is called. It can be known which JDBC API is called. Protocol log shows the situation to send and receive communication packets between JDBC driver and GOLDILOCKS server. Query log records the SQL statement to be executed, when PreparedStatement or Statement is executed.

Logging by Using DriverManager

First, the logging is left by using DriverManager. The logging media can be determined by using `setLogWriter()` method in DriverManager, and the type of logging to be left can be specified in connection url.

```

DriverManager.setLogWriter(new PrintWriter(System.out));
String url = "jdbc:goldilocks://localhost:22581/test?trace_log=on&query_log=on";
Connection con = DriverManager.getConnection(url, "TEST", "test");

```

Line 1 defines the logging media. All logging is output to the console. Line 2 defines the connection url, and the property can be defined after `?` character. It means to using `trace_log`, `query_log`.

Likewise, these properties can be specified in URL, or they can be defined with properties object.

```

Properties prop = new Properties();
prop.put("trace_log", "on");
prop.put("query_log", "on");

```

```
prop.put("protocol_log", "on");
prop.put("user", "TEST");
prop.put("password", test");
Connection con = DriverManager.getConnection(url, prop);
```

The connection properties which can be used in GOLDDLOCKS are defined in **Table 26-1 Connection property**.

Sometimes it is difficult to call `setLogWriter()` of `DriverManager`. When using the middleware, the code like that can not be added. For such a case, GOLDDLOCKS JDBC provides a global property called `global_logger`. Other general properties are limited to a single connection, but this property is global. In other words, if the property is set, it does not have to call `DriverManager.setLogWriter()`.

```
String url = "jdbc:goldilocks://localhost:22581/test?" +
            "global_logger=console&trace_log=on&query_log=on";
Connection con = DriverManager.getConnection(url, "TEST", "test");
```

`global_logger` property is applied only once initially, and it is ignored if log writer is already set in `DriverManager`. Only the current console is applicable as the property value. Other value does not cause any operation.

Logging by Using DataSource

Unlike `DriverManager`, `DataSource` can set the log writer by each object. If the log writer is set for a `DataSource` object, all connections which are generated from the `DataSource` are logged by the log writer. The following describes how to set the logging in the `DataSource`.

```
import sunje.goldilocks.jdbc.GoldilocksDataSource;
...
GoldilocksDataSource ds = new sunje.goldilocks.jdbc.GoldilocksDataSource();
ds.setServerName("localhost");
ds.setDatabaseName("test");
ds.setUser("TEST");
ds.setPassword("test");
ds.setPortNumber(22581);
ds.setLogTarget("console");
ds.setTraceLog("on");
ds.setQueryLog("on");
ds.setProtocolLog("on");
Connection con = ds.getConnection();
```

Likewise, the logging feature is set by using `setLogTarget()`, `setTraceLog()`, `setQueryLog()` and `setProtocol`

Log() methods. `setLogWriter()` of `DataSource` can be called instead of `setLogTarget()`. When using the middleware, the method such as `setLogWriter()` can not be directly called, so it should be controlled with the `property`. In this case, if `logTarget`, `traceLog`, `queryLog` and `protocolLog` properties are defined, the middleware automatically calls the methods.

Viewing Plan Text

Usage

The plan text can be obtained by using GOLDILOCKS JDBC like as the plan text of the executed statement is obtained by using GOLDILOCKS ODBC. It can be configured to generate a plan text by using non-standard API method in `GoldilocksStatement` class, or obtain the plan text which is already generated.

```
Connection con = ...
GoldilocksStatement stmt = (GoldilocksStatement)con.createStatement();
stmt.setExplainPlanOption(GoldilocksStatement.EXPLAIN_PLAN_OPTION_ON);
ResultSet rs = stmt.executeQuery("select * from t1");
System.out.println(stmt.getExplainPlan());
```

For example, when querying a simple table, the plan text is output as follows.

```
< Execution Plan >
=====
|  IDX  |  NODE DESCRIPTION          |  ROWS  |
-----
|   0   |  SELECT STATEMENT          |        |
|   1   |  TABLE ACCESS ("T1")      |        0 |
=====
1 - READ COLUMNS : A
```

Option Types

GOLDILOCKS provides the following four properties about the plan text generation.

- `EXPLAIN_PLAN_OPTION_OFF`: It does not generate the plan text as the default value of the property related to the plan text of statement.
- `EXPLAIN_PLAN_OPTION_ON`: It generates the plan text when executing or fetching.
- `EXPLAIN_PLAN_OPTION_ON_VERBOSE`: It generates more detailed plan text such as execution time when executing or fetching.
- `EXPLAIN_PLAN_OPTION_ONLY`: It generates the plan text like as `EXPLAIN_PLAN_OPTION_ON` when

executing or fetching but it is not actually executed.

These properties are set by using `GoldilocksStatement.setExplainPlanOption(int)` method, and the property which is set once is continuously maintained. A constant value of the property is defined in `GoldilocksStatement`.



The plan text for non-SELECT DML statements or other SQL statements is generated at run-time, but the plan text for the SELECT statements is generated when the SELECT statement is fetched and the cursor is positioned at the end in the server. The plan text should be obtained after all rows are traversed with `ResultSet` for the SELECT statement. The plan text can be obtained when there are few rows in a table because the cursor can traverse until the end in the server without fetching all rows.

Connection Failover

GOLDILOCKS supports the connection failover of the client level (JDBC, ODBC). The application which accesses with client/ server mode by using the JDBC or ODBC to GOLDILOCKS, may perform connection to the alternative server automatically when the connection fails or disconnected. This allows a user to use high availability applications which utilize multiple servers. In particular, when a user registers the main server URL and the alternative server URL through the connection property under interworking web server environment, it can safely use the connection object obtained from the connection pool without worrying about the interruption. Failover is performed entirely automatically inside the driver and the user does not need to worry about the reconnection logics.

`alternate_servers` property should be given to use failover. IP and port of the alternative server are given for this property, and it may indicate the multiple alternative servers by using the comma (,).

```
Class.forName("sunje.goldilocks.jdbc.GoldilocksDriver");
String url = "jdbc:goldilocks://192.168.0.101:22581/test";
Property prop = new Properties();
prop.setProperty("user", "TEST");
prop.setProperty("password", "test");
prop.setProperty("alternate_servers", "192.168.0.201:22581");
Connection con = DriverManager.getConnection(url, prop); ❶
Statement stmt = con.createStatement();
stmt.executeUpdate("insert into time_tab values (sysdate)"); ❷
...
```

For example, if ❶ fails to connect to the main server (192.168.0.101), it will automatically connect to an

alternative server (192.168.0.201) and returns a connection object. Any error is not returned to the user. If it can not communicate with the server because the connection is broken at ② during `executeUpdate()` or before then, it automatically connects to the alternative server inside the driver and continues to use the existing connection object and returns `SQLException`. Users can continue to use the existing connection object after processing `SQLException`.

Whether failover or not can be viewed through `getWarnings()` of connection object.

A failover feature of GOLDILOCKS JDBC is that a user can continue to use statement object or `PreparedStatement` object created from connection object. (`ResultSet` can not continue to be used.)

In particular, a user can continue to use the object because `PreparedStatements` perform the prepare operations internally again in the alternative server if a failover occurs.

```

Connection con = DriverManager.getConnection(url, prop);
PreparedStatement pstmt =
    con.prepareStatement("insert into t1 values (?,?)");
...
try
{
    pstmt.setInt(1, 100);
    pstmt.setString(2, "John");
    pstmt.executeUpdate();
}
catch (SQLException sException)
{
    if (sException.getErrorCode() == 21012)
    {

```

- Failover occurs due to the communication link failure error.
- A user can continue to use the `pstmt` object.

```

pstmt.executeUpdate();
}
else
{
    ...
}
}

```

GOLDILOCKS JDBC driver provides some properties related to failover. These can help a user to decide the failover type, connection order and simple policy used for failover.

failover_type

The property is used to select the failover type. In the example above, the failover at ① is the connection failover and the failover at ② is the session failover. If the property value is *connection*, only the connection failover is used, and if it is *session*, both of the connection failover and session failover can be used. The default value is *session*.

failover_granularity

When failover occurs, the prepare operation is performed after the PreparedStatement objects which are generated from the current connection object are connected to the alternative server. If the prepare operation fails in the alternative server (An error may occur due to the different server environment.), the property is used to determine whether to consider the failover failed or to ignore the prepare error. The property value is either 0 or 1. If the property value is 0, the prepare error is ignored and the failover continuously proceeds. If the property value is 1, the failover is failed. The default value is 0. If the value is 0 and the prepare operation is failed, PreparedStatement object can not continue to be used and the user should directly create the PreparedStatement object again.

Connecting in Direct Attach Mode

Since JDBC 1.1, Goldilocks provides the connection in direct attach mode (D/A mode) besides the existing connection in Client/ Server mode (C/S mode) based on TCP/ IP. Like as ODBC D/A connection mode, this is operated directly interworking with the server process. so the server module interworks within a single process (in a process same as jvm). Therefore, the remote host can not connect in D/A mode.

D/A mode is designed to utilize the merit of an in-memory DB GOLDILOCKS, which is a fast processing. TCP/ IP based connection offsets the fast processing of GOLDILOCKS by expensive cost, so an alternative method is required when a fast processing is required. Though it is restricted to be operated within the host which is same as the host of GOLDILOCKS server, this D/A mode connection is a good solution.

JDBC program connecting in D/A mode can directly call the server feature by loading GOLDILOCKS jni library when DB connection is created first within jvm. A server module can be directly called through native interface in jvm without network cost, it enables faster processing than the existing C/S mode.

Connecting Method

Use *0.0.0.0:0* instead of existing ip:port in the connection URL to connect in D/A mode. The existing URL can be literally used and using a special ip:port address (0.0.0.0:0) can minimize changing existing applications. Or, use a special protocol (*da*) to connect in D/A mode.

```
Connection con =  
    DriverManager.getConnection("jdbc:goldilocks://0.0.0.0:0/test", "TEST", "test");
```

or,

```
Connection con =  
    DriverManager.getConnection("jdbc:goldilocks:da/test", "TEST", "test");
```

Features of D/A Connection

GOLDILOCKS server module can be directly called in jvm when connecting in D/A mode. It is called through JNI (Java Native Interface) between JDBC program and GOLDILOCKS server module. It uses the server module with minimum call cost considering that it is expensive to call JNI, so it is faster double than the JDBC based on existing TCP/ IP.

When using the connection based on the existing TCP/ IP, it uses only goldilocks6.jar file. However, when using the connection based on D/A mode, it uses libgoldilocksjni.so file and libgoldilocksas.so file in \$GOLDILOCKS_HOME/lib by dynamically loading them. Therefore, an error occurs when connecting if those two library files do not exist. However, the location of the library files need not to be separately specified when operating java program. Because it searches for those two library files and loads them as long as it is in the directory as same as the directory of goldilocks6.jar file.

26.3 JDBC API References

Array

The class is not implemented.

free

| void free() throws SQLException

getArray

| Object getArray() throws SQLException

| Object getArray(Map<String,Class<?>> map) throws SQLException

| Object getArray(long index, int count) throws SQLException

| Object getArray(long index, int count, Map<String,Class<?>> map) throws SQLException

getBaseType

| int getBaseType() throws SQLException

getBaseTypeName

| String getBaseTypeName() throws SQLException

getResultSet

| ResultSet getResultSet() throws SQLException

| ResultSet getResultSet(Map<String,Class<?>> map) throws SQLException

| `ResultSet getResultSet(long index, int count)` throws `SQLException`

| `ResultSet getResultSet(long index, int count, Map<String,Class<?>> map)` throws `SQLException`

Blob

The class is not implemented.

free

| void free() throws SQLException

getBinaryStream

| InputStream getBinaryStream() throws SQLException

| InputStream getBinaryStream(long pos, long length) throws SQLException

getBytes

| byte[] getBytes(long pos, int length) throws SQLException

length

| long length() throws SQLException

position

| long position(byte[] pattern, long start) throws SQLException

| long position(Blob pattern, long start) throws SQLException

setBinaryStream

| OutputStream setBinaryStream(long pos) throws SQLException

setBytes

| `int setBytes(long pos, byte[] bytes) throws SQLException`

| `int setBytes(long pos, byte[] bytes, int offset, int len) throws SQLException`

truncate

| `void truncate(long len) throws SQLException`

CallableStatement

getArray

Array `getArray(int parameterIndex)` throws `SQLException`

- Operation: It does not support an array type.
- Exception: It always returns `SQLFeatureNotSupportedException`.

Array `getArray(String parameterName)` throws `SQLException`

- Operation: It does not support an array type.
- Exception: It always returns `SQLFeatureNotSupportedException`.

getBigDecimal

`BigDecimal getBigDecimal(int parameterIndex)` throws `SQLException`

- Operation: It obtains column data at `parameterIndex`-th position in `BigDecimal` type. For more information about whether it supports `GOLDILOCKS` types, refer to **Table 26-4 Whether supporting getter method for `GOLDILOCKS` type - 1**.
- Exception: If the `parameterIndex` is invalid, database is not accessible, or `CallableStatement` is already closed, then it throws `SQLException`.

`BigDecimal getBigDecimal(int parameterIndex, int scale)` throws `SQLException`

- Operation: It is not implemented. (It is a deprecated method.)
- Exception: It always throws `SQLFeatureNotSupportedException`.

`BigDecimal getBigDecimal(String parameterName)` throws `SQLException`

- Operation: It is not implemented.
- Exception: It always throws `SQLFeatureNotSupportedException`.

getBlob

`Blob getBlob(int parameterIndex)` throws `SQLException`

- Operation: It does not support blob type.
- Exception: It always returns `SQLFeatureNotSupportedException`.

`Blob getBlob(String parameterName)` throws `SQLException`

- Operation: It does not support blob type.
- Exception: It always returns `SQLFeatureNotSupportedException`.

getBoolean

`boolean getBoolean(int parameterIndex)` throws `SQLException`

- Operation: It obtains column data at `parameterIndex`-th position in boolean type. For more information about whether it supports GOLDILOCKS types, refer to **Table 26-4 Whether supporting getter method for GOLDILOCKS type - 1**.
- Exception: If the `parameterIndex` is invalid, database is not accessible, or `CallableStatement` is already closed, then it throws `SQLException`.

`boolean getBoolean(String parameterName)` throws `SQLException`

- Operation: It is not implemented.
- Exception: It always throws `SQLFeatureNotSupportedException`.

getBytes

`byte getByte(int parameterIndex)` throws `SQLException`

- Operation: It obtains column data at `parameterIndex`-th position in byte type. For more information about whether it supports GOLDILOCKS types, refer to **Table 26-4 Whether supporting getter method for GOLDILOCKS type - 1**.
- Exception: If the `parameterIndex` is invalid, database is not accessible, or `CallableStatement` is already closed, then it throws `SQLException`.

`byte getByte(String parameterName)` throws `SQLException`

- Operation: It is not implemented.
- Exception: It always throws `SQLFeatureNotSupportedException`.

getBytes

`byte[] getBytes(int parameterIndex)` throws `SQLException`

- Operation: It obtains column data at `parameterIndex`-th position in `byte[]` type. For more information about whether it supports GOLDILOCKS types, refer to **Table 26-4 Whether supporting getter metho**

d for GOLDILOCKS type - 1 .

- Exception: If the parameterIndex is invalid, database is not accessible, or CallableStatement is already closed, then it throws SQLException.

`byte[] getBytes(String parameterName)` throws SQLException

- Operation: It is not implemented.
- Exception: It always throws SQLFeatureNotSupportedException.

getCharacterStream

`Reader getCharacterStream(int parameterIndex)` throws SQLException

- Operation: It obtains column data at parameterIndex-th position in reader type. For more information about whether it supports GOLDILOCKS types, refer to **Table 26-4 Whether supporting getter method for GOLDILOCKS type - 1 .**
- Exception: If the parameterIndex is invalid, database is not accessible, or CallableStatement is already closed, then it throws SQLException.

`Reader getCharacterStream(String parameterName)` throws SQLException

- Operation: It is not implemented.
- Exception: It always throws SQLFeatureNotSupportedException.

getClob

`Clob getClob(int parameterIndex)` throws SQLException

- Operation: It does not support clob type.
- Exception: It always returns SQLFeatureNotSupportedException.

`Clob getClob(String parameterName)` throws SQLException

- Operation: It does not support clob type.
- Exception: It always returns SQLFeatureNotSupportedException.

getDate

`Date getDate(int parameterIndex)` throws SQLException

- Operation: It obtains column data at parameterIndex-th position in date type. For more information a

about whether it supports GOLDILOCKS types, refer to **Table 26-4 Whether supporting getter method for GOLDILOCKS type - 1**. It uses local time zone and locale when creating a date object.

- Exception: If the `parameterIndex` is invalid, database is not accessible, or `CallableStatement` is already closed, then it throws `SQLException`.

`Date getDate(int parameterIndex, Calendar cal)` throws `SQLException`

- Operation: It obtains column data at `parameterIndex`-th position in date type. For more information about whether it supports GOLDILOCKS types, refer to **Table 26-4 Whether supporting getter method for GOLDILOCKS type - 1**. It uses time zone and locale of `cal` when creating a date object.
- Exception: If the `parameterIndex` is invalid, database is not accessible, or `CallableStatement` is already closed, then it throws `SQLException`.

`Date getDate(String parameterName)` throws `SQLException`

- Operation: It is not implemented.
- Exception: It always throws `SQLFeatureNotSupportedException`.

`Date getDate(String parameterName, Calendar cal)` throws `SQLException`

- Operation: It is not implemented.
- Exception: It always throws `SQLFeatureNotSupportedException`.

getDouble

`double getDouble(int parameterIndex)` throws `SQLException`

- Operation: It obtains column data at `parameterIndex`-th position in double type. For more information about whether it supports GOLDILOCKS types, refer to **Table 26-4 Whether supporting getter method for GOLDILOCKS type - 1**.
- Exception: If the `parameterIndex` is invalid, database is not accessible, or `CallableStatement` is already closed, then it throws `SQLException`.

`double getDouble(String parameterName)` throws `SQLException`

- Operation: It is not implemented.
- Exception: It always throws `SQLFeatureNotSupportedException`.

getFloat

`float getFloat(int parameterIndex)` throws `SQLException`

- Operation: It obtains column data at parameterIndex-th position in float type. For more information about whether it supports GOLDILOCKS types, refer to **Table 26-4 Whether supporting getter method for GOLDILOCKS type - 1**.
- Exception: If the parameterIndex is invalid, database is not accessible, or CallableStatement is already closed, then it throws SQLException.

`float getFloat(String parameterName) throws SQLException`

- Operation: It is not implemented.
- Exception: It always throws SQLFeatureNotSupportedException.

getInt

`int getInt(int parameterIndex) throws SQLException`

- Operation: It obtains column data at parameterIndex-th position in int type. For more information about whether it supports GOLDILOCKS types, refer to **Table 26-4 Whether supporting getter method for GOLDILOCKS type - 1**.
- Exception: If the parameterIndex is invalid, database is not accessible, or CallableStatement is already closed, then it throws SQLException.

`int getInt(String parameterName) throws SQLException`

- Operation: It is not implemented.
- Exception: It always throws SQLFeatureNotSupportedException.

getLong

`long getLong(int parameterIndex) throws SQLException`

- Operation: It obtains column data at parameterIndex-th position in long type. For more information about whether it supports GOLDILOCKS types, refer to **Table 26-4 Whether supporting getter method for GOLDILOCKS type - 1**.
- Exception: If the parameterIndex is invalid, database is not accessible, or CallableStatement is already closed, then it throws SQLException.

`long getLong(String parameterName) throws SQLException`

- Operation: It is not implemented.
- Exception: It always throws SQLFeatureNotSupportedException.

getNCharacterStream

Reader `getNCharacterStream(int parameterIndex)` throws `SQLException`

- Operation: Currently, it does not support NCHAR-family type.
- Exception: It always throws `SQLFeatureNotSupportedException`.

Reader `getNCharacterStream(String parameterName)` throws `SQLException`

- Operation: Currently, it does not support NCHAR-family type.
- Exception: It always throws `SQLFeatureNotSupportedException`.

getNClob

NClob `getNClob(int parameterIndex)` throws `SQLException`

- Operation: Currently, it does not support NClob-family type.
- Exception: It always throws `SQLFeatureNotSupportedException`.

NClob `getNClob(String parameterName)` throws `SQLException`

- Operation: Currently, it does not support NClob-family type.
- Exception: It always throws `SQLFeatureNotSupportedException`.

getNString

String `getNString(int parameterIndex)` throws `SQLException`

- Operation: Currently, it does not support NCHAR-family type.
- Exception: It always throws `SQLFeatureNotSupportedException`.

String `getNString(String parameterName)` throws `SQLException`

- Operation: Currently, it does not support NCHAR-family type.
- Exception: It always throws `SQLFeatureNotSupportedException`.

getObject

Object `getObject(int parameterIndex)` throws `SQLException`

- Operation: It obtains column data at `parameterIndex`-th position in Java object type. For more inform

ation about whether it supports GOLDILOCKS types, refer to **Table 26-4 Whether supporting getter method for GOLDILOCKS type - 1** .

- Exception: If the parameterIndex is invalid, database is not accessible, or CallableStatement is already closed, then it throws SQLException.

Object getObject(int parameterIndex, Map<String,Class<?>> map) throws SQLException

- Operation: It is not supported.
- Exception: It always throws SQLFeatureNotSupportedException.

Object getObject(String parameterName) throws SQLException

- Operation: It is not implemented.
- Exception: It always throws SQLFeatureNotSupportedException.

Object getObject(String parameterName, Map<String,Class<?>> map) throws SQLException

- Operation: It is not supported.
- Exception: It always throws SQLFeatureNotSupportedException.

getRef

Ref getRef(int parameterIndex) throws SQLException

- Operation: It does not support ref type.
- Exception: It always returns SQLFeatureNotSupportedException.

Ref getRef(String parameterName) throws SQLException

- Operation: It does not support ref type.
- Exception: It always returns SQLFeatureNotSupportedException.

getRowId

RowId getRowId(int parameterIndex) throws SQLException

- Operation: It obtains column data at parameterIndex-th position in rowid type. For more information about whether it supports GOLDILOCKS types, refer to **Table 26-4 Whether supporting getter method for GOLDILOCKS type - 1** .
- Exception: If the parameterIndex is invalid, database is not accessible, or CallableStatement is already closed, then it throws SQLException.

`RowId getRowId(String parameterName)` throws `SQLException`

- Operation: It is not implemented.
- Exception: It always throws `SQLFeatureNotSupportedException`.

getShort

`short getShort(int parameterIndex)` throws `SQLException`

- Operation: It obtains column data at `parameterIndex`-th position in short type. For more information about whether it supports GOLDILOCKS types, refer to **Table 26-4 Whether supporting getter method for GOLDILOCKS type - 1**.
- Exception: If the `parameterIndex` is invalid, database is not accessible, or `CallableStatement` is already closed, then it throws `SQLException`.

`short getShort(String parameterName)` throws `SQLException`

- Operation: It is not implemented.
- Exception: It always throws `SQLFeatureNotSupportedException`.

getSQLXML

`SQLXML getSQLXML(int parameterIndex)` throws `SQLException`

- Operation: It does not support `SQLXML` type.
- Exception: It always returns `SQLFeatureNotSupportedException`.

`SQLXML getSQLXML(String parameterName)` throws `SQLException`

- Operation: It does not support `SQLXML` type.
- Exception: It always returns `SQLFeatureNotSupportedException`.

getString

`String getString(int parameterIndex)` throws `SQLException`

- Operation: It obtains column data at `parameterIndex`-th position in string type. For more information about whether it supports GOLDILOCKS types, refer to **Table 26-4 Whether supporting getter method for GOLDILOCKS type - 1**.
- Exception: If the `parameterIndex` is invalid, database is not accessible, or `CallableStatement` is already closed, then it throws `SQLException`.

String getString(String parameterName) throws SQLException

- Operation: It is not implemented.
- Exception: It always throws SQLFeatureNotSupportedException.

getTime

Time getTime(int parameterIndex) throws SQLException

- Operation: It obtains column data at parameterIndex-th position in time type. For more information about whether it supports GOLDILOCKS types, refer to **Table 26-4 Whether supporting getter method for GOLDILOCKS type - 1**. It uses local time zone when creating a time object.
- Exception: If the parameterIndex is invalid, database is not accessible, or CallableStatement is already closed, then it throws SQLException.

Time getTime(int parameterIndex, Calendar cal) throws SQLException

- Operation: It obtains column data at parameterIndex-th position in time type. For more information about whether it supports GOLDILOCKS types, refer to **Table 26-4 Whether supporting getter method for GOLDILOCKS type - 1**. It uses time zone of cal when creating a time object.
- Exception: If the parameterIndex is invalid, database is not accessible, or CallableStatement is already closed, then it throws SQLException.

Time getTime(String parameterName) throws SQLException

- Operation: It is not implemented.
- Exception: It always throws SQLFeatureNotSupportedException.

Time getTime(String parameterName, Calendar cal) throws SQLException

- Operation: It is not implemented.
- Exception: It always throws SQLFeatureNotSupportedException.

getTimestamp

Timestamp getTimestamp(int parameterIndex) throws SQLException

- Operation: It obtains column data at parameterIndex-th position in timestamp type. For more information about whether it supports GOLDILOCKS types, refer to **Table 26-4 Whether supporting getter method for GOLDILOCKS type - 1**. It uses local time zone when creating a timestamp object.
- Exception: If the parameterIndex is invalid, database is not accessible, or CallableStatement is already closed, then it throws SQLException.

Timestamp `getTimestamp(int parameterIndex, Calendar cal)` throws `SQLException`

- Operation: It obtains column data at `parameterIndex`-th position in timestamp type. For more information about whether it supports GOLDILOCKS types, refer to **Table 26-4 Whether supporting getter method for GOLDILOCKS type - 1**. It uses time zone of `cal` when creating a timestamp object.
- Exception: If the `parameterIndex` is invalid, database is not accessible, or `CallableStatement` is already closed, then it throws `SQLException`.

Timestamp `getTimestamp(String parameterName)` throws `SQLException`

- Operation: It is not implemented.
- Exception: It always throws `SQLFeatureNotSupportedException`.

Timestamp `getTimestamp(String parameterName, Calendar cal)` throws `SQLException`

- Operation: It is not implemented.
- Exception: It always throws `SQLFeatureNotSupportedException`.

getURL

URL `getURL(int parameterIndex)` throws `SQLException`

- Operation: It does not support URL type.
- Exception: It always returns `SQLFeatureNotSupportedException`.

URL `getURL(String parameterName)` throws `SQLException`

- Operation: It does not support URL type.
- Exception: It always returns `SQLFeatureNotSupportedException`.

registerOutParameter

`void registerOutParameter(int parameterIndex, int sqlType)` throws `SQLException`

- Operation: It registers out parameters positioned in `parameterIndex` as `sqlType`. All out parameters should be registered before executing the stored procedure. JDBC type of out parameter specified as `sqlType` determines Java type which is used in a get method to read parameter value. For more information about whether it supports GOLDILOCKS types, refer to **Table 26-4 Whether supporting getter method for GOLDILOCKS type - 1**.
- Exception: If the `parameterIndex` is invalid, database is not accessible, or `CallableStatement` is already closed, then it throws `SQLFeatureNotSupportedException`.

`void registerOutParameter(int parameterIndex, int sqlType, int scale) throws SQLException`

- Operation: It is not implemented.
- Exception: It always throws `SQLFeatureNotSupportedException`.

`void registerOutParameter(int parameterIndex, int sqlType, String typeName) throws SQLException`

- Operation: It is not implemented.
- Exception: It always throws `SQLFeatureNotSupportedException`.

`void registerOutParameter(String parameterName, int sqlType) throws SQLException`

- Operation: It is not implemented.
- Exception: It always throws `SQLFeatureNotSupportedException`.

`void registerOutParameter(String parameterName, int sqlType, int scale) throws SQLException`

- Operation: It is not implemented.
- Exception: It always throws `SQLFeatureNotSupportedException`.

`void registerOutParameter(String parameterName, int sqlType, String typeName) throws SQLException`

- Operation: It is not implemented.
- Exception: It always throws `SQLFeatureNotSupportedException`.

setAsciiStream

`void setAsciiStream(String parameterName, InputStream x) throws SQLException`

- Operation: It is not implemented.
- Exception: It always throws `SQLFeatureNotSupportedException`.

`void setAsciiStream(String parameterName, InputStream x, int length) throws SQLException`

- Operation: It is not implemented.
- Exception: It always throws `SQLFeatureNotSupportedException`.

`void setAsciiStream(String parameterName, InputStream x, long length) throws SQLException`

- Operation: It is not implemented.

- Exception: It always throws `SQLFeatureNotSupportedException`.

setBigDecimal

`void setBigDecimal(String parameterName, BigDecimal x) throws SQLException`

- Operation: It is not implemented.
- Exception: It always throws `SQLFeatureNotSupportedException`.

setBinaryStream

`void setBinaryStream(String parameterName, InputStream x) throws SQLException`

- Operation: It is not implemented.
- Exception: It always throws `SQLFeatureNotSupportedException`.

`void setBinaryStream(String parameterName, InputStream x, int length) throws SQLException`

- Operation: It is not implemented.
- Exception: It always throws `SQLFeatureNotSupportedException`.

`void setBinaryStream(String parameterName, InputStream x, long length) throws SQLException`

- Operation: It is not implemented.
- Exception: It always throws `SQLFeatureNotSupportedException`.

setBlob

`void setBlob(String parameterName, Blob x) throws SQLException`

- Operation: It does not support blob type.
- Exception: It always returns `SQLFeatureNotSupportedException`.

`void setBlob(String parameterName, InputStream inputStream) throws SQLException`

- Operation: It does not support blob type.
- Exception: It always returns `SQLFeatureNotSupportedException`.

`void setBlob(String parameterName, InputStream inputStream, long length) throws SQLException`

- Operation: It does not support blob type.

- Exception: It always returns `SQLFeatureNotSupportedException`.

setBoolean

`void setBoolean(String parameterName, boolean x) throws SQLException`

- Operation: It is not implemented.
- Exception: It always throws `SQLFeatureNotSupportedException`.

setByte

`void setByte(String parameterName, byte x) throws SQLException`

- Operation: It is not implemented.
- Exception: It always throws `SQLFeatureNotSupportedException`.

setBytes

`void setBytes(String parameterName, byte[] x) throws SQLException`

- Operation: It is not implemented.
- Exception: It always throws `SQLFeatureNotSupportedException`.

setCharacterStream

`void setCharacterStream(String parameterName, Reader reader) throws SQLException`

- Operation: It is not implemented.
- Exception: It always throws `SQLFeatureNotSupportedException`.

`void setCharacterStream(String parameterName, Reader reader, int length) throws SQLException`

- Operation: It is not implemented.
- Exception: It always throws `SQLFeatureNotSupportedException`.

`void setCharacterStream(String parameterName, Reader reader, long length) throws SQLException`

- Operation: It is not implemented.
- Exception: It always throws `SQLFeatureNotSupportedException`.

setClob

`void setClob(String parameterName, Clob x) throws SQLException`

- Operation: It does not support clob type.
- Exception: It always returns `SQLFeatureNotSupportedException`.

`void setClob(String parameterName, Reader reader) throws SQLException`

- Operation: It does not support clob type.
- Exception: It always returns `SQLFeatureNotSupportedException`.

`void setClob(String parameterName, Reader reader, long length) throws SQLException`

- Operation: It does not support clob type.
- Exception: It always returns `SQLFeatureNotSupportedException`.

setDate

`void setDate(String parameterName, Date x) throws SQLException`

- Operation: It is not implemented.
- Exception: It always throws `SQLFeatureNotSupportedException`.

`void setDate(String parameterName, Date x, Calendar cal) throws SQLException`

- Operation: It is not implemented.
- Exception: It always throws `SQLFeatureNotSupportedException`.

setDouble

`void setDouble(String parameterName, double x) throws SQLException`

- Operation: It is not implemented.
- Exception: It always throws `SQLFeatureNotSupportedException`.

setFloat

`void setFloat(String parameterName, float x) throws SQLException`

- Operation: It is not implemented.

- Exception: It always throws `SQLFeatureNotSupportedException`.

setInt

`void setInt(String parameterName, int x) throws SQLException`

- Operation: It is not implemented.
- Exception: It always throws `SQLFeatureNotSupportedException`.

setLong

`void setLong(String parameterName, long x) throws SQLException`

- Operation: It is not implemented.
- Exception: It always throws `SQLFeatureNotSupportedException`.

setNCharacterStream

`void setNCharacterStream(String parameterName, Reader value) throws SQLException`

- Operation: It does not support `NChar`.
- Exception: It always throws `SQLFeatureNotSupportedException`.

`void setNCharacterStream(String parameterName, Reader value, long length) throws SQLException`

- Operation: It does not support `NChar`.
- Exception: It always throws `SQLFeatureNotSupportedException`.

setNClob

`void setNClob(String parameterName, NClob value) throws SQLException`

- Operation: It does not support `NClob`.
- Exception: It always throws `SQLFeatureNotSupportedException`.

`void setNClob(String parameterName, Reader reader) throws SQLException`

- Operation: It does not support `NClob`.
- Exception: It always throws `SQLFeatureNotSupportedException`.

`void setNClob(String parameterName, Reader reader, long length) throws SQLException`

- Operation: It does not support NClob.
- Exception: It always throws `SQLFeatureNotSupportedException`.

setNString

`void setNString(String parameterName, String value) throws SQLException`

- Operation: It does not support NChar.
- Exception: It always throws `SQLFeatureNotSupportedException`.

setNull

`void setNull(String parameterName, int sqlType) throws SQLException`

- Operation: It is not implemented.
- Exception: It always throws `SQLFeatureNotSupportedException`.

`void setNull(String parameterName, int sqlType, String typeName) throws SQLException`

- Operation: It is not implemented.
- Exception: It always throws `SQLFeatureNotSupportedException`.

setObject

`void setObject(String parameterName, Object x) throws SQLException`

- Operation: It is not implemented.
- Exception: It always throws `SQLFeatureNotSupportedException`.

`void setObject(String parameterName, Object x, int targetSqlType) throws SQLException`

- Operation: It is not implemented.
- Exception: It always throws `SQLFeatureNotSupportedException`.

`void setObject(String parameterName, Object x, int targetSqlType, int scale) throws SQLException`

- Operation: It is not implemented.
- Exception: It always throws `SQLFeatureNotSupportedException`.

setRowId

`void setRowId(String parameterName, RowId x) throws SQLException`

- Operation: It is not implemented.
- Exception: It always throws `SQLFeatureNotSupportedException`.

setShort

`void setShort(String parameterName, short x) throws SQLException`

- Operation: It is not implemented.
- Exception: It always throws `SQLFeatureNotSupportedException`.

setSQLXML

`void setSQLXML(String parameterName, SQLXML xmlObject) throws SQLException`

- Operation: It does not support `SQLXML` type.
- Exception: It always returns `SQLFeatureNotSupportedException`.

setString

`void setString(String parameterName, String x) throws SQLException`

- Operation: It is not implemented.
- Exception: It always throws `SQLFeatureNotSupportedException`.

setTime

`void setTime(String parameterName, Time x) throws SQLException`

- Operation: It is not implemented.
- Exception: It always throws `SQLFeatureNotSupportedException`.

`void setTime(String parameterName, Time x, Calendar cal) throws SQLException`

- Operation: It is not implemented.
- Exception: It always throws `SQLFeatureNotSupportedException`.

setTimestamp

`void setTimestamp(String parameterName, Timestamp x) throws SQLException`

- Operation: It is not implemented.
- Exception: It always throws `SQLFeatureNotSupportedException`.

`void setTimestamp(String parameterName, Timestamp x, Calendar cal) throws SQLException`

- Operation: It is not implemented.
- Exception: It always throws `SQLFeatureNotSupportedException`.

setURL

`void setURL(String parameterName, URL val) throws SQLException`

- Operation: It does not support URL type.
- Exception: It always throws `SQLFeatureNotSupportedException`.

wasNull

`boolean wasNull()`

- Operation: It is not implemented.
- Exception: It always throws `SQLFeatureNotSupportedException`.

isWrapperFor

`boolean isWrapperFor(Class<?> iface)`

- Operation: It is not implemented.
- Exception: It always throws `SQLFeatureNotSupportedException`.

unwrap

`boolean isWrapperFor(Class<?> iface)`

- Operation: It is not implemented.
- Exception: It always throws `SQLFeatureNotSupportedException`.

Clob

The class is not implemented.

free

| void free() throws SQLException

getAsciiStream

| InputStream getAsciiStream() throws SQLException

getCharacterStream

| Reader getCharacterStream() throws SQLException

| Reader getCharacterStream(long pos, long length) throws SQLException

getSubString

| String getSubString(long pos, int length) throws SQLException

length

| long length() throws SQLException

position

| long position(Clob searchstr, long start) throws SQLException

| long position(String searchstr, long start) throws SQLException

setAsciiStream

| OutputStream setAsciiStream(long pos) throws SQLException

setCharacterStream

| Writer setCharacterStream(long pos) throws SQLException

setString

| int setString(long pos, String str) throws SQLException

| int setString(long pos, String str, int offset, int len) throws SQLException

truncate

| void truncate(long len) throws SQLException

CommonDataSource

getLoginTimeout

`int getLoginTimeout()` throws `SQLException`

- Operation: It returns the login timeout setting value. Login timeout is used as a timeout value when performing socket connection to the server. If the value is not set, 0 is returned. 0 means infinite standby.
- Exception: It does not occur.

getLogWriter

`PrintWriter getLogWriter()` throws `SQLException`

- Operation: It returns the log writer which is set in the DataSource. If it is not set, null is returned. Log writer refers to `PrintWriter` to write various trace logs. For more information about logging, refer to **Logging**.
- Exception: It does not occur.

setLoginTimeout

`void setLoginTimeout(int seconds)` throws `SQLException`

- Operation: It sets the login timeout value. Login timeout is used as a timeout value when performing socket connection to the server. 0 means infinite standby.
- Exception: It does not occur.

setLogWriter

`void setLogWriter(PrintWriter out)` throws `SQLException`

- Operation: It sets the log writer in DataSource. If the value is not set, the default value is null. Log writer refers to `PrintWriter` to write various trace logs. If the value is set, trace log, query log, and protocol log are written according to the options, and connection object which is created from DataSource and all objects which are created from connection object such as Statement, ResultSet, perform logging. Trace log, query log, protocol log options can be specified in the connection url or property. For more information about logging, refer to **Logging**.
- Exception: It does not occur.

setDataSourceName

```
void setDataSourceName(String aDataSourceName)
```

- Operation: It sets the data source name. It is not the mandatory information required for the connection. It is the information charged separately to distinguish objects.
- Exception: It does not occur.

setServerName

```
void setServerName(String aServerName)
```

- Operation: It sets the server name, which is the connection URL. It is the mandatory information required for the connection.
- Exception: It does not occur.

setDatabaseName

```
void setDatabaseName(String aDBName)
```

- Operation: It sets the database name. It is the mandatory information required for the connection.
- Exception: It does not occur.

setNetworkProtocol

```
void setNetworkProtocol(String aProtocol)
```

- Operation: It is the network protocol information. It is not the mandatory information required for the connection.
- Exception: It does not occur.

setUser

```
void setUser(String aUser)
```

- Operation: It sets the connection account name. It is the mandatory information required for the connection.
- Exception: It does not occur.

setPassword

`void setPassword(String aPassword)`

- Operation: It sets the connection account password. It is the mandatory information required for the connection.
- Exception: It does not occur.

setPortNumber

`void setPortNumber(int aPort)`

- Operation: It sets the port number used when connecting to the server. It is the mandatory information required for the connection.
- Exception: It does not occur.

`void setPortNumber(String aPort)`

- Operation: It sets the port number used when connecting to the server. It is the mandatory information required for the connection.
- Exception: It does not occur.

setRoleName

`void setRoleName(String aRoleName)`

- Operation: It specifies the role of when connecting to server. It is not mandatory information required for the connection, but it is the connection related information. One of "", "ADMIN", "SYSDBA" is specified.
- Exception: It does not occur.

setDescription

`void setDescription(String aDescription)`

- Operation: It sets the description about the data source. It is not used for the connection.
- Exception: It does not occur.

setConnectionProperties

void setConnectionProperties(Properties aProps)

- Operation: It defines the properties which can be used in various connections.
- Exception: It does not occur.

setURL

void setURL(String aURL) throws SQLException

- Operation: It specifies the serverName, portNumber, and database Name in URL form. It has URL as same as the URL of when connecting via DriverManager.
- Exception: If it is the wrong format, it throws SQLException.

void setUrl(String aUrl) throws SQLException

It is as same as setURL (String aURL).

setLogTarget

void setLogTarget(String aTarget)

- Operation: If setLogWriter can not be called, the log writer is set by this method. Currently, it is supported only when aTarget is "console", other values are ignored. If it is set to "console", all loggings below the connection object which is generated from the DataSource are output to the console.
- Exception: It does not occur.

setTraceLog

void setTraceLog(String aMode)

- Operation: It sets the trace log. If aMode is *on*, the trace logging is on.
- Exception: It does not occur.

setQueryLog

void setQueryLog(String aMode)

- Operation: It sets the query log. If aMode is *on*, the query logging is on.

- Exception: It does not occur.

setProtocolLog

`void setProtocolLog(String aMode)`

- Operation: It sets the protocol log. If *aMode* is *on*, the protocol logging is on.
- Exception: It does not occur.

Connection

clearWarnings

void clearWarnings() throws **SQLException**

- Operation: It clears the warning object(s) owned by the current connection object.
- Exception: It does not occur.

close

void close() throws **SQLException**

- Operation: It breaks the connection with GOLDILOCKS not to use anymore the current connection and closes all statement objects created from the object. If already closed, any operation is not performed.
- Exception: It may happen when an error occurs from the server or it does not respond.

commit

void commit() throws **SQLException**

- Operation: For non-auto commit mode, the commit is executed for the current connection.
- Exception: If it is already closed or is on the auto-commit mode, it throws **SQLException**.

createArrayOf

Array createArrayOf(String typeName, Object[] elements) throws **SQLException**

- Operation: It is not implemented.
- Exception: It always throws **SQLFeatureNotSupportedException**.

createBlob

Blob createBlob() throws **SQLException**

- Operation: It is not implemented.
- Exception: It always throws **SQLFeatureNotSupportedException**.

createClob

Clob `createClob()` throws `SQLException`

- Operation: It is not implemented.
- Exception: It always throws `SQLFeatureNotSupportedException`.

createNClob

NClob `createNClob()` throws `SQLException`

- Operation: It is not implemented.
- Exception: It always throws `SQLFeatureNotSupportedException`.

createSQLXML

SQLXML `createSQLXML()` throws `SQLException`

- Operation: It is not implemented.
- Exception: It always throws `SQLFeatureNotSupportedException`.

createStatement

Statement `createStatement()` throws `SQLException`

- Operation: It creates statement object. The `ResultSet` type created by the statement is `ResultSet.TYPE_FORWARD_ONLY`, and concurrency is `ResultSet.CONCUR_READ_ONLY`, and holdability is `ResultSet.HOLD_CURSORS_OVER_COMMIT`.
- Exception: If it is already closed, it throws `SQLException`.

Statement `createStatement(int resultSetType, int resultSetConcurrency)` throws `SQLException`

- Operation: It creates statement object which creates `ResultSet` including the user defined resultset type and resultset concurrency. The holdability of `ResultSet` which are generated from the statement object is as same as the holdability of the connection type. The default holdability of connection is `ResultSet.HOLD_CURSORS_OVER_COMMIT`.
- Exception: If it is already closed, it throws `SQLException`.

Statement `createStatement(int resultSetType, int resultSetConcurrency, int resultSetHoldability)` throws `SQLException`

- Operation: It creates a statement object which creates ResultSet including the user defined resultset type, resultset concurrency and holdability.
- Exception: If it is already closed, it throws SQLException.

createStruct

Struct createStruct(String typeName, Object[] attributes) throws SQLException

- Operation: It is not implemented.
- Exception: It always throws SQLFeatureNotSupportedException.

getAutoCommit

boolean getAutoCommit() throws SQLException

- Operation: It returns the current auto commit mode. If setAutoCommit() has not been called, it returns true.
- Exception: It does not occur.

getCatalog

String getCatalog() throws SQLException

- Operation: It gets the current catalog name of the database.
- Exception: If an error occurs from the server or it does not respond, then it throws SQLException.

getClientInfo

Properties getClientInfo() throws SQLException

- Operation: It returns client information set by the user. If setting information does not exist, It returns null.
- Exception: It does not occur.

String getClientInfo(String name) throws SQLException

- Operation: It returns specific client information set by the user. If the corresponding information does not exist, it returns null.
- Exception: It does not occur.

getHoldability

`int getHoldability()` throws `SQLException`

- Operation: It returns the default holdability value of statements created by this object. The default value is `ResultSet.HOLD_CURSORS_OVER_COMMIT`.
- Exception: It does not occur.

getMetaData

`DatabaseMetaData getMetaData()` throws `SQLException`

- Operation: It gets a `DatabaseMetaData` object which can be queried for metadata information from this object. It always returns the same object.
- Exception: If it is already closed, it throws `SQLException`.

getTransactionIsolation

`int getTransactionIsolation()` throws `SQLException`

- Operation: It gets the transaction isolation level which is set on the current session (connection). The default value which is set on the server is `Connection.TRANSACTION_READ_COMMITTED`.
- Exception: If an error occurs from the server, it throws `SQLException`.

getTypeMap

`Map<String,Class<?>> getTypeMap()` throws `SQLException`

- Operation: It is not implemented.
- Exception: It always throws `SQLFeatureNotSupportedException`.

getWarnings

`SQLWarning getWarnings()` throws `SQLException`

- Operation: It returns a warning which the server responds to connection object until now. If a warning does not exist or `clearWarnings()` is already performed, it returns null.
- Exception: It does not occur.

isClosed

boolean isClosed() throws **SQLException**

- Operation: It queries whether close() is successfully called. If close() is successfully performed, it returns true. Otherwise, it returns false.
- Exception: It does not occur.



This method does not inform a user whether the connection to a physical server is broken. Even if the actual connection is broken it returns true when close () has never been called.

isReadOnly

boolean isReadOnly() throws **SQLException**

- Operation: If the session(connection) is read only mode, it returns true. Otherwise, it returns false. The default value is false. Communication with the server occurs.
- Exception: If an error occurs from the server or it does not respond, it throws SQLException.

isValid

boolean isValid(int timeout) throws **SQLException**

- Operation: If isClosed() returns true or the heart beat query is sent to the server and response is not successfully received, it returns false. Otherwise, it returns true.
- Exception: It does not occur.

nativeSQL

String nativeSQL(String sql) throws **SQLException**

- Operation: It returns the native SQL recognized by the server for the given user SQL statement. GOLD ILOCKS always return the value as same as given by the user because the server recognizes the user's SQL statement literally.
- Exception: It does not occur.

prepareCall

`CallableStatement prepareCall(String sql)` throws `SQLException`

- Operation: It returns `CallableStatement` object for calling stored procedures. `ResultSet` type created from this `CallableStatement` is `ResultSet.TYPE_FORWARD_ONLY`, the concurrency is `ResultSet.CONCUR_READ_ONLY`, and the holdability is `ResultSet.HOLD_CURSORS_OVER_COMMIT`.
- Exception: If it is already closed or the SQL statement is wrong, then it throws `SQLException`.

`CallableStatement prepareCall(String sql, int resultSetType, int resultSetConcurrency)` throws `SQLException`

- Operation: It creates `CallableStatement` object which creates `ResultSet` with the resultset type and the resultset concurrency specified by the user. The holdability of `ResultSet` created from this `CallableStatement` is as same as that of the connection. The default holdability value of the connection is `ResultSet.HOLD_CURSORS_OVER_COMMIT`.
- Exception: If it is already closed or the SQL statement is wrong, then it throws `SQLException`.

`CallableStatement prepareCall(String sql, int resultSetType, int resultSetConcurrency, int resultSetHoldability)` throws `SQLException`

- Operation: It creates `CallableStatement` object which creates `ResultSet` with the resultset type, the resultset concurrency and the holdability specified by the user.
- Exception: If it is already closed or the SQL statement is wrong, then it throws `SQLException`.

prepareStatement

`PreparedStatement prepareStatement(String sql)` throws `SQLException`

- Operation: It sends the SQL statement to the server and prepares (parsing, validation, optimization), and it returns the `PreparedStatement` object which controls the prepared statement to the user. The type of `ResultSet` generated by the `PreparedStatement` is `ResultSet.TYPE_FORWARD_ONLY`, and concurrency is `ResultSet.CONCUR_READ_ONLY`, and holdability is `ResultSet.HOLD_CURSORS_OVER_COMMIT`.
- Exception: If it is already closed or the SQL statement is wrong, it throws `SQLException`.

`PreparedStatement prepareStatement(String sql, int autoGeneratedKeys)` throws `SQLException`

- Operation: If `autoGeneratedKeys` is `Statement.NO_GENERATED_KEYS`, it operates in the same way as `prepareStatement(String sql)` method. Otherwise, it throws an exception.
- Exception: If it is already closed, the SQL statement is wrong or `autoGeneratedKeys` value is neither `Statement.NO_GENERATED_KEYS` nor `Statement.RETURN_GENERATED_KEYS`, then it throws `SQLException`. If `autoGeneratedKeys` is `Statement.RETURN_GENERATED_KEYS`, it throws `SQLFeatureNotSupportedException`.

ortedException.

`PreparedStatement prepareStatement(String sql, int[] columnIndexes)` throws `SQLException`

- Operation: If `columnIndexes` is null, it operates in the same way as the `prepareStatement(String sql)` method. Otherwise, it throws an exception.
- Exception: If it is already closed or the SQL statement is wrong, it throws `SQLException`. If `columnIndexes` is not null, it throws `SQLFeatureNotSupportedException`.

`PreparedStatement prepareStatement(String sql, int resultSetType, int resultSetConcurrency)`
throws `SQLException`

- Operation: It sends the SQL statement to the server and prepares (parsing, validation, optimization). It returns the `PreparedStatement` object which controls the prepared statement to the user. It creates the `PreparedStatement` object generating `ResultSet` which includes the user defined result set type and result set concurrency. The holdability of `ResultSet` which is generated by `PreparedStatement` is as same as the holdability of connection. The default holdability value of connection is `ResultSet.HOLD_CURSORS_OVER_COMMIT`.
- Exception: If it is already closed or the SQL statement is wrong, it throws `SQLException`.

`PreparedStatement prepareStatement(String sql, int resultSetType, int resultSetConcurrency, int resultSetHoldability)` throws `SQLException`

- Operation: It sends the SQL statement to the server and prepares (parsing, validation, optimization). It returns the `PreparedStatement` object which controls the prepared statement to the user. It creates the `PreparedStatement` object generating `ResultSet` which includes the user defined result set type and result set concurrency and holdability.
- Exception: If it is already closed or the SQL statement is wrong, it throws `SQLException`.

`PreparedStatement prepareStatement(String sql, String[] columnNames)` throws `SQLException`

- Operation: If `columnNames` is null, it operates in the same way as `prepareStatement(String sql)` method. Otherwise, it throws an exception.
- Exception: If it is already closed or the SQL statement is wrong, it throws `SQLException`. If `columnNames` is not null, it throws `SQLFeatureNotSupportedException`.

releaseSavepoint

`void releaseSavepoint(Savepoint savepoint)` throws `SQLException`

- Operation: It removes the savepoint from the server. It also removes all savepoints after this savepoint.
- Exception: If it is already closed or the savepoint object was already released or it is not the `GOLDILOCKS` savepoint object, it throws `SQLException`.

rollback

`void rollback()` throws `SQLException`

- Operation: If it is non auto commit mode, it rolls back the current transaction.
- Exception: If it is already closed or it is the auto commit mode or an error is returned from the server, it throws `SQLException`.

`void rollback(Savepoint savepoint)` throws `SQLException`

- Operation: If it is non auto commit mode, it performs partial rollback to the savepoint for the current transaction.
- Exception: If it is already closed or it is the auto commit mode or an error is returned from the server or the savepoint is not valid, it throws `SQLException`.

setAutoCommit

`void setAutoCommit(boolean autoCommit)` throws `SQLException`

- Operation: It changes the auto commit mode for the current connection. If the performed transaction exists and the non auto commit mode is changed to the auto commit, it performs commit.
- Exception: It is as same as the exception which may occur during the commit process.

setCatalog

`void setCatalog(String catalog)` throws `SQLException`

- Operation: It is not implemented.
- Exception: It always throws `SQLFeatureNotSupportedException`.

setClientInfo

`void setClientInfo(Properties properties)` throws `SQLException`

- Operation: It sets the user defined client information. Existing client information is eliminated. It does not affect the server.
- Exception: It does not occur.

`void setClientInfo(String name, String value)` throws `SQLException`

- Operation: It adds the user defined client information. Existing client information is retained.

- Exception: It does not occur.

setHoldability

`void setHoldability(int holdability) throws SQLException`

- Operation: It sets the ResultSet holdability which is generated by the statement generated from this object. If the method is not called, the default value is `ResultSet.HOLD_CURSORS_OVER_COMMIT`.
- Exception: It does not occur.

setReadOnly

`void setReadOnly(boolean readOnly) throws SQLException`

- Operation: It sets the read only property of the current session (connection). The default value is false.
- Exception: If it is already closed or an error is returned from the server, it throws `SQLException`.

setSavepoint

`Savepoint setSavepoint() throws SQLException`

- Operation: If it is the non auto commit mode, it sets the savepoint for the current transaction. The savepoint name is internally determined.
- Exception: If it is already closed or it is the auto commit mode or an error is returned from the server, it throws `SQLException`.

`Savepoint setSavepoint(String name) throws SQLException`

- Operation: If it is the non auto commit mode, it sets the savepoint whose name is specified by the user for the current transaction.
- Exception: If it is already closed or it is the auto commit mode or an error is returned from the server, it throws `SQLException`.

setTransactionIsolation

`void setTransactionIsolation(int level) throws SQLException`

- Operation: It changes the transaction isolation for the current session (connection). The supported value is `Connection.TRANSACTION_READ_COMMITTED`, `Connection.TRANSACTION_READ_UNCOMMITTED`, and `Connection.TRANSACTION_SERIALIZABLE`. `Connection.READ_UNCOMMITTED` is set to `Connection.TRANSACTION_READ_COMMITTED`, and `Connection.TRANSACTION_REPEATABLE_READ` is s

et to `Connection.TRANSACTION_SERIALIZABLE`.

- Exception: If it is already closed or the level has the wrong value, it throws `SQLException`.

setTypeMap

`void setTypeMap(Map<String,Class<?>> map) throws SQLException`

- Operation: It is not implemented.
- Exception: It always throws `SQLFeatureNotSupportedException`.

isWrapperFor

`void isWrapperFor(Class<?> iface) throws SQLException`

- Operation: It queries whether this object is a class which implements the `iface` interface. If it is, it returns true. Otherwise, it returns false. It does not determine the presence of the wrapper but it only queries only whether the given argument class type is implemented because `GOLDILOCKS` connection object is not the wrapper of any other class.
- Exception: It does not occur.

unwrap

`<T> T unwrap(Class<T> iface) throws SQLException`

- Operation: It eventually returns itself, even when it is unwrapped because `GOLDILOCKS` connection is not the wrapper of any other class. It returns itself after casting it to the corresponding type. If `iface` is an argument of `isWrapperFor()` method and false is returned, the method throws an exception.
- Exception: If `iface` is not the type of this object (if this object returns the unimplemented type), it throws `SQLException`.

ConnectionPoolDataSource

getPooledConnection

`PooledConnection getPooledConnection()` throws `SQLException`

- Operation: It creates the `PooledConnection` object. Various connection information, such as user name, password, connection URL should be set through the setter method in advance.
- Exception: If the connection fails, it throws `SQLException`.

`PooledConnection getPooledConnection(String user, String password)` throws `SQLException`

- Operation: It creates the `PooledConnection` object. Username and password shall comply with the argument. Other connection information should be set to the setter method in advance.
- Exception: If the connection fails, it throws `SQLException`.

DatabaseMetaData

allProceduresAreCallable

boolean allProceduresAreCallable() throws SQLException

- Operation: It always returns true.
- Exception: It does not occur.

allTablesAreSelectable

boolean allTablesAreSelectable() throws SQLException

- Operation: It always returns true.
- Exception: It does not occur.

autoCommitFailureClosesAllResultSets

boolean autoCommitFailureClosesAllResultSets() throws SQLException

- Operation: It always returns false.
- Exception: It does not occur.

dataDefinitionCausesTransactionCommit

boolean dataDefinitionCausesTransactionCommit() throws SQLException

- Operation: It always returns false because it does not automatically commit DDL statements at runtime.
- Exception: It does not occur.

dataDefinitionIgnoredInTransactions

boolean dataDefinitionIgnoredInTransactions() throws SQLException

- Operation: It always returns false, because DDL statements are included in a transaction.
- Exception: It does not occur.

deletesAreDetected

boolean `deletesAreDetected(int type)` throws `SQLException`

- Operation: If type is `ResultSet.TYPE_SCROLL_SENSITIVE`, it returns true. Otherwise, it returns false.
- Exception: It does not occur.

doesMaxRowSizeIncludeBlobs

boolean `doesMaxRowSizeIncludeBlobs()` throws `SQLException`

- Operation: It always returns false.
- Exception: It does not occur.

getAttributes

`ResultSet` `getAttributes(String catalog, String schemaPattern, String typeNamePattern, String attributeNamePattern)` throws `SQLException`

- Operation: It returns an empty `ResultSet`.
- Exception: If an error is returned from the server, it throws `SQLException`.

getBestRowIdentifier

`ResultSet` `getBestRowIdentifier(String catalog, String schema, String table, int scope, boolean nullable)` throws `SQLException`

- Operation: It returns a `ResultSet` including one row consisting with rowid information because the rowid type is supported for all tables. If the table does not exist, it returns an empty `ResultSet`.
- Exception: If the table is null or an error is returned from the server, it throws `SQLException`.

getCatalogs

`ResultSet` `getCatalogs()` throws `SQLException`

- Operation: It returns a `ResultSet` which has the catalog name in a column.
- Exception: If an error is returned from the server, it throws `SQLException`.

getCatalogSeparator

String `getCatalogSeparator()` throws `SQLException`

- Operation: It returns a catalog separator character.
- Exception: If an error is returned from the server, it throws `SQLException`.

getCatalogTerm

String `getCatalogTerm()` throws `SQLException`

- Operation: It returns a catalog term character.
- Exception: If an error is returned from the server, it throws `SQLException`.

getClientInfoProperties

`ResultSet` `getClientInfoProperties()` throws `SQLException`

- Operation: It returns a `ResultSet` including client information.
- Exception: If an error is returned from the server, it throws `SQLException`.

getColumnPrivileges

`ResultSet` `getColumnPrivileges(String catalog, String schema, String table, String columnNamePattern)` throws `SQLException`

- Operation: It returns a `ResultSet` including column privilege information of the column in the table. If the table or the column corresponding to the column name pattern does not exist, it returns an empty `ResultSet`.
- Exception: If an error is returned from the server, it throws `SQLException`.

getColumns

`ResultSet` `getColumns(String catalog, String schemaPattern, String tableNamePattern, String columnNamePattern)` throws `SQLException`

- Operation: It returns a `ResultSet` including all column information of the table. If the table or the column corresponding to the column name pattern does not exist, it returns an empty `ResultSet`.
- Exception: If an error is returned from the server, it throws `SQLException`.

getConnection

Connection getConnection() throws SQLException

- Operation: It returns the connection object which created the DatabaseMetaData object.
- Exception: It does not occur.

getCrossReference

ResultSet getCrossReference(String parentCatalog, String parentSchema, String parentTable, String foreignCatalog, String foreignSchema, String foreignTable) throws SQLException

- Operation: It returns a ResultSet including information of the foreign keys which refers to the given parent table in the given foreign key table. If reference relationship does not exist, it returns an empty ResultSet.
- Exception: If the foreign table or parent table is null or an error is returned from the server, it throws SQLException.

getDatabaseMajorVersion

int getDatabaseMajorVersion() throws SQLException

- Operation: It returns the major version of the product.
- Exception: If an error is returned from the server, it throws SQLException.

getDatabaseMinorVersion

int getDatabaseMinorVersion() throws SQLException

- Operation: It returns the minor version of the product.
- Exception: If an error is returned from the server, it throws SQLException.

getDatabaseProductName

String getDatabaseProductName() throws SQLException

- Operation: It returns the product name.
- Exception: If an error is returned from the server, it throws SQLException.

getDatabaseProductVersion

String getDatabaseProductVersion() throws SQLException

- Operation: It returns the product version.
- Exception: If an error is returned from the server, it throws SQLException.

getDefaultTransactionIsolation

int getDefaultTransactionIsolation() throws SQLException

- Operation: It returns the default transaction isolation. The default value which is set on the server is Connection.TRANSACTION_READ_COMMITTED.
- Exception: If an error is returned from the server, it throws SQLException.

getDriverMajorVersion

int getDriverMajorVersion() throws SQLException

- Operation: It returns the major version of GOLDILOCKS JDBC driver.
- Exception: It does not occur.

getDriverMinorVersion

int getDriverMinorVersion() throws SQLException

- Operation: It returns the minor version of GOLDILOCKS JDBC driver.
- Exception: It does not occur.

getDriverName

String getDriverName() throws SQLException

- Operation: It returns "GOLDILOCKS JDBC Driver".
- Exception: It does not occur.

getDriverVersion

String getDriverVersion() throws SQLException

- Operation: It returns GOLDILOCKS JDBC driver version string. It includes the protocol version.
- Exception: It does not occur.

getExportedKeys

ResultSet getExportedKeys(String catalog, String schema, String table) throws SQLException

- Operation: It returns a ResultSet including foreign key information referring to the column in the given table.
- Exception: If an error is returned from the server, it throws SQLException.

getExtraNameCharacters

String getExtraNameCharacters() throws SQLException

- Operation: It returns "-\$".
- Exception: It does not occur.

getFunctionColumns

ResultSet getFunctionColumns(String catalog, String schemaPattern, String functionNamePattern, String columnNamePattern) throws SQLException

- Operation: It returns an empty ResultSet.
- Exception: If an error is returned from the server, it throws SQLException.

getFunctions

ResultSet getFunctions(String catalog, String schemaPattern, String functionNamePattern) throws SQLException

- Operation: It returns an empty ResultSet.
- Exception: If an error is returned from the server, it throws SQLException.

getIdentifierQuoteString

`String getIdentifierQuoteString()` throws `SQLException`

- Operation: It returns an identifier quote character. The value that is set on the server is ".
- Exception: If an error is returned from the server, it throws `SQLException`.

getImportedKeys

`ResultSet getImportedKeys(String catalog, String schema, String table)` throws `SQLException`

- Operation: It returns a `ResultSet` including parent key information to which the foreign key column in the given table refers.
- Exception: If an error is returned from the server, it throws `SQLException`.

getIndexInfo

`ResultSet getIndexInfo(String catalog, String schema, String table, boolean unique, boolean approximate)` throws `SQLException`

- Operation: It returns a `ResultSet` including index information of the given table. If `unique` is true, only unique index information is displayed. The `approximate` argument is ignored.
- Exception: If an error is returned from the server, it throws `SQLException`.

getJDBCMajorVersion

`int getJDBCMajorVersion()` throws `SQLException`

- Operation: It returns JDBC major version of GOLDILOCKS JDBC driver. It can vary depending on the jar file in use.
- Exception: It does not occur.

getJDBCMinorVersion

`int getJDBCMinorVersion()` throws `SQLException`

- Operation: It returns JDBC minor version of GOLDILOCKS JDBC driver. It can vary depending on the jar file in use.
- Exception: It does not occur.

getMaxBinaryLiteralLength

`int getMaxBinaryLiteralLength()` throws `SQLException`

- Operation: It gets the maximum binary length from the server. 0 refers that the maximum length is in finite.
- Exception: If an error is returned from the server, it throws `SQLException`.

getMaxCatalogNameLength

`int getMaxCatalogNameLength()` throws `SQLException`

- Operation: It gets the maximum length of the catalog name from the server. 0 refers that the maximum length is infinite.
- Exception: If an error is returned from the server, it throws `SQLException`.

getMaxCharLiteralLength

`int getMaxCharLiteralLength()` throws `SQLException`

- Operation: It gets the maximum literal length from the server. 0 refers that the maximum length is infinite.
- Exception: If an error is returned from the server, it throws `SQLException`.

getMaxColumnNameLength

`int getMaxColumnNameLength()` throws `SQLException`

- Operation: It gets the maximum length of the column name from the server. 0 refers that the maximum length is infinite.
- Exception: If an error is returned from the server, it throws `SQLException`.

getMaxColumnsInGroupBy

`int getMaxColumnsInGroupBy()` throws `SQLException`

- Operation: It gets the maximum number of columns available to use in *group by* clause from the server. 0 refers that the maximum number is infinite.
- Exception: If an error is returned from the server, it throws `SQLException`.

getMaxColumnsInIndex

`int getMaxColumnsInIndex()` throws `SQLException`

- Operation: It gets the maximum number of columns available to use as the index from the server. 0 refers that the maximum number is infinite.
- Exception: If an error is returned from the server, it throws `SQLException`.

getMaxColumnsInOrderBy

`int getMaxColumnsInOrderBy()` throws `SQLException`

- Operation: It gets the maximum number of columns available to use in *order by* clause from the server. 0 refers that the maximum number is infinite.
- Exception: If an error is returned from the server, it throws `SQLException`.

getMaxColumnsInSelect

`int getMaxColumnsInSelect()` throws `SQLException`

- Operation: It gets the maximum number of columns available to use in select target clause from the server. 0 refers that the maximum number is infinite.
- Exception: If an error is returned from the server, it throws `SQLException`.

getMaxColumnsInTable

`int getMaxColumnsInTable()` throws `SQLException`

- Operation: It gets the maximum number of columns available to use in the table from the server. 0 refers that the maximum number is infinite.
- Exception: If an error is returned from the server, it throws `SQLException`.

getMaxConnections

`int getMaxConnections()` throws `SQLException`

- Operation: It gets the maximum number of connection to the server from the server. 0 refers that the maximum number is infinite.
- Exception: If an error is returned from the server, it throws `SQLException`.

getMaxCursorNameLength

`int getMaxCursorNameLength()` throws `SQLException`

- Operation: It gets the maximum length of the cursor name from the server. 0 refers that the maximum length is infinite.
- Exception: If an error is returned from the server, it throws `SQLException`.

getMaxIndexLength

`int getMaxIndexLength()` throws `SQLException`

- Operation: It gets the maximum size for a single index key from the server.
- Exception: If an error is returned from the server, it throws `SQLException`.



The JDBC specification defines that the available maximum size of a single index is returned in bytes, but its value is meaningless, because index size does not have limit. It operates in this way for it to have the same meaning as ODBC.

getMaxProcedureNameLength

`int getMaxProcedureNameLength()` throws `SQLException`

- Operation: It gets the maximum length of the procedure name from the server. 0 refers that the maximum length is infinite.
- Exception: If an error is returned from the server, it throws `SQLException`.

getMaxRowSize

`int getMaxRowSize()` throws `SQLException`

- Operation: It gets the maximum number of rows in a table from the server. 0 refers that the maximum number is infinite.
- Exception: If an error is returned from the server, it throws `SQLException`.

getMaxSchemaNameLength

`int getMaxSchemaNameLength() throws SQLException`

- Operation: It gets the maximum length of the schema name from the server. 0 refers that the maximum length is infinite.
- Exception: If an error is returned from the server, it throws SQLException.

getMaxStatementLength

`int getMaxStatementLength() throws SQLException`

- Operation: It gets the maximum string length of an SQL statement from the server. 0 refers that the maximum length is infinite.
- Exception: If an error is returned from the server, it throws SQLException.

getMaxStatements

`int getMaxStatements() throws SQLException`

- Operation: It gets the maximum number of statements which can be open at once from the server. 0 refers that the maximum number is infinite.
- Exception: If an error is returned from the server, it throws SQLException.

getMaxTableNameLength

`int getMaxTableNameLength() throws SQLException`

- Operation: It gets the maximum string length of the table name from the server. 0 refers that the maximum length is infinite.
- Exception: If an error is returned from the server, it throws SQLException.

getMaxTablesInSelect

`int getMaxTablesInSelect() throws SQLException`

- Operation: It gets the maximum number of tables which can be used in the select statement from the server. 0 refers that the maximum number is infinite.
- Exception: If an error is returned from the server, it throws SQLException.

getMaxUserNameLength

`int getMaxUserNameLength()` throws `SQLException`

- Operation: It gets the maximum string length of the user name from the server. 0 refers that the maximum length is infinite.
- Exception: If an error is returned from the server, it throws `SQLException`.

getNumericFunctions

`String getNumericFunctions()` throws `SQLException`

- Operation: It gets a list of numeric-related functions corresponding to SQL standard from the server. Each function name is distinguished by comma (,).
- Exception: If an error is returned from the server, it throws `SQLException`.

getPrimaryKeys

`ResultSet getPrimaryKeys(String catalog, String schema, String table)` throws `SQLException`

- Operation: It returns a `ResultSet` including all primary keys in a given table.
- Exception: If an error is returned from the server, it throws `SQLException`.

getProcedureColumns

`ResultSet getProcedureColumns(String catalog, String schemaPattern, String procedureNamePattern, String columnNamePattern)` throws `SQLException`

- Operation: It returns a `ResultSet` including column information corresponding to the given name pattern for a given procedure.
- Exception: If an error is returned from the server, it throws `SQLException`.

getProcedures

`ResultSet getProcedures(String catalog, String schemaPattern, String procedureNamePattern)` throws `SQLException`

- Operation: It returns a `ResultSet` including procedure information of a given name pattern.
- Exception: If an error is returned from the server, it throws `SQLException`.

getProcedureTerm

String getProcedureTerm() throws SQLException

- Operation: It gets the keyword which refers to the procedure from the server.
- Exception: If an error is returned from the server, it throws SQLException.

getResultSetHoldability

int getResultSetHoldability() throws SQLException

- Operation: It returns the default holdability property of ResultSet. It is ResultSet.HOLD_CURSORS_OVER_COMMIT.
- Exception: It does not occur.

getRowIdLifetime

RowIdLifetime getRowIdLifetime() throws SQLException

- Operation: It always returns RowIdLifetime.ROWID_VALID_FOREVER.
- Exception: It does not occur.

getSchemas

ResultSet getSchemas() throws SQLException

- Operation: It returns a ResultSet including information about all schemas in the server.
- Exception: If an error is returned from the server, it throws SQLException.

ResultSet getSchemas(String catalog, String schemaPattern) throws SQLException

- Operation: It returns a ResultSet including information for all schemas which meet the pattern of a given schema name. The catalog is ignored.
- Exception: If an error is returned from the server, it throws SQLException.

getSchemaTerm

String getSchemaTerm() throws SQLException

- Operation: It gets the keyword which refers to the schema from the server.

- Exception: If an error is returned from the server, it throws `SQLException`.

getSearchStringEscape

`String getSearchStringEscape()` throws `SQLException`

- Operation: It returns the escape characters used in *like* clause as a string.
- Exception: If an error is returned from the server, it throws `SQLException`.

getSQLKeywords

`String getSQLKeywords()` throws `SQLException`

- Operation: It returns the keywords which can not be used in SQL statement, separated by comma (,).
- Exception: If an error is returned from the server, it throws `SQLException`.

getSQLStateType

`int getSQLStateType()` throws `SQLException`

- Operation: It always returns `DatabaseMetaData.sqlStateSQL99`.
- Exception: It does not occur.

getStringFunctions

`String getStringFunctions()` throws `SQLException`

- Operation: It gets a list of functions which handle the strings and corresponds to SQL standard. Each function name is distinguished by comma (,).
- Exception: If an error is returned from the server, it throws `SQLException`.

getSuperTables

`ResultSet getSuperTables(String catalog, String schemaPattern, String tableNamePattern)` throws `SQLException`

- Operation: It returns an empty `ResultSet`.
- Exception: If an error is returned from the server, it throws `SQLException`.

getSuperTypes

ResultSet getSuperTypes(String catalog, String schemaPattern, String typeNamePattern) throws SQLException

- Operation: It returns an empty ResultSet.
- Exception: If an error is returned from the server, it throws SQLException.

getSystemFunctions

String getSystemFunctions() throws SQLException

- Operation: It gets a list of system functions corresponding to SQL standard. Each function name is separated by the comma (,).
- Exception: If an error is returned from the server, it throws SQLException.

getTablePrivileges

ResultSet getTablePrivileges(String catalog, String schemaPattern, String tableNamePattern) throws SQLException

- Operation: It returns a ResultSet including privilege information of all tables which satisfy the condition.
- Exception: If an error is returned from the server, it throws SQLException.

getTables

ResultSet getTables(String catalog, String schemaPattern, String tableNamePattern, String[] types) throws SQLException

- Operation: It returns a ResultSet including information of all tables which satisfy the condition.
- Exception: If an error is returned from the server, it throws SQLException.

getTableTypes

ResultSet getTableTypes() throws SQLException

- Operation: It returns a ResultSet containing information of all table types.
- Exception: If an error is returned from the server, it throws SQLException.

getTimeDateFunctions

String getTimeDateFunctions() throws SQLException

- Operation: It gets functions which are related to time and date and corresponds to SQL standard. Each function name is separated by the comma(,).
- Exception: If an error is returned from the server, it throws SQLException.

getTypeInfo

ResultSet getTypeInfo() throws SQLException

- Operation: It returns a ResultSet including information of the data type.
- Exception: If an error is returned from the server, it throws SQLException.

getUDTs

ResultSet getUDTs(String catalog, String schemaPattern, String typeNamePattern, int[] types) throws SQLException

- Operation: It returns an empty ResultSet.
- Exception: If an error is returned from the server, it throws SQLException.

getURL

String getURL() throws SQLException

- Operation: It returns the URL used to connect to the server.
- Exception: It does not occur.

getUserName

String getUserName() throws SQLException

- Operation: It returns the current user name which maintains a session.
- Exception: If an error is returned from the server, it throws SQLException.



A user name may be different from the user name used to connect firstly because the user can be changed during a session.

getVersionColumns

`ResultSet getVersionColumns(String catalog, String schema, String table)` throws `SQLException`

- Operation: It returns an empty `ResultSet`.
- Exception: If an error is returned from the server, it throws `SQLException`.

insertsAreDetected

`boolean insertsAreDetected(int type)` throws `SQLException`

- Operation: It always returns false regardless of the type.
- Exception: It does not occur.

isCatalogAtStart

`boolean isCatalogAtStart()` throws `SQLException`

- Operation: It always returns false.
- Exception: It does not occur.

isReadOnly

`boolean isReadOnly()` throws `SQLException`

- Operation: It gets the information whether the current connection is the read only mode from the server.
- Exception: If an error is returned from the server, it throws `SQLException`.

locatorsUpdateCopy

`boolean locatorsUpdateCopy()` throws `SQLException`

- Operation: It always returns false.
- Exception: It does not occur.

nullPlusNonNullsNull

`boolean nullPlusNonNullIsNull()` throws `SQLException`

- Operation: It always returns true.
- Exception: It does not occur.

nullsAreSortedAtEnd

`boolean nullsAreSortedAtEnd()` throws `SQLException`

- Operation: It always returns false. It does not separately sort null.
- Exception: It does not occur.

nullsAreSortedAtStart

`boolean nullsAreSortedAtStart()` throws `SQLException`

- Operation: It always returns false. It does not separately sort null.
- Exception: It does not occur.

nullsAreSortedHigh

`boolean nullsAreSortedHigh()` throws `SQLException`

- Operation: It always returns true. Null is positioned at last by default.
- Exception: It does not occur.

nullsAreSortedLow

`boolean nullsAreSortedLow()` throws `SQLException`

- Operation: It always returns false. Null is positioned at last by default.
- Exception: It does not occur.

othersDeletesAreVisible

`boolean othersDeletesAreVisible(int type)` throws `SQLException`

- Operation: If the type is `ResultSet.TYPE_SCROLL_SENSITIVE`, it returns true. Otherwise, it returns false.
- Exception: It does not occur.

othersInsertsAreVisible

`boolean othersInsertsAreVisible(int type)` throws `SQLException`

- Operation: It always returns false regardless of the type.
- Exception: It does not occur.

othersUpdatesAreVisible

`boolean othersUpdatesAreVisible(int type)` throws `SQLException`

- Operation: If the type is `ResultSet.TYPE_SCROLL_SENSITIVE`, it returns true. Otherwise, it returns false.
- Exception: It does not occur.

ownDeletesAreVisible

`boolean ownDeletesAreVisible(int type)` throws `SQLException`

- Operation: If the type is `ResultSet.TYPE_SCROLL_SENSITIVE`, it returns true. Otherwise, it returns false.
- Exception: It does not occur.

ownInsertsAreVisible

`boolean ownInsertsAreVisible(int type)` throws `SQLException`

- Operation: It always returns false regardless of the type.
- Exception: It does not occur.

ownUpdatesAreVisible

`boolean ownUpdatesAreVisible(int type)` throws `SQLException`

- Operation: If the type is `ResultSet.TYPE_SCROLL_SENSITIVE`, it returns true. Otherwise, it returns false.
- Exception: It does not occur.

storesLowerCaseIdentifiers

`boolean storesLowerCaseIdentifiers()` throws `SQLException`

- Operation: It always returns false.
- Exception: It does not occur.

storesLowerCaseQuotedIdentifiers

`boolean storesLowerCaseQuotedIdentifiers()` throws `SQLException`

- Operation: It always returns false.
- Exception: It does not occur.

storesMixedCaseIdentifiers

`boolean storesMixedCaseIdentifiers()` throws `SQLException`

- Operation: It always returns false.
- Exception: It does not occur.

storesMixedCaseQuotedIdentifiers

`boolean storesMixedCaseQuotedIdentifiers()` throws `SQLException`

- Operation: It always returns true.
- Exception: It does not occur.

storesUpperCaseIdentifiers

`boolean storesUpperCaseIdentifiers()` throws `SQLException`

- Operation: It always returns true.
- Exception: It does not occur.

storesUpperCaseQuotedIdentifiers

`boolean storesUpperCaseQuotedIdentifiers()` throws `SQLException`

- Operation: It always returns false.
- Exception: It does not occur.

supportsAlterTableWithAddColumn

`boolean supportsAlterTableWithAddColumn()` throws `SQLException`

- Operation: It always returns true.
- Exception: It does not occur.

supportsAlterTableWithDropColumn

`boolean supportsAlterTableWithDropColumn()` throws `SQLException`

- Operation: It always returns true.
- Exception: It does not occur.

supportsANSI92EntryLevelSQL

`boolean supportsANSI92EntryLevelSQL()` throws `SQLException`

- Operation: It always returns false.
- Exception: It does not occur.

supportsANSI92FullSQL

`boolean supportsANSI92FullSQL()` throws `SQLException`

- Operation: It always returns false.
- Exception: It does not occur.

supportsANSI92IntermediateSQL

`boolean supportsANSI92IntermediateSQL()` throws `SQLException`

- Operation: It always returns false.
- Exception: It does not occur.

supportsBatchUpdates

`boolean supportsBatchUpdates()` throws `SQLException`

- Operation: It always returns true.
- Exception: It does not occur.

supportsCatalogsInDataManipulation

`boolean supportsCatalogsInDataManipulation()` throws `SQLException`

- Operation: It always returns false.
- Exception: It does not occur.

supportsCatalogsInIndexDefinitions

`boolean supportsCatalogsInIndexDefinitions()` throws `SQLException`

- Operation: It always returns false.
- Exception: It does not occur.

supportsCatalogsInPrivilegeDefinitions

`boolean supportsCatalogsInPrivilegeDefinitions()` throws `SQLException`

- Operation: It always returns false.
- Exception: It does not occur.

supportsCatalogsInProcedureCalls

`boolean supportsCatalogsInProcedureCalls()` throws `SQLException`

- Operation: It always returns false.
- Exception: It does not occur.

supportsCatalogsInTableDefinitions

`boolean supportsCatalogsInTableDefinitions()` throws `SQLException`

- Operation: It always returns false.
- Exception: It does not occur.

supportsColumnAliasing

`boolean supportsColumnAliasing()` throws `SQLException`

- Operation: It gets information whether to support the column aliasing from the server.
- Exception: If an error is returned from the server, it throws `SQLException`.

supportsConvert

`boolean supportsConvert()` throws `SQLException`

- Operation: It always returns false.
- Exception: It does not occur.

supportsConvert

`boolean supportsConvert(int fromType, int toType)` throws `SQLException`

- Operation: It always returns false.
- Exception: It does not occur.

supportsCoreSQLGrammar

`boolean supportsCoreSQLGrammar()` throws `SQLException`

- Operation: It always returns true.
- Exception: It does not occur.

supportsCorrelatedSubqueries

`boolean supportsCorrelatedSubqueries()` throws `SQLException`

- Operation: It always returns true.
- Exception: It does not occur.

supportsDataDefinitionAndDataManipulationTransactions

boolean supportsDataDefinitionAndDataManipulationTransactions() throws SQLException

- Operation: It always returns true. It can perform DML and DDL with a single transaction.
- Exception: It does not occur.

supportsDataManipulationTransactionsOnly

boolean supportsDataManipulationTransactionsOnly() throws SQLException

- Operation: It always returns false.
- Exception: It does not occur.

supportsDifferentTableCorrelationNames

boolean supportsDifferentTableCorrelationNames() throws SQLException

- Operation: It gets information whether the table correlation name should be different from the table name from the server.
- Exception: If an error is returned from the server, it throws SQLException.

supportsExpressionsInOrderBy

boolean supportsExpressionsInOrderBy() throws SQLException

- Operation: It gets information whether the calculation can be used in *order by* clause from the server.
- Exception: If an error is returned from the server, it throws SQLException.

supportsExtendedSQLGrammar

boolean supportsExtendedSQLGrammar() throws SQLException

- Operation: It always returns true.
- Exception: It does not occur.

supportsFullOuterJoins

`boolean supportsFullOuterJoins()` throws `SQLException`

- Operation: It always returns true.
- Exception: It does not occur.

supportsGetGeneratedKeys

`boolean supportsGetGeneratedKeys()` throws `SQLException`

- Operation: It always returns false.
- Exception: It does not occur.

supportsGroupBy

`boolean supportsGroupBy()` throws `SQLException`

- Operation: It always returns true.
- Exception: It does not occur.

supportsGroupByBeyondSelect

`boolean supportsGroupByBeyondSelect()` throws `SQLException`

- Operation: It always returns true.
- Exception: It does not occur.

supportsGroupByUnrelated

`boolean supportsGroupByUnrelated()` throws `SQLException`

- Operation: It always returns true.
- Exception: It does not occur.

supportsIntegrityEnhancementFacility

`boolean supportsIntegrityEnhancementFacility()` throws `SQLException`

- Operation: It gets information whether to support SQL integrity enhancing feature from the server.
- Exception: If an error is returned from the server, it throws `SQLException`.

supportsLikeEscapeClause

`boolean supportsLikeEscapeClause()` throws `SQLException`

- Operation: It gets information whether to support escape clause in like statement from the server.
- Exception: If an error is returned from the server, it throws `SQLException`.

supportsLimitedOuterJoins

`boolean supportsLimitedOuterJoins()` throws `SQLException`

- Operation: It always returns true.
- Exception: It does not occur.

supportsMinimumSQLGrammar

`boolean supportsMinimumSQLGrammar()` throws `SQLException`

- Operation: It always returns true.
- Exception: It does not occur.

supportsMixedCaseIdentifiers

`boolean supportsMixedCaseIdentifiers()` throws `SQLException`

- Operation: It always returns false.
- Exception: It does not occur.

supportsMixedCaseQuotedIdentifiers

`boolean supportsMixedCaseQuotedIdentifiers()` throws `SQLException`

- Operation: It always returns true.
- Exception: It does not occur.

supportsMultipleOpenResults

`boolean supportsMultipleOpenResults()` throws `SQLException`

- Operation: It always returns false.
- Exception: It does not occur.

supportsMultipleResultSets

`boolean supportsMultipleResultSets()` throws `SQLException`

- Operation: It always returns false.
- Exception: It does not occur.

supportsMultipleTransactions

`boolean supportsMultipleTransactions()` throws `SQLException`

- Operation: It always returns true.
- Exception: It does not occur.

supportsNamedParameters

`boolean supportsNamedParameters()` throws `SQLException`

- Operation: It always returns false.
- Exception: It does not occur.

supportsNonNullableColumns

`boolean supportsNonNullableColumns()` throws `SQLException`

- Operation: It always returns true.
- Exception: It does not occur.

supportsOpenCursorsAcrossCommit

`boolean supportsOpenCursorsAcrossCommit()` throws `SQLException`

- Operation: It always returns true.
- Exception: It does not occur.

supportsOpenCursorsAcrossRollback

`boolean supportsOpenCursorsAcrossRollback()` throws `SQLException`

- Operation: It always returns true.
- Exception: It does not occur.

supportsOpenStatementsAcrossCommit

`boolean supportsOpenStatementsAcrossCommit()` throws `SQLException`

- Operation: It always returns true.
- Exception: It does not occur.

supportsOpenStatementsAcrossRollback

`boolean supportsOpenStatementsAcrossRollback()` throws `SQLException`

- Operation: It always returns true.
- Exception: It does not occur.

supportsOrderByUnrelated

`boolean supportsOrderByUnrelated()` throws `SQLException`

- Operation: It always returns true.
- Exception: It does not occur.

supportsOuterJoins

`boolean supportsOuterJoins()` throws `SQLException`

- Operation: It always returns true.
- Exception: It does not occur.

supportsPositionedDelete

`boolean supportsPositionedDelete()` throws `SQLException`

- Operation: It always returns false.
- Exception: It does not occur.

supportsPositionedUpdate

`boolean supportsPositionedUpdate()` throws `SQLException`

- Operation: It always returns false.
- Exception: It does not occur.

supportsResultSetConcurrency

`boolean supportsResultSetConcurrency(int type, int concurrency)` throws `SQLException`

- Operation: It returns true for all `ResultSet` types and all concurrency. It returns false for the invalid arguments.
- Exception: It does not occur.

supportsResultSetHoldability

`boolean supportsResultSetHoldability(int holdability)` throws `SQLException`

- Operation: If the holdability is `ResultSet.CLOSE_CURSORS_AT_COMMIT` or `ResultSet.HOLD_CURSORS_S_OVER_COMMIT`, it returns true. Otherwise, it returns false.
- Exception: It does not occur.

supportsResultSetType

`boolean supportsResultSetType(int type)` throws `SQLException`

- Operation: If the type is `ResultSet.TYPE_FORWARD_ONLY`, `ResultSet.TYPE_SCROLL_INSENSITIVE` or `ResultSet.TYPE_SCROLL_SENSITIVE`, it returns true. Otherwise, it returns false.
- Exception: It does not occur.

supportsSavepoints

boolean supportsSavepoints() throws SQLException

- Operation: It always returns true.
- Exception: It does not occur.

supportsSchemasInDataManipulation

boolean supportsSchemasInDataManipulation() throws SQLException

- Operation: It always returns true.
- Exception: It does not occur.

supportsSchemasInIndexDefinitions

boolean supportsSchemasInIndexDefinitions() throws SQLException

- Operation: It always returns true.
- Exception: It does not occur.

supportsSchemasInPrivilegeDefinitions

boolean supportsSchemasInPrivilegeDefinitions() throws SQLException

- Operation: It always returns true.
- Exception: It does not occur.

supportsSchemasInProcedureCalls

boolean supportsSchemasInProcedureCalls() throws SQLException

- Operation: It always returns true.
- Exception: It does not occur.

supportsSchemasInTableDefinitions

`boolean supportsSchemasInTableDefinitions()` throws `SQLException`

- Operation: It always returns true.
- Exception: It does not occur.

supportsSelectForUpdate

`boolean supportsSelectForUpdate()` throws `SQLException`

- Operation: It always returns true.
- Exception: It does not occur.

supportsStatementPooling

`boolean supportsStatementPooling()` throws `SQLException`

- Operation: It always returns false.
- Exception: It does not occur.

supportsStoredFunctionsUsingCallSyntax

`boolean supportsStoredFunctionsUsingCallSyntax()` throws `SQLException`

- Operation: It always returns false.
- Exception: It does not occur.

supportsStoredProcedures

`boolean supportsStoredProcedures()` throws `SQLException`

- Operation: It always returns true.
- Exception: It does not occur.

supportsSubqueriesInComparisons

`boolean supportsSubqueriesInComparisons()` throws `SQLException`

- Operation: It always returns true.
- Exception: It does not occur.

supportsSubqueriesInExists

boolean supportsSubqueriesInExists() throws SQLException

- Operation: It always returns true.
- Exception: It does not occur.

supportsSubqueriesInIns

boolean supportsSubqueriesInIns() throws SQLException

- Operation: It always returns true.
- Exception: It does not occur.

supportsSubqueriesInQuantifieds

boolean supportsSubqueriesInQuantifieds() throws SQLException

- Operation: It always returns true.
- Exception: It does not occur.

supportsTableCorrelationNames

boolean supportsTableCorrelationNames() throws SQLException

- Operation: It gets information whether to support the table correlation name from the server.
- Exception: If an error is returned from the server, it throws SQLException.

supportsTransactionIsolationLevel

boolean supportsTransactionIsolationLevel(int level) throws SQLException

- Operation: It gets information whether to support the transaction isolation level from the server.
- Exception: If an error is returned from the server, it throws SQLException.

supportsTransactions

`boolean supportsTransactions()` throws `SQLException`

- Operation: It always returns true.
- Exception: It does not occur.

`supportsUnion`

`boolean supportsUnion()` throws `SQLException`

- Operation: It gets information whether to support the union operation from the server.
- Exception: If an error is returned from the server, it throws `SQLException`.

`supportsUnionAll`

`boolean supportsUnionAll()` throws `SQLException`

- Operation: It gets information whether to support the union all operation from the server.
- Exception: If an error is returned from the server, it throws `SQLException`.

`updatesAreDetected`

`boolean updatesAreDetected(int type)` throws `SQLException`

- Operation: If the type is `ResultSet.TYPE_SCROLL_SENSITIVE`, it returns true. Otherwise, it returns false.
- Exception: It does not occur.

`usesLocalFilePerTable`

`boolean usesLocalFilePerTable()` throws `SQLException`

- Operation: It always returns false.
- Exception: It does not occur.

`usesLocalFiles`

`boolean usesLocalFiles()` throws `SQLException`

- Operation: It always returns false.
- Exception: It does not occur.

DataSource

getConnection

Connection getConnection() throws SQLException

- Operation: It opens and returns a new connection object. The information required for connection should be set through a separate non-standard method in advance.
- Exception: If the connection to the server fails, it throws SQLException.

Connection getConnection(String username, String password) throws SQLException

- Operation: It opens and returns a new connection object with the username and password. Other information required for the connection should be set through a separate non-standard method in advance.
- Exception: If the connection to the server fails, it throws SQLException.

isWrapperFor

boolean isWrapperFor(Class<?> iface) throws SQLException

- Operation: This class is not implemented as the wrapper of any other class. If the object is an instance of iface, it returns true. Otherwise, it returns false.
- Exception: It does not occur.

unwrap

<T> T unwrap(Class<T> iface) throws SQLException

- Operation: It *returns* this because this class is not implemented as the wrapper of any other class.
- Exception: If the object is not an instance of iface, it throws SQLException.

Driver

acceptsURL

`boolean acceptsURL(String url)` throws `SQLException`

- Operation: If the url is not null and it starts with "jdbc:goldilocks:", it returns true. Otherwise, it returns false.
- Exception: It does not occur.

connect

`Connection connect(String url, Properties info)` throws `SQLException`

- Operation: It creates and returns a new connection object. The url should include the server address, DB name and port.
- Exception: If the url is invalid or the connection from the server fails, it throws `SQLException`.

getMajorVersion

`int getMajorVersion()` throws `SQLException`

- Operation: It returns the major version of GOLDILOCKS JDBC driver.
- Exception: It does not occur.

getMinorVersion

`int getMinorVersion()` throws `SQLException`

- Operation: It returns the minor version of GOLDILOCKS JDBC driver.
- Exception: It does not occur.

getPropertyInfo

`DriverPropertyInfo[] getPropertyInfo(String url, Properties info)` throws `SQLException`

- Operation: It gets the list of available property when GOLDILOCKS JDBC driver is connected.
- Exception: It does not occur.

jdbcCompliant

`boolean jdbcCompliant()` throws `SQLException`

- Operation: It always returns false.
- Exception: It does not occur.

NClob

This class is not implemented.

free

| void free() throws SQLException

getAsciiStream

| InputStream getAsciiStream() throws SQLException

getCharacterStream

| Reader getCharacterStream() throws SQLException

| Reader getCharacterStream(long pos, long length) throws SQLException

getSubString

| String getSubString(long pos, int length) throws SQLException

length

| long length() throws SQLException

position

| long position(Clob searchstr, long start) throws SQLException

| long position(String searchstr, long start) throws SQLException

setAsciiStream

| OutputStream setAsciiStream(long pos) throws SQLException

setCharacterStream

| Writer setCharacterStream(long pos) throws SQLException

setString

| int setString(long pos, String str) throws SQLException

| int setString(long pos, String str, int offset, int len) throws SQLException

truncate

| void truncate(long len) throws SQLException

ParameterMetaData

ParameterMetaData object is returned by PreparedStatement.getParameterMetaData(). The parameterMetaData of the GOLDILOCKS JDBC does not use the actual DB information but it is based on the basic type varchar for other information (such as type, etc.) except for in/out. It is because in/out is the only information got from the server on the parameter after prepared. For example, if it is prepared with the query statement which is "Select * from t1 where a =?", the parameter type used in the condition clause is not determined. The server generally assumes it a varchar type.

getParameterClassName

String getParameterClassName(int param) throws SQLException

- Operation: It returns java.lang.String. The parameter type is regarded as varchar.
- Exception: If the param value exceeds the range of the number of parameters, it throws SQLException.

getParameterCount

int getParameterCount() throws SQLException

- Operation: It returns the number of parameters. It is also the number of ? used in the query statement.
- Exception: It does not occur.

getParameterMode

int getParameterMode(int param) throws SQLException

- Operation: It returns the in/out mode of the param-th parameter. It returns one of ParameterMetaData.parameterModeIn, ParameterMetaData.parameterModeInOut, ParameterMetaData.parameterModeOut, or ParameterMetaData.parameterModeUnknown. The case of returning parameterModeUnknown value does not exist until now.
- Exception: If the param value exceeds range of the number of parameters, it throws SQLException.

getParameterType

`int getParameterType(int param)` throws `SQLException`

- Operation: It returns `Types.VARCHAR` for all parameters.
- Exception: If the param value exceeds range of the number of parameters, it throws `SQLException`.

getParameterTypeName

`String getParameterTypeName(int param)` throws `SQLException`

- Operation: It returns "VARCHAR" for all parameters.
- Exception: If the param value exceeds range of the number of parameters, it throws `SQLException`.

getPrecision

`int getPrecision(int param)` throws `SQLException`

- Operation: It returns 4000 for all parameters. The parameter is regarded as `varchar(4000)` by default.
- Exception: If the param value exceeds range of the number of parameters, it throws `SQLException`.

getScale

`int getScale(int param)` throws `SQLException`

- Operation: It returns 0 for all parameters. The parameter is regarded as `varchar(4000)` by default.
- Exception: If the param value exceeds range of the number of parameters, it throws `SQLException`.

isNullable

`int isNullable(int param)` throws `SQLException`

- Operation: It always returns `ParameterMetaData.parameterNullableUnknown`.
- Exception: If the param value exceeds range of the number of parameters, it throws `SQLException`.

isSigned

`boolean isSigned(int param)` throws `SQLException`

- Operation: It always returns false.
- Exception: If the param value exceeds range of the number of parameters, it throws `SQLException`.

isWrapperFor

`boolean isWrapperFor(Class<?> iface) throws SQLException`

- Operation: It enquires if it the object is an instance of iface. If so, it returns true. Otherwise, it returns false.
- Exception: It does not occur.

unwrap

`<T> T unwrap(Class<T> iface) throws SQLException`

- Operation: If the object is an instance of iface, it casts this object to iface type and returns it.
- Exception: If the object is not an instance of iface, it throws SQLException.

PooledConnection

addConnectionEventListener

`void addConnectionEventListener(ConnectionEventListener listener) throws SQLException`

- Operation: It registers the `ConnectionEventListener` object. After then, if `close()` of the connection object (logical connection) which is returned from `PooledConnection` is called or the actual connection is broken, `ConnectionEvent` is generated to the registered listeners.
- Exception: It does not occur.

addStatementEventListener

`void addStatementEventListener(StatementEventListener listener) throws SQLException`

- Operation: It does not perform any operation. `GOLDILOCKS` JDBC driver does not implement the method. Statement pooling feature is performed by the external middleware.
- Exception: It does not occur.

close

`void close() throws SQLException`

- Operation: It calls `close()` of the physical connection that the object has.
- Exception: It may occur in `close()` of physical connection.

getConnection

`Connection getConnection() throws SQLException`

- Operation: It returns logical connection owned by the object.
- Exception: It does not occur.

removeConnectionEventListener

`void removeConnectionEventListener(ConnectionEventListener listener) throws SQLException`

- Operation: It removes the registered `ConnectionEventListener`. After then, `ConnectionEvent` is not transferred to this listener.

- Exception: It does not occur.

removeStatementEventListener

`void removeStatementEventListener(StatementEventListener listener) throws SQLException`

- Operation: It does not perform any operation.
- Exception: It does not occur.

PreparedStatement

addBatch

`void addBatch()` throws `SQLException`

- Operation: It registers the currently bound data as batch job. If any of this batch job is registered, an error occurs when performing `execute ()`, `executeUpdate ()`, `executeQuery ()` execution. If any one is not bound for the parameter, an error occurs. After `addBatch` if another `addBatch` is performed again at the state without binding with the method of `setXXX ()` type, it registers the batch job as the previously bound value.
- Exception: If a parameter which has never been bound exists, it throws an exception.

clearParameters

`void clearParameters()` throws `SQLException`

- Operation: It removes all of currently bound data and information. But if at least one batch job is registered, operation is not performed.
- Exception: It does not occur.

execute

`boolean execute()` throws `SQLException`

- Operation: It executes the prepared statement based on the bound data to the current parameter. If the executed statement is the select statement, it returns true and gets a `ResultSet` from the object. Otherwise, it returns false.
- Exception: If the batch job is registered, the bound parameters are insufficient or an error occurs on the server when executing, it throws an exception.

executeQuery

`ResultSet executeQuery()` throws `SQLException`

- Operation: It executes the prepared statement based on the bound data to the current parameter and fetches, then creates and returns a `ResultSet` object.
- Exception: If the batch job is registered or the bound parameters are insufficient or an error occurs on the server when executing, it throws an exception.

executeUpdate

`int executeUpdate()` throws `SQLException`

- Operation: It executes the prepared statement based on the bound data to the current parameter. It returns the number of updated records. If updated record with DDL statements does not exist, it returns 0.
- Exception: If the batch job is registered or the statement is not a select statement or the bound parameters are insufficient or an error occurs on the server when executing, it throws an exception.

getMetaData

`ResultSetMetaData getMetaData()` throws `SQLException`

- Operation: It gets `ResultSetMetaData` object. If the prepared statement is not the select statement (It is the statement which does not return `ResultSet`), it returns an empty `ResultSetMetaData`. The method can be called before executing.
- Exception: If an error occurs on the server, it throws an exception.

getParameterMetaData

`ParameterMetaData getParameterMetaData()` throws `SQLException`

- Operation: It gets the `ParameterMetaData` object. It can be called before executing. However, all parameters are assumed to be `varchar(4000)` because information about the exact parameter type is not known to the server.
- Exception: If an error occurs on the server, it throws an exception.

setArray

`void setArray(int parameterIndex, Array x)` throws `SQLException`

- Operation: It is not implemented.
- Exception: It always throws `SQLFeatureNotSupportedException`.

setAsciiStream

`void setAsciiStream(int parameterIndex, InputStream x)` throws `SQLException`

- Operation: It binds the `InputStream` object to the parameter index as `LONG VARCHAR` type. It does not

ot execute the encoding operation because the input data is a binary form. It does not consider the character set and assumes it as ascii data.

- Exception: It occurs if parameterIndex is smaller than 0 or it is bigger than the number of parameters.



The cost of conversion to VARCHAR occurs in the server because it is bound to LONG VARCHAR. If the length can be known, it is recommended to use void setAsciiStream(int parameterIndex, InputStream x, int length).

void setAsciiStream(int parameterIndex, InputStream x, int length) throws SQLException

- Operation: It binds the InputStream object to the parameter index as LONG VARCHAR type. It does not execute the encoding operation because the input data is a binary form. It does not consider the character set and assumes it as ascii data. If English data is inserted or the server client character set environment is identical, this method is faster than setCharacterStream or setString when inserting the string as varchar.
- Exception: It occurs if parameterIndex is smaller than 0 or it is bigger than the number of parameters.

void setAsciiStream(int parameterIndex, InputStream x, long length) throws SQLException

- Operation: It binds the InputStream object to the parameter index as LONG VARCHAR type. It does not execute the encoding operation because the input data is a binary form. It does not consider the character set and assumes it as ascii data. If English data is inserted or the server client character set environment is identical, this method is faster than setCharacterStream or setString when inserting the string as varchar.
- Exception: It occurs if parameterIndex is smaller than 0 or it is bigger than the number of parameters.

setBigDecimal

void setBigDecimal(int parameterIndex, BigDecimal x) throws SQLException

- Operation: It binds the BigDecimal object to the parameter index as NUMBER type.
- Exception: It occurs if parameterIndex is smaller than 0 or it is bigger than the number of parameters.

setBinaryStream

void setBinaryStream(int parameterIndex, InputStream x) throws SQLException

- Operation: It binds the InputStream object to the parameter index as LONG VARBINARY type.
- Exception: It occurs if parameterIndex is smaller than 0 or it is bigger than the number of parameters.

`void setBinaryStream(int parameterIndex, InputStream x, int length) throws SQLException`

- Operation: It binds the `InputStream` object to the parameter index as `LONG VARBINARY` type.
- Exception: It occurs if `parameterIndex` is smaller than 0 or it is bigger than the number of parameters.

`void setBinaryStream(int parameterIndex, InputStream x, long length) throws SQLException`

- Operation: It binds the `InputStream` object to the parameter index as `LONG VARBINARY` type.
- Exception: It occurs if `parameterIndex` is smaller than 0 or it is bigger than the number of parameters.

setBlob

`void setBlob(int parameterIndex, Blob x) throws SQLException`

- Operation: It is not implemented.
- Exception: It always throws `SQLFeatureNotSupportedException`.

`void setBlob(int parameterIndex, InputStream inputStream) throws SQLException`

- Operation: It is not implemented.
- Exception: It always throws `SQLFeatureNotSupportedException`.

`void setBlob(int parameterIndex, InputStream inputStream, long length) throws SQLException`

- Operation: It is not implemented.
- Exception: It always throws `SQLFeatureNotSupportedException`.

setBoolean

`void setBoolean(int parameterIndex, boolean x) throws SQLException`

- Operation: It binds the data `x` to the parameter index as `BOOLEAN` type.
- Exception: It occurs if `parameterIndex` is smaller than 0 or it is bigger than the number of parameters.

setByte

`void setByte(int parameterIndex, byte x) throws SQLException`

- Operation: It binds the data `x` to the parameter index as `NATIVE_SMALLINT` type.
- Exception: It occurs if `parameterIndex` is smaller than 0 or it is bigger than the number of parameters.

setBytes

`void setBytes(int parameterIndex, byte[] x) throws SQLException`

- Operation: It binds the data `x` to the parameter index as `VARBINARY` or `LONG VARBINARY` type. If the length of `x` is equal to or smaller than 4000, it is bound as `VARBINARY`, and if it is bigger than 4000, it is bound as `LONG VARBINARY` type.
- Exception: It occurs if `parameterIndex` is smaller than 0 or it is bigger than the number of parameters.

setCharacterStream

`void setCharacterStream(int parameterIndex, Reader reader) throws SQLException`

- Operation: It binds the reader object to the parameter index as `LONG VARCHAR` type.
- Exception: It occurs if `parameterIndex` is smaller than 0 or it is bigger than the number of parameters.

`void setCharacterStream(int parameterIndex, Reader reader, int length) throws SQLException`

- Operation: It binds the reader object to the parameter index as `LONG VARCHAR` type.
- Exception: It occurs if `parameterIndex` is smaller than 0 or it is bigger than the number of parameters.

`void setCharacterStream(int parameterIndex, Reader reader, long length) throws SQLException`

- Operation: It binds the reader object to the parameter index as `LONG VARCHAR` type.
- Exception: It occurs if `parameterIndex` is smaller than 0 or it is bigger than the number of parameters.

setClob

`void setClob(int parameterIndex, Clob x) throws SQLException`

- Operation: It is not implemented.
- Exception: It always throws `SQLFeatureNotSupportedException`.

`void setClob(int parameterIndex, Reader reader) throws SQLException`

- Operation: It is not implemented.
- Exception: It always throws `SQLFeatureNotSupportedException`.

`void setClob(int parameterIndex, Reader reader, long length) throws SQLException`

- Operation: It is not implemented.

- Exception: It always throws `SQLFeatureNotSupportedException`.

setDate

`void setDate(int parameterIndex, Date x) throws SQLException`

- Operation: It binds the data `x` to the parameter index as `DATE` type. It is equivalent to calling `setDate(parameterIndex, x, Calendar.getInstance())`. The local timezone is applied.
- Exception: It occurs if `parameterIndex` is smaller than 0 or it is bigger than the number of parameters.

`void setDate(int parameterIndex, Date x, Calendar cal) throws SQLException`

- Operation: It binds the data `x` to the parameter index as `DATE` type. Date `x` is regarded as timezone of `cal`.
- Exception: It occurs if `parameterIndex` is smaller than 0 or it is bigger than the number of parameters.

setDouble

`void setDouble(int parameterIndex, double x) throws SQLException`

- Operation: It binds the data `x` to the parameter index as `NATIVE_DOUBLE` type.
- Exception: It occurs if `parameterIndex` is smaller than 0 or it is bigger than the number of parameters.

setFloat

`void setFloat(int parameterIndex, float x) throws SQLException`

- Operation: It binds the data `x` to the parameter index as `NATIVE_REAL` type.
- Exception: It occurs if `parameterIndex` is smaller than 0 or it is bigger than the number of parameters.

setInt

`void setInt(int parameterIndex, int x) throws SQLException`

- Operation: It binds the data `x` to the parameter index as `NATIVE_INTEGER` type.
- Exception: It occurs if `parameterIndex` is smaller than 0 or it is bigger than the number of parameters.

setLong

`void setLong(int parameterIndex, long x) throws SQLException`

- Operation: It binds the data `x` to the parameter index as `NATIVE_BIGINT` type.
- Exception: It occurs if `parameterIndex` is smaller than 0 or it is bigger than the number of parameters.

setNCharacterStream

`void setNCharacterStream(int parameterIndex, Reader value) throws SQLException`

- Operation: It is not implemented.
- Exception: It always throws `SQLFeatureNotSupportedException`.

`void setNCharacterStream(int parameterIndex, Reader value, long length) throws SQLException`

- Operation: It is not implemented.
- Exception: It always throws `SQLFeatureNotSupportedException`.

setNClob

`void setNClob(int parameterIndex, NClob value) throws SQLException`

- Operation: It is not implemented.
- Exception: It always throws `SQLFeatureNotSupportedException`.

`void setNClob(int parameterIndex, Reader reader) throws SQLException`

- Operation: It is not implemented.
- Exception: It always throws `SQLFeatureNotSupportedException`.

`void setNClob(int parameterIndex, Reader reader, long length) throws SQLException`

- Operation: It is not implemented.
- Exception: It always throws `SQLFeatureNotSupportedException`.

setNString

`void setNString(int parameterIndex, String value) throws SQLException`

- Operation: It is not implemented.

- Exception: It always throws `SQLFeatureNotSupportedException`.

setNull

`void setNull(int parameterIndex, int sqlType) throws SQLException`

- Operation: It binds null to the parameter index as GOLDILOCKS type corresponding to `sqlType`. For more information about GOLDILOCKS type mapped to `sqlType`, refer to **Table 26-3 SQL types → GOLDILOCKS types**.
- Exception: It occurs if `parameterIndex` is smaller than 0 or it is bigger than the number of parameters.

`void setNull(int parameterIndex, int sqlType, String typeName) throws SQLException`

- Operation: It binds null to the parameter index as GOLDILOCKS type corresponding to `sqlType` type. For more information about GOLDILOCKS type mapped to `sqlType`, refer to **Table 26-3 SQL types → GOLDILOCKS types**. The third argument, `typeName`, is ignored because REF or the user type is not supported.
- Exception: It occurs if `parameterIndex` is smaller than 0 or it is bigger than the number of parameters.

setObject

`void setObject(int parameterIndex, Object x) throws SQLException`

- Operation: It binds the data `x` to the parameter index as the mapped GOLDILOCKS type.
- Exception: It occurs if `parameterIndex` is smaller than 0 or it is bigger than the number of parameters.

Table 26-2 Java objects → GOLDILOCKS types

Java class	GOLDILOCKS type
null	VARCHAR
Boolean	BOOLEAN
Byte	NATIVE_SMALLINT
Short	NATIVE_SMALLINT
Integer	NATIVE_INTEGER
Long	NATIVE_BIGINT
Float	NATIVE_REAL
Double	NATIVE_DOUBLE
BigInteger	NATIVE_BIGINT
BigDecimal	NUMBER
String	VARCHAR or LONG VARCHAR
byte[]	VARBINARY or LONG VARBINARY
Date	DATE

Java class	GOLDILOCKS type
Time	TIME
Timestamp	TIMESTAMP
Blob	N/A
Clob	N/A
InputStream	LONG VARBINARY
Reader	LONG VARCHAR
GoldilocksInterval	Corresponding INTERVAL type
RowId	ROWID
Others	N/A

`void setObject(int parameterIndex, Object x, int targetSqlType) throws SQLException`

- Operation: It binds the data `x` to the parameter index as GOLDILOCKS type corresponding to `targetSqlType`. For more information about GOLDILOCKS type mapped to `targetSqlType`, refer to **Table 26-3 SQL types → GOLDILOCKS types**.
- Exception: It occurs if `parameterIndex` is smaller than 0 or it is greater than the number of parameters.

`void setObject(int parameterIndex, Object x, int targetSqlType, int scaleOrLength) throws SQLException`

- Operation: It binds the data `x` to the parameter index as GOLDILOCKS type corresponding to `targetSqlType`. For more information about GOLDILOCKS type mapped to `targetSqlType`, refer to **Table 26-3 SQL types → GOLDILOCKS types**. If `x` is `InputStream` or `Reader` then `scaleOrLength` indicates the data length. For other types this value is ignored.
- Exception: It occurs if `parameterIndex` is smaller than 0 or it is bigger than the number of parameters.

setRef

`void setRef(int parameterIndex, Ref x) throws SQLException`

- Operation: It is not implemented.
- Exception: It always throws `SQLFeatureNotSupportedException`.

setRowId

`void setRowId(int parameterIndex, RowId x) throws SQLException`

- Operation: It binds the data `x` to the parameter index as ROWID type.
- Exception: It occurs if `parameterIndex` is smaller than 0 or it is bigger than the number of parameters.

setShort

`void setShort(int parameterIndex, short x) throws SQLException`

- Operation: It binds the data `x` to the parameter index as `NATIVE_SMALLINT` type.
- Exception: It occurs if `parameterIndex` is smaller than 0 or it is bigger than the number of parameters.

setSQLXML

`void setSQLXML(int parameterIndex, SQLXML xmlObject) throws SQLException`

- Operation: It is not implemented.
- Exception: It always throws `SQLFeatureNotSupportedException`.

setString

`void setString(int parameterIndex, String x) throws SQLException`

- Operation: It binds the data `x` to the parameter index as `VARCHAR` or `LONG VARCHAR` type. If the length of `x` is equal to or smaller than 4000, it is bound as `VARCHAR`, and if it is bigger than 4000, it is bound as `LONG VARCHAR` type.
- Exception: It occurs if `parameterIndex` is smaller than 0 or it is bigger than the number of parameters.

setTime

`void setTime(int parameterIndex, Time x) throws SQLException`

- Operation: It binds the data `x` to the parameter index as `TIME` type. It is equivalent to calling `setTime(parameterIndex, x, Calendar.getInstance())`. The local timezone is applied.
- Exception: It occurs if `parameterIndex` is smaller than 0 or it is bigger than the number of parameters.

`void setTime(int parameterIndex, Time x, Calendar cal) throws SQLException`

- Operation: It binds the data `x` to the parameter index as `TIME` type. Time `x` is regarded as timezone of `cal`.
- Exception: It occurs if `parameterIndex` is smaller than 0 or it is bigger than the number of parameters.

setTimestamp

`void setTimestamp(int parameterIndex, Timestamp x) throws SQLException`

- Operation: It binds the data `x` to the parameter index as `TIME` type. It is equivalent to calling `setTimestamp(parameterIndex, x, Calendar.getInstance())`. The local timezone is applied.
- Exception: It occurs if `parameterIndex` is smaller than 0 or it is bigger than the number of parameters.

`void setTimestamp(int parameterIndex, Timestamp x, Calendar cal) throws SQLException`

- Operation: It binds the data `x` to the parameter index as `TIMESTAMP` type. `Timestamp x` is regarded as a `Timestamp` of `cal`.
- Exception: It occurs if `parameterIndex` is smaller than 0 or it is bigger than the number of parameters.

setUnicodeStream

`void setUnicodeStream(int parameterIndex, InputStream x, int length) throws SQLException`

- Operation: It is not implemented. (It is a deprecated method.)
- Exception: It always throws `SQLFeatureNotSupportedException`.

setURL

`void setURL(int parameterIndex, URL x) throws SQLException`

- Operation: It is not implemented.
- Exception: It always throws `SQLFeatureNotSupportedException`.

isWrapperFor

`boolean isWrapperFor(Class<?> iface) throws SQLException`

- Operation: It queries whether this object is the class implementing the `iface` interface. If so, it returns `true`. Otherwise, it returns `false`. It does not determine the presence of the wrapper and it queries only whether the given argument class type is implemented because `GOLDILOCKS PreparedStatement` object is not the wrapper of any other class.
- Exception: It does not occur.

unwrap

`<T> T unwrap(Class<T> iface) throws SQLException`

- Operation: It eventually returns itself even when it is unwrapped because GOLDILOCKS PreparedStatement is not the wrapper of any other class. It returns after casting to that type. If `iface` is an argument of `isWrapperFor()` method and `false` is returned, the method throws an exception.
- Exception: If `iface` is not this object type (The type which is not implemented by this object is given), it throws `SQLException`.

executeBatchAtomic

`boolean executeBatchAtomic() throws SQLException`

- Operation: It is identical to `executeBatch()`, but it is atomically executed. The batch job is either entirely succeeded or failed. It is performed faster than `executeBatch()`. If the executed statement is the select statement, it returns `true`, otherwise, it returns `false`.
- Exception: If batch job is not registered or an error occurs on the server, it throws `SQLException`.



It is GOLDILOCKS JDBC-specific feature, and PreparedStatement object can be used after it is casted as GoldilocksPreparedStatement.

e.g. `((GoldilocksPreparedStatement)pstmt).executeBatchAtomic();`

setTimeTimeZone

`void setTimeTimeZone(int parameterIndex, Time x, Calendar cal) throws SQLException`

- Operation: It binds the data `x` to the parameter index as TIME WITH TIME ZONE type. Time `x` is regarded as timezone of `cal`. Timezone information for DB column refers to timezone of `cal`.
- Exception: It occurs if `parameterIndex` is smaller than 0 or it is bigger than the number of parameters.



It is GOLDILOCKS JDBC-specific feature, and PreparedStatement object can be used after it is casted as GoldilocksPreparedStatement.

e.g. `((GoldilocksPreparedStatement)pstmt).setTimeTimeZone(1, aTime, aCalendar);`

setTimestampTimeZone

`void setTimestampTimeZone(int parameterIndex, Timestamp x, Calendar cal)` throws `SQLException`

- Operation: It binds the data `x` to the parameter index as `TIMESTAMP WITH TIME ZONE` type. Timestamp `x` is regarded as timezone of `cal`. Timezone information for DB column refers to timezone of `cal`.
- Exception: It occurs if `parameterIndex` is smaller than 0 or it is bigger than the number of parameters.



It is GOLDILOCKS JDBC-specific feature, and `PreparedStatement` object can be used after it is casted as `GoldilocksPreparedStatement`.

e.g. `((GoldilocksPreparedStatement)pstmt).setTimestampTimeZone(1, aTimestamp, aCalendar);`

Ref

The class is not implemented.

getBaseTypeName

| String getBaseTypeName() throws SQLException

getObject

| Object getObject() throws SQLException

| Object getObject(Map<String,Class<?>> map) throws SQLException

setObject

| void setObject(Object value) throws SQLException

ResultSet

absolute

boolean absolute(int row) throws SQLException

- Operation: The fetched row cursor position is at the row-th. The first row is 1. 0 points to the previous first row. If it is a negative number, it points to the last row. -1 points to the last row, and -2 points to the second row from the last row. If the cursor can be positioned within the fetched row cache, only the position information is changed within the cache. If it is not within the cache, it is fetched from the server again. If the row exceeds the range, the cursor is positioned before first or after last, and it returns false. Otherwise, the cursor is positioned at the corresponding row and it returns true.
- Exception: If ResultSet is closed or the ResultSet type is ResultSet.TYPE_FORWARD_ONLY or an error occurs from the server when fetching, it throws an exception.



If it is not in the cache, it should be fetched again. If the row is behind the current position, the number of rows(n) from row position are fetched from the server in favor of next(). If the row is prior to the current position, the number of n rows from the position(row-n+1) are fetched from the server in favor of previous().

afterLast

void afterLast() throws SQLException

- Operation: The row cursor is positioned at *after last*. If the row cache is the last row set (It is a part of the entire result set), only the cursor position is changed. Otherwise, it fetches the last row set (The total number of rows-n + 1 to n rows, n is the number of rows fetched from the server), then positions the cursor at *after last*.
- Exception: If ResultSet is closed or the ResultSet type is ResultSet.TYPE_FORWARD_ONLY or an error occurs from the server when fetching, it throws an exception.

beforeFirst

void beforeFirst() throws SQLException

- Operation: The row cursor is positioned at *before first*. If the row cache is the first row set (It is a part of the entire result set), only the cursor position is changed. Otherwise, it fetches the first row set (1 to n rows, n is the number of rows fetched from the server), then positions the cursor at *before first*.
- Exception: If ResultSet is closed or the ResultSet type is ResultSet.TYPE_FORWARD_ONLY or an error occurs from the server when fetching, it throws an exception.

cancelRowUpdates

`void cancelRowUpdates()` throws `SQLException`

- Operation: Cursor update feature has not been implemented. If `ResultSet` concurrency is `ResultSet.CONCUR_READ_ONLY`, it throws `SQLException`. If it is `ResultSet.CONCUR_UPDATABLE`, it throws `SQLFeatureNotSupportedException`.
- Exception: If it is already closed, it throws `SQLException`. Otherwise, refer to the operation.

clearWarnings

`void clearWarnings()` throws `SQLException`

- Operation: It clears all `SQLWarning` objects which is owned by `ResultSet` object.
- Exception: It does not occur.

close

`void close()` throws `SQLException`

- Operation: If the cursor is open on the server, it closes the cursor (If the cursor is already closed on the server, this operation is not performed. Namely, the protocol is not transferred.), and the current state of the `ResultSet` object is changed to be closed. If it is already closed, then any operation is not performed.
- Exception: If an error occurs on the server, it throws `SQLException`.

deleteRow

`void deleteRow()` throws `SQLException`

- Operation: Cursor update feature is not implemented. If `ResultSet` concurrency is `ResultSet.CONCUR_READ_ONLY`, it throws `SQLException`. If it is `ResultSet.CONCUR_UPDATABLE`, it throws `SQLFeatureNotSupportedException`.
- Exception: If it is already closed, it throws `SQLException`. Otherwise, refer to the operation.

findColumn

`int findColumn(String columnName)` throws `SQLException`

- Operation: It returns the index of the column name. The index of the first column is 1.

- Exception: If it is already closed or the column name is not found, it throws `SQLException`.

first

`boolean first()` throws `SQLException`

- Operation: It positions the row cursor at the first (the first row). If the row cache is the first row set (It is a part of the entire result set), only the cursor position is changed. Otherwise, it fetches the first row set (1 to n rows, n is the number of rows fetched from the server), then positions the cursor at the first. If the row exists, it returns true. Otherwise, it returns false.
- Exception: If `ResultSet` is closed or the `ResultSet` type is `ResultSet.TYPE_FORWARD_ONLY` or an error occurs from the server when fetching, it throws an exception.

getArray

`Array getArray(int columnIndex)` throws `SQLException`

- Operation: Array type is not supported.
- Exception: It always throws `SQLFeatureNotSupportedException`.

`Array getArray(String columnLabel)` throws `SQLException`

- Operation: Array type is not supported. For more information about `GOLDILOCKS` type-specific support, refer to **Table 26-4 Whether supporting getter method for `GOLDILOCKS` type - 1**.
- Exception: It always throws `SQLFeatureNotSupportedException`.

getAsciiStream

`InputStream getAsciiStream(int columnIndex)` throws `SQLException`

- Operation: It gets the `columnIndex`-th column data as `InputStream` type. For more information about `GOLDILOCKS` type-specific support, refer to **Table 26-4 Whether supporting getter method for `GOLDILOCKS` type - 1**.
- Exception: If `ResultSet` is already closed or the `columnIndex` exceeds the range or the type can not be converted to `InputStream`, it throws `SQLException`.

`InputStream getAsciiStream(String columnLabel)` throws `SQLException`

- Operation: It gets the column data whose name is `columnLabel` as `InputStream` type. For more information about `GOLDILOCKS` type-specific support, refer to **Table 26-4 Whether supporting getter method for `GOLDILOCKS` type - 1**.
- Exception: If `ResultSet` is already closed or the corresponding `columnLabel` does not exist or the type

can not be converted to `InputStream`, it throws `SQLException`.

getBigDecimal

`BigDecimal getBigDecimal(int columnIndex)` throws `SQLException`

- Operation: It gets the `columnIndex`-th column data as `BigDecimal` type. For more information about GOLDILOCKS type-specific support, refer to **Table 26-4 Whether supporting getter method for GOLDILOCKS type - 1**.
- Exception: If `ResultSet` is already closed or the `columnIndex` exceeds the range or the type can not be converted to `BigDecimal`, it throws `SQLException`.

`BigDecimal getBigDecimal(int columnIndex, int scale)` throws `SQLException`

- Operation: This is a deprecated method. It operates in the same way as `getBigDecimal(int columnIndex)`. The scale is ignored.
- Exception: For more information, refer to **getBigDecimal(int columnIndex)**.

`BigDecimal getBigDecimal(String columnLabel)` throws `SQLException`

- Operation: It gets the column data whose name is `columnLabel` as `BigDecimal` type. For more information about GOLDILOCKS type-specific support, refer to **Table 26-4 Whether supporting getter method for GOLDILOCKS type - 1**.
- Exception: If `ResultSet` is already closed or the corresponding `columnLabel` does not exist or the type can not be converted to `BigDecimal`, it throws `SQLException`.

`BigDecimal getBigDecimal(String columnLabel, int scale)` throws `SQLException`

- Operation: This is a deprecated method. It operates in the same way as `getBigDecimal(String columnLabel)`. The scale is ignored.
- Exception: For more information, refer to **getBigDecimal(String columnLabel)**.

getBinaryStream

`InputStream getBinaryStream(int columnIndex)` throws `SQLException`

- Operation: It is as same as **getAsciiStream(int columnIndex)**.
- Exception: For more information, refer to **getAsciiStream(int columnIndex)**.

`InputStream getBinaryStream(String columnLabel)` throws `SQLException`

- Operation: It is as same as **getAsciiStream(String columnLabel)**.

- Exception: For more information, refer to `getAsciiStream(String columnLabel)`.

getBlob

`Blob getBlob(int columnIndex)` throws `SQLException`

- Operation: It does not support blob type currently.
- Exception: It always throws `SQLFeatureNotSupportedException`.

`Blob getBlob(String columnLabel)` throws `SQLException`

- Operation: It does not support blob type currently.
- Exception: It always throws `SQLFeatureNotSupportedException`.

getBoolean

`boolean getBoolean(int columnIndex)` throws `SQLException`

- Operation: It gets the `columnIndex`-th column data as Boolean type. For more information about GOLDILOCKS type-specific support, refer to **Table 26-4 Whether supporting getter method for GOLDILOCKS type - 1**.
- Exception: If `ResultSet` is already closed or the `columnIndex` exceeds the range or the type can not be converted to Boolean, it throws `SQLException`.

`boolean getBoolean(String columnLabel)` throws `SQLException`

- Operation: It gets the column data whose name is `columnLabel` as Boolean type. For more information about GOLDILOCKS type-specific support, refer to **Table 26-4 Whether supporting getter method for GOLDILOCKS type - 1**.
- Exception: If `ResultSet` is already closed or the corresponding `columnLabel` does not exist or the type can not be converted to Boolean, it throws `SQLException`.

getBytes

`byte getByte(int columnIndex)` throws `SQLException`

- Operation: It gets the `columnIndex`-th column data as byte type. For more information about GOLDILOCKS type-specific support, refer to **Table 26-4 Whether supporting getter method for GOLDILOCKS type - 1**.
- Exception: If `ResultSet` is already closed or the `columnIndex` exceeds the range or the type can not be converted to byte, it throws `SQLException`.

`byte getByte(String columnLabel)` throws `SQLException`

- Operation: It gets the column data whose name is `columnLabel` as `byte` type. For more information about GOLDILOCKS type-specific support, refer to **Table 26-4 Whether supporting getter method for GOLDILOCKS type - 1**.
- Exception: If `ResultSet` is already closed or the corresponding `columnLabel` does not exist or the type can not be converted to `byte`, it throws `SQLException`.

getBytes

`byte[] getBytes(int columnIndex)` throws `SQLException`

- Operation: It gets the `columnIndex`-th column data as `byte[]` type. For more information about GOLDILOCKS type-specific support, refer to **Table 26-4 Whether supporting getter method for GOLDILOCKS type - 1**.
- Exception: If `ResultSet` is already closed or the `columnIndex` exceeds the range, it throws `SQLException`.



If `getBytes` is performed for all GOLDILOCKS data types, it gets the binary form stored in DB.

`byte[] getBytes(String columnLabel)` throws `SQLException`

- Operation: It gets the column data whose name is `columnLabel` as `byte[]` type. For more information about GOLDILOCKS type-specific support, refer to **Table 26-4 Whether supporting getter method for GOLDILOCKS type - 1**.
- Exception: If `ResultSet` is already closed or the corresponding `columnLabel` does not exist, it throws `SQLException`.



If `getBytes` is performed for all GOLDILOCKS data types, it gets the binary form stored in DB.

getCharacterStream

`Reader getCharacterStream(int columnIndex)` throws `SQLException`

- Operation: It gets the `columnIndex`-th column data as `reader` type. For more information about GOLDILOCKS type-specific support, refer to **Table 26-4 Whether supporting getter method for GOLDILOCKS type - 1**.
- Exception: If `ResultSet` is already closed or the `columnIndex` exceeds the range or the type can not be converted to `reader`, it throws `SQLException`.

Reader `getCharacterStream(String columnLabel)` throws `SQLException`

- Operation: It gets the column data whose name is `columnLabel` as reader type. For more information about GOLDILOCKS type-specific support, refer to **Table 26-4 Whether supporting getter method for GOLDILOCKS type - 1**.
- Exception: If `ResultSet` is already closed or the corresponding `columnLabel` does not exist or the type can not be converted to reader, it throws `SQLException`.

getClob

Clob `getClob(int columnIndex)` throws `SQLException`

- Operation: It does not support clob type currently.
- Exception: It always throws `SQLFeatureNotSupportedException`.

Clob `getClob(String columnLabel)` throws `SQLException`

- Operation: It does not support clob type currently.
- Exception: It always throws `SQLFeatureNotSupportedException`.

getConcurrency

`int getConcurrency()` throws `SQLException`

- Operation: It returns concurrency of the current `ResultSet` object. It supports only `ResultSet.CONCUR_READ_ONLY` currently.
- Exception: It does not occur.

getCursorName

String `getCursorName()` throws `SQLException`

- Operation: It gets the cursor name of the server pointed by the `ResultSet`. The communication with the server occurs.
- Exception: If `ResultSet` is already closed or an error occurs on the server, it throws `SQLException`.

getDate

Date `getDate(int columnIndex)` throws `SQLException`

- Operation: It gets the columnIndex-th column data as date type. For more information about GOLDILOCKS type-specific support, refer to **Table 26-4 Whether supporting getter method for GOLDILOCKS type - 1** . When creating the date object, local timezone is used.
- Exception: If ResultSet is already closed or the columnIndex exceeds the range or the type can not be converted to date, it throws SQLException.

Date getDate(int columnIndex, Calendar cal) throws SQLException

- Operation: It gets the columnIndex-th column data as date type. For more information about GOLDILOCKS type-specific support, refer to **Table 26-4 Whether supporting getter method for GOLDILOCKS type - 1** . When creating the date object, local timezone of cal is used.
- Exception: If ResultSet is already closed or the columnIndex exceeds the range or the type can not be converted to date, it throws SQLException.

Date getDate(String columnLabel) throws SQLException

- Operation: It gets the column data whose name is columnLabel as date type. For more information about GOLDILOCKS type-specific support, refer to **Table 26-4 Whether supporting getter method for GOLDILOCKS type - 1** . When creating the date object, the local timezone is used.
- Exception: If ResultSet is already closed or the corresponding columnLabel does not exist or the type can not be converted to date, it throws SQLException.

Date getDate(String columnLabel, Calendar cal) throws SQLException

- Operation: It gets the column data whose name is columnLabel as date type. For more information about GOLDILOCKS type-specific support, refer to **Table 26-4 Whether supporting getter method for GOLDILOCKS type - 1** . When creating the date object, the local timezone of cal is used.
- Exception: If ResultSet is already closed or the corresponding columnLabel does not exist or the type can not be converted to date, it throws SQLException.

getDouble

double getDouble(int columnIndex) throws SQLException

- Operation: It gets the columnIndex-th column data as double type. For more information about GOLDILOCKS type-specific support, refer to **Table 26-4 Whether supporting getter method for GOLDILOCKS type - 1** .
- Exception: If ResultSet is already closed or the columnIndex exceeds the range or the type can not be converted to double, it throws SQLException.

double getDouble(String columnLabel) throws SQLException

- Operation: It gets the column data whose name is columnLabel as double type. For more information about GOLDILOCKS type-specific support, refer to **Table 26-4 Whether supporting getter method for**

GOLDILOCKS type - 1

- Exception: If ResultSet is already closed or the corresponding columnLabel does not exist or the type can not be converted to double, it throws SQLException.

getFetchDirection

`int getFetchDirection()` throws SQLException

- Operation: It always returns ResultSet.FETCH_FORWARD. The backward fetch is not supported.
- Exception: If ResultSet is already closed, it throws SQLException.

getFetchSize

`int getFetchSize()` throws SQLException

- Operation: It gets the number of rows fetched from the server at once. If it is 0, it calculates the maximum number of rows included in a communication packet per transmission. The default value is 0.
- Exception: If ResultSet is already closed, it throws SQLException.

getFloat

`float getFloat(int columnIndex)` throws SQLException

- Operation: It gets the columnIndex-th column data as float type. For more information about GOLDILOCKS type-specific support, refer to **Table 26-4 Whether supporting getter method for GOLDILOCKS type - 1**.
- Exception: If ResultSet is already closed or the columnIndex exceeds the range or the type can not be converted to float, it throws SQLException.

`float getFloat(String columnLabel)` throws SQLException

- Operation: It gets the column data whose name is columnLabel as float type. For more information about GOLDILOCKS type-specific support, refer to **Table 26-4 Whether supporting getter method for GOLDILOCKS type - 1**.
- Exception: If ResultSet is already closed or the corresponding columnLabel does not exist or the type can not be converted to float, it throws SQLException.

getHoldability

`int getHoldability()` throws `SQLException`

- Operation: It returns the holdability of the current `ResultSet`. It is the value determined when the `ResultSet` object is created, and it can not be changed in the meantime. The default value is `ResultSet.HOLD_CURSOR_OVER_COMMIT`.
- Exception: If `ResultSet` is already closed, it throws `SQLException`.

getInt

`int getInt(int columnIndex)` throws `SQLException`

- Operation: It gets the `columnIndex`-th column data as `int` type. For more information about `GOLDILOCKS` type-specific support, refer to **Table 26-4 Whether supporting getter method for `GOLDILOCKS` type - 1**.
- Exception: If `ResultSet` is already closed or the `columnIndex` exceeds the range or the type can not be converted to `int`, it throws `SQLException`.

`int getInt(String columnLabel)` throws `SQLException`

- Operation: It gets the column data whose name is `columnLabel` as `int` type. For more information about `GOLDILOCKS` type-specific support, refer to **Table 26-4 Whether supporting getter method for `GOLDILOCKS` type - 1**.
- Exception: If `ResultSet` is already closed or the corresponding `columnLabel` does not exist or the type can not be converted to `int`, it throws `SQLException`.

getLong

`long getLong(int columnIndex)` throws `SQLException`

- Operation: It gets the `columnIndex`-th column data as `long` type. For more information about `GOLDILOCKS` type-specific support, refer to **Table 26-4 Whether supporting getter method for `GOLDILOCKS` type - 1**.
- Exception: If `ResultSet` is already closed or the `columnIndex` exceeds the range or the type can not be converted to `long`, it throws `SQLException`.

`long getLong(String columnLabel)` throws `SQLException`

- Operation: It gets the column data whose name is `columnLabel` as `long` type. For more information about `GOLDILOCKS` type-specific support, refer to **Table 26-4 Whether supporting getter method for `GOLDILOCKS` type - 1**.

- Exception: If `ResultSet` is already closed or the corresponding `columnLabel` does not exist or the type can not be converted to long, it throws `SQLException`.

getMetaData

`ResultSetMetaData getMetaData()` throws `SQLException`

- Operation: It creates and returns the `ResultSetMetaData` object getting detailed information on the column.
- Exception: If `ResultSet` is already closed or an error occurs while detailed information on the column is fetched from the server, it throws `SQLException`.

getNCharacterStream

`Reader getNCharacterStream(int columnIndex)` throws `SQLException`

- Operation: `NCHAR` family types are not supported currently.
- Exception: It always throws `SQLFeatureNotSupportedException`.

`Reader getNCharacterStream(String columnLabel)` throws `SQLException`

- Operation: `NCHAR` family types are not supported currently.
- Exception: It always throws `SQLFeatureNotSupportedException`.

getNClob

`NClob getNClob(int columnIndex)` throws `SQLException`

- Operation: `NCHAR` family types are not supported currently.
- Exception: It always throws `SQLFeatureNotSupportedException`.

`NClob getNClob(String columnLabel)` throws `SQLException`

- Operation: `NCHAR` family types are not supported currently.
- Exception: It always throws `SQLFeatureNotSupportedException`.

getString

`String getString(int columnIndex)` throws `SQLException`

- Operation: NCHAR family types are not supported currently.
- Exception: It always throws `SQLFeatureNotSupportedException`.

String `getNString(String columnLabel)` throws `SQLException`

- Operation: NCHAR family types are not supported currently.
- Exception: It always throws `SQLFeatureNotSupportedException`.

getObject

Object `getObject(int columnIndex)` throws `SQLException`

- Operation: It gets the `columnIndex`-th column data as the most appropriate Java object type. For more information about GOLDILOCKS type-specific support, refer to **Table 26-4 Whether supporting getter method for GOLDILOCKS type - 1**.
- Exception: If `ResultSet` is already closed or the `columnIndex` exceeds the range, it throws `SQLException`.

Object `getObject(int columnIndex, Map<String,Class<?>> map)` throws `SQLException`

- Operation: It is not supported.
- Exception: It always throws `SQLFeatureNotSupportedException`.

Object `getObject(String columnLabel)` throws `SQLException`

- Operation: It gets the column data whose name is `columnLabel` as the most appropriate Java object type. For more information about GOLDILOCKS type-specific support, refer to **Table 26-4 Whether supporting getter method for GOLDILOCKS type - 1**.
- Exception: If `ResultSet` is already closed or the corresponding `columnLabel` does not exist, it throws `SQLException`.

Object `getObject(String columnLabel, Map<String,Class<?>> map)` throws `SQLException`

- Operation: It is not supported.
- Exception: It always throws `SQLFeatureNotSupportedException`.

getRef

Ref `getRef(int columnIndex)` throws `SQLException`

- Operation: REF type is not supported.
- Exception: It always throws `SQLFeatureNotSupportedException`.

Ref `getRef(String columnLabel)` throws `SQLException`

- Operation: REF type is not supported.
- Exception: It always throws `SQLFeatureNotSupportedException`.

getRow

int `getRow()` throws `SQLException`

- Operation: It returns the cursor position of the current `ResultSet` object. The first row is 1. If it is *before first*, it returns 0.
- Exception: If `ResultSet` is already closed, it throws `SQLException`.

getRowId

RowId `getRowId(int columnIndex)` throws `SQLException`

- Operation: It gets the `columnIndex`-th column data as `RowId` type. For more information about `GOLDILOCKS` type-specific support, refer to **Table 26-4 Whether supporting getter method for GOLDILOCKS type - 1**.
- Exception: If `ResultSet` is already closed or the `columnIndex` exceeds the range or the type can not be converted to `RowId`, it throws `SQLException`.

RowId `getRowId(String columnLabel)` throws `SQLException`

- Operation: It gets the column data whose name is `columnLabel` as `RowId` type. For more information about `GOLDILOCKS` type-specific support, refer to **Table 26-4 Whether supporting getter method for GOLDILOCKS type - 1**.
- Exception: If `ResultSet` is already closed or the corresponding `columnLabel` does not exist or the type can not be converted to `RowId`, it throws `SQLException`.

getShort

short `getShort(int columnIndex)` throws `SQLException`

- Operation: It gets the `columnIndex`-th column data as `short` type. For more information about `GOLDILOCKS` type-specific support, refer to **Table 26-4 Whether supporting getter method for GOLDILOCKS type - 1**.
- Exception: If `ResultSet` is already closed or the `columnIndex` exceeds the range or the type can not be converted to `short`, it throws `SQLException`.

short `getShort(String columnLabel)` throws `SQLException`

- Operation: It gets the column data whose name is `columnLabel` as short type. For more information about GOLDILOCKS type-specific support, refer to **Table 26-4 Whether supporting getter method for GOLDILOCKS type - 1**.
- Exception: If `ResultSet` is already closed or the corresponding `columnLabel` does not exist or the type can not be converted to short, it throws `SQLException`.

getSQLXML

SQLXML `getSQLXML(int columnIndex)` throws `SQLException`

- Operation: SQLXML type is not supported.
- Exception: It always throws `SQLFeatureNotSupportedException`.

SQLXML `getSQLXML(String columnLabel)` throws `SQLException`

- Operation: SQLXML type is not supported.
- Exception: It always throws `SQLFeatureNotSupportedException`.

getStatement

Statement `getStatement()` throws `SQLException`

- Operation: It returns the statement object which created the `ResultSet` object.
- Exception: If `ResultSet` is already closed, it throws `SQLException`.

getString

String `getString(int columnIndex)` throws `SQLException`

- Operation: It gets the `columnIndex`-th column data as string type. For more information about GOLDILOCKS type-specific support, refer to **Table 26-4 Whether supporting getter method for GOLDILOCKS type - 1**. If `getString()` is performed for `BINARY`, `VARBINARY`, `LONG VARBINARY`, the string of hex code is returned.
- Exception: If `ResultSet` is already closed or the `columnIndex` exceeds the range, it throws `SQLException`.

String `getString(String columnLabel)` throws `SQLException`

- Operation: It gets the column data whose name is `columnLabel` as string. For more information about

t GOLDILOCKS type-specific support, refer to **Table 26-4 Whether supporting getter method for GOLDILOCKS type - 1** . If getString() is performed for BINARY, VARBINARY, LONG VARBINARY, it returns the string of hex code.

- Exception: If ResultSet is already closed or the corresponding columnName does not exist, it throws SQLException.

getTime

Time getTime(int columnIndex) throws SQLException

- Operation: It gets the columnIndex-th column data as time type. For more information about GOLDILOCKS type-specific support, refer to **Table 26-4 Whether supporting getter method for GOLDILOCKS type - 1** . When creating the time object, local timezone is used.
- Exception: If ResultSet is already closed or the columnIndex exceeds the range or the type can not be converted to time, it throws SQLException.

Time getTime(int columnIndex, Calendar cal) throws SQLException

- Operation: It gets the columnIndex-th column data as time type. For more information about GOLDILOCKS type-specific support, refer to **Table 26-4 Whether supporting getter method for GOLDILOCKS type - 1** . When creating the time object, local timezone of cal is used.
- Exception: If ResultSet is already closed or the columnIndex exceeds the range or the type can not be converted to time, it throws SQLException.

Time getTime(String columnName) throws SQLException

- Operation: It gets the column data whose name is columnName as time type. For more information about GOLDILOCKS type-specific support, refer to **Table 26-4 Whether supporting getter method for GOLDILOCKS type - 1** . When creating the time object, the local timezone is used.
- Exception: If ResultSet is already closed or the corresponding columnName does not exist or the type can not be converted to time, it throws SQLException.

Time getTime(String columnName, Calendar cal) throws SQLException

- Operation: It gets the column data whose name is columnName as time type. For more information about GOLDILOCKS type-specific support, refer to **Table 26-4 Whether supporting getter method for GOLDILOCKS type - 1** . When creating the time object, the local timezone is used.
- Exception: If ResultSet is already closed or the corresponding columnName does not exist or the type can not be converted to time, it throws SQLException.

getTimestamp

Timestamp `getTimestamp(int columnIndex)` throws `SQLException`

- Operation: It gets the `columnIndex`-th column data as timestamp type. For more information about GOLDILOCKS type-specific support, refer to **Table 26-4 Whether supporting getter method for GOLDILOCKS type - 1**. When creating the timestamp object, local timezone is used.
- Exception: If `ResultSet` is already closed or the `columnIndex` exceeds the range or the type can not be converted to timestamp, it throws `SQLException`.

Timestamp `getTimestamp(int columnIndex, Calendar cal)` throws `SQLException`

- Operation: It gets the `columnIndex`-th column data as timestamp type. For more information about GOLDILOCKS type-specific support, refer to **Table 26-4 Whether supporting getter method for GOLDILOCKS type - 1**. When creating the timestamp object, local timezone of `cal` is used.
- Exception: If `ResultSet` is already closed or the `columnIndex` exceeds the range or the type can not be converted to timestamp, it throws `SQLException`.

Timestamp `getTimestamp(String columnLabel)` throws `SQLException`

- Operation: It gets the column data whose name is `columnLabel` as timestamp type. For more information about GOLDILOCKS type-specific support, refer to **Table 26-4 Whether supporting getter method for GOLDILOCKS type - 1**. When creating the timestamp object, the local timezone is used.
- Exception: If `ResultSet` is already closed or the corresponding `columnLabel` does not exist or the type can not be converted to timestamp, it throws `SQLException`.

Timestamp `getTimestamp(String columnLabel, Calendar cal)` throws `SQLException`

- Operation: It gets the column data whose name is `columnLabel` as timestamp type. For more information about GOLDILOCKS type-specific support, refer to **Table 26-4 Whether supporting getter method for GOLDILOCKS type - 1**. When creating the timestamp object, the local timezone of `cal` is used.
- Exception: If `ResultSet` is already closed or the corresponding `columnLabel` does not exist or the type can not be converted to timestamp, it throws `SQLException`.

getType

`int getType()` throws `SQLException`

- Operation: It returns the current `ResultSet` type. It returns one of `ResultSet.TYPE_FORWARD_ONLY`, `ResultSet.TYPE_SCROLL_INSENSITIVE`, `ResultSet.TYPE_SCROLL_SENSITIVE`.
- Exception: If `ResultSet` is already closed, it throws `SQLException`.

getUnicodeStream

`InputStream getUnicodeStream(int columnIndex)` throws `SQLException`

- Operation: It is a deprecated method. It is not implemented.
- Exception: It always throws `SQLFeatureNotSupportedException`.

`InputStream getUnicodeStream(String columnLabel)` throws `SQLException`

- Operation: It is a deprecated method. It is not implemented.
- Exception: It always throws `SQLFeatureNotSupportedException`.

getURL

`URL getURL(int columnIndex)` throws `SQLException`

- Operation: URL type is not supported.
- Exception: It always throws `SQLFeatureNotSupportedException`.

`URL getURL(String columnLabel)` throws `SQLException`

- Operation: URL type is not supported.
- Exception: It always throws `SQLFeatureNotSupportedException`.

getWarnings

`SQLWarning getWarnings()` throws `SQLException`

- Operation: It returns a list of `SQLWarning` accumulated on the object so far. If it gets a warning from the server, it creates `SQLWarning`. If `clearWarning` is not performed, it continues to be accumulated. If a warning does not occur, null is returned.
- Exception: It does not occur.

insertRow

`void insertRow()` throws `SQLException`

- Operation: Cursor update feature has not yet been implemented. If `ResultSet` concurrency is `ResultSet.CONCUR_READ_ONLY`, it throws `SQLException`. If it is `ResultSet.CONCUR_UPDATABLE`, it throws `SQLFeatureNotSupportedException`.
- Exception: If it is already closed, it throws `SQLException`. Otherwise, refer to the operation.

isAfterLast

boolean isAfterLast() throws SQLException

- Operation: It queries whether the current cursor position is at *after last*. If so, it returns true. Otherwise, it returns false.
- Exception: If ResultSet is already closed, it throws SQLException.

isBeforeFirst

boolean isBeforeFirst() throws SQLException

- Operation: It queries whether the current cursor position is at *before first*. If so, it returns true. Otherwise, it returns false.
- Exception: If ResultSet is already closed, it throws SQLException.

isClosed

boolean isClosed() throws SQLException

- Operation: It queries whether the current ResultSet is closed. If closed, it returns true. Otherwise, it returns false. Even if the user does not call the close, ResultSet can be closed by closing the cursor of the server. It is when, for example, the statement which created the ResultSet is closed, or the transaction is committed when the holdability is ResultSet.CLOSE_CURSOR_AT_COMMIT mode, or an error occurs from the server during fetching.
- Exception: It does not occur.

isFirst

boolean isFirst() throws SQLException

- Operation: It queries whether the current cursor position is at first (the first row). If so, it returns true. Otherwise, it returns false.
- Exception: If ResultSet is already closed, it throws SQLException.

isLast

boolean isLast() throws SQLException

- Operation: It queries whether the current cursor position is at last (the last row). If so, it returns true.

Otherwise, it returns false.

- Exception: If `ResultSet` is already closed, it throws `SQLException`.

last

`boolean last()` throws `SQLException`

- Operation: The row cursor is positioned at last (the last row). If the row cache is the last row set (It is a part of the entire result set), only the cursor position is changed. Otherwise, the row cursor is positioned at last after the last row set is fetched (row from last-n+1 to the last row, n is the number of rows fetched from the server). If the row exists, it returns true. Otherwise, it returns false.
- Exception: If `ResultSet` is already closed or the `ResultSet` type is `ResultSet.TYPE_FORWARD_ONLY` or an error occurs from the server when fetching, it throws an exception.

moveToCurrentRow

`void moveToCurrentRow()` throws `SQLException`

- Operation: The cursor update feature has not yet been implemented. If `ResultSet` concurrency is `ResultSet.CONCUR_READ_ONLY`, it throws `SQLException`. If it is `ResultSet.CONCUR_UPDATABLE`, it throws `SQLFeatureNotSupportedException`.
- Exception: If it is already closed, it throws `SQLException`. Otherwise, refer to the operation.

moveToInsertRow

`void moveToInsertRow()` throws `SQLException`

- Operation: The cursor update feature has not yet been implemented. If `ResultSet` concurrency is `ResultSet.CONCUR_READ_ONLY`, it throws `SQLException`. If it is `ResultSet.CONCUR_UPDATABLE`, it throws `SQLFeatureNotSupportedException`.
- Exception: If it is already closed, it throws `SQLException`. Otherwise, refer to the operation.

next

`boolean next()` throws `SQLException`

- Operation: The row cursor is positioned at the next to the current row. If the current row is the last row of the row cache, the next row cache is fetched from the server. If the row exists, it returns true. Otherwise, it returns false.
- Exception: If `ResultSet` is already closed or an error occurs from the server when fetching, it throws an exception.

previous

`boolean previous()` throws `SQLException`

- Operation: The row cursor is positioned at the row before the current position. If the current row is the first row of the row cache, the previous row cache (n rows from x-n to x-1, x is the current row index) is fetched from the server. If the row exists, it returns true. Otherwise, it returns false.
- Exception: If `ResultSet` is already closed or the `ResultSet` type is `ResultSet.TYPE_FORWARD_ONLY` or an error occurs from the server during fetching, it throws an exception.

refreshRow

`void refreshRow()` throws `SQLException`

- Operation: If `ResultSet` type is `ResultSet.SCROLL_SENSITIVE`, the current row cache is fetched from the server. If any row is changed (by the same transaction or other transactions), it is reflected. If `ResultSet` type is `ResultSet.Scroll_INSENSITIVE`, any operation is not performed.
- Exception: If `ResultSet` is already closed or the `ResultSet` type is `ResultSet.TYPE_FORWARD_ONLY` or an error occurs from the server during fetching, it throws an exception.

relative

`boolean relative(int rows)` throws `SQLException`

- Operation: It moves the row cursor from the current cursor position to the position apart as many as the number of rows. If it can be moved within the current row cache, only the cursor position is changed. Otherwise, the cursor is moved after the row cache is fetched from the server. If the position to be moved is backward from the current position (next direction), the row cache is fetched from rows to rows+n-1 (in favor of next). If the position to be moved is forward from the current position (previous direction), the row cache is fetched from rows-n+1 to rows (in favor of previous).
- Exception: If `ResultSet` is already closed or the `ResultSet` type is `ResultSet.TYPE_FORWARD_ONLY` or an error occurs from the server when fetching, it throws an exception.

rowDeleted

`boolean rowDeleted()` throws `SQLException`

- Operation: It queries whether the row of the current cursor position is deleted (by the same transaction or other transactions). If deleted, it returns true. Otherwise, it returns false.
- Exception: If `ResultSet` is already closed or the `ResultSet` type is `ResultSet.TYPE_FORWARD_ONLY`, it throws an exception.

rowInserted

boolean rowInserted() throws SQLException

- Operation: It queries whether the row of the current cursor position is inserted (by the same transaction or other transactions). If inserted, it returns true. Otherwise, it returns false.
- Exception: If ResultSet is already closed or the ResultSet type is ResultSet.TYPE_FORWARD_ONLY, it throws an exception.

rowUpdated

boolean rowUpdated() throws SQLException

- Operation: It queries whether the row of the current cursor position is updated (by the same transaction or other transactions). If updated, it returns true. Otherwise, it returns false.
- Exception: If ResultSet is already closed or the ResultSet type is ResultSet.TYPE_FORWARD_ONLY, it throws an exception.

setFetchDirection

void setFetchDirection(int direction) throws SQLException

- Operation: The backward fetch is not supported by the server. Therefore, only ResultSet.FETCH_FORWARD is available. SQLWarning occurs if other values are inserted.
- Exception: If ResultSet is already closed or the argument does not have the defined value, it throws an exception.

setFetchSize

void setFetchSize(int rows) throws SQLException

- Operation: It specifies the number of rows fetched from the server at once. 0 refers that the server determines it. If it is 0, it refers to the number of rows of which a communication packet can include at once for the forward only cursor. It is specified as 100 for the scrollable cursor.
- Exception: If ResultSet is already closed, it throws an exception.

updateArray

void updateArray(int columnIndex, Array x) throws SQLException

- Operation: The cursor update feature has not yet been implemented. If `ResultSet` concurrency is `ResultSet.CONCUR_READ_ONLY`, it throws `SQLException`. If it is `ResultSet.CONCUR_UPDATABLE`, it throws `SQLFeatureNotSupportedException`.
- Exception: If it is already closed, it throws `SQLException`. Otherwise, refer to the operation.

`void updateArray(String columnLabel, Array x) throws SQLException`

- Operation: The cursor update feature has not yet been implemented. If `ResultSet` concurrency is `ResultSet.CONCUR_READ_ONLY`, it throws `SQLException`. If it is `ResultSet.CONCUR_UPDATABLE`, it throws `SQLFeatureNotSupportedException`.
- Exception: If it is already closed, it throws `SQLException`. Otherwise, refer to the operation.

updateAsciiStream

`void updateAsciiStream(int columnIndex, InputStream x) throws SQLException`

- Operation: The cursor update feature has not yet been implemented. If `ResultSet` concurrency is `ResultSet.CONCUR_READ_ONLY`, it throws `SQLException`. If it is `ResultSet.CONCUR_UPDATABLE`, it throws `SQLFeatureNotSupportedException`.
- Exception: If it is already closed, it throws `SQLException`. Otherwise, refer to the operation.

`void updateAsciiStream(int columnIndex, InputStream x, int length) throws SQLException`

- Operation: The cursor update feature has not yet been implemented. If `ResultSet` concurrency is `ResultSet.CONCUR_READ_ONLY`, it throws `SQLException`. If it is `ResultSet.CONCUR_UPDATABLE`, it throws `SQLFeatureNotSupportedException`.
- Exception: If it is already closed, it throws `SQLException`. Otherwise, refer to the operation.

`void updateAsciiStream(int columnIndex, InputStream x, long length) throws SQLException`

- Operation: The cursor update feature has not yet been implemented. If `ResultSet` concurrency is `ResultSet.CONCUR_READ_ONLY`, it throws `SQLException`. If it is `ResultSet.CONCUR_UPDATABLE`, it throws `SQLFeatureNotSupportedException`.
- Exception: If it is already closed, it throws `SQLException`. Otherwise, refer to the operation.

`void updateAsciiStream(String columnLabel, InputStream x) throws SQLException`

- Operation: The cursor update feature has not yet been implemented. If `ResultSet` concurrency is `ResultSet.CONCUR_READ_ONLY`, it throws `SQLException`. If it is `ResultSet.CONCUR_UPDATABLE`, it throws `SQLFeatureNotSupportedException`.
- Exception: If it is already closed, it throws `SQLException`. Otherwise, refer to the operation.

`void updateAsciiStream(String columnLabel, InputStream x, int length) throws SQLException`

- Operation: The cursor update feature has not yet been implemented. If `ResultSet` concurrency is `ResultSet.CONCUR_READ_ONLY`, it throws `SQLException`. If it is `ResultSet.CONCUR_UPDATABLE`, it throws `SQLFeatureNotSupportedException`.
- Exception: If it is already closed, it throws `SQLException`. Otherwise, refer to the operation.

`void updateAsciiStream(String columnLabel, InputStream x, long length) throws SQLException`

- Operation: The cursor update feature has not yet been implemented. If `ResultSet` concurrency is `ResultSet.CONCUR_READ_ONLY`, it throws `SQLException`. If it is `ResultSet.CONCUR_UPDATABLE`, it throws `SQLFeatureNotSupportedException`.
- Exception: If it is already closed, it throws `SQLException`. Otherwise, refer to the operation.

updateBigDecimal

`void updateBigDecimal(int columnIndex, BigDecimal x) throws SQLException`

- Operation: The cursor update feature has not yet been implemented. If `ResultSet` concurrency is `ResultSet.CONCUR_READ_ONLY`, it throws `SQLException`. If it is `ResultSet.CONCUR_UPDATABLE`, it throws `SQLFeatureNotSupportedException`.
- Exception: If it is already closed, it throws `SQLException`. Otherwise, refer to the operation.

`void updateBigDecimal(String columnLabel, BigDecimal x) throws SQLException`

- Operation: The cursor update feature has not yet been implemented. If `ResultSet` concurrency is `ResultSet.CONCUR_READ_ONLY`, it throws `SQLException`. If it is `ResultSet.CONCUR_UPDATABLE`, it throws `SQLFeatureNotSupportedException`.
- Exception: If it is already closed, it throws `SQLException`. Otherwise, refer to the operation.

updateBinaryStream

`void updateBinaryStream(int columnIndex, InputStream x) throws SQLException`

- Operation: The cursor update feature has not yet been implemented. If `ResultSet` concurrency is `ResultSet.CONCUR_READ_ONLY`, it throws `SQLException`. If it is `ResultSet.CONCUR_UPDATABLE`, it throws `SQLFeatureNotSupportedException`.
- Exception: If it is already closed, it throws `SQLException`. Otherwise, refer to the operation.

`void updateBinaryStream(int columnIndex, InputStream x, int length) throws SQLException`

- Operation: The cursor update feature has not yet been implemented. If `ResultSet` concurrency is `ResultSet`

ResultSet.CONCUR_READ_ONLY, it throws SQLException. If it is ResultSet.CONCUR_UPDATABLE, it throws SQLFeatureNotSupportedException.

- Exception: If it is already closed, it throws SQLException. Otherwise, refer to the operation.

`void updateBinaryStream(int columnIndex, InputStream x, long length) throws SQLException`

- Operation: The cursor update feature has not yet been implemented. If ResultSet concurrency is ResultSet.CONCUR_READ_ONLY, it throws SQLException. If it is ResultSet.CONCUR_UPDATABLE, it throws SQLFeatureNotSupportedException.
- Exception: If it is already closed, it throws SQLException. Otherwise, refer to the operation.

`void updateBinaryStream(String columnLabel, InputStream x) throws SQLException`

- Operation: The cursor update feature has not yet been implemented. If ResultSet concurrency is ResultSet.CONCUR_READ_ONLY, it throws SQLException. If it is ResultSet.CONCUR_UPDATABLE, it throws SQLFeatureNotSupportedException.
- Exception: If it is already closed, it throws SQLException. Otherwise, refer to the operation.

`void updateBinaryStream(String columnLabel, InputStream x, int length) throws SQLException`

- Operation: The cursor update feature has not yet been implemented. If ResultSet concurrency is ResultSet.CONCUR_READ_ONLY, it throws SQLException. If it is ResultSet.CONCUR_UPDATABLE, it throws SQLFeatureNotSupportedException.
- Exception: If it is already closed, it throws SQLException. Otherwise, refer to the operation.

`void updateBinaryStream(String columnLabel, InputStream x, long length) throws SQLException`

- Operation: The cursor update feature has not yet been implemented. If ResultSet concurrency is ResultSet.CONCUR_READ_ONLY, it throws SQLException. If it is ResultSet.CONCUR_UPDATABLE, it throws SQLFeatureNotSupportedException.
- Exception: If it is already closed, it throws SQLException. Otherwise, refer to the operation.

updateBlob

`void updateBlob(int columnIndex, Blob x) throws SQLException`

- Operation: The cursor update feature has not yet been implemented. If ResultSet concurrency is ResultSet.CONCUR_READ_ONLY, it throws SQLException. If it is ResultSet.CONCUR_UPDATABLE, it throws SQLFeatureNotSupportedException.
- Exception: If it is already closed, it throws SQLException. Otherwise, refer to the operation.

`void updateBlob(int columnIndex, InputStream inputStream) throws SQLException`

- Operation: The cursor update feature has not yet been implemented. If `ResultSet` concurrency is `ResultSet.CONCUR_READ_ONLY`, it throws `SQLException`. If it is `ResultSet.CONCUR_UPDATABLE`, it throws `SQLFeatureNotSupportedException`.
- Exception: If it is already closed, it throws `SQLException`. Otherwise, refer to the operation.

`void updateBlob(int columnIndex, InputStream inputStream, long length) throws SQLException`

- Operation: The cursor update feature has not yet been implemented. If `ResultSet` concurrency is `ResultSet.CONCUR_READ_ONLY`, it throws `SQLException`. If it is `ResultSet.CONCUR_UPDATABLE`, it throws `SQLFeatureNotSupportedException`.
- Exception: If it is already closed, it throws `SQLException`. Otherwise, refer to the operation.

`void updateBlob(String columnLabel, Blob x) throws SQLException`

- Operation: The cursor update feature has not yet been implemented. If `ResultSet` concurrency is `ResultSet.CONCUR_READ_ONLY`, it throws `SQLException`. If it is `ResultSet.CONCUR_UPDATABLE`, it throws `SQLFeatureNotSupportedException`.
- Exception: If it is already closed, it throws `SQLException`. Otherwise, refer to the operation.

`void updateBlob(String columnLabel, InputStream inputStream) throws SQLException`

- Operation: The cursor update feature has not yet been implemented. If `ResultSet` concurrency is `ResultSet.CONCUR_READ_ONLY`, it throws `SQLException`. If it is `ResultSet.CONCUR_UPDATABLE`, it throws `SQLFeatureNotSupportedException`.
- Exception: If it is already closed, it throws `SQLException`. Otherwise, refer to the operation.

`void updateBlob(String columnLabel, InputStream inputStream, long length) throws SQLException`

- Operation: The cursor update feature has not yet been implemented. If `ResultSet` concurrency is `ResultSet.CONCUR_READ_ONLY`, it throws `SQLException`. If it is `ResultSet.CONCUR_UPDATABLE`, it throws `SQLFeatureNotSupportedException`.
- Exception: If it is already closed, it throws `SQLException`. Otherwise, refer to the operation.

updateBoolean

`void updateBoolean(int columnIndex, boolean x) throws SQLException`

- Operation: The cursor update feature has not yet been implemented. If `ResultSet` concurrency is `ResultSet.CONCUR_READ_ONLY`, it throws `SQLException`. If it is `ResultSet.CONCUR_UPDATABLE`, it throws `SQLFeatureNotSupportedException`.
- Exception: If it is already closed, it throws `SQLException`. Otherwise, refer to the operation.

`void updateBoolean(String columnLabel, boolean x) throws SQLException`

- Operation: The cursor update feature has not yet been implemented. If `ResultSet` concurrency is `ResultSet.CONCUR_READ_ONLY`, it throws `SQLException`. If it is `ResultSet.CONCUR_UPDATABLE`, it throws `SQLFeatureNotSupportedException`.
- Exception: If it is already closed, it throws `SQLException`. Otherwise, refer to the operation.

updateByte

`void updateByte(int columnIndex, byte x) throws SQLException`

- Operation: The cursor update feature has not yet been implemented. If `ResultSet` concurrency is `ResultSet.CONCUR_READ_ONLY`, it throws `SQLException`. If it is `ResultSet.CONCUR_UPDATABLE`, it throws `SQLFeatureNotSupportedException`.
- Exception: If it is already closed, it throws `SQLException`. Otherwise, refer to the operation.

`void updateByte(String columnLabel, byte x) throws SQLException`

- Operation: The cursor update feature has not yet been implemented. If `ResultSet` concurrency is `ResultSet.CONCUR_READ_ONLY`, it throws `SQLException`. If it is `ResultSet.CONCUR_UPDATABLE`, it throws `SQLFeatureNotSupportedException`.
- Exception: If it is already closed, it throws `SQLException`. Otherwise, refer to the operation.

updateBytes

`void updateBytes(int columnIndex, byte[] x) throws SQLException`

- Operation: The cursor update feature has not yet been implemented. If `ResultSet` concurrency is `ResultSet.CONCUR_READ_ONLY`, it throws `SQLException`. If it is `ResultSet.CONCUR_UPDATABLE`, it throws `SQLFeatureNotSupportedException`.
- Exception: If it is already closed, it throws `SQLException`. Otherwise, refer to the operation.

`void updateBytes(String columnLabel, byte[] x) throws SQLException`

- Operation: The cursor update feature has not yet been implemented. If `ResultSet` concurrency is `ResultSet.CONCUR_READ_ONLY`, it throws `SQLException`. If it is `ResultSet.CONCUR_UPDATABLE`, it throws `SQLFeatureNotSupportedException`.
- Exception: If it is already closed, it throws `SQLException`. Otherwise, refer to the operation.

updateCharacterStream

`void updateCharacterStream(int columnIndex, Reader x) throws SQLException`

- Operation: The cursor update feature has not yet been implemented. If `ResultSet` concurrency is `ResultSet.CONCUR_READ_ONLY`, it throws `SQLException`. If it is `ResultSet.CONCUR_UPDATABLE`, it throws `SQLFeatureNotSupportedException`.
- Exception: If it is already closed, it throws `SQLException`. Otherwise, refer to the operation.

`void updateCharacterStream(int columnIndex, Reader x, int length) throws SQLException`

- Operation: The cursor update feature has not yet been implemented. If `ResultSet` concurrency is `ResultSet.CONCUR_READ_ONLY`, it throws `SQLException`. If it is `ResultSet.CONCUR_UPDATABLE`, it throws `SQLFeatureNotSupportedException`.
- Exception: If it is already closed, it throws `SQLException`. Otherwise, refer to the operation.

`void updateCharacterStream(int columnIndex, Reader x, long length) throws SQLException`

- Operation: The cursor update feature has not yet been implemented. If `ResultSet` concurrency is `ResultSet.CONCUR_READ_ONLY`, it throws `SQLException`. If it is `ResultSet.CONCUR_UPDATABLE`, it throws `SQLFeatureNotSupportedException`.
- Exception: If it is already closed, it throws `SQLException`. Otherwise, refer to the operation.

`void updateCharacterStream(String columnLabel, Reader reader) throws SQLException`

- Operation: The cursor update feature has not yet been implemented. If `ResultSet` concurrency is `ResultSet.CONCUR_READ_ONLY`, it throws `SQLException`. If it is `ResultSet.CONCUR_UPDATABLE`, it throws `SQLFeatureNotSupportedException`.
- Exception: If it is already closed, it throws `SQLException`. Otherwise, refer to the operation.

`void updateCharacterStream(String columnLabel, Reader reader, int length) throws SQLException`

- Operation: The cursor update feature has not yet been implemented. If `ResultSet` concurrency is `ResultSet.CONCUR_READ_ONLY`, it throws `SQLException`. If it is `ResultSet.CONCUR_UPDATABLE`, it throws `SQLFeatureNotSupportedException`.
- Exception: If it is already closed, it throws `SQLException`. Otherwise, refer to the operation.

`void updateCharacterStream(String columnLabel, Reader reader, long length) throws SQLException`

- Operation: The cursor update feature has not yet been implemented. If `ResultSet` concurrency is `ResultSet.CONCUR_READ_ONLY`, it throws `SQLException`. If it is `ResultSet.CONCUR_UPDATABLE`, it throws `SQLFeatureNotSupportedException`.
- Exception: If it is already closed, it throws `SQLException`. Otherwise, refer to the operation.

updateClob

`void updateClob(int columnIndex, Clob x) throws SQLException`

- Operation: The cursor update feature has not yet been implemented. If `ResultSet` concurrency is `ResultSet.CONCUR_READ_ONLY`, it throws `SQLException`. If it is `ResultSet.CONCUR_UPDATABLE`, it throws `SQLFeatureNotSupportedException`.
- Exception: If it is already closed, it throws `SQLException`. Otherwise, refer to the operation.

`void updateClob(int columnIndex, Reader reader) throws SQLException`

- Operation: The cursor update feature has not yet been implemented. If `ResultSet` concurrency is `ResultSet.CONCUR_READ_ONLY`, it throws `SQLException`. If it is `ResultSet.CONCUR_UPDATABLE`, it throws `SQLFeatureNotSupportedException`.
- Exception: If it is already closed, it throws `SQLException`. Otherwise, refer to the operation.

`void updateClob(int columnIndex, Reader reader, long length) throws SQLException`

- Operation: The cursor update feature has not yet been implemented. If `ResultSet` concurrency is `ResultSet.CONCUR_READ_ONLY`, it throws `SQLException`. If it is `ResultSet.CONCUR_UPDATABLE`, it throws `SQLFeatureNotSupportedException`.
- Exception: If it is already closed, it throws `SQLException`. Otherwise, refer to the operation.

`void updateClob(String columnLabel, Clob x) throws SQLException`

- Operation: The cursor update feature has not yet been implemented. If `ResultSet` concurrency is `ResultSet.CONCUR_READ_ONLY`, it throws `SQLException`. If it is `ResultSet.CONCUR_UPDATABLE`, it throws `SQLFeatureNotSupportedException`.
- Exception: If it is already closed, it throws `SQLException`. Otherwise, refer to the operation.

`void updateClob(String columnLabel, Reader reader) throws SQLException`

- Operation: The cursor update feature has not yet been implemented. If `ResultSet` concurrency is `ResultSet.CONCUR_READ_ONLY`, it throws `SQLException`. If it is `ResultSet.CONCUR_UPDATABLE`, it throws `SQLFeatureNotSupportedException`.
- Exception: If it is already closed, it throws `SQLException`. Otherwise, refer to the operation.

`void updateClob(String columnLabel, Reader reader, long length) throws SQLException`

- Operation: The cursor update feature has not yet been implemented. If `ResultSet` concurrency is `ResultSet.CONCUR_READ_ONLY`, it throws `SQLException`. If it is `ResultSet.CONCUR_UPDATABLE`, it throws `SQLFeatureNotSupportedException`.
- Exception: If it is already closed, it throws `SQLException`. Otherwise, refer to the operation.

updateDate

`void updateDate(int columnIndex, Date x) throws SQLException`

- Operation: The cursor update feature has not yet been implemented. If `ResultSet` concurrency is `ResultSet.CONCUR_READ_ONLY`, it throws `SQLException`. If it is `ResultSet.CONCUR_UPDATABLE`, it throws `SQLFeatureNotSupportedException`.
- Exception: If it is already closed, it throws `SQLException`. Otherwise, refer to the operation.

`void updateDate(String columnLabel, Date x) throws SQLException`

- Operation: The cursor update feature has not yet been implemented. If `ResultSet` concurrency is `ResultSet.CONCUR_READ_ONLY`, it throws `SQLException`. If it is `ResultSet.CONCUR_UPDATABLE`, it throws `SQLFeatureNotSupportedException`.
- Exception: If it is already closed, it throws `SQLException`. Otherwise, refer to the operation.

updateDouble

`void updateDouble(int columnIndex, double x) throws SQLException`

- Operation: The cursor update feature has not yet been implemented. If `ResultSet` concurrency is `ResultSet.CONCUR_READ_ONLY`, it throws `SQLException`. If it is `ResultSet.CONCUR_UPDATABLE`, it throws `SQLFeatureNotSupportedException`.
- Exception: If it is already closed, it throws `SQLException`. Otherwise, refer to the operation.

`void updateDouble(String columnLabel, double x) throws SQLException`

- Operation: The cursor update feature has not yet been implemented. If `ResultSet` concurrency is `ResultSet.CONCUR_READ_ONLY`, it throws `SQLException`. If it is `ResultSet.CONCUR_UPDATABLE`, it throws `SQLFeatureNotSupportedException`.
- Exception: If it is already closed, it throws `SQLException`. Otherwise, refer to the operation.

updateFloat

`void updateFloat(int columnIndex, float x) throws SQLException`

- Operation: The cursor update feature has not yet been implemented. If `ResultSet` concurrency is `ResultSet.CONCUR_READ_ONLY`, it throws `SQLException`. If it is `ResultSet.CONCUR_UPDATABLE`, it throws `SQLFeatureNotSupportedException`.
- Exception: If it is already closed, it throws `SQLException`. Otherwise, refer to the operation.

`void updateFloat(String columnLabel, float x) throws SQLException`

- Operation: The cursor update feature has not yet been implemented. If `ResultSet` concurrency is `ResultSet.CONCUR_READ_ONLY`, it throws `SQLException`. If it is `ResultSet.CONCUR_UPDATABLE`, it throws `SQLFeatureNotSupportedException`.
- Exception: If it is already closed, it throws `SQLException`. Otherwise, refer to the operation.

updateInt

`void updateInt(int columnIndex, int x) throws SQLException`

- Operation: The cursor update feature has not yet been implemented. If `ResultSet` concurrency is `ResultSet.CONCUR_READ_ONLY`, it throws `SQLException`. If it is `ResultSet.CONCUR_UPDATABLE`, it throws `SQLFeatureNotSupportedException`.
- Exception: If it is already closed, it throws `SQLException`. Otherwise, refer to the operation.

`void updateInt(String columnLabel, int x) throws SQLException`

- Operation: The cursor update feature has not yet been implemented. If `ResultSet` concurrency is `ResultSet.CONCUR_READ_ONLY`, it throws `SQLException`. If it is `ResultSet.CONCUR_UPDATABLE`, it throws `SQLFeatureNotSupportedException`.
- Exception: If it is already closed, it throws `SQLException`. Otherwise, refer to the operation.

updateLong

`void updateLong(int columnIndex, long x) throws SQLException`

- Operation: The cursor update feature has not yet been implemented. If `ResultSet` concurrency is `ResultSet.CONCUR_READ_ONLY`, it throws `SQLException`. If it is `ResultSet.CONCUR_UPDATABLE`, it throws `SQLFeatureNotSupportedException`.
- Exception: If it is already closed, it throws `SQLException`. Otherwise, refer to the operation.

`void updateLong(String columnLabel, long x) throws SQLException`

- Operation: The cursor update feature has not yet been implemented. If `ResultSet` concurrency is `ResultSet.CONCUR_READ_ONLY`, it throws `SQLException`. If it is `ResultSet.CONCUR_UPDATABLE`, it throws `SQLFeatureNotSupportedException`.
- Exception: If it is already closed, it throws `SQLException`. Otherwise, refer to the operation.

updateNCharacterStream

`void updateNCharacterStream(int columnIndex, Reader x) throws SQLException`

- Operation: The cursor update feature has not yet been implemented. If `ResultSet` concurrency is `ResultSet.CONCUR_READ_ONLY`, it throws `SQLException`. If it is `ResultSet.CONCUR_UPDATABLE`, it throws `SQLFeatureNotSupportedException`.
- Exception: If it is already closed, it throws `SQLException`. Otherwise, refer to the operation.

`void updateNCharacterStream(int columnIndex, Reader x, long length) throws SQLException`

- Operation: The cursor update feature has not yet been implemented. If `ResultSet` concurrency is `ResultSet.CONCUR_READ_ONLY`, it throws `SQLException`. If it is `ResultSet.CONCUR_UPDATABLE`, it throws `SQLFeatureNotSupportedException`.
- Exception: If it is already closed, it throws `SQLException`. Otherwise, refer to the operation.

`void updateNCharacterStream(String columnLabel, Reader reader) throws SQLException`

- Operation: The cursor update feature has not yet been implemented. If `ResultSet` concurrency is `ResultSet.CONCUR_READ_ONLY`, it throws `SQLException`. If it is `ResultSet.CONCUR_UPDATABLE`, it throws `SQLFeatureNotSupportedException`.
- Exception: If it is already closed, it throws `SQLException`. Otherwise, refer to the operation.

`void updateNCharacterStream(String columnLabel, Reader reader, long length) throws SQLException`

- Operation: The cursor update feature has not yet been implemented. If `ResultSet` concurrency is `ResultSet.CONCUR_READ_ONLY`, it throws `SQLException`. If it is `ResultSet.CONCUR_UPDATABLE`, it throws `SQLFeatureNotSupportedException`.
- Exception: If it is already closed, it throws `SQLException`. Otherwise, refer to the operation.

updateNClob

`void updateNClob(int columnIndex, NClob nClob) throws SQLException`

- Operation: The cursor update feature has not yet been implemented. If `ResultSet` concurrency is `ResultSet.CONCUR_READ_ONLY`, it throws `SQLException`. If it is `ResultSet.CONCUR_UPDATABLE`, it throws `SQLFeatureNotSupportedException`.
- Exception: If it is already closed, it throws `SQLException`. Otherwise, refer to the operation.

`void updateNClob(int columnIndex, Reader reader) throws SQLException`

- Operation: The cursor update feature has not yet been implemented. If `ResultSet` concurrency is `ResultSet`

ResultSet.CONCUR_READ_ONLY, it throws SQLException. If it is ResultSet.CONCUR_UPDATABLE, it throws SQLFeatureNotSupportedException.

- Exception: If it is already closed, it throws SQLException. Otherwise, refer to the operation.

`void updateNClob(int columnIndex, Reader reader, long length) throws SQLException`

- Operation: The cursor update feature has not yet been implemented. If ResultSet concurrency is ResultSet.CONCUR_READ_ONLY, it throws SQLException. If it is ResultSet.CONCUR_UPDATABLE, it throws SQLFeatureNotSupportedException.
- Exception: If it is already closed, it throws SQLException. Otherwise, refer to the operation.

`void updateNClob(String columnLabel, NClob nClob) throws SQLException`

- Operation: The cursor update feature has not yet been implemented. If ResultSet concurrency is ResultSet.CONCUR_READ_ONLY, it throws SQLException. If it is ResultSet.CONCUR_UPDATABLE, it throws SQLFeatureNotSupportedException.
- Exception: If it is already closed, it throws SQLException. Otherwise, refer to the operation.

`void updateNClob(String columnLabel, Reader reader) throws SQLException`

- Operation: The cursor update feature has not yet been implemented. If ResultSet concurrency is ResultSet.CONCUR_READ_ONLY, it throws SQLException. If it is ResultSet.CONCUR_UPDATABLE, it throws SQLFeatureNotSupportedException.
- Exception: If it is already closed, it throws SQLException. Otherwise, refer to the operation.

`void updateNClob(String columnLabel, Reader reader, long length) throws SQLException`

- Operation: The cursor update feature has not yet been implemented. If ResultSet concurrency is ResultSet.CONCUR_READ_ONLY, it throws SQLException. If it is ResultSet.CONCUR_UPDATABLE, it throws SQLFeatureNotSupportedException.
- Exception: If it is already closed, it throws SQLException. Otherwise, refer to the operation.

updateNString

`void updateNString(int columnIndex, String nString) throws SQLException`

- Operation: The cursor update feature has not yet been implemented. If ResultSet concurrency is ResultSet.CONCUR_READ_ONLY, it throws SQLException. If it is ResultSet.CONCUR_UPDATABLE, it throws SQLFeatureNotSupportedException.
- Exception: If it is already closed, it throws SQLException. Otherwise, refer to the operation.

`void updateNString(String columnLabel, String nString) throws SQLException`

- Operation: The cursor update feature has not yet been implemented. If `ResultSet` concurrency is `ResultSet.CONCUR_READ_ONLY`, it throws `SQLException`. If it is `ResultSet.CONCUR_UPDATABLE`, it throws `SQLFeatureNotSupportedException`.
- Exception: If it is already closed, it throws `SQLException`. Otherwise, refer to the operation.

updateNull

`void updateNull(int columnIndex) throws SQLException`

- Operation: The cursor update feature has not yet been implemented. If `ResultSet` concurrency is `ResultSet.CONCUR_READ_ONLY`, it throws `SQLException`. If it is `ResultSet.CONCUR_UPDATABLE`, it throws `SQLFeatureNotSupportedException`.
- Exception: If it is already closed, it throws `SQLException`. Otherwise, refer to the operation.

`void updateNull(String columnLabel) throws SQLException`

- Operation: The cursor update feature has not yet been implemented. If `ResultSet` concurrency is `ResultSet.CONCUR_READ_ONLY`, it throws `SQLException`. If it is `ResultSet.CONCUR_UPDATABLE`, it throws `SQLFeatureNotSupportedException`.
- Exception: If it is already closed, it throws `SQLException`. Otherwise, refer to the operation.

updateObject

`void updateObject(int columnIndex, Object x) throws SQLException`

- Operation: The cursor update feature has not yet been implemented. If `ResultSet` concurrency is `ResultSet.CONCUR_READ_ONLY`, it throws `SQLException`. If it is `ResultSet.CONCUR_UPDATABLE`, it throws `SQLFeatureNotSupportedException`.
- Exception: If it is already closed, it throws `SQLException`. Otherwise, refer to the operation.

`void updateObject(int columnIndex, Object x, int scaleOrLength) throws SQLException`

- Operation: The cursor update feature has not yet been implemented. If `ResultSet` concurrency is `ResultSet.CONCUR_READ_ONLY`, it throws `SQLException`. If it is `ResultSet.CONCUR_UPDATABLE`, it throws `SQLFeatureNotSupportedException`.
- Exception: If it is already closed, it throws `SQLException`. Otherwise, refer to the operation.

`void updateObject(String columnLabel, Object x) throws SQLException`

- Operation: The cursor update feature has not yet been implemented. If `ResultSet` concurrency is `ResultSet.CONCUR_READ_ONLY`, it throws `SQLException`. If it is `ResultSet.CONCUR_UPDATABLE`, it throws `SQLFeatureNotSupportedException`.

- Exception: If it is already closed, it throws `SQLException`. Otherwise, refer to the operation.

`void updateObject(String columnLabel, Object x, int scaleOrLength) throws SQLException`

- Operation: The cursor update feature has not yet been implemented. If `ResultSet` concurrency is `ResultSet.CONCUR_READ_ONLY`, it throws `SQLException`. If it is `ResultSet.CONCUR_UPDATABLE`, it throws `SQLFeatureNotSupportedException`.
- Exception: If it is already closed, it throws `SQLException`. Otherwise, refer to the operation.

updateRef

`void updateRef(int columnIndex, Ref x) throws SQLException`

- Operation: The cursor update feature has not yet been implemented. If `ResultSet` concurrency is `ResultSet.CONCUR_READ_ONLY`, it throws `SQLException`. If it is `ResultSet.CONCUR_UPDATABLE`, it throws `SQLFeatureNotSupportedException`.
- Exception: If it is already closed, it throws `SQLException`. Otherwise, refer to the operation.

`void updateRef(String columnLabel, Ref x) throws SQLException`

- Operation: The cursor update feature has not yet been implemented. If `ResultSet` concurrency is `ResultSet.CONCUR_READ_ONLY`, it throws `SQLException`. If it is `ResultSet.CONCUR_UPDATABLE`, it throws `SQLFeatureNotSupportedException`.
- Exception: If it is already closed, it throws `SQLException`. Otherwise, refer to the operation.

updateRow

`void updateRow() throws SQLException`

- Operation: The cursor update feature has not yet been implemented. If `ResultSet` concurrency is `ResultSet.CONCUR_READ_ONLY`, it throws `SQLException`. If it is `ResultSet.CONCUR_UPDATABLE`, it throws `SQLFeatureNotSupportedException`.
- Exception: If it is already closed, it throws `SQLException`. Otherwise, refer to the operation.

updateRowId

`void updateRowId(int columnIndex, RowId x) throws SQLException`

- Operation: The cursor update feature has not yet been implemented. If `ResultSet` concurrency is `ResultSet.CONCUR_READ_ONLY`, it throws `SQLException`. If it is `ResultSet.CONCUR_UPDATABLE`, it throws `SQLFeatureNotSupportedException`.
- Exception: If it is already closed, it throws `SQLException`. Otherwise, refer to the operation.

`void updateRowId(String columnLabel, RowId x) throws SQLException`

- Operation: The cursor update feature has not yet been implemented. If `ResultSet` concurrency is `ResultSet.CONCUR_READ_ONLY`, it throws `SQLException`. If it is `ResultSet.CONCUR_UPDATABLE`, it throws `SQLFeatureNotSupportedException`.
- Exception: If it is already closed, it throws `SQLException`. Otherwise, refer to the operation.

updateShort

`void updateShort(int columnIndex, short x) throws SQLException`

- Operation: The cursor update feature has not yet been implemented. If `ResultSet` concurrency is `ResultSet.CONCUR_READ_ONLY`, it throws `SQLException`. If it is `ResultSet.CONCUR_UPDATABLE`, it throws `SQLFeatureNotSupportedException`.
- Exception: If it is already closed, it throws `SQLException`. Otherwise, refer to the operation.

`void updateShort(String columnLabel, short x) throws SQLException`

- Operation: The cursor update feature has not yet been implemented. If `ResultSet` concurrency is `ResultSet.CONCUR_READ_ONLY`, it throws `SQLException`. If it is `ResultSet.CONCUR_UPDATABLE`, it throws `SQLFeatureNotSupportedException`.
- Exception: If it is already closed, it throws `SQLException`. Otherwise, refer to the operation.

updateSQLXML

`void updateSQLXML(int columnIndex, SQLXML xmlObject) throws SQLException`

- Operation: The cursor update feature has not yet been implemented. If `ResultSet` concurrency is `ResultSet.CONCUR_READ_ONLY`, it throws `SQLException`. If it is `ResultSet.CONCUR_UPDATABLE`, it throws `SQLFeatureNotSupportedException`.
- Exception: If it is already closed, it throws `SQLException`. Otherwise, refer to the operation.

`void updateSQLXML(String columnLabel, SQLXML xmlObject) throws SQLException`

- Operation: The cursor update feature has not yet been implemented. If `ResultSet` concurrency is `ResultSet.CONCUR_READ_ONLY`, it throws `SQLException`. If it is `ResultSet.CONCUR_UPDATABLE`, it throws `SQLFeatureNotSupportedException`.
- Exception: If it is already closed, it throws `SQLException`. Otherwise, refer to the operation.

updateString

`void updateString(int columnIndex, String x) throws SQLException`

- Operation: The cursor update feature has not yet been implemented. If `ResultSet` concurrency is `ResultSet.CONCUR_READ_ONLY`, it throws `SQLException`. If it is `ResultSet.CONCUR_UPDATABLE`, it throws `SQLFeatureNotSupportedException`.
- Exception: If it is already closed, it throws `SQLException`. Otherwise, refer to the operation.

`void updateString(String columnLabel, String x) throws SQLException`

- Operation: The cursor update feature has not yet been implemented. If `ResultSet` concurrency is `ResultSet.CONCUR_READ_ONLY`, it throws `SQLException`. If it is `ResultSet.CONCUR_UPDATABLE`, it throws `SQLFeatureNotSupportedException`.
- Exception: If it is already closed, it throws `SQLException`. Otherwise, refer to the operation.

updateTime

`void updateTime(int columnIndex, Time x) throws SQLException`

- Operation: The cursor update feature has not yet been implemented. If `ResultSet` concurrency is `ResultSet.CONCUR_READ_ONLY`, it throws `SQLException`. If it is `ResultSet.CONCUR_UPDATABLE`, it throws `SQLFeatureNotSupportedException`.
- Exception: If it is already closed, it throws `SQLException`. Otherwise, refer to the operation.

`void updateTime(String columnLabel, Time x) throws SQLException`

- Operation: The cursor update feature has not yet been implemented. If `ResultSet` concurrency is `ResultSet.CONCUR_READ_ONLY`, it throws `SQLException`. If it is `ResultSet.CONCUR_UPDATABLE`, it throws `SQLFeatureNotSupportedException`.
- Exception: If it is already closed, it throws `SQLException`. Otherwise, refer to the operation.

updateTimestamp

`void updateTimestamp(int columnIndex, Timestamp x) throws SQLException`

- Operation: The cursor update feature has not yet been implemented. If `ResultSet` concurrency is `ResultSet.CONCUR_READ_ONLY`, it throws `SQLException`. If it is `ResultSet.CONCUR_UPDATABLE`, it throws `SQLFeatureNotSupportedException`.
- Exception: If it is already closed, it throws `SQLException`. Otherwise, refer to the operation.

`void updateTimeStamp(String columnLabel, Timestamp x) throws SQLException`

- Operation: The cursor update feature has not yet been implemented. If `ResultSet` concurrency is `ResultSet.CONCUR_READ_ONLY`, it throws `SQLException`. If it is `ResultSet.CONCUR_UPDATABLE`, it throws `SQLFeatureNotSupportedException`.
- Exception: If it is already closed, it throws `SQLException`. Otherwise, refer to the operation.

wasNull

`boolean wasNull() throws SQLException`

- Operation: It queries whether the column value which was read last is `NULL`. If it is `NULL`, it returns `true`. Otherwise, it returns `false`.
- Exception: If `ResultSet` is already closed or the column value never has been read, it throws `SQLException`.

isWrapperFor

`boolean isWrapperFor(Class<?> iface)`

- Operation: It queries whether this object is the class which implemented the `iface` interface. If it so, it returns `true`. Otherwise, it returns `false`. It does not determine the presence of the wrapper and it queries only whether the given argument class type is implemented because `GOLDILOCKS` `ResultSet` object is not the wrapper of any other class.
- Exception: It does not occur.

unwrap

`<T> T unwrap(Class<T> iface)`

- Operation: It eventually returns itself even when it is unwrapped because `GOLDILOCKS` `ResultSet` is not the wrapper of any other class. It returns after casting to that type. If `iface` is an argument of `isWrapperFor()` method and `false` is returned, then the method throws an exception.
- Exception: If `iface` is not this object type (when this object type is not implemented.), it throws `SQLException`.

ResultSetMetaData

getCatalogName

String getCatalogName(int column) throws SQLException

- Operation: It returns the catalog name of the column.
- Exception: If the column value is wrong, it throws SQLException.

getColumnClassName

String getColumnClassName(int column) throws SQLException

- Operation: It returns the name of Java class which is the most appropriate to the column type. It is specified such as java.math.BigDecimal, and it refers to getName() method in Java. For binary type, it refers to byte[].class.getName(), so it can be specified such as '[B'.
- Exception: If the column value is wrong, it throws SQLException.

getColumnCount

int getColumnCount() throws SQLException

- Operation: It returns the number of columns that the ResultSet has.
- Exception: It does not occur.

getColumnDisplaySize

int getColumnDisplaySize(int column) throws SQLException

- Operation: It returns the maximum width when the column value is displayed.
- Exception: If the column value is wrong, it throws SQLException.

getColumnLabel

String getColumnLabel(int column) throws SQLException

- Operation: It gets the label of the column. For example, the label is "C1 + 1" and the name is "" for the query statement such as "select C1 + 1 from t1".
- Exception: If the column value is wrong, it throws SQLException.

getColumnName

String getColumnName(int column) throws SQLException

- Operation: It returns the alias name of the column. The original column name, not the alias name is defined to be returned in JDBC specification. However, it is recommended to use the alias name because some view names are meaningless or complicated. For example, both the name and label are "C2" for the query statement such as "select C1 as C2 from t1". For more information about the case of when name and label are different, refer to **getColumnLabel**.
- Exception: If the column value is wrong, it throws SQLException.

getColumnType

int getColumnType(int column) throws SQLException

- Operation: It returns the type of the column. The return value is defined in types. Types.OTHERS is returned for GOLDILOCKS interval family types. The constant values of the corresponding types are returned for the other types.
- Exception: If the column value is wrong, it throws SQLException.

getColumnTypeName

String getColumnTypeName(int column) throws SQLException

- Operation: It returns GOLDILOCKS column type name of the column.
- Exception: If the column value is wrong, it throws SQLException.

getPrecision

int getPrecision(int column) throws SQLException

- Operation: It returns the precision of the column. It returns 0 for the type without any precision.
- Exception: If the column value is wrong, it throws SQLException.

getScale

int getScale(int column) throws SQLException

- Operation: It returns the scale of the column. It returns 0 for the type without any scale.
- Exception: If the column value is wrong, it throws SQLException.

getSchemaName

String getSchemaName(int column) throws SQLException

- Operation: It returns the schema name of the column.
- Exception: If the column value is wrong, it throws SQLException.

getTableName

String getTableName(int column) throws SQLException

- Operation: It returns the table name of the column.
- Exception: If the column value is wrong, it throws SQLException.

isAutoIncrement

boolean isAutoIncrement(int column) throws SQLException

- Operation: It returns whether it is the column which is automatically given the unique value. If so, it returns true. Otherwise, it returns false.
- Exception: If the column value is wrong, it throws SQLException.

isCaseSensitive

boolean isCaseSensitive(int column) throws SQLException

- Operation: It returns whether the column is case sensitive. If it is case sensitive, it returns true. Otherwise, it returns false.
- Exception: If the column value is wrong, it throws SQLException.

isCurrency

boolean isCurrency(int column) throws SQLException

- Operation: It always returns false because the currency of the column can not be determined by the server.
- Exception: If the column value is wrong, it throws SQLException.

isDefinitelyWritable

`boolean isDefinitelyWritable(int column)` throws `SQLException`

- Operation: It returns whether the column is updatable. GOLDILOCKS does not support the definitely writable. It always returns the value as same as `isUpdatable()`.
- Exception: If the column value is wrong, it throws `SQLException`.

isNullable

`int isNullable(int column)` throws `SQLException`

- Operation: It returns whether the column has nullable. It returns either `columnNullable` or `columnNoNulls`.
- Exception: If the column value is wrong, it throws `SQLException`.

isReadOnly

`boolean isReadOnly(int column)` throws `SQLException`

- Operation: It returns whether the column is read only. It always returns the opposite value of `isUpdatable()`.
- Exception: If the column value is wrong, it throws `SQLException`.

isSearchable

`boolean isSearchable(int column)` throws `SQLException`

- Operation: It returns whether the column can be used in the conditional clause. It always returns true because all target columns in GOLDILOCKS can be used in the conditional clause.
- Exception: If the column value is wrong, it throws `SQLException`.

isSigned

`boolean isSigned(int column)` throws `SQLException`

- Operation: It returns whether the column has a sign. If it has a sign, it returns true. Otherwise, it returns false.
- Exception: If the column value is wrong, it throws `SQLException`.

isWritable

`boolean isWritable(int column) throws SQLException`

- Operation: It returns whether the column is updatable.
- Exception: If the column value is wrong, it throws SQLException.

isWrapperFor

`boolean isWrapperFor(Class<?> iface)`

- Operation: It queries whether the object is a class implementing the `iface` interface. If so, it returns `true`. Otherwise, it returns `false`. It does not determine the presence of the wrapper and it queries only whether the given argument class type is implemented because `GOLDILOCKS ResultSetMetaData` object is not the wrapper of any other class.
- Exception: It does not occur.

unwrap

`<T> T unwrap(Class<T> iface)`

- Operation: It eventually returns itself, even when it is unwrapped because `GOLDILOCKS ResultSetMetaData` is not the wrapper of any other class. It returns after casting to that type. If `iface` is an argument of `isWrapperFor()` method and `false` is returned, the method throws an exception.
- Exception: If `iface` is not the type of the object (if this object returns the unimplemented type), it throws SQLException.

RowId

equals

`boolean equals(Object obj)` throws `SQLException`

- Operation: If RowId of this object is as same as RowId of obj, it returns true. Otherwise, it returns false.
- Exception: It does not occur.

getBytes

`byte[] getBytes()` throws `SQLException`

- Operation: It returns the byte array value of RowId.
- Exception: It does not occur.

hashCode

`int hashCode()` throws `SQLException`

- Operation: It returns the hash code value.
- Exception: It does not occur.

toString

`String toString()` throws `SQLException`

- Operation: It returns a base-64 string of RowId value.
- Exception: It does not occur.

RowSet

The class is not implemented

addRowSetListener

void addRowSetListener(RowSetListener listener) throws SQLException

clearParameters

void clearParameters() throws SQLException

execute

void execute() throws SQLException

getCommand

String getCommand() throws SQLException

getDataSourceName

String getDataSourceName() throws SQLException

getEscapeProcessing

boolean getEscapeProcessing() throws SQLException

getMaxFieldSize

int getMaxFieldSize() throws SQLException

getMaxRows

`int getMaxRows()` throws `SQLException`

getPassword

`String getPassword()` throws `SQLException`

getQueryTimeout

`int getQueryTimeout()` throws `SQLException`

getTransactionIsolation

`int getTransactionIsolation()` throws `SQLException`

getTypeMap

`Map<String,Class<?>> getTypeMap()` throws `SQLException`

getUrl

`String getUrl()` throws `SQLException`

getUsername

`String getUsername()` throws `SQLException`

isReadOnly

`boolean isReadOnly()` throws `SQLException`

removeRowSetListener

`void removeRowSetListener(RowSetListener listener) throws SQLException`

setArray

`void setArray(int i, Array x) throws SQLException`

setAsciiStream

`void setAsciiStream(int parameterIndex, InputStream x) throws SQLException`

`void setAsciiStream(int parameterIndex, InputStream x, int length) throws SQLException`

`void setAsciiStream(String parameterName, InputStream x) throws SQLException`

`void setAsciiStream(String parameterName, InputStream x, int length) throws SQLException`

setBigDecimal

`void setBigDecimal(int parameterIndex, BigDecimal x) throws SQLException`

`void setBigDecimal(String parameterName, BigDecimal x) throws SQLException`

setBinaryStream

`void setBinaryStream(int parameterIndex, InputStream x) throws SQLException`

`void setBinaryStream(int parameterIndex, InputStream x, int length) throws SQLException`

`void setBinaryStream(String parameterName, InputStream x) throws SQLException`

`void setBinaryStream(String parameterName, InputStream x, int length) throws SQLException`

setBlob

`void setBlob(int i, Blob x) throws SQLException`

`void setBlob(int parameterIndex, InputStream inputStream) throws SQLException`

`void setBlob(int parameterIndex, InputStream inputStream, long length) throws SQLException`

`void setBlob(String parameterName, Blob x) throws SQLException`

`void setBlob(String parameterName, InputStream inputStream) throws SQLException`

`void setBlob(String parameterName, InputStream inputStream, long length) throws SQLException`

setBoolean

`void setBoolean(int parameterIndex, boolean x) throws SQLException`

`void setBoolean(String parameterName, boolean x) throws SQLException`

setByte

`void setByte(int parameterIndex, byte x) throws SQLException`

`void setByte(String parameterName, byte x) throws SQLException`

setBytes

`void setBytes(int parameterIndex, byte[] x) throws SQLException`

`void setBytes(String parameterName, byte[] x) throws SQLException`

setCharacterStream

`void setCharacterStream(int parameterIndex, Reader reader) throws SQLException`

`void setCharacterStream(int parameterIndex, Reader reader, int length) throws SQLException`

`void setCharacterStream(String parameterName, Reader reader) throws SQLException`

`void setCharacterStream(String parameterName, Reader reader, int length) throws SQLException`

setClob

- | `void setClob(int i, Clob x) throws SQLException`
- | `void setClob(int parameterIndex, Reader reader) throws SQLException`
- | `void setClob(int parameterIndex, Reader reader, long length) throws SQLException`
- | `void setClob(String parameterName, Clob x) throws SQLException`
- | `void setClob(String parameterName, Reader reader) throws SQLException`
- | `void setClob(String parameterName, Reader reader, long length) throws SQLException`

setCommand

- | `void setCommand(String cmd) throws SQLException`

setConcurrency

- | `void setConcurrency(int concurrency) throws SQLException`

setDataSourceName

- | `void setDataSourceName(String name) throws SQLException`

setDate

- | `void setDate(int parameterIndex, Date x) throws SQLException`
- | `void setDate(int parameterIndex, Date x, Calendar cal) throws SQLException`
- | `void setDate(String parameterName, Date x) throws SQLException`
- | `void setDate(String parameterName, Date x, Calendar cal) throws SQLException`

setDouble

`void setDouble(int parameterIndex, double x) throws SQLException`

`void setDouble(String parameterName, double x) throws SQLException`

setEscapeProcessing

`void setEscapeProcessing(boolean enable) throws SQLException`

setFloat

`void setFloat(int parameterIndex, float x) throws SQLException`

`void setFloat(String parameterName, float x) throws SQLException`

setInt

`void setInt(int parameterIndex, int x) throws SQLException`

`void setInt(String parameterName, int x) throws SQLException`

setLong

`void setLong(int parameterIndex, long x) throws SQLException`

`void setLong(String parameterName, long x) throws SQLException`

setMaxFieldSize

`void setMaxFieldSize(int max) throws SQLException`

setMaxRows

`void setMaxRows(int max) throws SQLException`

setNCharacterStream

- | `void setNCharacterStream(int parameterIndex, Reader value) throws SQLException`
- | `void setNCharacterStream(int parameterIndex, Reader value, long length) throws SQLException`
- | `void setNCharacterStream(String parameterName, Reader value) throws SQLException`
- | `void setNCharacterStream(String parameterName, Reader value, long length) throws SQLException`

setNClob

- | `void setNClob(int parameterIndex, NClob value) throws SQLException`
- | `void setNClob(int parameterIndex, Reader reader) throws SQLException`
- | `void setNClob(int parameterIndex, Reader reader, long length) throws SQLException`
- | `void setNClob(String parameterName, NClob value) throws SQLException`
- | `void setNClob(String parameterName, Reader reader) throws SQLException`
- | `void setNClob(String parameterName, Reader reader, long length) throws SQLException`

setNString

- | `void setNString(int parameterIndex, String value) throws SQLException`
- | `void setNString(String parameterName, String value) throws SQLException`

setNull

- | `void setNull(int parameterIndex, int sqlType) throws SQLException`
- | `void setNull(int paramIndex, int sqlType, String typeName) throws SQLException`
- | `void setNull(String parameterName, int sqlType) throws SQLException`

`void setNull(String parameterName, int sqlType, String typeName) throws SQLException`

setObject

`void setObject(int parameterIndex, Object x) throws SQLException`

`void setObject(int parameterIndex, Object x, int targetSqlType) throws SQLException`

`void setObject(int parameterIndex, Object x, int targetSqlType, int scaleOrLength) throws SQLException`

`void setObject(String parameterName, Object x) throws SQLException`

`void setObject(String parameterName, Object x, int targetSqlType) throws SQLException`

`void setObject(String parameterName, Object x, int targetSqlType, int scale) throws SQLException`

setPassword

`void setPassword(String password) throws SQLException`

setQueryTimeout

`void setQueryTimeout(int seconds) throws SQLException`

setReadOnly

`void setReadOnly(boolean value) throws SQLException`

setRef

`void setRef(int i, Ref x) throws SQLException`

setRowId

| void setRowId(int parameterIndex, RowId x) throws SQLException

| void setRowId(String parameterName, RowId x) throws SQLException

setShort

| void setShort(int parameterIndex, short x) throws SQLException

| void setShort(String parameterName, short x) throws SQLException

setSQLXML

| void setSQLXML(int parameterIndex, SQLXML xmlObject) throws SQLException

| void setSQLXML(String parameterName, SQLXML xmlObject) throws SQLException

setString

| void setString(int parameterIndex, String x) throws SQLException

| void setString(String parameterName, String x) throws SQLException

setTime

| void setTime(int parameterIndex, Time x) throws SQLException

| void setTime(int parameterIndex, Time x, Calendar cal) throws SQLException

| void setTime(String parameterName, Time x) throws SQLException

| void setTime(String parameterName, Time x, Calendar cal) throws SQLException

setTimestamp

`void setTimestamp(int parameterIndex, Timestamp x) throws SQLException`

`void setTimestamp(int parameterIndex, Timestamp x, Calendar cal) throws SQLException`

`void setTimestamp(String parameterName, Timestamp x) throws SQLException`

`void setTimestamp(String parameterName, Timestamp x, Calendar cal) throws SQLException`

setTransactionIsolation

`void setTransactionIsolation(int level) throws SQLException`

setType

`void setType(int type) throws SQLException`

setTypeMap

`void setTypeMap(Map<String,Class<?>> map) throws SQLException`

setURL

`void setURL(int parameterIndex, URL x) throws SQLException`

setUrl

`void setUrl(String url) throws SQLException`

setUsername

`void setUsername(String name) throws SQLException`

RowSetMetaData

The class is not implemented

setAutoIncrement

| void setAutoIncrement(int columnIndex, boolean property) throws SQLException

setCaseSensitive

| void setCaseSensitive(int columnIndex, boolean property) throws SQLException

setCatalogName

| void setCatalogName(int columnIndex, String catalogName) throws SQLException

setColumnCount

| void setColumnCount(int columnCount) throws SQLException

setColumnDisplaySize

| void setColumnDisplaySize(int columnIndex, int size) throws SQLException

setColumnLabel

| void setColumnLabel(int columnIndex, String label) throws SQLException

setColumnName

| void setColumnName(int columnIndex, String columnName) throws SQLException

setColumnType

`void setColumnType(int columnIndex, int SQLType) throws SQLException`

setColumnName

`void setColumnName(int columnIndex, String typeName) throws SQLException`

setCurrency

`void setCurrency(int columnIndex, boolean property) throws SQLException`

setNullable

`void setNullable(int columnIndex, int property) throws SQLException`

setPrecision

`void setPrecision(int columnIndex, int precision) throws SQLException`

setScale

`void setScale(int columnIndex, int scale) throws SQLException`

setSchemaName

`void setSchemaName(int columnIndex, String schemaName) throws SQLException`

setSearchable

`void setSearchable(int columnIndex, boolean property) throws SQLException`

setSigned

| void setSigned(int columnIndex, boolean property) throws SQLException

setTableName

| void setTableName(int columnIndex, String tableName) throws SQLException

Savepoint

getSavepointId

`int getSavepointId()` throws `SQLException`

- Operation: It returns the id value which is automatically assigned.
- Exception: It throws `SQLException` because it does not have an ID if the savepoint object is created by giving its name.

getSavepointName

`String getSavepointName()` throws `SQLException`

- Operation: It returns the name specified at the time of when a savepoint object is created.
- Exception: If the savepoint created with an automatic id value, it throws `SQLException`.

SQLData

The class is not implemented.

getSQLTypeName

| String getSQLTypeName() throws SQLException

readSQL

| void readSQL(SQLInput stream, String typeName) throws SQLException

writeSQL

| void writeSQL(SQLOutput stream) throws SQLException

SQLXML

The class is not implemented.

free

`void free() throws SQLException`

getBinaryStream

`InputStream getBinaryStream() throws SQLException`

getCharacterStream

`Reader getCharacterStream() throws SQLException`

getSource

`<T extends Source> T getSource(Class<T> sourceClass) throws SQLException`

getString

`String getString() throws SQLException`

setBinaryStream

`OutputStream setBinaryStream() throws SQLException`

setCharacterStream

`Writer setCharacterStream() throws SQLException`

setResult

| `<T extends Result> T setResult(Class<T> resultClass) throws SQLException`

setString

| `void setString(String value) throws SQLException`

Statement

addBatch

void addBatch(String sql) throws SQLException

- Operation: The SQL statement is added to the batch job.
- Exception: It does not occur.

cancel

void cancel() throws SQLException

- Operation: It is not supported.
- Exception: It always throws `SQLFeatureNotSupportedException`.

clearBatch

void clearBatch() throws SQLException

- Operation: It clears all registered batch jobs. If registered batch job does not exist, any operation is not performed.
- Exception: It does not occur.

clearWarnings

void clearWarnings() throws SQLException

- Operation: It clears all `SQLWarning` objects which is owned by the statement object.
- Exception: It does not occur.

close

void close() throws SQLException

- Operation: The current statement object is closed, and it is released if the statement related information assigned to the server exists. If the `ResultSet` created by the object exists, it is closed. The object is removed from the connection object which created the statement object.
- Exception: If an error occurs when statement information is released from the server, it throws an exc

ption.

execute

`boolean execute(String sql)` throws `SQLException`

- Operation: It executes the SQL statement. If the executed SQL statement has the `ResultSet`, it returns `true`. Otherwise, it returns `false`.
- Exception: If the statement is already closed or the batch job is registered or an error occurs when executing from the server, it throws an exception.

`boolean execute(String sql, int autoGeneratedKeys)` throws `SQLException`

- Operation: It executes the SQL statement. If the executed SQL statement has the `ResultSet`, it returns `true`. Otherwise, it returns `false`. Auto key generation is not supported.
- Exception: If the statement is already closed or the batch job is registered or an error occurs when executing from the server, it throws an exception. If `autoGeneratedKeys` is not `Statement.NO_GENERATED_KEYS`, it throws `SQLFeatureNotSupportedException`.

`boolean execute(String sql, int[] columnIndexes)` throws `SQLException`

- Operation: It executes the SQL statement. If the executed SQL statement has the `ResultSet`, it returns `true`. Otherwise, it returns `false`. Auto key generation is not supported.
- Exception: If the statement is already closed or the batch job is registered or an error occurs when executing from the server, it throws an exception. If the `columnIndexes` are not null, it throws `SQLFeatureNotSupportedException`.

`boolean execute(String sql, String[] columnNames)` throws `SQLException`

- Operation: It executes the SQL statement. If the executed SQL statement has the `ResultSet`, it returns `true`. Otherwise, it returns `false`. Auto key generation is not supported.
- Exception: If the statement is already closed or the batch job is registered or an error occurs when executing from the server, it throws an exception. If the `columnNames` are not null, it throws `SQLFeatureNotSupportedException`.

executeBatch

`int[] executeBatch()` throws `SQLException`

- Operation: It executes the registered batch job in turn. The communication with the server occurs per each batch job. It returns the array of the number of rows in which the update reflected after executing each batch job.
- Exception: If the statement is already closed or any batch job is not registered or an error occurs when

n executing from the server, it throws an exception.



It does not have definite advantage over the normal `execute()` because the batch jobs are not transmitted and executed at once. Use a batch execution of the `PreparedStatement` for fast processing.

executeQuery

`ResultSet executeQuery(String sql)` throws `SQLException`

- Operation: It executes the given SQL statement and gets part of results and creates the `ResultSet`.
- Exception: If the statement is already closed or the batch job is registered or an error occurs when executing on the server or the SQL statement is not the select statement, it throws an exception.



Its operation is a bit different from `execute()`. The communicate with the server occurs twice if `getResultSet()` is performed for the same SQL statement after performing `execute()`. The execution command is performed when performing `execute()`, and the fetch related command is performed when performing `getResultSet()`. On the other hand, `executeQuery()` assumes that the SQL statement is the select statement, and it executes all with a single communication until fetch.

executeUpdate

`int executeUpdate(String sql)` throws `SQLException`

- Operation: It executes the SQL statement. It returns the number of rows updated by the execution.
- Exception: If the statement is already closed or the batch job is registered or an error occurs when executing on the server or the SQL statement is the select statement, it throws an exception.

`int executeUpdate(String sql, int autoGeneratedKeys)` throws `SQLException`

- Operation: It executes the SQL statement. It returns the number of rows updated by the execution. The auto key generation feature is not supported.
- Exception: If the statement is already closed or the batch job is registered or an error occurs when executing on the server or the SQL statement is the select statement, it throws an exception. If `autoGeneratedKeys` is not `Statement.NO_GENERATED_KEYS`, it throws `SQLFeatureNotSupportedException`.

`int executeUpdate(String sql, int[] columnIndexes)` throws `SQLException`

- Operation: It executes the SQL statement. It returns the number of rows updated by the execution. T

he auto key generation feature is not supported.

- Exception: If the statement is already closed or the batch job is registered or an error occurs when executing on the server or the SQL statement is the select statement, it throws an exception. If the columnIndexes are not null, it throws `SQLFeatureNotSupportedException`.

`int executeUpdate(String sql, String[] columnNames)` throws `SQLException`

- Operation: It executes the SQL statement. It returns the number of rows updated by the execution. The auto key generation feature is not supported.
- Exception: If the statement is already closed or the batch job is registered or an error occurs when executing from the server or the SQL statement is the select statement, it throws an exception. If the columnNames are not null, it throws `SQLFeatureNotSupportedException`.

getConnection

`Connection getConnection()` throws `SQLException`

- Operation: It returns the connection object which created the object. If statement object is created with logical connection via the `PooledConnection`, the user gets the logical connection, not the physical connection via the method.
- Exception: If the statement is already closed, it throws an exception.

getExplainPlan

`String getExplainPlan()` throws `SQLException`

- Operation: It is non-standard method, and it is the unique method of `GoldilocksStatement`. It gets the generated plan text. It should set for generating the plan text via `setExplainPlanOption` to use the method. For more information about the detailed usage, refer to **Viewing Plan Text**.
- Exception: If the statement is already closed or an error occurs on the server, it throws an exception.

getExplainPlanOption

`int getExplainPlanOption()` throws `SQLException`

- Operation: It is non-standard method, and it is the unique method of `GoldilocksStatement`. It gets the option for the generating the plan text which is currently set. The return value is one of the following and the default value is `GoldilocksStatement.EXPLAIN_PLAN_OPTION_OFF`.
 - `GoldilocksStatement.EXPLAIN_PLAN_OPTION_OFF`
 - `GoldilocksStatement.EXPLAIN_PLAN_OPTION_ON`
 - `GoldilocksStatement.EXPLAIN_PLAN_OPTION_ON_VERBOSE`

- `GoldilocksStatement.EXPLAIN_PLAN_OPTION_ONLY`
- Exception: It does not occur.

getFetchDirection

`int getFetchDirection()` throws `SQLException`

- Operation: It always returns `ResultSet.FETCH_FORWARD`.
- Exception: If the statement is already closed, it throws an exception.

getFetchSize

`int getFetchSize()` throws `SQLException`

- Operation: It returns the default fetch size of `ResultSet` which is got from the statement object. The default value is 0, and 0 refers that the server determines the number of fetched rows. For more information, refer to `getFetchSize` of `ResultSet`.
- Exception: If the statement is already closed, it throws an exception.

getGeneratedKeys

`ResultSet getGeneratedKeys()` throws `SQLException`

- Operation: It is not supported.
- Exception: It always throws `SQLFeatureNotSupportedException`.

getMaxFieldSize

`int getMaxFieldSize()` throws `SQLException`

- Operation: It returns the max field size. The value limits the maximum length of the column. If the column value is bigger than this length when fetching, the rest of the data is truncated. The default value is 0, and 0 refers that the maximum length is infinite.
- Exception: If the statement is already closed, it throws an exception.

getMaxRows

`int getMaxRows()` throws `SQLException`

- Operation: It returns the max rows. The max rows refer to the maximum number of rows of `ResultSet`

t which is got from the statement. The rows more than the maximum number of rows are ignored. The default value is 0, and 0 means infinity.

- Exception: If the statement is already closed, it throws an exception.

getMoreResults

`boolean getMoreResults()` throws `SQLException`

- Operation: It always returns false because a user can only have a single `ResultSet` per one execution, currently. The current `ResultSet` is closed.
- Exception: If the statement is already closed, it throws an exception.

`boolean getMoreResults(int current)` throws `SQLException`

getQueryTimeout

`int getQueryTimeout()` throws `SQLException`

- Operation: It gets the value of the query timeout. The value is the timeout value which the server applies at execution. The execution is canceled and the user gets the error related to timeout if the execution time exceeds the time. The unit is seconds and it applies the default value of the session if the user does not specifically set it. The default value of the session is 0 if it is not set with the property, and it refers to the infinite wait.
- Exception: If the statement is already closed, it throws an exception.

getResultSet

`ResultSet getResultSet()` throws `SQLException`

- Operation: It performs the fetch for the currently execution, and it gets part of fetched results, and creates and returns the `ResultSet`. JDBC specification defines to call this method once per the execution, but it is implemented to return the same object for several calls of the method.
- Exception: If the statement is already closed, it throws an exception. If an error occurs on the server when fetching, it throws an exception.

getResultSetConcurrency

`int getResultSetConcurrency()` throws `SQLException`

- Operation: It returns the `ResultSet` concurrency. The value determines the concurrency of `ResultSet` generated from the object. The default value is `ResultSet.CONCUR_READ_ONLY`. The updatable cursor

r is not yet supported.

- Exception: If the statement is already closed, it throws an exception.

getResultSetHoldability

`int getResultSetHoldability()` throws `SQLException`

- Operation: It returns the `ResultSet` holdability. The value determines the holdability of `ResultSet` generated from the object. The default value is `ResultSet.HOLD_CURSORS_OVER_COMMIT`.
- Exception: If the statement is already closed, it throws an exception.

getResultSetType

`int getResultSetType()` throws `SQLException`

- Operation: It returns the `ResultSet` type. The value determines the type of `ResultSet` generated from the object. The default value is `ResultSet.TYPE_FORWARD_ONLY`.
- Exception: If the statement is already closed, it throws an exception.

getUpdateCount

`int getUpdateCount()` throws `SQLException`

- Operation: It returns the number of rows in which the update for the last execution is reflected. If the last executed SQL statement is not `UPDATE` statement nor is `INSERT` statement, it returns -1.
- Exception: It does not occur.

getUpdateRowCount

`long getUpdateRowCount()` throws `SQLException`

- Operation: It is as same as `getUpdateCount`, but the returned type is `long`. It is non-standard method, and the type casting to `GoldilocksStatement` should be performed to use it.
- Exception: It does not occur.

getWarnings

`SQLWarning getWarnings()` throws `SQLException`

- Operation: It returns `SQLWarning` accumulated on the object. If it does not exist, it returns `null`.

- Exception: It does not occur.

isClosed

`boolean isClosed()` throws `SQLException`

- Operation: It returns whether the statement is closed. If it is closed, it returns true. Otherwise, it returns false. It can be closed not only by the explicit call of `close()` but also by the server or the connection object.
- Exception: It does not occur.

isPoolable

`boolean isPoolable()` throws `SQLException`

- Operation: Statement pooling is not supported. It always returns false.
- Exception: It does not occur.

setCursorName

`void setCursorName(String name)` throws `SQLException`

- Operation: It sets a name for the cursor created by the currently executed statement.
- Exception: If an error occurs on the server when setting the cursor name, it throws an exception.

setEscapeProcessing

`void setEscapeProcessing(boolean enable)` throws `SQLException`

- Operation: JDBC can not ban the feature because the escape processing of the SQL statement is performed in the server parser. Any operation is not performed.
- Exception: If the statement is already closed, it throws an exception.

setExplainPlanOption

`void setExplainPlanOption(int option)` throws `SQLException`

- Operation: It is non standard method, but it is the `GoldilocksStatement` unique method. It specifies the plan text generation options. The option should be set to one of the followings, and each meaning is as follows.

- `GoldilocksStatement.EXPLAIN_PLAN_OPTION_OFF`: The plan text is not generated.
- `GoldilocksStatement.EXPLAIN_PLAN_OPTION_ON`: The plan text is generated when executing.
- `GoldilocksStatement.EXPLAIN_PLAN_OPTION_ON_VERBOSE`: Detailed plan text is generated when executing.
- `GoldilocksStatement.EXPLAIN_PLAN_OPTION_ONLY`: The plan text is generated when executing, but the actual execution is not performed.
- Exception: When setting a value other than four values above, it throws an exception.

setFetchDirection

`void setFetchDirection(int direction) throws SQLException`

- Operation: It sets the fetch direction. If the direction is not `ResultSet.FETCH_FORWARD`, it throws an exception because `GOLDILOCKS` supports only the forward fetch.
- Exception: If the statement is already closed or the direction is not `FETCH_FORWARD`, it throws an exception.

setFetchSize

`void setFetchSize(int rows) throws SQLException`

- Operation: It sets the default fetch size of `ResultSet` which is got from the statement object. The default value is 0, and 0 refers that the server determines the number of fetched rows. For more information, refer to **setFetchSize** of `ResultSet`.
- Exception: If the statement is already closed, it throws an exception.

setMaxFieldSize

`void setMaxFieldSize(int max) throws SQLException`

- Operation: It sets the max field size. The value limits the maximum length of the column. If the column value is bigger than this length when fetching, the rest of the data is truncated. The default value is 0, 0 refers that the maximum length is infinity. It is valid for `CHAR`, `VARCHAR`, `LONG VARCHAR`, `BINARY`, `VARBINARY`, `LONG VARBINARY` types.
- Exception: If the statement is already closed, it throws an exception.

setMaxRows

`void setMaxRows(int max) throws SQLException`

- Operation: It sets the max rows. The max rows refers to the maximum number of rows of `ResultSet`

which is got from the statement. The rows more than the maximum number of rows are ignored. The default is 0, and 0 means infinity.

- Exception: If the statement is already closed, it throws an exception.

setPoolable

`void setPoolable(boolean poolable) throws SQLException`

- Operation: Statement pooling is not supported. Any operation is not performed.
- Exception: It does not occur.

setQueryTimeout

`void setQueryTimeout(int seconds) throws SQLException`

- Operation: It sets the value of query timeout. The value is the timeout value which the server applies at the execution, and the execution is canceled and the user gets the error related to timeout if the execution time exceeds the time. The unit is seconds and it applies the default value of the session if the user does not specifically set it. The default value of the session is 0 if it is not set with the property, and 0 refers to the infinite wait.
- Exception: If the statement is already closed, it throws an exception.

isWrapperFor

`boolean isWrapperFor(Class<?> iface) throws SQLException`

- Operation: It queries whether the object is a class which implements the iface interface. If so, it returns true. Otherwise, it returns false. It does not determine the presence of the wrapper but it only queries only whether the given argument class type is implemented because GOLDILOCKS statement object is not the wrapper of any other class.
- Exception: It does not occur.

unwrap

`<T> T unwrap(Class<T> iface) throws SQLException`

- Operation: It eventually returns itself, even when it is unwrapped because GOLDILOCKS statement is not the wrapper of any other class. It returns after casting to that type. If iface is an argument of isWrapperFor() method and false is returned, the method throws an exception.
- Exception: If iface is not the type of the object (when this object returns the unimplemented type), it throws SQLException.

Struct

The class is not implemented.

getAttributes

| Object[] getAttributes() throws SQLException

getAttributes

| Object[] getAttributes(Map<String,Class<?>> map) throws SQLException

getSQLTypeName

| String getSQLTypeName() throws SQLException

XAConnection

getXAResource

XAResource `getXAResource()` throws `SQLException`

- Operation: It returns XAResource object which can perform XA command. When the method is called for several times, the same result is continuously returned.
- Exception: It does not occur.

XADataSource

getXAConnection

`XAConnection getXAConnection()` throws `SQLException`

- Operation: It creates `XAConnection` object and returns it. The information required for the connection should be set as the separate non-standard methods in advance.
- Exception: When connection to the server is failed, it throws `SQLException`.

`XAConnection getXAConnection(String user, String password)` throws `SQLException`

- Operation: It opens and returns a new `XAConnection` object with the username and password. Other information required for the connection should be set as the separate non-standard methods in advance.
- Exception: When connection to the server is failed, it throws `SQLException`.

XAResource

commit

`void commit(Xid xid, boolean onePhase) throws XAException`

- Operation: It performs the XA commit command for the global transaction xid. If onePhase is set to true, one phase commit is performed.
- Exception: If the execution result error occurs, it throws XAException.

end

`void end(Xid xid, int flags) throws XAException`

- Operation: It performs the XA end command for the global transaction xid. The flags may be one of TMSUCCESS, TMFAIL, or TMSUSPEND.
- Exception: If the execution result error occurs, it throws XAException.

forget

`void forget(Xid xid) throws XAException`

- Operation: It performs the XA forget command for the global transaction xid.
- Exception: If the execution result error occurs, it throws XAException.

getTransactionTimeout

`int getTransactionTimeout() throws XAException`

- Operation: GOLDILOCKS does not support the transaction timeout. It always return 0.
- Exception: It does not occur.

isSameRM

`boolean isSameRM(XAResource xares) throws XAException`

- Operation: It has the unique rmid when XAResource object is created. Whether it is the same XAResource object is determined with this rmid.
- Exception: It does not occur.

prepare

`int prepare(Xid xid) throws XAException`

- Operation: It performs the XA prepare command for the global transaction xid.
- Exception: If the execution result error occurs, it throws XAException.

recover

`Xid[] recover(int flag) throws XAException`

- Operation: It performs XA recover command with the given flag, and the array of the prepared transaction branches is returned. The flag may be one of TMSTARTRSCAN, TMENDRSCAN, TMNOFLAGS.
- Exception: If the execution result error occurs, it throws XAException.

rollback

`void rollback(Xid xid) throws XAException`

- Operation: It performs the XA rollback command for the global transaction xid.
- Exception: If the execution result error occurs, it throws XAException.

setTransactionTimeout

`boolean setTransactionTimeout(int seconds) throws XAException`

- Operation: GOLDDILOCKS does not support the transaction timeout. Any operation is not performed.
- Exception: It does not occur.

start

`void start(Xid xid, int flags) throws XAException`

- Operation: It starts the global transaction with the given flag. The flag may be one of TMNOFLAGS, TMJOIN, TMRESUME.
- Exception: If the execution result error occurs, it throws XAException.

GoldilocksInterval

To give value to a column of GOLDILOCKS by using a GoldilocksInterval object, refer to **Using Other Data Types**.

createIntervalYear

```
public static GoldilocksInterval createIntervalYear(int yearPrecision, boolean sign, int year)
throws SQLException
```

- Operation: It creates GoldilocksInterval object with the given year value. The yearPrecision refers to the number of digits which the year can have. The value of year should be equal to or bigger than 0. If the time is a positive number, sign is true. If it is a negative number, sign is false.
- Exception: If the given year value exceeds yearPrecision, an error occurs.

```
public static GoldilocksInterval createIntervalYear(int yearPrecision, String year) throws
SQLException
```

- Operation: It creates GoldilocksInterval object with the given year value. The yearPrecision refers to the number of digits which the year can have. The value of year should be an integer equal to or bigger than 0.
- Exception: If the given year value exceeds yearPrecision, an error occurs.

createIntervalMonth

```
public static GoldilocksInterval createIntervalMonth(int monthPrecision, boolean sign, int
month) throws SQLException
```

- Operation: It creates GoldilocksInterval object with the given month value. The monthPrecision refers to the number of digits which the month can have. The value of month should be an integer equal to or bigger than 0. If the time is a positive number, sign is true. If it is a negative number, sign is false.
- Exception: If the given month value exceeds monthPrecision, an error occurs.

```
public static GoldilocksInterval createIntervalMonth(int monthPrecision, String month) throws
SQLException
```

- Operation: It creates GoldilocksInterval object with the given month value. The monthPrecision refers to the number of digits which the month can have. The value of month should be an integer equal to or bigger than 0.
- Exception: If the given month value exceeds monthPrecision, an error occurs.

createIntervalYearToMonth

```
public static GoldilocksInterval createIntervalYearToMonth(int yearPrecision, boolean sign,
int year, int month) throws SQLException
```

- Operation: It creates GoldilocksInterval object with the given year, month value. The yearPrecision refers to the number of digits which the year can have. The value of year, month should be equal to or bigger than 0. If the time is a positive number, sign is true. If it is a negative number, sign is false.
- Exception: If the given year value exceeds yearPrecision, an error occurs.

```
public static GoldilocksInterval createIntervalYearToMonth(int yearPrecision, String
yearToMonth) throws SQLException
```

- Operation: It creates GoldilocksInterval object with the given yearToMonth value. The yearPrecision refers to the number of digits which the year can have. yearToMonth should satisfy "yy-mm" pattern.
- Exception: If the given year value exceeds yearPrecision, an error occurs.

createIntervalDay

```
public static GoldilocksInterval createIntervalDay(int dayPrecision, boolean sign, int day)
throws SQLException
```

- Operation: It creates GoldilocksInterval object with the given day value. The dayPrecision refers to the number of digits which the day can have. The value of day should be equal to or bigger than 0. If the time is a positive number, sign is true. If it is a negative number, sign is false.
- Exception: If the given day value exceeds dayPrecision, an error occurs.

```
public static GoldilocksInterval createIntervalDay(int dayPrecision, String day) throws
SQLException
```

- Operation: It creates GoldilocksInterval object with the given day value. The dayPrecision refers to the number of digits which the day can have. The value of day should be an integer equal to or bigger than 0.
- Exception: If the given day value exceeds dayPrecision, an error occurs.

createIntervalHour

```
public static GoldilocksInterval createIntervalHour(int hourPrecision, boolean sign, int hour)
throws SQLException
```

- Operation: It creates GoldilocksInterval object with the given hour value. The hourPrecision refers to the number of digits which the hour can have. The value of hour should be equal to or bigger than 0.

If the time is a positive number, sign is true. If it is a negative number, sign is false.

- Exception: If the given hour value exceeds hourPrecision, an error occurs.

```
public static GoldilocksInterval createIntervalHour(int hourPrecision, String hour) throws
SQLException
```

- Operation: It creates GoldilocksInterval object with the given hour value. The hourPrecision refers to the number of digits which the hour can have. The value of hour should be an integer equal to or bigger than 0.
- Exception: If the given hour value exceeds hourPrecision, an error occurs.

createIntervalMinute

```
public static GoldilocksInterval createIntervalMinute(int minutePrecision, boolean sign, int
minute) throws SQLException
```

- Operation: It creates GoldilocksInterval object with the given minute value. The minutePrecision refers to the number of digits which the minute can have. The value of minute should be equal to or bigger than 0. If the time is a positive number, sign is true. If it is a negative number, sign is false.
- Exception: If the given minute value exceeds minutePrecision, an error occurs.

```
public static GoldilocksInterval createIntervalMinute(int minutePrecision, String minute)
throws SQLException
```

- Operation: It creates GoldilocksInterval object with the given minute value. The minutePrecision refers to the number of digits which the minute can have. The value of minute should be an integer equal to or bigger than 0.
- Exception: If the given minute value exceeds minutePrecision, an error occurs.

createIntervalSecond

```
public static GoldilocksInterval createIntervalSecond(int secondPrecision, int
fractionalPrecision, boolean sign, int second, int microsecond) throws SQLException
```

- Operation: It creates GoldilocksInterval object with the given second value. The secondPrecision refers to the number of digits of second, and the fractionalPrecision refers to the number of digits of microsecond. The value of second and microsecond should be equal to or bigger than 0. If the time is a positive number, sign is true. If it is a negative number, sign is false.
- Exception: If the given second value exceeds secondPrecision or the given microSecond value exceeds fractionalPrecision, an error occurs.

```
public static GoldilocksInterval createIntervalSecond(int secondPrecision, int
fractionalPrecision, boolean sign, int day, int hour, int minute, int second, int microsecond)
throws SQLException
```

- Operation: It creates GoldilocksInterval object with the given day, hour, minute, second, microsecond value. The secondPrecision refers to the number of digits of second when day, hour, minute, second is converted to second. The fractionalPrecision refers to the number of digits of microsecond. The value of day, hour, minute, second, microsecond should be equal to or bigger than 0. If the time is a positive number, sign is true. If it is a negative number, sign is false.
- Exception: If the converted second value exceeds the secondPrecision or the microSecond value exceeds the fractionalPrecision, an error occurs.

```
public static GoldilocksInterval createIntervalSecond(int secondPrecision, int
fractionalPrecision, String second) throws SQLException
```

- Operation: It creates GoldilocksInterval object with the given second string. The secondPrecision refers to the number of digits of second. The fractionalPrecision refers to the number of digits of microsecond. The second string should be one of "dd hh:mm:ss.ffffff" or "dd hh:mm:ss", "dd hh:mm", "dd hh", "hh:mm", "ss.ffffff", "ss" patterns.
- Exception: If the converted second value exceeds the secondPrecision or the microSecond value exceeds the fractionalPrecision, an error occurs. If the string does not conform to the prescribed format, an error occurs.

createIntervalDayToHour

```
public static GoldilocksInterval createIntervalDayToHour(int dayPrecision, boolean sign, int
day, int hour) throws SQLException
```

- Operation: It creates GoldilocksInterval object with the given day, hour value. The dayPrecision refers to the number of digits of day. The value of day, hour should be equal to or bigger than 0. If the time is a positive number, sign is true. If it is a negative number, sign is false.
- Exception: If the day value exceeds dayPrecision, an error occurs.

```
public static GoldilocksInterval createIntervalDayToHour(int dayPrecision, String dayToHour)
throws SQLException
```

- Operation: It creates GoldilocksInterval object with the given dayToHour string. The dayPrecision refers to the number of digits of day. dayToHour should satisfy "dd hh" format. Or, if its format is "dd hh:mm:ss", all should be 0 except for dd, hh.
- Exception: If the day value exceeds dayPrecision or the given string does not satisfy the format, an error occurs.

createIntervalDayToMinute

```
public static GoldilocksInterval createIntervalDayToMinute(int dayPrecision, boolean sign, int day, int hour, int minute) throws SQLException
```

- Operation: It creates GoldilocksInterval object with the given day, hour, minute value. The dayPrecision refers to the number of digits of day. The value of day, hour, minute should be equal to or bigger than 0. If the time is a positive number, sign is true. If it is a negative number, sign is false.
- Exception: If the day value exceeds dayPrecision, an error occurs.

```
public static GoldilocksInterval createIntervalDayToMinute(int dayPrecision, String dayToMinute) throws SQLException
```

- Operation: It creates GoldilocksInterval object with the given dayToMinute string. The dayPrecision refers to the number of digits of day. dayToMinute should satisfy "dd hh:mm" format. Or, if its format is "dd hh:mm:ss", all should be 0 except for dd, hh, mm.
- Exception: If the day value exceeds dayPrecision or the given string does not satisfy the format, an error occurs.

createIntervalDayToSecond

```
public static GoldilocksInterval createIntervalDayToSecond(int dayPrecision, int fractionalPrecision, boolean sign, int day, int hour, int minute, int second, int microsecond) throws SQLException
```

- Operation: It creates GoldilocksInterval object with the given day, hour, minute, second, microsecond value. The dayPrecision refers to the number of digits of day. The fractionalPrecision refers to the number of digits of microsecond. The value of day, hour, minute, second, microsecond should be equal to or bigger than 0. If the time is a positive number, sign is true. If it is a negative number, sign is false.
- Exception: If the day value exceeds dayPrecision or the microsecond value exceeds the fractionalPrecision, an error occurs.

```
public static GoldilocksInterval createIntervalDayToSecond(int dayPrecision, String dayToSecond) throws SQLException
```

- Operation: It creates GoldilocksInterval object with the given dayToSecond string. The dayPrecision refers to the number of digits of day. The fractionalPrecision refers to the number of digits of microsecond. dayToSecond should satisfy one of "dd hh:mm:ss.ffffff", "dd hh:mm:ss", "hh:mm:ss", "hh:mm" formats.
- Exception: If the day value or the converted day value exceeds dayPrecision or the microsecond value exceeds the fractionalPrecision or the given string does not satisfy the format, an error occurs.

createIntervalHourToMinute

```
public static GoldilocksInterval createIntervalHourToMinute(int hourPrecision, boolean sign,
int hour, int minute) throws SQLException
```

- Operation: It creates GoldilocksInterval object with the given hour, minute value. The hourPrecision refers to the number of digits of hour. The value of hour, minute should be equal to or bigger than 0. If the time is a positive number, sign is true. If it is a negative number, sign is false.
- Exception: If the hour value exceeds hourPrecision, an error occurs.

```
public static GoldilocksInterval createIntervalHourToMinute(int hourPrecision, boolean sign,
int day, int hour, int minute) throws SQLException
```

- Operation: It creates GoldilocksInterval object with the given day, hour, minute value. The hourPrecision refers to the number of digits of hour. The value of day, hour, minute should be equal to or bigger than 0. If the time is a positive number, sign is true. If it is a negative number, sign is false.
- Exception: If the hour value or the converted hour value exceeds hourPrecision, an error occurs.

```
public static GoldilocksInterval createIntervalHourToMinute(int hourPrecision, String
hourToMinute) throws SQLException
```

- Operation: It creates GoldilocksInterval object with the given hourToMinute string. The hourPrecision refers to the number of digits of hour. hourToMinute must satisfy "hh:mm" format. The value of ss or fffffff should be 0 for other formats.
- Exception: If the hour value or the converted hour value exceeds hourPrecision, an error occurs. If the given string does not satisfy the format, an error occurs.

createIntervalHourToSecond

```
public static GoldilocksInterval createIntervalHourToSecond(int hourPrecision, int
fractionalPrecision, boolean sign, int hour, int minute, int second, int microsecond) throws
SQLException
```

- Operation: It creates GoldilocksInterval object with the given hour, minute, second, microsecond value. The hourPrecision refers to the number of digits of hour. The fractionalPrecision refers to the number of digits of microsecond. The value of hour, minute, second, microsecond should be equal to or bigger than 0. If the time is a positive number, sign is true. If it is a negative number, sign is false.
- Exception: If the hour value exceeds hourPrecision or the microsecond value exceeds the fractionalPrecision, an error occurs.

```
public static GoldilocksInterval createIntervalHourToSecond(int hourPrecision, int
fractionalPrecision, boolean sign, int day, int hour, int minute, int second, int microsecond)
throws SQLException
```

- Operation: It creates GoldilocksInterval object with the given day, hour, minute, second, microsecond value. The hourPrecision refers to the number of digits of hour. The fractionalPrecision refers to the number of digits of microsecond. The value of day, hour, minute, second, microsecond should be equal to or bigger than 0. If the time is a positive number, sign is true. If it is a negative number, sign is false.
- Exception: If the hour value or the converted hour value exceeds hourPrecision or the microsecond value exceeds the fractionalPrecision, an error occurs.

```
public static GoldilocksInterval createIntervalHourToSecond(int hourPrecision, int fractionalPrecision, String hourToSecond) throws SQLException
```

- Operation: It creates GoldilocksInterval object with the given hourToSecond string. The hourPrecision refers to the number of digits of hour. The fractionalPrecision refers to the number of digits of microsecond. hourToSecond should satisfy "hh:mm:ss.ffffff", "hh:mm:ss", or "hh:mm" format. If dd is included, the value of converted hour should not exceed hourPrecision.
- Exception: If the hour value or the converted hour value exceeds hourPrecision or the microsecond value exceeds the fractionalPrecision, or the given string does not satisfy the format, an error occurs.

createIntervalMinuteToSecond

```
public static GoldilocksInterval createIntervalMinuteToSecond(int minutePrecision, int fractionalPrecision, boolean sign, int minute, int second, int microsecond) throws SQLException
```

- Operation: It creates GoldilocksInterval object with the given minute, second, microsecond value. The minutePrecision refers to the number of digits of minute. The fractionalPrecision refers to the number of digits of microsecond. The value of minute, second, microsecond should be equal to or bigger than 0. If the time is a positive number, sign is true. If it is a negative number, sign is false.
- Exception: If the minute value exceeds the minutePrecision or the microsecond value exceeds the fractionalPrecision, an error occurs.

```
public static GoldilocksInterval createIntervalMinuteToSecond(int minutePrecision, int fractionalPrecision, boolean sign, int day, int hour, int minute, int second, int microsecond) throws SQLException
```

- Operation: It creates GoldilocksInterval object with the given day, hour, minute, second, microsecond value. The minutePrecision refers to the number of digits of minute. The fractionalPrecision refers to the number of digits of microsecond. The value of day, hour, minute, second, microsecond should be equal to or bigger than 0. If the time is a positive number, sign is true. If it is a negative number, sign is false.
- Exception: If the minute value or the converted minute value exceeds minutePrecision or the microsecond value exceeds the fractionalPrecision, an error occurs.

```
public static GoldilocksInterval createIntervalMinuteToSecond(int minutePrecision, int fractionalPrecision, String minuteToSecond) throws SQLException
```

- Operation: It creates GoldilocksInterval object with the given minuteToSecond string. The minutePrecision refers to the number of digits of minute. The fractionalPrecision refers to the number of digits of microsecond. minuteToSecond should satisfy "mm:ss.ffffff" or "mm:ss" format. If dd or hh is included, the value of the converted minute should not exceed minutePrecision.
- Exception: If the minute value or the converted minute value exceeds the minutePrecision or the microsecond value exceeds the fractionalPrecision or the given string does not satisfy the format, an error occurs.

getSign

```
public int getSign()
```

- Operation: If the time is a positive number, 1 is returned. If the time is a negative number, -1 is returned.
- Exception: It does not occur.

getYear

```
public int getYear()
```

- Operation: It returns the year value. Whether the interval object is a negative number is not returned through getYear().
- Exception: It does not occur.

getMonth

```
public int getMonth()
```

- Operation: It returns the month value. Whether the interval object is a negative number is not returned through getMonth().
- Exception: It does not occur.

getAccumulatedMonth

```
public int getAccumulatedMonth()
```

- Operation: It converts the value of year and month to the value of month, and returns the result.

- Exception: It does not occur.

getDay

```
public int getDay()
```

- Operation: It returns the day value. Whether the interval object is a negative number is not returned through `getDay()`.
- Exception: It does not occur.

getHour

```
public int getHour()
```

- Operation: It returns the hour value. Whether the interval object is a negative number is not returned through `getHour()`.
- Exception: It does not occur.

getAccumulatedHour

```
public int getAccumulatedHour()
```

- Operation: It converts the value of day and hour to the value of hour, and returns the result.
- Exception: It does not occur.

getMinute

```
public int getMinute()
```

- Operation: It returns the minute value. Whether the interval object is a negative number is not returned through `getMinute()`.
- Exception: It does not occur.

getAccumulatedMinute

```
public int getAccumulatedMinute()
```

- Operation: It converts the value of day, hour and minute to the value of minute, and returns the result.
- Exception: It does not occur.

getSecond

```
public int getSecond()
```

- Operation: It returns the second value. Whether the interval object is a negative number is not returned through `getSecond()`.
- Exception: It does not occur.

getAccumulatedSecond

```
public int getAccumulatedSecond()
```

- Operation: It converts the value of day, hour, minute and second to the value of second, and returns the result.
- Exception: It does not occur.

getMicroSecond

```
public int getMicroSecond()
```

- Operation: It returns the microsecond value. Whether the interval object is a negative number is not returned through `getMicroSecond()`.
- Exception: It does not occur.

getAccumulatedMicroSecond

```
public long getAccumulatedMicroSecond()
```

- Operation: It converts the value of day, hour, minute, second and microsecond to the value of microsecond, and returns the result.
- Exception: It does not occur.

getTypeName

```
public String getTypeName()
```

- Operation: The type name is returned.
- Exception: It does not occur.

getSqlType

```
public int getSqlType()
```

- Operation: The type of this object is returned as the type constant defined in GoldilocksTypes.
- Exception: It does not occur.

toString

```
public String toString()
```

- Operation: The interval value which is indicated by this object is returned as a string value.
- Exception: It does not occur.

GOLDILOCKS Type

Constant Definition

```
public static final int INTERVAL_YEAR;
public static final int INTERVAL_MONTH;
public static final int INTERVAL_DAY;
public static final int INTERVAL_HOUR;
public static final int INTERVAL_MINUTE;
public static final int INTERVAL_SECOND;
public static final int INTERVAL_YEAR_TO_MONTH;
public static final int INTERVAL_DAY_TO_HOUR;
public static final int INTERVAL_DAY_TO_MINUTE;
public static final int INTERVAL_DAY_TO_SECOND;
public static final int INTERVAL_HOUR_TO_MINUTE;
public static final int INTERVAL_HOUR_TO_SECOND;
public static final int INTERVAL_MINUTE_TO_SECOND;
public static final int TIME_WITH_TIME_ZONE;
public static final int TIMESTAMP_WITH_TIME_ZONE;
```

These constants are used like as the constants of `java.sql.Types`. In other words, they are used when specifying the types in `setObject` of `PreparedStatement` or the types in `getObject` of `ResultSet`. These types are separately provided by `GoldilocksTypes` because they are not defined in the JDBC standard.

Type Conversion

The following tables describe how to convert types.

Table 26-3 SQL types → GOLDILOCKS types

SQL type	GOLDILOCKS type
<code>Types.BIGINT</code>	<code>NATIVE_BIGINT</code>
<code>Types.BINARY</code>	<code>BINARY(2000)</code>
<code>Types.BIT</code>	<code>BOOLEAN</code>
<code>Types.BOOLEAN</code>	<code>BOOLEAN</code>
<code>Types.BLOB</code>	N/A
<code>Types.CHAR</code>	<code>CHAR(2000)</code>
<code>Types.CLOB</code>	N/A
<code>Types.DATE</code>	<code>DATE</code>

SQL type	GOLDILOCKS type
Types.DECIMAL	DECIMAL
Types.DOUBLE	NATIVE_DOUBLE
Types.FLOAT	FLOAT
Types.NUMERIC	NUMBER
Types.INTEGER	NATIVE_INTEGER
Types.LONGVARBINARY	LONG VARBINARY
Types.LONGVARCHAR	LONG VARCHAR
Types.REAL	NATIVE_REAL
Types.ROWID	ROWID
Types.SMALLINT	NATIVE_SMALLINT
Types.TIME	TIME
Types.TIMESTAMP	TIMESTAMP
Types.VARBINARY	VARBINARY(4000)
Types.VARCHAR	VARCHAR(4000)
GoldilocksTypes.INTERVAL_YEAR	INTERVAL YEAR
GoldilocksTypes.INTERVAL_MONTH	INTERVAL MONTH
GoldilocksTypes.INTERVAL_YEAR_TO_MONTH	INTERVAL YEAR TO MONTH
GoldilocksTypes.INTERVAL_DAY	INTERVAL DAY
GoldilocksTypes.INTERVAL_HOUR	INTERVAL HOUR
GoldilocksTypes.INTERVAL_MINUTE	INTERVAL MINUTE
GoldilocksTypes.INTERVAL_SECOND	INTERVAL SECOND
GoldilocksTypes.INTERVAL_DAY_TO_HOUR	INTERVAL DAY TO HOUR
GoldilocksTypes.INTERVAL_DAY_TO_MINUTE	INTERVAL DAY TO MINUTE
GoldilocksTypes.INTERVAL_DAY_TO_SECOND	INTERVAL DAY TO SECOND
GoldilocksTypes.INTERVAL_HOUR_TO_MINUTE	INTERVAL HOUR TO MINUTE
GoldilocksTypes.INTERVAL_HOUR_TO_SECOND	INTERVAL HOUR TO SECOND
GoldilocksTypes.INTERVAL_MINUTE_TO_SECOND	INTERVAL MINUTE TO SECOND
Types.OTHER	N/A
Types.ARRAY	N/A
Types.DATALINK	N/A
Types.DISTINCT	N/A
Types.NCHAR	N/A
Types.NCLOB	N/A
Types.NVARCHAR	N/A
Types.JAVA_OBJECT	N/A
Types.REF	N/A
Types.SQLXML	N/A
Types.STRUCT	N/A

Table 26-4 Whether supporting getter method for GOLDILOCKS type - 1

	NATIVE_SMALLINT	NATIVE_INTEGER	NATIVE_BIGINT	NATIVE_REAL	NATIVE_DOUBLE
getByte	O	O	O	O	O
getShort	O	O	O	O	O
getInt	O	O	O	O	O
getLong	O	O	O	O	O
getFloat	O	O	O	O	O
getDouble	O	O	O	O	O
getBigDecimal	O	O	O	O	O
getBoolean	Available only for 0,1	Available only for 0,1	Available only for 0,1	Available only for 0,1	Available only for 0,1
getString	O	O	O	O	O
getBytes	raw data	raw data	raw data	raw data	raw data
getDate	X	X	X	X	X
getTime	X	X	X	X	X
getTimestamp	X	X	X	X	X
getAsciiStream	raw data	raw data	raw data	raw data	raw data
getBinaryStream	raw data	raw data	raw data	raw data	raw data
getCharacterStream	X	X	X	X	X
getClob	X	X	X	X	X
getBlob	X	X	X	X	X
getArray	X	X	X	X	X
getRef	X	X	X	X	X
getURL	X	X	X	X	X
getObject	Short	Integer	Long	Float	Double
getRowId	X	X	X	X	X

Table 26-5 Whether supporting getter method for GOLDILOCKS Type - 2

	BOOLEAN	FLOAT/NUMBER	CHAR/VARCHAR/LONG VARCHAR	BINARY/VARBINARY/LONG VARBINARY	ROWID
getByte	0 or 1	O	Available only for numeric	X	X
getShort	0 or 1	O	Available only for numeric	X	X
getInt	0 or 1	O	Available only for numeric	X	X
getLong	0 or 1	O	Available only for numeric	X	X

	BOOLEAN	FLOAT/ NUMBER	CHAR/ VARCHAR/ LONG VARCHAR	BINARY/ VARBINARY/LON G VARBINARY	ROWID
getFloat	0 or 1	O	Available only for numeric	X	X
getDouble	0 or 1	O	Available only for numeric	X	X
getBigDecimal	0 or 1	O	Available only for numeric	X	X
getBoolean	O	Available only for 0,1	Available only for "t", "f", "true", "false", "y", "n", "yes", "no", "on", "off", "1", "0" (case-insensitive)	X	X
getString	"TRUE" or "FALSE"	O	O	O	O
getBytes	raw data	raw data	raw data	O	raw data
getDate	X	X	Available only for date format	X	X
getTime	X	X	Available only for time format	X	X
getTimestamp	X	X	Available only for timestamp format	X	X
getAsciiStream	raw data	raw data	raw data	O	raw data
getBinaryStream	raw data	raw data	raw data	O	raw data
getCharacterStream	X	X	O	X	X
getClob	X	X	X	X	X
getBlob	X	X	X	X	X
getArray	X	X	X	X	X
getRef	X	X	X	X	X
getURL	X	X	X	X	X
getObject	Boolean	BigDecimal	String	byte[]	RowId
getRowId	X	X	X	X	O

Table 26-6 Whether supporting getter method for GOLDILOCKS Type - 3

	DATE	TIME/ TIME WITH TIME ZONE	TIMESTAMP/ TIMESTAMP WITH TIME ZONE	INTERVAL
getBytes	X	X	X	Available only for a si

	DATE	TIME/ TIME WITH TIME ZONE	TIMESTAMP/ TIMESTAMP WITH TIME ZONE	INTERVAL
				single item type
getShort	X	X	X	Available only for a single item type
getInt	X	X	X	Available only for a single item type
getLong	X	X	X	Available only for a single item type
getFloat	X	X	X	Available only for a single item type
getDouble	X	X	X	Available only for a single item type
getBigDecimal	X	X	X	Available only for a single item type
getBoolean	X	X	X	X
getString	O	O	O	O
getBytes	raw data	raw data	raw data	raw data
getDate	O	O	O	X
getTime	O	O	O	X
getTimestamp	O	O	O	X
getAsciiStream	raw data	raw data	raw data	raw data
getBinaryStream	raw data	raw data	raw data	raw data
getCharacterStream	X	X	X	X
getClob	X	X	X	X
getBlob	X	X	X	X
getArray	X	X	X	X
getRef	X	X	X	X
getURL	X	X	X	X
getObject	Date	Time	Timestamp	GoldilocksInterval
getRowId	X	X	X	X

27.

Embedded SQL

27.1 Precompiler

Overview

GOLDILOCKS precompiler is a programming development tool which enables a user to use embedded SQL in the high-level programming language. Currently, GOLDILOCKS supports the precompiler only for the language such as C/ C++, and it is called as gpec.

Developing Embedded SQL Applications

As described in Figure 1 **Developing the embedded SQL applications**, the user creates a C source program including embedded SQL, and converts it via gpec precompiler. Then, the pure C code is created of which the embedded SQL on the source code is converted to the contents calling the library of GOLDILOCKS. This C code uses C compiler of the system to perform compile as object code and link it with libgoldilocksesql.a which is an embedded SQL library provided by GOLDILOCKS, then completes the final application.

Figure 1 Developing the embedded SQL applications

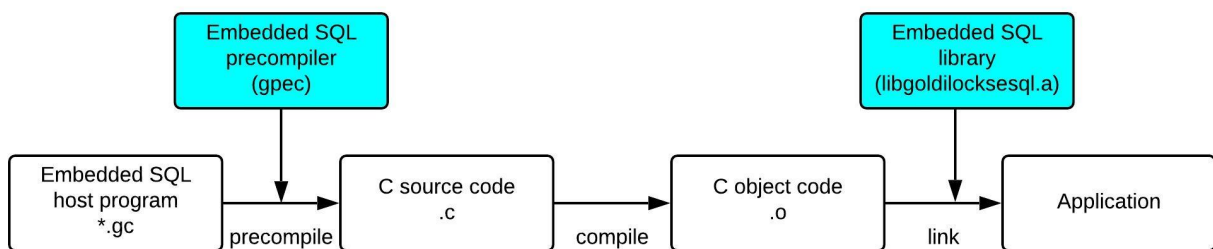

Configuring Embedded SQL Application Development Tool

Embedded SQL application of GOLDILOCKS consists of the following elements.

Directory or File	Description
\bin\gpec	GOLDILOCKS precompiler embedded SQL for C
\include\goldilocksesql.h	It is an embedded SQL library header file. Precompiler automatically inserts it, so the user does not have to do any extra work.
\include\sqlca.h	It is the SQLCA data structure related header file.
\lib\libgoldilocksesql.a, \lib\libgoldilocksesqls.so	It is the embedded SQL run-time library.
\lib\libgoldilocks.a, \lib\libgoldilockss.so	It is the GOLDILOCKS DA/ CS mixed mode library.

Directory or File	Description
\lib\libgoldilocks.a, \lib\libgoldilocksas.so	It is the GOLDILOCKS DA mode library.
\lib\libgoldilocksc.a, \lib\libgoldilockscs.so	It is the GOLDILOCKS CS mode library.
\sample\EmbeddedSQL	It is a sample program.

Building Application

This chapter describes the process to build an embedded SQL source program of GOLDILOCKS and make the application.

Precompile

Description

The user precompiles the C/ C++ source code which was written by using embedded SQL, and generates the pure C/ C++ source code. The core of this process is converting the user-created embedded SQL to the library call provided by GOLDILOCKS, and the C/ C++ source code is not modified except for embedded SQL.

Usage

The name of GOLDILOCKS precompiler is `gpec`, and it is located in `$GOLDILOCKS_HOME/bin/`. `gpec` is used as follows.

```
$ gpec [OPTION]... <input file>
```

<input file> is input to `gpec`, and `gpec` generates the C/ C++ source code after precompile process. The extension of <input file> is `*.gc`, and it can be omitted. If <input file> does not have `*.gc` extension, the file name with the extension should be required.

For more information about options given to `gpec`, refer to **Precompiler Options**.

Example

```
$ gpec sample1

FileName: sample1
Pre-compile sample1.gc -> sample1.c
```

Compile

C/ C++ source code is generated after precompile process. The source code generates the object code by using the C/ C++ compiler provided in the platform. For more information about this process refer to the C/ C++ compiler manual which is provided by the user platform.

Link

The application is generated by linking the object codes generated through the process above, and GOLD ILOCKS supports libgoldilocksesql.a for an embedded SQL. The library includes the GOLDILOCKS APIs which is converted from the embedded SQL by the precompiler, so it is prerequisite when making the embedded SQL application.

Additionally, the required library varies upon the various operation modes of GOLDILOCKS, and the required library is selected and linked according to the operation mode of the current application as follows.

Operation mode	Static library	Shared object
DA dedicated	libgoldilocks.a	libgoldilocksas.so
CS dedicated	libgoldilocksc.a	libgoldilockscs.so
DA/ CS mixed	libgoldilocks.a	libgoldilockss.so

Other link processes are as same as the process of generating the common C/ C++ application so refer to the linker manual provided by the user platform.

Example

make is used a lot to easily perform the precompile, compile, link process above. The following is an example of Makefile to create the sample program. Refer to the following example to make the Makefile which is suitable for the user environment.

```
CC = gcc
CFLAGS = -g -Wall

INC = -I$(GOLDILOCKS_HOME)/include
LFLAGS = -L$(GOLDILOCKS_HOME)/lib

LIB = -lgoldilocksesql -lpthread -lm -lrt
ifeq ($(CSMODE), 1)
    LIB += -lgoldilocksc
else
    ifeq ($(MIXMODE), 1)
```



```

        LIB += -lgoldilocks
    else
        LIB += -lgoldilocksa
    endif
endif

GPEC = gpec
GPECFLAGS =
#GPECFLAGS = --unsafe-null --no-prompt
BINS = overview sample1 sample2 sample3 sample4 sample5 dyn1 dyn2 number date_time thread1
fetch_struct_array

ifneq ($(MAKECMDGOALS), clean)
ifneq ($(MAKECMDGOALS), all)
TARGET = $(MAKECMDGOALS)
OBJECT = $(TARGET).o
C_SRC = $(TARGET).c
endif
endif

```

- Implicit rules

```

.SUFFIXES: .gc .c .o
.gc.c:
    $(GPEC) $(GPECFLAGS) $^          ❶ Precompile
.c.o:
    $(CC) $(CFLAGS) -c $(INC) $^    ❷ Compile

```

- Build rules

```

NoTarget :
    @echo "Syntax : make {all | sample_name | clean}"
    @echo "sample_name is one of '$(BINS)'"

all :
    for target in $(BINS); do \
        $(MAKE) $$target; \
    done

$(OBJECT) : $(C_SRC)
$(TARGET) : $(OBJECT)
    $(CC) -o $@ $^ $(LFLAGS) $(LIB)  ❸ Link

```

```
clean :
    rm -rf $(BINS) *.o *.c *~ core
```

Sample

GOLDILOCKS provides a simple embedded SQL sample code to help to create an embedded SQL application. The sample code is in \$GOLDILOCKS_HOME/sample/EmbeddedSQL directory, and sample.sql which is in the same directory should be executed first to execute the samples.

```
$ cd $GOLDILOCKS/sample/EmbeddedSQL
$ gsql test test -i sample.sql
$ make
Syntax : make {all | sample_name | clean}
sample_name is one of 'overview sample1 sample2 sample3 sample4 sample5 dyn1 dyn2 number
date_time thread1 fetch_struct_array'
```

If *make all* is executed, all samples are built. Execute *make <sample_name>* to build a particular sample alone. For <Sample_name>, refer to the message above. If sample2 is built and executed, and the result is as follows.

```
$ make sample2
gpec sample2.gc
FileName: sample2.gc
Pre-compile sample2.gc -> sample2.c
gcc -g -Wall -c -I/home/mycomman/work/product/Gliese/home/include sample2.c
gcc -o sample2 sample2.o -L/home/mycomman/work/product/Gliese/home/lib -lgoldilocksesql
-lpthread -lm -lrt -lgoldilocksa
$ ./sample2
Connect goldilocks ...
```

EMPNO	ENAME	JOB	SALARY
2854	Park	RND	800
2098	Kim	SALESMAN	1600
2175	Choi	SALESMAN	1250
2306	Lee	SUPPORT	2975
2122	Lyu	SALESMAN	1250
2999	Ohn	SUPPORT	2850
2012	Cheon	SUPPORT	2450
2168	Sohn	RND	3000
2836	Seo	CEO	5000

```

2022          Song  SALESMAN  1500
2232          Jeong      RND    1100
2676          Kang      RND     950
2714          Cho       RND   3000
2441          Yoon      RND   1300
=====
Record Count = 14
=====
SUCCESS
#####

```

Precompiler Options

This chapter describes the options of gpec.

--no-prompt, -n

Description

It does not output the version information.

Example

```

$ gpec --no-prompt sample2
FileName: sample2
Pre-compile sample2.gc -> sample2.c
$

```

--version, -v

Description

It outputs only the version information, then exits.

Example

```

$ gpec --version
$

```

--help, -h

Description

It outputs the help message. It performs the same operation even when an option or <input file> does not exist in gpec.

Example

```
$ gpec --help
gpec is the GOLDILOCKS embedded SQL precompiler for C programs.

Usage:
  gpec [OPTION]... <input file>

Options:
  --no-prompt      No Print version information
  --version        Print version information and exit
  --help           Print help message
  --output         Describe output filename
  --unsafe-null    Allow a NULL fetch without indicator variable
  --include-path   Describe header file path
  --no-lineinfo    Exclude line information
  --char_map       Mapping of character arrays ( CHARZ | STRING )
$
```

--output, -o

Description

It specifies the name of precompile result file. If this option is not given, the file name as same as <input file> is created with the extension of .c.

Example

- When an output is not used.

```
$ gpec sample2.gc
FileName: sample2.gc
Pre-compile sample2.gc -> sample2.c
$ ls
sample2.c  sample2.gc
```

- When an output is used.

```
$ gpec --output outfile.cpp sample2.gc
FileName: sample2.gc
Pre-compile sample2.gc -> outfile.cpp
$ ls
outfile.cpp sample2.gc
```

--unsafe-null

Description

Even if it does not use the host indicator variable, It succeeds when NULL fetch occurs. It means that the operation is successful, but it does not mean that the NULL value can be fetched.

Example

```
$ gpec --unsafe-null sample2
FileName: sample2
Option : --unsafe-null
Pre-compile sample2.gc -> sample2.c
$
```

--include-path, -I

Description

It describes the path of the header file to refer when performing the precompile. Other header files are found by using EXEC SQL INCLUDE statement when performing the precompile. First, it searches in the directory where the current file is located. If it can not find any file, then it searches in the directories where the option is described in turn.

Example

The following is an example of when the header file is in include directory.

- When an error occurs.

```
$ gpec sample.gc
FileName: sample.gc
Pre-compile sample.gc -> sample.c
ERR-42000(41000): syntax error
```

```
Error at line 12, in file sample.gc
ERR-42000(41004): "decl.h": file not exist
ERR-42000(41000): syntax error
rsEmpRecord gRecord[] = {
^
Error at line 15, in file sample.gc
```

- When -I option is used.

```
$ gpec -Iinclude sample.gc
FileName: sample.gc
Pre-compile sample.gc -> sample.c
$
```

--no-lineinfo

Description

When gc file is converted to c file by default, GPEC adds #line information to enable debugging with gc file. However, if this option is used, It does not add the line information through #line preprocessor when creating c file.

Example

```
$ gpec --no-lineinfo sample2
FileName: sample2
Pre-compile sample2.gc -> sample2.c
$
```

--char_map, -c

Description

It sets to which type the char type data declared in a DECLARE SECTION is mapped. The default value is 'STRING', and it is null-terminated data type. 'CHARZ' is space padded and null-terminated data type.

Example

```
$ gpec --char_map=STRING overview
FileName: overview
Pre-compile overview.gc -> overview.c
```

```
$ gpec --char_map=CHARZ overview
FileName: overview
Pre-compile overview.gc -> overview.c
```

--define, -D

Description

It is a define name used in gpec and it is set to 1.

Example

```
$ gpec --define=AAA preprocess
FileName: preprocess
Pre-compile preprocess.gc -> preprocess.c
$ gpec -D BBB preprocess
FileName: preprocess
Pre-compile preprocess.gc -> preprocess.c
ERR-42000(41028): 'BBB' macro is already defined at line 45, in file preprocess.gc
```

27.2 Embedded SQL

Preprocessing

Overview

It performs the preprocessing before precompiling in gpec.

gpec supports the preprocess statements such as `#if`, `#ifdef`, `#if defined`, `#ifndef`, `#else`, `#elif`, `#endif`, `#define`, `#undef`.

It can use a predefine by using a `--define` option of gpec. It is defined as 1 when it is predefined with a `gpec` option.

e.g. `gpec --define=_DEV_ Test.gc` is as same as `#define _DEV_ (1)` in `Test.gc` file.

Applicable Range

The host variable of SQL precompiler feature for gpec is applied only within a declare section and the feature is used in the EXEC SQL statement. (The host variable outside of the declare section can not be used in the host EXEC SQL statement.)

gpec preprocessor are applied all over the source.

Only the header file declared with EXEC SQL INCLUDE is applied to an include file.

```
#define _DEV1_
EXEC SQL BEGIN DECLARE SECTION;
#define _DEV2_
char username[10];
char password[10];
#ifdef _DEV1_
VARCHAR conn_str[20]; ①
#elif defined _DEV2_
VARCHAR conn_str[30]; ②
#endif
EXEC SQL END DECLARE SECTION;
```



- ① `_DEV1_` is defined irrespective of the position of DECLARE SECTION, so it is processed as a host variable in gpec.
- ② `_DEV1_` is defined, so its location becomes false, so is processed as a white space in gpec.

When creating c file from the file above using gpec, conn_str[20] is converted and #ifdef, #elif, #endif preprocessor statements and conn_str[30] are converted into white spaces as follows.

```

/* EXEC SQL BEGIN DECLARE SECTION; */
#define _DEV2_
char username[10];
char password[10];
/* VARCHAR conn_str[20]; */
struct { int len; char arr[20]; } conn_str; ❶

                                     ❷

/* EXEC SQL END DECLARE SECTION; */

```



❶ `_DEV1_` is defined irrespective of the position of `DECLARE SECTION`, so it is processed as a host variable in gpec.

❷ `_DEV1_` is defined, so its location becomes false, so is processed as a white space in gpec.

Types

#if

- Syntax

```
#if constant
```

or

```
#if defined identifier
```

or

```
#if !defined identifier
```

- Example

```

#if 0
int sVar1;
#endif
#if 3-2 ❶ An operation is available.
int sVar2;

```

```
#endif
#if defined _DEV_
int sVar3;
#endif
#if !defined (_DEV_)
int sVar4;
#endif
```

#ifdef, #ifndef

- Syntax

```
#ifdef identifier
```

or

```
#ifndef identifier
```

- Example

```
#ifdef _DEV_
int sVar1;
#endif
#ifndef _DEV_
int sVar2;
#else
int sVar3;
#endif
```

#else, #elif, #endif

- Syntax

```
#else
```

or

```
#endif
```

or

```
#elif constant
```

or

```
#elif defined identifier
```

- Example

```
#if 1
int sVar1;
#else
int sVar2;
#endif
#if 0
int sVar3;
#elif 1
int sVar4;
#else
int sVar5;
#endif
#ifdef _DEV1_
int sVar6;
#elif defined _DEV2_
int sVar7;
#elif !defined _DEV3_
int sVar8;
#endif
```

#define, #undef

- Syntax

```
#define identifier
```

or

```
#define identifier constant
```

or

```
#undef identifier
```

- Example

```
#define _DEV1_
EXEC SQL BEGIN DECLARE SECTION;
#define _DEV2_
char username[10];
char password[10];
#ifdef _DEV1_
VARCHAR conn_str[20]; ❶
#elif defined _DEV2_
VARCHAR conn_str[30]; ❷
#endif
#undef _DEV2_
#ifdef _DEV2_
VARCHAR sDept[10]; ❸
#endif
EXEC SQL END DECLARE SECTION;
```



- ❶ `_DEV1_` is defined, so it is processed as a host variable in gpec.
- ❷ `#ifdef _DEV1_` is true, so `_DEV2_` is processed as a white space in gpec.
- ❸ `_DEV2_` is undefined, so it is processed as a white space in gpec.



An annotation can be used in `#define`. However, if `#define` are written along multiple lines, the `n` the annotation can not be correctly processed.

```
#define _DEF1_ 1 \ ❶
+ 1
#define _DEF2_ 1 \ /* this ❷
is comment */ + 1
#define _DEF3_ 1 /* this is comment */ + 1 ❸
```



- ❶ `_DEF1_` is processed as `1 + 1`.
- ❷ `_DEF2_` is processed as `1`.
- ❸ `_DEF3_` is processed as `1 + 1`.

Constraints

Even though it is defined within a declare section, it is not extended to an EXEC SQL statement.

```
EXEC SQL BEGIN DECLARE SECTION;
#define C_EMP_NO 14
char username[10];
EXEC SQL END DECLARE SECTION;
EXEC SQL
    SELECT USERNAME INTO :username
    FROM EMP
    WHERE EMPNO = C_EMP_NO; ❶ A wrong MACRO is used.
```

Expansion

MACRO can be used in the middle of c statement or in the middle of EXEC SQL statement.

```
#define _DEV_
EXEC SQL BEGIN DECLARE SECTION;
char
#ifdef _DEV_
sTrue[10];
#else
sFalse[10];
#endif
EXEC SQL END DECLARE SECTION;
EXEC SQL SELECT
#ifdef _DEV_
    "true" INTO :sTrue
#else
    "false" INTO :sFalse
#endif
FROM DUAL;
```

gpec can execute the preprocessor to create the following c code. The following is an example in which the converting from SQL statement to c code is omitted.

```
#define _DEV_
EXEC SQL BEGIN DECLARE SECTION;
char
sTrue[10];
```

```
EXEC SQL END DECLARE SECTION;
EXEC SQL SELECT

        "true" INTO :sTrue

FROM DUAL;
```

Connection

Connecting to Database

A process of connecting to the database server is required to perform the operation by connecting to the database in the embedded SQL program.

The syntax for connecting to the database is expressed in GOLDILOCKS as follows.

```
EXEC SQL [ AT <db_name> ] CONNECT <user_name> IDENTIFIED BY <password> [ AT <db_name> ] [
USING <conn_string> ]
<db_name> := dbname | :hostvar
<user_name> := username | :hostvar
<password> := password | :hostvar
<conn_string> := connection_string | :hostvar
```

An example of the most basic way to connect to database is as follows.

```
EXEC SQL BEGIN DECLARE SECTION;
char username[10];
char password[10];
EXEC SQL END DECLARE SECTION;
strcpy( username, "test" );
strcpy( password, "test" );
...
EXEC SQL CONNECT :username IDENTIFIED BY :password;
```

GOLDILOCKS supports both D/A mode and C/S mode. The D/A mode is operated by attaching directly to the shared memory, and C/S mode is operated by connecting to the database by using TCP communicati

on. When operated in D/A mode, it is not necessary to include a separate server information as described above because the direct access from the same host of the database is performed. When operated in C/S mode, Data Source Name (DSN) should be specified to access. For more information about DSN, refer to **Data Source Configuration**.

connection_string information should be given to use DSN. USING clause is used to use connection_string information. An example of the connection statement whose DSN is "GOLDILOCKS", and using USING clause is as follows.

```
EXEC SQL BEGIN DECLARE SECTION;
char username[10];
char password[10];
char conn_str[20];
EXEC SQL END DECLARE SECTION;
strcpy( username, "test" );
strcpy( password, "test" );
strcpy( conn_str, "DSN=GOLDILOCKS" );
...
EXEC SQL CONNECT :username IDENTIFIED BY :password USING :conn_str;
```

When developing an application, sometimes it is required to uniquely identify the respective connection. It is the case of which each connection is performed in the multi-thread program in D/A mode. Or it is the case of which several connections are performed in C/S mode. The name is given to each connection by using AT clause.

AT clause may be positioned in front of CONNECT statement or USING clause. The example of AT clause in CONNECT statement is as follows.

```
EXEC SQL BEGIN DECLARE SECTION;
char username[10];
char password[10];
char conn_str[20];
char conn_name[10];
EXEC SQL END DECLARE SECTION;
strcpy( username, "test" );
strcpy( password, "test" );
strcpy( conn_str, "DSN=GOLDILOCKS" );
strcpy( conn_name, "DBCONN1" );
...
EXEC SQL CONNECT :username IDENTIFIED BY :password AT :conn_name USING :conn_str;
```

Disconnecting Database

It disconnects the connection to the database in the application. Like as the CONNECT statement, the disconnect is performed for the default connection or it is performed by giving a connection name. The syntax for disconnecting all connections performed in the application is also provided.

Single Disconnection

There are two ways of disconnecting a single connection, which are explicit and implicit method. The explicit method uses DISCONNECT statement as follows.

```
EXEC SQL [ AT <db_name> ] DISCONNECT;
```

The transaction is terminated via commit or rollback. The implicit disconnection is performed by adding RELEASE option after the transaction termination statement.

```
EXEC SQL [ AT <db_name> ] { COMMIT/ROLLBACK } [ WORK ] RELEASE;
```

All Disconnection

All connections of the current application are disconnected all together as follows.

```
EXEC SQL DISCONNECT ALL;
```

Transaction

Database application consists of transaction units. Therefore, an embedded SQL program should be able to manipulate the transaction. This chapter describes how to manipulate the transaction.

Start and End of Transaction

A transaction starts in the SQL which is performed first after it is connected. The transaction is maintained until the end command explicitly occurs. There are two end commands, which are COMMIT and ROLLBACK.

COMMIT

The transaction commit command causes the following actions.

- All data changes after the current transaction started are permanently reflected in the database.
- The reflected changes are visibly applied to all transactions which started after the changes or to the sensitive cursor.

- All savepoints which are created in the current transaction are deleted.
- All locks which are obtained in the current transaction are released.
- All cursors which are opened in the current transaction are closed. (The holdable cursor is excluded.)
- The transaction is terminated.

The commit command is used as follows.

```
EXEC SQL COMMIT [ WORK ];
```

ROLLBACK

The rollback command types are as follows.

- Transaction full rollback
- Transaction partial rollback
- Statement-level rollback

The transaction rollback command causes the following actions.

- All data changes after the current transaction started are undone and it returns to the state of before the transaction starts.
- All savepoints which are created in the current transaction are deleted.
- All locks which are obtained in the current transaction are released.
- All cursors which are opened in the current transaction are closed. (The holdable cursor is excluded.)
- The transaction is terminated.

The rollback command is used as follows.

```
EXEC SQL ROLLBACK [ WORK ];
```

Transaction partial rollback uses the savepoint. The application developer explicitly specifies the savepoint, and the transaction partial rollback is implemented by undoing all operations up to the savepoint. The transaction partial rollback command causes the following actions.

- All changes after the rollback savepoint are undone.
- All savepoints created after the rollback savepoint are deleted.
- All locks obtained after the rollback savepoint are released.

Transaction partial rollback command is used as follows.

```
EXEC SQL ROLLBACK TO SAVEPOINT <savepoint_name>;
```

Statement-level rollback undoes only the statement which is currently executed. For example, as if rows are inserted to a table and the unique violation occurs so the current statement can not be performed, the

n only the currently executed statement should be undone so that the next operation may continue.

In this case, there is not a command to be explicitly specified by the user because GOLDILOCKS internally undoes the statement.

Auto Commit

If the embedded SQL of GOLDILOCKS generally performs the connection, transaction is operated in non auto-commit mode.

However, it may be required to adjust the auto-commit mode for the convenience of application development or for the logical environment of the application. The embedded SQL precompiler of GOLDILOCKS may turn on or off the auto-commit mode with the following syntax.

```
EXEC SQL [ AT <db_name> ] ATUTOCOMMIT { ON | OFF };
```

RELEASE Option

The currently used connection may be turned off by using the RELEASE option when ending the transaction (commit/ rollback).

The option is allowed to be applied only for the transaction full commit rollback. It can not be used for the transaction partially rollback (ROLLBACK TO SAVEPOINT).

Host Variables and Datatypes

The embedded SQL application aims at manipulating the data and querying to obtain the desired results by interworking with the database server.

A method for the application data to be transferred to the database server, or vice versa, is required for this operation. The method to perform this role is defined as a host variable.

The application can use the host variables in the same way as C variables because the host variable is declared as a variable of C language. A host variable is treated as a part of the SQL statement and is responsible for the input/output of value between the database server and applications.

Declaring Host Variable

Host variable should be declared in the embedded SQL directive as follows.

```
EXEC SQL BEGIN DECLARE SECTION;
```

- Declaring a host variable

```
EXEC SQL END DECLARE SECTION;
```

The section above is called as a declare section, and host variables can be declared within the declare section in the same way as C variables. The following is an example of declaring a part of host variables.

```
EXEC SQL BEGIN DECLARE SECTION;
    int    empno;
    char   ename[20];
    double salary;
EXEC SQL END DECLARE SECTION;
```

C Data Type for Host Variable

There are two types of C data used as the host variables, and which are a native type provided by the C language and a data type additionally provided by GOLDILOCKS. The following table describes the data types provided by the embedded SQL of GOLDILOCKS.

C Native Datatype

C native datatype is the default data type provided by the C language, and its range and size are entirely dependent on the application development platform.

Table 27-1 C native datatype

C datatype	Description
char	It is a single character.
char[n]	It is a string with maximum length n.
short	It is a small integer (2 bytes).
int	It is an integer (4 bytes).
long	It is a large integer (4/8 bytes).
long long	It is a very large integer (8 bytes).
float	It is a single precision floating-point number.
double	It is a double precision floating-point number.

- char

char type represents a single character.

- char[n]

char[n] represents a string with maximum length n.

The following is an example.

```
EXEC SQL BEGIN DECLARE SECTION;  
char strName[20];  
EXEC SQL BEGIN DECLARE SECTION;
```

If it is declared as above, strName represents to the string data with the maximum length 20.

If strName is used as an output of ESQL, then it is space padded.



The maximum length of a char[] can not exceed 2001.

- short

It represents 2 bytes integer datatype.

- int

It represents 4 bytes integer datatype.

- long

Long type means a large integer, but the range of the actual value is determined in accordance with the platform. Long is 8 bytes integer in 64 bits Unix/Linux platform, but it is 4 bytes integer in 32 bits Unix/Linux platform.

- long long

It means very large integer, and it represents the 8 bytes integer.

- float

It is the float type of C language, and it represents the 4 bytes single-precision floating-point number.

- double

It is the double type of C language, and it represents the double-precision floating-point number.

Pseudo Datatype

Pseudo type supports the various forms of GOLDILOCKS type, and it is the type provided by GOLDILOCKS embedded SQL precompiler for the convenience of development. Most of its contents are implemented by using the structure of C.

Table 27-2 GOLDILOCKS embedded SQL pseudo type

Pseudo type	Description
VARCHAR[n]	It is a variable-length string with the maximum length n.
LONG VARCHAR[n]	It is a variable-length string with the maximum length 100M (104857600).
BINARY[n]	It is a binary data with the maximum length n.
VARBINARY[n]	It is a variable-length binary data with the maximum length n.
LONG VARBINARY[n]	It is a variable-length binary data with the maximum length 100M (104857600).
NUMBER	It is an integer whose number of significant digits is 38.
NUMBER(p)	It is an integer whose number of significant digits is p.
NUMBER(p, s)	It is a real number whose number of significant digits is p and whose scale is s.
BOOLEAN	It is a boolean type.
DATE	It is a date type data.
TIME	It is a time type data.
TIME WITH TIMEZONE	It is a time type data with timezone.
TIMESTAMP	It is a datetime type data.
TIMESTAMP WITH TIMEZONE	It is a time type data with timezone.
INTERVAL YEAR	It is an interval data type.
INTERVAL MONTH	
INTERVAL DAY	
INTERVAL HOUR	
INTERVAL MINUTE	
INTERVAL SECOND	
INTERVAL YEAR TO MONTH	
INTERVAL DAY TO HOUR	
INTERVAL DAY TO MINUTE	
INTERVAL DAY TO SECOND	
INTERVAL HOUR TO MINUTE	
INTERVAL HOUR TO SECOND	
INTERVAL MINUTE TO SECOND	

VARCHAR

VARCHAR type is the datatype in which the variable length string can be stored, and it consists of the following structure.

```
struct {
    int len;
    char arr[n];
}
```

n refers to the maximum length of VARCHAR type.

```
EXEC SQL BEGIN DECLARE SECTION;
    VARCHAR varstr[100];
EXEC SQL END DECLARE SECTION;
```

For example, if it is declared as above, it is converted via precompile process as follows.

```
struct VARCHAR_varstr {
    int len;
    char arr[100];
} varstr;
```

The application can use VARCHAR type as follows.

```
strcpy( varstr.arr, "abcde" );
varstr.len = strlen( varstr.arr );

EXEC SQL INSERT INTO TEST_T1 VALUES ( :varstr );
```



The length of VARCHAR can not exceed 4000.

LONG VARCHAR

LONG VARCHAR type is the datatype in which a long variable-length strings can be stored, and it consists of the following structure.

```
typedef struct SQL_LONG_VARIABLE_LENGTH_STRUCT
{
    SQLBIGINT len;
    SQLCHAR * arr;
} SQL_LONG_VARIABLE_LENGTH_STRUCT;
```

LONG VARCHAR type can be declared as follows.

```
EXEC SQL BEGIN DECLARE SECTION;
    LONGVARCHAR long_text[1048576];
EXEC SQL END DECLARE SECTION;
```

LONG VARCHAR is different from VARCHAR. LONG VARCHAR can have the length up to 100M (104857600), so it does not pre-allocate the space for the string when declaring. After declaring LONG VARCHAR, the memory space should be allocated in long_text.arr before actual use, and the application should release the allocated memory space. An example of using LONG VARCHAR is as follows.

```

long_text.arr = malloc( 1048576 );

gets( long_text.arr );
long_text.len = strlen( long_text.arr );

EXEC SQL INSERT INTO TEST_T1 VALUES ( :long_text );
...
free( long_text.arr );

```



LONG VARCHAR type can be declared by specifying the current length up to 100M (10485760).

BINARY

BINARY type is the datatype to literally handle the non-formal raw data, and it consists of the following structure. The example of declaring BINARY type is as follows.

```

EXEC SQL BEGIN DECLARE SECTION;
    VARCHAR binary[100];
EXEC SQL END DECLARE SECTION;

```

If it is declared as above, it is converted via precompile process as follows.

```
char binary[100];
```

Its form is as same as the character string storage form. char[n] is defined to store the string of database, but BINARY type is for storing the binary data. Therefore, the applications can use BINARY type in the same way as dealing with the character string data.



The maximum length of BINARY can not exceed 2000.

VARBINARY

VARBINARY type is the datatype in which the variable length binary data can be stored, and it consists of the following structure.

```

struct {
    int len;
    char arr[n];
}

```

n refers to the maximum length of VARCHAR type.

```
EXEC SQL BEGIN DECLARE SECTION;
    VARCHAR varbin[100];
EXEC SQL END DECLARE SECTION;
```

For example, if it is declared as above, it is converted via precompile process as follows.

```
struct VARBINARY_varbin {
    int len;
    char arr[100];
} varbin;
```

The forms of VARBINARY type and VARCHAR type are same. VARCHAR is for storing the string data, but VARBINARY is for storing the binary data. VARCHAR and VARBINARY are same in all other aspects except for the aspect above. Therefore, the application can use both VARCHAR and VARBINARY types as follows.

```
memcpy( varbin.arr, binary_data, 50 );
varbin.len = 50;

EXEC SQL INSERT INTO TEST_T1 VALUES ( :varbin );
```



The length of VARBINARY can not exceed 4000.

LONG VARBINARY

LONG VARBINARY type is the datatype in which the long variable length binary data can be stored, and it consists of the following structure.

```
typedef struct SQL_LONG_VARIABLE_LENGTH_STRUCT
{
    SQLBIGINT len;
    SQLCHAR * arr;
} SQL_LONG_VARIABLE_LENGTH_STRUCT;
```

LONG VARBINARY type can be declared as follows.

```
EXEC SQL BEGIN DECLARE SECTION;
    LONGVARBINARY long_bin[1048576];
EXEC SQL END DECLARE SECTION;
```

The difference between LONG VARBINARY and VARBINARY is that the space is not pre-allocated to store binary data when declaring LONG VARBINARY type. (It is as same as the difference between LONG VARCHAR and VARCHAR). After declaring LONG VARBINARY, the memory space should be allocated in long_bin.arr before actual use, and the application should release the allocated memory space after use. An example of using LONG VARBINARY is as follows.

```
long_bin.arr = malloc( 1048576 );

memcpy( long_bin.arr, long_binary_data, 1048576);
long_bin.len = 1048576;

EXEC SQL INSERT INTO TEST_T1 VALUES ( :long_bin );
...
free( long_bin.arr );
```



LONG VARBINARY type can be declared by specifying the current length up to 100M(104857600).

NUMBER

NUMBER type is the datatype which provides an SQL_NUMERIC_STRUCT defined in ODBC to make it to be used in the application.

```
#define SQL_MAX_NUMERIC_LEN 16
typedef struct tagSQL_NUMERIC_STRUCT
{
    SQLCHAR precision;
    SQLSCHAR scale;
    SQLCHAR sign; /* 1=pos 0=neg */
    SQLCHAR val[SQL_MAX_NUMERIC_LEN];
} SQL_NUMERIC_STRUCT;
```

NUMBER type is configured to express the real number type data with precision and scale. When declaring NUMBER type, precision and scale can also be declared. Scale and precision can be omitted as follows in some cases.

Table 27-3 Scale and precision of number types

Declaring NUMBER type	Description
NUMBER	It is as same as NUMBER(38, 0).
NUMBER(p)	It is as same as NUMBER(p, 0)
NUMBER(p, s)	It is a real number type data with precision p, scale s.

```
EXEC SQL BEGIN DECLARE SECTION;
    NUMBER          number_default;
    NUMBER(20)      number_20;
    NUMBER(30,10)   number_30_10;
EXEC SQL END DECLARE SECTION;
```

For example, if the variable is declared as above, number_default variable is as same as the declaration of NUMBER(38, 0), and number_20 variable is as same as the declaration of NUMBER(20, 0). NUMBER type uses SQL_NUMERIC_STRUCT which is a ODBC type. The following is a sample of using NUMBER type.

```
/*
 * number.gc
 *
 */
#include <stdio.h>
#include <stdlib.h>
#include <string.h>
EXEC SQL INCLUDE SQLCA;
#define SUCCESS 0
#define FAILURE -1
#define PRINT_SQL_ERROR(aMsg) \
    { \
        printf("\n"); \
        printf(aMsg); \
        printf("\nSQLCODE : %d\nSQLSTATE : %s\nERROR MSG : %s\n", \
            sqlca.sqlcode, \
            SQLSTATE, \
            sqlca.sqlerrm.sqlerrmc ); \
    }

int Connect(char *aHostInfo, char *aUserID, char *sPassword);
int CreateTable();
int DropTable();

unsigned long long ConvertMantisaToDecimal(SQLCHAR *aNumStrValue)
{
    unsigned long long sResult = 0;
    unsigned long long sLast=1;
    unsigned int sCurrent;
    unsigned int sLSD = 0;
    unsigned int sMSD = 0;
```

```

int      i      = 1;
for(i = 0; i < SQL_MAX_NUMERIC_LEN; i ++)
{
    sCurrent = (unsigned char) aNumStrValue[i];
    sLSD = sCurrent % 16; //Obtain LSD
    sMSD = sCurrent / 16; //Obtain MSD
    sResult += sLast * sLSD;
    sLast = sLast * 16;
    sResult += sLast * sMSD;
    sLast = sLast * 16;
}
return sResult;
}

void PrintNumber(SQL_NUMERIC_STRUCT *aNumber)
{
    unsigned long long  sDigit;
    unsigned long long  sFraction;
    unsigned long long  sMantisa;
    unsigned long long  sFactor;
    int      i;
    sMantisa = ConvertMantisaToDecimal( aNumber->val );
    sFactor = 1;
    for( i = 0; i < aNumber->scale; i ++ )
    {
        sFactor *= 10;
    }
    sDigit = sMantisa / sFactor;
    sFraction = sMantisa % sFactor;
    if( sFraction != 0 )
    {
        printf("%llu.%-3llu", sDigit, sFraction);
    }
    else
    {
        printf("%llu", sDigit);
    }
}

int main(int      argc,
          char    **argv)

```

```

{
EXEC SQL BEGIN DECLARE SECTION;
NUMBER          sNumber;
NUMBER(10,5)    sResultNumber1;
NUMBER(10,5)    sResultNumber2;
char            sCharNumber[20];
int             sNo;
int             sResultNo;
EXEC SQL END DECLARE SECTION;

int i;
int sState = 0;
printf("#### Number Datatype Test ####\n");
printf("Connect GOLDILOCKS ...\n");
if(Connect("DSN=GOLDILOCKS", "test", "test") != SUCCESS)
{
    goto fail_exit;
}
printf("Create table ...\n");
if(CreateTable() != SUCCESS)
{
    goto fail_exit;
}
sState = 1;
printf("Insert record ...\n");
for(i = 0; i < 20; i ++)
{
    sNo = i + 1;
    memset( &sNumber, 0x00, sizeof(SQL_NUMERIC_STRUCT) );
    sNumber.precision = 38;
    sNumber.scale = 3;
    sNumber.sign = 1;
    /*
    * 0x627d = 25213
    */
    sNumber.val[0] = 0x7d + i;
    sNumber.val[1] = 0x62;
    snprintf( sCharNumber, 20, "25.2%02d", 13 + i );
EXEC SQL
    INSERT INTO TEST_T1(C1, C2, C3)
    VALUES(:sNo, :sNumber, :sCharNumber);
    if(sqlca.sqlcode != 0)

```

```

        {
            goto fail_exit;
        }
    }
EXEC SQL COMMIT WORK;
if(sqlca.sqlcode != 0)
{
    goto fail_exit;
}
printf("Retrive record\n");
EXEC SQL
    DECLARE CUR1 CURSOR FOR
    SELECT C1, C2, C3
    FROM TEST_T1;
EXEC SQL OPEN CUR1;
if(sqlca.sqlcode != 0)
{
    goto fail_exit;
}
printf(" NO   Number1  Number2\n");
printf("==== =====\n");
memset( &sResultNumber1, 0x00, sizeof(SQL_NUMERIC_STRUCT) );
memset( &sResultNumber2, 0x00, sizeof(SQL_NUMERIC_STRUCT) );
while( 1 )
{
    EXEC SQL
        FETCH FROM CUR1
        INTO :sResultNo, :sResultNumber1, :sResultNumber2;
    if(sqlca.sqlcode == SQL_NO_DATA)
    {
        /*
         * No more data
         */
        break;
    }
    if(sqlca.sqlcode != 0)
    {
        goto fail_exit;
    }
    printf("%3d  ", sResultNo);
    PrintNumber( &sResultNumber1 );
}

```

```

        printf("  ");
        PrintNumber( &sResultNumber2 );
        printf("\n");
    }
    printf("==== ===== \n");
    EXEC SQL CLOSE CUR1;
    if(sqlca.sqlcode != 0)
    {
        goto fail_exit;
    }
    EXEC SQL COMMIT WORK;
    if(sqlca.sqlcode != 0)
    {
        goto fail_exit;
    }
    sState = 0;
    printf("Drop table ... \n");
    if(DropTable() != SUCCESS)
    {
        goto fail_exit;
    }
    printf("Disconnect GOLDILOCKS ... \n");
    EXEC SQL COMMIT WORK RELEASE;
    printf("SUCCESS \n");
    printf("##### \n");
    return 0;
fail_exit:
    PRINT_SQL_ERROR("[ERROR] SQL ERROR -");
    printf("FAILURE \n");
    printf("##### \n \n");
    switch(sState)
    {
        case 1:
            printf("Drop table ... \n");
            (void)DropTable();
        default:
            break;
    }
    EXEC SQL ROLLBACK WORK RELEASE;
    return 0;
}

```

```
int CreateTable()
{
    EXEC SQL DROP TABLE IF EXISTS TEST_T1;
    if(sqlca.sqlcode != 0)
    {
        goto fail_exit;
    }
}
```

- Create table

```
EXEC SQL CREATE TABLE TEST_T1 ( C1 INTEGER,
                                C2 NUMERIC(38,4),
                                C3 VARCHAR(20) );

    if(sqlca.sqlcode != 0)
    {
        goto fail_exit;
    }
    EXEC SQL COMMIT WORK;
    if(sqlca.sqlcode != 0)
    {
        goto fail_exit;
    }
    return SUCCESS;
fail_exit:
    PRINT_SQL_ERROR("[ERROR] SQL ERROR -");
    EXEC SQL ROLLBACK WORK;
    return FAILURE;
}
```

- Drop table

```
int DropTable()
{
    EXEC SQL DROP TABLE TEST_T1;
    if(sqlca.sqlcode != 0)
    {
        goto fail_exit;
    }
    EXEC SQL COMMIT WORK;
    if(sqlca.sqlcode != 0)
    {
```

```

        goto fail_exit;
    }
    return SUCCESS;
fail_exit:
    PRINT_SQL_ERROR("[ERROR] SQL ERROR -");
    EXEC SQL ROLLBACK WORK;
    return FAILURE;
}

int Connect(char *aHostInfo, char *aUserID, char *sPassword)
{
    EXEC SQL BEGIN DECLARE SECTION;
    VARCHAR sUid[80];
    VARCHAR sPwd[20];
    VARCHAR sConnStr[1024];
    EXEC SQL END DECLARE SECTION;

```

- Log on GOLDILOCKS

```

strcpy((char *)sUid.arr, aUserID);
sUid.len = (short)strlen((char *)sUid.arr);
strcpy((char *)sPwd.arr, sPassword);
sPwd.len = (short)strlen((char *)sPwd.arr);
strcpy((char *)sConnStr.arr, aHostInfo);
sConnStr.len = (short)strlen((char *)sConnStr.arr);

```

- DB connection

```

EXEC SQL CONNECT :sUid IDENTIFIED BY :sPwd USING :sConnStr;
    if(sqlca.sqlcode != 0)
    {
        goto fail_exit;
    }
    return SUCCESS;
fail_exit:
    PRINT_SQL_ERROR("[ERROR] Connection Failure!");
    return FAILURE;
}

```

BOOLEAN

BOOLEAN type has the value of TRUE or FALSE. Actually, the variable is used as the variable of C language, so if the variable is 1, it refers to TRUE. If the variable is 0, it refers to FALSE.

The following is an example of using a simple BOOLEAN type variable.

```
EXEC SQL BEGIN DECLARE SECTION;
    BOOLEAN boolean;
EXEC SQL END DECLARE SECTION;

EXEC SQL SELECT IsEnable INTO :boolean FROM STATUS WHERE ID = 100;

if( boolean != 0 )
{
    print( "Enable Status : TRUE\n" );
}
else
{
    print( "Enable Status : FALSE\n" );
}
```

DATE

Date type can deal with dates and times. Date type has SQL_TIMESTAMP_STRUCT structure of ODBC.

```
typedef struct tagTIMESTAMP_STRUCT
{
    SQLSMALLINT    year;
    SQLUSMALLINT   month;
    SQLUSMALLINT   day;
    SQLUSMALLINT   hour;
    SQLUSMALLINT   minute;
    SQLUSMALLINT   second;
    SQLINTEGER      fraction;
} TIMESTAMP_STRUCT;

typedef TIMESTAMP_STRUCT SQL_TIMESTAMP_STRUCT;
```

If the variable of DATE type is declared, the precompiler converts it to the structure above, and the meaning of each field as same as SQL_TIMESTAMP_STRUCT of ODBC.

TIME

TIME type is the datatype which deals with time, and it has SQL_TIME_STRUCT structure of ODBC.

```
typedef struct tagTIME_STRUCT
{
    SQLUSMALLINT  hour;
    SQLUSMALLINT  minute;
    SQLUSMALLINT  second;
} TIME_STRUCT;
typedef TIME_STRUCT SQL_TIME_STRUCT;
```

If the variable of TIME type is declared, the precompiler converts it to the structure above, and the meaning of each field is as same as SQL_TIME_STRUCT of ODBC.

TIME WITH TIMEZONE

TIME WITH TIMEZONE type is the datatype which deals with the time with timezone, and it has the structure as follows.

```
typedef struct tagTIME_WITH_TIMEZONE_STRUCT
{
    SQLUSMALLINT  hour;
    SQLUSMALLINT  minute;
    SQLUSMALLINT  second;
    SQLINTEGER    fraction;
    SQLSMALLINT   timezone_hour;
    SQLSMALLINT   timezone_minute;
} TIME_WITH_TIMEZONE_STRUCT;
typedef TIME_WITH_TIMEZONE_STRUCT SQL_TIME_WITH_TIMEZONE_STRUCT;
```

If the variable of TIME WITH TIMEZONE type is declared, precompiler converts it to the structure above, and the meaning of each field is as follows.

Table 27-4 Fields of TIME WITH TIMEZONE

Field name	Description
hour	hour
minute	minute
second	second
fraction	the seconds below the decimal point
timezone_hour	hour of timezone
timezone_minute	minute of timezone

TIMESTAMP

TIMESTAMP type is the datatype which deals with date ~ time, and it has SQL_TIMESTAMP_STRUCT structure of ODBC.

```
typedef struct tagTIMESTAMP_STRUCT
{
    SQLSMALLINT    year;
    SQLUSMALLINT   month;
    SQLUSMALLINT   day;
    SQLUSMALLINT   hour;
    SQLUSMALLINT   minute;
    SQLUSMALLINT   second;
    SQLINTEGER      fraction;
} TIMESTAMP_STRUCT;
typedef TIMESTAMP_STRUCT SQL_TIMESTAMP_STRUCT;
```

If the variable of TIMESTAMP type is declared, precompiler converts it to the structure above, and the meaning of each field is same as SQL_TIMESTAMP_STRUCT structure of ODBC.

TIMESTAMP WITH TIMEZONE

TIMESTAMP WITH TIMEZONE type is the datatype which deals with timestamp with timezone, and it has the following structure.

```
typedef struct tagTIMESTAMP_WITH_TIMEZONE_STRUCT
{
    SQLSMALLINT    year;
    SQLUSMALLINT   month;
    SQLUSMALLINT   day;
    SQLUSMALLINT   hour;
    SQLUSMALLINT   minute;
    SQLUSMALLINT   second;
    SQLINTEGER      fraction;
    SQLSMALLINT    timezone_hour;
    SQLSMALLINT    timezone_minute;
} TIMESTAMP_WITH_TIMEZONE_STRUCT;
typedef TIMESTAMP_WITH_TIMEZONE_STRUCT SQL_TIMESTAMP_WITH_TIMEZONE_STRUCT;
```

If the variable of TIMESTAMP WITH TIMEZONE type is declared, precompiler converts it to the structure above, and the meaning of each field is as follows.

Table 27-5 Fields of TIMESTAMP WITH TIMEZONE

Field name	Description
year	year
month	month
day	day
hour	hour
minute	minute
second	second
fraction	the seconds below the decimal point
timezone_hour	hour of timezone
timezone_minute	minute of timezone

The following is an example of dealing with DATE, TIME, TIMESTAMP, TIME WITH TIMEZONE, TIMESTAMP WITH TIMEZONE types.

```

/*
 * date_time.gc
 *
 */
#include <stdio.h>
#include <stdlib.h>
#include <string.h>

EXEC SQL INCLUDE SQLCA;

#define SUCCESS 0
#define FAILURE -1

#define PRINT_SQL_ERROR(aMsg) \
{ \
    printf("\n"); \
    printf(aMsg); \
    printf("\nSQLCODE : %d\nSQLSTATE : %s\nERROR MSG : %s\n", \
        sqlca.sqlcode, \
        SQLSTATE, \
        sqlca.sqlerrm.sqlerrmc ); \
}

int Connect(char *aHostInfo, char *aUserID, char *sPassword);
int CreateTable();
int DropTable();

```

```
int main(int    argc,
         char  **argv)
{
    EXEC SQL BEGIN DECLARE SECTION;
    int          sNo;
    int          sResultNo;
    DATE        sDate, sResultDate;
    TIME        sTime, sResultTime;
    TIME WITH TIMEZONE    sTimeTz, sResultTimeTz;
    TIMESTAMP   sTimestamp, sResultTimestamp;
    TIMESTAMP WITH TIMEZONE sTimestampTz, sResultTimestampTz;
    EXEC SQL END DECLARE SECTION;
    int  sState = 0;

    printf("#### Datatype Insert Test ####\n");
    printf("Connect GOLDILOCKS ...\n");
    if(Connect("DSN=GOLDILOCKS", "test", "test") != SUCCESS)
    {
        goto fail_exit;
    }
    sState = 1;
    printf("Create table ...\n");
    if(CreateTable() != SUCCESS)
    {
        goto fail_exit;
    }
    sState = 2;
    printf("Insert record ...\n");

    sNo = 1;
    /**
     * Date : 2014-7-14 21:29:30
     */
    sDate.year   = 2014;
    sDate.month  = 7;
    sDate.day    = 14;
    sDate.hour   = 21;
    sDate.minute = 29;
    sDate.second = 30;
    sDate.fraction = 0;
```

```
/**
 * Time : 17:46:35
 */
sTime.hour   = 17;
sTime.minute = 46;
sTime.second = 35;

/**
 * Time With Timezone : 17:46:35.6789(+9:00)
 */
sTimeTz.hour           = 17;
sTimeTz.minute         = 46;
sTimeTz.second         = 35;
sTimeTz.fraction       = 678900000;
sTimeTz.timezone_hour  = 9;
sTimeTz.timezone_minute = 0;

/**
 * Timestamp : 2014-02-13 17:46:28.123
 */
sTimestamp.year      = 2014;
sTimestamp.month     = 2;
sTimestamp.day       = 13;
sTimestamp.hour      = 17;
sTimestamp.minute    = 46;
sTimestamp.second    = 28;
sTimestamp.fraction  = 123000000;

/**
 * Time With Timezone : 2014-05-18 17:46:35.001(+9:00)
 */
sTimestampTz.year    = 2014;
sTimestampTz.month   = 5;
sTimestampTz.day     = 18;
sTimestampTz.hour    = 17;
sTimestampTz.minute  = 46;
sTimestampTz.second  = 35;
sTimestampTz.fraction = 1000000;
sTimestampTz.timezone_hour = 9;
sTimestampTz.timezone_minute = 0;
```

```

/**
 * Insert record
 */
EXEC SQL
    INSERT INTO TEST_T1(C1, C2, C3, C4, C5, C6)
    VALUES(:sNo, :sDate, :sTime, :sTimeTz, :sTimestamp, :sTimestampTz);
if(sqlca.sqlcode != 0)
{
    goto fail_exit;
}

EXEC SQL COMMIT WORK;
if(sqlca.sqlcode != 0)
{
    goto fail_exit;
}

printf("Retrive record\n");
EXEC SQL
    SELECT C1, C2, C3, C4, C5, C6
    INTO   :sResultNo, :sResultDate, :sResultTime, :sResultTimeTz, :sResultTimestamp,
:sResultTimestampTz
    FROM   TEST_T1
    WHERE  C1 = 1;
if(sqlca.sqlcode != 0)
{
    goto fail_exit;
}

printf("=====\n");
printf( "DATE                : %04d-%02d-%02d %02d:%02d:%02d\n",
        sResultDate.year,
        sResultDate.month,
        sResultDate.day,
        sResultDate.hour,
        sResultDate.minute,
        sResultDate.second );

printf( "TIME                : %02d:%02d:%02d\n",
        sResultTime.hour,

```

```
        sResultTime.minute,
        sResultTime.second );

printf( "TIME WITH TIMEZONE      : %02d:%02d:%02d.%09u(GMT %+02d:%02d)\n",
        sResultTimeTz.hour,
        sResultTimeTz.minute,
        sResultTimeTz.second,
        sResultTimeTz.fraction,
        sResultTimeTz.timezone_hour,
        sResultTimeTz.timezone_minute );

printf( "TIMESTAMP                : %04d-%02d-%02d %02d:%02d:%02d.%09u\n",
        sResultTimestamp.year,
        sResultTimestamp.month,
        sResultTimestamp.day,
        sResultTimestamp.hour,
        sResultTimestamp.minute,
        sResultTimestamp.second,
        sResultTimestamp.fraction );

printf( "TIMESTAMP WITH TIMEZONE: %04d-%02d-%02d %02d:%02d:%02d.%09u(GMT %+02d:%02d)\n",
        sResultTimestampTz.year,
        sResultTimestampTz.month,
        sResultTimestampTz.day,
        sResultTimestampTz.hour,
        sResultTimestampTz.minute,
        sResultTimestampTz.second,
        sResultTimestampTz.fraction,
        sResultTimestampTz.timezone_hour,
        sResultTimestampTz.timezone_minute );

printf("=====\n");

sState = 0;
printf("Drop table ...\n");
if(DropTable() != SUCCESS)
{
    goto fail_exit;
}

sState = 0;
```



```

printf("Disconnect GOLDILOCKS ...\\n");
EXEC SQL COMMIT WORK RELEASE;

printf("SUCCESS\\n");
printf("#####\\n");

return 0;

fail_exit:
printf("\\n");
PRINT_SQL_ERROR("[ERROR] SQL ERROR -");

printf("FAILURE\\n");
printf("#####\\n\\n");

switch(sState)
{
    case 1:
        printf("Drop table ...\\n");
        (void)DropTable();
    default:
        break;
}

EXEC SQL ROLLBACK WORK RELEASE;

return 0;
}

int CreateTable()
{
    EXEC SQL DROP TABLE IF EXISTS TEST_T1;
    if(sqlca.sqlcode != 0)
    {
        goto fail_exit;
    }
}

```

- Create table

```

EXEC SQL CREATE TABLE TEST_T1 ( C1 INTEGER,
                                C2 DATE,

```

```

C3 TIME,
C4 TIME WITH TIME ZONE,
C5 TIMESTAMP,
C6 TIMESTAMP WITH TIME ZONE );

if(sqlca.sqlcode != 0)
{
    goto fail_exit;
}

EXEC SQL COMMIT WORK;
if(sqlca.sqlcode != 0)
{
    goto fail_exit;
}

return SUCCESS;

fail_exit:
PRINT_SQL_ERROR("[ERROR] SQL ERROR -");

EXEC SQL ROLLBACK WORK;

return FAILURE;
}

```

- Drop table

```

int DropTable()
{
    EXEC SQL DROP TABLE TEST_T1;
    if(sqlca.sqlcode != 0)
    {
        goto fail_exit;
    }

    EXEC SQL COMMIT WORK;
    if(sqlca.sqlcode != 0)
    {
        goto fail_exit;
    }
}

```

```

    return SUCCESS;

fail_exit:
    PRINT_SQL_ERROR("[ERROR] SQL ERROR -");

    EXEC SQL ROLLBACK WORK;

    return FAILURE;
}

int Connect(char *aHostInfo, char *aUserID, char *sPassword)
{
    EXEC SQL BEGIN DECLARE SECTION;
    VARCHAR sUid[80];
    VARCHAR sPwd[20];
    VARCHAR sConnStr[1024];
    EXEC SQL END DECLARE SECTION;

```

- Log on DB

```

strcpy((char *)sUid.arr, aUserID);
sUid.len = (short)strlen((char *)sUid.arr);
strcpy((char *)sPwd.arr, sPassword);
sPwd.len = (short)strlen((char *)sPwd.arr);
strcpy((char *)sConnStr.arr, aHostInfo);
sConnStr.len = (short)strlen((char *)sConnStr.arr);

```

- DB connection

```

EXEC SQL CONNECT :sUid IDENTIFIED BY :sPwd USING :sConnStr;
    if(sqlca.sqlcode != 0)
    {
        goto fail_exit;
    }

    return SUCCESS;

fail_exit:
    PRINT_SQL_ERROR("[ERROR] Connection Failure!");

    return FAILURE;
}

```

INTERVAL Types

INTERVAL types are the datatypes which represent the time interval between two times. They are divided into year ~ month family type and day ~ second family type. They are subdivided by specific types of each family.

The following table describes the detailed classification of INTERVAL type.

Table 27-6 Classification of INTERVAL type

Family	Detailed type	Description
YEAR TO MONTH	INTERVAL YEAR	It is an interval in terms of years.
	INTERVAL MONTH	It is an interval in terms of months.
	INTERVAL YEAR TO MONTH	It is an interval in terms of years to months.
DAY TO SECOND	INTERVAL DAY	It is an interval in terms of days.
	INTERVAL HOUR	It is an interval in terms of hours.
	INTERVAL MINUTE	It is an interval in terms of minutes.
	INTERVAL SECOND	It is an interval in terms of seconds.
	INTERVAL DAY TO HOUR	It is an interval in terms of days to hours.
	INTERVAL DAY TO MINUTE	It is an interval in terms of days to minutes.
	INTERVAL DAY TO SECOND	It is an interval in terms of days to seconds.
	INTERVAL HOUR TO MINUTE	It is an interval in terms of hours to minutes.
	INTERVAL HOUR TO SECOND	It is an interval in terms of hours to seconds.
INTERVAL MINUTE TO SECOND	It is an interval in terms of minutes to seconds.	

INTERVAL type has the structure of SQL_INTERVAL_STRUCT of ODBC as follows.

```
typedef enum
{
    SQL_IS_YEAR          = 1,
    SQL_IS_MONTH        = 2,
    SQL_IS_DAY          = 3,
    SQL_IS_HOUR         = 4,
    SQL_IS_MINUTE       = 5,
    SQL_IS_SECOND       = 6,
    SQL_IS_YEAR_TO_MONTH = 7,
    SQL_IS_DAY_TO_HOUR  = 8,
    SQL_IS_DAY_TO_MINUTE = 9,
    SQL_IS_DAY_TO_SECOND = 10,
    SQL_IS_HOUR_TO_MINUTE = 11,
    SQL_IS_HOUR_TO_SECOND = 12,
    SQL_IS_MINUTE_TO_SECOND = 13
} SQLINTERVAL;
```

```

typedef struct tagSQL_YEAR_MONTH
{
    SQLUIINTEGER  year;
    SQLUIINTEGER  month;
} SQL_YEAR_MONTH_STRUCT;
typedef struct tagSQL_DAY_SECOND
{
    SQLUIINTEGER  day;
    SQLUIINTEGER  hour;
    SQLUIINTEGER  minute;
    SQLUIINTEGER  second;
    SQLUIINTEGER  fraction;
} SQL_DAY_SECOND_STRUCT;
typedef struct tagSQL_INTERVAL_STRUCT
{
    SQLINTERVAL  interval_type;
    SQLSMALLINT  interval_sign;
    union {
        SQL_YEAR_MONTH_STRUCT  year_month;
        SQL_DAY_SECOND_STRUCT  day_second;
    } intval;
} SQL_INTERVAL_STRUCT;

```

All INTERVAL types listed above have the same structure. For each INTERVAL type, a valid field is separately distinguished within the structure. INTERVAL type is distinguished by interval_type field within the structure, and a real INTERVAL value is represented to intval union in the structure. The field which is used in intval union is different by each type, and the following table describes the valid field depending on the type.

Table 27-7 The valid field depending on INTERVAL type

Type	? .interval_type	? .intval valid field
INTERVAL YEAR	SQL_IS_YEAR	* .year_month.year
INTERVAL MONTH	SQL_IS_MONTH	* .year_month.month
INTERVAL YEAR TO MONTH	SQL_IS_YEAR_TO_MONTH	* .year_month.year * .year_month.month
INTERVAL DAY	SQL_IS_DAY	* .day_second.day
INTERVAL HOUR	SQL_IS_HOUR	* .day_second.hour
INTERVAL MINUTE	SQL_IS_MINUTE	* .day_second.minute
INTERVAL SECOND	SQL_IS_SECOND	* .day_second.second * .day_second.fraction
INTERVAL DAY TO HOUR	SQL_IS_DAY_TO_HOUR	* .day_second.day

Type	?interval_type	?intval valid field
		*.day_second.hour
INTERVAL DAY TO MINUTE	SQL_IS_DAY_TO_MINUTE	*.day_second.day *.day_second.hour *.day_second.minute
INTERVAL DAY TO SECOND	SQL_IS_DAY_TO_SECOND	*.day_second.day *.day_second.hour *.day_second.minute *.day_second.second *.day_second.fraction
INTERVAL HOUR TO MINUTE	SQL_IS_HOUR_TO_MINUTE	*.day_second.hour *.day_second.minute
INTERVAL HOUR TO SECOND	SQL_IS_HOUR_TO_SECOND	*.day_second.hour *.day_second.minute *.day_second.second *.day_second.fraction
INTERVAL MINUTE TO SECOND	SQL_IS_MINUTE_TO_SECOND	*.day_second.minute *.day_second.second *.day_second.fraction

Fraction refers to the seconds below the decimal point. (The fraction field is valid only for INTERVAL type which includes SECOND.)

Special Type

The special data type provides the additional functionality and convenience for development of application rather than handling the data on its own. The following table describes the special types.

Table 27-8 Special types

Type	Description
SQL_CONTEXT	It manages run-time context within the multi-connection structure.
Struct	It constitutes a set of column as a structure, and it is used when dealing with row.
Typedef	The previously defined type is redefined as another name.

SQL_CONTEXT

SQL_CONTEXT is a special data type for managing the run-time context. Run-time context is used for the purpose of managing the connection and the individual data related to the connection on the run-time while the application is running.

SQL_CONTEXT variable is declared as follows.

```
EXEC SQL BEGIN DECLARE SECTION;
SQL_CONTEXT my_context;
EXEC SQL BEGIN DECLARE SECTION;
```

ALLOCATE clause is used after declaring SQL_CONTEXT variable as follows.

```
EXEC SQL CONTEXT ALLOCATE :my_context;
```

USE clause is used for SQL_CONTEXT variable.

```
EXEC SQL CONTEXT USE :my_context;
```

USE clause specifies the context to be used, and the following describes how to go back to the default context not the context declared by the application.

```
EXEC SQL CONTEXT USE DEFAULT;
```

The disused SQL_CONTEXT variable is released as follows.

```
EXEC SQL CONTEXT FREE :my_context;
```

The following is an example of using SQL_CONTEXT.

```
/*
 * thread1.gc
 *
 */
#include <stdio.h>
#include <stdlib.h>
#include <string.h>
#include <pthread.h>

EXEC SQL INCLUDE SQLCA;

#define SUCCESS 0
#define FAILURE -1

#define PRINT_SQL_ERROR(aMsg) \
{ \
    printf("\n"); \
    printf(aMsg); \
    printf("\nSQLCODE : %d\nSQLSTATE : %s\nERROR MSG : %s\n", \
```

```

        sqlca.sqlcode,          \
        SQLSTATE,              \
        sqlca.sqlerrm.sqlerrmc ); \
    }

int Connect(sql_context aCtx, char *aHostInfo, char *aUserID, char *sPassword);
int CreateEmpTempTable();
int DropEmpTempTable();
void *clientThread(void *args);

typedef struct thread_param
{
    int    mNo;
    char  *mJobName;
} thread_param;

#define THREAD_COUNT  2
char gJobName[THREAD_COUNT][20]= {
    "RND",
    "SUPPORT"
};

int main(int argc, char **argv)
{
    EXEC SQL BEGIN DECLARE SECTION;
    int          sEmpNo;
    varchar      sEName[20 + 1];
    char         sJob[20];
    long         sSalary;
    EXEC SQL END DECLARE SECTION;
    int          sRecordCount = 0;
    pthread_t    thread_id[THREAD_COUNT];
    thread_param param[THREAD_COUNT];
    int          i;

    printf("Connect GOLDILOCKS ...\n");
    if(Connect(NULL, "DSN=GOLDILOCKS", "test", "test") != SUCCESS)
    {
        goto fail_exit;
    }
}

```



```

if(CreateEmpTempTable() != SUCCESS)
{
    goto fail_exit;
}

```

- Create client thread

```

for( i = 0; i < THREAD_COUNT; i ++ )
{
    param[i].mNo = i;
    param[i].mJobName = gJobName[i];
    if( pthread_create(&thread_id[i],
                      NULL,
                      clientThread,
                      &param[i]) != 0 )
    {
        printf( "Can't create thread %d!\n", i );
    }
    else
    {
        printf( "Create thread %d!\n", i );
    }
}

for( i = 0; i < THREAD_COUNT; i ++ )
{
    if( pthread_join(thread_id[i],
                    NULL) != 0 )
    {
        printf( "Error when waiting for thread %d to terminate!\n", i );
    }
    else
    {
        printf( "Stopped thread %d!\n", i );
    }
}

```

- Retrieve employee

EXEC SQL

```

DECLARE EMP_CUR CURSOR FOR
SELECT empno, ename, job, sal

```

```

        FROM EMP_TEMP
        ORDER BY empno;

EXEC SQL OPEN EMP_CUR;
if(sqlca.sqlcode != 0)
{
    PRINT_SQL_ERROR("[ERROR] SQL ERROR -");
    goto fail_exit;
}

printf(" EMPNO      ENAME                      JOB      SALARY\n");
printf("===== \n");
while( 1 )
{
    EXEC SQL
        FETCH EMP_CUR
        INTO :sEmpNo, :sENAME, :sJob, :sSalary;
    if(sqlca.sqlcode == SQL_NO_DATA)
    {
        break;
    }
    else if(sqlca.sqlcode != 0)
    {
        PRINT_SQL_ERROR("[ERROR] SQL ERROR -");
        goto fail_exit;
    }

    sRecordCount ++;

    printf("%6d %20s %10s %8ld\n",
           sEmpNo, sENAME.arr, sJob, sSalary);
}

printf("===== \n");
printf("Record Count = %d\n", sRecordCount);
printf("===== \n");

EXEC SQL CLOSE EMP_CUR;
if(sqlca.sqlcode != 0)
{
    PRINT_SQL_ERROR("[ERROR] SQL ERROR -");
}

```

```

        goto fail_exit;
    }

    if(DropEmpTempTable() != SUCCESS)
    {
        goto fail_exit;
    }

    EXEC SQL COMMIT WORK RELEASE;
    if(sqlca.sqlcode != 0)
    {
        PRINT_SQL_ERROR("[ERROR] SQL ERROR -");
        goto fail_exit;
    }

    printf("SUCCESS\n");
    printf("#####\n");

    return 0;

fail_exit:

    printf("FAILURE\n");
    printf("#####\n\n");
    EXEC SQL ROLLBACK WORK RELEASE;

    return 0;
}

int Connect(sql_context aCtx, char *aHostInfo, char *aUserID, char *sPassword)
{
    EXEC SQL BEGIN DECLARE SECTION;
    VARCHAR  sUid[80];
    VARCHAR  sPwd[20];
    VARCHAR  sConnStr[1024];
    EXEC SQL END DECLARE SECTION;
    struct sqlca sqlca;

```

- Log on GOLDILOCKS

```
strcpy((char *)sUid.arr, aUserID);
    sUid.len = (short)strlen((char *)sUid.arr);
    strcpy((char *)sPwd.arr, sPassword);
    sPwd.len = (short)strlen((char *)sPwd.arr);
    strcpy((char *)sConnStr.arr, aHostInfo);
    sConnStr.len = (short)strlen((char *)sConnStr.arr);
```

- DB connection

```
if( aCtx != NULL )
    {
        EXEC SQL CONTEXT USE :aCtx;
        EXEC SQL CONNECT :sUid IDENTIFIED BY :sPwd USING :sConnStr;
    }
else
    {
        EXEC SQL CONTEXT USE DEFAULT;
        EXEC SQL CONNECT :sUid IDENTIFIED BY :sPwd USING :sConnStr;
    }
if(sqlca.sqlcode != 0)
    {
        goto fail_exit;
    }

    return SUCCESS;

fail_exit:

    PRINT_SQL_ERROR("[ERROR] Connection Failure!");

    return FAILURE;
}

int Disconnect(sql_context aCtx)
{
    struct sqlca sqlca;
```

- DB disconnection

```
if( aCtx != NULL )
    {
```

```

        EXEC SQL CONTEXT USE :aCtx;
        EXEC SQL DISCONNECT;
    }
else
{
    EXEC SQL CONTEXT USE DEFAULT;
    EXEC SQL DISCONNECT;
}
if(sqlca.sqlcode != 0)
{
    goto fail_exit;
}

return SUCCESS;

fail_exit:

    PRINT_SQL_ERROR("[ERROR] Connection Failure!");

return FAILURE;
}

```

- Create table

```

int CreateEmpTempTable()
{
    EXEC SQL DROP TABLE IF EXISTS EMP_TEMP;
    if(sqlca.sqlcode != 0)
    {
        goto fail_exit;
    }

    EXEC SQL
        CREATE TABLE EMP_TEMP (
            EMPNO NUMBER(4) CONSTRAINT PK_EMP_TEMP PRIMARY KEY,
            ENAME VARCHAR2(10),
            JOB VARCHAR2(9),
            SAL NUMBER(7,2),
            DEPTNO NUMBER(2) );
    if(sqlca.sqlcode != 0)
    {

```

```
        goto fail_exit;
    }

    EXEC SQL COMMIT WORK;
    if(sqlca.sqlcode != 0)
    {
        goto fail_exit;
    }
    return SUCCESS;

fail_exit:

    PRINT_SQL_ERROR("[ERROR] SQL ERROR -");
    EXEC SQL ROLLBACK WORK;

    return FAILURE;
}
```

- Drop table

```
int DropEmpTempTable()
{
    EXEC SQL DROP TABLE EMP_TEMP;
    if(sqlca.sqlcode != 0)
    {
        goto fail_exit;
    }

    EXEC SQL COMMIT WORK;
    if(sqlca.sqlcode != 0)
    {
        goto fail_exit;
    }

    return SUCCESS;

fail_exit:

    PRINT_SQL_ERROR("[ERROR] SQL ERROR -");
    EXEC SQL ROLLBACK WORK;
```

```
    return FAILURE;
}

void *clientThread(void *args)
{
    EXEC SQL BEGIN DECLARE SECTION;
    SQL_CONTEXT    my_context;
    char          job_name[20 + 1];
    EXEC SQL END DECLARE SECTION;
    int           state = 0;
    thread_param *param = (thread_param *)args;

    EXEC SQL CONTEXT ALLOCATE :my_context;
    state = 1;

    EXEC SQL CONTEXT USE :my_context;
    if(Connect(my_context, "DSN=GOLDILOCKS", "test", "test") != SUCCESS)
    {
        goto fail_exit;
    }
    state = 2;

    strcpy( job_name, param->mJobName );

    EXEC SQL
        INSERT INTO EMP_TEMP
        SELECT *
        FROM    EMP
        WHERE   JOB = :job_name;
    if(sqlca.sqlcode != 0)
    {
        goto fail_exit;
    }

    EXEC SQL COMMIT WORK;
    if(sqlca.sqlcode != 0)
    {
        goto fail_exit;
    }
    state = 1;
    if(Disconnect(my_context) != SUCCESS)
```

```

    {
        goto fail_exit;
    }
    state = 0;
    EXEC SQL CONTEXT FREE :my_context;
    pthread_exit(0);
    return NULL;

fail_exit:

    PRINT_SQL_ERROR("[ERROR] SQL ERROR -");
    switch(state)
    {
        case 2:
            (void)Disconnect(my_context);
        case 1:
            EXEC SQL CONTEXT FREE :my_context;
            break;
        default:
            break;
    }

    pthread_exit(0);
    return NULL;
}

```

Host Structure

The C structure can be used as a host variable in an embedded SQL of GOLDILOCKS. A typical scalar variable represents a single column, but using the structure enables to simply express multiple column sets.

Host structure can only be used only in INTO clause of SELECT INTO or FETCH INTO statement and in VALUES clause of INSERT statement, but it can not be used in WHERE clause or UPDATE SET clause, because it has the same effect as when listing its member variables in sequence.

The structure is defined in the declare section to use the host structure, and it can be used as a host variable after declaring the structure variable. The structure is defined in the same way as defining the C struct, and it can also be used after defining the type via typedef.

The following is an example of using the host structure.

```

/*
 * sample4.gc

```



```

*
*/
#include <stdio.h>
#include <stdlib.h>
#include <string.h>

EXEC SQL INCLUDE SQLCA;

#define SUCCESS 0
#define FAILURE -1
#define PRINT_SQL_ERROR(aMsg) \
    { \
        printf("\n"); \
        printf(aMsg); \
        printf("\nSQLCODE : %d\nSQLSTATE : %s\nERROR MSG : %s\n", \
            sqlca.sqlcode, \
            SQLSTATE, \
            sqlca.sqlerrm.sqlerrmc ); \
    }

EXEC SQL BEGIN DECLARE SECTION;
typedef struct rsRecord
{
    int          mEmpNo;
    varchar      mENAME[20 + 1];
    char         mJob[20 + 1];
    long         mSalary;
} rsRecord;
EXEC SQL END DECLARE SECTION;

int Connect(char *aHostInfo, char *aUserID, char *sPassword);

int main(int argc, char **argv)
{
    EXEC SQL BEGIN DECLARE SECTION;
    rsRecord    sRecord;
    EXEC SQL END DECLARE SECTION;
    int sRecordCount = 0;

    printf("Connect GOLDILOCKS ...\n");
    if(Connect("DSN=GOLDILOCKS", "test", "test") != SUCCESS)
    {

```

```

        goto fail_exit;
    }

```

- Retrieve employee

EXEC SQL

```

    DECLARE EMP_CUR CURSOR FOR
    SELECT empno, ename, job, sal
    FROM EMP
    ORDER BY EMPNO;

EXEC SQL OPEN EMP_CUR;
if(sqlca.sqlcode != 0)
{
    PRINT_SQL_ERROR("[ERROR] SQL ERROR -");
    goto fail_exit;
}

printf(" EMPNO      ENAME                      JOB      SALARY\n");
printf("===== \n");
while( 1 )
{
    EXEC SQL
        FETCH EMP_CUR
        INTO :sRecord;
    if(sqlca.sqlcode == SQL_NO_DATA)
    {
        break;
    }
    else if(sqlca.sqlcode != 0)
    {
        PRINT_SQL_ERROR("[ERROR] SQL ERROR -");
        goto fail_exit;
    }

    sRecordCount ++;

    printf("%6d %20s %10s %8ld\n",
        sRecord.mEmpNo, sRecord.mENAME.arr, sRecord.mJob, sRecord.mSalary);
}

```

```

printf("=====  

printf("Record Count = %d\n", sRecordCount);  

printf("=====  

EXEC SQL CLOSE EMP_CUR;  

if(sqlca.sqlcode != 0)  

{  

    PRINT_SQL_ERROR("[ERROR] SQL ERROR -");  

    goto fail_exit;  

}

EXEC SQL COMMIT WORK RELEASE;  

if(sqlca.sqlcode != 0)  

{  

    PRINT_SQL_ERROR("[ERROR] SQL ERROR -");  

    goto fail_exit;  

}

printf("\n\nSUCCESS\n");  

printf("#####\n");

return 0;

fail_exit:

printf("\n\nFAILURE\n");  

printf("#####\n\n");

EXEC SQL ROLLBACK WORK RELEASE;

return 0;
}

int Connect(char *aHostInfo, char *aUserID, char *sPassword)  

{  

    EXEC SQL BEGIN DECLARE SECTION;  

    VARCHAR sUid[80];  

    VARCHAR sPwd[20];  

    VARCHAR sConnStr[1024];  

    EXEC SQL END DECLARE SECTION;

```

- Log on GOLDILOCKS

```
strcpy((char *)sUId.arr, aUserID);
    sUId.len = (short)strlen((char *)sUId.arr);
    strcpy((char *)sPwD.arr, sPassword);
    sPwD.len = (short)strlen((char *)sPwD.arr);
    strcpy((char *)sConnStr.arr, aHostInfo);
    sConnStr.len = (short)strlen((char *)sConnStr.arr);
```

- DB connection

```
EXEC SQL CONNECT :sUId IDENTIFIED BY :sPwD USING :sConnStr;
    if(sqlca.sqlcode != 0)
    {
        goto fail_exit;
    }

    return SUCCESS;

fail_exit:
    PRINT_SQL_ERROR("[ERROR] Connection Failure!");

    return FAILURE;
}
```

When a user declares a structure for using the host variable, the restriction is as follows. The nested structure is not allowed. If another structure exists within the structure declaration as shown below, it can not be used as the host variable.

```
EXEC SQL BEGIN DECLARE SECTION;
typedef struct rsRecord
{
    struct person {
        int          mEmpNo;
        varchar      mENAME[20 + 1];
    } person;
    char            mJob[20 + 1];
    long            mSalary;
} rsRecord;
EXEC SQL END DECLARE SECTION;
```

Indicator Variable

Scalar Indicator

Host variables can be used together with the indicator variables combined with it. An indicator variable determines whether the current value of the host variable is NULL. The indicator variable is declared in the same way as the host variable, and it is declared only as an integer type of C (short, int, long, long long). Indicator is used as follows.

```
:hostvar INDICATOR :hostind
:hostvar :hostind (INDICATOR keyword can be omitted.)
```

The value of indicator variable means the followings.

Table 27-9 Value of input indicator

Value	Meaning
-1	NULL
>= 0	It inputs a host variable value.

Table 27-10 Value of output indicator

Value	Meaning
-1	NULL
0	All values are stored in a host variable.
> 0	It is the length of DB data when all values are not stored in a host variable due to an insufficient buffer size of host variable.

The following is an example of using the indicator.

```
/*
 * sample5.gc
 *
 */
#include <stdio.h>
#include <stdlib.h>
#include <string.h>

EXEC SQL INCLUDE SQLCA;

#define SUCCESS 0
#define FAILURE -1
#define PRINT_SQL_ERROR(aMsg) \
{ \
```

```

        printf("\n");
        printf(aMsg);
        printf("\nSQLCODE : %d\nSQLSTATE : %s\nERROR MSG : %s\n",
            sqlca.sqlcode,
            SQLSTATE,
            sqlca.sqlerrm.sqlerrmc );
    }

int Connect(char *aHostInfo, char *aUserID, char *sPassword);
int CreateEmpTempTable();
int DropEmpTempTable();

int main(int argc, char **argv)
{
    EXEC SQL BEGIN DECLARE SECTION;
    int          sEmpNo;
    varchar      sENAME[20 + 1];
    char         sJob[20];
    long         sSalary;
    int          sDeptNo;
    int          sDeptNoInd;
    EXEC SQL END DECLARE SECTION;
    int          sRecordCount = 0;
    int          state = 0;

    printf("Connect GOLDILOCKS ...\n");
    if(Connect("DSN=GOLDILOCKS", "test", "test") != SUCCESS)
    {
        goto fail_exit;
    }

    if(CreateEmpTempTable() != SUCCESS)
    {
        goto fail_exit;
    }
    state = 1;

```

- Update Dept NULL where deptno = 10

```

EXEC SQL
    UPDATE EMP_TEMP

```

```

        SET    DEPTNO = NULL
        WHERE  DEPTNO = 10;
if(sqlca.sqlcode != 0)
{
    PRINT_SQL_ERROR("[ERROR] SQL ERROR -");
    goto fail_exit;
}

```

- Retrieve employee

EXEC SQL

```

        DECLARE EMP_CUR CURSOR FOR
        SELECT empno, ename, job, sal, deptno
        FROM   EMP_TEMP
        ORDER BY empno;

EXEC SQL OPEN EMP_CUR;
if(sqlca.sqlcode != 0)
{
    PRINT_SQL_ERROR("[ERROR] SQL ERROR -");
    goto fail_exit;
}

printf(" EMPNO          ENAME          JOB          SALARY  DEPTNO\n");
printf("===== \n");
while( 1 )
{
    EXEC SQL
        FETCH EMP_CUR
        INTO  :sEmpNo, :sENAME, :sJob, :sSalary, :sDeptNo :sDeptNoInd;
    if(sqlca.sqlcode == SQL_NO_DATA)
    {
        break;
    }
    else if(sqlca.sqlcode != 0)
    {
        PRINT_SQL_ERROR("[ERROR] SQL ERROR -");
        goto fail_exit;
    }

    sRecordCount ++;
}

```

```
    if(sDeptNoInd == -1)
    {
        printf("%6d %20s %10s %8ld (null)\n",
            sEmpNo, sENAME.arr, sJob, sSalary);
    }
    else
    {
        printf("%6d %20s %10s %8ld %4d\n",
            sEmpNo, sENAME.arr, sJob, sSalary, sDeptNo);
    }
}

printf("=====  
printf("Record Count = %d\n", sRecordCount);  
printf("=====  
EXEC SQL CLOSE EMP_CUR;  
if(sqlca.sqlcode != 0)  
{  
    PRINT_SQL_ERROR("[ERROR] SQL ERROR -");  
    goto fail_exit;  
}  
  
state = 0;  
if(DropEmpTempTable() != SUCCESS)  
{  
    goto fail_exit;  
}  
  
EXEC SQL COMMIT WORK RELEASE;  
if(sqlca.sqlcode != 0)  
{  
    PRINT_SQL_ERROR("[ERROR] SQL ERROR -");  
    goto fail_exit;  
}  
  
printf("\n\nSUCCESS\n");  
printf("#####\n");  
  
return 0;
```



```

fail_exit:

    printf("\n\nFAILURE\n");
    printf("#####\n\n");

    switch( state )
    {
        case 1:
            (void)DropEmpTempTable();
            break;
        default:
            break;
    }

    EXEC SQL ROLLBACK WORK RELEASE;

    return 0;
}

int Connect(char *aHostInfo, char *aUserID, char *sPassword)
{
    EXEC SQL BEGIN DECLARE SECTION;
    VARCHAR   sUid[80];
    VARCHAR   sPwd[20];
    VARCHAR   sConnStr[1024];
    EXEC SQL END DECLARE SECTION;

```

- Log on GOLDILOCKS

```

strcpy((char *)sUid.arr, aUserID);
    sUid.len = (short)strlen((char *)sUid.arr);
    strcpy((char *)sPwd.arr, sPassword);
    sPwd.len = (short)strlen((char *)sPwd.arr);
    strcpy((char *)sConnStr.arr, aHostInfo);
    sConnStr.len = (short)strlen((char *)sConnStr.arr);

```

- DB connection

```

EXEC SQL CONNECT :sUid IDENTIFIED BY :sPwd USING :sConnStr;
    if(sqlca.sqlcode != 0)
    {
        goto fail_exit;
    }

```

```
    }  
  
    return SUCCESS;  
  
fail_exit:  
  
    PRINT_SQL_ERROR("[ERROR] Connection Failure!");  
  
    return FAILURE;  
}
```

- Create table

```
int CreateEmpTempTable()  
{  
    EXEC SQL DROP TABLE IF EXISTS EMP_TEMP;  
    if(sqlca.sqlcode != 0)  
    {  
        goto fail_exit;  
    }  
  
    EXEC SQL  
        CREATE TABLE EMP_TEMP (  
            EMPNO NUMBER(4) CONSTRAINT PK_EMP_TEMP PRIMARY KEY,  
            ENAME VARCHAR2(10),  
            JOB VARCHAR2(9),  
            SAL NUMBER(7,2),  
            DEPTNO NUMBER(2) );  
    if(sqlca.sqlcode != 0)  
    {  
        goto fail_exit;  
    }  
  
    EXEC SQL  
        INSERT INTO EMP_TEMP  
        SELECT * FROM EMP;  
    if(sqlca.sqlcode != 0)  
    {  
        goto fail_exit;  
    }  
}
```

```
EXEC SQL COMMIT WORK;
if(sqlca.sqlcode != 0)
{
    goto fail_exit;
}

return SUCCESS;

fail_exit:

PRINT_SQL_ERROR("[ERROR] SQL ERROR -");

EXEC SQL ROLLBACK WORK;

return FAILURE;
}
```

- Drop table

```
int DropEmpTempTable()
{
    EXEC SQL DROP TABLE EMP_TEMP;
    if(sqlca.sqlcode != 0)
    {
        goto fail_exit;
    }

    EXEC SQL COMMIT WORK;
    if(sqlca.sqlcode != 0)
    {
        goto fail_exit;
    }

    return SUCCESS;

fail_exit:

PRINT_SQL_ERROR("[ERROR] SQL ERROR -");
EXEC SQL ROLLBACK WORK;

return FAILURE;
}
```

```
}

```

Structure Indicator

If a host variable is a scalar variable, an Indicator variable is declared and combined with the host variable, then it is used. If the host variable is the structure, each variable configuring the structure can not be used with an indicator variable. In this case, the indicator should also be the structure.

When declaring an indicator structure, it should comply with the followings.

- The number of indicator members should be as same as the number of host variable structure members to be combined.
- All members of the indicator structure should have the integer data type.

For example, if the following structure is declared, the member of indicator structure should be four because the number of the variables of the structure is four.

```
EXEC SQL BEGIN DECLARE SECTION;
typedef struct rsRecord
{
    int          mEmpNo;
    varchar      mENAME[20 + 1];
    char         mJob[20 + 1];
    long         mSalary;
} rsRecord;
EXEC SQL END DECLARE SECTION;
```

Therefore, it should be declared as follows.

```
EXEC SQL BEGIN DECLARE SECTION;
typedef struct rsRecordInd
{
    int          mEmpNoInd;
    int          mENAMEInd;
    int          mJobInd;
    int          mSalaryInd;
} rsRecordInd;
EXEC SQL END DECLARE SECTION;
```

Each indicator structure member sequentially corresponds one-to-one to the host variable structure member which is combined to the indicator structure. When declaring as above, the combination relationship is as follows.

:rsRecordVar INDICATOR :rsRecordIndVar

Host variable	Indicator to be combined
rsRecordVar.mEmpNo	rsRecordIndVar.mEmpNoInd
rsRecordVar.mENAME	rsRecordIndVar.mENAMEInd
rsRecordVar.mJob	rsRecordIndVar.mJobInd
rsRecordVar.mSalary	rsRecordIndVar.mSalaryInd

Embedded SQL

Host Variable

The host variable is used as the data input/output medium between the application and GOLDILOCKS. The input host variable transfers the data from the application to GOLDILOCKS, and the output host variable transfers the data from GOLDILOCKS to the application. The declarations of two variables are same and their roles are determined in the SQL statement in use.

The host variable which is located in INTO clause of SELECT or FETCH statement is the output host variable. It receives the data from GOLDILOCKS. Other than that is the input host variable. The input host variable should be set before executing the SQL statement.

Host Indicator

The host variable literally uses the variable of C language, so a particular way to display NULL does not exist. The indicator variable can be used for that, and a single indicator is combined with a single host variable.

An indicator variable means the followings.

Table 27-11 Value of input indicator

Value	Meaning
-1	NULL
>= 0	It inputs a host variable value.

Table 27-12 Value of output indicator

Value	Meaning
-1	NULL
0	All values are stored in a host variable.
> 0	It is the length of DB data when all values are not stored in a host variable due to an insufficient buffer size of host variable.

Insert NULL

NULL is inserted in a column as follows.

```
EXEC SQL INSERT INTO EMP ( EMPNO, DEPTNO ) VALUES ( :empno, NULL );
```

However, if hard coding above is used to create the application, the flexibility becomes very poor. The following is an example of using the indicator variable.

```
deptno_ind = -1;
EXEC SQL INSERT INTO EMP ( EMPNO, DEPTNO ) VALUES ( :empno, :deptno :deptno_ind );
```

If the value of deptno_ind which is the indicator variable is -1, it is recognized as NULL regardless of the value of deptno which is the host variable.

Fetch NULL

When GOLDILOCKS receives the data, the indicator variable can be used to determine whether to be NULL. The following is an example.

```
EXEC SQL DECLARE CUR_1 CURSOR FOR
    SELECT  EMPNO, DEPTNO
    FROM    EMP
    WHERE   EMPNO = :emp_number;
EXEC SQL OPEN CUR_1;

while( 1 )
{
    EXEC SQL FETCH CUR_1 INTO :empno, :deptno :deptno_ind;
    if( sqlca.sqlcode == SQL_NO_DATA )
    {
        break;
    }

    if( deptno_ind == -1 )
    {
        printf( "empno : %d, deptno : (null)\n", empno );
    }
    else
    {
        printf( "empno : %d, deptno : %d\n", empno, deptno );
    }
}
```

```
EXEC SQL CLOSE CUR_1;
```

If deptno_ind is -1 after performing FETCH, it determines that deptno is NULL.

Basic SQL Statement

All SQL statements provided in GOLDILOCKS is available in an embedded SQL. For more information about SQL statements, refer to **Part III. SQL Manual**. When using an SQL statement in an embedded SQL, the SQL statement is specified after EXEC SQL keyword. This chapter describes Data Definition Language (DDL) or Data Manipulation Language (DML), and the next chapter describes the statements repeatedly retrieving data like as a query.

SQLCA is checked to determine whether the SQL statement is successfully executed. For more information, refer to **Handling Run-time Errors**.

DDL Statement

DDL statement is an SQL statement which creates, drops or alters GOLDILOCKS objects such as table, view, index. When executing a DDL statement in an embedded SQL application, the SQL statement is specified after EXEC SQL keyword.

```
EXEC SQL DROP TABLE IF EXISTS EMP;
EXEC SQL
    CREATE TABLE EMP (
        EMPNO NUMBER(4) CONSTRAINT PK_EMP PRIMARY KEY,
        ENAME VARCHAR2(10),
        JOB VARCHAR2(9),
        SAL NUMBER(7,2),
        DEPTNO NUMBER(2) );
```

The host variable can not be used in DDL statement. Therefore, the following usage is wrong.

```
strcpy( table_name, "T1" );
EXEC SQL CREATE TABLE :table_name ( C1 INTEGER );
```

If DDL statement is to be used variably as above because the DDL statement is not defined while creating the application, the dynamic SQL statement can be used as follows.

```
strcpy( table_name, "T1" );
sprintf( sql_stmt, "CREATE TABLE %s ( C1 INTEGER )", table_name );
EXEC SQL EXECUTE IMMEDIATE :sql_stmt;
```

For more information, refer to [Embedded Dynamic SQL](#).

Select Into Statement

The query is used to retrieve the data from GOLDILOCKS. Generally, the number of retrieved rows are not known, so the cursor object is declared and the process of open, fetch, close may be performed to use the query statement. For more information, refer to [Cursor](#).

However, the number of retrieved rows are known in a special case. For example, when the primary key is known and the record with the same primary key is retrieved, then it can be predicted that the result either does not exist or has up to one record. The select into statement is used when the number of the result records is less than one as follows.

```
EXEC SQL
  SELECT ename, job, sal
  INTO :emp_name, :job_title, :salary
  FROM emp
  WHERE empno = :emp_number;
```



Several records can be retrieved by using select into statement when using host array. For more information about host array, refer to [Host Array](#).

Insert Statement

The insert statement is used to insert rows into a table. The column value can be determined by using the host variable, and NULL can be inserted by using an indicator.

The following is an example of the insert statement.

```
EXEC SQL
  INSERT INTO EMP ( empno, ename, job, sal )
  VALUES ( :emp_number, :emp_name, :job_name :job_ind, :saraly );
EXEC SQL
  INSERT INTO DEPT ( deptno, dname, loc )
  VALUES ( 1, :dept_name, NULL );
```



When using host structure, data can be inserted in structure units instead of individually using host variable.

```
EXEC SQL BEGIN DECLARE SECTION;
typedef struct rsRecord
{
```



```

    int          mEmpNo;
    varchar      mENAME[20 + 1];
    char         mJob[20 + 1];
    long         mSalary;
} rsRecord;

rsRecord sInsertRec;
EXEC SQL END DECLARE SECTION;

sInsertRec.mEmpNo = 3000;
strcpy( sInsertRec.mENAME.arr, "John" );
sInsertRec.mENAME.len = strlen( sInsertRec.mENAME.arr );
strcpy( sInsertRec.mJob , "RND" );
sInsertRec.mSalary = 3500;

EXEC SQL INSERT INTO EMP ( empno, ename, job, sal ) VALUES ( :sInsertRec );

```



Multiple rows can be inserted by using host array at once. For more information, refer to **Host Array**.

Update Statement

The update statement is used to update the column values of the specific rows in a table. The column value can be determined by using the host variable, and NULL can be inserted by using an indicator.

The following is an example of the update statement.

```

EXEC SQL
    UPDATE emp
    SET sal = :salary, deptno = :dept_number :deptno_ind
    WHERE empno = :emp_number;

```



Multiple rows can be updated by using host array at once. For more information, refer to **Host Array**.

Delete Statement

The delete statement removes the specific rows from a table.

The following is an example of the delete statement.

```
EXEC SQL
```

```
DELETE FROM emp
WHERE empno = :emp_number;
```



Multiple rows can be deleted by using host array at once. For more information, refer to **Host Array**.

PSM Statement

PSM statement creates a procedure or a function within a server and uses it. For more information about PSM, refer to **PSM manual**.

Generally, it starts with EXEC SQL EXECUTE and ends with END-EXEC;. However, when creating a procedure or a function, EXEC SQL is used instead of EXEC SQL EXECUTE.

The following is an example of a statement creating and calling a procedure.

```
EXEC SQL
```

```
CREATE OR REPLACE PROCEDURE PROC1( A1 INTEGER, A2 INTEGER )
IS
  V1 INTEGER;
BEGIN
  SELECT COUNT(*)
  INTO V1
  FROM T1
  WHERE T1.I1 >= A1 AND T1.I1 <= A2;
  DBMS_OUTPUT.PUT_LINE( 'V1 = ' || V1 );
END;
END-EXEC;
EXEC SQL CALL PROC1( 2, 4 );
```

The following is an example of a statement creating and calling a function.

```
EXEC SQL BEGIN DECLARE SECTION;
```

```
  int          sV1 = 0;
```

```
EXEC SQL END DECLARE SECTION;
```

```
EXEC SQL
```

```
CREATE OR REPLACE FUNCTION FUNC1( A1 INTEGER, A2 INTEGER )
RETURN INTEGER
IS
  V1 INTEGER;
```

```

BEGIN
  SELECT COUNT(*)
    INTO V1
    FROM T1
    WHERE T1.I1 >= A1 AND T1.I1 <= A2;
  RETURN V1;
END;
END-EXEC;
EXEC SQL CALL FUNC1( 2, 4 ) INTO :sV1;

```

The following is an example of an anonymous block statement.

```

EXEC SQL EXECUTE
  DECLARE
    V1 INTEGER := 0;
    FUNCTION FUNC1( A1 INTEGER )
      RETURN INTEGER
    IS
      BEGIN
        RETURN A1 * 10;
      END;
  BEGIN
    V1 := FUNC1( 10 );
    DBMS_OUTPUT.PUT_LINE( 'V1 = ' || V1 );
  END;
END-EXEC;

```

```

EXEC SQL EXECUTE
  DECLARE
    PROCEDURE PROC1( A1 INTEGER )
    IS
      BEGIN
        DBMS_OUTPUT.PUT_LINE( 'A1 = ' || A1 );
      END;
  BEGIN
    PROC1( 100 );
  END;
END-EXEC;

```

Cursor

The application executes the query to retrieve data from GOLDILOCKS. Generally, the cursor is used because the number of rows retrieved are not known when executing the query. The cursor is an identifier which specifies the position of the current row in the query result set. The cursor can be manipulated via the following operations.

Declare Cursor

It declares a cursor. The cursor name and its query should be specified. The declared cursor name is used for different cursor manipulation commands later. The following is an example of the cursor declaration.

```
EXEC SQL
    DECLARE RECORD_CUR1 CURSOR FOR
    SELECT empno, ename, dept
    FROM SEMP
    ORDER BY empno;
```

The cursor name is an identifier recognized and used by the precompiler, and it has nothing to do with the variable of C program. The cursor declaration precedes the statement accessing the cursor on the program source code. The cursor declaration which is defined on the other file can not be used. All statements which perform the operations such as open/ fetch/ close of the cursor should exist on a single source file, and the cursor declaration should precede all those statements. It is impossible to use the same cursor name for different queries within a single source file.

```
EXEC SQL OPEN RECORD_CUR1;
```

- Wrong position of the cursor declaration

```
EXEC SQL
    DECLARE RECORD_CUR1 CURSOR FOR
    SELECT empno, ename, dept
    FROM SEMP
    ORDER BY empno;
```

If the cursor declaration is positioned behind as above, then the error of which the cursor is not declared in the precompile process occurs.

```
FileName: overview.gc
Pre-compile overview.gc -> overview.c
ERR-42000(41000): syntax error
Error at line 310, in file overview.gc
ERR-42000(41003): Cursor "RECORD_CUR1" not declared
```

```

OPEN RECORD_CUR1;
.....^
Error at line 1:
ERR-42000(41006): Fatal error while doing embedded SQL preprocessing

```

Open Cursor

It opens a cursor.

```

EXEC SQL OPEN <cursor_name>;
Example)
EXEC SQL OPEN EMP_CURSOR;

```

If the cursor is opened, it is prepared to fetch the result set which the query of the declared cursor is executed. However, it does not actually fetch the result. **Fetch Cursor** should be performed to actually fetch the data.

The host variable which is used when executing the query does not affect the result set until the current cursor is closed.

```

EXEC SQL DECLARE EMP_CURSOR CURSOR FOR
        SELECT  empno, ename, dept
        FROM    EMP
        WHERE   empno < :sNo
        ORDER BY empno;

sNo = 100;
EXEC SQL OPEN EMP_CURSOR;
if(sqlca.sqlcode != 0)
{
    goto fail_exit;
}

while( 1 )
{
    sNo = 10;
    EXEC SQL FETCH EMP_CURSOR INTO :emp_number, :emp_name, :dept_name;
    if(sqlca.sqlcode == SQL_NO_DATA)
    {
        break;
    }
    else if(sqlca.sqlcode != 0)
    {

```

```

        goto fail_exit;
    }
    ...
}

```

In the example above, even if the cursor is opened with `sNo = 100` and `sNo` is changed during the processing, it does not affect the result set until the cursor is closed.

Fetch Cursor

It fetches the row at the cursor position.

```
EXEC SQL FETCH <cursor_name> INTO <host_variable_list>;
```

Example)

```
EXEC SQL FETCH EMP_CURSOR INTO :emp_number, :emp_name, :dept_name;
```

The cursor should be declared first for FETCH operation, and it should be open. If FETCH is performed for the first time, the cursor moves to the first row of the result set and specifies it as a current row. Then, it fetches the current row into the host variable of INTO clause and returns. After then, if FETCH is repeatedly performed, the cursor updates the current row to the next row, and then it repeatedly fetches the current row into the host variable of INTO clause and returns. If the result does not exist even after performing FETCH, `SQL_NO_DATA` code is returned in `sqlca.sqlcode`, and the application checks this code to determine whether this operation is terminated.

Close Cursor

It closes a cursor.

```
EXEC SQL CLOSE <cursor_name>;
```

Example)

```
EXEC SQL CLOSE EMP_CURSOR;
```

The cursor should already be open to close it. The FETCH can not be performed after closing the cursor. If the cursor is opened to use it again after it is closed, then it becomes a new cursor. Therefore, the result set of the new cursor may be different from the result set of the previously closed cursor.

The following sample code is an example of the simple DDL, DML and cursor.

```

/*
 * overview.gc
 *
 * Connect / Disconnect
 * DDL(Create/Drop table)
 * Basic DML(Insert, Delete, Update)

```

```

* Standing Cursor
*/
EXEC SQL INCLUDE SQLCA;

#include <stdio.h>
#include <stdlib.h>
#include <string.h>

#define SUCCESS 0
#define FAILURE -1
#define PRINT_SQL_ERROR(aMsg) \
    { \
        printf("\n"); \
        printf(aMsg); \
        printf("\nSQLCODE : %d\nSQLSTATE : %s\nERROR MSG : %s\n", \
            sqlca.sqlcode, \
            SQLSTATE, \
            sqlca.sqlerrm.sqlerrmc ); \
    }

EXEC SQL BEGIN DECLARE SECTION;
typedef struct rsEmpRecord
{
    int      mEmpNo;
    char     mENAME[20];
    char     mDept[10];
} rsEmpRecord;

rsEmpRecord gRecord[10] = {
    { 1, "Park", "RND" },
    { 2, "Kim", "CEO" },
    { 3, "Choi", "SALES" },
    { 4, "Lee", "CTO" },
    { 5, "Lyu", "RND" },
    { 6, "Ohn", "SUPPORT" },
    { 7, "Cheon", "RND" },
    { 8, "Sohn", "SALES" },
    { 9, "Smith", "WAIT" },
    { 10, "mycomman", "WAIT" }
};
EXEC SQL END DECLARE SECTION;

```

```
int CreateEmpTable();
int DropEmpTable();
int Connect(char *aHostInfo, char *aUserID, char *sPassword);
int Disconnect();
int PrintRecord();

int main(int argc, char **argv)
{
    EXEC SQL BEGIN DECLARE SECTION;
    int          sEmpNo;
    char          sDept[10 + 1];
    EXEC SQL END DECLARE SECTION;
    int  sState = 0;

    printf("Connect GOLDILOCKS ...\n");
    if(Connect("DSN=GOLDILOCKS", "test", "test") != SUCCESS)
    {
        goto fail_exit;
    }
    sState = 1;

    printf("Create SEMP table ...\n");
    if(CreateEmpTable() != SUCCESS)
    {
        goto fail_exit;
    }
    sState = 2;

    printf("Insert record ...\n");
    EXEC SQL
        INSERT INTO SEMP(empno, ename, dept)
        VALUES(:gRecord);
    if(sqlca.sqlcode != 0)
    {
        PRINT_SQL_ERROR("[ERROR] SQL ERROR -");
        goto fail_exit;
    }
    printf("=====\n");
    printf("%d Record Inserted\n", sqlca.sqlerrd[2]);
    printf("=====\n");
```



```
EXEC SQL COMMIT WORK;
if(sqlca.sqlcode != 0)
{
    PRINT_SQL_ERROR("[ERROR] SQL ERROR -");
    goto fail_exit;
}

printf("Current record\n");
PrintRecord();

sEmpNo = 9;
printf("Delete record WHERE empno == %d\n", sEmpNo);
EXEC SQL
    DELETE FROM SEMP
    WHERE empno = :sEmpNo;
if(sqlca.sqlcode != 0)
{
    PRINT_SQL_ERROR("[ERROR] SQL ERROR -");
    goto fail_exit;
}

printf("After Delete record\n");
PrintRecord();

EXEC SQL COMMIT WORK;
if(sqlca.sqlcode != 0)
{
    PRINT_SQL_ERROR("[ERROR] SQL ERROR -");
    goto fail_exit;
}

strcpy( sDept, "RND" );
printf("Update record WHERE dept == 'WAIT'\n");
EXEC SQL
    UPDATE SEMP
    SET dept = :sDept
    WHERE dept = 'WAIT';
if(sqlca.sqlcode != 0)
{
    PRINT_SQL_ERROR("[ERROR] SQL ERROR -");
```

```
        goto fail_exit;
    }

    printf("After Update record\n");
    PrintRecord();

    EXEC SQL COMMIT WORK;
    if(sqlca.sqlcode != 0)
    {
        PRINT_SQL_ERROR("[ERROR] SQL ERROR -");
        goto fail_exit;
    }

    sState = 1;
    printf("Drop SEMP table ...\n");
    if(DropEmpTable() != SUCCESS)
    {
        goto fail_exit;
    }

    sState = 0;
    printf("Disconnect GOLDILOCKS ...\n");
    if(Disconnect() != SUCCESS)
    {
        goto fail_exit;
    }

    printf("SUCCESS\n");
    printf("#####\n");

    return 0;

fail_exit:

    printf("FAILURE\n");
    printf("#####\n");

    EXEC SQL ROLLBACK WORK;
    switch(sState)
    {
        case 2:
```

```

        printf("Drop SEMP table ...\n");
        (void)DropEmpTable();
    case 1:
        printf("Disconnect GOLDILOCKS ...\n");
        (void)Disconnect();
        break;
    default:
        break;
}

return 0;
}

```

- Create table

```

int CreateEmpTable()
{
    EXEC SQL DROP TABLE IF EXISTS SEMP;
    if(sqlca.sqlcode != 0)
    {
        goto fail_exit;
    }

    EXEC SQL CREATE TABLE SEMP ( empno      INTEGER,
                                ename      VARCHAR(20),
                                dept      VARCHAR(10),
                                PRIMARY KEY (empno) );

    if(sqlca.sqlcode != 0)
    {
        goto fail_exit;
    }

    EXEC SQL COMMIT WORK;
    if(sqlca.sqlcode != 0)
    {
        goto fail_exit;
    }

    return SUCCESS;

fail_exit:

```

```
    PRINT_SQL_ERROR("[ERROR] SQL ERROR -");

    EXEC SQL ROLLBACK WORK;

    return FAILURE;
}
```

- Drop table

```
int DropEmpTable()
{
    EXEC SQL DROP TABLE SEMP;
    if(sqlca.sqlcode != 0)
    {
        goto fail_exit;
    }

    EXEC SQL COMMIT WORK;
    if(sqlca.sqlcode != 0)
    {
        goto fail_exit;
    }

    return SUCCESS;

fail_exit:

    PRINT_SQL_ERROR("[ERROR] SQL ERROR -");

    EXEC SQL ROLLBACK WORK;

    return FAILURE;
}

int Connect(char *aHostInfo, char *aUserID, char *sPassword)
{
    EXEC SQL BEGIN DECLARE SECTION;
    VARCHAR sUid[80];
    VARCHAR sPwd[20];
    VARCHAR sConnStr[1024];
```

```
EXEC SQL END DECLARE SECTION;
```

- Log on GOLDILOCKS

```
strcpy((char *)sUId.arr, aUserID);
sUId.len = (short)strlen((char *)sUId.arr);
strcpy((char *)sPwD.arr, sPassword);
sPwD.len = (short)strlen((char *)sPwD.arr);
strcpy((char *)sConnStr.arr, aHostInfo);
sConnStr.len = (short)strlen((char *)sConnStr.arr);
```

- DB connection

```
EXEC SQL CONNECT :sUId IDENTIFIED BY :sPwD USING :sConnStr;
if(sqlca.sqlcode != 0)
{
    goto fail_exit;
}

return SUCCESS;

fail_exit:

PRINT_SQL_ERROR("[ERROR] Connection Failure!");

return FAILURE;
}

int Disconnect()
{
    EXEC SQL DISCONNECT;
    if(sqlca.sqlcode != 0)
    {
        goto fail_exit;
    }

    return SUCCESS;

fail_exit:

PRINT_SQL_ERROR("[ERROR] [ERROR] Disconnect Failure!");
```

```
    return FAILURE;
}

int PrintRecord()
{
    EXEC SQL BEGIN DECLARE SECTION;
    rsEmpRecord sResultRecord;
    EXEC SQL END DECLARE SECTION;
    int sRecordCount = 0;

    EXEC SQL
        DECLARE RECORD_CUR1 CURSOR FOR
        SELECT empno, ename, dept
        FROM SEMP
        ORDER BY empno;

    EXEC SQL OPEN RECORD_CUR1;
    if(sqlca.sqlcode != 0)
    {
        goto fail_exit;
    }

    printf(" EMPNO      ENAME                DEPT\n");
    printf("=====  
===== \n");
    while( 1 )
    {
        EXEC SQL FETCH RECORD_CUR1 INTO :sResultRecord;
        if(sqlca.sqlcode == SQL_NO_DATA)
        {
            break;
        }
        else if(sqlca.sqlcode != 0)
        {
            goto fail_exit;
        }

        sRecordCount ++;

        printf("%6d %20s %10s\n",
            sResultRecord.mEmpNo,
            sResultRecord.mENAME,
```

```

        sResultRecord.mDept);
    }

    printf("=====  

    printf("Record Count = %d\n", sRecordCount);
    printf("=====  

    EXEC SQL CLOSE RECORD_CUR1;
    if(sqlca.sqlcode != 0)
    {
        goto fail_exit;
    }

    return SUCCESS;

fail_exit:

    PRINT_SQL_ERROR("[ERROR] SQL ERROR -");

    return FAILURE;
}

```

Cursor Property

The previous chapter described only the most basic cursor. However, the cursor may have various properties, and it can perform various functions depending on the properties. An embedded SQL of GOLDLOCKS provides the cursor properties provided in ISO/IEC-9075-2 SQL Foundation and ODBC.

For more information about the cursor definition syntax and the property, refer to **DECLARE cursor_name**.

Scrollable Cursor

SCROLL is the cursor property of ISO type, and it determines whether the cursor is scrollable. The scrollable cursor can receive the position option in the FETCH statement, and the row at the position according to this option is fetched. If scrolling is impossible, it can FETCH only the row in the result set sequentially.

When declaring the scroll cursor, SCROLL option is used. The following is an example of the declaration.

```
EXEC SQL DECLARE cur_scroll SCROLL CURSOR FOR SELECT c1, c2 FROM t1;
```

With NO SCROLL option, the cursor which is unable to scroll is declared. When the scroll option is not given, the default value is NO SCROLL.

For the scrollable cursor, it is possible to specify the position information when fetching. This position info

Information is called as fetch orientation, and it is as follows.

Table 27-13 Fetch orientation

Fetch orientation	Description
NEXT	It fetches the next row of the current position.
PRIOR	It fetches the previous row of the current position.
FIRST	It fetches the first row in the result set.
LAST	It fetches the last row in the result set.
CURRENT	It fetches the row of the current position.
ABSOLUTE <position>	<ul style="list-style-type: none"> It fetches the row corresponding to <i>position</i> in the result set. If the position value is a negative number, it fetches the row of the previous position from AFTER THE LAST ROW.
RELATIVE <position>	It fetches the row which is away as much as <i>position</i> from the current position.

If fetch orientation is ABSOLUTE or RELATIVE, the value of <position> is additionally required. The value of <position> may be an integer literal or the host variable of the integer type. The following is an example of fetch orientation.

```
EXEC SQL FETCH NEXT;
EXEC SQL FETCH PRIOR;
EXEC SQL FETCH FIRST;
EXEC SQL FETCH LAST;
EXEC SQL FETCH CURRENT;
EXEC SQL FETCH ABSOLUTE 100;
EXEC SQL FETCH RELATIVE :position;
```

Sensitive Cursor

Sensitivity is the cursor property of ISO type, and it determines whether the changes can be displayed if the result set is changed during the cursor operation. Sensitivity has the following three options.

Table 27-14 Sensitivity

Option	Description
SENSITIVE	The information which is deleted or updated in another transaction can be viewed.
INSENSITIVE	The information which is deleted or updated after the cursor is opened can not be viewed.
ASENSITIVE	SENSITIVE/ INSENSITIVE is selected according to information of query.

If sensitive option is not specified, the default value is INSENSITIVE, and the cursor with the sensitive option is declared as follows.

```
EXEC SQL DECLARE <cur_name> SENSITIVE CURSOR FOR SELECT c1, c2 FROM t1;
EXEC SQL DECLARE <cur_name> INSENSITIVE CURSOR FOR SELECT c1, c2 FROM t1;
EXEC SQL DECLARE <cur_name> ASENSITIVE CURSOR FOR SELECT c1, c2 FROM t1;
```

Holdable Cursor

Holdability is the cursor property of ISO type, and it determines whether the cursor is still held even after the transaction which opened the current cursor is committed. Holdability has the following two options.

Table 27-15 Holdability

Option	Description
WITH HOLD	<ul style="list-style-type: none"> The cursor is held even after the end of the transaction. It can not be used with FOR UPDATE clause. It can not be used with INSERT INTO ... RETURNING statement. It can not be used with UPDATE ... RETURNING statement. It can not be used with DELETE FROM ... RETURNING statement.
WITHOUT HOLD	The cursor is closed when COMMIT/ ROLLBACK the transaction.
Rollback and cursor	<ul style="list-style-type: none"> It closes a cursor which is included in a transaction when rolling back the transaction. It closes a cursor which is created after the savepoint when rolling back the transaction to the savepoint.

If holdable option is not specified, the default value is determined according to <cursor updatability>.

- If FOR READ ONLY or <cursor updatability> is not specified, it is WITH HOLD.
- If it is used with FOR UPDATE statement, it is WITHOUT HOLD.

The cursor using holdable option is declared as follows.

```
EXEC SQL DECLARE <cur_name> CURSOR WITH HOLD FOR SELECT c1, c2 FROM t1;
EXEC SQL DECLARE <cur_name> CURSOR WITHOUT HOLD FOR SELECT c1, c2 FROM t1 FOR UPDATE;
```

Static Cursor

Static cursor is the cursor property of ODBC type, and it is as same as INSENSITIVE SCROLL cursor of ISO type.

```
EXEC SQL DECLARE cur_static STATIC CURSOR FOR SELECT c1, c2 FROM t1;
```

For more information about how to fetch the static cursor, refer to **Scrollable Cursor**.

Keyset Driven Cursor

Keyset driven cursor is the cursor property of ODBC type, it is as same as SENSITIVE SCROLL cursor of ISO type.

```
EXEC SQL DECLARE cur_static KEYSET CURSOR FOR SELECT c1, c2 FROM t1;
```

Keyset driven cursor also has the scroll feature, so for more information about how to fetch, refer to **Scrollable Cursor**.

Positioned DML

Positioned DML refers that delete or update statement can be executed for the finally fetched row using CURRENT OF <cursor_name> clause. The cursor should be open and point to the row by performing the Fetch at least once to execute the positioned DML.

The following is an example of executing the positioned DML.

```
EXEC SQL DECLARE emp_cursor CURSOR FOR
    SELECT ename, sal FROM emp WHERE job = 'SALES'
    FOR UPDATE;
...
EXEC SQL OPEN emp_cursor;
EXEC SQL WHENEVER NOT FOUND GOTO ...
while( 1 )
{
    EXEC SQL FETCH emp_cursor INTO :emp_name, :salary;
    ...
    EXEC SQL UPDATE emp SET sal = :new_salary
        WHERE CURRENT OF emp_cursor;
}
```

Options

This chapter describes the applicable options when an embedded SQL source code is precompiled.

Precompiled Header File

When developing the embedded SQL program, it is efficient that the information referenced in common by multiple source codes is stored in the separated header file and the header file is included in the source

e code. C language supports this feature by using #include statement. However, when the header file is included by using #include of C language the target file is not precompiled but it is interpreted by the compiler of C language, so the declare section within the file is not converted by the precompiler.

EXEC SQL INCLUDE statement is used to convert and insert this header file into the source code by the precompiler when creating the header file. The syntax is as follows.

```
EXEC SQL INCLUDE <filename>;
```

The statement above precompiles the given file and inserts it into the source code.

Specifying Header File Path

Generally, it preferentially searches for the directory in which the current source code is stored when searching for the header file. However, header files are often separately stored in many cases or they exist in other paths for many reasons.

In this case, the directory searching for the header file is given separately as an option, and the syntax is as follows.

```
EXEC SQL OPTION( INCLUDE = <directory path> );
```

Several options can be listed and the directories are searched in the order given by the options when searching for the header file via EXEC SQL INCLUDE.



This option can be given via command-line option of precompiler. For more information, refer to `--include-path, -I` of **Precompiler Options**.

Host Array

So far, only the scalar variables having only a single value as the host variable were described. This chapter describes how to use the array with the host variable.

When using the host array, the program source code becomes simple, and the performance is improved, but it should be used carefully because there are restrictions.

Declaring Host Array

Declaration of the host array is as same as the declaration of the scalar variable. A variable is required only to be declared as an array itself. The following is an example of declaring the host array with its size 10.

```
EXEC SQL BEGIN DECLARE SECTION;
    int    empno[10];
    char   ename[10][20];
    double salary[10];
EXEC SQL END DECLARE SECTION;
```

The host array declaration has the following limitations.

- More than two-dimensional array is not allowed.
- Exceptionally, the string family (char, varchar) and binary family (binary, varbinary) can be used as the two-dimensional array because their array consists of an array subscript representing the array size and data size.
- An array of pointer is not allowed.

Using Host Array

Accessing Host Array

How to use the host array in the SQL statement is as same as to use the scalar host variable.

The following is a simple example of the host array.

```
EXEC SQL BEGIN DECLARE SECTION;
int    emp_number[20];
char   emp_name[20][10];
int    dept_number[20];
EXEC SQL END DECLARE SECTION;
```

- Setting the values of emp_number, emp_name, dept_number

...

- Inserting the values of emp_number, emp_name, dept_number

```
EXEC SQL INSERT INTO emp (empno, ename, deptno)
    VALUES (:emp_number, :emp_name, :dept_number);
```

The example above has the same feature as the following code.

```
EXEC SQL BEGIN DECLARE SECTION;
int    emp_number[20];
char   emp_name[20][10];
int    dept_number[20];
```

```
EXEC SQL END DECLARE SECTION;
```

- Setting the values of emp_number, emp_name, dept_number

```
...
```

- Inserting the values of emp_number, emp_name, dept_number

```
for( i = 0; i < 20; i ++ )
{
    EXEC SQL INSERT INTO emp (empno, ename, deptno)
        VALUES (:emp_number[i], :emp_name[i], :dept_number[i]);
}
```

When using several host variable arrays, the operation is performed for the array with the smallest array size among the host arrays. In the example above, 20 rows are inserted because the size of every host variable is 20. However, 10 rows are inserted as a result in the example below, if the array size of dept_number is specified as 10.

```
EXEC SQL BEGIN DECLARE SECTION;
int    emp_number[20];
char   emp_name[20][10];
int    dept_number[10];
EXEC SQL END DECLARE SECTION;
```

- Setting the values of emp_number, emp_name, dept_number

```
...
```

- Inserting the values of emp_number, emp_name, dept_number

```
EXEC SQL INSERT INTO emp (empno, ename, deptno)
    VALUES (:emp_number, :emp_name, :dept_number);
```

Using Host Indicator Array

If the host variable is an array, the indicator variable to be combined to it should also be an array. Also, the indicator variable and the host variable should have the same array size. The following is an example of adding the indicator variable to the example above.

```
EXEC SQL BEGIN DECLARE SECTION;
int    emp_number[20];
int    emp_number_ind[20];
```

```
char emp_name[20][10];
int emp_name_ind[20];
int dept_number[20];
int dept_number_ind[20];
EXEC SQL END DECLARE SECTION;
```

- Setting the values of emp_number, emp_name, dept_number
- Setting each indicator value of emp_number_ind, emp_name_ind, dept_number_ind

...

- Inserting the values of emp_number, emp_name, dept_number

```
EXEC SQL INSERT INTO emp (empno, ename, deptno)
VALUES (:emp_number :emp_number_ind,
        :emp_name :emp_name_ind,
        :dept_number :dept_number_ind);
```

Restrictions

- When using several host variables, it is not allowed to use a mixture of scalar variables and array variables.
- The host array can not be used in WHERE clause of the select statement.
- The host array can not be used in CURRENT OF clause of the update, delete statements.

Array in INTO Clause

In GOLDILOCKS, rows are fetched by using SELECT INTO statement or cursor. An embedded SQL uses INTO clause in common for both two methods. Multiple rows are fetched by using the host array in INTO clause.

Array in SELECT INTO

If the number of rows to be fetched is explicitly known, it is implemented by using the host array in **Select Into Statement**. Only the case of when row does not exist or a single row is fetched is described in **Select Into Statement**. However, multiple rows can be fetched by using the host array in it.

The usage is as same as using scalar variables, but the Select Into statement with the array can be created just by declaring the host variable with the array.

```
EXEC SQL BEGIN DECLARE SECTION;
char emp_name[50][20];
int emp_number[50];
```

```
float salary[50];
EXEC SQL END DECLARE SECTION;

EXEC SQL SELECT ENAME, EMPNO, SAL
        INTO :emp_name, :emp_number, :salary
        FROM EMP
        WHERE SAL > 1000;
```

In the example above, SELECT INTO statement is used to fetch 50 rows by declaring the host variable with an array. This statement fetches only the first 50 rows which meet the query criteria because it is an independent execution unit.



Even if more than 50 rows meet the query criteria, it can not fetch the rear rows starting from the 51th row by using the SELECT INTO statement. Cursor should be used when continuously fetching rows.

Array When Using Cursor

If the number of rows in the result set is unknown for the current query, the cursor should be used. For more information about how to use the cursor, refer to **Cursor**. After declaring the cursor, multiple rows can be fetched at once by using the host variable of INTO clause as an array in FETCH statement.

```
EXEC SQL BEGIN DECLARE SECTION;
        int emp_number[50];
        char emp_name[50][20];
        char dept_name[50][20];
EXEC SQL END DECLARE SECTION;

EXEC SQL DECLARE EMP_CURSOR CURSOR FOR
        SELECT empno, ename, dept
        FROM EMP
        WHERE empno < :sNo
        ORDER BY empno;

sNo = 100;
EXEC SQL OPEN EMP_CURSOR;
if(sqlca.sqlcode != 0)
{
        goto fail_exit;
}
```

```

while( 1 )
{
    EXEC SQL FETCH EMP_CURSOR INTO :emp_number, :emp_name, :dept_name;
    if(sqlca.sqlcode == SQL_NO_DATA)
    {
        break;
    }
    else if(sqlca.sqlcode != 0)
    {
        goto fail_exit;
    }
    ...
}

```

50 rows can be fetched at once by using the host array in FETCH statement.

sqlca.sqlerrd[2]

The rows are fetched as many as the declared array size when using an array, but sometimes it can not fetch as many as the declared array size because there is not a row any more. For example, if the array size is declared as 50 and the number of rows in the result set are 30, then only 30 rows can be fetched. To solve this problem, an embedded SQL of GOLDILOCKS provides information about the number of rows processed by the current statement in sqlca.sqlerrd[2].

The number of rows processed in INSERT, UPDATE, DELETE, SELECT INTO, FETCH statements are returned in sqlca.sqlerrd[2].

```

EXEC SQL BEGIN DECLARE SECTION;
    int   emp_number[50];
    char  emp_name[50][20];
    char  dept_name[50][20];
EXEC SQL END DECLARE SECTION;

EXEC SQL DECLARE EMP_CURSOR CURSOR FOR
    SELECT empno, ename, dept
    FROM EMP
    WHERE empno < :sNo
    ORDER BY empno;

sNo = 100;
EXEC SQL OPEN EMP_CURSOR;
if(sqlca.sqlcode != 0)
{

```



```

        goto fail_exit;
    }

    while( 1 )
    {
        EXEC SQL FETCH EMP_CURSOR INTO :emp_number, :emp_name, :dept_name;
        if(sqlca.sqlcode == SQL_NO_DATA)
        {
            break;
        }
        else if(sqlca.sqlcode != 0)
        {
            goto fail_exit;
        }

        for( i = 0; i < sqlca.sqlerrd[2]; i ++ )
        {
            printf( "%d %s %s\n", emp_number[i], emp_name[i], dept_name[i] );
        }
        ...
    }

```

For more information about sqlca, refer to **Handling Run-time Errors**.

Array in Insert Statement

If the host variable is declared as an array in INSERT statement, the array insert is implemented.

```

EXEC SQL BEGIN DECLARE SECTION;
int    emp_number[20];
char   emp_name[20][10];
int    dept_number[20];
EXEC SQL END DECLARE SECTION;

```

- Setting the values of emp_number, emp_name, dept_number

...

- Inserting the values of emp_number, emp_name, dept_number

```
EXEC SQL INSERT INTO emp (empno, ename, deptno)
VALUES (:emp_number, :emp_name, :dept_number);
```

The example above has the same feature as the following code.

```
EXEC SQL BEGIN DECLARE SECTION;
int    emp_number[20];
char   emp_name[20][10];
int    dept_number[20];
EXEC SQL END DECLARE SECTION;
```

- Setting the values of emp_number, emp_name, dept_number

...

- Inserting the values of emp_number, emp_name, dept_number

```
for( i = 0; i < 20; i ++ )
{
    EXEC SQL INSERT INTO emp (empno, ename, deptno)
        VALUES (:emp_number[i], :emp_name[i], :dept_number[i]);
}
```



- When using the array insert, all host variables should be array variables or all of them should be scalar variables.
- The number of inserted rows can be checked by using `sqlca.sqlerrd[2]`.

Atomic Insert

Atomic insert is a special form of the array insert, and it has the following 2 characteristics.

- If any of the rows to be inserted is failed, the entire insert operation fails.
- The performance is outstanding because the command is transferred only once from the application to GOLDILOCKS.

ATOMIC keyword is used for the atomic insert as follows.

```
EXEC SQL BEGIN DECLARE SECTION;
int    emp_number[20];
char   emp_name[20][10];
int    dept_number[20];
```

```
EXEC SQL END DECLARE SECTION;
```

- Setting the values of emp_number, emp_name, dept_number

```
...
```

- Inserting the values of emp_number, emp_name, dept_number

```
EXEC SQL ATOMIC INSERT INTO emp (empno, ename, deptno)
VALUES (:emp_number, :emp_name, :dept_number);
```

Array in Update Statement

The following is an example of using the array in update statement.

```
EXEC SQL BEGIN DECLARE SECTION;
char job_title [10][20];
float commission[10];
EXEC SQL END DECLARE SECTION;

...

EXEC SQL UPDATE emp SET comm = :commission
WHERE job = :job_title;
```

The example above has the same feature as the following code.

```
EXEC SQL BEGIN DECLARE SECTION;
char job_title [10][20];
float commission[10];
EXEC SQL END DECLARE SECTION;

...
for( i = 0; i < 10; i ++ )
{
    EXEC SQL UPDATE emp SET comm = :commission[i]
    WHERE job = :job_title[i];
}
```



- When using the array update, all host variables should be array variables or all of them should be scalar variables.

- The number of updated rows can be checked by using `sqlca.sqlerrd[2]`.
- Array can not be used in CURRENT OF clause of UPDATE statement.

Array in Delete Statement

Array can be used in DELETE statement as follows.

```
EXEC SQL BEGIN DECLARE SECTION;
char job_title[10][20];
EXEC SQL BEGIN DECLARE SECTION;
...
EXEC SQL DELETE FROM emp
    WHERE job = :job_title;
```

The example above has the same feature as the following code.

```
EXEC SQL BEGIN DECLARE SECTION;
char job_title[10][20];
EXEC SQL BEGIN DECLARE SECTION;
...
for( i = 0; i < 10; i ++ )
{
    EXEC SQL DELETE FROM emp
        WHERE job = :job_title[i];
}
```



- When using the array delete, all host variables should be array variables or all of them should be scalar variables.
- The number of deleted rows can be checked by using `sqlca.sqlerrd[2]`.
- Array can not be used in CURRENT OF clause of DELETE statement.

Using FOR Clause

FOR clause is used to specify the array size when executing the SQL statement. FOR clause can be used in the following statements.

- SELECT INTO
- FETCH
- INSERT
- UPDATE

- DELETE

For clause can be used as follows.

```
EXEC SQL FOR :host_variable <sql_stmt>
EXEC SQL FOR <integer_constant> <sql_stmt>
```

The following is an example of using the for clause.

```
EXEC SQL BEGIN DECLARE SECTION;
int    emp_number[20];
char   emp_name[20][10];
int    dept_number[20];
int    record_cnt;
EXEC SQL END DECLARE SECTION;
```

- Setting the values of emp_number, emp_name, dept_number

...

- Inserting the values of emp_number, emp_name, dept_number

```
record_cnt = 10;
EXEC SQL FOR :record_cnt INSERT INTO emp (empno, ename, deptno)
VALUES (:emp_number, :emp_name, :dept_number);
```

In the example above, the actual number of inserted rows are 10 because the size of the host array is given as 20 but it is specified to perform as much as record_cnt by using the FOR clause.



FOR clause can not be used with CURRENT OF clause in UPDATE/ DELETE statements.

Structure Array

Using the general scalar variables as an array has the advantage of processing multiple rows at once, but it has a limit that a variable can represent only a single column.

For more information about how to process multiple columns with a single host variable, refer to **Host Structure**. Multiple rows with multiple columns can be processed at once by declaring a host variable as a structure and using the structure as the array.

A structure array can be used in the following cases.

- Output host variable array: SELECT INTO, FETCH INTO statements
- Input host variable array: VALUES item of INSERT statement

Restrictions

A structure array can not be used in the following cases.

- It can not be used in WHERE clause or FROM clause.
- It can not be used in SET clause of UPDATE statement.

Declaring Structure Array

A structure is declared in an way of a common C language structure declaration. A structural variable can be directly declared, or it can be declared as a host variable after declaring type via typedef.

```
EXEC SQL BEGIN DECLARE SECTION;
typedef struct rsRecord
{
    int          mEmpNo;
    varchar      mENAME[20 + 1];
    char         mJob[20 + 1];
    long         mSalary;
} rsRecord;
rsRecord      sRecord[10];

struct {
    int          mEmpNo;
    varchar      mENAME[20 + 1];
    char         mJob[20 + 1];
    long         mSalary;
} sResultRecord[10];
EXEC SQL END DECLARE SECTION;
```

When declaring the structure for using the host variable, the nested structure can not be used. If another structure is inside the structure declaration as follows, it can not be used as a host variable.

```
EXEC SQL BEGIN DECLARE SECTION;
typedef struct rsRecord
{
    struct person {
        int          mEmpNo;
        varchar      mENAME[20 + 1];
    } person;
}
```

```

    char        mJob[20 + 1];
    long        mSalary;
} rsRecord;
EXEC SQL END DECLARE SECTION;

```

Indicators of Structure Array

As described in **Structure Indicator**, if a host variable is the structure, the Indicator variable should also be the structure. For the same reason, if the host variable is the structure array, the indicator variable should also be the corresponding structure array.

The declaration of the Indicator structure array should comply with the followings.

- It should have the number of members as many as the host variable structure to be combined by the indicator.
- All members of the Indicator structure should have a integer data type.
- The size of the indicator structure array should be as same as that of the host variable structure array. If size of the Indicator structure array is smaller, the number of array executions should be limited by using FOR clause when executing SQL statement.

Mixed Use of Structure and Scalar Variable

When the host structure is transferred to GOLDLOCKS, its structure members are sequentially listed. The following is an example of mixed use of the host structure and the scalar variable.

```

EXEC SQL BEGIN DECLARE SECTION;
    typedef struct rsEmp
    {
        int        mEmpNo;
        varchar    mENAME[20 + 1];
    } rsEmp;
    rsEmp    sEmp[5];
    char    sJob[5][20 + 1];
    long    sSalary[5];
EXEC SQL END DECLARE SECTION;

EXEC SQL
    DECLARE EMP_CUR CURSOR FOR
    SELECT empno, ename, job, sal
    FROM EMP
    ORDER BY EMPNO;
EXEC SQL OPEN EMP_CUR;

```

```
EXEC SQL
    FETCH EMP_CUR
    INTO :sEmp, :sJob, :sSalary;
```

The structure `rsEmp` and the scalar variables `sJob`, `sSalary` are used together in `FETCH` statement. This statement is internally interpreted as four variables `sEmp.mEmpNo`, `sEmp.mENAME`, `sJob` and `sSalary`. The host structure and the host scalar variable can be used together in this way.

The following is an example of mixed use of the host structure array, structure array indicator, structure and scalar variable.

```
/*
 * fetch_struct_array.gc
 * : structure array fetch
 * : structure indicators
 * : mix structure, scalar variable
 * : sqlca.sqlerrd[2]
 *
 */
#include <stdio.h>
#include <stdlib.h>
#include <string.h>

EXEC SQL INCLUDE SQLCA;

#define SUCCESS 0
#define FAILURE -1

#define PRINT_SQL_ERROR(aMsg) \
    { \
        printf("\n"); \
        printf(aMsg); \
        printf("\nSQLCODE : %d\nSQLSTATE : %s\nERROR MSG : %s\n", \
            sqlca.sqlcode, \
            SQLSTATE, \
            sqlca.sqlerrm.sqlerrmc ); \
    }

EXEC SQL BEGIN DECLARE SECTION;
typedef struct rsEmp
{
    int          mEmpNo;
    varchar      mENAME[20 + 1];
```



```

} rsEmp;
EXEC SQL END DECLARE SECTION;

int Connect(char *aHostInfo, char *aUserID, char *sPassword);

int main(int argc, char **argv)
{
    EXEC SQL BEGIN DECLARE SECTION;
    rsEmp    sEmp[5];
    char     sJob[5][20 + 1];
    long     sSalary[5];
    EXEC SQL END DECLARE SECTION;
    int  sRecordCount = 0;
    int  i;

    printf("Connect GOLDILOCKS ...\n");
    if(Connect("DSN=GOLDILOCKS", "test", "test") != SUCCESS)
    {
        goto fail_exit;
    }
}

```

- Retrieve employee

```

EXEC SQL
    DECLARE EMP_CUR CURSOR FOR
    SELECT empno, ename, job, sal
    FROM   EMP
    ORDER BY EMPNO;

EXEC SQL OPEN EMP_CUR;
if(sqlca.sqlcode != 0)
{
    PRINT_SQL_ERROR("[ERROR] SQL ERROR -");
    goto fail_exit;
}

printf(" EMPNO      ENAME                JOB      SALARY\n");
printf("===== \n");

while( 1 )
{

```

```

EXEC SQL
    FETCH EMP_CUR
    INTO :sEmp, :sJob, :sSalary;
if(sqlca.sqlcode == SQL_NO_DATA)
{
    break;
}
else if(sqlca.sqlcode != 0)
{
    PRINT_SQL_ERROR("[ERROR] SQL ERROR -");
    goto fail_exit;
}

sRecordCount += sqlca.sqlerrd[2];

for( i = 0; i < sqlca.sqlerrd[2]; i ++ )
{
    printf("%6d %20s %10s %8ld\n",
           sEmp[i].mEmpNo, sEmp[i].mENAME.arr, sJob[i], sSalary[i]);
}
}
printf("=====\n");
printf("Record Count = %d\n", sRecordCount);
printf("=====\n");

EXEC SQL CLOSE EMP_CUR;
if(sqlca.sqlcode != 0)
{
    PRINT_SQL_ERROR("[ERROR] SQL ERROR -");
    goto fail_exit;
}

EXEC SQL COMMIT WORK RELEASE;
if(sqlca.sqlcode != 0)
{
    PRINT_SQL_ERROR("[ERROR] SQL ERROR -");
    goto fail_exit;
}

printf("\n\nSUCCESS\n");
printf("#####\n");

```

```

    return 0;

fail_exit:

    printf("\n\nFAILURE\n");
    printf("#####\n\n");

    EXEC SQL ROLLBACK WORK RELEASE;

    return 0;
}

int Connect(char *aHostInfo, char *aUserID, char *sPassword)
{
    EXEC SQL BEGIN DECLARE SECTION;
    VARCHAR sUId[80];
    VARCHAR sPwD[20];
    VARCHAR sConnStr[1024];
    EXEC SQL END DECLARE SECTION;

```

- Log on GOLDILOCKS

```

strcpy((char *)sUId.arr, aUserID);
sUId.len = (short)strlen((char *)sUId.arr);
strcpy((char *)sPwD.arr, sPassword);
sPwD.len = (short)strlen((char *)sPwD.arr);
strcpy((char *)sConnStr.arr, aHostInfo);
sConnStr.len = (short)strlen((char *)sConnStr.arr);

```

- DB connection

```

EXEC SQL CONNECT :sUId IDENTIFIED BY :sPwD USING :sConnStr;
    if(sqlca.sqlcode != 0)
    {
        goto fail_exit;
    }

    return SUCCESS;

fail_exit:

```

```
PRINT_SQL_ERROR("[ERROR] Connection Failure!");  
  
return FAILURE;  
}
```

Handling Run-time Errors

Overview

In case when the application can not get the expected result during execution, a preparation is required for this case when developing an embedded SQL application. This chapter explains how to detect the results returned after the SQL execution.

Detecting Run-time Error

SQLCA

All types of errors which occur in an embedded SQL are reported in the area called as SQL Communication Area (SQLCA). Therefore, the application can identify the success of the current operation and the error type by checking the information of SQLCA.

SQLCA is a data structure which stores errors, warnings, SQL statement execution states. SQLCA will only have the results of the last SQL execution which the data structure is combined, but it does not have information about the history of executed SQL statement. If an embedded SQL statement is executed, the existing contents of SQLCA disappears. Therefore, it is necessary to immediately check SQLCA and to perform the exception handling after executing the SQL statement.

Using SQLCA

The following syntax is used to use SQLCA.

```
EXEC SQL INCLUDE SQLCA;
```

The syntax above is replaced with the following statement in the precompile process.

```
#include "sqlca.h"
```

This statement should be used before using the first embedded SQL statement, and it is typically recommended to be positioned at the top of the source code.

The embedded SQL application of GOLDILOCKS generally has a global sqlca. In a single thread program, sqlca can be used without any declaration. However, in multi thread program, sqlca is required to be declared.

red separately because the simultaneous accesses to `sqlca` cause the concurrency problems. For more information, refer to **Multithread Application**.

SQLCA Structure

The following describes the structure of `sqlca`.

```

struct sqlca
{
    char    sqlcaid[8];    ❶ It is initialized to the string SQLCA.
    int     sqlabc;       ❷ It is the size of sqlca structure.

    /*
     * ❸ It is the error code which occurred in the most recent statement execution.
     * ❹ If it is 0, it is successful. If it is a positive number, it is a warning. If it is
a negative number, it is an error.
     */
    int     sqlcode;

    /*
     * ❺ It stores the error message for sqlcode
     * ❻ .sqlerrml is the length of sqlerrmc.
     * ❼ .sqlerrmc stores the error message in a string form.
     */
    struct
    {
        unsigned short sqlerrml;
        char            sqlerrmc[SQLERRMC_LEN];
    } sqlerrm;

    char    sqlerrp[8]; /* unused */
    int     sqlerrd[6];
    /* 0: empty */
    /* 1: empty */
    /* 2: ❽ It is the number of rows processed after INSERT, UPDATE, DELETE. */
    /* 3: empty */
    /* 4: empty */
    /* 5: empty */
    char    sqlwarn[8];
    /* 0: ❾ If any warning occurs, it is 'W'.
     * 1: ❿ If the result string is truncated in SELECT, FETCH, it is 'W'.
     * 2: unused

```

```

    * 3: unused
    * 4: unused
    * 5: unused
    * 6: unused
    * 7: unused
    */
char    sqlext[8];    /* unused          */
char    sqlstate[8]; /* SQLSTATE      */
unsigned short *rowstatus; /* fetched row status array*/
};

```

The next chapter describes the content of each component.

SQLCODE

SQLCODE is defined as follows.

```
#define SQLCODE          (sqlca.sqlcode)
```

SQLCODE executes an embedded SQL statement and then returns the result code. SQLCODE was proposed early in ISO/IEC-9075, but it is deprecated in SQL-92. However, it is provided for the backward compatibility because it is being used in many applications. The result code is as follows.

Table 27-16 Execution result of SQLCODE

SQLCODE	Result
0	Success
> 0	Warning
SQL_NO_DATA	No result
< 0	Error

sqlcode is checked as follows. sqlca.sqlcode or SQLCODE can be used.

```

EXEC SQL
    DECLARE EMP_CUR CURSOR FOR
    SELECT empno, ename, job, sal
    FROM EMP;

EXEC SQL OPEN EMP_CUR;
if(SQLCODE != 0)
{
    goto fail_exit;
}
while( 1 )

```

```

{
    EXEC SQL
        FETCH EMP_CUR
        INTO :sEmpNo, :sENAME, :sJob, :sSalary;
    if(sqlca.sqlcode == SQL_NO_DATA)
    {
        break;
    }
    else if(sqlca.sqlcode != 0)
    {
        goto fail_exit;
    }
    ...
}

```

SQLSTATE

SQLSTATE is defined as follows.

```
#define SQLSTATE      (sqlca.sqlstate)
```

SQLCODE was deprecated in ISO/IEC-9075, and SQLSTATE is proposed instead. SQLSTATE consists of five characters(number, English uppercase alphabet), and the first two digits are called as class, and the rear 3 digits are called as subclass. The result of SQLSTATE are as follows.

Table 27-17 Execution result of SQLSTATE

SQLSTATE	Result
00000	Success
01xxx	Warning
02000	No result
All other states	Error

The code is modified by checking SQLSTATE instead of SQLCODE in the example above as follows. sqlca.sqlstate or SQLSTATE can be used.

```

EXEC SQL
    DECLARE EMP_CUR CURSOR FOR
    SELECT empno, ename, job, sal
    FROM EMP;

EXEC SQL OPEN EMP_CUR;

```

```

if(strcmp(SQLSTATE, "00000") != 0)
{
    goto fail_exit;
}
while( 1 )
{
    EXEC SQL
        FETCH EMP_CUR
        INTO :sEmpNo, :sENAME, :sJob, :sSalary;
    if(strcmp(sqlca.sqlstate, "02000") == 0)
    {
        break;
    }
    else if(strcmp(sqlca.sqlstate, "00000") != 0)
    {
        goto fail_exit;
    }

    ...
}

```

Number of Processed Rows

When executing update, delete statements or insert, select info, fetch statement using array, it informs a user the number of the processed rows. The information is stored in `sqlca.sqlerrd[2]`. The application refers to the field value and finds out the number of the processed rows. The following is an example of using `sqlca.sqlerrd[2]`.

```

EXEC SQL BEGIN DECLARE SECTION;
    typedef struct rsEmp
    {
        int          mEmpNo;
        varchar      mENAME[20 + 1];
    } rsEmp;
    rsEmp    sEmp[5];
    char     sJob[5][20 + 1];
    long     sSalary[5];
EXEC SQL END DECLARE SECTION;

EXEC SQL
    DECLARE EMP_CUR CURSOR FOR
    SELECT empno, ename, job, sal
    FROM EMP;

```



```

EXEC SQL OPEN EMP_CUR;
if(SQLCODE != 0)
{
    goto fail_exit;
}
while( 1 )
{
    EXEC SQL
        FETCH EMP_CUR
        INTO :sEmpNo, :sENAME, :sJob, :sSalary;
    if(sqlca.sqlcode == SQL_NO_DATA)
    {
        break;
    }
    else if(sqlca.sqlcode != 0)
    {
        goto fail_exit;
    }

    sRecordCount += sqlca.sqlerrd[2];
    ...
}

```

Status of Processed Rows

sqlca.row status indicates the row status which is currently processed. When the row is updated or deleted by using the scroll sensitive cursor or Where CURRENT OF, then the row status can be updated. When using SQL statement with array, It has row status as many as the array size.

Table 27-18 Referring to the row status

Number of rows	Row status
1	*sqlca.rowstatus
Array size n	sqlca.rowstats[0] sqlca.rowstats[1] sqlca.rowstats[2] ... sqlca.rowstats[n-1]

Table 27-19 Value of row status

Row status	Description
SQL_ROW_SUCCESS	The row status is normal.

Row status	Description
SQL_ROW_DELETED	The row is deleted.
SQL_ROW_UPDATED	The row is updated.
SQL_ROW_NOROW	The row does not exist.
SQL_ROW_ADDED	The row is added.
SQL_ROW_ERROR	The row status is not normal.

The following is an example of referring to the row status.

```
EXEC SQL BEGIN DECLARE SECTION;
    typedef struct rsEmp
    {
        int          mEmpNo;
        varchar      mENAME[20 + 1];
    } rsEmp;
    rsEmp    sEmp[5];
    char     sJob[5][20 + 1];
    long     sSalary[5];
EXEC SQL END DECLARE SECTION;
EXEC SQL
    DECLARE EMP_CUR CURSOR FOR
    SELECT empno, ename, job, sal
    FROM   EMP;

EXEC SQL OPEN EMP_CUR;
if(SQLCODE != 0)
{
    goto fail_exit;
}
while( 1 )
{
    EXEC SQL
        FETCH EMP_CUR
        INTO  :sEmpNo, :sENAME, :sJob, :sSalary;
    if(sqlca.sqlcode == SQL_NO_DATA)
    {
        break;
    }
    else if(sqlca.sqlcode != 0)
    {
        goto fail_exit;
    }
}
```

```

    }

    sRecordCount += sqlca.sqlerrd[2];

    for( i = 0; i < sqlca.sqlerrd[2]; i ++ )
    {
        if( sqlca.rowstatus[i] == SQL_ROW_SUCCESS )
        {
            printf("%6d %20s %10s %8ld\n",
                sEmp[i].mEmpNo, sEmp[i].mENAME.arr, sJob[i], sSalary[i]);
        }
    }

    ...
}

```

Error Message Text

When an error or warning occurs as a result of the embedded SQL statement, the message can be transferred in a text form. The error message is stored in `sqlca.sqlerrm`, and `sqlca.sqlerrm.sqlerrml` is the length of the text. The actual message is stored in `sqlca.sqlerrm.sqlerrmc`. The error message text is useful to output information to a user when anomalies occur in the application. The following is an example of using an error message text.

```

EXEC SQL INSERT INTO EMP VALUES ( :sEmp );
if( SQLCODE != 0 )
{
    printf("\nSQLCODE : %d\nSQLSTATE : %s\nERROR MSG : %s\n",
        SQLCODE,
        SQLSTATE,
        sqlca.sqlerrm.sqlerrmc );
}

```

Warning Flags

When a warning occurs after executing the embedded SQL, `sqlca.sqlwarn` is used as the flag which marks the warning. It consists of eight char arrays, and the mark of 'W' is used when the warning occurs.

Table 27-20 Warning flags

Warning flag	Description
<code>sqlca.sqlwarn[0]</code>	If any warning occurs, it is 'W'.
<code>sqlca.sqlwarn[1]</code>	If the result string is truncated in select into, fetch, then it is 'W'.

Warning flag	Description
sqlca.sqlwarn[2]	reserved
sqlca.sqlwarn[3]	reserved
sqlca.sqlwarn[4]	reserved
sqlca.sqlwarn[5]	reserved
sqlca.sqlwarn[6]	reserved
sqlca.sqlwarn[7]	reserved

Handling Implicit Error

After executing the embedded SQL statement, a user should check SQLCA and take action into the execution result. However, when treating the same exception occurs after executing the embedded SQL statement, it can be automated by using WHENEVER indicator.

Using WHENEVER Statement

WHENEVER statement has the following syntax.

```
EXEC SQL WHENEVER conditions actions;
```

WHENEVER Condition

Conditions of WHENEVER statement are as follows.

```
<conditions> ::=
    SQLERROR
    | SQLWARNING
    | NOT FOUND
    | SQLSTATE <sqlstate class value>[<sqlstate subclass value>]
    ;

<sqlstate_char> ::= [0-9A-Z];
<sqlstate class value> ::= <sqlstate_char><sqlstate_char>;
<sqlstate subclass value> ::= <sqlstate_char><sqlstate_char><sqlstate_char>;
```

Table 27-21 Conditions of WHENEVER statement

Conditions	Descriptions
SQLERROR	An error occurs while an embedded SQL is executed.
SQLWARNING	A warning occurs while an embedded SQL is executed.
NOT FOUND	A result row does not exist.
SQLSTATE <sqlstate>	SQLSTATE <sqlstate> occurs while an embedded SQL is executed.

WHENEVER Action

When actions meet the conditions described above, it describes the action actually performed, and its syntax is as follows.

```
<actions> ::=
    CONTINUE
  | GOTO <label>
  | STOP
  | DO <c statements>
  ;
```

Table 27-22 Actions of WHENEVER statement

Actions	Description
CONTINUE	An action is not performed. It ignores the given conditions.
GOTO <label>	It branches the program flow with <label>.
STOP	It terminates the program execution.
DO <c statements>	It executes <c statements>.

Scope of WHENEVER Statement

WHENEVER statement describes actions for conditions, and only one action can be described for one condition. When using WHENEVER statement, the same action is used for all embedded SQL statements until the definition of another condition comes after the current condition.

Maximum four WHENEVER statements can be applied for a specific point because WHENEVER statements are separately managed by each condition. If a new WHENEVER statement is applied for the same condition, the existing action is canceled and a new action may be applied afterwards. The following is an example.

```
EXEC SQL WHENEVER SQLERROR STOP;
EXEC SQL INSERT INTO emp VALUES ( :emp_number, :emp_name, :salary ); ❶
...
EXEC SQL WHENEVER SQLERROR CONTINUE;
EXEC SQL UPDATE emp SET sal = sal * 1.1 WHERE sal < :sal_bound; ❷
...
EXEC SQL WHENEVER SQLERROR GOTO exit_label;
EXEC SQL WHENEVER NOT FOUND DO break;
EXEC SQL DECLARE EMP_CURSOR FOR
    SELECT empno, ename, sal
    FROM emp;
```

```

EXEC SQL OPEN EMP_CURSOR; ❸

EXEC SQL WHENEVER SQLERROR GOTO close_label;
while( 1 )
{
    EXEC SQL FETCH EMP_CURSOR
        INTO :emp_number, :emp_name, :salary; ❹

    printf( "emp number : %d, emp name : %s, salary : %lf\n",
        emp_number, emp_name, salary );
}
close_label:
EXEC SQL WHENEVER SQLERROR DO sql_error();
EXEC SQL CLOSE EMP_CURSOR; ❺
...
exit_label:
...

```

The application is stopped when an error occurs during executing ❶ because the stop operation is specified for SQLERROR in line 1. SQLERROR action is changed to proceed without performing any action because CONTINUE is indicated for SQLERROR in line 4. Therefore, it proceeds to the next even when an error occurs during executing ❷. It branches to exit_label when an error occurs during executing ❸ because the SQLERROR action is set to branch to exit_label in line 7. It is specified to perform break for NOT FOUND in line 8, and SQLERROR action is reassigned as close_label in line 15. Therefore, two conditions are applied to ❹. When an error occurs during FETCH, it branches to close_label, and if the FETCH result does not exist, then the break statement is executed. sql_error() function is called when an error occurs during executing ❺ because SQLERROR action is specified to execute sql_error() in line 26.

Notice for WHENEVER statement

WHENEVER statement should be used carefully after understanding the operation principle. The following should be considered when using the WHENEVER statement.

- The position of WHENEVER statement on the source code: WHENEVER statement is an indicator which informs to automatically insert the exception handling code to precompiler, and it is not an logically executable code. WHENEVER should be at the beginning of the embedded SQL statements to be applied on the source code. CONTINUE action should be used to initialize not to affect the following embedded SQL.
- Using the break, continue keywords: If DO break, DO continue are used in an action clause, the loop scope should be checked and used. The following is an example.

```

EXEC SQL WHENEVER SQLERROR GOTO fail_exit;
EXEC SQL WHENEVER NOT FOUND DO break; ❶
EXEC SQL DECLARE EMP_CURSOR FOR
        SELECT empno, ename, sal
        FROM emp;

EXEC SQL OPEN EMP_CURSOR;
while( 1 )
{
    EXEC SQL FETCH EMP_CURSOR
        INTO :emp_number, :emp_name, :salary; ❷
    printf( "emp number : %d, emp name : %s, salary : %lf\n",
        emp_number, emp_name, salary );
}
EXEC SQL CLOSE EMP_CURSOR;

EXEC SQL
    SELECT MAX(sal)
    INTO :max_salary
    FROM emp; ❸
...

```

break; may be performed for NOT FOUND in subsequent SQL statements because the action for NOT FOUND is defined as DO break; in ❶. When NOT FOUND occurs in ❷ during FETCH, break is performed and it exits the while loop. However, break can not be performed when NOT FOUND occurs in ❸ because it is not a loop. In this case, the compile error occurs when building the source program and developing the application

- Avoiding infinite loop

If it is misused when branching to the action, it causes the infinite loop. The following is an example.

```

EXEC SQL WHENEVER SQLERROR GOTO sql_error;
...
EXEC SQL INSERT INTO emp VALUES ( :emp_number, :emp_name, :salary );
...
sql_error:
    EXEC SQL ROLLBACK WORK RELEASE;

```

When an error occurs during executing the SQL statement, it branches to sql_error label. When an error occurs during executing the embedded SQL statement, it branches to sql_error. However, when the error is repeatedly occurs during executing another embedded SQL statement in an error processing, the applic

ation infinitely loops. In this case, the following is recommended to safely initialize the error handling.

```
EXEC SQL WHENEVER SQLERROR GOTO sql_error;
...
EXEC SQL INSERT INTO emp VALUES ( :emp_number, :emp_name, :salary );
...
sql_error:
    EXEC SQL WHENEVER SQLERROR CONTINUE;
    EXEC SQL ROLLBACK WORK RELEASE;
```

- Scope of branch label

If it is branched in an action, its label should be located in an accessible position. The following is an example.

```
func1()
{
    EXEC SQL WHENEVER SQLERROR GOTO labelA;
    EXEC SQL DELETE FROM emp WHERE deptno = :dept_number;
    ...
labelA:
    ...
}
func2()
{
    EXEC SQL INSERT INTO emp (job) VALUES (:job_title);
    ...
}
```

In `func1()`, the branching the `labelA` is specified for `SQLERROR`. However, the compile error occurs because `labelA` exists in `func1()` but it does not exist in `func2()`. In this case, the same `labelA` should be created in `func2()` or the action should be initialized as follows.

```
func1()
{
    EXEC SQL WHENEVER SQLERROR GOTO labelA;
    EXEC SQL DELETE FROM emp WHERE deptno = :dept_number;
    ...
labelA:
```



```
...  
}  
func2()  
{  
    EXEC SQL WHENEVER SQLERROR CONTINUE;  
    EXEC SQL INSERT INTO emp (job) VALUES (:job_title);  
    ...  
}
```

27.3 Advanced Topic

Embedded Dynamic SQL

Overview

Most of the embedded SQL applications perform the specific operations on GOLDILOCKS. They are to insert, update, delete, retrieve rows and they are specified by using the database language called as SQL. When SQL is directly specified on the embedded SQL source code for this purpose, the precompiler interpretes the SQL, and converts it to an API call available to GOLDILOCKS on the state of knowing all the given SQL and input/output host variables.

However, some applications do not know the SQL in advance when developing the applications. For example, if static SQL is used in an application such as GUI tool when the user wants to query by selecting the operation type, the table name, condition, the user should specify all SQL statement of possible combination in advance. However, it is impossible or it is very inefficient even when it is possible. In this case, if the user generates and executes the SQL statement with an user selectable option, it might be very flexible and efficient. The dynamic SQL is the SQL which is not defined on the source code in advance and is changed at run-time. GOLDILOCKS supports the embedded dynamic SQL feature.

The advantage of embedded dynamic SQL application provides more flexible usage compared to the static SQL, but the disadvantage is that the development of the source code is difficult and it has poor performance compared to the static SQL when performing the same query.

It is recommended to compare the static SQL and the dynamic SQL, then select one of them considering these features carefully when developing applications.

This chapter describes how to develop the embedded dynamic SQL program.

Dynamic SQL Types

The dynamic SQLs are classified according the usage as follows.

Table 27-23 Dynamic SQL type

Method	Description	Support
Method 1	It is a non-query and a host variable does not exist.	O
Method 2	It is a non-query and a host variable may know the number and type.	O
Method 3	It is a query and a host variable may know the number and type.	O
Method 4	It is a query, and the existence of host variable, the number and type are unknown.	X

Currently, GOLDILOCKS supports until the method 3.

Method 1

It is the simplest form of the dynamic SQL, and it is a non-query and can be used when a host variable does not exist. Typically, it is used for the DDL or for the DML in which the host variable does not exist.

- EXECUTE IMMEDIATE

The SQL statement can be immediately executed because the method1 is a non-query and it does not have the host variable at the same time. The syntax of the immediate execution of SQL is as follows.

```
EXEC SQL EXECUTE IMMEDIATE { :host_variable | <string_literal> };
<string_literal> ::=
    ' <sql_statement> '
  | " <sql_statement> "
  | <sql_statement>
  ;
```

The method 1 is used as follows.

```
sprintf(sSqlStmt, "CREATE TABLE EMP_RND (\n"
        "EMPNO NUMBER(4) CONSTRAINT PK_EMP_RND PRIMARY KEY,\n"
        "ENAME VARCHAR2(10),\n"
        "JOB VARCHAR2(9),\n"
        "SAL NUMBER(7,2),\n"
        "DEPTNO NUMBER(2) )\n" );
EXEC SQL EXECUTE IMMEDIATE :sSqlStmt;
if(sqlca.sqlcode != 0)
{
    goto fail_exit;
}
sprintf(sSqlStmt, "INSERT INTO EMP_RND\n"
        "SELECT *\n"
        "FROM EMP\n"
        "WHERE JOB = 'RND'\n" );
EXEC SQL EXECUTE IMMEDIATE :sSqlStmt;
if(sqlca.sqlcode != 0)
{
    goto fail_exit;
}
```

Method 2

The method 2 is used for the non-query with an existence of input host variable. The number of input host variables and the data type should be known, and it is performed through preparation step and the execution step.

- Prepare

In the prepare step, the SQL statement is analyzed, and the name is given to this statement. The syntax of prepare is as follows.

```
EXEC SQL PREPARE <statement_name> FROM { :host_variable | <string_literal> };
<string_literal> ::=
    ' <sql_statement> '
  | " <sql_statement> "
  | <sql_statement>
  ;
```

<statement_name> is an identifier notifying to the precompiler. It does not require a separate type or any declaration of a variable because it is not the host variable.

- Execute

The analyzed statement is executed in the execute step. The syntax of execute statement is as follows.

```
EXEC SQL EXECUTE <statement_name> [ USING <host_variable_list> ];
<host_variable_list> ::= <host_variable_entry> [ , <host_variable_list> ];
<host_variable_entry> ::= :host_variable [ [ INDICATOR ] :host_indicator ] ;
```

If an input host variable exist, USING clause is used. If the host variable does not exist, USING clause is omitted. It is bound to the host variable of the prepared SQL statement according to the sequence of host variables in USING clause.

When the same SQL statements are repeatedly executed in method 2, execute may be repeatedly performed after performing prepare only once. The prepared statement is valid in the current source code until another SQL statement is prepared with the same statement name or it is disconnected.

Method 3

The method 3 is an extended form of the method 2 to support the query. The statements of declare, open, fetch, close are added for the cursor because generally a statement is analyzed in the query prepare process and the cursor should be handled for the query.

- Prepare

The prepare step analyzes the SQL statement like as the method 2, and gives the name to the statement. The syntax of prepare is as follows.

```
EXEC SQL PREPARE <statement_name> FROM { :host_variable | <string_literal> };
<string_literal> ::=
    ' <sql_statement> '
  | " <sql_statement> "
  | <sql_statement>
  ;
```

<statement_name> is an identifier notifying to the precompiler. It does not require a separate type or any declaration of a variable because it is not the host variable.

- Declare cursor

Declare statement declares the cursor for the prepared statement. When declaring the cursor, the cursor property which is as same as the standing cursor can be used. The syntax is as follows.

```
EXEC SQL <dynamic declare cursor>;

<dynamic declare cursor> ::=
    DECLARE <cursor_name> <cursor properties> { FOR | IS } <statement_name>
    ;

<cursor properties> ::=
    [ <cursor sensitivity> ] [ <cursor scrollability> ] CURSOR [ <cursor holdability> ]
  | [ <odbc cursor type> ] CURSOR [ <cursor holdability> ]
  ;

<cursor sensitivity> ::=
    INSENSITIVE
  | SENSITIVE
  | ASENSITIVE
  ;

<cursor scrollability> ::=
    NO SCROLL
  | SCROLL
  ;

<cursor holdability> ::=
    WITH HOLD
  | WITHOUT HOLD
  ;

<odbc cursor type> ::=
    STATIC
```

```
| KEYSET
;
```

The meaning and used name of <cursor properties> is as same as the standing cursor. For more information, refer to **Cursor Property**.

<statement_name> is the name specified in PREPARE statement. <cursor name> and <statement name> are the identifiers notifying to the precompiler. It does not require a separate type or any declaration of a variable because it is not the host variable.

- Open cursor

It opens the cursor. It is generally same with the **Open Cursor** of the standing cursor, but there is a significant and typical difference in opening the dynamic cursor. The host variable is determined depending on the declared SQL statement because the dynamic cursor updates and uses the SQL statement freely at the run-time. Therefore, when opening the dynamic cursor, it transfers the host variable by using the USING clause at the time of opening.

Open syntax of dynamic cursor is as follows.

```
EXEC SQL <dynamic cursor open>;

<dynamic cursor open> ::=
    OPEN <cursor_name> [ USING <host_variable_list> ]
    ;

<host_variable_list> ::= <host_variable_entry> [ , <host_variable_list> ];
<host_variable_entry> ::= :host_variable [ [ INDICATOR ] :host_indicator ];
```

- Fetch cursor

It fetches from the cursor. Fetching dynamic cursor is as same as **fetching standing cursor**.

- Close cursor

It closes the cursor. Closing dynamic cursor is as same as **closing standing cursor**.

Example Program

The following is a sample program of using the dynamic method 1, 2, 3.

```
/*
 * dyn2.gc
 * : dynamic method 1
```

```

* : dynamic method 2
* : dynamic method 3
*
*/
#include <stdio.h>
#include <stdlib.h>
#include <string.h>
EXEC SQL INCLUDE SQLCA;

#define SUCCESS 0
#define FAILURE -1
#define PRINT_SQL_ERROR(aMsg) \
    { \
        printf("\n"); \
        printf(aMsg); \
        printf("\nSQLCODE : %d\nSQLSTATE : %s\nERROR MSG : %s\n", \
            sqlca.sqlcode, \
            SQLSTATE, \
            sqlca.sqlerrm.sqlerrmc ); \
    }

EXEC SQL BEGIN DECLARE SECTION;
typedef struct Record
{
    int          mEmpNo;
    varchar      mENAME[20 + 1];
    char         mJob[20];
    char         mSalary[10];
} Record;
EXEC SQL END DECLARE SECTION;

int Connect(char *aHostInfo, char *aUserID, char *sPassword);
int CreateEmpTempTable();
int DropEmpTempTable();
int UpdateSalary(char *aJob, int aBound, double aRatio);

int main(int argc, char **argv)
{
    EXEC SQL BEGIN DECLARE SECTION;
    EXEC SQL END DECLARE SECTION;
    printf("Connect GOLDILOCKS ...\n");

```

```

if(Connect("DSN=GOLDILOCKS", "test", "test") != SUCCESS)
{
    goto fail_exit;
}

if(CreateEmpTempTable() != SUCCESS)
{
    goto fail_exit;
}

```

- Print RND employee increase 20% salary where salary < 2000

```

printf("print RND employee increase 20% salary where salary < 2000\n");
UpdateSalary( "RND", 2000, 1.2 );
printf("\n\n");

```

- Print SUPPORT employee increase 10% salary where salary < 3000

```

printf("print SUPPORT employee increase 10% salary where salary < 3000\n");
UpdateSalary( "SUPPORT", 3000, 1.1 );
printf("\n\n");

if(DropEmpTempTable() != SUCCESS)
{
    goto fail_exit;
}

printf("Disconnect GOLDILOCKS ...\n");
EXEC SQL COMMIT WORK RELEASE;
if(sqlca.sqlcode != 0)
{
    PRINT_SQL_ERROR("[ERROR] SQL ERROR -");
    goto fail_exit;
}

printf("SUCCESS\n");
printf("#####\n");

return 0;

fail_exit:

```



```

printf("\n\nFAILURE\n");
printf("#####\n\n");
EXEC SQL ROLLBACK WORK RELEASE;

return 0;
}

int Connect(char *aHostInfo, char *aUserID, char *sPassword)
{
EXEC SQL BEGIN DECLARE SECTION;
VARCHAR sUId[80];
VARCHAR sPwD[20];
VARCHAR sConnStr[1024];
EXEC SQL END DECLARE SECTION;

```

- Log on GOLDILOCKS

```

strcpy((char *)sUId.arr, aUserID);
sUId.len = (short)strlen((char *)sUId.arr);
strcpy((char *)sPwD.arr, sPassword);
sPwD.len = (short)strlen((char *)sPwD.arr);
strcpy((char *)sConnStr.arr, aHostInfo);
sConnStr.len = (short)strlen((char *)sConnStr.arr);

```

- DB connection

```

EXEC SQL CONNECT :sUId IDENTIFIED BY :sPwD USING :sConnStr;
if(sqlca.sqlcode != 0)
{
goto fail_exit;
}

return SUCCESS;

fail_exit:

PRINT_SQL_ERROR("[ERROR] Connection Failure!");

return FAILURE;
}

```

- Create table

```
int CreateEmpTempTable()
{
    EXEC SQL BEGIN DECLARE SECTION;
    char   sSqlStmt[8192];
    EXEC SQL END DECLARE SECTION;
    sprintf(sSqlStmt, "DROP TABLE IF EXISTS EMP_RND" );
    EXEC SQL EXECUTE IMMEDIATE :sSqlStmt;
    if(sqlca.sqlcode != 0)
    {
        goto fail_exit;
    }

    sprintf(sSqlStmt, "CREATE TABLE EMP_RND (\n"
        "EMPNO NUMBER(4) CONSTRAINT PK_EMP_RND PRIMARY KEY,\n"
        "ENAME VARCHAR2(10),\n"
        "JOB VARCHAR2(9),\n"
        "SAL NUMBER(7,2),\n"
        "DEPTNO NUMBER(2) )\n" );
    EXEC SQL EXECUTE IMMEDIATE :sSqlStmt;
    if(sqlca.sqlcode != 0)
    {
        goto fail_exit;
    }

    sprintf(sSqlStmt, "INSERT INTO EMP_RND\n"
        "SELECT *\n"
        "FROM   EMP\n"
        "WHERE  JOB = 'RND'\n" );
    EXEC SQL EXECUTE IMMEDIATE :sSqlStmt;
    if(sqlca.sqlcode != 0)
    {
        goto fail_exit;
    }

    sprintf(sSqlStmt, "DROP TABLE IF EXISTS EMP_SUPPORT" );
    EXEC SQL EXECUTE IMMEDIATE :sSqlStmt;
    if(sqlca.sqlcode != 0)
    {
        goto fail_exit;
    }
}
```

```

sprintf(sSqlStmt, "CREATE TABLE EMP_SUPPORT (\n"
        "EMPNO NUMBER(4) CONSTRAINT PK_EMP_SUPPORT PRIMARY KEY,\n"
        "ENAME VARCHAR2(10),\n"
        "JOB VARCHAR2(9),\n"
        "SAL NUMBER(7,2),\n"
        "DEPTNO NUMBER(2) )\n" );
EXEC SQL EXECUTE IMMEDIATE :sSqlStmt;
if(sqlca.sqlcode != 0)
{
    goto fail_exit;
}

sprintf(sSqlStmt, "INSERT INTO EMP_SUPPORT\n"
        "SELECT *\n"
        "FROM EMP\n"
        "WHERE JOB = 'SUPPORT'\n" );
EXEC SQL EXECUTE IMMEDIATE :sSqlStmt;
if(sqlca.sqlcode != 0)
{
    goto fail_exit;
}

EXEC SQL COMMIT WORK;
if(sqlca.sqlcode != 0)
{
    goto fail_exit;
}

return SUCCESS;

fail_exit:

PRINT_SQL_ERROR("[ERROR] SQL ERROR -");
EXEC SQL ROLLBACK WORK;

return FAILURE;
}

```

- Drop table

```
int DropEmpTempTable()
{
    EXEC SQL DROP TABLE EMP_RND;
    if(sqlca.sqlcode != 0)
    {
        goto fail_exit;
    }

    EXEC SQL DROP TABLE EMP_SUPPORT;
    if(sqlca.sqlcode != 0)
    {
        goto fail_exit;
    }

    EXEC SQL COMMIT WORK;
    if(sqlca.sqlcode != 0)
    {
        goto fail_exit;
    }

    return SUCCESS;

fail_exit:

    PRINT_SQL_ERROR("[ERROR] SQL ERROR -");
    EXEC SQL ROLLBACK WORK;

    return FAILURE;
}

int UpdateSalary(char *aJob, int aBound, double aRatio)
{
    EXEC SQL BEGIN DECLARE SECTION;
    Record      sRecord;
    char        sSelectSql[128];
    char        sUpdateSql[128];
    int         sBound = aBound;
    double      sRatio = aRatio;
    EXEC SQL END DECLARE SECTION;

    int sRecordCount = 0;
```

```
int i;
int sIsOpenCur = 0;

sprintf( sSelectSql, "SELECT EMPNO, ENAME, JOB, SAL FROM EMP_%s WHERE sal < :v1 FOR
UPDATE", aJob );
sprintf( sUpdateSql, "UPDATE EMP_%s SET sal = sal * :v1 WHERE CURRENT OF DYN_CUR", aJob);

EXEC SQL PREPARE SELECT_STMT FROM :sSelectSql;
if(sqlca.sqlcode != 0)
{
    goto fail_exit;
}

EXEC SQL DECLARE DYN_CUR KEYSET CURSOR FOR SELECT_STMT;
EXEC SQL OPEN DYN_CUR USING :sBound;
if(sqlca.sqlcode != 0)
{
    goto fail_exit;
}
sIsOpenCur = 1;

EXEC SQL PREPARE UPDATE_STMT FROM :sUpdateSql;
if(sqlca.sqlcode != 0)
{
    goto fail_exit;
}

while( 1 )
{
    EXEC SQL
        FETCH NEXT DYN_CUR
        INTO :sRecord;
    if(sqlca.sqlcode == SQL_NO_DATA)
    {
        break;
    }
    else if(sqlca.sqlcode != 0)
    {
        goto fail_exit;
    }
}
```

```

EXEC SQL EXECUTE UPDATE_STMT USING :sRatio;
if(sqlca.sqlcode != 0)
{
    goto fail_exit;
}
}

sIsOpenCur = 0;
EXEC SQL CLOSE DYN_CUR;
if(sqlca.sqlcode != 0)
{
    goto fail_exit;
}

sprintf( sSelectSql, "SELECT EMPNO, ENAME, JOB, SAL FROM EMP_%s ORDER BY SAL DESC", aJob
);
EXEC SQL PREPARE SELECT_STMT FROM :sSelectSql;
if(sqlca.sqlcode != 0)
{
    goto fail_exit;
}

EXEC SQL OPEN DYN_CUR;
if(sqlca.sqlcode != 0)
{
    goto fail_exit;
}
sIsOpenCur = 1;

printf("%s salary list\n", aJob);
sRecordCount = 0;
printf(" EMPNO      ENAME                JOB      SALARY\n");
printf("===== \n");
while( 1 )
{
    EXEC SQL
        FETCH DYN_CUR
        INTO :sRecord;
    if(sqlca.sqlcode == SQL_NO_DATA)
    {
        break;
    }
}

```

```

    }
    else if(sqlca.sqlcode != 0)
    {
        PRINT_SQL_ERROR("[ERROR] SQL ERROR -");
        goto fail_exit;
    }

    for(i = 0; i < sqlca.sqlerrd[2]; i ++)
    {
        sRecordCount ++;
        printf("%6d %20s %10s %10s\n",
            sRecord.mEmpNo,
            sRecord.mENAME.arr,
            sRecord.mJob,
            sRecord.mSalary);
    }
}

printf("=====  

printf("Record Count = %d\n", sRecordCount);
printf("=====  

sIsOpenCur = 0;
EXEC SQL CLOSE DYN_CUR;
if(sqlca.sqlcode != 0)
{
    goto fail_exit;
}

return SUCCESS;

fail_exit:

PRINT_SQL_ERROR("[ERROR] SQL ERROR -");
if(sIsOpenCur == 1)
{
    EXEC SQL CLOSE DYN_CUR;
}
return FAILURE;
}

```

Multithread Application

The multithreaded application is an application including multiple execution units in a single process. The multithreaded application can process multiple tasks such as running multiple applications at the same time in parallel, and it has the advantage of being able to share the same address scope because it is a single process.

Sharing the same address scope means sharing the global variables and static variables. When accessing these variables, the concurrency control for each thread should be considered. Therefore, the application should be developed very carefully.

GOLDILOCKS supports the run-time context. The run-time context has a slight difference between Direct Attach (D/A) mode and Client/Server (C/S) mode. The next chapter describes the run-time context and the guideline for developing the multithreaded application.

Run-time Context

The run-time context in an embedded SQL of GOLDILOCKS is used for the purpose of managing the connection from the application to GOLDILOCKS. The relationship between the run-time context and connection is 1:1, and the run-time context is regarded as the connection itself.

GOLDILOCKS structurally allows only a single connection in a thread in D/A mode. The multithreaded application is required for multiple connections. However, it is the connection with the server via network in C/S mode, so a single thread may have multiple connections.

Direct Attach (D/A) Mode

A single thread has only a single connection in D/A mode. Therefore, n threads are required when developing an application with n connections.

Figure 2 In case when each thread has its own connection in D/A mode

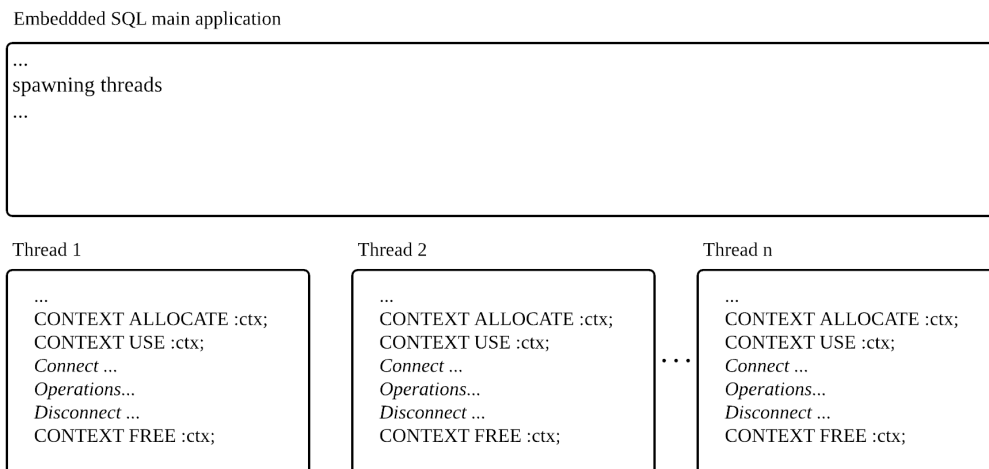

Client/Server (C/S) Mode

An extra restriction for the connection does not exist when operating in C/S mode. A single thread may have multiple connections or multiple threads may share a single connection. N threads can share m connections.

Figure 3 In case when multiple threads share a single connection

Embedded SQL main application

```
...
CONTEXT ALLOCATE :ctx;
CONTEXT USE :ctx;
Connect ...
spawning threads
wait for threads
Disconnect ...
CONTEXT FREE :ctx;
...
```

Thread 1

```
...
CONTEXT USE :ctx;
Operations ...
...
```

Thread 2

```
...
CONTEXT USE :ctx;
Operations ...
...
```

...

Thread n

```
...
CONTEXT USE :ctx;
Operations ...
...
```

Figure 4 In case when a single thread has multiple connections

Embedded SQL main application

```
...
CONTEXT ALLOCATE :ctx1;
CONTEXT ALLOCATE :ctx2;
CONTEXT ALLOCATE :ctx3;

CONTEXT USE :ctx1;
Connect ...
CONTEXT USE :ctx2;
Connect ...
CONTEXT USE :ctx3;
Connect ...

CONTEXT USE :ctx1;
SQL operations ...
CONTEXT USE :ctx2;
SQL operations ...
CONTEXT USE :ctx3;
SQL operations ...

CONTEXT USE :ctx1;
Disconnect ...
CONTEXT USE :ctx2;
Disconnect ...
CONTEXT USE :ctx3;
Disconnect ...

CONTEXT FREE :ctx1;
CONTEXT FREE :ctx2;
CONTEXT FREE :ctx3;
...
```

Guidelines

The followings should be considered to develop the multithreaded application.

- The SQLCA variable should be declared thread-safely. It is recommended to declare as a stack variable in each thread, and to refer to the example program of the next chapter.
- The static variables or the global variables are shared because the multithread has the same address space in a single process. The concurrency control should be considered when using these variables.
- A single run-time context should not be allowed to be used at the same time in multiple threads. The concurrency control of run-time context should also be considered.

Example Program

The following is a sample program of a multithreaded application.

```

/*
 * thread1.gc
 *
 */
#include <stdio.h>
#include <stdlib.h>
#include <string.h>
#include <pthread.h>

EXEC SQL INCLUDE SQLCA;

#define SUCCESS 0
#define FAILURE -1

#define PRINT_SQL_ERROR(aMsg) \
{ \
    printf("\n"); \
    printf(aMsg); \
    printf("\nSQLCODE : %d\nSQLSTATE : %s\nERROR MSG : %s\n", \
        sqlca.sqlcode, \
        SQLSTATE, \
        sqlca.sqlerrm.sqlerrmc ); \
}

int Connect(sql_context aCtx, char *aHostInfo, char *aUserID, char *sPassword);
int CreateEmpTempTable();
int DropEmpTempTable();

```

```

void *clientThread(void *args);

typedef struct thread_param
{
    int    mNo;
    char  *mJobName;
} thread_param;

#define THREAD_COUNT    2
char gJobName[THREAD_COUNT][20]= {
    "RND",
    "SUPPORT"
};

int main(int argc, char **argv)
{
    EXEC SQL BEGIN DECLARE SECTION;
    int          sEmpNo;
    varchar      sEName[20 + 1];
    char         sJob[20];
    long         sSalary;
    EXEC SQL END DECLARE SECTION;
    int          sRecordCount = 0;
    pthread_t    thread_id[THREAD_COUNT];
    thread_param param[THREAD_COUNT];
    int          i;

    printf("Connect GOLDILOCKS ...\n");
    if(Connect(NULL, "DSN=GOLDILOCKS", "test", "test") != SUCCESS)
    {
        goto fail_exit;
    }

    if(CreateEmpTempTable() != SUCCESS)
    {
        goto fail_exit;
    }
}

```

- Create client thread

```

for( i = 0; i < THREAD_COUNT; i ++ )
{
    param[i].mNo = i;
    param[i].mJobName = gJobName[i];
    if( pthread_create(&thread_id[i],
                      NULL,
                      clientThread,
                      &param[i]) != 0 )
    {
        printf( "Can't create thread %d!\n", i );
    }
    else
    {
        printf( "Create thread %d!\n", i );
    }
}

for( i = 0; i < THREAD_COUNT; i ++ )
{
    if( pthread_join(thread_id[i],
                    NULL) != 0 )
    {
        printf( "Error when waiting for thread %d to terminate!\n", i );
    }
    else
    {
        printf( "Stopped thread %d!\n", i );
    }
}

```

- Retrieve employee

EXEC SQL

```

DECLARE EMP_CUR CURSOR FOR
SELECT empno, ename, job, sal
FROM EMP_TEMP
ORDER BY empno;

EXEC SQL OPEN EMP_CUR;
if(sqlca.sqlcode != 0)
{

```

```

    PRINT_SQL_ERROR("[ERROR] SQL ERROR -");
    goto fail_exit;
}

printf(" EMPNO      ENAME                JOB      SALARY\n");
printf("===== \n");
while( 1 )
{
    EXEC SQL
        FETCH EMP_CUR
        INTO :sEmpNo, :sENAME, :sJob, :sSalary;
    if(sqlca.sqlcode == SQL_NO_DATA)
    {
        break;
    }
    else if(sqlca.sqlcode != 0)
    {
        PRINT_SQL_ERROR("[ERROR] SQL ERROR -");
        goto fail_exit;
    }

    sRecordCount ++;

    printf("%6d %20s %10s %8ld\n",
        sEmpNo, sENAME.arr, sJob, sSalary);
}

printf("===== \n");
printf("Record Count = %d\n", sRecordCount);
printf("===== \n");

EXEC SQL CLOSE EMP_CUR;
if(sqlca.sqlcode != 0)
{
    PRINT_SQL_ERROR("[ERROR] SQL ERROR -");
    goto fail_exit;
}

if(DropEmpTempTable() != SUCCESS)
{
    goto fail_exit;
}

```

```

    }

    EXEC SQL COMMIT WORK RELEASE;
    if(sqlca.sqlcode != 0)
    {
        PRINT_SQL_ERROR("[ERROR] SQL ERROR -");
        goto fail_exit;
    }

    printf("SUCCESS\n");
    printf("#####\n");

    return 0;

fail_exit:

    printf("FAILURE\n");
    printf("#####\n\n");
    EXEC SQL ROLLBACK WORK RELEASE;

    return 0;
}

int Connect(sql_context aCtx, char *aHostInfo, char *aUserID, char *sPassword)
{
    EXEC SQL BEGIN DECLARE SECTION;
    VARCHAR sUId[80];
    VARCHAR sPwd[20];
    VARCHAR sConnStr[1024];
    EXEC SQL END DECLARE SECTION;
    struct sqlca sqlca;

```

- Log on GOLDILOCKS

```

strcpy((char *)sUId.arr, aUserID);
sUId.len = (short)strlen((char *)sUId.arr);
strcpy((char *)sPwd.arr, sPassword);
sPwd.len = (short)strlen((char *)sPwd.arr);
strcpy((char *)sConnStr.arr, aHostInfo);
sConnStr.len = (short)strlen((char *)sConnStr.arr);

```

- DB connection

```

if( aCtx != NULL )
{
    EXEC SQL CONTEXT USE :aCtx;
    EXEC SQL CONNECT :sUid IDENTIFIED BY :sPwd USING :sConnStr;
}
else
{
    EXEC SQL CONTEXT USE DEFAULT;
    EXEC SQL CONNECT :sUid IDENTIFIED BY :sPwd USING :sConnStr;
}
if(sqlca.sqlcode != 0)
{
    goto fail_exit;
}

return SUCCESS;

fail_exit:

PRINT_SQL_ERROR("[ERROR] Connection Failure!");

return FAILURE;
}

```

- DB disconnection

```

int Disconnect(sql_context aCtx)
{
    struct sqlca sqlca;
    if( aCtx != NULL )
    {
        EXEC SQL CONTEXT USE :aCtx;
        EXEC SQL DISCONNECT;
    }
    else
    {
        EXEC SQL CONTEXT USE DEFAULT;
        EXEC SQL DISCONNECT;
    }
}

```

```

    if(sqlca.sqlcode != 0)
    {
        goto fail_exit;
    }

    return SUCCESS;

fail_exit:

    PRINT_SQL_ERROR("[ERROR] Connection Failure!");

    return FAILURE;
}

```

- Create table

```

int CreateEmpTempTable()
{
    EXEC SQL DROP TABLE IF EXISTS EMP_TEMP;
    if(sqlca.sqlcode != 0)
    {
        goto fail_exit;
    }

    EXEC SQL
        CREATE TABLE EMP_TEMP (
            EMPNO NUMBER(4) CONSTRAINT PK_EMP_TEMP PRIMARY KEY,
            ENAME VARCHAR2(10),
            JOB VARCHAR2(9),
            SAL NUMBER(7,2),
            DEPTNO NUMBER(2) );
    if(sqlca.sqlcode != 0)
    {
        goto fail_exit;
    }

    EXEC SQL COMMIT WORK;
    if(sqlca.sqlcode != 0)
    {
        goto fail_exit;
    }
}

```



```

    return SUCCESS;

fail_exit:

    PRINT_SQL_ERROR("[ERROR] SQL ERROR -");
    EXEC SQL ROLLBACK WORK;

    return FAILURE;
}

```

- Drop table

```

int DropEmpTempTable()
{
    EXEC SQL DROP TABLE EMP_TEMP;
    if(sqlca.sqlcode != 0)
    {
        goto fail_exit;
    }

    EXEC SQL COMMIT WORK;
    if(sqlca.sqlcode != 0)
    {
        goto fail_exit;
    }

    return SUCCESS;

fail_exit:

    PRINT_SQL_ERROR("[ERROR] SQL ERROR -");
    EXEC SQL ROLLBACK WORK;

    return FAILURE;
}

void *clientThread(void *args)
{
    EXEC SQL BEGIN DECLARE SECTION;
    SQL_CONTEXT    my_context;
    char           job_name[20 + 1];
}

```

```
EXEC SQL END DECLARE SECTION;
int          state = 0;
thread_param *param = (thread_param *)args;

EXEC SQL CONTEXT ALLOCATE :my_context;
state = 1;

EXEC SQL CONTEXT USE :my_context;
if(Connect(my_context, "DSN=GOLDILOCKS", "test", "test") != SUCCESS)
{
    goto fail_exit;
}
state = 2;

strcpy( job_name, param->mJobName );

EXEC SQL
    INSERT INTO EMP_TEMP
    SELECT *
    FROM EMP
    WHERE JOB = :job_name;
if(sqlca.sqlcode != 0)
{
    goto fail_exit;
}

EXEC SQL COMMIT WORK;
if(sqlca.sqlcode != 0)
{
    goto fail_exit;
}
state = 1;
if(Disconnect(my_context) != SUCCESS)
{
    goto fail_exit;
}
state = 0;
EXEC SQL CONTEXT FREE :my_context;
pthread_exit(0);
return NULL;
```

```

fail_exit:

    PRINT_SQL_ERROR("[ERROR] SQL ERROR -");
    switch(state)
    {
        case 2:
            (void)Disconnect(my_context);
        case 1:
            EXEC SQL CONTEXT FREE :my_context;
            break;
        default:
            break;
    }

    pthread_exit(0);
    return NULL;
}

```

C++ Application

Extension of Output Filename

Precompiler (gpec) of GOLDILOCKS generates C code by precompiling the embedded SQL source code. The extension of the output file is .c by default. The general C++ source code has various file extensions depending on the compiler types.

-o option which is the output file specification option of gpec is used to specify the file extension. For example, testfile.gc is converted to testfile.cpp as follows.

```
gpec $(GPEC_OPT) testfile.gc -o testfile.cpp
```

SQLCA_STORAGE_CLASS

When the same symbol is declared as a global variable, the conflict on the symbol is occurred in C++ application. The embedded SQL of GOLDILOCKS has the sqlca variable by default, and the conflict of these variables causes a problem when linking multiple C++ files.

SQLCA_STORAGE_CLASS macro should be defined for all other files except for one file to avoid this problem. For example, if a single application is generated by linking 3 files, SQLCA_STORAGE_CLASS macro is defined for two of three files as follows.

```
#define SQLCA_STORAGE_CLASS extern
EXEC SQL INCLUDE SQLCA;
```

SQLCA_STORAGE_CLASS macro definition should be positioned ahead of the following statement.

```
EXEC SQL INCLUDE SQLCA;
```

XA

Definition of xa_open string

xa_open string includes information for connecting to Resource Manager (RM). For more information, refer to **SQLDriverConnect attributes**.

The following is an example of xa_open string.

```
DSN=GOLDILOCKS;UID=test;PWD=test;CONN_NAME=XA_CONN
```

Using XA in Precompiler

A user can choose one of the followings when using XA in the precompiler.

- Using the default connection
- Using the named connection

Using Default Connection

It uses the connection connected only with the access information in xa_open string.

The following is an example of xa_open string for the default connection.

```
DSN=GOLDILOCKS;UID=test;PWD=test
```

It is described as follows when using the embedded SQL with the default connection.

```
EXEC SQL
    UPDATE Deposit
    Set InterestRates = :value :value_ind
    WHERE AccountNumber = :account_number;
```

Using Named Connection

It uses the connection name together with the connection information in xa_open string. The following is an example of xa_open string for the named connection.

```
DSN=GOLDILOCKS;UID=test;PWD=test;CONN_NAME=XA_CONN
```

The connection name should be specified as follows in an embedded SQL which uses the named connection.

```
EXEC SQL AT XA_CONN
    UPDATE Deposit
    Set InterestRates = :value :value_ind
    WHERE AccountNumber = :account_number;
```

Example Program

- GOLDILOCKS Sample - XA

```
#include <stdio.h>
#include <string.h>
#include <stdlib.h>
```

- Include GOLDILOCKS ODBC header

```
#include <goldilocks.h>
EXEC SQL INCLUDE SQLCA;
#define SUCCESS 0
#define FAILURE -1
#define PRINT_SQL_ERROR(aMsg) \
    { \
        printf("\n"); \
        printf(aMsg); \
        printf("\nSQLCODE : %d\nSQLSTATE : %s\nERROR MSG : %s\n", \
            sqlca.sqlcode, \
            SQLSTATE, \
            sqlca.sqlerrm.sqlerrmc ); \
    }
```

- User-specific definitions

```

#define BUF_LEN 101
#define GOLDILOCKS_SQL_THROW( aLabel )          \
    goto aLabel;
#define GOLDILOCKS_SQL_TRY( aExpression )      \
    do                                          \
    {                                          \
        if( !(SQL_SUCCEEDED( aExpression ) ) ) \
        {                                          \
            goto GOLDILOCKS_FINISH_LABEL;      \
        }                                          \
    } while( 0 )
#define GOLDILOCKS_FINISH                      \
    goto GOLDILOCKS_FINISH_LABEL;            \
GOLDILOCKS_FINISH_LABEL:

```

- Print diagnostic record to console

```

void PrintDiagnosticRecord( SQLSMALLINT aHandleType, SQLHANDLE aHandle )
{
    SQLCHAR      sSQLState[6];
    SQLINTEGER    sNaiveError;
    SQLSMALLINT  sTextLength;
    SQLCHAR      sMessageText[SQL_MAX_MESSAGE_LENGTH];
    SQLSMALLINT  sRecNumber = 1;
    SQLRETURN     sReturn;

```

- SQLGetDiagRec returns the current values which includes an error, warning.

```

while( 1 )
{
    sReturn = SQLGetDiagRec( aHandleType,
                            aHandle,
                            sRecNumber,
                            sSQLState,
                            &sNaiveError,
                            sMessageText,
                            100,
                            &sTextLength );

    if( sReturn == SQL_NO_DATA )
    {
        break;
    }

```

```

    }
    GOLDILOCKS_SQL_TRY( sReturn );
    printf("\n=====\n" );
    printf("SQL_DIAG_SQLSTATE      : %s\n", sSQLState );
    printf("SQL_DIAG_NATIVE          : %d\n", sNaiveError );
    printf("SQL_DIAG_MESSAGE_TEXT : %s\n", sMessageText );
    printf("=====\n" );
    sRecNumber++;
}
return;
GOLDILOCKS_FINISH;
printf("SQLGetDiagRec failure.\n" );
return;
}

```

- Create table

```

int testCreateTable()
{
    EXEC SQL AT XA_CONN
        DROP TABLE IF EXISTS DEPOSIT;
    if(sqlca.sqlcode != 0)
    {
        goto fail_exit;
    }
    EXEC SQL AT XA_CONN
        CREATE TABLE DEPOSIT (
            NAME          VARCHAR(30),
            BALANCE       INTEGER,
            ACCOUNTNUMBER VARCHAR(100),
            ACCOUNTDAY    DATE,
            INTERESTRATES NUMBER(10, 5),
            PHONENUMBER   VARCHAR(30) );
    if(sqlca.sqlcode != 0)
    {
        goto fail_exit;
    }
    EXEC SQL AT XA_CONN COMMIT;
    if(sqlca.sqlcode != 0)
    {
        goto fail_exit;
    }
}

```

```

    }
    return SUCCESS;
fail_exit:
    PRINT_SQL_ERROR("[ERROR] SQL ERROR -");
    EXEC SQL AT XA_CONN ROLLBACK;
    return FAILURE;
}

```

- Drop table

```

int testDropTable()
{
    EXEC SQL AT XA_CONN
        DROP TABLE DEPOSIT;
    if(sqlca.sqlcode != 0)
    {
        goto fail_exit;
    }
    EXEC SQL AT XA_CONN COMMIT;
    if(sqlca.sqlcode != 0)
    {
        goto fail_exit;
    }
    return SUCCESS;
fail_exit:
    PRINT_SQL_ERROR("[ERROR] SQL ERROR -");
    EXEC SQL AT XA_CONN ROLLBACK;
    return FAILURE;
}

```

- Insert function

```

int testInsert( )
{
    EXEC SQL BEGIN DECLARE SECTION;
    char          sName[BUF_LEN];
    int           sNameInd          = 0;
    int           sBalance          = 0;
    int           sBalanceInd       = 0;
    char          sAccountNumber[BUF_LEN];
    int           sAccountNumberInd = 0;
    DATE          sAccountDay;

```



```

int          sAccountDayInd          = 0;
double       sInterestRates          = 0;
int          sInterestRatesInd       = 0;
char         sPhoneNumber[BUF_LEN];
int          sPhoneNumberInd          = 0;
EXEC SQL END DECLARE SECTION;
sNameInd     = sprintf( (char*)sName, BUF_LEN, "sunje" );
sBalance     = 30000000;
sAccountNumberInd = sprintf( (char*)sAccountNumber, BUF_LEN, "9999-99-9999" );
sAccountDay.year = 2009;
sAccountDay.month = 1;
sAccountDay.day = 1;
sAccountDay.hour = 0;
sAccountDay.minute = 0;
sAccountDay.second = 0;
sAccountDay.fraction = 0;
sInterestRates = (double)5.0;
sPhoneNumberInd = sprintf( (char*)sPhoneNumber, BUF_LEN, "010-9999-9999" );
EXEC SQL AT XA_CONN
    INSERT INTO DEPOSIT
    VALUES ( :sName :sNameInd,
             :sBalance :sBalanceInd,
             :sAccountNumber :sAccountNumberInd,
             :sAccountDay :sAccountDayInd,
             :sInterestRates :sInterestRatesInd,
             :sPhoneNumber :sPhoneNumberInd );
if(sqlca.sqlcode != 0)
{
    goto fail_exit;
}

```

- The number of rows affected by INSERT statement

```

printf("\n%d row created.\n\n", sqlca.sqlerrd[2] );
return SUCCESS;
fail_exit:
PRINT_SQL_ERROR("[ERROR] SQL ERROR -");
return FAILURE;
}

```

- Update function

```

int testUpdate( )
{
    EXEC SQL BEGIN DECLARE SECTION;
    char    sCondition[BUF_LEN];
    int     sConditionInd    = 0;
    double  sValue          = 0;
    int     sValueInd       = 0;
    EXEC SQL END DECLARE SECTION;
    sValue   = (SQLREAL)6.0;
    sConditionInd = snprintf( (char*)sCondition,
                             BUF_LEN,
                             "9999-99-9999" );

    EXEC SQL AT XA_CONN
        UPDATE Deposit
        Set InterestRates = :sValue :sValueInd
        WHERE AccountNumber = :sCondition :sConditionInd;
    if(sqlca.sqlcode != 0)
    {
        goto fail_exit;
    }
}

```

- The number of rows affected by UPDATE statement

```

printf("\n%d row updated.\n\n", sqlca.sqlerrd[2] );
    return SUCCESS;
fail_exit:
    PRINT_SQL_ERROR("[ERROR] SQL ERROR -");
    return FAILURE;
}

```

- Select function

```

int testSelect( )
{
    EXEC SQL BEGIN DECLARE SECTION;
    char    sName[BUF_LEN];
    int     sNameInd        = 0;
    int     sBalance        = 0;
    int     sBalanceInd     = 0;
    char    sAccountNumber[BUF_LEN];
    int     sAccountNumberInd = 0;
}

```

```

DATE          sAccountDay;
int           sAccountDayInd          = 0;
double       sInterestRates          = 0;
int          sInterestRatesInd       = 0;
char         sPhoneNumber[BUF_LEN];
int          sPhoneNumberInd          = 0;
EXEC SQL END DECLARE SECTION;
int          sCount                   = 0;
int          sIsOpen                  = 0;
EXEC SQL DECLARE CUR1 CURSOR FOR
    SELECT NAME, BALANCE, ACCOUNTNUMBER, ACCOUNTDAY, INTERESTRATES, PHONENUMBER
    FROM DEPOSIT;
EXEC SQL AT XA_CONN
    OPEN CUR1;
if( sqlca.sqlcode != 0 )
{
    goto fail_exit;
}
sIsOpen = 1;
printf( "=====\n" );
while( 1 )
{
    EXEC SQL AT XA_CONN
        FETCH CUR1 INTO
            :sName :sNameInd,
            :sBalance :sBalanceInd,
            :sAccountNumber :sAccountNumberInd,
            :sAccountDay :sAccountDayInd,
            :sInterestRates :sInterestRatesInd,
            :sPhoneNumber :sPhoneNumberInd;
    if( sqlca.sqlcode == SQL_NO_DATA )
    {
        break;
    }
    else if( sqlca.sqlcode != 0 )
    {
        goto fail_exit;
    }
    printf( "NAME          : " );
    if( sNameInd == -1 )
    {

```

```
        printf( "(null)" );
    }
    else
    {
        printf( "%s", sName );
    }
    printf( "\n" );
    printf( "BALANCE      : " );
    if( sBalanceInd == -1 )
    {
        printf( "(null)" );
    }
    else
    {
        printf( "%d", sBalance );
    }
    printf( "\n" );
    printf( "ACCOUNTNUMBER : " );
    if( sAccountNumberInd == -1 )
    {
        printf( "(null)" );
    }
    else
    {
        printf( "%s", sAccountNumber );
    }
    printf( "\n" );
    printf( "ACCOUNTDAY      : " );
    if( sAccountDayInd == -1 )
    {
        printf( "(null)" );
    }
    else
    {
        printf( "%4d-%02d-%02d", sAccountDay.year, sAccountDay.month, sAccountDay.day);
    }
    printf( "\n" );
    printf( "INTERESTRATES : " );
    if( sInterestRatesInd == -1 )
    {
        printf( "(null)" );
    }
}
```

```

    }
    else
    {
        printf( "%lf", sInterestRates );
    }
    printf( "\n" );
    printf( "PHONENUMBER   : " );
    if( sPhoneNumberInd == -1 )
    {
        printf( "(null)" );
    }
    else
    {
        printf( "%s", sPhoneNumber );
    }
    printf( "\n" );
    printf( "-----\n" );
    sCount ++;
}
printf( "=====\n" );
printf( "\n%d rows selected.\n\n", sCount );
sIsOpen = 0;
EXEC SQL AT XA_CONN
    CLOSE CUR1;
if( sqlca.sqlcode != 0 )
{
    goto fail_exit;
}
return SUCCESS;
fail_exit:
PRINT_SQL_ERROR("[ERROR] SQL ERROR -");
if( sIsOpen == 1 )
{
    EXEC SQL AT XA_CONN
        CLOSE CUR1;
}
return FAILURE;
}

```

- Delete function

- SQLSetEnvAttr sets attributes which controls aspects of environments.

```
GOLDILOCKS_SQL_TRY( SQLSetEnvAttr( sEnv,
                                SQL_ATTR_ODBC_VERSION,
                                (SQLPOINTER)SQL_OV_ODBC3,
                                0 ) );
    if( (sXaSwitch->xa_open_entry)( "DSN=GOLDILOCKS;UID=test;PWD=test;CONN_NAME=XA_CONN", 0,
TMNOFLAGS ) != XA_OK )
    {
        GOLDILOCKS_SQL_THROW( GOLDILOCKS_FINISH_LABEL );
    }
    sState = 2;
    sXid.formatID = 0;
    sXid.gtrid_length = 2;
    sXid.bqual_length = 1;
    memcpy( sXid.data, "100", sXid.gtrid_length + sXid.bqual_length );
```

- Create table

```
if( testCreateTable() != SUCCESS )
    {
        GOLDILOCKS_SQL_THROW( GOLDILOCKS_FINISH_LABEL );
    }
    sState = 3;
    if( (sXaSwitch->xa_start_entry)( &sXid, 0, TMNOFLAGS ) != XA_OK )
    {
        GOLDILOCKS_SQL_THROW( GOLDILOCKS_FINISH_LABEL );
    }
    sState = 4;
```

- Insert row

```
if( testInsert() != SUCCESS )
    {
        GOLDILOCKS_SQL_THROW( GOLDILOCKS_FINISH_LABEL );
    }
```

- Update row

```
if( testUpdate() != SUCCESS )
    {
        GOLDILOCKS_SQL_THROW( GOLDILOCKS_FINISH_LABEL );
    }
```

```
    }
```

- Select row

```
if( testSelect() != SUCCESS )
{
    GOLDDILOCKS_SQL_THROW( GOLDDILOCKS_FINISH_LABEL );
}
```

- Delete row

```
if( testDelete() != SUCCESS )
{
    GOLDDILOCKS_SQL_THROW( GOLDDILOCKS_FINISH_LABEL );
}
sState = 3;
if( (sXaSwitch->xa_end_entry)( &sXid, 0, TMSUCCESS ) != XA_OK )
{
    GOLDDILOCKS_SQL_THROW( GOLDDILOCKS_FINISH_LABEL );
}
if( (sXaSwitch->xa_prepare_entry)( &sXid, 0, TMNOFLAGS ) != XA_OK )
{
    GOLDDILOCKS_SQL_THROW( GOLDDILOCKS_FINISH_LABEL );
}
if( (sXaSwitch->xa_commit_entry)( &sXid, 0, TMNOFLAGS ) != XA_OK )
{
    GOLDDILOCKS_SQL_THROW( GOLDDILOCKS_FINISH_LABEL );
}
sState = 2;
```

- Drop table

```
if( testDropTable() != SUCCESS )
{
    GOLDDILOCKS_SQL_THROW( GOLDDILOCKS_FINISH_LABEL );
}
sState = 1;
if( (sXaSwitch->xa_close_entry)( "", 0, TMNOFLAGS ) != XA_OK )
{
    GOLDDILOCKS_SQL_THROW( GOLDDILOCKS_FINISH_LABEL );
}
```

- SQLFreeHandleEnv releases resources related to the environment.

```
sState = 0;
GOLDILOCKS_SQL_TRY( SQLFreeHandle( SQL_HANDLE_ENV,
                                   sEnv ) );

sEnv = NULL;
return EXIT_SUCCESS;
GOLDILOCKS_FINISH;
if( sEnv != NULL )
{
    PrintDiagnosticRecord( SQL_HANDLE_ENV, sEnv );
}
switch( sState )
{
    case 4:
        (void)(sXaSwitch->xa_end_entry)( &sXid, 0, TMSUCCESS );
        (void)(sXaSwitch->xa_prepare_entry)( &sXid, 0, TMNOFLAGS );
        (void)(sXaSwitch->xa_commit_entry)( &sXid, 0, TMNOFLAGS );
    case 3:
        (void)testDropTable();
    case 2:
        (void)(sXaSwitch->xa_close_entry)( "", 0, TMNOFLAGS );
    case 1:
        (void)SQLFreeHandle( SQL_HANDLE_ENV, sEnv );
        sEnv = NULL;
    default:
        break;
}
return EXIT_FAILURE;
}
```

27.4 Embedded SQL Reference

This chapter describes the SQL statements which are available only in the embedded SQL applications of GOLDILOCKS. The embedded SQL statements on the source code should have the following syntax.

```

<statement> ::= EXEC SQL <exec sql statement>;
<exec sql statement> ::=
    <embedded SQL statement>
  | <embedded get group_id statement>
  | <embedded specific statement>
  ;

<embedded SQL statement> ::=
    [ AT <db_name> ] [ ATOMIC ] [ FOR <iteration_count> ] <sql statement>
  ;

<embedded get group_id statement> ::=
    [ AT <db_name> ] <get group_id statement> <sql statement>

<embedded specific statement> ::=
    <autocommit statement>
  | <declare section statement>
  | <include statement>
  | <exception statement>
  | <context statement>
  | <option statement>
  ;

<autocommit statement> ::= [ AT <db_name> ] AUTOCOMMIT { ON | OFF };
<declare section statement> ::= { BEGIN | END } DECLARE SECTION;
<include statement> ::= INCLUDE { SQLCA | <identifier> };
<exception statement> ::= WHENEVER <exception_condition> <exception_action>;
<context statement> ::= CONTEXT <context action>;
<context action> ::=
    ALLOCATE :context_name
  | FREE :context_name
  | USE :context_name
  | USE DEFAULT
  ;

<option statement> ::= OPTION ( <option> );
<get group_id statement> ::= GET GROUPID INTO :group_id;

```

EXEC SQL AT

Feature

It specifies the connection name applied to the embedded SQL statement.

Syntax

```
EXEC SQL [ AT <db_name> ] ...
<db_name> ::=
    <identifier>
  | :hostvar
  ;
```

Description

The connection name can be specified when connected in the embedded SQL application. The name is used when the embedded SQL statement is performed by using the certain connection.

Example

```
{
  ...
  EXEC SQL AT :conn_name CONNECT :uid IDENTIFIED BY :pwd USING :conn_str;

  EXEC SQL AT :conn_name
    UPDATE EMP
    SET    sal = sal * 1.1
    WHERE JOB = 'SALES';
  ...
}
```

For More Information

Refer to [Connection](#).

EXEC SQL ATOMIC INSERT

Feature

It performs the atomic array insert.

Syntax

```
EXEC SQL ATOMIC <insert_statement>;
```

Description

Atomic array insert is performed in an embedded SQL application. Atomic array insert is for inserting multiple rows at once. It succeeds only when the entire row is inserted. If any row fails to be inserted, the insertion of the entire rows is failed.

It has a better performance than the individual insertion because the insertion is performed with a single command.

Example

```
{  
    EXEC SQL BEGIN DECLARE SECTION;  
    int    emp_number[20];  
    char   emp_name[20][10];  
    int    dept_number[20];  
    EXEC SQL END DECLARE SECTION;
```

- Setting the values of emp_number, emp_name, dept_number

```
...
```

- Inserting the values of emp_number, emp_name, dept_number

```
EXEC SQL ATOMIC INSERT INTO emp (empno, ename, deptno)  
                                VALUES (:emp_number, :emp_name, :dept_number);  
}
```

For More Information

Refer to **Atomic Insert**.

EXEC SQL AUTOCOMMIT

Feature

It changes the autocommit setting.

Syntax

```
EXEC SQL AUTOCOMMIT { ON | OFF };
```

Description

It sets the autocommit as follows.

Table 27-24 Setting the autocommit

Flag	Description
ON	Statement is executed and then autocommit is performed.
OFF	Commit is not performed until the explicit commit statement comes.

Example

```
{  
  ...  
  EXEC SQL AT :conn_name CONNECT :uid IDENTIFIED BY :pwd USING :conn_str;  
  
  EXEC SQL AUTOCOMMIT ON;  
  EXEC SQL AT :conn_name  
    UPDATE EMP  
    SET    sal = sal * 1.1  
    WHERE JOB = 'SALES';  
  
  ...  
}
```

For More Information

Refer to [Auto Commit](#).

EXEC SQL BEGIN DECLARE SECTION

Feature

It is a precompiler indicator, and it specifies the host variable declaration area.

Syntax

```
EXEC SQL BEGIN DECLARE SECTION;
```

Description

It is a precompiler indicator which specifies the host variable declaration section, and it is always used together with EXEC SQL END DECLARE SECTION. When precompiler encounters this statement, it is regarded as the start of declare section, and the variable thereafter is processed as the host variable.

Example

```
{  
    EXEC SQL BEGIN DECLARE SECTION;  
    int    emp_number[20];  
    char   emp_name[20][10];  
    int    dept_number[20];  
    EXEC SQL END DECLARE SECTION;  
  
    ...  
}
```

For More Information

Refer to the followings.

- [Declaring Host Variable](#)
- [EXEC SQL END DECLARE SECTION](#)

EXEC SQL COMMIT RELEASE

Feature

It commits the transaction and terminates the current connection.

Syntax

```
EXEC SQL [ AT <db_name> ] COMMIT [ WORK ] RELEASE;
```

Description

It commits the transaction and terminates the current connection.

```
EXEC SQL AT :conn_name COMMIT RELEASE;
```

The statement above is as same as the following.

```
EXEC SQL AT :conn_name COMMIT;  
EXEC SQL AT :conn_name DISCONNECT;
```

Example

```
{  
  ...  
  EXEC SQL AT :conn_name CONNECT :uid IDENTIFIED BY :pwd USING :conn_str;  
  
  EXEC SQL AT :conn_name  
    UPDATE EMP  
    SET    sal = sal * 1.1  
    WHERE JOB = 'SALES';  
  EXEC SQL AT :conn_name COMMIT RELEASE;  
  ...  
}
```

For More Information

Refer to **RELEASE Option**.

EXEC SQL CONNECT

Feature

It connects to GOLDILOCKS.

Syntax

```
EXEC SQL [ AT <db_name> ] CONNECT <user_name> IDENTIFIED BY <password> [ AT <db_name> ] [
USING <conn_string> ]
<db_name> ::=
    <identifier>
    | :hostvar
    ;
<user_name> ::=
    <identifier>
    | :hostvar
    ;
<password> ::=
    <identifier>
    | :hostvar
    ;
<conn_string> ::= :hostvar;
```

Description

It sets the connection to GOLDILOCKS.

Example

```
{
    ...
    EXEC SQL CONNECT :uid IDENTIFIED BY :pwd USING :conn_str;
    ...
}
```

For More Information

Refer to [Connecting to Database](#).

EXEC SQL CONTEXT ALLOCATE

Feature

It allocates the run-time context memory.

Syntax

```
EXEC SQL CONTEXT ALLOCATE :context;
```

Description

It allocates run-time context memory. It should be allocated for variable of SQL_CONTEXT type after the variable of SQL_CONTEXT type is declared in declare section to allocate the run-time context. This statement allocates the memory only, so to use it, USE should be specified and perform the connect.

Example

```
{  
    ...  
    EXEC SQL BEGIN DECLARE SECTION;  
    SQL_CONTEXT ctxt;  
    EXEC SQL END DECLARE SECTION;  
    EXEC SQL CONTEXT ALLOCATE :ctxt;  
  
    EXEC SQL CONTEXT USE :ctxt;  
    EXEC SQL CONNECT :uid IDENTIFIED BY :pwd USING :conn_str;  
  
    EXEC SQL  
        UPDATE EMP  
        SET     sal = sal * 1.1  
        WHERE  JOB = 'SALES';  
    EXEC SQL DISCONNECT;  
    EXEC SQL CONTEXT FREE :ctxt;  
  
    ...  
}
```

For More Information

Refer to `SQL_CONTEXT`.

EXEC SQL CONTEXT FREE

Feature

It frees the run-time context memory.

Syntax

```
EXEC SQL CONTEXT FREE :context;
```

Description

It frees run-time context memory. Disconnect should be performed before freeing the run-time context so that the connection will not be used any more. Otherwise, an unexpected error may occur.

Example

```
{  
    ...  
    EXEC SQL BEGIN DECLARE SECTION;  
    SQL_CONTEXT ctxt;  
    EXEC SQL END DECLARE SECTION;  
    EXEC SQL CONTEXT ALLOCATE :ctxt;  
  
    EXEC SQL CONTEXT USE :ctxt;  
    EXEC SQL CONNECT :uid IDENTIFIED BY :pwd USING :conn_str;  
  
    EXEC SQL  
        UPDATE EMP  
        SET     sal = sal * 1.1  
        WHERE  JOB = 'SALES';  
    EXEC SQL DISCONNECT;  
    EXEC SQL CONTEXT FREE :ctxt;  
  
    ...  
}
```

For More Information

Refer to `SQL_CONTEXT`.

EXEC SQL CONTEXT USE

Feature

It informs the use of run-time context.

Syntax

```
EXEC SQL CONTEXT USE { :context | DEFAULT };
```

Description

It is an indicator which informs the precompiler of the use of run-time context, and it specifies the run-time context to be used. The run-time context which is declared and allocated by a user can be used by using SQL_CONTEXT variable in USE statement, and the default context in the application is used when performing the USE DEFAULT statement.

Example

```
{  
  ...  
  EXEC SQL BEGIN DECLARE SECTION;  
  SQL_CONTEXT ctxt;  
  double      max_sal;  
  EXEC SQL END DECLARE SECTION;  
  EXEC SQL CONTEXT ALLOCATE :ctxt;  
  
  EXEC SQL CONTEXT USE :ctxt;  
  EXEC SQL CONNECT :uid IDENTIFIED BY :pwd USING :conn_str;  
  
  EXEC SQL  
    UPDATE EMP  
    SET   sal = sal * 1.1  
    WHERE JOB = 'SALES';  
  EXEC SQL COMMIT RELEASE;  
  EXEC SQL CONTEXT FREE :ctxt;  
  
  EXEC SQL CONTEXT USE DEFAULT;  
  EXEC SQL CONNECT :uid IDENTIFIED BY :pwd USING :conn_str;
```



```
EXEC SQL
  SELECT MAX(sal)
  INTO   max_sal
  FROM   EMP
  WHERE  JOB = 'SALES';
EXEC SQL DISCONNECT;
...
}
```

For More Information

Refer to `SQL_CONTEXT`.

EXEC SQL DISCONNECT

Feature

It disconnects from GOLDILOCKS.

Syntax

```
EXEC SQL [ AT <db_name> ] DISCONNECT [ ALL ]
```

Description

It disconnects from GOLDILOCKS. A specific connection can be freed with AT clause, and the current connection is freed if AT clause is not used. All connections which are used in the current application are freed by using DISCONNECT ALL.

Example

```
{  
  ...  
  EXEC SQL AT :conn_name DISCONNECT;  
  ...  
}
```

For More Information

Refer to [Disconnecting Database](#).

EXEC SQL END DECLARE SECTION

Feature

It is a precompiler indicator, and it specifies the the host variable declaration section.

Syntax

```
EXEC SQL END DECLARE SECTION;
```

Description

It is a precompiler indicator which specifies the host variable declaration section, and it is always used together with EXEC SQL BEGIN DECLARE SECTION. When precompiler encounters this statement during analyzing the declare section, it is regarded as the end of the declare section.

Example

```
{  
    EXEC SQL BEGIN DECLARE SECTION;  
    int    emp_number[20];  
    char   emp_name[20][10];  
    int    dept_number[20];  
    EXEC SQL END DECLARE SECTION;  
  
    ...  
}
```

For More Information

Refer to the followings.

- [Declaring Host Variable](#)
- [EXEC SQL BEGIN DECLARE SECTION](#)

EXEC SQL FOR

Feature

It specifies the number of arrays in array operation.

Syntax

```
EXEC SQL FOR { :array_count | integer_constant } <sql statement>;
```

Description

If the host variable of the SQL statement is an array, it is a precompiler indicator which specifies the array count. When FOR clause is given, the array count of the host array is ignored and the arrays as many as the number specified in FOR clause are performed.

The constant or variable which refers to array count should be an integer.

Example

```
EXEC SQL BEGIN DECLARE SECTION;  
int    emp_number[20];  
char   emp_name[20][10];  
int    dept_number[20];  
int    record_cnt;  
EXEC SQL END DECLARE SECTION;
```

- Setting the values of emp_number, emp_name, dept_number

...

- Inserting emp_number, emp_name, dept_number

```
record_cnt = 10;  
EXEC SQL FOR :record_cnt INSERT INTO emp (empno, ename, deptno)  
VALUES (:emp_number, :emp_name, :dept_number);
```

For More Information

Refer to [Using FOR Clause](#).

EXEC SQL GET GROUPID INTO

Feature

It obtains the group ID of the SQL statement.

Syntax

```
EXEC SQL [ AT <db_name> ] GET GROUPID INTO :group_id { delete_stmt | insert_stmt | select_stmt  
| update_stmt };
```

Description

It obtains the the group ID of the SQL statement in the cluster environment which uses the global connection. Only the signed numeric type is allowed for the host variable :group_id. The group ID can be obtained only for the delete, insert, select, update SQL statement, and the shard key should be set in the table in advance.

The SQL statement which obtained the group ID is internally cached in SQLPrepare status without executing SQLExecute.



-1 which is an invalid group ID value can be returned.

Example

```
{  
EXEC SQL BEGIN DECLARE SECTION;  
int group_id[10];  
int emp_no[10];  
char emp_name[10][20];  
int dept_no[10];  
EXEC SQL END DECLARE SECTION;
```

- Set emp_no, emp_name, dept_no values

...

- Obtain the group id.

```
EXEC SQL GET GROUPID INTO :group_id
      INSERT INTO emp (empno, ename, deptno) VALUES (:emp_no, :emp_name, :dept_no);
```

- INSERT emp_no, emp_name, dept_no.

```
EXEC SQL INSERT INTO emp (empno, ename, deptno) VALUES (:emp_no, :emp_name, :dept_no);
}
```

EXEC SQL INCLUDE

Feature

It includes the embedded SQL header file.

Syntax

```
EXEC SQL INCLUDE <Header file name>;
```

Description

It includes the embedded SQL header file. If the header file is included with #include of C language, the precompiler does not interpret it, so the precompiler can not recognize it even when the information which the precompiler should recognize such as declare section in the header file is included in it. Therefore, the EXEC SQL INCLUDE statement should be used when the embedded SQL statement which the precompiler should recognize is used.

Example

```
EXEC SQL INCLUDE decl.h;
```

For More Information

Refer to [Precompiled Header File](#).

EXEC SQL INCLUDE SQLCA

Feature

It includes sqlca.h header file.

Syntax

```
EXEC SQL INCLUDE SQLCA;
```

Description

It is a special type of EXEC SQL INCLUDE statement, and it includes sqlca.h header file supported by GOL DILLOCKS. This header file is required for run-time exception handling in the embedded SQL application.

Example

```
EXEC SQL INCLUDE SQLCA;
```

For More Information

Refer to [Detecting Run-time Error](#).

EXEC SQL OPTION

Feature

It applies the option to the process of precompiling the embedded SQL source code.

Syntax

```
EXEC SQL OPTION ( <option_desc> );  
<option_desc> ::=  
    INCLUDE = <directory path>  
    ;
```

Description

It describes the option which is applied to the process of precompiling the embedded SQL source code. It supports only specifying INCLUDE path in the current version, and the option specifies the directory of the header file to be precompiled in EXEC SQL INCLUDE.

Example

```
EXEC SQL OPTION ( INCLUDE = include );
```

For More Information

Refer to [Specifying Header File Path](#).

EXEC SQL ROLLBACK RELEASE

Feature

It rolls back the transaction, then releases the connection.

Syntax

```
EXEC SQL [ AT <db_name> ] ROLLBACK [ WORK ] RELEASE;
```

Description

It rolls back the transaction, then releases the current connection.

```
EXEC SQL AT :conn_name ROLLBACK RELEASE;
```

The statement above is as same as the following.

```
EXEC SQL AT :conn_name ROLLBACK;  
EXEC SQL AT :conn_name DISCONNECT;
```

Example

```
{  
  ...  
  EXEC SQL AT :conn_name CONNECT :uid IDENTIFIED BY :pwd USING :conn_str;  
  
  EXEC SQL AT :conn_name  
    UPDATE EMP  
    SET    sal = sal * 1.1  
    WHERE JOB = 'SALES';  
  EXEC SQL AT :conn_name ROLLBACK RELEASE;  
  ...  
}
```

For More Information

Refer to **RELEASE Option**.

EXEC SQL WHENEVER

Feature

It executes run-time exception handling in the embedded SQL application.

Syntax

```
EXEC SQL WHENEVER <conditions> <actions>;
<conditions> ::=
    SQLERROR
  | SQLWARNING
  | NOT FOUND
  | SQLSTATE <sqlstate class value>[<sqlstate subclass value>]
  ;
<sqlstate_char> ::= [0-9A-Z];
<sqlstate class value> ::= <sqlstate_char> <sqlstate_char>;
<sqlstate subclass value> ::= <sqlstate_char> <sqlstate_char> <sqlstate_char>;
<actions> ::=
    CONTINUE
  | GOTO <label>
  | STOP
  | DO <c statements>
  ;
```

Description

It automates and processes the run-time exception handling in an embedded SQL application. There are four conditions, a single action can be specified per each condition. The action can be reassigned as needed. For more information, refer to **Handling Implicit Error**.

Example

```
EXEC SQL WHENEVER SQLERROR STOP;
EXEC SQL WHENEVER SQLERROR CONTINUE;
EXEC SQL WHENEVER SQLERROR GOTO exit_label;
EXEC SQL WHENEVER NOT FOUND DO break;
EXEC SQL WHENEVER SQLERROR GOTO close_label;
EXEC SQL WHENEVER SQLERROR DO sql_error();
```

```
EXEC SQL WHENEVER SQLWARNING CONTINUE;  
EXEC SQL WHENEVER SQLSTATE HY000 DO sql_error();
```

For More Information

Refer to [Handling Implicit Error](#).

28.

PDO

28.1 Overview of PDO

GOLDILOCKS PDO (PDO_GOLDILOCKS) driver provides PDO interface to access GOLDILOCKS database in PDO, and it is provides in a package.

PDO_GOLDILOCKS is built based on GOLDILOCKS CLI driver.

28.2 Installation /Configuration

Requirement

The client package of GOLDILOCKS should be installed in the system which is as same as that of PHP, and environment variables of \$GOLDILOCKS_HOME should be set.

Installation

Installation by Using PECL

Create the package file if PDO_GOLDILOCKS package file does not exist.

```
% pecl pickle
Attempting to process the second package file
Package PDO_GOLDILOCKS-3.2.0.tgz done
```

Install the package by using PECL if PDO_GOLDILOCKS package file exists.

```
% sudo -E pecl install PDO_GOLDILOCKS-3.2.0.tgz
```

Installation by Building the Source

1. Decompress PDO_GOLDILOCKS.

```
% tar xvzf PDO_GOLDILOCKS-3.2.0.tgz
% cd PDO_GOLDILOCKS-3.2.0
```

2. Create the environment for the build.

Create the build environment for PDO_GOLDILOCKS expanded module by using `phpize` command. If `phpize` command can not be found, PHP devel package in an appropriate version should be installed.

```
% whereis phpize
phpize: /usr/bin/phpize /usr/share/man/man1/phpize.1.gz
```

```
% /usr/bin/phpize
Configuring for:
PHP Api Version:      20121113
Zend Module Api No:   20121212
Zend Extension Api No: 220121212
```

3. Build it.

Execute `configure` by adding the path of `$GOLDILOCKS_HOME` to `--with-pdo-goldilocks` option and adding the path of `php-config` to `--with-php-config` option, then build it.

```
% whereis php-config
php-config: /usr/bin/php-config /usr/share/man/man1/php-config.1.gz
```

```
% ./configure --with-php-config=/usr/bin/php-config
--with-pdo-goldilocks=/home/goldilocks/goldilocks_home/
```

```
% make
```

4. Install it.

```
% sudo -E make install
```

Altering PHP Configuration File

When using CentOS 6.0 or higher or Fedora 15 or higher, the `pdo_goldilocks.ini` file should be created in `/etc/php.d` directory and extension property should be added as follows.

```
extension=pdo_goldilocks.so
```

When using other OS `extension_dir` should be appropriately set in `php.ini` file and add extension property should be added as follows.

```
extension=pdo_goldilocks.so
```

Restarting Web Server

Restart the web server.

Checking Installation of PDO_GOLDILOCKS

Check whether PDO_GOLDILOCKS is activated by using `phpinfo()`.

```
% php -i | grep PDO
PDO
PDO support => enabled
PDO drivers => goldilocks, sqlite
PDO Driver for GOLDILOCKS => enabled
PDO Driver for SQLite 3.x => enabled
```

28.3 Usage

Data Source Name (DSN)

Data Source Name (DSN) of PDO_GOLDILOCKS is configured as follows.

Property	Description
DSN prefix	goldilocks
DSN	ODBC Data Source Name (DSN)
HOST	IP address of a server
PORT	PORT number of server
UID	User ID
PWD	User password

28.4 Examples

- Connecting to GOLDBLOCKS

```
print "\n[Connecting to GOLDBLOCKS]\n";
$db = new PDO('goldlocks:HOST=192.168.0.16;PORT=22581', 'test', 'test');
//$db = new PDO('goldlocks:DSN=GOLDBLOCKS;UID=test;PWD=test');
$db->setAttribute(PDO::ATTR_ERRMODE, PDO::ERRMODE_EXCEPTION);
```

- Set test data

```
$result = $db->exec('DROP TABLE IF EXISTS t1');
$result = $db->exec('CREATE TABLE t1 ( id INTEGER GENERATED BY DEFAULT AS IDENTITY, name
VARCHAR(32) )');
$result = $db->exec("INSERT INTO t1(name) VALUES ('Carol')");
$result = $db->exec("INSERT INTO t1(name) VALUES ('Ted')");
$result = $db->exec("INSERT INTO t1(name) VALUES (null)");
$result = $db->exec("INSERT INTO t1(name) VALUES ('William')");
$result = $db->exec("INSERT INTO t1(name) VALUES ('Chelsea')");
$result = $db->exec("INSERT INTO t1(name) VALUES ('Colin')");
$result = $db->exec('DROP TABLE IF EXISTS t2');
$result = $db->exec('CREATE TABLE t2 ( id INTEGER, name VARCHAR(32) )');
$result = $db->exec("INSERT INTO t2 VALUES (1, 'John')");
$result = $db->exec("INSERT INTO t2 VALUES (1, 'John')");
$result = $db->exec("INSERT INTO t2 VALUES (1, 'John')");
$result = $db->exec("INSERT INTO t2 VALUES (2, 'Smith')");
$result = $db->exec("INSERT INTO t2 VALUES (2, 'Smith')");
$result = $db->exec('DROP TABLE IF EXISTS images');
$result = $db->exec('CREATE TABLE images ( id INTEGER, contenttype VARCHAR(256), imagedata
LONG VARBINARY )');
$result = $db->exec('DROP PROCEDURE IF EXISTS sp_out_string');
$result = $db->exec("CREATE OR REPLACE PROCEDURE sp_out_string( v1 OUT VARCHAR(32) ) ".
    "IS ".
    "BEGIN ".
    "  v1 := 'WORLD'; ".
    "END; ");
$result = $db->exec('DROP PROCEDURE IF EXISTS sp_inout_string');
$result = $db->exec("CREATE OR REPLACE PROCEDURE sp_inout_string( v1 INOUT VARCHAR(32) ) ".
    "IS ".
    "BEGIN ";
```

```

        " v1 := V1 || ' WORLD'; ".
        "END; ");

```

- Quoting a normal string

```

print "\n[Quoting a normal string]\n";
$string = 'Nice';
print "Unquoted string: $string\n";
print "Quoted string : " . $db->quote($string) . "\n";

```

- Quoting a dangerous string

```

print "\n[Quoting a dangerous string]\n";
$string = 'Naughty \' string';
print "Unquoted string: $string\n";
print "Quoted string : " . $db->quote($string) . "\n";

```

- Quoting a complex string

```

print "\n[Quoting a complex string]\n";
$string = "Co'mpl'ex \'st\'"ring";
print "Unquoted string: $string\n";
print "Quoted string : " . $db->quote($string) . "\n";

```

- Handling an error

```

print "\n[Error Handling]\n";
try
{
    //connect as appropriate as above
    $db->query('invalid query'); //invalid query!
}
catch(PDOException $ex)
{
    print "ERROR:". $ex->getMessage(). "\n";
}

```

- Retrieving column metadata

```

print "\n[Retrieving column metadata]\n";
$stmt = $db->query('SELECT * FROM t1');
foreach(range(0, $stmt->columnCount() - 1) as $column_index)

```

```
{
    $meta = $stmt->getColumnMeta($column_index);
    var_dump($meta);
}
```

- Running simple select statements

```
print "\n[Running Simple Select Statements]\n";
print "\n#1\n";
foreach($db->query('SELECT * FROM t1') as $row)
{
    print $row['ID'].' '.$row['NAME']."\n";
}
print "\n#2\n";
$stmt = $db->query('SELECT * FROM t1');

while($row = $stmt->fetch(PDO::FETCH_ASSOC))
{
    print $row['ID'].' '.$row['NAME']."\n";
}
```

- Fetching rows using different fetch styles

```
print "\n[Fetching rows using different fetch styles]\n";
$stmt = $db->prepare("SELECT id, name FROM t1");
$stmt->execute();
print("PDO::FETCH_ASSOC: ");
print("Return next row as an array indexed by column name\n");
$result = $stmt->fetch(PDO::FETCH_ASSOC);
print_r($result);
print("\n");
print("PDO::FETCH_BOTH: ");
print("Return next row as an array indexed by both column name and number\n");
$result = $stmt->fetch(PDO::FETCH_BOTH);
print_r($result);
print("\n");
print("PDO::FETCH_LAZY: ");
print("Return next row as an anonymous object with column names as properties\n");
$result = $stmt->fetch(PDO::FETCH_LAZY);
print_r($result);
print("\n");
print("PDO::FETCH_OBJ: ");
```

```
print("Return next row as an anonymous object with column names as properties\n");
$result = $stmt->fetch(PDO::FETCH_OBJ);
print $result->NAME;
print("\n");
```

- Fetching rows with a scrollable cursor

```
print "\n[Fetching rows using different fetch styles]\n";
print "\n[Fetching rows with a scrollable cursor]\n";
$sql = 'SELECT id, name FROM t1 ORDER BY id';
print "Reading forwards:\n";
try
{
    $stmt = $db->prepare($sql, array(PDO::ATTR_CURSOR => PDO::CURSOR_SCROLL));
    $stmt->execute();
    while( $row = $stmt->fetch(PDO::FETCH_NUM, PDO::FETCH_ORI_NEXT) )
    {
        $data = $row[0] . "\t" . $row[1] . "\n";
        print $data;
    }
    $stmt = null;
}
catch (PDOException $e)
{
    print $e->getMessage();
}
print "Reading backwards:\n";
try
{
    $stmt = $db->prepare($sql, array(PDO::ATTR_CURSOR => PDO::CURSOR_SCROLL));
    $stmt->execute();
    $row = $stmt->fetch(PDO::FETCH_NUM, PDO::FETCH_ORI_LAST);
    do
    {
        $data = $row[0] . "\t" . $row[1] . "\n";
        print $data;
    } while( $row = $stmt->fetch(PDO::FETCH_NUM, PDO::FETCH_ORI_PRIOR) );
    $stmt = null;
}
catch (PDOException $e)
{
```

```

    print $e->getMessage();
}

```

- Constructing an order

```

print "\n[Construction order]\n";
class Person
{
    private $NAME;
    public function __construct()
    {
        $this->tell();
    }
    public function tell()
    {
        if (isset($this->NAME))
        {
            print "I am {$this->NAME}.\n";
        }
        else
        {
            print "I don't have a name yet.\n";
        }
    }
}

$stmt = $db->query("SELECT name FROM t1");
$stmt->setFetchMode(PDO::FETCH_CLASS, 'Person');
$person = $stmt->fetch();
$person->tell();
$stmt->setFetchMode(PDO::FETCH_CLASS|PDO::FETCH_PROPS_LATE, 'Person');
$person = $stmt->fetch();
$person->tell();

```

- Running simple INSERT, UPDATE, or DELETE statements

```

print "\n[Running Simple INSERT, UPDATE, or DELETE statements]\n";
$affected_rows = $db->exec("INSERT INTO t1(name) VALUES ('John'), ('Marry')");
print $affected_rows." were affected\n";

```

- Getting the last insert id

```

print "\n[Getting the Last Insert Id]\n";
$affected_rows = $db->exec("INSERT INTO t1(name) VALUES ('Smith')");
$insertId = $db->lastInsertId();
print "last insert id : ".$insertId."\n";

```

- Running statements with parameters

```

print "\n[Running Statements With Parameters]\n";
print "\n#1 array\n";
$id = 1;
$name = 'John';
$stmt = $db->prepare("SELECT * FROM t2 WHERE id=? AND name=?");
$stmt->execute(array($id, $name));
$rows = $stmt->fetchAll(PDO::FETCH_ASSOC);
var_dump($rows);
print "\n#2 bindValue\n";
$id = 2;
$name = 'Smith';
$stmt = $db->prepare("SELECT * FROM t2 WHERE id=? AND name=?");
$stmt->bindValue(1, $id, PDO::PARAM_INT);
$stmt->bindValue(2, $name, PDO::PARAM_STR);
$stmt->execute();
$rows = $stmt->fetchAll(PDO::FETCH_ASSOC);
var_dump($rows);

```

- Named placeholders

```

print "\n[Named Placeholders]\n";
print "\n#1 array\n";
$id = 1;
$name = 'John';
$stmt = $db->prepare("SELECT * FROM t2 WHERE id=:id AND name=:name");
$stmt->execute(array(':name' => $name, ':id' => $id));
$rows = $stmt->fetchAll(PDO::FETCH_ASSOC);
var_dump($rows);
print "\n#2 bindValue\n";
$id = 2;
$name = 'Smith';
$stmt = $db->prepare("SELECT * FROM t2 WHERE id=:id AND name=:name");
$stmt->bindValue(':id', $id, PDO::PARAM_INT);
$stmt->bindValue(':name', $name, PDO::PARAM_STR);

```



```
$stmt->execute();
$rows = $stmt->fetchAll(PDO::FETCH_ASSOC);
var_dump($rows);
```

- Executing prepared statements in a loop

```
print "\n[Executing prepared statements in a loop]\n";
$values = array('bob', 'alice', 'lisa', 'john');
$name = '';
$stmt = $db->prepare("INSERT INTO t1(name) VALUES(:name)");
$stmt->bindParam(':name', $name, PDO::PARAM_STR);
foreach($values as $name)
{
    $stmt->execute();
}
foreach($db->query('SELECT * FROM t1') as $row)
{
    print $row[0].' '.$row[1]."\n";
}
```

- Calling a stored procedure with an output parameter

```
print "\n[Calling a stored procedure with an output parameter]\n";
$stmt = $db->prepare("CALL sp_out_string(?)");
$stmt->bindParam(1, $value, PDO::PARAM_STR, 32);
$stmt->execute();
print "procedure returned $value\n";
```

- Calling a stored procedure with an input/output parameter

```
print "\n[Calling a stored procedure with an input/output parameter]\n";
$stmt = $db->prepare("CALL sp_inout_string(?)");
$value = 'HELLO';
$stmt->bindParam(1, $value, PDO::PARAM_STR|PDO::PARAM_INPUT_OUTPUT, 32);
$stmt->execute();
print "procedure returned $value\n";
```

- Transactions

```
print "\n[Transactions]\n";
print "\n#1 commit\n";
try
```

```
{
    $db->beginTransaction();

    $db->exec("INSERT INTO t1(name) VALUES('kim')");
    $name = 'lee';
    $stmt = $db->prepare("INSERT INTO t1(name) VALUES(?)");
    $stmt->execute(array($name));

    $id = 3;
    $name = 'park';
    $stmt = $db->prepare("INSERT INTO t2 VALUES(?, ?)");
    $stmt->execute(array($id, $name));

    $db->commit();
}
catch(PDOException $ex)
{
    //Something went wrong rollback!
    $db->rollBack();
    print $ex->getMessage()."\n";
}
print "\nT1\n";
foreach($db->query('SELECT * FROM t1') as $row)
{
    print $row[0].' '.$row[1]."\n";
}
print "\nT2\n";
foreach($db->query('SELECT * FROM t2') as $row)
{
    print $row[0].' '.$row[1]."\n";
}
print "\n#2 rollback\n";
try
{
    $db->beginTransaction();

    $db->exec("INSERT INTO t1(name) VALUES('KIM')");
    $name = 'LEE';
    $stmt = $db->prepare("INSERT INTO t1(name) VALUES(?)");
    $stmt->execute(array($name));
```

```

$id = 3;
$name = 'PARK';
$stmt = $db->prepare("INSERT INTO invalid VALUES(?, ?)");
$stmt->execute(array($id, $name));

$db->commit();
}
catch(PDOException $ex)
{
    //Something went wrong rollback!
    $db->rollBack();
    print $ex->getMessage()."\n";
}
print "\nT1\n";
foreach($db->query('SELECT * FROM t1') as $row)
{
    print $row[0].' '.$row[1]."\n";
}
print "\nT2\n";
foreach($db->query('SELECT * FROM t2') as $row)
{
    print $row[0].' '.$row[1]."\n";
}

```

- Inserting an image into a database

```

print "\n[Inserting an image into a database]\n";
try
{
    $stmt = $db->prepare("INSERT INTO images (id, contenttype, imagedata) VALUES (?, ?, ?)");
    $id = 1;
    $type = "image/png";
    $fp = fopen("logo.png", "rb");
    $stmt->bindParam(1, $id, PDO::PARAM_INT);
    $stmt->bindParam(2, $type, PDO::PARAM_STR, 256);
    $stmt->bindParam(3, $fp, PDO::PARAM_LOB);
    $db->beginTransaction();
    $stmt->execute();
    $db->commit();
}
catch(PDOException $ex)

```

```
{
    $db->rollBack();
    print $ex->getMessage()."\n";
}
foreach($db->query('SELECT id, contenttype, lengthb(imagedata) FROM images') as $row)
{
    print $row[0].' '.$row[1].' '.$row[2]."\n";
}
```

- Displaying an image from a database

```
print "\n[Displaying an image from a database]\n";
try
{
    $stmt = $db->prepare("SELECT contenttype, imagedata FROM images WHERE id = ?");
    $id = 1;
    $stmt->execute(array($id));
    $stmt->bindColumn(1, $type, PDO::PARAM_STR, 256);
    $stmt->bindColumn(2, $lob, PDO::PARAM_LOB);
    $stmt->fetch(PDO::FETCH_BOUND);
    print 'Content-Type: '.$type."\n";
    print 'size: '.file_put_contents($id.".png", $lob)."\n";
}
catch(PDOException $ex)
{
    print $ex->getMessage()."\n";
}
```

29.

PyDBC

29.1 GOLDDILOCKS PyDBC

Overview

PyDBC programs Python accessing GOLDDILOCKS database by using API which complies with **Python Database API Specification v2.0(PEP 249)**.

PyDBC requires the Python standard library, and the internal operation which connects to and operate GOLDDILOCKS database requires ODBC library because it calls ODBC API. PyDBC basically uses ODBC library `$GOLDDILOCKS_HOME/lib/libgoldilocksas.so`, and a user can update it.

The internal operation of PyDBC uses ODBC driver, so it is as same as **Overview of ODBC Components**. There are an architecture of which an application links to the driver manager, and an architecture of which an application links to GOLDDILOCKS ODBC driver library.

Version

The information of GOLDDILOCKS PyDBC version can be viewed by executing *pygoldilocks.so* file as follows.

```
shell>python
>>> import pygoldilocks
>>> print pygoldilocks.version
3.2.0
```

The current version of GOLDDILOCKS PyDBC driver is 3.2.0 according to GOLDDILOCKS version, and this driver complies with the standard Python database API 2.0. PyDBC driver supports Python 2.7, 3.4, 3.5, 3.6 versions, and PyDBC driver library should be installed according to each Python version.

Installation

The source should be built to install PyDBC. PyDBC links `gdlds` library in `GOLDDILOCKS_HOME/lib` and it includes *goldilocks.h* header file in `GOLDDILOCKS_HOME/include`, so the environment variable `GOLDDILOCKS_HOME` should be set in an appropriate position.

Installation on Linux

Linux requires the gcc compiler, and it is built as follows.

```
shell> sudo python setup.py install
```



It does not support HP-UX nor AIX platform.

Installation on Windows

It is built on Windows as follows.

```
shell> python setup.py install
```

An appropriate Microsoft Visual C++ compiler according to python version is required to compile PyDBC. For more information, refer to <https://wiki.python.org/moin/WindowsCompilers>.

- Visual Studio 2003.NET compiler is required to build Python version 2.4 or 2.5, and there is not a free ware for this version.
- Visual C++ 2008 compiler is required to build Python version 2.6, 2.7, 3.0, 3.2, and the freeware for this version is Visual C++ 2008 Express.
- Visual C++ 2010 compiler is required to build Python version 3.3, 3.4, and the freeware for this version is Visual C++ 2010 Express.
- Visual C++ 2014 or VC 2017 compiler is required to build Python version 3.5, 3.6.
- Visual C++ 2017 compiler is required to build Python version 3.7.

Examples

- Obtain the connection as follows.

```
import pygoldilocks
cnxn = pygoldilocks.connect( 'DSN=GOLDILOCKS;UID=test;PWD=test' )
```

Call connect which is an internal function of pygoldilocks, a module of PyDBC, to obtain the connection.



odbc.ini File should be built in advance to use DSN.

- A cursor and a row class can be used as follows.

```
cursor = cnxn.cursor()
cursor.execute( "SELECT NAME, ADDRESS FROM EMP" )
rows = cursor.fetchall()
for row in rows:
    print row.A, row.B
cursor.close()
cnxn.close()
```

29.2 API Reference

pygoldilocks Module

pygoldilocks object complies with **Python Database API Specification v2.0**.

For more information, refer to **Python DB API module**.

Properties

- version
 - The version of pygoldilocks module follows that of GOLDDLOCKS database. The version is a string in a form of major.minor.patch.
- apilevel
 - It indicates DB API level 2.0, and the value is "2.0" character string constant.
- lowercase
 - It controls whether to convert the column name from the row object of the result value to lowercase. The default value is false. It is useful when the case of database column does not conform.
- threadsafety
 - It is constant 1, and it does not share the connection even when threads share the module.
- paramstyle
 - It indicates a parameter and the value is the character string constant "qmark" which means a question mark.

connect

It newly connects to the database.

```
connect( *connectionstring, **kwargs )
```

It inputs the ODBC connect string and keywords. The keywords are as follows.

Keyword	Description	Default value
attrs_before	It sets properties which should be set before the connection. It receives the value in dictionary type.	-
autocommit	It sets whether to auto commit. If it is false, connection.commit should be called to reflect it in the database.	False

Keyword	Description	Default value
readonly	If it is true, the connection is set to readonly.	False
timeout	It sets the timeout for the connection. <code>SQL_ATTR_LOGIN_TIMEOUT</code> is set.	-

- `attrs_before`
 - It sets options which is to be set before the connection. These options are set by using `SQLSetConnectAttr`. It receives the properties and values in dictionary type. For more information about configuration, refer to **ODBC attributes**.

```
cnxn = pygoldilocks.connect( "DSN=GOLDILOCKS", attr_before={ pygoldilocks.SQL_ATTR_MAX_ROWS :
1000 })
```

Date

```
>>> print pygoldilocks.Date(1984,11,23), type(pygoldilocks.Date(1984,11,23))
1984-11-23 <type 'datetime.date'>
```

It creates a date object corresponding to the given value.

Time

```
>>> print pygoldilocks.Time(11,23,23), type(pygoldilocks.Time(11,23,23))
11:23:23 <type 'datetime.time'>
```

It creates a time object corresponding to the given value.

Timestamp

```
>>> print pygoldilocks.Timestamp(1984,11,23,11,23,23),
type(pygoldilocks.Timestamp(1984,11,23,11,23,23))
1984-11-23 11:23:23 <type 'datetime.datetime'>
```

It creates a datetime object corresponding to the given value.

DATETIME

```
>>> print pygoldilocks.DATETIME(1984,11,23,11,23,23),
type(pygoldilocks.DATETIME(1984,11,23,11,23,23))
1984-11-23 11:23:23 <type 'datetime.datetime'>
```

It creates a datetime object corresponding to the given value. It is as same as **Timestamp**.

Binary

```
>>> print pygoldilocks.Binary('binary'), type(pygoldilocks.Binary('binary'))
binary <type 'bytearray'>
```

It creates a bytearray object corresponding to the given value. It is as same as **BINARY**.

BINARY

```
>>> print pygoldilocks.BINARY('binary'), type(pygoldilocks.BINARY('binary'))
binary <type 'bytearray'>
```

It creates a bytearray object corresponding to the given value.

STRING

```
>>> print pygoldilocks.STRING('str'), type(pygoldilocks.STRING('str'))
str <type 'str'>
```

It creates an str object corresponding to the given value.

NUMBER

```
>>> print pygoldilocks.NUMBER(100.001), type(pygoldilocks.NUMBER(100.001))
100.001 <type 'float'>
```

It creates a float object corresponding to the given value.

ROWID

```
>>> print pygoldilocks.ROWID('AA'), type(pygoldilocks.ROWID('AA'))
AA <type 'str'>
```

It is used to describe the row ID column of the database, and returns an str object.

TimeFromTicks

```
>>> print pygoldilocks.TimeFromTicks( 10 )  
09:00:10
```

It returns a `datetime.time` object which is set as an argument value.

DateFromTicks

```
>>> print pygoldilocks.DateFromTicks( 360000 )  
1970-01-05
```

It returns a `datetime.date` object which is set as an argument value.

TimestampFromTicks

```
>>> print pygoldilocks.DateFromTicks( 360000 )  
1970-01-05
```

It returns a `datetime.timestamp` object which is set as an argument value.

setDecimalSeparator

It sets the decimal point delimiter in NUMERIC type obtained from the database. The default value uses a period (.).

getDecimalSeparator

It obtains the set decimal point delimiter in NUMERIC type.

Connection

It is an object managing the connection with the database, and it is created with `connect()` function of `pygoldilocks` module.

Properties

- `autocommit`
 - It can set the autocommit mode of the connection.
- `searchescape`
 - It obtains an escape character of ODBC. `pygoldilocks` uses `'/'`.
- `timeout`
 - It sets `SQL_ATTR_QUERY_TIMEOUT` by using `SQLSetConnectAttr` function.

함수

- `cursor()`
 - It returns a new cursor object.
- `commit()`
 - It commits the executed SQL statement.
- `rollback()`
 - It rolls back the executed SQL statement.
- `close()`
 - It closes the connection. If the autocommit is false, then the SQL statement which was not committed is rolled back.
- `getinfo(info)`
 - It can obtain the connection properties by using `SQLGetInfo` function of ODBC. For more information, refer to **SQLGetInfo**.

```
dns_name = cnxn.getinfo( pygoldilocks.SQL_DATA_SOURCE_NAME )
```

- `execute(sql, [*params])`
 - It creates a new cursor object, and executes `execute` function of this object, then returns a cursor object.

```
cursor = cnxn.execute( "SELECT COUNT(*) FROM EMP" )
```

For more information, refer to `Cursor.execute()` function. This function does not exist in Python API, but it is provided for the convenience. Whenever this function is called, a cursor object is allocated, so it is not recommended to use it when it is required to execute one or more SQL statements.

- `set_attr(attr_id, value)`

- The connection properties can be set by executing `SQLSetConnectAttr` function.
- The following is an example of controlling the transaction isolation level of the database by using `set_attr` function.

```
connection.set_attr( pygoidilocks.SQL_ATTR_TXN_ISOLATION, pygoidilocks.SQL_TXN_SERIALIZABLE )
```

Cursor

Generally, a cursor object means the database cursor which is used to manage the fetch operation. The database cursor is mapped to ODBC statement handle (HSTMT). The cursor objects which is created by the same connection are not separated. In other words, all updates executed by a cursor to the database are also applied to other cursors.



Cursor does not manage the database transaction, but the connection commits or rolls back the transaction.

Properties

Description

It is the read-only property, and it includes the contents for each column which was returned by `SELECT` statement executed last with tuple type. Each tuple includes the followings.

1. Column name (or alias)
2. Type code
3. Display size
4. Internal size
5. Precision
6. Scale
7. Nullable

When `SELECT` statement is not called, then the description is none.

rowcount

It is the number of rows which were updated by SQL statement which was executed last.

arraysize

It is the number of rows which can be fetched per one time by using `fetchmany([size = cursor.arraysize])` function. The default value 1.

connection

It is the read-only property, and it indicates the connection object which created the corresponding cursor object.

fast_executemany

If it is set to true, then makes the parameters in array and executes them at once when executing `execute_many(sql, [*params])` function. If it is set to false, it separately executes each parameter.

Function

execute(sql, [*params])

It executes SQL statement through `SQLPrepare` and `SQLExecute` functions, then returns a cursor which called this function.

The parameter option can be used as follows.

```
cursor.execute( "SELECT A FROM TEST WHERE B=? AND C=?", x, y )
```

```
cursor.execute( "SELECT A FROM TEST WHERE B=? AND C=?", (x, y) )
```

executemany(sql, [*params])

It executes SQL statement for each parameter and returns *none*. Parameter *params* should be a sequence type of a sequence or a sequence generator.

```
params = [ ( 1, 'A' ), ( 2, 'B' ) ]
cursor.executemany( "INSERT INTO TEST( C1, C2 ) VALUES ( ?, ? )", params )
```

SQL statement is executed twice in the example above. In other words, it is separately executed for (1, 'A') and (2, 'B') each. The operation of `executemany` depends on whether `fast_executemany` of a cursor object is set to true or false.

The example above is as same as follows.

```
params = [ ( 1, 'A' ), ( 2, 'B' ) ]
for p in params:
    cursor.execute( "INSERT INTO TEST( C1, C2 ) VALUES ( ?, ? )", p )
```

If `fast_executemany` is set to `true`, `executemany` processes the operation with only a single `execute`. For that, data in the same index location in items of parameter `params` should be the same data type.

```
params = [ ( 1, 'A' ), ( '2', 'B' ) ]
cursor.executemany("INSERT INTO TEST( C1, C2 ) VALUES ( ?, ? )", params)
```

In the example above, the data type of the first item among two items of parameter `params` is different. Likewise, the data type on the same index location between items are different, then `executemany` does not process SQL statement at once, but separately processes it.

If the `autocommit` of a connection object is `true`, then SQL statement is processed being split and each SQL statement is separately committed. If an error occurs while sequentially processing records, then only some records are committed to the database and the operation is completed leaving some records are not committed. Therefore, it is recommended to set `autocommit` to `false` to check if all records are committed to the database when using `executemany()`.

fetchone()

It returns the next row of the query. If the next data does not exist, it is `none`.

fetchall()

It returns all rows left in the query. Be cautious when using it because it reads all rows to the memory.

fetchmany([size = cursor.arraysize])

It returns rows which were left as many as `size` or `cursor.arraysize`. The next data returns an empty sequence data. The default value of `cursor.arraysize` is 1.

commit()

It commits SQL statement. It is a function executed by a connection object which created a cursor object, and it is applied to all cursor which were created in the same connection object. It is as same as `commit` of the connection object.

rollback()

It rolls back SQL statement. It is a function executed by a connection object which created a cursor object, and it is applied to all cursor which were created in the same connection object. It is as same as `rollback` of the connection object.

skip(count)

It passes through the record through `SQLFetchScroll` and `SQL_FETCH_NEXT` as many times as it is set in `count`.

nextset()

It returns false because GOLDILOCKS ODBC does not support SQLMoreResults.

close()

It closes a cursor object.

setinputsizes(size_list)

It is an optional function, and receives sequence type as a parameter. It sets INPUT parameter size of SQL BindParameter.

setoutputsize(size)

It is an optional function, and is used for a purpose which is different from that of DB API, and it allocates the buffer size of OUTPUT parameter.

callproc(procname [, params])

It calls the storage procedure corresponding to procname. The parameter should be a sequence type, and it includes the output parameter. However, data located in the output parameter when inputting is meaningless. callproc function updates data corresponding to INOUT, OUT of the input parameter data, and returns it in sequence type.

```

create_proc = """CREATE OR REPLACE PROCEDURE PROC1( A1 INTEGER, A2 OUT CHAR(10) )
IS
  V1 CHAR(10);
BEGIN
  SELECT T1.I1
  INTO V1
  FROM T1
  WHERE T1.I1 >= A1 AND T1.I1 <= A1;
  A2 := V1;
END;\
"""

cursor.execute( create_proc )
result = cursor.callproc( 'PROC1', ( 1, 0 ) )

```

callfunc(funcname [, params])

It calls a function corresponding to funcname. callfunc() returns the function data.

```

create_func = """
CREATE OR REPLACE FUNCTION FUNC1( A1 INTEGER, A2 INTEGER )
RETURN INTEGER
IS
  V1 INTEGER;
BEGIN
  SELECT COUNT(*)
  INTO V1
  FROM T1
  WHERE T1.I1 >= A1 AND T1.I1 <= A2;
RETURN V1;
END;\
"""
cursor.execute( create_func )
cursor.commit()
result = cursr.callfunc( 'FUNC1', ( 1, 4) )

```

tables(table=None, catalog=None, schema=None, tableType=None)

It returns the table information of the database which satisfies the given condition. The character '_' and '%' are translated as a wild card. Each row has the following column information. For more information, refer to [SQLTables](#).

1. table_cat: It is the name of the catalog.
2. table_schem: It is the name of the schema.
3. table_name: It is the name of the table.
4. table_type: 'TABLE', 'VIEW', 'SYSTEM TABLE', 'GLOBAL TEMPORARY', 'LOCAL TEMPORARY', 'ALIAS', 'SYNONYM' or a specific type name can be a table type.
5. remarks: It is a description of a table.

```

print cursor.tables( table= 'TEST' ).fetchone()
#print table name
for row in cursor.tables():
  print row.table_name

```



If a parameter is empty, information of all table of which a user has a privilege is returned.

columns(table=None, catalog=None, schema=None, tableType=None)

It obtains the column information of the specified table through [SQLColumns](#) function. Each row includes the following column information.

1. table_cat
2. table_schem
3. table_name
4. column_name
5. data_type
6. type_name
7. column_size
8. buffer_length
9. decimal_digits
10. num_prec_radix
11. nullable
12. remarks
13. column_def
14. sql_data_type
15. sql_datetime_sub
16. char_octet_length
17. ordinal_position
18. is_nullable: SQL_NULLABLE, SQL_NO_NULLS or SQL_NULLS_UNKNOWN.

```
#print column name of table TEST
for r in cursor.columns( table = 'TEST' ):
    print r.column_name
```

statistics(table, catalog=None, schema=None, unique=False, quick=True)

It obtains the information about the specified table through `SQLStatistics` function.

If `unique` is true, it returns an unique index, and if it is false, it returns all indexes.

If `quick` is true, `CARDINALITY` and `PAGES` are returned only when it is instantly available, otherwise, `NULL` is returned to the corresponding column.

1. table_cat
2. table_schem
3. table_name
4. non_unique
5. index_qualifier
6. index_name
7. type
8. ordinal_position
9. column_name
10. asc_or_desc
11. cardinality
12. pages

13. filter_condition



A wildcard character is not allowed.

rowIdColumns(table, catalog=None, schema=None, nullable=True)

It returns the result set of columns which uniquely identifies a row by executing **SQLSpecialColumns** with **SQL_BEST_ROWID**. Each row includes the following column information.

1. scope: **SQL_SCOPE_CURROW**, **SQL_SCOPE_TRANSACTION**, or **SQL_SCOPE_SESSION**
2. column_name
3. data_type: SQL type constant of ODBC
4. type_name
5. column_size
6. buffer_length
7. decimal_digits
8. pseudo_column: **SQL_PC_UNKNOWN**, **SQL_PC_NOT_PSEUDO** or **SQL_PC_PSEUDO**

rowVerColumns(table, catalog=None, schema=None, nullable=True)

It returns the result set of columns which are automatically updated when a row is updated by executing **SQLSpecialColumns** with **SQL_ROWVER**. Each row includes the following column information.

1. scope: **SQL_SCOPE_CURROW**, **SQL_SCOPE_TRANSACTION**, or **SQL_SCOPE_SESSION**
2. column_name
3. data_type: SQL type constant of ODBC
4. type_name
5. column_size
6. buffer_length
7. decimal_digits
8. pseudo_column: **SQL_PC_UNKNOWN**, **SQL_PC_NOT_PSEUDO**, or **SQL_PC_PSEUDO**

primaryKeys(table, catalog=None, schema=None)

It returns the result set of columns which configures major keys of a table by executing **SQLPrimaryKeys** function. Each row includes the following column information.

1. table_cat
2. table_schem
3. table_name
4. column_name
5. key_seq
6. pk_name

foreignKeys(table=None, catalog=None, schema=None, foreignTable=None, foreignCatalog=None, foreignSchema=None)

It creates the result set of column names of a specified table, or the result set of column names which are foreign keys of another table referring to the basic key of the specified table, by executing **SQLForeignKey** function. Each row includes the following column information.

1. pktable_cat
2. pktable_schem
3. pktable_name
4. pkcolumn_name
5. fktable_cat
6. fktable_schem
7. fktable_name
8. fkcolumn_name
9. key_seq
10. update_rule
11. delete_rule
12. fk_name
13. pk_name
14. deferrability

procedures(procedure=None, catalog=None, schema=None)

It creates the result set of the information about the procedure by executing **SQLProcedures**. Each row includes the following column information.

1. procedure_cat
2. procedure_schem
3. procedure_name
4. num_input_params
5. num_output_params
6. num_result_sets
7. remarks
8. procedure_type

getTypeInfo(sqlType=None)

It creates the result set of the information about the specified data type or about all data types which are supported by GOLDILOCKS ODBC, by executing **SQLGetTypeInfo** function. Each row includes the following column information.

1. type_name

2. data_type
3. column_size
4. literal_prefix
5. literal_suffix
6. create_params
7. nullable
8. case_sensitive
9. searchable
10. unsigned_attribute
11. fixed_prec_scale
12. auto_unique_value
13. local_type_name
14. minimum_scale
15. maximum_scale
16. sql_data_type
17. sql_datetime_sub
18. num_prec_radix
19. interval_precision

Row

A row object is returned with fetch function of a cursor object. It is processed as a tuple type as described in DB API.

```
row = cursor.fetchone()
for column in row:
    print column
```

The following features are added to pygoldilocks.

- It can access the data by using a column name.
- It can access the value of cursor.description through a row even after a cursor object is closed.
- It can update the value of a row.

Accessing to a row by using a column name is not only convenient but it also improves the readability. However, if a column name includes Python reserved name or a whitespace, then it be accessed only through row.__getattr__().

```
cursor.execute( "select c1 from test")
print cursor.description
```

```
row = cursor.fetchone()
print row.C1
```

```
(('C1', <type 'str'>, 10, 10, 10, 0, True),)
test
```



Basically, the identifier of GOLDILOCKS database is uppercase. However, sometimes it is required to be specified in lowercase, so be cautious of using uppercase or lowercase when accessing to a row by using a column name.

Properties

- `cursor_description`

It is the copy of property description of a cursor object which created the corresponding row. For more information, refer to **Cursor.description**.

29.3 Exception

Python exceptions occur by pygoldilocks when GOLDILOCKS ODBC detects an error. The exception classes are as follows, which are the same as **Python DB API**.

- Error
 - DatabaseError
 - DataError
 - OperationalError
 - IntegrityError
 - InternalError
 - ProgrammingError
 - NotSupportedError

If an error occurs, generally, the exception is processed based on SQLSTATE value provided by the database.

SQLSTATE	Exception
0A000	NotSupportedError
01002	OperationalError
08001	OperationalError
08003	OperationalError
08004	OperationalError
08007	OperationalError
08S01	OperationalError
28000	InterfaceError
40002	IntegrityError
22***	DataError
23***	IntegrityError
24***	ProgrammingError
25***	ProgrammingError
42***	ProgrammingError

29.4 Data Type

Transferring Python Parameter to GOLDILOCKS

The data is converted as follows when transferring Python parameter to GOLDILOCKS ODBC.

Table 29-1 Python 3

Python datatype	Description	ODBC datatype
None	-	SQL_VARCHAR
str	UTF-8	SQL_VARCHAR or SQL_LONGVARCHAR
bytes, bytearray	binary	SQL_VARBINARY or SQL_LONGVARBINARY
bool	bit	SQL_BIT
datetime.date	date	SQL_TYPE_DATE
datetime.time	time	SQL_TYPE_TIME
datetime.datetime	timestamp	SQL_TYPE_TIMESTAMP
int	integer	SQL_BIGINT
float	floating point	SQL_DOUBLE
decimal	numeric	SQL_NUMERIC

Table 29-2 Python 2

Python datatype	Description	ODBC datatype
None		SQL_VARCHAR
str	UTF-8	SQL_VARCHAR or SQL_LONGVARCHAR
bytearray	binary	SQL_VARBINARY or SQL_LONGVARBINARY
buffer	binary	SQL_VARBINARY or SQL_LONGVARBINARY
bool	bit	SQL_BIT
datetime.date	date	SQL_TYPE_DATE
datetime.time	time	SQL_TYPE_TIME
datetime.datetime	timestamp	SQL_TYPE_TIMESTAMP
int	integer	32 bit: SQL_INTEGER, 64 bit: SQL_BIGINT
long	bigint	SQL_BIGINT
float	floating point	SQL_DOUBLE
decimal	numeric	SQL_NUMERIC

SQL Value Received from GOLDILOCKS

The data is converted as follows when transferring the data of GOLDILOCKS database to Python.

Table 29-3 Python 3

ODBC datatype	Description	Python datatype
any	NULL	None
SQL_CHAR, SQL_VARCHAR, SQL_LONGVARCHAR	text	text
SQL_BINARY, SQL_VARBINARY, SQL_LONGVARBINARY	binary	bytes
SQL_NUMERIC	decimal, numeric	decimal.Decimal
SQL_BOOLEAN	bit, bool	bool
SQL_SMALLINT, SQL_INTEGER	integers	int
SQL_BIGINT	long	long
SQL_REAL, SQL_FLOAT, SQL_DOUBLE	floating point	float
SQL_TYPE_TIME	time	datetime.time
SQL_TYPE_DATE	date	datetime.date
SQL_TYPE_TIMESTAMP	timestamp	datetime.timestamp
SQL_TYPE_TIME_WITH_TIMEZONE	time with timezone	text
SQL_TYPE_TIMESTAMP_WITH_TIMEZONE	timestamp with timezone	text
SQL_C_INTERVAL_***	interval	text

Table 29-4 Python 2

ODBC datatype	Description	Python datatype
any	NULL	None
SQL_CHAR, SQL_VARCHAR, SQL_LONGVARCHAR	text	text
SQL_BINARY, SQL_VARBINARY, SQL_LONGVARBINARY	binary	bytes
SQL_NUMERIC	decimal, numeric	decimal.Decimal
SQL_BOOLEAN	bit, bool	bool
SQL_SMALLINT, SQL_INTEGER	integers	int
SQL_BIGINT	long	long
SQL_REAL, SQL_FLOAT, SQL_DOUBLE	floating point	float
SQL_TYPE_TIME	time	datetime.time
SQL_TYPE_DATE	date	datetime.date
SQL_TYPE_TIMESTAMP	timestamp	datetime.timestamp
SQL_TYPE_TIME_WITH_TIMEZONE	time with timezone	text
SQL_TYPE_TIMESTAMP_WITH_TIMEZONE	timestamp with timezone	text
SQL_C_INTERVAL_***	interval	text

The text of Python data type is converted to unicode in Python 3. It is converted to the unicode or a string according to the character set of the database in Python 2.

Table 29-5 Python 2 text

DB character set	Python type
UTF-8	str
SQL_ASCII	str
UHC	unicode
GB18030	unicode

30.

Ruby

30.1 Overview

GOLDILOCKS ruby is a driver which enables to use GOLDILOCKS database in an application created with ruby, and it is provided as a RubyGem package.

GOLDILOCKS ruby driver is created based on GOLDILOCKS CLI driver.

30.2 Installation

Requirement

The client package of GOLDILOCKS should be installed in the same system as that of Ruby, and \$GOLDILOCKS_HOME environment variable should be set.

Installing/ Removing

GOLDILOCKS ruby driver can be installed/ removed by using gem.

Removing

Remove the installed GOLDILOCKS ruby driver.

```
% sudo -E gem uninstall ruby-goldilocks
```

Installing

Create the package file when GOLDILOCKS ruby driver package file does not exist.

```
% gem build goldilocks.gemspec
Successfully built RubyGem
Name: ruby-goldilocks
Version: 3.2.0
File: ruby-goldilocks-3.2.0.gem
```

Install the package file by using gem when GOLDDLOCKS ruby driver package file exists.

```
% sudo -E gem install ruby-goldilocks-3.2.0.gem
Building native extensions. This could take a while...
Successfully installed ruby-goldilocks-3.2.0
Parsing documentation for ruby-goldilocks-3.2.0
Installing ri documentation for ruby-goldilocks-3.2.0
Done installing documentation for ruby-goldilocks after 0 seconds
1 gem installed
```

30.3 Examples

Connecting

Connecting by Using DSN

```
require 'goldilocks'
$c = GOLDDLOCKS.connect("GOLDDLOCKS")
```

Connecting by Using DSN, UID, PWD

```
require 'goldilocks'
$c = GOLDDLOCKS.connect("GOLDDLOCKS", "test", "test")
```

Connecting by Using Connecting String

```
$c = GOLDDLOCKS::Database.new.drvconnect("DSN=GOLDDLOCKS")
```

```
$c = GOLDDLOCKS::Database.new.drvconnect("HOST=192.168.0.1;PORT=22581;UID=test;PWD=test")
```

Creating Table

```
$c.run("create table test (id int not null, str varchar(32) not null)")
```

Inserting Data

```
$q = $c.run("insert into test (id, str) values (1, 'foo')")
$q.run("insert into test (id, str) values (2, 'bar')")
$p = $c.proc("insert into test (id, str) values (?, ?)") {}
$p.call(3, "F00")
$p[4, "BAR"]
```

Retrieving Data

```
$q = $c.prepare("select id,str from test order by id")
if $q.column(0).name.upcase != "ID" then raise "fetch failed" end
if $q.column(1).name.upcase != "STR" then raise "fetch failed" end
$q.execute
if $q.fetch != [1, "foo"] then raise "fetch: failed" end
if $q.fetch != [2, "bar"] then raise "fetch: failed" end
if $q.fetch != [3, "F00"] then raise "fetch: failed" end
if $q.fetch != [4, "BAR"] then raise "fetch: failed" end
if $q.fetch != nil then raise "fetch: failed" end
$q.close
if $q.execute.entries != [[1, "foo"], [2, "bar"], [3, "F00"], [4, "BAR"]] then
  raise "fetch: failed"
end
$q.close
if $q.execute.fetch_all != [[1, "foo"], [2, "bar"], [3, "F00"], [4, "BAR"]] then
  raise "fetch: failed"
end
$q.close
$q.execute
if $q.fetch_many(2) != [[1, "foo"], [2, "bar"]] then raise "fetch: failed" end
if $q.fetch_many(3) != [[3, "F00"], [4, "BAR"]] then raise "fetch: failed" end
if $q.fetch_many(99) != nil then raise "fetch: failed" end
```



```

$q.close
a = []
$q.execute {|r| a=r.entries}
if a.size != 4 then raise "fetch: failed" end
$q.close
a = []
$q.execute.each {|r| a.push(r)}
if a.size != 4 then raise "fetch: failed" end
$q.close
a = []
$q.execute.each_hash {|r| a.push(r)}
if a.size != 4 then raise "fetch: failed" end
$q.close
a = []
$q.execute.each_hash(true) {|r| a.push(r)}
if a.size != 4 then raise "fetch: failed" end
$q.close
a = []
$q.execute.each_hash(:key=>:Symbol) {|r| a.push(r)}
if a.size != 4 then raise "fetch: failed" end
$q.close
a = []
$q.execute.each_hash(:key=>:Symbol,:table_names=>true) {|r| a.push(r)}
if a.size != 4 then raise "fetch: failed" end
$q.close
a = []
$q.execute.each_hash(:key=>:String,:table_names=>false) {|r| a.push(r)}
if a.size != 4 then raise "fetch: failed" end
$q.close
a = []
$q.execute.each_hash(:key=>:Fixnum,:table_names=>false) {|r| a.push(r)}
if a.size != 4 then raise "fetch: failed" end
$q.close

```

Updating Data

```

$q = $c.run("update test set id=0, str='hoge'")
if $q.nrows != 4 then
  $stderr.print "update row count: expected 4, got ", $q.nrows, "\n"

```

```
end
```

Deleting Data

```
$count = $c.do("delete from test where 1 = 1")
if $count != 4
  $stderr.print "delete row count: expected 4, got ", $count, "\n"
end
$count = $c.do("delete from test where 1 = 1")
if $count != 0
  $stderr.print "delete row count: expected 0, got ", $count, "\n"
end
```

Arranging All Created Statement

```
$c.drop_all
```

Dropping Table

```
$c.do("drop table test")
```

Disconnecting

```
$c.disconnect
```

30.4 Examples of ActiveRecord

The following table is created in advance as an example.

```
CREATE TABLE members
(
  id          INTEGER GENERATED BY DEFAULT AS IDENTITY PRIMARY KEY,
  name       VARCHAR(255),
  email      VARCHAR(255),
  created_at TIMESTAMP,
  updated_at TIMESTAMP
);
```

Connecting

```
require 'rubygems'
require 'active_record'
require 'goldilocks'
ActiveRecord::Base.establish_connection(
  :adapter => "goldilocks",
  :host => "192.168.0.1",
  :port => "22581",
  :uid => "TEST",
  :pwd => "test",
  :option => "" )
```

The property values for the connection are as follows.

Property	Description
:adapter	goldilocks
:dsn	ODBC data source name (DSN)
:host	IP address of a server
:port	PORT number of a server
:uid	User ID
:pwd	User password
:opt	Connection string

Inserting Data

```
class Members < ActiveRecord::Base
end
```

```
Members.create(:name => "David", :email => "David@mail.com")
Members.create(:name => "Olivia", :email => "Olivia@mail.com")
Members.create(:name => "Amelia", :email => "Amelia@mail.com")
Members.create(:name => "Hazel", :email => "Hazel@mail.com")
Members.create(:name => "Lily", :email => "Lily@mail.com")
```

Retrieving Data

```
require 'pp'
puts "\nfind(1)"
puts '-'*80
David = Members.find(1)
pp(David)
puts '-'*80
puts "\nwhere(:name => \"Amelia\")"
puts '-'*80
Amelia = Members.where(:name => "Amelia")
pp(Amelia)
puts '-'*80
puts "\nfind_each"
puts '-'*80
Members.find_each do |member|
  pp(member)
end
puts '-'*80
```

Updating Data

```
puts "\nupdate Lily -> Harry"
puts '-'*80
Members.transaction do
  Lily = Members.where(:name => 'Lily')[0]
  Lily.name = 'Harry'
  Lily.save
end
puts "\nfind_each"
Members.find_each do |member|
```

```
pp(member)
end
puts '-'*80
```

Deleting Data

```
puts "\ndelete Harry"
puts '-'*80
Members.transaction do
  Harry = Members.where(:name => 'Harry')[0]
  Harry.destroy
end
puts "\nfind_each"
Members.find_each do |member|
  pp(member)
end
puts '-'*80
```

31.

Hibernate

31.1 Overview

Hibernate is a Object-Relational Mapping (ORM) framework of which Java Persistent API (JPA) model is applied to the database. It maps the relationship between DB table and Java object so that it helps the persistent logic processing. In other words, when using hibernate, it is easy to access and control DB without using SQL.

31.2 Interworking with Hibernate

Downloading Hibernate

Hibernate can be downloaded at <https://sourceforge.net/projects/hibernate/>. When the downloaded file is decompressed, many jar files are found in lib directory. These files are used to interwork with hibernate.



Hibernate of GOLDBLOCKS is created based on Hibernate version 5.2.

Interworking with GoldilocksDialect Class

It should be ported to the downloaded Hibernate jar file to interwork with Hibernate. GoldilocksDialect.class file and GoldilocksDialect\$1.class file can be included in Hibernate jar file as follows.

1. Decompress Hibernate jar file.
2. Move GoldilocksDialect.class file and GoldilocksDialect\$1.class file to the decompressed org/hibernate/dialect directory.
3. Compress it again with Hibernate jar file.
4. Add the newly created jar file to classpath.

```
$ jar -xvf hibernate-core-5.2.11.Final.jar
$ pwd
hibernate-release-5.2.11.Final/lib/required/
$ mv GoldilocksDialect*.class org/hibernate/dialect/
$ jar -cvf hibernate.5.2.11.jar META-INF/MANIFEST.MF .
```

31.3 Examples

Configuration

hibernate-configuration XML file and hibernate-mapping XML file are required to interwork Hibernate and DB.

Hibernate Configuration File

Configuration XML file sets the connect information to access the dialect class and DB, and sets Hibernate-mapping files.

For more information, refer to **Configuration**.

The following is an example of hibernate.conf.xml file.

```
<?xml version="1.0" encoding="utf-8"?>
<!DOCTYPE hibernate-configuration PUBLIC
"-//Hibernate/Hibernate Configuration DTD 3.0//EN"
"http://www.hibernate.org/dtd/hibernate-configuration-3.0.dtd">

<hibernate-configuration>
  <session-factory>
    <property
name="hibernate.connection.driver_class">sunje.goldilocks.jdbc.GoldilocksDriver</property>
    <property
name="hibernate.connection.url">jdbc:goldilocks://192.168.0.21:22581/test</property>
    <property name="hibernate.connection.username">test</property>
    <property name="hibernate.connection.password">test</property>
    <property name="hibernate.dialect">org.hibernate.dialect.GoldilocksDialect</property>
    <property name="show_sql">>true</property>
    <property name="format_sql">>true</property>
    <property name="hbm2ddl.auto"> create </property>
    <mapping resource="SampleTable.mapping.xml" />
  </session-factory>
</hibernate-configuration>
```

Set the DB connecting information on `<session-factory>` tag, and specifies the dialect class name of DB to connect to `hibernate.dialect` property. Also, specify hibernate-mapping files by using `<mapping-resource>` tag.

Hibernate Mapping File

Mapping XML is a configuration file including mapping information about DB table and Java object. For more information, refer to **Mapping**.

The following is an example of SampleTable.mapping.xml file which was used in the example above.

```
<?xml version="1.0" encoding="UTF-8"?>
<!DOCTYPE hibernate-mapping PUBLIC
"-//Hibernate/Hibernate Mapping DTD 3.0//EN"
"http://hibernate.sourceforge.net/hibernate-mapping-3.0.dtd">
<hibernate-mapping>
  <class name="SampleTable" table="SAMPLETABLE">
    <id column="ID" name="id" type="long">
      <generator class="increment" />
    </id>
    <property column="STUDENT_NAME" name="name" type="string" />
    <property column="BIGINT_VALUE" name="bigintValue" type="long" />
    <property column="INT_VALUE" name="intValue" type="int" />
    <property column="SMALL_VALUE" name="smallValue" type="short" />
    <property column="FLOAT_VALUE" name="floatValue" type="float" />
    <property column="DOUBLE_VALUE" name="doubleValue" type="double" />
    <property column="NUMERIC_VALUE" name="numericValue" type="big_integer" precision="10"
scale="5" />
    <property column="DATE_VALUE" name="dateValue" type="date" />
    <property column="TIME_VALUE" name="timeValue" type="time" />
    <property column="TIMESTAMP_VALUE" name="timestampValue" type="timestamp" />
    <property column="VARBINARY_VALUE" name="binaryValue" type="byte[]" />
  </class>
</hibernate-mapping>
```

The mapping information about Java class and DB table are described on <class> tag. Data type used in a table column and Java are specified on <property> tag.

Examples of Application

Java class to be mapped to DB table should be described. The following is an example of SampleTable.jav a which is described above.

```
import java.math.BigInteger;
import java.sql.Date;
import java.sql.Time;
import java.sql.Timestamp;
public class SampleTable {
    private long id;
    private String name;
    private long bigintValue;
    private int intValue;
    private short smallValue;
    private float floatValue;
    private double doubleValue;
    private BigInteger numericValue;
    private Date dateValue;
    private Time timeValue;
    private Timestamp timestampValue;
    private byte[] binaryValue;
    private String longvarcharValue;
    private byte[] longvarbinaryValue;

    public SampleTable() {
        this.name = null;
    }

    public SampleTable( String name ) {
        this.name = name;
    }

    public long getId() {
        return id;
    }

    public void setId( long id ) {
        this.id = id;
    }

    public String getName() {
        return name;
    }

    public void setName( String name ) {
        this.name = name;
    }
}
```

```

    }
    ....

```

get/ set function of a variable corresponding to a column of SampleTable table should be described.

The data is processed in SampleTable table as follows.

1. It obtains org.hibernate.SessionFactory object through a configuration file.
2. It obtains org.hibernate.Session object through SessionFactory object.
3. It processes the desired operation by calling a method of a session object.

The following is an example of inserting, updating, retrieving, deleting data in SampleTable table of DB. It obtains SessionFactory object through org.hibernate.Configuration class.

```

public class HibernateSample
{
    private static SessionFactory mFactory;
    public static void main( String[] args ) {
        try {
            mFactory = new Configuration().configure( "hibernate.conf.xml"
).buildSessionFactory();
        } catch( Throwable ex ) {
            System.err.println( "Failed to create sessionFactory object." + ex);
            throw new ExceptionInInitializerError(ex);
        }
        HibernateSample sHibernateSample = new HibernateSample();

```

- Insert 3 records

```

Long sRecord1 = sHibernateSample.addSample( "RECORD_1" );
Long sRecord2 = sHibernateSample.addSample( "RECORD_2" );
Long sRecord3 = sHibernateSample.addSample( "RECORD_3" );

```

- Update record 1

```

sHibernateSample.updateSample( sRecord1, ....

```

- Fetch table

```

sHibernateSample.fetchSample( 0, 3 );

```

- Delete record 2

```
sHibernateSample.deleteSample( sRecord2 );
sHibernateSample.closeFactory();
    }
public void closeFactory() {
    mFactory.close();
}
....
```

The following is an example of a method inserting a record to HibernateSample class. First, it obtains a session object through SessionFactory class, then obtains org.hibernate.Transaction object. It can be committed or rolled back after starting a transaction by using a transaction class and inserting a record.

```
public Long addSample( String name ) {
    Session session = mFactory.openSession();
    Transaction tx = null;
    Long id = null;

    try{
```

- Begin transaction

```
tx = (Transaction) session.beginTransaction();
SampleTable sample = new SampleTable( name );
```

- Insert

```
id = (Long) session.save(sample);
```

- Commit transaction

```
tx.commit();

        System.out.println("add success");
    } catch( HibernateException e) {
        if( tx != null ) {
            tx.rollback();
        }
        System.out.println("add fail");
        e.printStackTrace();
    } finally {
        session.close();
    }
```

```

    return id;
}

```

The following is an example of a method retrieving SampleTable table. It obtains org.hibernate.Query object through a session class. fetchSample method retrieves SampleTable from offset to count.

```

public void fetchSample( int offset, int count ) {
    Session session = mFactory.openSession();
    Query query = null;

    try{
        query = session.createQuery( "FROM SampleTable" );
        query.setFirstResult( offset );
        query.setMaxResults( count );
        query.setFetchSize( 20 );

        @SuppressWarnings( "unchecked" )
        List<SampleTable> samples = (List<SampleTable>) query.list();
        for( Iterator<SampleTable> iter = samples.iterator(); iter.hasNext(); ) {
            SampleTable sample = (SampleTable) iter.next();
            System.out.print( "id: " + sample.getId() );
            ... Ellipsis ...
        }
    } catch ( HibernateException e ) {
        e.printStackTrace();
    } finally {
        session.close();
    }
}

```

The following is an example of a method updating SampleTable table. After altering to a set method described in SampleTable class, then it is updated by calling an update method of a session class.

```

public void updateSample( long id, ... ) {
    Session session = mFactory.openSession();
    Transaction tx = null;
    try {
        tx = session.beginTransaction();
        SampleTable sample = (SampleTable)session.get(SampleTable.class, id);
        sample.setName( name );
        ...
        session.update( sample );
    }
}

```

```

        tx.commit();
        System.out.println( "update success" );
    } catch ( HibernateException e ) {
        if( tx != null ){
            tx.rollback();
        }
        System.out.println("update fail");
        e.printStackTrace();
    } finally {
        session.close();
    }
}

```

The following is an example of deleting a record. It can be deleted by using a delete method of a session class.

```

public void deleteSample( long id ) {
    Session session = mFactory.openSession();
    Transaction tx = null;

    try {
        tx = session.beginTransaction();
        SampleTable sample = (SampleTable) session.get( SampleTable.class, id );
        session.delete( sample );
        tx.commit();

        System.out.println( "delete success" );
    } catch ( HibernateException e ) {
        if( tx != null ) {
            tx.rollback();
        }
        System.out.println("delete fail");
        e.printStackTrace();
    } finally {
        session.close();
    }
}

```

Part VI.

Utility Manual

32. gcreatedb	3,265
32.1 Overview of gcreatedb	3,266
Definition	3,266
Feature	3,266
Usage	3,266
Options	3,266
Example	3,267
32.2 Command Option	3,268
--cluster	3,268
--db_name	3,268
--db_comment	3,268
--timezone	3,268
--character_set	3,268
--char_length_units	3,269
--home	3,269
--member	3,269
--host	3,270
--port	3,270
--silent	3,270
--help	3,270
33. glsnr	3,273
33.1 Overview of glsnr	3,274
33.2 Command Options	3,275
--silent	3,275
--start	3,275
--stop	3,275
--status	3,276
--home	3,276
--help	3,277
33.3 Listener Configuration	3,278
Configuration File and Environment Variables	3,278
LISTEN_PORT	3,278
TCP_HOST	3,279
BACKLOG	3,279
DEFAULT_CS_MODE	3,279
TCP_VALIDNODE_CHECKING	3,280
TCP_INVITED_FILE	3,280
TCP_EXCLUDED_FILE	3,281
TIMEOUT	3,281

LISTENER_LOG_DIR	3,282
UDS_DIR	3,282
34. gsql/gsqlnet (Interactive SQL Tool)	3,283
34.1 Overview of gsql	3,284
Definition	3,284
Examples	3,284
34.2 Executing gsql	3,288
Information of gsql	3,288
Server Connection	3,289
Controlling Interactive Mode	3,290
Storing gsql configuration	3,291
34.3 Using Interactive Command	3,294
gsql Interactive Mode Command	3,294
Startup and Shutdown Server	3,296
Executing SQL Statements	3,300
Controlling Output Result	3,310
Logging Output Result	3,316
Querying SQL Object Information	3,317
Output DDL Statement of SQL Object	3,318
Controlling History	3,321
Editing SQL	3,322
Controlling Connection	3,323
Using Host Variable	3,324
Controlling Method of Treating SQL Statement	3,325
Information of SQL Execution Plan	3,330
34.4 Command Option Reference	3,332
Username Password	3,332
--as {SYSDBA ADMIN}	3,332
--conn-string	3,333
--dsn	3,333
--enable-color	3,334
--help	3,335
--import	3,336
--no-prompt	3,337
--prompt	3,337
--silent	3,338
--version	3,339
34.5 Interactive Command References	3,340
\ \	3,340

<code>\connect</code>	3,341
<code>\cstartup</code>	3,342
<code>\cshutdown</code>	3,343
<code>\ddl_cluster</code>	3,344
<code>\ddl_db</code>	3,345
<code>\ddl_tablespace</code>	3,349
<code>\ddl_profile</code>	3,350
<code>\ddl_audit_policy</code>	3,351
<code>\ddl_auth</code>	3,352
<code>\ddl_schema</code>	3,355
<code>\ddl_publicsynonym</code>	3,358
<code>\ddl_table</code>	3,359
<code>\ddl_constraint</code>	3,361
<code>\ddl_index</code>	3,362
<code>\ddl_view</code>	3,363
<code>\ddl_sequence</code>	3,364
<code>\ddl_synonym</code>	3,366
<code>\ddl_procedure</code>	3,366
<code>\desc</code>	3,367
<code>\dynamic sql :var</code>	3,369
<code>\edit</code>	3,371
<code>\exec</code>	3,374
<code>\exec :var := value</code>	3,376
<code>\exec sql</code>	3,380
<code>\explain plan</code>	3,381
<code>\help</code>	3,382
<code>\host</code>	3,384
<code>\history</code>	3,384
<code>\import</code>	3,385
<code>\idesc</code>	3,387
<code>\{n}</code>	3,388
<code>\prepare sql</code>	3,389
<code>\print</code>	3,390
<code>\quit</code>	3,392
<code>\set autocommit</code>	3,392
<code>\set autotrace</code>	3,394
<code>\set color</code>	3,395
<code>\set colsize</code>	3,396
<code>\set ddlsize</code>	3,398

\set error	3,399
\set heading	3,400
\set history	3,401
\set linesize	3,402
\set numsize	3,404
\set pagesize	3,405
\set serveroutput	3,406
\set time	3,408
\set timing	3,408
\set vertical	3,409
\shutdown	3,411
\spool	3,412
\startup	3,414
\var	3,415
35. gloder/gloadernet (Upload/download Tool)	3,419
35.1 Overview of gloder and gloadernet	3,420
Environment	3,420
Example	3,422
35.2 Using gloder	3,424
Datafile Type	3,424
Downloading Data	3,424
Uploading Data	3,432
Troubleshooting for Uploading	3,441
35.3 Control File Syntax	3,447
CHARACTERSET	3,447
TABLE	3,448
FIELDS TERMINATED BY	3,449
OPTIONALLY ENCLOSED BY	3,449
LINES TERMINATED BY	3,450
LTRIM	3,451
RTRIM	3,452
WHERE	3,453
35.4 gloder Argument References	3,454
Usage	3,454
Mandatory Argument	3,455
Optional Argument	3,456
36. gdump	3,469
36.1 Overview of gdump	3,470
Definition	3,470

Argument	3,470
36.2 Examples of Using gdump	3,473
Control File	3,473
Datafile	3,475
Log File	3,477
Incremental Backup File	3,479
Property File	3,482
Commit Log	3,483
Log Buffer File	3,484
Pending Log Buffer File	3,484
37. tablediff	3,487
37.1 Overview of tablediff	3,488
Background	3,488
Features	3,488
Characteristics	3,489
File Configuration	3,489
37.2 Usage	3,490
Command Usage	3,490
Property Option	3,491
38. gsyncher	3,497
38.1 Overview of gsyncher	3,498
Definition	3,498
Features	3,498
Usage	3,498
Options	3,498
38.2 Examples	3,499
39. gmon	3,503
39.1 Overview of gmon	3,504
Definition	3,504
Features	3,504
Usage	3,504
Options	3,504
39.2 Examples	3,505
40. gtrclogger	3,507
40.1 Overview of gtrclogger	3,508
Definition	3,508
Features	3,508
Usage	3,508

Options	3,509
40.2 Examples	3,510
41. glocator	3,511
41.1 Overview of glocator	3,512
Definition	3,512
Usage	3,512
Options	3,512
41.2 Using glocator	3,516
Data File	3,516
CSTARTUP and CSHUTDOWN	3,516
Replication	3,517
41.3 Features of glocator	3,519
Connection Service	3,519
Cluster Failover	3,520
41.4 glocator Configuration	3,521
Configuration File and Environment Variable	3,521
Configuration Properties	3,521
42. gagent	3,527
42.1 Overview of gagent	3,528
Definition	3,528
Usage	3,528
Options	3,528
42.2 gagent Configuration	3,532
Configuration File and Environment Variable	3,532
Configuration Properties	3,532
43. gloctl	3,537
43.1 Overview of gloctl	3,538
Definition	3,538
Usage	3,538
Options	3,538
43.2 Interactive Command References	3,542
ADD MEMBER	3,542
ADD SERVICE	3,543
DROP MEMBER	3,544
DROP SERVICE	3,544
EXPORT	3,545
HELP	3,545
IMPORT	3,546

QUIT	3,547
SET TIMEOUT	3,547
43.3 Location File	3,548
Description	3,548
43.4 Configuration	3,550
PORT	3,550
LOCATOR_HOST	3,550
LOCATOR_PORT	3,550
MESSAGE_TIMEOUT	3,551

32.

gcreatedb

32.1 Overview of gcreatedb

Definition

gcreatedb is a database creation utility provided by GOLDDILOCKS.

Feature

A new database is created by using DB_Name, comment, time zone, character set specified by a user.

Usage

```
gcreatedb [options]
```

Options

```
--cluster          cluster system (if not specified, stand-alone system)
--db_name          database name
--db_comment       database comment
--timezone         timezone ( {+/-}{TZH:TZM} )
--character_set    character set
                   SQL_ASCII
                   UTF8
                   UHC
                   GB18030
--char_length_units char length units
                   OCTETS
                   CHARACTERS
--home             home directory
--member          local member name
--host            host address
--port           host port
--silent         suppresses the display of the result message
```

`--help` print help message

Example

```
$ gcreatedb --db_name="goldilocks" --db-comment="goldilocks database" --timezone="+09:00"  
--character_set="UTF8" --silent
```

32.2 Command Option

--cluster

It creates the database of a cluster environment.

If this option is not used, then it creates the database of a stand alone environment.

--db_name

It specifies the database name which a user wants to create.

The default value is "goldilocks".

The maximum length of database name is 128.

--db_comment

It specifies the database comment which a user wants to create.

The default value is "goldilocks database".

The maximum length of database comment is 1024.

--timezone

It is the time zone value of database.

The default value is the **TIMEZONE** value of the property.

The property is applied when database is created and it has a value in range of '-14:00' ~ '+14:00'.

--character_set

It is the database character set.

The default value is the **CHARACTER_SET** value of the property.

The property is applied when database is created, and its value is set to one of the followings.

- GB18030

- SQL_ASCII
- UHC
- UTF8

--char_length_units

It is the char length unit value which is used when defining the string column type such as CHAR, VARCHAR and omitting its char length unit as follows.

```
CREATE TABLE t1
(
  id CHAR( 10 OCTETS ),           ❶ It refers to 10 bytes.
  name VARCHAR( 128 CHARACTERS ), ❷ It refers to 128 characters.
  addr VARCHAR( 1024 )           ❸ char length unit is omitted.
```

The default value is the **CHAR_LENGTH_UNITS** value of the property.

The property is applied when database is created, and its value is set to one of the followings.

- OCTETS: It is the number of bytes.
- CHARACTERS: It is the number of characters.

The default value of char length unit is defined as CHARACTERS in the SQL standard and it is defined as follows in other DBMS.



- OCTETS is used in Oracle, DB2.
- CHARACTERS is used in MS-SQL, MySQL, PostgreSQL.

--home

It sets the home directory of the database.

The default value uses \$GOLDILOCSK_HOME environment variable.

--member

It sets the name of a local database in a cluster environment.

--host

It sets the host address of a local database in a cluster environment.

--port

It sets the port number of a local database in a cluster environment.

--silent

Result messages are not displayed.

--help

Help messages are displayed.

```
$ gcreatedb --help
Usage
  gcreatedb [options]
Options:
  --db_name           database name
  --db_comment       database comment
  --timezone          timezone ( {+/-}{TZH:TZM} )
  --character_set    character set
                    SQL_ASCII
                    UTF8
                    UHC
                    GB18030
  --char_length_units char length units
                    OCTETS
                    CHARACTERS
  --silent           suppresses the display of the result message
  --help            print help message
examples:
  gcreatedb --db_name="goldilocks" --db_comment="goldilocks database" --timezone="+09:00"
```

| `--character_set="UTF8" --char_length_units="OCTETS" --silent`

33.

glsnr

33.1 Overview of glsnr

glsnr is a listener which GOLDILOCKS enables remote access through the network in the client/ server environment. glsnr should be run on the server for the network access to GOLDILOCKS.

glsnr is used as follows.

```
| $ glsnr [options]
```

33.2 Command Options

The followings are cell prompt options for using glsnr.

--silent

Description

It does not display the message for execution.

Example

```
$ glsnr --start --silent
```

--start

Description

It starts running glsnr. If glsnr is already running, an error occurs.

Example

```
$ glsnr --start  
Listener is started successfully.
```

--stop

Description

It stops the currently running glsnr.

Example

```
$ glsnr --stop  
Listener is stopped.
```

--status

Description

It displays the message about glsnr status.

Example

```
$ glsnr --status  
Listener is not running.  
$ glsnr --start  
Listener is started successfully.  
$ glsnr --status  
Listener process ID : 27880  
Listener configuration file : /home/goldilocks/goldilocks_home/conf/goldilocks.listener.conf  
Unix Domain Path : /tmp/unix-glsnr.22581  
TCP Listen Host : 0.0.0.0, Port : 22581  
default C/S mode : Dedicated  
Connection Timeout(second) : 100  
Listener is running.
```

--home

Description

It sets db home.

Example

```
$ glsnr --start --home Gliese/home/g1n1_home  
Listener is started successfully.  
$ glsnr --status
```

```
Listener process ID : 20777
Listener configuration file :
/home/goldilocksk/Gliese/home/g1n1_home/conf/goldilocks.listener.conf
Unix Domain Path : /tmp/unix-glsnr.22581
TCP Listen Host : 0.0.0.0, Port : 22581
default C/S mode : Dedicated
Connection Timeout(second) : 100
Listener is running.
```

--help

Description

It displays the help message.

Example

```
$ glsnr --help

Usage:
  glsnr [options]

Options:

  --silent      don't print message
  --start       start listener
  --stop        stop listener
  --status      show listener status
  --help        show listner help messages
```

33.3 Listener Configuration

Configuration File and Environment Variables

glsnr uses the configuration file or environment variables for setting the configuration.

The environment variable is specified by using the name which 'GOLDILOCKS_' is added to the property name of the configuration as a prefix. For example, setting the LISTEN_PORT in configuration file is as same as specifying \$GOLDILOCKS_LISTEN_PORT.

The contents of configuration file precedes the environment variable settings. (In other words, environment variables are applied only if the configuration file is not set.)

The environment file of glsnr is \$GOLDILOCKS_DATA/conf/goldilocks.listener.conf. If the corresponding file is changed or the environment variables are set and glsnr is started to run, then the glsnr driving environment is modified.

If a user want to modify and apply the glsnr environment during running glsnr, a user should stop glsnr and change the content of configuration file or set the environment variable and then restart glsnr.

If a user stops the glsnr, a problem does not occur for the client which is already connected, but the problem occurs when being connected from a new client.

LISTEN_PORT

It is the port on which the glsnr waits for the connection.

Item	Description
Name	LISTEN_PORT
Description	It is the port on which the glsnr waits for a connection.
Data type	INT
Default value/ range	22581 / 1024 ~ 49151

Description

The client who wants a TCP connection should try to connect to the specified port.

The port is available from 1024 to 49151.

TCP_HOST

It is an IP address of NIC of which glsnr waits for the connection.

Item	Description
Name	TCP_HOST
Description	It is the IP address which the glsnr binds.
Data type	ip address (ip v4)
Default value	0.0.0.0

Description

The client who wants a TCP connection should access the IP address specified above. The IP address is used in ip v4 format.

BACKLOG

It is the number of clients which the glsnr can handle when multiple clients simultaneously access.

Item	Description
Name	BACKLOG
Description	It is the number of client of which glsnr waits for the connection.
Data type	INT
Default value/ range	1024 / 1 ~ 32768

Description

This setting value does not guarantee the number of concurrent connector of the client.

DEFAULT_CS_MODE

It sets the access mode when the access mode is not designated as dedicated or shared on the client.

Item	Description
Name	DEFAULT_CS_MODE
Description	It sets the default access mode.

Item	Description
Data type	String (dedicated shared)
Default value	dedicated

Description

- The client/ server mode connected via glsnr supports two modes, which are dedicated and shared.
- Generally, the access mode is set as dedicated or shared on the client (It is .odbcini for ODBC), then it accesses. However, if it is not set on the client, the access mode is determined by setting DEFAULT_CS_MODE.

TCP_VALIDNODE_CHECKING

It sets whether to check the validity of the client attempting to access.

Item	Description
Name	TCP_VALIDNODE_CHECKING
Description	It sets whether to check the client validity.
Data type	String (NO INVITED EXCLUDED)
Default value	NO

Description

- If the value is set to *NO*, the client validity is not checked.
- If the value is set to *INVITED* and the file set in TCP_INVITED_FILE exists, then only the client having the IP address of the file set in TCP_INVITED_FILE is set to be valid.
- If the value is set to *EXCLUDED* and the file set in TCP_EXCLUDED_FILE exists, then only the client excluding the client who has IP address of the file set in TCP_EXCLUDED_FILE is set to be valid.

TCP_INVITED_FILE

It is used only when the value of TCP_VALIDNODE_CHECKING is *INVITED*.

Item	Description
Name	TCP_INVITED_FILE
Description	It is the file with the valid user (IP address) list.
Data type	String

Item	Description
Default value	'goldilocks.invited.conf'

Description

If the set file exists, only the user (IP address) within the file is allowed to access.

TCP_EXCLUDED_FILE

It is used only when the value of TCP_VALIDNODE_CHECKING is *EXCLUDED*.

Item	Description
Name	TCP_EXCLUDED_FILE
Description	It is the file with the invalid user (IP address) list.
Data type	String
Default value	'goldilocks.excluded.conf'

Description

If the set file exists, anyone except for the user (IP address) within the file is allowed to access.

TIMEOUT

It is the glsnr timeout value and its unit is second.

Item	Description
Name	TIMEOUT
Description	glsnr timeout
Data type	INT
Default value/ range	100 / (0 ~ 2147483647)

Description

If the response is too slow or there is not a response from the client when glsnr communicates with the client, the connection is released by the specified timeout.

LISTENER_LOG_DIR

It sets the directory which stores the log to be display from the glsnr.

Item	Description
Name	LISTENER_LOG_DIR
Description	It sets the directory which stores the log of the glsnr.
Data type	String
Default value	'<GOLDILOCKS_DATA>/trc'

Description

<GOLDILOCKS_DATA> of the setting value is replaced with the value of the environment variable \$GOLDILOCKS_DATA.

UDS_DIR

It sets the directory in which the Unix Domain Socket file used in glsnr is stored.

Item	Description
Name	UDS_DIR
Description	It sets the directory in which the Unix Domain Socket file used in glsnr is stored.
Data type	String
Default value/ range	'/tmp' / Maximum 60 byte

Description

The maximum length of the directory should be set within 60 bytes. The absolute path of the Unix Domain Socket file (directory name + file name) depends on OS, but usually it is around 100 bytes.

34.

gsq/gsqlnet (Interactive SQL Tool)

34.1 Overview of gsql

The followings are execution files.

Table 34-1 Execution files

Execution file name	Description
gsql	It is used in Direct Attach (D/A) environment.
gsqlnet	It is used in Client/ Server (C/S) environment.



All commands supported by gsql are equally supported by gsqlnet.

Definition

gsql is an interactive utility for processing SQL statements provided by GOLDILOCKS.

Using gsql, a user can query the results of the SELECT statement as well as execute SQL statements without any application.

gsql program executes the SQL statement, and queries a brief information of the objects such as tables and indexes through the gsql specific commands beginning with \, and it provides various features such as startup or shutdown of the server, controlling the output, and querying the execution plan of SQL statement.

Examples

This chapter describes the method of creating/dropping the table, manipulating data, performing a query by using gsql.

gsql is operated in an interactive mode as follows. When connecting normally, it waits for entering the SQL statement or gsql command with *gSQL>* prompt.

```
% gsql test test
Connected to GOLDILOCKS Database.
gSQL>
```

Create a table by executing **CREATE TABLE** statement and commit the transaction as follows.

```
gSQL> CREATE TABLE t1 ( id INTEGER, name VARCHAR(128) );
Table created.
gSQL> COMMIT;
Commit complete.
```

Insert the data into the created table by executing **INSERT INTO** statement, then commit the transaction as follows. The second INSERT statement is an example of inserting two rows.

```
gSQL> INSERT INTO t1 VALUES ( 1, 'leekmo' );
1 row created.
```

- Two rows are inserted.

```
gSQL> INSERT INTO t1 VALUES ( 2, 'mkkim' ), ( 3, 'xcom73' );
2 rows created.
gSQL> COMMIT;
Commit complete.
```

The column `addr` is added to the table and data is updated by executing **UPDATE** statement as follows.

```
gSQL> ALTER TABLE t1 ADD COLUMN ( addr VARCHAR(1024) );
Table altered.
gSQL> UPDATE t1 SET addr = 'Seoul, Korea' WHERE id = 1;
1 row updated.
gSQL> UPDATE t1 SET addr = 'Inchon, Korea' WHERE id = 3;
1 row updated.
gSQL> COMMIT;
Commit complete.
```

The inserted data is queried by using **SELECT** query as follows. The query result consists of the header representing column names and the information of each row in a single line. NULL is expressed in lowercase null.

```
gSQL> SELECT * FROM t1 ORDER BY 1;
ID NAME  ADDR
-----
1 leekmo Seoul, Korea
2 mkkim  null
3 xcom73 Inchon, Korea
3 rows selected.
```

A host variable is declared, and the value is put in the host variable then a query using the host variable is

performed as follows.

```
gSQL> \var v_id INTEGER
gSQL> \exec :v_id := 1
gSQL> SELECT * FROM t1 WHERE id = :v_id;
ID NAME  ADDR
-- -----
1 leekmo Seoul, Korea
1 row selected.
```

The SQL statement is prepared by using `\prepare sql` and the SELECT statement above is repeatedly performed by using `\exec`, changing the value of host variable. ODBC and JDBC simulate prepare/ execute operation in gsql interactive mode as follows.

```
gSQL> \var v_id INTEGER
gSQL> \prepare sql SELECT * FROM t1 WHERE id = :v_id;
SQL prepared.
gSQL> \exec :v_id := 2
gSQL> \exec
ID NAME  ADDR
-- -----
2 mkkim null
1 row selected.
gSQL> \exec :v_id := 3
gSQL> \exec
ID NAME  ADDR
-- -----
3 xcom73 Incheon, Korea
1 row selected.
```

A scrollable cursor is declared in an embedded SQL, ODBC, JDBC, and the data retrieval using the cursor is simulated via gsql as follows. The cursor `cur1` declared by using `DECLARE cursor_name` is the scrollable KEYSET cursor and various fetch orientations may be used by using `FETCH cursor_name`.

```
gSQL> \var v_id INTEGER
gSQL> \var v_name VARCHAR(128)
gSQL> DECLARE cur1 KEYSET CURSOR FOR SELECT id, name FROM t1 ORDER BY id;
Cursor declared.
gSQL> OPEN cur1;
Cursor is open.
gSQL> FETCH cur1 INTO :v_id, :v_name;
V_ID V_NAME
```

```

-----
      1 leekmo
1 row fetched.
gSQL> FETCH cur1 INTO :v_id, :v_name;
V_ID V_NAME
-----
      2 mkkim
1 row fetched.
gSQL> FETCH cur1 INTO :v_id, :v_name;
V_ID V_NAME
-----
      3 xcom73
1 row fetched.
gSQL> FETCH cur1 INTO :v_id, :v_name;
no rows fetched.
gSQL> FETCH ABSOLUTE 2 cur1 INTO :v_id, :v_name;
V_ID V_NAME
-----
      2 mkkim
1 row fetched.
gSQL> FETCH PRIOR cur1 INTO :v_id, :v_name;
V_ID V_NAME
-----
      1 leekmo
1 row fetched.
gSQL> CLOSE cur1;
Cursor closed.

```

The created table t1 is dropped and the gsql interactive mode is terminated as follows.

```

gSQL> DROP TABLE t1;
Table dropped.
gSQL> COMMIT;
Commit complete.
gSQL> \q
%
```

34.2 Executing gsql

Information of gsql

Refer to the following options.

Table 34-2 Options

Option	Description
<code>--help</code>	Option list
<code>--version</code>	gsql version information

A user can view the gsql command options which are executable at the shell prompt via `--help` option as follows.

```
% gsql --help
Usage
  gsql [user_name [password]] [options]
Arguments:
  user_name      user name
  password       password
Options:
  --version          print version information and exit
  --import FILE     import sql FILE
... Ellipsis ...
%
```

gsql program has a version separate from GOLDILOCKS server version, and the version is viewed by using `--version` option as follows. It is recommended to use the gsql program in the same version as the GOLDILOCKS server.

```
% gsql --version
%
```

The version of GOLDILOCKS server can be view via **VERSION** function as follows.

```
gSQL> SELECT version() FROM dual;
VERSION()
-----
1 row selected.
```

Server Connection

Refer to the following options.

Table 34-3 Options

Option	Description
Username Password	It is the user and password of connection.
--as {SYSDBA ADMIN}	It specifies the connection role.
--conn-string	It specifies the connection string.
--dsn	It specifies Data Source Name (DSN).

User Connection

Using gsql program, it can be connected to GOLDILOCKS server in various ways.

The simplest way to connect is using a username and password as follows. The following is an example that the test user connects to it by using the test password. When successfully connected, it operates in an interactive mode and the *gSQL>* prompt waits for the user command.

```
% gsql test test
Connected to GOLDILOCKS Database.
gSQL>
```

The following is an example that an error occurs when using an invalid username or password. When the login is failed, an error message is displayed and then the gsql program is terminated.

```
% gsql test invalid_password
ERR-28000(16004): invalid username/password; logon denied
%
```

The following is an example that an error occurs when the GOLDILOCKS server does not run. The gsql program is terminated with the error message as follows.

```
% gsql test test
ERR-HY000(11031): Unable to attach the shared memory segment
%
```

In addition, it can be connected via the following options. For more details, refer to the respective link.

- **--conn-string**
- **--dsn**

SYSDBA Connection

The `--as {SYSDBA|ADMIN}` option is used to drive the server or to connect to SYSDBA role which has full access privilege on the database.

The following is an example of connecting with `--as sysdba` in the state of when the GOLDILOCKS server is not driven. `gSQL>` prompt is waiting in the state which is ready to drive GOLDILOCKS with the message *Connected to an idle instance.*

```
% gsql sys gliese --as sysdba
Connected to an idle instance.
gSQL>
```

The following is an example of connecting with `--as sysdba` when the GOLDILOCKS server is already driven.

```
% gsql sys gliese --as sysdba
Connected to GOLDILOCKS Database.
gSQL>
```

For more information, refer to [Startup and Shutdown Server](#).

Quit gsql

gsql is quit by using `\quit` or `\q` command as follows.

For more information, refer to [\quit](#).

```
gSQL> \quit
%
```

Controlling Interactive Mode

Refer to the following options.

Table 34-4 Options

Option	Description
<code>--prompt</code>	It specifies the prompt.
<code>--no-prompt</code>	It removes the prompt.
<code>--import</code>	It executes the SQL file with input.
<code>--silent</code>	When executing the SQL file, the command and the result are not displayed.

Option	Description
<code>--enable-color</code>	The query result is displayed by grouping per row.

Controlling Prompt

When starting an interactive mode, the prompt may be changed by using `--prompt` option as follows. The following is an example that the prompt is changed to `GOLDILOCKS>` prompt, not to `gSQL>` prompt.

```
% gsql test test --prompt GOLDILOCKS
Connected to GOLDILOCKS Database.
GOLDILOCKS>
```

For more information about controlling the prompt, refer to the following options.

- `--prompt`
- `--no-prompt`

Executing from File

When processing batch operation by using `gsql` program, the SQL statement included in the file may be executed by using `--import` option. The following is an example of executing `PerformanceViewSchema.sql` file in the `$GOLDILOCKS_HOME/admin` directory. The example uses `--silent` option not to output the execution results.

```
% cd $GOLDILOCKS_HOME/admin
% gsql --as SYSDBA --import 'PerformanceViewSchema.sql' --silent
%
```

For more information about executing `gsql` from the file, refer to the following options.

- `--import`
- `--silent`
- `--enable-color`

Storing gsql configuration

gsql Configuration File (gsql.ini)

The `gsql` configuration file (`.gsql.ini`) consists of options which is automatically applied when `gsql` starts up, and it should be in the directory `$HOME`.

A user can set multiple dsn in the configuration file, and can specify different options for each dsn. If a user does not enter dsn when gsql starts up, the options in GOLDILOCKS are applied.

Example

```
[GOLDILOCKS]
AUTOCOMMIT = OFF
AUTOTRACE = OFF
LINESIZE = 80
PAGESIZE = 20
VERTICAL = OFF
TIME = OFF
TIMING = OFF
ERROR = ON
COLSIZE = 8192
NUMSIZE = 20
DDLsize = 10000
HISTORY = 128
```

Table 34-5 Options

Option	Minimum value	Maximum value	Default value
AUTOCOMMIT	OFF	ON	OFF
AUTOTRACE	OFF	ON/TRACEONLY	OFF
LINESIZE	1	10000	80
PAGESIZE	1	10000	20
VERTICAL	OFF	ON	OFF
TIME	OFF	ON	OFF
TIMING	OFF	ON	OFF
ERROR	ON	OFF	ON
COLSIZE	1	10485760	8192
NUMSIZE	1	50	20
DDLsize	1	10485760	10000
HISTORY	0	100000	128



If `.gsql.ini` does not exist or the option value is invalid, it is ignored.

glogin.sql

glogin.sql is a global configuration file and it is positioned in `$GOLDILOCKS_DATA/conf/glogin.sql`. If glogin.sql file exists when driving gsql, then it reads the file and executed the statement included in the file. In this way, all gsql sessions are set (e.g.line size).

login.sql

login.sql is a user configuration file. If login.sql file exists in the current directory when driving gsql, then it reads the file and executed the statement included in the file.

The login.sql configuration takes precedence over the glogin.sql configuration.

34.3 Using Interactive Command

gsql Interactive Mode Command

Refer to the following commands.

Table 34-6 Commands

gsql command	Description
<code>\help</code>	gsql command list

gsql program operates in an interactive mode through **Server Connection** as follows.

```
% gsql test test
Connected to GOLDILOCKS Database.
gSQL>
```

A user may enter the SQL statement on the prompt line then execute it or enter the unique command which is executable in an gsql interactive mode then execute it. The gsql command begins with back-slash (\) to distinguish it from the SQL statement. The gsql command which begins with back-slash (\) can not be used in the application, while SQL statement can be directly used in the application.

 The gsql interactive mode command begins with \.

The following is an example of executing SQL statement in an interactive mode.

```
gSQL> SELECT * FROM dual;
DUMMY
-----
X
1 row selected.
```

The following is an example of executing the same SELECT statement by using `\exec sql`, gsql command. `\exec sql` command is a unique gsql command although the syntax of `\exec sql` is as same as the syntax of EXEC SQL referring to the beginning of SQL statement in an **Embedded SQL**.

```
gSQL> \exec sql SELECT * FROM dual;
DUMMY
-----
```

```
X
1 row selected.
```

The current time can be output on the prompt by setting via `\set time`.

```
gSQL> \set time on
12:45:34 gSQL> SELECT * FROM dual;
DUMMY
-----
X
1 row selected.
12:45:37 gSQL>
```

The unique commands of gsql interactive mode can be queried with the command `\help` as follows.

```
gSQL> \help
\help
\q[uit]
\i[mport] {'FILE'}          Import SQL
\ed[it] [{'FILE'}|[HISTORY] num}] Edit SQL statement
\\                          Executes the most recent history entry
\{n}                        Executes n'th history entry
\hi[story]                  Show history entries
\desc  {[schema.]table_name} Show table description
\idesc {[schema.]index_name} Show index description
\spo[ol] ['filename' | OFF] Stores query results in a file
\ho[st] [command]          Executes an operating system command
\set vertical  {ON|OFF}
\set time     {ON|OFF}
\set timing   {ON|OFF}
\set color    {ON|OFF}
\set error    {ON|OFF}
\set autocommit {ON|OFF}
\set autotrace {ON|TRACEONLY|OFF}
\set serveroutput {ON|OFF}
\set heading  {ON|OFF}
\set linesize {n}      0 < n <= 100000
\set pagesize {n}      0 < n <= 100000
\set colsize  {n}      0 < n <= 104857600
\set numsize  {n}      0 < n <= 50
\set ddlsize  {n}      0 < n <= 100000
\set history  {n}      n <= 100000 ( if n < 0, clear history buffer )
```

```

\var          {host_var_name} {INTEGER|BIGINT|VARCHAR(n)}
\exec        [[:host_var_name] := {constant}]
\exec sql    {sql string}
\prepare sql {sql string}
\dynamic sql {host_var_name}
\explain plan [{ON|ONLY}] {sql string}
\print       [{host_var_name}]
\ddl_cluster
\ddl_db
\ddl_tablespace {name}
\ddl_profile   {name}
\ddl_auth      {name}
\ddl_schema    {name}
\ddl_table     {[schema.]name}
\ddl_constraint {[schema.]name}
\ddl_index     {[schema.]name}
\ddl_view      {[schema.]name}
\ddl_sequence  {[schema.]name}
\ddl_synonym    {[schema.]name}
\ddl_publicsynonym {name}
\ddl_procedure  {[schema.]name}
\startup       {[nomount|mount|open]}
\shutdown      {[abort|immediate|transactional|normal]}
\cstartup      {[nomount|mount|open]}
\cshutdown     {[abort|normal]}
\connect       userid password [as {sysdba|admin}]

```

Startup and Shutdown Server

Refer to the following commands.

Table 34-7 Commands

gsql Commad	Description
\startup	It starts up the server.
\shutdown	It shuts down the server.
\cstartup	It starts up the server for the cluster environment.
\cshutdown	It shuts down the server for the cluster environment.

Standalone

It should be connected by using SYSDBA role or ADMIN role as follows to startup or shutdown the server.

- SYSDBA role
 - It has all privileges related to DBA such as the server startup or shutdown.
- ADMIN role
 - It has the same privileges as SYSDBA but it is allowed to connect only one session.
 - It is the role for when a valid session does not exist or for emergency connection under abnormal circumstances.

The following is an example of connecting by using SYSDBA role when the GOLDILOCKS server is not driven.

```
% gsql sys gliese --as sysdba
Connected to an idle instance.
gSQL>
```

gsql is connected to an idle instance in the state of when GOLDILOCKS server does not exist. gsql drives the GOLDILOCKS server on the specific step through **\startup** and connects to the server. The following is an example of driving the GOLDILOCKS server on NOMOUNT phase.

```
gSQL> \startup NOMOUNT
Startup success
gSQL>
```

\startup command is used only when initially driving GOLDILOCKS. Each step of the GOLDILOCKS server is switched by using **ALTER SYSTEM {MOUNT | OPEN} DATABASE** after driving the GOLDILOCKS server and connecting to the server.

```
gSQL> ALTER SYSTEM MOUNT DATABASE;
System altered.
gSQL> ALTER SYSTEM OPEN DATABASE;
System altered.
gSQL>
```

\startup command is executed without any extra option as follows when GOLDILOCKS server is driven on OPEN phase whose service is available without switching the step.

```
% gsql sys gliese --as sysdba
Connected to an idle instance.
gSQL> \startup
Startup success
```

```
gSQL>
```

If the server is already driven on a certain step, `\startup` command outputs an error message as follows. Unless the server is driven up to OPEN phase, it may be driven on OPEN phase by using ALTER SYSTEM as follows.

```
% gsql sys gliese--as sysdba
Connected to GOLDILOCKS Database.
gSQL> \startup
ERR-HY000(11029): shared memory segment exists
gSQL> ALTER SYSTEM MOUNT DATABASE;
System altered.
gSQL> ALTER SYSTEM OPEN DATABASE;
System altered.
gSQL>
```

For more information about the server startup, refer to the followings.

- Step of the server startup: **Multi-level Startup**
- Command for the initial server startup: **\startup**
- Altering the server step: **ALTER SYSTEM {MOUNT | OPEN} DATABASE**

`\shutdown` command is used as follows to shutdown the server. For more information about the server shutdown, refer to **\shutdown**.

```
gSQL> \shutdown
Shutdown success
gSQL>
```

Cluster

LOCATOR_DSN property should be defined in `odbc.ini` file to startup or shutdown the server by using `\cs` `tartup` command and `\cshutdown` command, and it should be connected with SYSDBA role or ADMIN role by using `gsqlnet`.

The following is an example of connecting with SYSDBA role by using `gsqlnet` when GOLDILOCKS server is not driven.

```
% gsqlnet sys gliese --as sysdba
Connected to an idle instance.
gSQL>
```

The following is an example of driving GOLDILOCKS server on LOCAL OPEN phase by using `\cstartup` co

mmmand. Then it switches the server to OPEN phase.

```
gSQL> \cstartup LOCAL OPEN
Startup success
gSQL> ALTER SYSTEM OPEN GLOBAL DATABASE;
System altered.
gSQL>
```

\cstartup command and \cshutdown command are used in C/S environment, so glsnr should be on service on all servers to startup or shutdown the server.

The following is an example of trying to drive GOLDILOCKS server when glsnr is not on service.

```
gSQL> \cstartup
ERR-HY000(58000): MEMBER(G1N1): the sender failed to connect to the member(1)
ERR-HY000(11067): MEMBER(G1N1): fail to connect to an host with a socket : connect() :
stnConnect() returned errno(111)
gSQL>
```

The following is an example of defining LOCATOR_DSN property and LOCATOR DSN property in **odbc.ini** file.

```
% cat .odbc.ini
# Edit the SYSTEM or USER DSN ini file (/etc/odbc.ini or ~/.odbc.ini) and add a data source
using the syntax:
[GOLDILOCKS]
HOST=127.0.0.1
PORT=20101
UID=test
PWD=test
LOCATOR_DSN=LOCATOR
[LOCATOR]
FILE=/home/test/.locator.ini
```

The following is an example of trying to drive the server when LOCATOR_DSN property is not defined in odbc.ini file.

```
gSQL> \cstartup
ERR-HY000(40057): not specified valid location information
gSQL>
```

Commands excluding \CSTARTUP {LOCAL | GLOBAL} OPEN are applied only to the corresponding GOLDILOCKS server. Therefore, other servers should be started up to LOCAL OPEN phase for multi-level startup

by using **ALTER SYSTEM {MOUNT | OPEN} DATABASE** after `\CSTARTUP NOMOUNT`, `MOUN` commands.

The following is an example of trying multi-level startup after `\CSTARTUP MOUNT`. The corresponding server is started on MOUNT phase, but the other server is not started up to LOCAL OPEN phase, so an error occurs.

```
gSQL> \CSTARTUP MOUNT
Startup success
gSQL> ALTER SYSTEM OPEN LOCAL DATABASE;
System altered.
gSQL> ALTER SYSTEM OPEN GLOBAL DATABASE;
ERR-HY000(58000): MEMBER(G1N1): the sender failed to connect to the member(1)
ERR-HY000(11067): MEMBER(G1N1): fail to connect to an host with a socket : connect() :
stnConnect() returned errno(111)
gSQL>
```

For more information about the server startup, refer to the followings.

- Step of the server startup: **Multi-level Startup**
- Command for the initial server startup: `\cstartup`
- Altering the server step: **ALTER SYSTEM {MOUNT | OPEN} DATABASE**

`\cshutdown` command is used as follows to shutdown the entire server. For more information about the entire server shutdown, refer to `\cshutdown`.

```
gSQL> \cshutdown
Shutdown success
gSQL>
```

Executing SQL Statements

Refer to the following commands.

Table 34-8 Commands

gsql command	Description
<code>\import</code>	It executes SQL file.
<code>\set autocommit</code>	It automatically COMMITs whenever executing the SQL statement.
16. SQL References	It is a type of SQL statement.

Entering SQL Statement

In an interactive mode, gsql outputs the interactive mode prompt gSQL> and waits for a user input. After entering the SQL statement, gsql performs the SQL statement by transferring it to the server. In an interactive mode, the SQL statement is completed by entering semi-colon (;), then entering **enter**. After executing the SQL statement, gsql outputs the result and the prompt gSQL>, and then waits for user input.

The following is an example of entering the SQL statement on a single line and executing it.

```
gSQL> SELECT * FROM dual;
DUMMY
-----
X
1 row selected.
gSQL>
```

The following is an example of entering SQL statement across multiple lines and executing it. If **enter** is used in the state of which the SQL statement is not completed, gsql outputs the line number, moves to the next line and waits for user input.

```
gSQL> SELECT id, name
2
```

When a user continuously completes entering all SQL statements, then enters semicolon (;) and **enter** as follows, the SQL statement is executed and gSQL> prompt waits for the next command.

```
gSQL> SELECT id, name
2 FROM t1
3 WHERE id > 0;
ID NAME
-- -----
1 leekmo
2 mkkim
3 xcom73
3 rows selected.
gSQL>
```

The SQL statement is not recognized to be completed of input because the semi-colon (;) within the single quote (') is recognized as a string.

```
gSQL> SELECT id, ';'
2 FROM t1
3 WHERE id = 1;
```

```
ID ';'
-- ---
  1 ;
1 row selected.
gSQL>
```

Entering SQL Statement from File

In an interactive mode, `\import` is used to execute the SQL statement from the file, not to execute it by directly entering the SQL statement. The following is an example of executing multiple SQL statements by reading the file `sample.sql`. For more information, refer to `\import`.

```
gSQL> \import 'sample.sql'
```

- Drop table

```
DROP TABLE IF EXISTS t1;
Table dropped.
```

- Create table

```
CREATE TABLE t1
(
  id    INTEGER PRIMARY KEY,
  name  VARCHAR(128),
  addr  VARCHAR(128)
);
Table created.
```

- Create index

```
CREATE INDEX t1_idx_name ON t1(name);
Index created.
```

- Insert three rows

```
INSERT INTO t1
VALUES ( 1, 'leekmo', 'Seoul, Korea' ),
       ( 2, 'mkkim' , 'Seoul, Korea' ),
       ( 3, 'xcom73', 'Inchon, Korea' );
3 rows created.
```

- Commit transaction

```
COMMIT;
Commit complete.
gSQL>
```

gsql Comment

The comments in an interactive mode are as same as those in the SQL statement. The comments input from the file via the `--import` option is also as same as those in the SQL statement. For more information about comments on SQL statement, refer to **Comments**.

The following is an example of using the line comment in an interactive mode.

```
gSQL> -- outside line-comment
gSQL> SELECT id, name
2 FROM t1 -- inside line-comment
3 WHERE id = 1;
ID NAME
-- -----
1 leekmo
1 row selected.
gSQL>
```

The following is an example of executing the file content with the `\import` command. It is treated in the same way as the comment in an interactive mode. And `gSQL>` prompt waits for the next SQL statement after all contents of the file are executed.

```
gSQL> \import 'sample.sql'
```

- Drop table

```
DROP TABLE IF EXISTS t1;
Table dropped.
```

- Create table

```
CREATE TABLE t1
(
  id    INTEGER PRIMARY KEY,
  name  VARCHAR(128),
  addr  VARCHAR(128)
```

```
);
```

Table created.

- Create index

```
CREATE INDEX t1_idx_name ON t1(name);
```

Index created.

- Insert three rows

```
INSERT INTO t1
VALUES ( 1, 'leekmo', 'Seoul, Korea' ),
       ( 2, 'mkkim' , 'Seoul, Korea' ),
       ( 3, 'xcom73', 'Inchon, Korea' );
```

3 rows created.

- Commit transaction

```
COMMIT;
```

Commit complete.

```
gSQL>
```

The following is an example of using the multi-line comment in an interactive mode.

```
gSQL> SELECT id, name
```

```
2      /*
```

```
3      multi-line
```

```
4      comment
```

```
5      */
```

```
6      FROM t1
```

```
7      WHERE id = 1;
```

```
ID NAME
```

```
-- -----
```

```
1 leekmo
```

1 row selected.

```
gSQL>
```

The comments which is available in gsql interactive mode are as same as those in the SQL statement. For more information about the comments, refer to **Comments** of SQL statement.

SQL Execution Result

When a user performs a query such as SELECT statement in an interactive mode, gsql outputs the query results. The query result consists of the header with the column names, the data of the query result, and summary the query results at the end.

The following is an example of executing the SELECT statement.

```
gSQL> SELECT * FROM t1;
ID NAME  ADDR
-- -----
 1 leekmo Seoul, Korea
 2 mkkim Seoul, Korea
 3 xcom73 Incheon, Korea
3 rows selected.
gSQL>
```

In the example above, the header of output results consists of the column name and the hyphen (-) which distinguishes it from data. The query result is displayed in the middle of the output result, each row of query result is displayed on a single line, and each column value is separated with the space. The summary of the query result is displayed at the end. In this case, it refers that three rows are retrieved.

Data Definition Language, Data Manipulation Language, Control Language statements (except for SQL query) displays the summarized information of the execution result corresponding to the SQL statements characteristics.

The followings are the examples of respectively executing the DDL, DML, Control Language, displaying the results.

- DDL statement

```
gSQL> CREATE TABLE t1 ( id INTEGER, name VARCHAR(128) );
Table created.
```

- DML statement

```
gSQL> INSERT INTO t1 VALUES ( 1, 'leekmo' );
1 row created.
```

- Transaction control statement

```
gSQL> COMMIT;
Commit complete.
gSQL>
```

SQL Execution Error

The error which occurs during executing the SQL statement consists of the following information when it.

- SQLSTATE information: SQLSTATE value of SQL standard
- Error code: Unique error code value of GOLDILOCKS
- Error message: An error message describing the cause of error

The following is an example of an error when executing the SELECT statement. The error message consists of that value of ERR-42000 corresponds to SQLSTATE and the unique error code of GOLDILOCKS is the value of (16040) and a table or view corresponding to invalid_table does not exist at line 2.

```
gSQL> SELECT id, name
2     FROM invalid_table
3     WHERE id > 0;
ERR-42000(16040): table or view does not exist :
        FROM invalid_table
            *
ERROR at line 2:
gSQL>
```

Interactive Command Execution Result

The interactive commands used together with SQL statements displays the same results and errors as those executing SQL statements.

The following is an example of preparing the SQL statement by using `\prepare sql` and executing it by using `\exec`.

```
gSQL> \prepare sql SELECT * FROM t1;
SQL prepared.
gSQL> \exec
ID NAME  ADDR
-- -----
1 leekmo Seoul, Korea
2 mkkim  Seoul, Korea
3 xcom73 Incheon, Korea
3 rows selected.
gSQL>
```

The following is an example of an error occurred in the SQL statement when using `\prepare sql`. It displays an error which is as same as that occurs when executing the SQL statement.

- An error of \prepare sql command

```
gSQL> \prepare sql SELECT * FROM invalid_table;
ERR-42000(16040): table or view does not exist :
SELECT * FROM invalid_table
          *
ERROR at line 1:
```

- An error of the same SQL statement

```
gSQL> SELECT * FROM invalid_table;
ERR-42000(16040): table or view does not exist :
SELECT * FROM invalid_table
          *
ERROR at line 1:
gSQL>
```

If the gsql commands in an interactive mode do not include the SQL statement or when the command does not have any result to display, only *gSQL>* prompt is displayed without any extra message when the command is successfully performed.

The following is an example of successfully performing the interactive command without a message. The error message is displayed when an error occurs.

- When the interactive gsql command is normally performed

```
gSQL> \var v1 INTEGER
gSQL> \exec :v1 := 1
```

- When the interactive gsql command causes an error

```
gSQL> \var v2 INVALID TYPE
ERR-42000(40000): syntax error
\var v2 INVALID TYPE
.....^      ^
Error at line 1
gSQL>
```

For more information about the performance result of the interactive command, refer to the description and example of the interactive command in **Interactive Command References**.

Autocommitting SQL statement

The SQL statements in the gsql interactive mode may commit or rollback the transaction by using the **COMMIT** or **ROLLBACK** statement.

The following is an example of performing COMMIT or ROLLBACK after performing multiple INSERT statements. Whereas the first INSERT statement is successfully committed by COMMIT, the second and third INSERT statements are rolled back by ROLLBACK in the following example.

```
gSQL> INSERT INTO t1 VALUES ( 1, 'leekmo' );
1 row created.
gSQL> COMMIT;
Commit complete.
gSQL> INSERT INTO t1 VALUES ( 2, 'mkkim' );
1 row created.
gSQL> INSERT INTO t1 VALUES ( 3, 'xcom73' );
1 row created.
gSQL> ROLLBACK;
Rollback complete.
gSQL> SELECT * FROM t1;
ID NAME
-- -----
1 leekmo
1 row selected.
gSQL>
```

If a user wants to automatically COMMIT every transaction whenever performing the SQL statements, it can be controlled by using the **\set autocommit** as follows. When performing the same SQL statement as the example above, each SQL statement is automatically committed, so the transaction of the second and the third INSERT statements are completed regardless of ROLLBACK.

```
gSQL> \set autocommit on
gSQL> INSERT INTO t1 VALUES ( 1, 'leekmo' );
1 row created.
gSQL> COMMIT;
Commit complete.
gSQL> INSERT INTO t1 VALUES ( 2, 'mkkim' );
1 row created.
gSQL> INSERT INTO t1 VALUES ( 3, 'xcom73' );
1 row created.
gSQL> ROLLBACK;
Rollback complete.
```

```

gSQL> SELECT * FROM t1;
ID NAME
-- -----
1 leekmo
2 mkkim
3 xcom73
3 rows selected.
gSQL>

```

For more information about controlling automatic COMMIT, refer to `\set autocommit`.

Forced Termination of SQL Statement Being Executed

SQL statements being executed in an interactive mode is forcibly terminated by entering `Ctrl+C`.

The following is an example of which the SELECT statement being executed for a long time is forcibly terminated. If `Ctrl+C` is entered by using a keyboard during performing the SQL statement, the error message, operation canceled, is displayed and the SQL statement is forcibly terminated.

```

gSQL> SELECT COUNT(*)
FROM
    t1 AS v01,
    t1 AS v02,
    t1 AS v03,
    t1 AS v04,
    t1 AS v05,
    t1 AS v06,
    t1 AS v07,
    t1 AS v08,
    t1 AS v09,
    t1 AS v10,
    t1 AS v11,
    t1 AS v12,
    t1 AS v13,
    t1 AS v14,
    t1 AS v15,
    t1 AS v16,
    t1 AS v17,
    t1 AS v18,
    t1 AS v19,
    t1 AS v20;
2 3 4 5 6 7 8 9 10 11 12 13 14 15 16 17 18 19 20 21 22

```

^C

ERR-HY008(13043): operation canceled

gSQL>

Controlling Output Result

Refer to the following commands.

Table 34-9 Commands

gsql command	Description
<code>\set color</code>	It identifies each row with different color.
<code>\set colsize</code>	It controls the maximum size of the column results.
<code>\set error</code>	It controls whether an error message is displayed.
<code>\set linesize</code>	It controls the maximum output length of the row.
<code>\set numsize</code>	It controls the maximum number of digit of the numeric value.
<code>\set pagesize</code>	It controls the number of row to be included in a page.
<code>\set timing</code>	It outputs the execution time of the SQL statement.
<code>\set vertical</code>	It displays each column in a single line.

Controlling Page Configuration

As described in **SQL Execution Result**, the query results display the column names in the header, displays the data, then the summary information at the end.

If there are many query results, they are divided into the unit of pagesize (default value is 20), and each page outputs the column names and data set. When the output of all pages is completed, the summary information is displayed at the end.

The following is an example of the output of query results by changing the pagesize to 5. For more information about controlling the pagesize, refer to `\set pagesize`.

```
gSQL> \set pagesize 5
gSQL> SELECT table_schema, table_name FROM dictionary WHERE table_name like 'ALL_%' FETCH 20;
TABLE_SCHEMA      TABLE_NAME
-----
DICTIONARY_SCHEMA ALL_ALL_TABLES
DICTIONARY_SCHEMA ALL_COL_COMMENTS
DICTIONARY_SCHEMA ALL_COL_PRIVS
DICTIONARY_SCHEMA ALL_COL_PRIVS_MADE
DICTIONARY_SCHEMA ALL_COL_PRIVS_REC'D
```

```

TABLE_SCHEMA      TABLE_NAME
-----
DICTIONARY_SCHEMA ALL_CONSTRAINTS
DICTIONARY_SCHEMA ALL_CONS_COLUMNS
DICTIONARY_SCHEMA ALL_DB_PRIVS
DICTIONARY_SCHEMA ALL_DB_PRIVS_MADE
DICTIONARY_SCHEMA ALL_DB_PRIVS_RECD
TABLE_SCHEMA      TABLE_NAME
-----
DICTIONARY_SCHEMA ALL_INDEXES
DICTIONARY_SCHEMA ALL_IND_COLUMNS
DICTIONARY_SCHEMA ALL_SCHEMAS
DICTIONARY_SCHEMA ALL_SCHEMA_PATH
DICTIONARY_SCHEMA ALL_SCHEMA_PRIVS
TABLE_SCHEMA      TABLE_NAME
-----
DICTIONARY_SCHEMA ALL_SCHEMA_PRIVS_MADE
DICTIONARY_SCHEMA ALL_SCHEMA_PRIVS_RECD
DICTIONARY_SCHEMA ALL_SEQUENCES
DICTIONARY_SCHEMA ALL_SEQ_PRIVS
DICTIONARY_SCHEMA ALL_SEQ_PRIVS_MADE
20 rows selected.
gSQL>

```

Each row of the query result is output in linesize unit (default value is 80). If the row length of the result is bigger than linesize, it is output on the next line.

The following is an example of the query result before and after the linesize is adjusted to 200. For more information about controlling linesize, refer to `\set linesize`.

```

gSQL> SELECT * FROM dict_columns WHERE table_name = 'USER_TABLES' FETCH 3;
TABLE_SCHEMA      TABLE_NAME      COLUMN_NAME
-----
COMMENTS
-----
DICTIONARY_SCHEMA USER_TABLES      TABLE_SCHEMA
Schema of the table
DICTIONARY_SCHEMA USER_TABLES      TABLE_NAME
Name of the table
DICTIONARY_SCHEMA USER_TABLES      TABLESPACE_NAME
Name of the tablespace containing the table
3 rows selected.

```

- Set the linesize to 200.

```
gSQL> \set linesize 200
gSQL> SELECT * FROM dict_columns WHERE table_name = 'USER_TABLES' FETCH 3;
TABLE_SCHEMA      TABLE_NAME  COLUMN_NAME    COMMENTS
-----
DICTIONARY_SCHEMA USER_TABLES  TABLE_SCHEMA  Schema of the table
DICTIONARY_SCHEMA USER_TABLES  TABLE_NAME    Name of the table
DICTIONARY_SCHEMA USER_TABLES  TABLESPACE_NAME Name of the tablespace containing the table
3 rows selected.
gSQL>
```

To increase the readability of each row on the terminal by differentiating rows, each row can be output by varying the color through `\set color` as described below. For more information, refer to `\set color`.

```
gSQL> \set color on
gSQL> SELECT table_schema, table_name FROM dictionary WHERE table_name like 'ALL_%' FETCH 10;
TABLE_SCHEMA      TABLE_NAME
-----
DICTIONARY_SCHEMA ALL_ALL_TABLES
DICTIONARY_SCHEMA ALL_COL_COMMENTS
DICTIONARY_SCHEMA ALL_COL_PRIVS
DICTIONARY_SCHEMA ALL_COL_PRIVS_MADE
DICTIONARY_SCHEMA ALL_COL_PRIVS_REC'D
DICTIONARY_SCHEMA ALL_CONSTRAINTS
DICTIONARY_SCHEMA ALL_CONS_COLUMNS
DICTIONARY_SCHEMA ALL_DB_PRIVS
DICTIONARY_SCHEMA ALL_DB_PRIVS_MADE
DICTIONARY_SCHEMA ALL_DB_PRIVS_REC'D
10 rows selected.
gSQL>
```

To output the query result rows in the column unit on a single line, not in the line unit, `\set vertical on` is used. The following is an example of displaying the query results in a column unit. For more information, refer to `\set vertical`.

```
gSQL> SELECT * FROM v$system_stat FETCH 5;
STAT_NAME          STAT_VALUE  COMMENTS
-----
SYSTEM_SAR          3 system available resource( 0:none, 1:session 2:database )
MAX_ENVIRONMENT_COUNT 128 maximum environment count
FREE_ENVIRONMENT_ID  3 available environment identifier
```



```

MAX_SESSION_COUNT          128 maximum session count
FREE_SESSION_ID            4 available session identifier
5 rows selected.
gSQL> \set vertical on
gSQL> SELECT * FROM v$system_stat FETCH 5;
      STAT_NAME # SYSTEM_SAR
      STAT_VALUE # 3
      COMMENTS # system available resource( 0:none, 1:session 2:database )
      STAT_NAME # MAX_ENVIRONMENT_COUNT
      STAT_VALUE # 128
      COMMENTS # maximum environment count
      STAT_NAME # FREE_ENVIRONMENT_ID
      STAT_VALUE # 3
      COMMENTS # available environment identifier
      STAT_NAME # MAX_SESSION_COUNT
      STAT_VALUE # 128
      COMMENTS # maximum session count
      STAT_NAME # FREE_SESSION_ID
      STAT_VALUE # 4
      COMMENTS # available session identifier
5 rows selected.
gSQL>

```

Controlling Data Output

gsq converts all data included in the query result to a string, then outputs it.

For a numeric data type, numsize (default value is 20) is output in the digit unit, and a numeric value bigger than numsize is output in an exponent form. The following is an example of controlling the output by using the numsize. For more information, refer to `\set numsize`.

```

gSQL> SELECT num, ( num * num ) AS result FROM t1;
      NUM          RESULT
-----
1234567890123 1.52415787532276E+24
1 row selected.
gSQL> \set numsize 50
gSQL> SELECT num, ( num * num ) AS result FROM t1;
      NUM          RESULT
-----
1234567890123 1524157875322755800955129
1 row selected.

```



```

26-AUG-2014
1 row selected.
gSQL>

```

The output of the date/ time value can be controlled by using **TO_CHAR(datetime)** function without altering property as follows.

```

gSQL> SELECT TO_CHAR( enter_date, 'DD-MON-YYYY' ) as result FROM t1;
RESULT
-----
26-AUG-2016
1 row selected.
gSQL>

```

A binary string such as BINARY or VARBINARY is output as hex values as follows.

```

gSQL> select * from t1;
BINARY_VALUE
-----
A010002F370000000000
1 row selected.
gSQL>

```

The data of the LONG VARCHAR, LONG VARBINARY type may include a very long string, so it outputs the data as much as colsize (default value is 8192). The following is an example of outputting the part of the TEXT column data of LONG VARCHAR data type by reducing the colsize. The whole data may be output by increasing the colsize. For more information, refer to **\set colsize**.

```

gSQL> \set colsize 100
gSQL> SELECT view_name, text FROM all_views WHERE view_name = 'ALL_ALL_TABLES';
VIEW_NAME      TEXT
-----
ALL_ALL_TABLES SELECT
                auth.AUTHORIZATION_NAME      ① OWNER
                , sch.SCHEMA_NAME
1 row selected.
gSQL>

```

Execution Time of SQL Statement

The execution time of the SQL statement is output by using `\set timing` on as follows. For more information, refer to `\set timing`.

```
gSQL> \set timing on
gSQL> SELECT * FROM dual;
DUMMY
-----
X
1 row selected.
Elapsed time: 0.08500 ms
```

Logging Output Result

All results performed in gsql are simultaneously logged to the file when they are output on the terminal.

Table 34-10 Commands

gsql command	Description
<code>\spool</code>	It logs the output result to a file.

For more information about the features related to logging output results, refer to the commands of `\spool`.

The output result is logged as the following example.

- Start to log the execution result on result.txt

```
gSQL> \SP00L 'result.txt'
```

- Check the spool status

```
gSQL> \SP00L
currently spooling to result.txt
gSQL> SELECT * FROM T1 WHERE C1 < 10;
```

- Stop the spool feature

```
gSQL> \SP00L OFF
```

Querying SQL Object Information

The information about SQL objects may be queried with the views of **DICTIONARY_SCHEMA**, **INFORMATION_SCHEMA**.

Table 34-11 Commands

gsq command	Description
<code>\desc</code>	It queries the table information.
<code>\idesc</code>	It queries the index information.

For example, there are the table and index created as follows.

```
CREATE TABLE t1
(
  id   INTEGER PRIMARY KEY,
  name VARCHAR(128),
  addr VARCHAR(128)
);
CREATE INDEX t1_idx_name ON t1(name);
```

A user may query the information related to the table by performing a series of SQL statements as follows.

```
gsQL> SELECT table_schema, table_name FROM user_tables WHERE table_name = 'T1';
TABLE_SCHEMA TABLE_NAME
-----
PUBLIC      T1
1 row selected.
gsQL> SELECT column_name, data_type, nullable FROM user_tab_columns WHERE table_schema =
'PUBLIC' AND table_name = 'T1';
COLUMN_NAME DATA_TYPE      NULLABLE
-----
ID           NUMBER          N
NAME        CHARACTER VARYING Y
ADDR        CHARACTER VARYING Y
3 rows selected.
gsQL> SELECT index_name FROM user_indexes WHERE table_schema = 'PUBLIC' AND table_name = 'T1';
INDEX_NAME
-----
T1_PRIMARY_KEY_INDEX
T1_IDX_NAME
```

2 rows selected.

gSQL>

gsql may easily query the information related to the table by using `\desc` as follows. For more information about the output, refer to `\desc`.

```
gSQL> \desc t1
COLUMN_NAME TYPE IS_NULLABLE
-----
ID NUMBER(10,0) FALSE
NAME VARCHAR(128) TRUE
ADDR VARCHAR(128) TRUE
INDEX_NAME TABLESPACE_NAME INDEX_TYPE IS_UNIQUE COLUMNS
-----
T1_PRIMARY_KEY_INDEX MEM_TEMP_TBS BTREE TRUE ID
T1_IDX_NAME MEM_TEMP_TBS BTREE FALSE NAME
CONSTRAINT_NAME CONSTRAINT_TYPE ASSOCIATED_INDEX COLUMNS
-----
T1_PRIMARY_KEY PRIMARY KEY T1_PRIMARY_KEY_INDEX ID
gSQL>
```

`\idesc` describes the information related to the index as the following example. For more information, refer to `\idesc`.

```
gSQL> \idesc t1_idx_name
COLUMN_NAME ORDINAL_POSITION IS_ASCENDING_ORDER IS_NULLS_FIRST
-----
NAME 1 TRUE FALSE
gSQL>
```

Output DDL Statement of SQL Object

The following gsql commands output the DDL statement corresponding to the current state of the SQL object. As well as the CREATE statement which creates the SQL object, DDL statement of the related object may be output through the various options.

Table 34-12 Commands

gsql command	Description
<code>\ddl_cluster</code>	It outputs the cluster-related DDL.
<code>\ddl_db</code>	It outputs the database-related DDL.

gsql command	Description
<code>\ddl_tablespace</code>	It outputs the tablespace-related DDL.
<code>\ddl_profile</code>	It outputs the profile-related DDL.
<code>\ddl_audit_policy</code>	It outputs the audit policy-related DDL.
<code>\ddl_auth</code>	It outputs the account-related DDL.
<code>\ddl_schema</code>	It outputs the schema-related DDL.
<code>\ddl_publicsynonym</code>	It outputs the public synonym-related DDL.
<code>\ddl_table</code>	It outputs the table-related DDL.
<code>\ddl_constraint</code>	It outputs the constraint-related DDL.
<code>\ddl_index</code>	It outputs the index-related DDL.
<code>\ddl_view</code>	It outputs the view-related DDL.
<code>\ddl_sequence</code>	It outputs the sequence-related DDL.
<code>\ddl_synonym</code>	It outputs the synonym-related DDL.
<code>\ddl_procedure</code>	It outputs the procedure-related DDL.
<code>\set ddlsize</code>	It controls the size of the DDL output buffer.

For example, the orders table is created as follows.

```
gSQL>
CREATE TABLE ORDERS
(
    O_ID          INTEGER,
    O_D_ID        INTEGER,
    O_W_ID        INTEGER,
    O_C_ID        INTEGER,
    O_ENTRY_D     TIMESTAMP,
    O_CARRIER_ID INTEGER,
    O_OL_CNT      NUMERIC(8),
    O_ALL_LOCAL   NUMERIC(1),
    PRIMARY KEY(O_W_ID, O_D_ID, O_ID) INDEX ORDERS_PK_IDX
);
```

Table created.

The CREATE TABLE statement which created the orders table in the example above is output by using `\ddl_table` as follows.

```
gSQL> \ddl_table orders CREATE
SET SESSION AUTHORIZATION "TEST";
CREATE TABLE "PUBLIC"."ORDERS"
(
```

```

        "O_ID" NUMBER( 10, 0 )
    , "O_D_ID" NUMBER( 10, 0 )
    , "O_W_ID" NUMBER( 10, 0 )
    , "O_C_ID" NUMBER( 10, 0 )
    , "O_ENTRY_D" TIMESTAMP( 6 ) WITHOUT TIME ZONE
    , "O_CARRIER_ID" NUMBER( 10, 0 )
    , "O_OL_CNT" NUMBER( 8, 0 )
    , "O_ALL_LOCAL" NUMBER( 1, 0 )
    )
PCTFREE 10
PCTUSED 60
INITRANS 4
MAXTRANS 8
STORAGE
(
    INITIAL 524288
    NEXT 262144
    MINSIZE 524288
    MAXSIZE 562949953159168
)
TABLESPACE "MEM_DATA_TBS"
;

```

From the example above, SET AUTHORIZATION statement refers to the owner who performed CREATE TABLE statement. The CREATE TABLE statement is output together with the information that the user does not input such as the schema name to which the table belongs, the tablespace name in which the table is stored and the physical information of the table.

DDL corresponding to the constraints generated in the table is output by using the CONSTRAINT option of \ddl_table as follows.

```

gSQL> \ddl_table orders CONSTRAINT
SET SESSION AUTHORIZATION "TEST";
ALTER TABLE "PUBLIC"."ORDERS"
ADD CONSTRAINT "PUBLIC"."ORDERS_PRIMARY_KEY"
PRIMARY KEY
(
    "O_W_ID" ASC NULLS LAST
    , "O_D_ID" ASC NULLS LAST
    , "O_ID" ASC NULLS LAST
)
INDEX "ORDERS_PK_IDX"

```



```

PCTFREE 10
INITRANS 4
MAXTRANS 8
STORAGE
(
  INITIAL 524288
  NEXT 262144
  MINSIZE 524288
  MAXSIZE 562949953159168
)
NOLOGGING
TABLESPACE "MEM_TEMP_TBS"
NOT DEFERRABLE
INITIALLY IMMEDIATE
;

```

For more information, refer to the `gsql` command corresponding to the SQL object.



If a user uses the command such as `\ddl_table` and simultaneously performs DDL on the relevant SQL object, it may output different results, so DDL should not be simultaneously performed.

Controlling History

`gsql` controls the history of executed SQL statements in an interactive mode.

Table 34-13 Commands

gsql command	Description
<code>\</code>	It executes the previous SQL.
<code>\{n}</code>	It executes the SQL statement corresponding to the history number.
<code>\history</code>	It queries the SQL execution history.
<code>\set history</code>	It controls the number of history buffer.

The following is an example of executing SQL statement which has already been performed again.

- The most recent successfully executed SQL statement is executed again.

```

gSQL> \\  

DUMMY  

-----  

X  

1 row selected.  

gSQL> \history  

ID SQL  

-----  

1 DROP TABLE IF EXISTS t1  

2 CREATE TABLE t1  

  (  

    id  INTEGER PRIMARY KEY,  

    name VARCHAR(128),  

    addr VARCHAR(128)  

  )  

3 CREATE INDEX t1_idx_name ON t1(name)  

4 INSERT INTO t1  

    VALUES ( 1, 'leekmo', 'Seoul, Korea' ),  

           ( 2, 'mkkim' , 'Seoul, Korea' ),  

           ( 3, 'xcom73', 'Inchon, Korea' )  

5 COMMIT  

6 select * from t1

```

- The first SQL in the history is executed.

```

gSQL> \1  

Table dropped.

```

For more information about the history related features of gsql, refer to **Commands** .

Editing SQL

It edits the SQL statement by using the text editor. The text editor to be used may be specified in the environment variable EDITOR. If the environment variable EDITOR does not exist, vi is used by default.

Table 34-14 Command

gsql command	Description
\edit	It edits the SQL statement by using the text editor.

When using the editing features, gsql runs the editor and hands over control to it. The user can freely edit

the SQL statements with the editor. When the editor ends, the control is handed over to gsql, and its content will be added as the last history.

The SQL statement edited by the editor may be executed through the last history execution command `\\`.



Only a single SQL statement can be edited with the SQL editor. An error occurs when executing multiple SQL statements.

The followings may be edited by using `\edit`.

- The most recently performed SQL statement
- The SQL statement stored in a file
- The SQL statement stored in the gsql history

For more information about the edit-related features in gsql, refer to `\edit`.

The SQL statement may be edited as the following example.

- The most recently performed SQL statement is edited.

```
gSQL> SELECT * FROM T1;
C1
--
 1
11
2 rows selected.
gSQL> \EDIT
SELECT * FROM T1 WHERE C1 < 10;
```

- The edited SQL statement is executed.

```
gSQL> \\
C1
--
 1
1 row selected.
```

Controlling Connection

Refer to the following commands.

Table 34-15 Commands

gsql command	Description
<code>\connect</code>	It connects with a new user.
<code>\quit</code>	It quits the connection.

It is connected with a new user by using `\connect` in an interactive mode as follows. The existing session is terminated and a new session is created by using `\connect`. For more information, refer to `\connect`.

```
gSQL> \connect test test
gSQL>
```

The user may be changed by using the `SET SESSION AUTHORIZATION user_identifier` statement as follows. `\connect` commits all transactions being executed and creates a new session whereas the `SET SESSION AUTHORIZATION` statement changes the user while keeping intact the existing sessions.

```
gSQL> SET SESSION AUTHORIZATION test;
Session set.
gSQL>
```

Interactive mode is terminated by using `\quit` as follows. For more information, refer to `\quit`.

```
gSQL> \quit
%
```

Using Host Variable

`gsql` declares a host variable in an interactive mode, and assigns a value to the host variable, then uses the host variable together with the SQL statement.

Table 34-16 Commands

gsql command	Description
<code>\var</code>	It declares the host variable.
<code>\exec :var := value</code>	It assigns the value to the host variable.
<code>\print</code>	It outputs the value of the host variable.
<code>\dynamic sql :var</code>	It executes SQL statements stored in the host variable.

The following is an example of declaring the host variable by using `\var`, and assigning the value to the host variable by using `\exec :var := value`, and querying the value of the host variable by using `\print`. For more information, refer to each command.

```

gSQL> \var v_id INTEGER
gSQL> \exec :v_id := 1
gSQL> \print v_id
V_ID
----
   1
gSQL>

```

The variable declared in an interactive mode may be used as the input parameter in the SQL statement as follows.

```

gSQL> SELECT * FROM t1 WHERE id = :v_id;
ID NAME   ADDR
-----
   1 leekmo Seoul, Korea
1 row selected.
gSQL>

```

The variable declared in an interactive mode may be used as the output parameter in the SQL statement as follows.

```

gSQL> SELECT id INTO :v_id FROM t1 WHERE name = 'mkkim';
V_ID
----
   2
1 row selected.
gSQL>

```

Controlling Method of Treating SQL Statement

The SQL process methods which are frequently used when processing the SQL such as the execution of prepare/ execute statement or the retrieval by using the cursor may be simulated by using the gsql interactive mode command before developing the application.

Table 34-17 Commands

gsql command	Description
<code>\exec sql</code>	It directly executes the SQL statement.
<code>\prepare sql</code>	It prepares the SQL statement.
<code>\exec</code>	It executes the prepared SQL statement.
	It executes the SQL statement stored in the host variable.....

gsql command	Description
<code>\dynamic sql :var</code>	

The following Java application is a part of code in `$GOLDILOCKS_HOME/sample/JDBC/JdbcSample.java`.

```
public static void main(String[] args) throws SQLException
{
    Connection con = createConnectionByDriverManager("TEST", "test");
    Statement stmt = con.createStatement();
    stmt.execute("CREATE TABLE SAMPLE_TABLE ( ID INTEGER, NAME CHAR(20) )");
    PreparedStatement pstmt = con.prepareStatement("INSERT INTO SAMPLE_TABLE VALUES (?,
?)" );
    pstmt.setInt(1, 100);
    pstmt.setString(2, "Tom");
    pstmt.executeUpdate();
    pstmt.setInt(1, 200);
    pstmt.setString(2, "Jerry");
    pstmt.executeUpdate();
    ResultSet rs = stmt.executeQuery("SELECT * FROM SAMPLE_TABLE");
    while (rs.next())
    {
        System.out.println("ID = " + rs.getInt(1) + ": " + rs.getString(2));
    }
    rs.close();
    stmt.close();
    pstmt.close();
    con.close();
    Connection con2 = createConnectionByDataSource("TEST", "test");
    Statement stmt2 = con2.createStatement();
    stmt2.execute("DROP TABLE SAMPLE_TABLE");
    stmt2.close();
    con2.close();
}
```

The implementation above which used the `PreparedStatement` class of Java code may be simulated by using `\prepare sql` and `\exec` as follows.

```
gSQL> \connect test test
gSQL> \var v_int INTEGER
gSQL> \var v_string VARCHAR(128)
gSQL> CREATE TABLE SAMPLE_TABLE ( ID INTEGER, NAME CHAR(20) );
```

```

Table created.
gSQL> \prepare sql INSERT INTO SAMPLE_TABLE VALUES (:v_int, :v_string);
SQL prepared.
gSQL> \exec :v_int := 100
gSQL> \exec :v_string := 'Tom'
gSQL> \exec
1 row created.
gSQL> \exec :v_int := 200
gSQL> \exec :v_string := 'Jerry'
gSQL> \exec
1 row created.
gSQL> SELECT * FROM SAMPLE_TABLE;
  ID NAME
--- -----
100 Tom
200 Jerry
2 rows selected.
gSQL> \connect test test
gSQL> DROP TABLE SAMPLE_TABLE;
Table dropped.
gSQL> \quit
%
```

The following embedded SQL program is a part of code in `$GOLDILOCKS_HOME/sample/EmbeddedSQL/sample2.gc`.

```

int main(int argc, char **argv)
{
    EXEC SQL BEGIN DECLARE SECTION;
    int          sEmpNo;
    varchar      sENAME[20 + 1];
    char         sJob[20];
    long         sSalary;
    EXEC SQL END DECLARE SECTION;
    ... Ellipsis ...
}
```

- Retrieve employee

```

EXEC SQL
    DECLARE EMP_CUR CURSOR FOR
    SELECT empno, ename, job, sal
    FROM EMP;
```

```

EXEC SQL OPEN EMP_CUR;
if(sqlca.sqlcode != 0)
{
    PRINT_SQL_ERROR("[ERROR] SQL ERROR -");
    goto fail_exit;
}
printf(" EMPNO      ENAME                JOB      SALARY\n");
printf("===== \n");
while( 1 )
{
    EXEC SQL
        FETCH EMP_CUR
        INTO  :sEmpNo, :sENAME, :sJob, :sSalary;
    if(sqlca.sqlcode == SQL_NO_DATA)
    {
        break;
    }
    else if(sqlca.sqlcode != 0)
    {
        PRINT_SQL_ERROR("[ERROR] SQL ERROR -");
        goto fail_exit;
    }
    sRecordCount ++;
    printf("%6d %20s %10s %8ld\n",
        sEmpNo, sENAME.arr, sJob, sSalary);
}
printf("===== \n");
printf("Record Count = %d\n", sRecordCount);
printf("===== \n");
EXEC SQL CLOSE EMP_CUR;
if(sqlca.sqlcode != 0)
{
    PRINT_SQL_ERROR("[ERROR] SQL ERROR -");
    goto fail_exit;
}

... Ellipsis ...
}

```

The query processing which uses the cursor in an embedded SQL program above may be simulated in gsql interactive mode as follows.

```

gSQL> \var sEmpNo INTEGER
gSQL> \var sENAME VARCHAR(20)
gSQL> \var sJob CHAR(20)
gSQL> \var sSalary BIGINT
gSQL> DECLARE EMP_CUR CURSOR FOR
        SELECT empno, ename, job, sal
        FROM EMP;
Cursor declared.
gSQL> OPEN EMP_CUR;
Cursor is open.
gSQL> FETCH EMP_CUR
        INTO :sEmpNo, :sENAME, :sJob, :sSalary;
SEMPNO SENAME SJOB          SSALARY
-----
2854 Park  RND              800
1 row fetched.
gSQL> FETCH EMP_CUR
        INTO :sEmpNo, :sENAME, :sJob, :sSalary;
SEMPNO SENAME SJOB          SSALARY
-----
2098 Kim   SALESMAN          1600
1 row fetched.
gSQL> FETCH EMP_CUR
        INTO :sEmpNo, :sENAME, :sJob, :sSalary;
SEMPNO SENAME SJOB          SSALARY
-----
2175 Choi  SALESMAN          1250
1 row fetched.
gSQL> CLOSE EMP_CUR;
Cursor closed.
gSQL>

```



The following statements are limitedly used in an embedded SQL in other DBMS. On the other hand, in GOLDILOCKS, the followings are used not only in an embedded SQL but also can be used as an argument of SQL processing functions when developing the application of ODBC or JDBC.

- **SELECT .. INTO**
- **DECLARE cursor_name**
- **OPEN cursor_name**

- FETCH cursor_name
- CLOSE cursor_name

Information of SQL Execution Plan

Refer to the following commands.

Table 34-18 Command

gsql Command	Description
\explain plan	It outputs the execution plan for the SQL statement.
\set autotrace	It sets whether to output the execution plan.

The execution plan of the SQL statement is viewed in an interactive mode by using `\explain plan` or `\set autotrace` as follows. For more information about the command, refer to `\explain plan` or `\set autotrace`, and for more information about the analysis of execution plan, refer to [SQL Execution Plan](#).

The following is an example of executing the query No.4 of TPC-H benchmark by using the `\explain plan`.

```
\explain plan
select
  o_orderpriority,
  count(*) as order_count
from
  orders
where
  o_orderdate >= date '1993-07-01'
and o_orderdate < date '1993-07-01' + interval '3' month
and exists (
  select
    *
  from
    lineitem
  where
    l_orderkey = o_orderkey
    and l_commitdate < l_receiptdate
)
group by
  o_orderpriority
order by
```

```

o_orderpriority;
O_ORDERPRIORITY ORDER_COUNT
-----
1-URGENT          10594
2-HIGH            10476
3-MEDIUM         10410
4-NOT SPECIFIED  10556
5-LOW             10487

```

5 rows selected.

```
>>> start print plan
```

```
< Execution Plan >
```

```

=====
|  IDX  |  NODE DESCRIPTION                                |      ROWS  |
-----
|   0   |  SELECT STATEMENT                                |            |
|   1   |    SORT INSTANT ACCESS                           |           5 |
|   2   |      GROUP HASH INSTANT ACCESS                   |           5 |
|   3   |        NESTED LOOP JOIN (LEFT SEMI)              |        52523 |
|   4   |          TABLE ACCESS ("ORDERS")                 |        57218 |
|   5   |            INDEX ACCESS ("LINEITEM, LINEITEM_PK_INDEX") |        52523 |
=====

```

```

1 - SORT KEY : "ORDERS.O_ORDERPRIORITY ASC NULLS LAST"
   RECORD COLUMNS : COUNT(*)
   READ COLUMNS  : O_ORDERPRIORITY, COUNT(*)
2 - AGGREGATIONS : COUNT(*)
   GROUPING COLUMNS : O_ORDERPRIORITY
   RECORD COLUMNS : COUNT(*)
   READ COLUMNS  : O_ORDERPRIORITY, COUNT(*)
3 - JOINED COLUMNS : ORDERS.O_ORDERPRIORITY
4 - READ COLUMNS : O_ORDERKEY, O_ORDERDATE, O_ORDERPRIORITY
   PHYSICAL FILTER : O_ORDERDATE >= CAST( '1993-07-01' AS DATE ) AND O_ORDERDATE < (
CAST( '1993-07-01' AS DATE ) + CAST( '3' AS INTERVAL(MONTH) ) )
5 - READ INDEX COLUMNS : L_ORDERKEY
   READ TABLE COLUMNS : L_COMMITDATE, L_RECEIPTDATE
   MIN RANGE : L_ORDERKEY = {O_ORDERKEY}
   MAX RANGE : L_ORDERKEY = {O_ORDERKEY}
   PHYSICAL TABLE FILTER : L_COMMITDATE < L_RECEIPTDATE

```

```
<<< end print plan
```

34.4 Command Option Reference

This chapter describes the options for performing gsql command at the shell prompt.

Username Password

Description

It connects to GOLDILOCKS by using the username and password.

Examples

The following is an example of connecting to GOLDILOCKS with the test user.

```
% gsql test test
Connected to GOLDILOCKS Database.
gSQL>
```

The following is an example of failing to connect to GOLDILOCKS with the invalid username or password.

```
% gsql invalid_user invalid_password
ERR-28000(16004): invalid username/password; logon denied
%
```

--as {SYSDBA|ADMIN}

Description

It connects to GOLDILOCKS with SYSDBA role or ADMIN role.

For more information about the description of the role, refer to **Startup and Shutdown Server**.

```
% gsql sys gliese --as sysdba
```

Example

The following is an example of connecting to GOLDILOCKS with SYSDBA role.

```
% gsql sys gliese --as sysdba
Connected to GOLDILOCKS Database.
gSQL>
```

--conn-string

Description

It connects to GOLDILOCKS by using the connection string.

The details of the connection string to be described should used in a form as same as the input string of the ODBC function, **SQLDriverConnect**. For more information about the connection string, refer to **SQLDriverConnect**function.

Example

The following is an example of connecting to GOLDILOCKS with --conn-string.

```
% gsql --conn-string 'DSN=GOLDILOCKS;UID=test;PWD=test'
Connected to GOLDILOCKS Database.
gSQL>
```

--dsn

Description

It connects to GOLDILOCKS by using Data Source Name (DSN) defined in the file odbc.ini.

DSN should be defined in the odbc.ini file. For more information about the odbc.ini file, refer to **DSN Configuration on UNIX**.

If DSN is omitted, the default value is GOLDILOCKS.

Examples

The following is an example of connecting to GOLDILOCKS with DSN.

```
% gsql test test --dsn GOLDILOCKS
Connected to GOLDILOCKS Database.
gSQL>
```

The content of odbc.ini file used in the example above is as follows.

```
[GOLDILOCKS]
DATE_FORMAT = SYYYY-MM-DD
TIME_FORMAT = HH24:MI:SS.FF6
```



gsql does not recognize HOST, PORT of odbc.ini file property.

--enable-color

Description

It outputs each row of query results in a different color on the terminal to easily distinguish them. Each row of the query results is output with a different color in an interactive mode, and it is also applied to the results of the SELECT statement included in the file by using the **--import** option.

Examples

The following is an example of performing gsql by using the --enable-color option, then outputting the query results in an interactive mode.

```
% gsql test test --enable-color
Connected to GOLDILOCKS Database.
gSQL> SELECT id, addr FROM t1;
ID ADDR
-- -----
1 Seoul, Korea
2 Seoul, Korea
3 Incheon, Korea
3 rows selected.
gSQL>
```

The following is an example of executing a SELECT query included in the file by using the --import option.

```
% gsql test test --import 'sample_select.sql' --enable-color
SELECT id, addr FROM t1;
ID ADDR
-- -----
 1 Seoul, Korea
 2 Seoul, Korea
 3 Incheon, Korea
3 rows selected.
%
```

--help

Description

It briefly displays the option list of gsql program.

Example

The following is an example of using the --help option.

```
% gsql --help
Usage
  gsql [user_name [password]] [options]
Arguments:
  user_name      user name
  password       password
Options:
  --version                print version information and exit
  --import FILE           import sql FILE
  --no-prompt             suppresses the display of the banner and prompts
  --dsn DSN              dsn string (default is GOLDILOCKS)
  --conn-string 'CONN-STRING' connection string
  --prompt STRING        change prompt string
  --enable-color         enable colored text
  --as {SYSDBA|ADMIN}    privilege
  --silent               suppresses the display of the result message and echoing of
commands
  --help                 print help message
%
```

--import

Description

It performs the SQL statement which is not an interactive mode in the file in batch.
The file name is enclosed in a single quote ('), and it can use an absolute or relative path.

Examples

The following is an example of executing the SQL statement by using the absolute path of the file.

```
% gsql test test --import '/home/goldilocks/sample.sql'  
DROP TABLE IF EXISTS t1;  
Table dropped.  
CREATE TABLE t1  
(  
    id    INTEGER PRIMARY KEY,  
    name  VARCHAR(128),  
    addr  VARCHAR(128)  
);  
Table created.  
CREATE INDEX t1_idx_name ON t1(name);  
Index created.  
INSERT INTO t1  
    VALUES ( 1, 'leekmo', 'Seoul, Korea' ),  
           ( 2, 'mkkim' , 'Seoul, Korea' ),  
           ( 3, 'xcom73', 'Inchon, Korea' );  
3 rows created.  
COMMIT;  
Commit complete.  
%
```

The following is an example of executing the SQL statement by using the relative path of the file.

```
% gsql test test --import 'sample.sql'  
DROP TABLE IF EXISTS t1;  
Table dropped.  
CREATE TABLE t1  
(  
    id    INTEGER PRIMARY KEY,
```



```

    name VARCHAR(128),
    addr VARCHAR(128)
);
Table created.
CREATE INDEX t1_idx_name ON t1(name);
Index created.
INSERT INTO t1
    VALUES ( 1, 'leekmo', 'Seoul, Korea' ),
           ( 2, 'mkkim' , 'Seoul, Korea' ),
           ( 3, 'xcom73', 'Inchon, Korea' );
3 rows created.
COMMIT;
Commit complete.
%
```

--no-prompt

Description

It does not output the prompt when performing an interactive mode.

Example

The following is an example of using --no-prompt.

```

% gsql test test --no-prompt
SELECT * FROM dual;
DUMMY
-----
X
1 row selected.
```

--prompt

Description

It sets the gsql prompt when performing an interactive mode.

The default value is gSQL.

The special characters or spaces are enclosed in double quotes (") as follows.

```
% gsql test test --prompt "GOLDILOCKS Venus.3.2"
```

Example

The following is an example of which the prompt is changed to GOLDILOCKS in an interactive mode by using the --prompt option.

```
% gsql test test --prompt GOLDILOCKS
Connected to GOLDILOCKS Database.
GOLDILOCKS> SELECT * FROM dual;
DUMMY
-----
X
1 row selected.
GOLDILOCKS>
```

--silent

Description

It does not output the results of SQL statement.

It is useful when executing large amounts of SQL statements by reading the file with --import command.

The --silent option is also applied when operating in an interactive mode.

Example

The following is an example of executing the DictionarySchema.sql file in the \$GOLDILOCKS_HOME/adm in directory by using the --silent option.

```
% gsql sys gliese --as sysdba --import 'DictionarySchema.sql' --silent
%
```

--version

Description

It outputs the version information of the gsql program.

It is recommended to use the gsql program with the version as same as the version of GOLDILOCKS. The GOLDILOCKS version can be viewed via the SQL function **VERSION** as follows.

```
gSQL> SELECT version() FROM dual;  
VERSION()  
-----  
Release Name.X.X.X revision(XXXXX)  
1 row selected.
```

Example

The following is an example of using the --version option.

```
% gsql --version  
%
```

34.5 Interactive Command References

All gsql-specific commands start with backslash (\) in an interactive mode.

\\

Syntax

| \\

Description

It executes the most recent successfully executed SQL statement.

Examples

```
gSQL> SELECT * FROM dual;
DUMMY
-----
X
1 row selected.
```

- It executes the most recent successfully executed SQL statement.

```
gSQL> \\
DUMMY
-----
X
1 row selected.
gSQL> SELECT * FROM invalid_table;
ERR-42000(16040): table or view does not exist :
SELECT * FROM invalid_table
          *
ERROR at line 1:
```

- It executes the most recent successfully executed SQL statement rather than executing the failed SQL statement.

```
gSQL> \\  
DUMMY  
-----  
X  
1 row selected.
```

\connect

Syntax

```
\connect username password [as sysdba]
```

Description

It is newly connected with the entered username and password.
If any uncommitted transaction exists, it performs COMMIT.

Examples

The following is an example of connecting with the test account.

```
gSQL> \connect test test  
gSQL>
```

An error occurs if the password is invalid as follows.

```
gSQL> \connect test invalid_password  
ERR-28000(16004): invalid username/password; logon denied  
gSQL> SELECT * FROM dual;  
ERR-08003(40044): connection does not exist
```

The following is an example of connecting with the SYSDBA role.

```
gSQL> \connect sys gliese as sysdba  
gSQL>
```

\cstartup

Syntax

```
\cstartup  
\cstartup nomount  
\cstartup mount  
\cstartup open  
\cstartup local open  
\cstartup global open
```

Description

It starts up GOLDILOCKS server in a cluster environment.

To execute \cstartup command, it should connect with SYSDBA role or ADMIN role. For more information about how to connect with SYSDBA role, refer to **startup and shutdown server**.

- \cstartup nomount
 - It starts up the corresponding server on NOMOUNT phase.
- \cstartup mount
 - It starts up the corresponding server on MOUNT phase.
- \cstartup local open
 - It starts up the corresponding server and other servers on LOCAL OPEN phase.
- \cstartup global open
 - It startup all servers on GLOBAL OPEN phase.
- \cstartup open
 - It is as same as \cstartup global open.
- \cstartup
 - It is as same as \cstartup global open.

\cstartup local open command and \cstartup global open command startup the corresponding server and other servers to the corresponding phase. Other commands are applied only to the corresponding server, so the server should be started up to LOCAL OPEN phase for the multi-level startup using **ALTER SYSTEM {MOUNT | OPEN} DATABASE**.

The server startup phases are classified as NOMOUNT, MOUNT, LOCAL OPEN, GLOBAL OPEN. For more information, refer to **multi-level startup**.

ALTER SYSTEM {MOUNT | OPEN} DATABASE should be performed to move on to the next phase after executing \cstartup command.

\cstartup using glocator can be viewed via **CSTARTUP** and **CSHUTDOWN**.



- It is command used only in a C/S environment. It can be used only in gsqlnet.
- Commands other than \cstartup nomount/ mount affects on the corresponding server and other servers. Therefore, if LOCATOR_DSN is not specified in **odbc.ini file**, then an error occurs.

Example

The following is an example of starting up GOLDILOCKS.

```
% gsqlnet sys gliese --as sysdba
Connected to an idle instance.
gSQL> \cstartup
Startup success
```

\cshutdown

Syntax

```
\cshutdown
\cshutdown abort
\cshutdown normal
```

Description

It shuts down GOLDILOCKS server in a cluster environment.

To execute \cshutdown command, it should connect with SYSDBA role or ADMIN role. For more information about how to connect with SYSDBA role, refer to **startup and shutdown server**.

- \cshutdown normal
 - It blocks an access of a new session, waits for all connected sessions to be terminated, executes a checkpoint, then terminates the server.
- \cshutdown abort
 - It forcibly and immediately terminates the server regardless of the status of connected sessions.
- \cshutdown
 - It is as same as \cshutdown normal.

\cshutdown using glocator can be viewed via **CSTARTUP** and **CSHUTDOWN**.



- It is command used only in a C/S environment. It can be used only in gsqlnet.
- Commands other than \cshutdown affects on the corresponding server and other servers. The refore, if LOCATOR_DSN is not specified in **odbc.ini file**, then an error occurs.

Example

The following is an example of shutting down GOLDILOCKS.

```
% gsqlnet sys gliese --as sysdba
Connected to GOLDILOCKS Database.
gSQL> \cshutdown
Shutdown success
gSQL>
```

\ddl_cluster

Syntax

```
\ddl_cluster
```

Description

It outputs a cluster DDL corresponding to the current status of a cluster system. This statement is valid in a cluster system.

Example

The following is an example of executing \ddl_cluster command for a cluster system consisting as 3 x 2.

```
gSQL> \ddl_cluster
SET SESSION AUTHORIZATION "SYS";
CREATE CLUSTER GROUP "G1"
    CLUSTER MEMBER "G1N1" HOST '127.0.0.1' PORT '10110'
;
COMMIT;
SET SESSION AUTHORIZATION "SYS";
```



```

ALTER CLUSTER GROUP "G1" ADD
    CLUSTER MEMBER "G1N2" HOST '127.0.0.1' PORT '10120'
;
COMMIT;
SET SESSION AUTHORIZATION "SYS";
CREATE CLUSTER GROUP "G2"
    CLUSTER MEMBER "G2N1" HOST '127.0.0.1' PORT '10210'
;
COMMIT;
SET SESSION AUTHORIZATION "SYS";
ALTER CLUSTER GROUP "G2" ADD
    CLUSTER MEMBER "G2N2" HOST '127.0.0.1' PORT '10220'
;
COMMIT;
SET SESSION AUTHORIZATION "SYS";
CREATE CLUSTER GROUP "G3"
    CLUSTER MEMBER "G3N1" HOST '127.0.0.1' PORT '10310'
;
COMMIT;
SET SESSION AUTHORIZATION "SYS";
ALTER CLUSTER GROUP "G3" ADD
    CLUSTER MEMBER "G3N2" HOST '127.0.0.1' PORT '10320'
;

```

\ddl_db

Syntax

```

\ddl_db
\ddl_db GRANT
\ddl_db COMMENT

```

Description

It outputs the DDL statements corresponding to the current state of the database object.

Table 34-19 \ddl_db commands

Command	Description
\ddl_db	It outputs the DDL statements of all objects created in the database.

Command	Description
\ddl_db GRANT	It outputs the GRANT .. ON DATABASE statement corresponding to the privilege information on the database object.
\ddl_db COMMENT	It outputs the COMMENT ON DATABASE statement corresponding to the comment information on the database object.

The result of \ddl_db command without any option outputs the DDL statements in the following order.

- Database DDL
- Tablespace DDL
- Profile DDL
- Authorization DDL
- Schema DDL
- Authorization schema path DDL
- Database privilege DDL
- Tablespace privilege DDL
- Schema privilege DDL
- Public synonym DDL
- Table DDL
- Table privilege DDL
- Table option DDL
- Constraint DDL
- Index DDL
- View DDL
- View privilege DDL
- Sequence DDL
- Sequence privilege DDL
- Synonym DDL
- Stored procedure/ function DDL
- Audit policy DDL

However, the information related to the following schemas which include the dictionary information are not output.

- DICTIONARY_SCHEMA
- INFORMATION_SCHEMA
- PERFORMANCE_VIEW_SCHEMA
- DEFINITION_SCHEMA
- FIXED_TABLE_SCHEMA

The DDL statement for the schema above which includes the dictionary information can be output by using **\ddl_schema**.

Examples

The following is an example of executing \ddl_db.

```
gSQL> \ddl_db
```

- Database DDL

```
SET SESSION AUTHORIZATION "SYS";
COMMENT
  ON DATABASE
  IS 'goldilocks database'
;
```

- Tablespace DDL

```
SET SESSION AUTHORIZATION "SYS";
CREATE MEMORY DATA TABLESPACE "TEST_TBS"
  DATAFILE '/home/GOLDILOCKS/workspace/product/Gliese/home/db/test1.dbf'
  SIZE 10477568 REUSE
  ONLINE
  LOGGING
  EXTSIZE 262144
;
SET SESSION AUTHORIZATION "SYS";
ALTER TABLESPACE "TEST_TBS"
  ADD DATAFILE '/home/GOLDILOCKS/workspace/product/Gliese/home/db/test2.dbf'
  SIZE 10477568 REUSE
;
SET SESSION AUTHORIZATION "SYS";
ALTER TABLESPACE "TEST_TBS"
  ADD DATAFILE '/home/GOLDILOCKS/workspace/product/Gliese/home/db/test3.dbf'
  SIZE 10477568 REUSE
;
SET SESSION AUTHORIZATION "SYS";
COMMENT
  ON TABLESPACE "TEST_TBS"
  IS 'comment tablespace TPC data'
;
SET SESSION AUTHORIZATION "SYS";
CREATE MEMORY TEMPORARY TABLESPACE "TEMP_TBS"
  MEMORY 'test_mem'
```

```

        SIZE 10477568
    EXTSIZE 262144
;
... Ellipsis ...

```

- Sequence privilege DDL

```

SET SESSION AUTHORIZATION "H_USER";
GRANT
    USAGE ON SEQUENCE "H_USER"."H_SEQ"
    TO "PUBLIC"
;
SET SESSION AUTHORIZATION "H_USER";
GRANT
    USAGE ON SEQUENCE "H_USER"."H_SEQ"
    TO "TEST"
    WITH GRANT OPTION
;
SET SESSION AUTHORIZATION "H_USER";
GRANT
    USAGE ON SEQUENCE "H_USER"."H_SEQ"
    TO "C_USER"
;
SET SESSION AUTHORIZATION "C_USER";
GRANT
    USAGE ON SEQUENCE "C_USER"."C_SEQ"
    TO "TEST"
;
SET SESSION AUTHORIZATION "C_USER";
GRANT
    USAGE ON SEQUENCE "C_USER"."C_SEQ"
    TO "H_USER"
;

```

The following is an example of executing `\ddl_db GRANT`.

```

gSQL> \ddl_db GRANT
SET SESSION AUTHORIZATION "SYS";
GRANT
    ALTER DATABASE ON DATABASE
    TO "TEST"
    WITH GRANT OPTION

```

```

;
SET SESSION AUTHORIZATION "SYS";
GRANT
    ALTER SYSTEM ON DATABASE
    TO "TEST"
    WITH GRANT OPTION
;
... Ellipsis ...

```

\ddl_tablespace

Syntax

```

\ddl_tablespace name
\ddl_tablespace name CREATE
\ddl_tablespace name ALTER
\ddl_tablespace name TABLE
\ddl_tablespace name CONSTRAINT
\ddl_tablespace name INDEX
\ddl_tablespace name GRANT
\ddl_tablespace name COMMENT

```

Description

It outputs the DDL statements for the current state of the tablespace object.

Table 34-20 \ddl_tablespace commands

Command	Description
\ddl_tablespace name	It performs all options below.
\ddl_tablespace name CREATE	It outputs the CREATE TABLESPACE statement of the tablespace object.
\ddl_tablespace name ALTER	It outputs the ALTER TABLESPACE statements for the datafile or memory added to the tablespace.
\ddl_tablespace name TABLE	It outputs the CREATE TABLE statements of the tables stored in the tablespace.
\ddl_tablespace name CONSTRAINT	It outputs the ALTER TABLE statements of the constraints stored in the tablespace.
\ddl_tablespace name INDEX	It outputs the CREATE INDEX statements of the indexes stored in the tablespace.
\ddl_tablespace name GRANT	It outputs the GRANT .. ON TABLESPACE statement for the privilege information on the tablespace.
\ddl_tablespace name COMMENT	It outputs the COMMENT ON TABLESPACE statement corresponding to the comment.

Command	Description
	nt on the tablespace.

Examples

The following is an example of executing `\ddl_tablespace CREATE`.

```
gSQL> \ddl_tablespace test_tbs CREATE
SET SESSION AUTHORIZATION "SYS";
CREATE MEMORY DATA TABLESPACE "TEST_TBS"
    DATAFILE '/home/GOLDILOCKS/workspace/product/Gliese/home/db/test1.dbf'
    SIZE 10477568 REUSE
    ONLINE
    EXTSIZE 262144
;
```

The following is an example of executing `\ddl_tablespace ALTER`.

```
gSQL> \ddl_tablespace test_tbs ALTER
SET SESSION AUTHORIZATION "SYS";
ALTER TABLESPACE "TEST_TBS"
    ADD DATAFILE
        '/home/GOLDILOCKS/workspace/product/Gliese/home/db/test2.dbf'
        SIZE 10477568 REUSE
    ,
        '/home/GOLDILOCKS/workspace/product/Gliese/home/db/test3.dbf'
        SIZE 10477568 REUSE
;
```

\ddl_profile

Syntax

```
\ddl_profile name
\ddl_profile name CREATE
\ddl_profile name COMMENT
```

Description

It outputs the DDL statement for the current state of the profile object.

Table 34-21 \ddl_profile commands

Command	Description
\ddl_profile name	It performs all options below.
\ddl_profile name CREATE	It outputs the CREATE PROFILE statement of the profile object.
\ddl_profile name COMMENT	It outputs the COMMENT ON PROFILE statement corresponding to the comment on the profile.

Example

The following is an example of executing \ddl_profile CREATE.

```
gSQL> \ddl_profile prof1 CREATE
SET SESSION AUTHORIZATION "SYS";
CREATE PROFILE "PROF1" LIMIT
    FAILED_LOGIN_ATTEMPTS    DEFAULT
    PASSWORD_LOCK_TIME       1/86400
    PASSWORD_LIFE_TIME        UNLIMITED
    PASSWORD_GRACE_TIME       100
    PASSWORD_REUSE_MAX        DEFAULT
    PASSWORD_REUSE_TIME       DEFAULT
    PASSWORD_VERIFY_FUNCTION   KISA_VERIFY_FUNCTION
;
COMMIT;
```

\ddl_audit_policy

Syntax

```
\ddl_audit_policy name
\ddl_audit_policy name CREATE
\ddl_audit_policy name AUDIT
\ddl_audit_policy name COMMENT
```

Description

It outputs the DDL statement for the current state of the audit policy object.

Table 34-22 \ddl_audit_policy commands

Command	Description
\ddl_audit_policy name	It perform all options below.
\ddl_audit_policy name CREATE	It outputs CREATE AUDIT POLICY statement of the audit policy object.
\ddl_audit_policy name AUDIT	It outputs AUDIT POLICY statement of the audit policy object.
\ddl_audit_policy name COMMENT	It outputs the COMMENT ON AUDIT POLICY statement corresponding to the comment on the audit policy.

Examples

The following is an example of executing \ddl_audit_policy CREATE.

```
gSQL> \ddl_audit_policy p1 CREATE
SET SESSION AUTHORIZATION "SYS";
CREATE AUDIT POLICY "P1"
    ACTIONS SELECT ON "PUBLIC"."T1"
        , INSERT ON "PUBLIC"."T1"
        , UPDATE ON "PUBLIC"."T2"
        , ALL ON "PUBLIC"."SEQ1"
        , SELECT ON "PUBLIC"."SEQ2"
        , EXECUTE ON "PUBLIC"."FUNC2"
;
COMMIT;
```

\ddl_auth

Syntax

```
\ddl_auth name
\ddl_auth name CREATE
\ddl_auth name SCHEMA PATH
\ddl_auth name SCHEMA
\ddl_auth name TABLE
```



```

\ddl_auth name CONSTRAINT
\ddl_auth name INDEX
\ddl_auth name VIEW
\ddl_auth name SEQUENCE
\ddl_auth name SYNONYM
\ddl_auth name PROCEDURE
\ddl_auth name COMMENT

```

Description

It outputs the DDL statements for the current state of the account object.

Table 34-23 \ddl_auth commands

Command	Description
\ddl_auth name	It performs all options below.
\ddl_auth name CREATE	It outputs the CREATE USER statement of the user object.
\ddl_auth name SCHEMA	It outputs the CREATE SCHEMA statement of schemas owned by a user.
\ddl_auth name SCHEMA PATH	It outputs the ALTER USER statement corresponding to the schema path of the account.
\ddl_auth name TABLE	It outputs the CREATE TABLE statements of tables owned by a user.
\ddl_auth name CONSTRAINT	It outputs the ALTER TABLE statements of constraints owned by a user.
\ddl_auth name INDEX	It outputs the CREATE INDEX statements of indexes owned by a user.
\ddl_auth name VIEW	It outputs the CREATE VIEW statements of views owned by a user.
\ddl_auth name SEQUENCE	It outputs the CREATE SEQUENCE statements of sequences owned by a user.
\ddl_auth name SYNONYM	It outputs the CREATE SYNONYM statements of sequences owned by a user.
\ddl_auth name PROCEDURE	It outputs the CREATE PROCEDURE/ FUNCTION statements of sequences owned by a user.
\ddl_auth name COMMENT	It outputs the COMMENT ON AUTHORIZATION statement corresponding to comments on the account.

Examples

The following is an example of executing \ddl_auth CREATE.

```

gSQL> \ddl_auth h_user CREATE
SET SESSION AUTHORIZATION "SYS";
CREATE USER "H_USER"
  IDENTIFIED BY H_USER
  DEFAULT TABLESPACE "TEST_TBS"
  TEMPORARY TABLESPACE "TEMP_TBS"
  WITHOUT SCHEMA

```

;

The following is an example of executing \ddl_auth SCHEMA.

```
gSQL> \ddl_auth h_user SCHEMA
SET SESSION AUTHORIZATION "SYS";
CREATE SCHEMA "H_USER"
    AUTHORIZATION "H_USER"
;
```

The following is an example of executing \ddl_auth TABLE.

```
gSQL> \ddl_auth h_user TABLE
SET SESSION AUTHORIZATION "H_USER";
CREATE TABLE "H_USER"."REGION"
    (
        "R_REGIONKEY" NUMBER( 10, 0 )
        , "R_NAME" CHARACTER( 25 OCTETS )
        , "R_COMMENT" CHARACTER VARYING( 152 OCTETS )
    )
PCTFREE 10
PCTUSED 60
INITRANS 4
MAXTRANS 8
STORAGE
    (
        INITIAL 524288
        NEXT 262144
        MINSIZE 524288
        MAXSIZE 562949953159168
    )
TABLESPACE "TEST_TBS"
;
SET SESSION AUTHORIZATION "H_USER";
CREATE TABLE "H_USER"."NATION"
    (
        "N_NATIONKEY" NUMBER( 10, 0 )
        , "N_NAME" CHARACTER( 25 OCTETS )
        , "N_REGIONKEY" NUMBER( 10, 0 )
        , "N_COMMENT" CHARACTER VARYING( 152 OCTETS )
    )
PCTFREE 10
```

```

PCTUSED 60
INITRANS 4
MAXTRANS 8
STORAGE
(
  INITIAL 524288
  NEXT 262144
  MINSIZE 524288
  MAXSIZE 562949953159168
)
TABLESPACE "TEST_TBS"
;

```

\ddl_schema

Syntax

```

\dddl_schema name
\dddl_schema name CREATE
\dddl_schema name TABLE
\dddl_schema name CONSTRAINT
\dddl_schema name INDEX
\dddl_schema name VIEW
\dddl_schema name SEQUENCE
\dddl_schema name SYNONYM
\dddl_schema name PROCEDURE
\dddl_schema name GRANT
\dddl_schema name COMMENT

```

Description

It outputs the DDL statements for the current state of the schema object.

Table 34-24 \ddl_schema commands

Command	Description
\ddl_schema name	It performs all options below.
\ddl_schema name CREATE	It outputs the CREATE SCHEMA statement of the schema object.
\ddl_schema name TABLE	It outputs the CREATE TABLE statements of the tables which belong to the schema.
\ddl_schema name CONSTRAI	It outputs the ALTER TABLE statements of the constraints which belong to the schem

Command	Description
NT	a.
\ddl_schema name INDEX	It outputs the CREATE INDEX statements of the indexes which belong to the schema.
\ddl_schema name VIEW	It outputs the CREATE VIEW statements of the views which belong to the schema.
\ddl_schema name SEQUENCE	It outputs the CREATE SEQUENCE statements of the sequences which belong to the schema.
\ddl_schema name SYNONYM	It outputs the CREATE SYNONYM statements of the sequences which belong to the schema.
\ddl_schema name PROCEDURE	It outputs the CREATE PROCEDURE/ FUNCTION statements of the sequences which belong to the schema.
\ddl_schema name GRANT	It outputs the GRANT .. ON SCHEMA statement for the privilege information on the schema.
\ddl_schema name COMMENT	It outputs the COMMENT ON SCHEMA statement corresponding to the comment on the schema.

Examples

The following is an example of executing \ddl_schema CREATE.

```
gSQL> \ddl_schema h_user CREATE
SET SESSION AUTHORIZATION "SYS";
CREATE SCHEMA "H_USER"
    AUTHORIZATION "H_USER"
;
```

The following is an example of executing \ddl_schema CONSTRAINT.

```
gSQL> \ddl_schema h_user CONSTRAINT
SET SESSION AUTHORIZATION "H_USER";
ALTER TABLE "H_USER"."REGION"
    ADD CONSTRAINT "H_USER"."REGION_PK"
    PRIMARY KEY
    (
        "R_REGIONKEY" ASC NULLS LAST
    )
    INDEX "REGION_PK_INDEX"
    PCTFREE 10
    INITRANS 4
    MAXTRANS 8
    STORAGE
    (
```

```
        INITIAL 524288
        NEXT    262144
        MINSIZE 524288
        MAXSIZE 562949953159168
    )
    NOLOGGING
    TABLESPACE "TEMP_TBS"
    NOT DEFERRABLE
    INITIALLY IMMEDIATE
;
SET SESSION AUTHORIZATION "H_USER";
ALTER TABLE "H_USER"."NATION"
    ADD CONSTRAINT "H_USER"."NATION_PK"
    PRIMARY KEY
    (
        "N_NATIONKEY" ASC NULLS LAST
    )
    INDEX "NATION_PK_INDEX"
    PCTFREE 10
    INITRANS 4
    MAXTRANS 8
    STORAGE
    (
        INITIAL 524288
        NEXT    262144
        MINSIZE 524288
        MAXSIZE 562949953159168
    )
    NOLOGGING
    TABLESPACE "TEMP_TBS"
    NOT DEFERRABLE
    INITIALLY IMMEDIATE
;
SET SESSION AUTHORIZATION "H_USER";
ALTER TABLE "H_USER"."SUPPLIER"
    ADD CONSTRAINT "H_USER"."SUPPLIER_PK"
    PRIMARY KEY
    (
        "S_SUPPKEY" ASC NULLS LAST
    )
    INDEX "SUPPLIER_PK_INDEX"
```

```

PCTFREE 10
INITRANS 4
MAXTRANS 8
STORAGE
(
  INITIAL 524288
  NEXT 262144
  MINSIZE 524288
  MAXSIZE 562949953159168
)
NOLOGGING
TABLESPACE "TEMP_TBS"
NOT DEFERRABLE
INITIALLY IMMEDIATE
;

```

\ddl_publicsynonym

Syntax

```

\ddl_public_synonym name
\ddl_public_synonym name CREATE

```

Description

It outputs the DDL statements for the current state of the public synonym object.

Table 34-25 \ddl_public_synonym commands

Command	Description
\ddl_public_synonym	It performs all options below.
\ddl_public_synonym name CREATE	It outputs the CREATE PUBLIC SYNONYM statement of the public synonym object.

Example

The following is an example of executing \ddl_public_synonym CREATE.

```
gSQL> \ddl_public_synonym pubsyn CREATE
SET SESSION AUTHORIZATION "SYS";
CREATE PUBLIC SYNONYM "PUBSYN" FOR "PUBLIC"."T1"
;
COMMIT;
```

\ddl_table

Syntax

```
\ddl_table name
\ddl_table name CREATE
\ddl_table name CONSTRAINT
\ddl_table name INDEX
\ddl_table name IDENTITY
\ddl_table name SUPPLEMENTAL
\ddl_table name GRANT
\ddl_table name COMMENT
```

Description

It outputs the DDL statements for the current state of the table object.

Table 34-26 \ddl_table commands

Command	Description
\ddl_table name	It performs all options below.
\ddl_table name CREATE	It outputs the CREATE TABLE statement of the table object.
\ddl_table name CONSTRAINT	It outputs the ALTER TABLE statements of the constraints created in the table.
\ddl_table name INDEX	It outputs the CREATE INDEX statements of the indexes created in the table.
\ddl_table name IDENTITY	It outputs the ALTER TABLE statement for the restart value if the table has an identity column.
\ddl_table name SUPPLEMENTAL	It outputs the ALTER TABLE statement if the supplemental log option is set on the table.
\ddl_table name GRANT	It outputs the GRANT .. ON TABLE statement for the privilege information on the table.
\ddl_table name COMMENT	It outputs the COMMENT ON TABLE statement corresponding to the comment on the table.

Examples

The following is an example of executing `\ddl_table CREATE`.

```
gSQL> \ddl_table h_user.orders CREATE
SET SESSION AUTHORIZATION "H_USER";
CREATE TABLE "H_USER"."ORDERS"
(
    "O_ORDERKEY" NUMBER( 10, 0 )
    , "O_CUSTKEY" NUMBER( 10, 0 )
    , "O_ORDERSTATUS" CHARACTER( 1 OCTETS )
    , "O_TOTALPRICE" NUMBER( 12, 2 )
    , "O_ORDERDATE" DATE
    , "O_ORDERPRIORITY" CHARACTER( 15 OCTETS )
    , "O_CLERK" CHARACTER( 15 OCTETS )
    , "O_SHIPPRIORITY" NUMBER( 10, 0 )
    , "O_COMMENT" CHARACTER VARYING( 79 OCTETS )
)
PCTFREE 10
PCTUSED 60
INITRANS 4
MAXTRANS 8
STORAGE
(
    INITIAL 524288
    NEXT 262144
    MINSIZE 524288
    MAXSIZE 562949953159168
)
TABLESPACE "TEST_TBS"
;
```

The following is an example of executing `\ddl_table GRANT`.

```
gSQL> \ddl_table h_user.nation GRANT
SET SESSION AUTHORIZATION "H_USER";
GRANT
    DELETE ON TABLE "H_USER"."NATION"
    TO "TEST"
;
SET SESSION AUTHORIZATION "H_USER";
GRANT
```



```

SELECT ( "N_NATIONKEY" ) ON TABLE "H_USER"."NATION"
TO "C_USER"
;
SET SESSION AUTHORIZATION "H_USER";
GRANT
SELECT ( "N_NAME" ) ON TABLE "H_USER"."NATION"
TO "C_USER"
;

```

\ddl_constraint

Syntax

```

\dll_constraint name
\dll_constraint name ALTER
\dll_constraint name COMMENT

```

Description

It outputs the DDL statements for the current state of the constraint object.

Table 34-27 \ddl_constraint commands

Command	Description
\ddl_constraint name	It performs all options below.
\ddl_constraint name ALTER	It outputs the ALTER TABLE statement of the constraint object.
\ddl_constraint name COMMENT	It outputs the COMMENT ON CONSTRAINT statement corresponding to the comment on the constraint.

Example

The following is an example of executing \ddl_constraint ALTER.

```

gSQL> \ddl_constraint h_user.lineitem_pk ALTER
SET SESSION AUTHORIZATION "H_USER";
ALTER TABLE "H_USER"."LINEITEM"
ADD CONSTRAINT "H_USER"."LINEITEM_PK"
PRIMARY KEY
(
"L_ORDERKEY" ASC NULLS LAST

```

```

        , "L_LINENUMBER" ASC NULLS LAST
    )
INDEX "LINEITEM_PK_INDEX"
PCTFREE 10
INITRANS 4
MAXTRANS 8
STORAGE
(
    INITIAL 524288
    NEXT 262144
    MINSIZE 524288
    MAXSIZE 562949953159168
)
NOLOGGING
TABLESPACE "TEMP_TBS"
NOT DEFERRABLE
INITIALLY IMMEDIATE
;

```

\ddl_index

Syntax

```

\ddl_index name
\ddl_index name CREATE
\ddl_index name COMMENT

```

Description

It outputs the DDL statements for the current state of the index object.

Table 34-28 \ddl_index commands

Command	Description
\ddl_index name	It performs all options below.
\ddl_index name CREATE	It outputs the CREATE INDEX statement of the index object.
\ddl_index name COMMENT	It outputs the COMMENT ON INDEX statement corresponding to the comment on the index.

Example

The following is an example of executing `\ddl_index CREATE`.

```
gSQL> \ddl_index public.idx2 CREATE
SET SESSION AUTHORIZATION "TEST";
CREATE INDEX "PUBLIC"."IDX2"
  ON "PUBLIC"."T1"
  (
    "C3" ASC NULLS LAST
    , "C1" DESC NULLS FIRST
  )
PCTFREE 10
INITRANS 4
MAXTRANS 8
STORAGE
  (
    INITIAL 524288
    NEXT 262144
    MINSIZE 524288
    MAXSIZE 562949953159168
  )
NOLOGGING
TABLESPACE "MEM_TEMP_TBS"
;
```

`\ddl_view`

Syntax

```
\ddl_view name
\ddl_view name CREATE
\ddl_view name GRANT
\ddl_view name COMMENT
```

Description

It outputs the DDL statements for the current state of the view object.

Table 34-29 \ddl_view commands

Command	Description
\ddl_view name	It performs all options below.
\ddl_view name CREATE	It outputs the CREATE VIEW statement of the view object.
\ddl_view name GRANT	It outputs the GRANT .. ON TABLE statement for the privilege information on the view.
\ddl_view name COMMENT	It outputs the COMMENT ON TABLE corresponding to the comment on the view.

Example

The following is an example of executing \ddl_view CREATE.

```
gSQL> \ddl_view h_user.revenue CREATE
SET SESSION AUTHORIZATION "H_USER";
CREATE OR REPLACE FORCE VIEW "H_USER"."REVENUE"
  (supplier_no, total_revenue)
AS SELECT
  l_suppkey,
  ROUND( sum(l_extendedprice * (1 - l_discount)), 2)
FROM
  lineitem
WHERE
  l_shipdate >= date '1996-01-01'
  AND l_shipdate < date '1996-01-01' + interval '3' month
GROUP BY
  l_suppkey
;
```

\ddl_sequence

Syntax

```
\ddl_sequence name
\ddl_sequence name CREATE
\ddl_sequence name RESTART
\ddl_sequence name GRANT
\ddl_sequence name COMMENT
```

Description

It outputs the DDL statements for the current state of the sequence object.

Table 34-30 \ddl_sequence commands

Command	Description
\ddl_sequence name	It performs all options below.
\ddl_sequence name CREATE	It outputs the CREATE SEQUENCE statement of the sequence object.
\ddl_sequence name RESTART	It outputs the ALTER SEQUENCE statement corresponding to the restart value of the sequence object.
\ddl_sequence name GRANT	It outputs the GRANT .. ON SEQUENCE statement for the privilege information on the sequence.
\ddl_sequence name COMMENT	It outputs the COMMENT ON SEQUENCE statement corresponding to the comment on the sequence.

Examples

The following is an example of executing \ddl_sequence CREATE.

```
gSQL> \ddl_sequence h_user.h_seq CREATE
SET SESSION AUTHORIZATION "H_USER";
CREATE SEQUENCE "H_USER"."H_SEQ"
    START WITH 1
    INCREMENT BY 1
    MAXVALUE 9223372036854775807
    MINVALUE 1
    NO CYCLE
    CACHE 20
;
```

The following is an example of executing \ddl_sequence RESTART.

```
gSQL> \ddl_sequence h_user.h_seq RESTART
SET SESSION AUTHORIZATION "H_USER";
ALTER SEQUENCE "H_USER"."H_SEQ"
    RESTART WITH 21
;
```

\ddl_synonym

Syntax

```
\ddl_synonym name  
\ddl_synonym name CREATE
```

Description

It outputs the DDL statements for the current state of the synonym object.

Table 34-31 \ddl_synonym commands

Command	Description
\ddl_synonym	It performs all options below.
\ddl_synonym name CREATE	It outputs the CREATE SYNONYM statement of the synonym object.

Example

The following is an example of executing \ddl_synonym CREATE.

```
gSQL> \ddl_synonym syn CREATE  
SET SESSION AUTHORIZATION "TEST";  
CREATE SYNONYM "PUBLIC"."SYN" FOR "PUBLIC"."T1"  
;  
COMMIT;
```

\ddl_procedure

Syntax

```
\ddl_procedure name  
\ddl_procedure name CREATE
```

Description

It outputs the DDL statements for the current state of the stored procedure or the function object.

Table 34-32 \ddl_procedure commands

Command	Description
\ddl_procedure	It performs all options below.
\ddl_procedure name CREATE	It outputs CREATE PROCEDURE/ FUNCTION statement of the stored procedure/ function object.

Example

The following is an example of executing \ddl_procedure CREATE.

```
gSQL> \ddl_procedure proc1 CREATE
SET SESSION AUTHORIZATION "TEST";
CREATE OR REPLACE PROCEDURE "PUBLIC"."PROC1"
is
begin
  null;
end;
/
COMMIT;
```

\desc

Syntax

```
\desc table_name
\desc schema_name.table_name
```

Description

It queries the structure information of the table.

A table may be described only with the table name as follows or described together with the schema name. If the schema name is not specified, the schema name of the table is determined by the **Schema Path** of the user.

- \desc t1
- \desc public.t1

If a table name is created by using **Identifiers** when creating a table as follows, the double quotes (") is used to describe it.

- Creating a table
 - CREATE TABLE "Table#@^*" (id INTEGER);
- \desc "Table#@^*"
- \desc "PUBLIC"."Table#@^*"

The execution result includes the following information of the table.

- Column information
 - Column name
 - Data type
 - Whether NULL is allowed
- Index information
 - Index name
 - Storage space for index
 - Index type
 - Whether UNIQUE is allowed
 - Key column name
- Constraint information
 - Constraint name
 - Constraint type
 - The related index
 - Constraint column

Examples

The following is an example of querying the information of the t1 table.

```
gSQL> \desc t1
COLUMN_NAME TYPE IS_NULLABLE
-----
ID NUMBER(10,0) FALSE
NAME CHARACTER VARYING(128) TRUE
ADDR CHARACTER VARYING(1024) TRUE
INDEX_NAME TABLESPACE_NAME INDEX_TYPE IS_UNIQUE COLUMNS
-----
T1_PRIMARY_KEY_INDEX MEM_TEMP_TBS BTREE TRUE ID
T1_IDX_NAME MEM_TEMP_TBS BTREE FALSE NAME
CONSTRAINT_NAME CONSTRAINT_TYPE ASSOCIATED_INDEX COLUMNS
-----
T1_PRIMARY_KEY PRIMARY KEY T1_PRIMARY_KEY_INDEX ID
```

The following is an example of querying the information of the t1 table by describing together with the s

chema name public.

```
gSQL> \desc public.t1
COLUMN_NAME TYPE                IS_NULLABLE
-----
ID          NUMBER(10,0)                FALSE
NAME       CHARACTER VARYING(128)    TRUE
ADDR       CHARACTER VARYING(1024)   TRUE
INDEX_NAME TABLESPACE_NAME INDEX_TYPE IS_UNIQUE COLUMNS
-----
T1_PRIMARY_KEY_INDEX MEM_TEMP_TBS BTREE TRUE ID
T1_IDX_NAME MEM_TEMP_TBS BTREE FALSE NAME
CONSTRAINT_NAME CONSTRAINT_TYPE ASSOCIATED_INDEX COLUMNS
-----
T1_PRIMARY_KEY PRIMARY KEY T1_PRIMARY_KEY_INDEX ID
```

The following is an example of querying the information of the table created by using the delimited identifier.

```
gSQL> CREATE TABLE "Table#@^*" ( id INTEGER );
Table created.
gSQL> \desc "Table#@^*"
COLUMN_NAME TYPE                IS_NULLABLE
-----
ID          NUMBER(10,0)                TRUE
```

If the delimited identifier is not used as follows, then an error occurs.

```
gSQL> \desc Table#@^*
ERR-42000(40000): syntax error
\desc Table#@^*
..... ^ ^
Error at line 1
```

\dynamic sql :var

Syntax

```
\dynamic sql :var
```

Description

It executes the SQL statement stored in the host variable var.

It is similar in concept to **Embedded Dynamic SQL** which executes SQL statements that are not defined in an embedded SQL, but It is used when performing SQL statement which is not defined.

It is performed in the following order.

1. Declare a host variable. (Refer to **\var**.)

```
\var var_stmt VARCHAR(1024)
```
2. Assign an SQL statement as the value of the host variable. (Refer to **\exec :var := value**.)

```
\exec :var_stmt := 'SELECT # FROM t1'
```
3. Execute the dynamic SQL.

```
\dynamic sql :var_stmt
```

Examples

The following is an example of declaring the var_stmt host variable and executing the dynamic SQL by assigning an SQL statement.

- Assigning the SELECT statement to the host variable

```
gSQL> \exec :var_stmt := 'SELECT * FROM t1'
```

- Executing the dynamic SQL

```
gSQL> \dynamic sql :var_stmt
ID NAME  ADDR
-- -----
 1 leekmo Seoul, Korea
1 row selected.
```

Two single quote (') are described like as the usage of the **\exec :var := value** command when a string exists in an SQL statement as the INSERT statement below.

- Declaring a host variable

```
gSQL> \var var_stmt VARCHAR(1024)
```

- Assigning the INSERT statement to the host variable

```
gSQL> \exec :var_stmt := 'INSERT INTO t1(id, name, addr) VALUES ( 1, ''leekmo'', ''Seoul,
Korea'' )'
```

- Executing the dynamic SQL.

```
gSQL> \dynamic sql :var_stmt
1 row created.
```

\edit

Description

It edits the SQL statement by using the text editor. The used text editor is specified in the EDITOR environment variable, and if the EDITOR environment variable does not exist, vi is used by default.

When using the editing feature, gsql hands over control by executing the editor. The user can freely edit the SQL statements with the editor. When the editor ends, the control is handed over to gsql, and its content will be added as the last history.

The SQL statement edited by the editor may be executed through the last history execution command \.



Only a single SQL statement can be edited with the SQL editor. An error occurs when executing multiple SQL statements.

The followings can be edited by using \edit.

- The most recently performed SQL statement
- the SQL statement stored in a file
- The SQL statement stored in the gsql history

The following chapter describes the usage.

\edit

Syntax

```
\edit
\ed
```

Description

It edits the most recently executed SQL statement by using the text editor. If any SQL statement has not been executed, the text editor is run without any content.

Example

The following is an example of editing the most recently executed SQL statement.

- Editing the most recently executed SQL statement

```
gSQL> SELECT * FROM T1;
C1
--
 1
11
2 rows selected.
gSQL> \EDIT
SELECT * FROM T1 WHERE C1 < 10;
```

- Executing the edited SQL statement

```
gSQL> \\  
C1  
--  
 1  
1 row selected.
```

\edit 'file_name'

Syntax

```
\edit 'file_name'  
\ed 'file_name'
```

Description

It edits the given file_name by using the text editor.

The file_name is enclosed with the single quote (').

file_name can use either an absolute path or a relative path as follows. When file_name uses a relative path, it searches for the file_name based on the path of gsql execution.

- Using the absolute path

```
gSQL> \edit '/home/goldilocks/sample.sql'
```

- Using the relative path

```
gSQL> \edit 'sample.sql'
```

Example

The following is an example of editing the SQL statement stored in the file.

- Editing the most recently executed SQL statement

```
gSQL> SELECT * FROM T1;
C1
--
 1
11
2 rows selected.
gSQL> \EDIT 'sample.sql'
SELECT * FROM T1 WHERE C1 < 10;
```

- Executing the edited SQL statement

```
gSQL> \\  
C1  
--  
 1  
1 row selected.
```

\edit [history] {n}

Syntax

```
\edit [history] {n}  
\ed  [history] {n}
```

Description

It edits the SQL statement corresponding to the number from the SQL execution history which can be queried by using **\history**.

The value of number should be the ID value which is the result of executing **\history**.

Example

The following is an example of editing the SQL statement stored in the gsql history.

```
gSQL> SELECT * FROM T1;
C1
--
 1
11
2 rows selected.
gSQL> \history
ID SQL
-- -----
 1 SELECT * FROM T1
```

- Editing the SQL statement whose ID value is 1 from the stored history

```
gSQL> \edit 1
SELECT * FROM T1 WHERE C1 < 5;
```

- Executing the edited SQL statement

```
gSQL> \\  
C1  
--  
 1  
1 row selected.
```

\exec

Syntax

```
\exec
```

Description

It executes the SQL statement which is prepared by `\prepare sql`.

`\exec` operates similarly to the `SQLExecute` function of ODBC and `PreparedStatement::execute` function of JDBC.

The prepared SQL statements can be repeatedly executed by using `\exec`.

Examples

The following is an example of preparing an INSERT statement and repeatedly executing it.

- Preparing the INSERT statement

```
gSQL> \prepare sql INSERT INTO t1(id, addr) VALUES ( seq.NEXTVAL, 'N/A' );
SQL prepared.
```

- Executing the prepared statement

```
gSQL> \exec
1 row created.
```

- Executing the prepared statement

```
gSQL> \exec
1 row created.
```

- The results of querying the table are as follows.

```
gSQL> SELECT * FROM t1;
ID ADDR
-- ----
 1 N/A
 2 N/A
2 rows selected.
```

The following is an example of preparing the SELECT statement with the host variable and repeatedly executing it by changing the host variable value.

- Declaring the host variable

```
gSQL> \var v_id INTEGER
```

- Preparing the SELECT statement which used the host variable

```
gSQL> \prepare sql SELECT * FROM t1 WHERE ID = :v_id;
SQL prepared.
```

- Assigning the value 1 to the host variable

```
gSQL> \exec :v_id := 1
```

- Executing the prepared SELECT statement

```
gSQL> \exec
ID ADDR
-- ----
1 N/A
1 row selected.
```

- Assigning the value 2 to the host variable

```
gSQL> \exec :v_id := 2
```

- Executing the prepared SELECT statement

```
gSQL> \exec
ID ADDR
-- ----
2 N/A
1 row selected.
```

\exec :var := value

Syntax

```
\exec :variable := <value expression>
```

Description

It assigns the value to the host variable.

This command assigns a value to the host variable in the same way as executing **SELECT .. INTO** as follows.

```
gSQL> \exec :v_value := 1234
gSQL> SELECT 1234 INTO :v_value FROM DUAL;
```

The host variable must have been declared with **\var**.

The host variable must be used together with colon (:), and the assignment operator (:=) is not allowed t

o omit (:). Simple values or operators may appear in <value expression> entered to the host variable. For more information, refer to **Expressions**.

The value assigned to the host variable should be compatible with the data type of the host variable. For more information, refer to **Type Conversion**.

The value assigned to the host variable may be queried by using **\print**.

```
\exec :v_value := 1234
\print v_value
```

The string should be enclosed in the single quote (') as follows when inserting the string into the host variable.

- Simple string
 - Value: abcd
 - \exec :v_value := 'abcd'
- The string which includes the single quote
 - Value: Tom's House
 - The single quote within the string is represented with the two single quotes (') as follows.
 - \exec :v_value := 'Tom''s House'
- The SQL statement including the single quote
 - Value: INSERT INTO t1 VALUES (1, 'Tom''s House')
 - The single quote within the string is represented with the two single quotes (') as follows.
 - \exec :v_value := 'INSERT INTO t1 VALUES (1, "Tom''s House")'

Examples

The following is an example of assigning the various types of string to the host variable.

- Declaring the host variable

```
gSQL> \var v_value VARCHAR(1024)
```

- Assigning the simple string

```
gSQL> \exec :v_value := 'abcd'
gSQL> \print v_value
V_VALUE
-----
abcd
```

- Assigning the string including the single quote (')

```
gSQL> \exec :v_value := 'Tom''s House'
gSQL> \print v_value
V_VALUE
-----
Tom's House
```

- Assigning the SQL statement including the single quote (')

```
gSQL> \exec :v_value := 'INSERT INTO t1 VALUES ( 1, ''Tom''s House'' )'
gSQL> \print v_value
V_VALUE
-----
INSERT INTO t1 VALUES ( 1, 'Tom's House' )
```

The following is an example of using the operation result when assigning the value to the host variable.

- Declaring the host variable

```
gSQL> \var v1 INTEGER
gSQL> \var v2 INTEGER
```

- Assigning the value to v1

```
gSQL> \exec :v1 := 100
```

- Assigning the result of operation with v1 to v2

```
gSQL> \exec :v2 := :v1 + 1000
```

- Querying the value of host variables v1 and v2

```
gSQL> \print v1
V1
---
100
gSQL> \print v2
V2
----
1100
```

The following is an example of assigning the value to the host variable and using the host variable in the SELECT statement.

- Declaring the host variable

```
gSQL> \var v_id INTEGER
```

- Assigning the value to the host variable

```
gSQL> \exec :v_id := 1
```

- Executing the SELECT statement by using the host variable

```
gSQL> SELECT * FROM t1 WHERE id = :v_id;
ID ADDR
-- ----
 1 N/A
1 row selected.
```

The following is an example of obtaining the value to the host variable via **SELECT .. INTO**.

- Declaring the host variable

```
gSQL> \var v_id INTEGER
```

- A value is not specified.

```
gSQL> \print v_id
V_ID
----
null
```

- Assigning the value to v_id by executing the SELECT INTO statement

```
gSQL> SELECT MAX(id) INTO :v_id FROM t1;
V_ID
----
 2
1 row selected.
```

- Checking the host variable value

```
gSQL> \print v_id
V_ID
----
 2
```

\exec sql

Syntax

```
\exec sql <sql_statement>
```

Description

It executes the SQL statement described in <sql_statement>.

It operates as same as the execution of the SQL statement at the prompt as follows.

```
gSQL> SELECT * FROM dual;
DUMMY
-----
X
1 row selected.
gSQL> \exec sql SELECT * FROM dual;
DUMMY
-----
X
1 row selected.
```

The SQL statement is executed with the PREPARE/EXECUTE method using **\prepare sql** and **\exec**. On the other hand, **\exec sql** executes the SQL statement with the DIRECT EXECUTE method corresponding to **SQLExecDirect** function of ODBC and to **Statement::execute** function of JDBC.

Example

The following is an example of executing the SELECT statement.

```
gSQL> \exec sql SELECT * FROM dual;
DUMMY
-----
X
1 row selected.
```

\explain plan

Syntax

```
\explain plan <sql_statement>
\explain plan on <sql_statement>
\explain plan only <sql_statement>
```

Description

It outputs the execution plan of the SELECT statement described in <sql_statement>.

- \explain plan on
 - It executes the SQL statement and outputs the execution plan along with the query results.
- \explain plan only
 - It does not execute the SQL statement and outputs the execution plan without the query results.
- \explain plan
 - If on or only is not specified, the default value is on.

For more information about the execution plan, refer to [SQL Execution Plan](#).

Examples

If it is used together with ON as follows, it executes the SQL statement and outputs the execution plan with the query results.

```
gSQL> \explain plan on SELECT * FROM t1 WHERE id = 1;
ID NAME  ADDR
-- -----
 1 leekmo Seoul, Korea
1 row selected.
>>> start print plan
< Execution Plan >
=====
|  IDX  |  NODE DESCRIPTION          |  ROWS  |
-----|-----|-----|
|   0   |  SELECT STATEMENT          |         |
|   1   |  TABLE ACCESS ("T1")      |         1 |
=====
1 - READ COLUMNS : ID, NAME, ADDR
```

```

                PHYSICAL FILTER : ID = 1
<<< end print plan

```

If it is used together with ONLY as follows, it does not execute the SQL statement and outputs the execution plan without the query results.

```

gSQL> \explain plan only SELECT * FROM t1 WHERE id = 1;
>>> start print plan
< Execution Plan >
=====
|  IDX  |  NODE DESCRIPTION          |  ROWS  |
-----|-----|-----|
|   0   |  SELECT STATEMENT          |         |
|   1   |  TABLE ACCESS ("T1")     |        0 |
=====
      1 - READ COLUMNS : ID, NAME, ADDR
          PHYSICAL FILTER : ID = 1
<<< end print plan

```

\help

Syntax

```
\help
```

Description

It briefly displays the list of commands which begin with (\) in gsql interactive mode.

Examples

The following is an example of using \help.

```

gSQL> \help
\help
\q[uit]
\i[mport] {'FILE'}          Import SQL
\ed[it] [{'FILE'}[HISTORY] num]} Edit SQL statement
\\                          Executes the most recent history entry

```

```

\{n}                               Executes n'th history entry
\hi[story]                          Show history entries
\desc    {[schema.]table_name}      Show table description
\idesc   {[schema.]index_name}      Show index description
\spo[ol] ['filename' | OFF]         Stores query results in a file
\ho[st]  [command]                  Executes an operating system command
\set vertical    {ON|OFF}
\set time        {ON|OFF}
\set timing      {ON|OFF}
\set color       {ON|OFF}
\set error       {ON|OFF}
\set autocommit  {ON|OFF}
\set autotrace   {ON|TRACEONLY|OFF}
\set serveroutput {ON|OFF}
\set heading     {ON|OFF}
\set linesize   {n}      0 < n <= 100000
\set pagesize    {n}      0 < n <= 100000
\set colsize     {n}      0 < n <= 104857600
\set numsize     {n}      0 < n <= 50
\set ddlsize     {n}      0 < n <= 100000
\set history     {n}      n <= 100000 ( if n < 0, clear history buffer )
\var             {host_var_name} {INTEGER|BIGINT|VARCHAR(n)}
\exec            [[:host_var_name] := {constant}]
\exec sql       {sql string}
\prepare sql    {sql string}
\dynamic sql    {host_var_name}
\explain plan   [{ON|ONLY}] {sql string}
\print          [{host_var_name}]
\ddl_db
\ddl_tablespace {name}
\ddl_auth       {name}
\ddl_schema    {name}
\ddl_table     {[schema.]name}
\ddl_constraint {[schema.]name}
\ddl_index     {[schema.]name}
\ddl_view      {[schema.]name}
\ddl_sequence  {[schema.]name}
\ddl_synonym   {[schema.]name}
\ddl_publicsynonym {name}
\startup       {[nomount|mount|open]}
\shutdown      {[abort|immediate|transactional|normal]}

```

```
\cstartup      {[nomount|mount|open]}
\cshutdown     {[abort|normal]}
\connect       [userid password] [as {sysdba|admin}]
```

\host

Syntax

```
\host [command]
\ho [command]
```

Description

It executes the command of the operational system without terminating gsql program.

If HOST is input without command, then the prompt of the operational system is displayed and it is able to continuously input the command of the operational system.

Instead of HOST, "\$" is input in Windows, and "!" is input in UNIX.

Example

The following is an example of executing ls *.sql statement which is a command of UNIX operational system.

```
gSQL> \host ls *.sql
DictionarySchema.sql  InformationSchema.sql  PerformanceViewSchema.sql
```

\history

Syntax

```
\history
\hi
```

Description

It displays the list of the SQL statements executed after executing gsql program.

It manages only the successfully executed SQL statements and it does not include the failed SQL statements nor the interactive command which begins with gsql(\).

The previously executed SQL statements can be executed again referring to the list through \ or \{n}.

The number of manageable SQL statements is controlled by using **\set history**.

Example

The following is an example of querying the SQL statement execution history and executing the SQL statement of number 8 again.

```
gSQL> \history
ID SQL
-----
 1 drop table t1
 2 create table t1 ( id integer, name varchar(128), addr varchar(1024) )
 3 create index t1_idx on t1(id)
 4 insert into t1 values ( 1, 'leekmo', 'Seoul, Korea' )
 5 insert into t1 values ( 2, 'mkkim', 'Seoul, Korea' )
 6 insert into t1 values ( 3, 'xcom73', 'Inchon, Korea' )
 7 commit
 8 select * from dual
gSQL> \8
DUMMY
-----
X
1 row selected.
```

\import

Syntax

```
\import 'file_name'
\i 'file_name'
```

Description

It imports the SQL statement included in file_name.

The file_name is enclosed with the single quote (').

file_name can use either an absolute path or a relative path as follows. When file_name uses a relative path, it searches for the file_name based on the path of gsql execution.

- Using the absolute path

```
gSQL> \import '/home/GOLDILOCKS/sample.sql'
```

- Using the relative path

```
gSQL> \import 'sample.sql'
```

Examples

The following is an example of importing the SQL statement from the file by using the absolute path.

```
gSQL> \import '/home/GOLDILOCKS/sample.sql'
DROP TABLE IF EXISTS t1;
Table dropped.
CREATE TABLE t1
(
  id    INTEGER,
  name  VARCHAR(128),
  addr  VARCHAR(128)
);
Table created.
INSERT INTO t1
VALUES ( 1, 'leekmo', 'Seoul, Korea' ),
       ( 2, 'mkkim' , 'Seoul, Korea' ),
       ( 3, 'xcom73', 'Inchon, Korea' );
3 rows created.
COMMIT;
Commit complete.
```

The following is an example of importing the SQL statement from the file by using the relative path.

```
gSQL> \import 'sample.sql'
DROP TABLE IF EXISTS t1;
Table dropped.
```

```
CREATE TABLE t1
(
  id  INTEGER,
  name VARCHAR(128),
  addr VARCHAR(128)
);
Table created.
INSERT INTO t1
VALUES ( 1, 'leekmo', 'Seoul, Korea' ),
       ( 2, 'mkkim' , 'Seoul, Korea' ),
       ( 3, 'xcom73', 'Inchon, Korea' );
3 rows created.
COMMIT;
Commit complete.
```

\idesc

Syntax

```
\idesc index_name
\idesc schema_name.index_name
```

Description

It queries the structure information of the index.

An index can be described alone as follows or it can be described together with the schema name. If the schema name is not specified, the schema name of the index is determined by the user's **Schema Path**.

- \idesc t1_idx_name
- \idesc public.t1_idx_name

The execution result includes the following key column information of the index.

- Key column name
- Key column location
- Key column sort order (ascending/ descending)
- NULL position of the key column(FIRST/ LAST)

Example

The following is an example of querying the information of the index t1_idx_name.

```
gSQL> \idesc t1_idx_name
COLUMN_NAME  ORDINAL_POSITION  IS_ASCENDING_ORDER  IS_NULLS_FIRST
-----
NAME                1  TRUE                FALSE
```

\{n}

Syntax

```
\number
```

Description

It executes the SQL statement corresponding to the number from the SQL execution history which can be queried by using **\history**.

The value of number should be the ID value which is the result of executing **\history**.

Examples

The following is an example of executing SQL statement which used **\history**, then executing the DROP TABLE statement whose ID value is 1.

```
gSQL> \history
ID SQL
-----
1 DROP TABLE IF EXISTS t1
2 CREATE TABLE t1
  (
    id  INTEGER PRIMARY KEY,
    name VARCHAR(128),
    addr VARCHAR(128)
  )
3 CREATE INDEX t1_idx_name ON t1(name)
4 INSERT INTO t1
  VALUES ( 1, 'leekmo', 'Seoul, Korea' ),
```

```

        ( 2, 'mkkim' , 'Seoul, Korea' ),
        ( 3, 'xcom73', 'Inchon, Korea' )
5 COMMIT
6 select * from t1
gSQL> \1
Table dropped.

```

\prepare sql

Syntax

```
\prepare sql <sql_statement>
```

Description

It prepares the SQL statement described in <sql_statement>. The prepared SQL statement can be executed repeatedly with **\exec**.

\prepare sql operates similarly to the **SQLPrepare** functions of ODBC and **Connection::prepareStatement** function of JDBC.

Example

The following is an example of preparing the SELECT statement and repeatedly executing it.

- Preparing the SELECT statement

```

gSQL> \prepare sql SELECT * FROM t1 WHERE id > 2;
SQL prepared.

```

- Executing the prepared SQL statement

```

gSQL> \exec
ID NAME      ADDR
-----
3 xcom73 Inchon, Korea
1 row selected.
gSQL> INSERT INTO t1 VALUES ( 4, 'GOLDILOCKS', 'Better Place' );
1 row created.

```

- Executing the prepared SQL statement again

```
gSQL> \exec
ID NAME      ADDR
-----
3 xcom73 Inchon, Korea
4 goldilocks Better Place
2 rows selected.
```

\print

Syntax

```
\print
\print variable
```

Description

It queries the value of host variable declared with **\var** as follows. If the value of host variable is not set, it is NULL.

```
gSQL> \var v1 INTEGER
gSQL> \print v1
  V1
----
null
```

If the name of host variable is not specified as follows, it queries all declared host variables. VAR_ELAPSED_TIME__ is a built-in host variable which manages the execution time of SQL statement as follows.

```
gSQL> \print
NAME                VALUE
-----
VAR_ELAPSED_TIME__ null
V1                   21
V2                   10
```

Example

The following is an example of declaring the host variable, assigning the value to the host variable then querying it.

- Declaring the host variable

```
gSQL> \var v1 INTEGER
gSQL> \var v2 INTEGER
gSQL> \var v3 INTEGER
```

- Querying all host variables

```
gSQL> \print
NAME                VALUE
-----
VAR_ELAPSED_TIME__  null
V1                   null
V2                   null
V3                   null
```

- Assigning the value to the host variable

```
gSQL> \exec :v1 := 10
gSQL> \exec :v2 := 20
gSQL> \exec :v3 := :v1 + :v2
```

- Querying the host variable v3

```
gSQL> \print v3
V3
--
30
```

- Querying all host variables

```
gSQL> \print
NAME                VALUE
-----
VAR_ELAPSED_TIME__  null
V1                   10
V2                   20
V3                   30
```

`\quit`

Syntax

```
\quit  
\q
```

Description

It quits gsql.

When quitting gsql, all uncommitted transactions are committed.

Example

```
gSQL> \quit  
%
```

`\set autocommit`

Syntax

```
\set autocommit on  
\set autocommit off
```

Description

It sets whether to automatically commit after executing the SQL statement.

- `\set autocommit on`
 - It automatically commits after executing the SQL statement.
- `\set autocommit off`
 - It does not automatically commit after executing the SQL statement.
- The default value of autocommit is OFF.

Examples

The following is a usage example when setting the AUTOCOMMIT value to ON.

- Setting the autocommit to on

```
gSQL> \set autocommit on
```

- The INSERT statement is automatically committed.

```
gSQL> INSERT INTO t1 ( id, name, addr ) VALUES ( 1, 'leekmo', 'Seoul, Korea' );
1 row created.
```

- It is not affected by rollback.

```
gSQL> ROLLBACK;
Rollback complete.
gSQL> SELECT * FROM t1;
ID NAME  ADDR
-- -----
 1 leekmo Seoul, Korea
1 row selected.
```

The following is a usage example when setting the AUTOCOMMIT value to OFF.

- Setting the autocommit to off

```
gSQL> \set autocommit off
```

- The transaction is not committed after executing the INSERT statement.

```
gSQL> INSERT INTO t1 ( id, name, addr ) VALUES ( 1, 'leekmo', 'Seoul, Korea' );
1 row created.
```

- The transaction is rolled back.

```
gSQL> ROLLBACK;
Rollback complete.
```

- The INSERT statement is rolled back without any result.

```
gSQL> SELECT * FROM t1;
no rows selected.
```

\set autotrace

Syntax

```
\set autotrace on
\set autotrace traceonly
\set autotrace off
```

Description

It sets whether to output the execution plan.

- \set autotrace on
 - It executes SQL statement, and outputs the execution plan together with the query result.
- \set autotrace traceonly
 - It does not execute SQL statement, and outputs the execution plan without the query result.
- \set autotrace off
 - It does not output the execution plan.
 - The default value is off.

For more information, refer to [SQL execution plan](#).

Example

When using ON as follows, it executes SQL statement and outputs the execution plan together with the query result.

```
gSQL> \set autotrace on
gSQL> SELECT * FROM t1 WHERE id = 1;
ID NAME  ADDR
-----
1 leekmo Seoul, Korea
1 row selected.
>>> start print plan
< Execution Plan >
=====
|  IDX  |  NODE DESCRIPTION          |  ROWS  |
-----|-----|-----|
|    0  |  SELECT STATEMENT          |         |
|    1  |  TABLE ACCESS ("T1")      |        1 |
```

```

=====
1 - READ COLUMNS : ID, NAME, ADDR
    PHYSICAL FILTER : ID = 1
<<< end print plan

```

When using TRACEONLY as follows, it does not execute SQL statement, and outputs the execution plan without the query result.

```

gSQL> \set autotrace traceonly
gSQL> SELECT * FROM t1 WHERE id = 1;
>>> start print plan
< Execution Plan >
=====
|  IDX  |  NODE DESCRIPTION          |  ROWS  |
-----|-----|-----|
|   0   |  SELECT STATEMENT          |         |
|   1   |  TABLE ACCESS ("T1")     |        0 |
=====
1 - READ COLUMNS : ID, NAME, ADDR
    PHYSICAL FILTER : ID = 1
<<< end print plan

```

\set color

Syntax

```

\set color on
\set color off

```

Description

It sets whether to output each row of the query results in a different color on the terminal to distinguish them.

- \set color on
 - Each row is output in a different color.
- \set color off
 - Each row is output in the same color.
- The default value is OFF.

If the length of each row is too long so that it overflows the terminal window, then the row is output over multiple lines. In this case, each row is hard to be distinguished, so it reduces the readability. It is used to distinguish between the rows and increase the readability on the terminal.

Example

The following is an example of setting the color to ON.

```
gSQL> \set color on
gSQL> SELECT id, addr FROM t1;
ID ADDR
-----
1 Seoul, Korea
2 Seoul, Korea
3 Incheon, Korea
3 rows selected.
```

\set colsize

Syntax

```
\set colsize number
```

Description

It sets the maximum length of the data when outputting LONG VARCHAR, LONG VARBINARY data.

- The colsize value is a positive integer between 1 and 104,857,600.(100M, the maximum length of LONG VARCHAR)
- The default value of colsize is 8,192.

The string length of the LONG VARCHAR column is too long, so the readability of the query execution is low as follows. In this case, the readability of LONG VARCHAR column can be increased by reducing the colsize, or it may be output as long as the desired length by enlarging the colsize.

```
gSQL> SELECT view_name, text FROM all_views WHERE view_name LIKE 'ALL_%' FETCH 3;
VIEW_NAME
-----
TEXT
-----
```

```

ALL_ALL_TABLES
SELECT
    auth.AUTHORIZATION_NAME          ❶ OWNER
    , sch.SCHEMA_NAME                ❷ TABLE_SCHEMA
    ... Ellipsis ...
    WHERE
    , pvcol.GRANTEE_ID
    , pvcol.PRIVILEGE_TYPE_ID

```

3 rows selected.

Example

The following is an example of increasing the readability of the LONG VARCHAR column by reducing the colsize.

```

gSQL> \set colsize 200
gSQL> SELECT view_name, text FROM all_views WHERE view_name LIKE 'ALL_%' FETCH 3;
VIEW_NAME      TEXT
-----
ALL_ALL_TABLES  SELECT
                auth.AUTHORIZATION_NAME          ❶ OWNER
                , sch.SCHEMA_NAME                ❷ TABLE_SCHEMA
                , tab.TABLE_NAME                  ❸ TABLE_NAME
                , spc.TAB
ALL_COL_COMMENTS  SELECT
                auth.AUTHORIZATION_NAME
                , sch.SCHEMA_NAME
                , tab.TABLE_NAME
                , col.COLUMN_NAME
                , col.COMMENTS
                FROM
                DICTIONARY_SCHEMA.WHOLE_COLUMNS AS col
                , DICTIONARY_S
ALL_COL_PRIVS    SELECT
                grantor.AUTHORIZATION_NAME
                , grantee.AUTHORIZATION_NAME
                , owner.AUTHORIZATION_NAME
                , sch.SCHEMA_NAME
                , tab.TABLE_NAME

```

```
, col.COLUMN_NAME
, pvcol.PRIVILEGE_TY
```

3 rows selected.

\set ddlsize

Syntax

```
\set ddlsize number
```

Description

It sets the buffer size to output the statement when outputting the DDL statements by using the following commands.

- \ddl_db
 - \ddl_tablespace
 - \ddl_auth
 - \ddl_schema
 - \ddl_table
 - \ddl_constraint
 - \ddl_index
 - \ddl_view
 - \ddl_sequence
 - \ddl_synonym
 - \ddl_public_synonym
- The value of ddlsize is a positive integer between 1 and 1,0485,760 (10M).
 - The default value of ddlsize is 10,000.

If an error occurs due to the lack of buffer space as follows, DDL statement may be output by increasing the value of ddlsize.

```
gSQL> \set ddlsize 1000
gSQL> \ddl_view dictionary_schema.all_tables
ERR-HY000(40052): not enough DDLSIZE.
use command: \set ddlsize {n}
gSQL> \set ddlsize 100000
gSQL> \ddl_view dictionary_schema.all_tables
SET SESSION AUTHORIZATION "SYS";
```

```
CREATE OR REPLACE FORCE VIEW "DICTIONARY_SCHEMA"."ALL_TABLES"
... Ellipsis ...
```

Example

The following is an example of changing the ddlsize.

```
gSQL> \set ddlsize 100000
gSQL>
```

\set error

Syntax

```
\set error on
\set error off
```

Description

It sets whether to output the error message.

- \set error on
 - It outputs the error message.
- \set error off
 - It does not output the error message.
- The default value of error is ON.

If an error occurs during executing the SQL statement, gsql outputs the following information.

- SQLSTATE: SQL standard state code
- Error code: GOLDILOCKS error code
- Error message

The following example describes that the error of the SQL statement occurs, the SQLSTATE value in ERR-42000(16040) is 42000, and the error code is 16040 within ().

```
gSQL> SELECT * FROM invalid_table;
ERR-42000(16040): table or view does not exist :
SELECT * FROM invalid_table
      *
```

ERROR at line 1:

Example

The following is an example of disabling the error message.

- Disabling the error message

```
gSQL> \set error off
```

- Outputting only the value of SQLSTATE and the error code

```
gSQL> SELECT * FROM invalid_table;  
ERR-42000(16040)
```

\set heading

Syntax

```
\set heading {ON|OFF}
```

Description

It sets whether to output the header in the query result.

Example

- Set not to output the header message.

```
gSQL> \set heading off
```

- The following is an example of a query result in which the header message is not output.

```
gSQL> select * from dual;  
X  
1 row selected.
```

\set history

Syntax

```
\set history number
```

Description

It sets the number of SQL statements to manage the history information.

- The history value is a positive integer between 1 and 100,000.
- If the history value is set to a negative value, all SQL history are removed.
- The default value of history is 128.

If the history value is reduced, the old SQL statement is removed.

The history information is used when executing the previously executed SQL statement again through `\` and `{n}`.

Example

The following is an example of setting the number of history to 100.

```
gSQL> \set history 100
gSQL>
```

The following is an example of setting the number of history to smaller than the number of stored SQL statements.

- Five SQL statements are stored.

```
gSQL> \history
ID SQL
-----
1 DROP TABLE IF EXISTS t1
2 CREATE TABLE t1
  (
    id   INTEGER PRIMARY KEY,
    name VARCHAR(128),
    addr VARCHAR(128)
  )
3 CREATE INDEX t1_idx_name ON t1(name)
```

```

4 INSERT INTO t1
      VALUES ( 1, 'leekmo', 'Seoul, Korea' ),
      ( 2, 'mkkim' , 'Seoul, Korea' ),
      ( 3, 'xcom73', 'Inchon, Korea' )
5 COMMIT

```

- The history value is reduced to 3.

```
gSQL> \set history 3
```

- Three SQL statements are stored.

```

gSQL> \history
ID SQL
-----
3 CREATE INDEX t1_idx_name ON t1(name)
4 INSERT INTO t1
      VALUES ( 1, 'leekmo', 'Seoul, Korea' ),
      ( 2, 'mkkim' , 'Seoul, Korea' ),
      ( 3, 'xcom73', 'Inchon, Korea' )
5 COMMIT

```

The following is an example of removing all SQL statements stored in the history.

```

gSQL> \history
ID SQL
-----
1 SELECT * FROM dual
2 SELECT * FROM user_tables

```

- All SQL history are removed by using a negative value.

```

gSQL> \set history -1
gSQL> \history
gSQL>

```

\set linesize

Syntax

```
\set linesize number
```

Description

It sets the maximum size of a single line when outputting the query result.

- The value of linesize is a positive integer between 1 and 10,000.
- The default value of linesize is 80.

Each row of the query result is output on a single line basis. If there are many columns in a row or the row length is bigger than linesize, a row is output to the multiple lines so the readability is decreased.

```
gSQL> SELECT * FROM dict_columns WHERE table_name = 'USER_TABLES' FETCH 3;
TABLE_SCHEMA      TABLE_NAME  COLUMN_NAME
-----
COMMENTS
-----
DICTIONARY_SCHEMA USER_TABLES TABLE_SCHEMA
Schema of the table
DICTIONARY_SCHEMA USER_TABLES TABLE_NAME
Name of the table
DICTIONARY_SCHEMA USER_TABLES TABLESPACE_NAME
Name of the tablespace containing the table
3 rows selected.
```

In this case, a row may be controlled to be output in a single line by changing the linesize value.

Example

The following is an example of increasing the readability by setting the linesize larger.

```
gSQL> \set linesize 400
gSQL> SELECT * FROM dict_columns WHERE table_name = 'USER_TABLES' FETCH 3;
TABLE_SCHEMA      TABLE_NAME  COLUMN_NAME      COMMENTS
-----
DICTIONARY_SCHEMA USER_TABLES TABLE_SCHEMA    Schema of the table
DICTIONARY_SCHEMA USER_TABLES TABLE_NAME      Name of the table
DICTIONARY_SCHEMA USER_TABLES TABLESPACE_NAME  Name of the tablespace containing the table
3 rows selected.
```

\set numsize

Syntax

```
\set numsize number
```

Description

It sets the maximum number of digit for the output of a numeric value.

- The numsize value is a positive integer between 1 and 50.
- The default value of numsize is 20.

If the number of digit of a numeric value exceeds the numsize range as follows, it is output in an exponential form.

```
gSQL> SELECT num, ( num * num ) AS result FROM t1;
          NUM                RESULT
-----
1234567890123 1.52415787532276E+24
1 row selected.
```

By changing the value of numsize, these numeric value is output in a numeric form, not in an exponential form.

Example

The following is an example of outputting all digits of the numeric value by setting the numsize larger.

```
gSQL> \set numsize 50
gSQL> SELECT num, ( num * num ) AS result FROM t1;
          NUM                RESULT
-----
1234567890123 1524157875322755800955129
1 row selected.
```

\set pagesize

Syntax

```
\set pagesize number
```

Description

It sets the number of the rows which is to be consisted in a single page.

- The value of pagesize is a positive integer between 1 and 10,000.
- The default value of pagesize is 20.

It is set when there are many rows of the query results or when a page should consist of a certain number of row.

Example

The following is an example of consisting a page in 10 rows unit.

```
gSQL> \set linesize 120
gSQL> \set pagesize 10
gSQL> SELECT column_name, comments FROM dict_columns WHERE table_name = 'SEQUENCES';
COLUMN_NAME      COMMENTS
-----
OWNER_ID          authorization identifier who owns the table of the sequence generator
SCHEMA_ID         schema identifier of the sequence generator
SEQUENCE_ID       sequence generator identifier
SEQUENCE_TABLE_ID table id of sequence for naming resolution
TABLESPACE_ID     tablespace identifier of the sequence generator
PHYSICAL_ID       physical identifier of the sequence generator
SEQUENCE_NAME     sequence generator name
DTD_IDENTIFIER    unsupported feature
START_VALUE       the start value of the sequence generator
MINIMUM_VALUE     the minimum value of the sequence generator
COLUMN_NAME      COMMENTS
-----
MAXIMUM_VALUE     the maximum value of the sequence generator
INCREMENT         the increment of the sequence generator
CYCLE_OPTION      The values of CYCLE_OPTION have the following meanings:
```

- TRUE : The cycle option of the sequence generator is CYCLE.
- FALSE : The cycle option of the sequence generator is NO CYCLE.

```

CACHE_SIZE          number of sequence numbers to cache
CREATED_TIME        created time of the sequence generator
MODIFIED_TIME       last modified time of the sequence generator
COMMENTS            comments of the sequence generator
SEQUENCE_CATALOG    catalog name of the sequence
SEQUENCE_OWNER      owner name of the sequence
SEQUENCE_SCHEMA     schema name of the sequence
COLUMN_NAME         COMMENTS
-----
SEQUENCE_NAME       sequence name
DATA_TYPE           the standard name of the data type
NUMERIC_PRECISION   the numeric precision of the numerical data type
NUMERIC_PRECISION_RADIX the radix ( 2 or 10 ) of the precision of the numerical data type
NUMERIC_SCALE       the numeric scale of the exact numerical data type
START_VALUE         the start value of the sequence generator
MINIMUM_VALUE       the minimum value of the sequence generator
MAXIMUM_VALUE       the maximum value of the sequence generator
INCREMENT           the increment of the sequence generator
CYCLE_OPTION        cycle option
COLUMN_NAME         COMMENTS
-----
CACHE_SIZE          number of sequence numbers to cache
DECLARED_DATA_TYPE  the data type name that a user declared
DECLARED_NUMERIC_PRECISION the precision value that a user declared
DECLARED_NUMERIC_SCALE the scale value that a user declared
CREATED_TIME        created time of the sequence generator
MODIFIED_TIME       last modified time of the sequence generator
COMMENTS            comments of the sequence generator
37 rows selected.
```

\set serveroutput

Syntax

```

\set serveroutput on
\set serveroutput off
```

Description

It controls automatic output feature for the message writeten by functions of which DBMS_OUTPUT pack age provides in gsql or gsqlnet

- \set serveroutput on
 - It automatically outputs messages accumulated in the server by DBMS_OUTPUT.PUT_LINE after e xecuting SQL.
- \set serveroutput off
 - It does not use DBMS_OUTPUT package.
- The default value of serveroutput is OFF.

Basically, the maximum size of accumulated in the server is 20000 bytes.

Example

The following is an example of outputting the messages accumulated in a user defined function which w as used in SQL statement.

```
gSQL> create or replace function my_msg( msg varchar(100) )
return integer
is
begin
  dbms_output.put_line( 'my message is : ' || msg );
  return length( msg );
end;
/
2 3 4 5 6 7 8
Function created.
gSQL> commit;
Commit complete.
gSQL> \set serveroutput on
gSQL> select my_msg( 'Hello World!' ) from dual;
MY_MSG( 'Hello World!' )
-----
                               12
my message is : Hello World!
1 row selected.
```

\set time

Syntax

```
\set time on  
\set time off
```

Description

It sets whether to output the current time.

- \set time on
 - It outputs the current time.
- \set time off
 - It does not output the current time.
- The default value of time is OFF.

Example

The following is an example of outputting the current time.

```
gSQL> \set time on  
12:45:34 gSQL> SELECT * FROM dual;  
DUMMY  
-----  
X  
1 row selected.  
Elapsed time: 0.07600 ms
```

\set timing

Syntax

```
\set timing on  
\set timing off
```

Description

It sets whether to output the execution time of SQL statement.

- `\set timing on`
 - The execution time is output.
- `\set timing off`
 - The execution time is not output.
- The default value of timing is OFF.

The unit of execution time is ms (millisecond).

Example

The following is an example of outputting the execution time of SQL statement.

```
gSQL> \set timing on
gSQL> SELECT * FROM dual;
DUMMY
-----
X
1 row selected.
Elapsed time: 0.07600 ms
```

`\set vertical`

Syntax

```
\set vertical on
\set vertical off
```

Description

It sets whether to output the value of column in line unit.

- `\set vertical on`
 - A column is output in a line unit.
- `\set vertical off`
 - A row is output in a line unit.
- The default value of vertical is OFF.

If each row has an individual information, the readability can be increased by outputting the query result in a column unit.

If `\set vertical on` is set, then each row is separated by a blank line, and one line represents a single value, then it is consisted in the following form.

```
column name # data value
```

Example

The following is an example of outputting a query result in a column unit.

```
gSQL> \set vertical on
gSQL> SELECT * FROM v$system_stat FETCH 10;
      STAT_NAME # SYSTEM_SAR
      STAT_VALUE # 3
      COMMENTS # system available resource( 0:none, 1:session 2:database )
      STAT_NAME # MAX_ENVIRONMENT_COUNT
      STAT_VALUE # 128
      COMMENTS # maximum environment count
      STAT_NAME # FREE_ENVIRONMENT_ID
      STAT_VALUE # 81
      COMMENTS # available environment identifier
      STAT_NAME # MAX_SESSION_COUNT
      STAT_VALUE # 128
      COMMENTS # maximum session count
      STAT_NAME # FREE_SESSION_ID
      STAT_VALUE # 82
      COMMENTS # available session identifier
      STAT_NAME # MAX_PROCESS_COUNT
      STAT_VALUE # 128
      COMMENTS # maximum process count
      STAT_NAME # FREE_PROCESS_ID
      STAT_VALUE # 1
      COMMENTS # available process identifier
      STAT_NAME # CACHE_ALIGNED_SIZE
      STAT_VALUE # 64
      COMMENTS # cache aligned size
      STAT_NAME # CPU_COUNT
      STAT_VALUE # 8
      COMMENTS # count of CPUs
      STAT_NAME # SYSTEM_TIME
```

```
STAT_VALUE # 1408676900172925
```

```
COMMENTS # system time
```

```
10 rows selected.
```

\shutdown

Syntax

```
\shutdown
```

```
\shutdown abort
```

```
\shutdown immediate
```

```
\shutdown transactional
```

```
\shutdown normal
```

Description

It shuts down the GOLDILOCKS server.

It should be connected as SYSDBA or ADMIN role to perform \shutdown. For more information about connecting as SYSDBA, refer to **Startup and Shutdown Server**.

- \shutdown normal
 - It blocks the connection from the new session and waits for all currently connected sessions to be terminated, then performs the checkpoint and shuts down the server.
- \shutdown transactional
 - It blocks the start of a new transaction and waits for all currently running transactions to be terminated, then performs the checkpoint and shuts down the server.
- \shutdown immediate
 - It blocks the execution of a new unit operation(ex FETCH or EXECUTE, etc.), waits for all currently running unit operations to be terminated, then rolls back all transactions and performs the checkpoint and shuts down the server.
- \shutdown abort
 - The server is forcibly shut down immediately regardless of the status of the currently connected session.
- \shutdown
 - It is as same as \shutdown normal.

Example

The following is an example of shutting down GOLDILOCKS.

```
% gsql --as sysdba
Connected to GOLDILOCKS Database.
gSQL> \shutdown
Shutdown success
gSQL>
```

\spool

Description

It sets all results output by using gsql to be stored in the terminal and file.

\spool 'filename'

Syntax

```
\spool 'filename' [CREATE | REPLACE | APPEND]
\spo  'filename' [CREATE | REPLACE | APPEND]
```

Description

It starts the spool function. All output results performed by gsql are stored in the given filename since executing this statement.

The following options describe how to open the file.

- CREATE: It creates the file. If a file already exists, an error occurs.
- REPLACE: It removes the contents of an existing file, and newly starts storing. If a file does not exist, it performs as same as CREATE.
- APPEND: It continues to store the contents from the end of an existing file. If a file does not exist, it performs as same as CREATE.

If these options are not given, it is operated in REPLACE mode by default.



When starting a new spool during spooling, the existing spool stops and a new spool starts.

Example

The following is an example of starting spooling.

- Creating the result.txt file and storing the gsql execution result

```
gSQL> \SPOOL 'result.txt' CREATE
gSQL> SELECT * FROM T1 WHERE C1 < 10;
gSQL> \SPOOL OFF
```

- Continuing to store the result at the end of the existing result.txt file

```
gSQL> \SPOOL 'result.txt' APPEND
gSQL> SELECT * FROM T1 WHERE C1 >= 10;
gSQL> \SPOOL OFF
```

- Removing the contents of the existing result.txt file and storing a new result

```
gSQL> \SPOOL 'result.txt' REPLACE
gSQL> SELECT * FROM T1;
gSQL> \SPOOL OFF
```

\spool OFF

Syntax

```
\spool OFF
\spo  OFF
```

Description

It ends the current spool. If the spool is not in use, it does not perform any transaction.

Example

The following is an example of starting the spool then ending it.

```
gSQL> \SPOOL 'result.txt'
gSQL> SELECT * FROM T1;
```

- Ending spooling

```
gSQL> \SP00L OFF
```

\spool

Syntax

```
\spool  
\spo
```

Description

It represents the current spool state. If the spool is in use, it informs which file is spooling. Otherwise, it informs that the spool is not in use.

Example

The following is an example of editing the SQL statement stored in the gsql history.

```
gSQL> \SP00L 'a.txt'
```

- It informs that it is spooling in a.txt.

```
gSQL> \SP00L
```

```
currently spooling to a.txt
```

```
gSQL> \SP00L OFF
```

- It informs that it is not spooling.

```
gSQL> \SP00L
```

```
not spooling currently
```

\startup

Syntax

```
\startup  
\startup nomount
```

```
\startup mount
```

```
\startup open
```

Description

It starts up the GOLDILOCKS server.

It should be connected as SYSDBA or ADMIN role to perform \startup.

For more information about connecting as SYSDBA, refer to **Startup and Shutdown Server**.

- \startup nomount
 - It starts up the server on the NOMOUNT phase.
- \startup mount
 - It starts up the server on the MOUNT phase.
- \startup open
 - It starts up the server on the OPEN phase.
- \startup
 - It is as same as \startup open.

The server start up is divided into NOMOUNT, MOUNT, OPEN phase. For more information, refer to **Multi-level Startup**.

Execute **ALTER SYSTEM {MOUNT | OPEN} DATABASE** statement to move on to the next phase after executing \startup.

Example

The following is an example of starting up GOLDILOCKS.

```
% gsql --as SYSDBA
Connected to an idle instance.
gSQL> \startup
Startup success
```

\var

Syntax

```
\var variable_name data_type
```

Description

It declares the host variable.

When declaring the host variable which is as same as `variable_name`, the existing host variable is removed and a new one is declared. The maximum length of `variable_name` is 128 bytes.

The `data_type` of host variable is as same as the data type of GOLDILOCKS.

For more information, refer to **Data Type**.

The host variable assigns the value by using `\exec :var := value`, and its value is queried by using `\print`.

```
gSQL> \var v1 INTEGER
gSQL> \exec :v1 := 1
gSQL> \print v1
V1
--
1
```

The host variable can be used as an input or output parameter in the SQL statement. When the host variable is used in the SQL statement or `\exec :var := value`, a colon (:) sign should be put in front of the host variable to indicate that it is a host variable.

Example

The following is an example of declaring the host variable and using it as an input argument of the SQL statement.

```
gSQL> \var v1 INTEGER
gSQL> \exec :v1 := 1
gSQL> SELECT * FROM t1 WHERE id = :v1;
ID NAME  ADDR
-----
1 leekmo Seoul, Korea
1 row selected.
```

The following is an example of using the host variable as an output argument of the SQL statement.

```
gSQL> \var v_name VARCHAR(128)
gSQL> SELECT name INTO :v_name FROM t1 WHERE id = 1;
V_NAME
-----
leekmo
1 row selected.
```

The following is an example of declaring the host variable and using it as the input and output arguments of the SQL statement.

In the following **UPDATE name RETURNING .. INTO** statement, the host variable of SET clause and WHERE clause, `:v_id`, is used as an input argument and `:v_id` of INTO clause is used as an output argument.

```
gSQL> \var v_name VARCHAR(128)
gSQL> \var v_id INTEGER
gSQL> \exec :v_id := 1
gSQL> UPDATE t1 SET id = 100 + :v_id WHERE id = :v_id RETURNING id INTO :v_id;
V_ID
----
 101
1 row updated.
gSQL> \print v_id
V_ID
----
 101
```

35.

gloader/gloadernet (Upload/download Tool)

35.1 Overview of gloder and gloadernet

gloder is a utility which downloads or uploads data of GOLDILOCKS in table unit.

Table 35-1 Execution files

Name	Description
gloder	It is used in Direct Attach (D/A) environment.
gloadernet	It is used in Client/ Server (C/S) environment.

Environment

gloder should be connected to the database and it requires attention to all required files while using gloder.

Figure 1 gloder environment

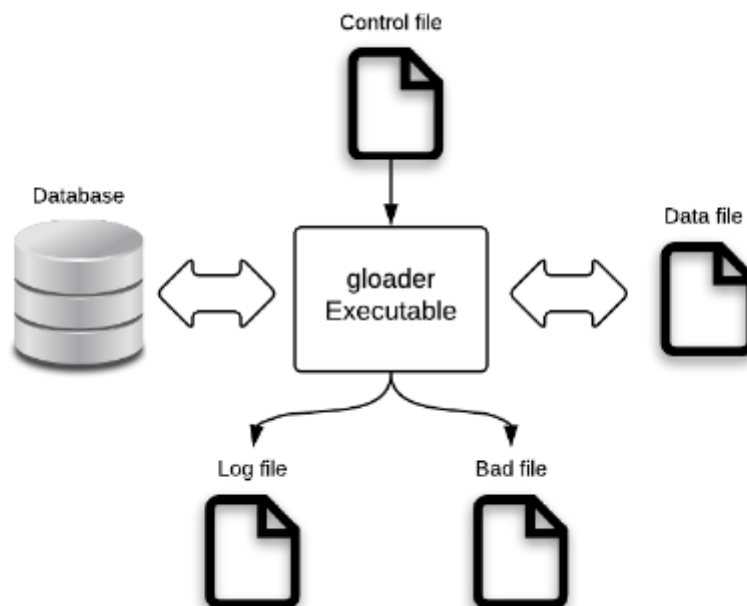

The control file and datafile are required to upload the data, then the log file is generated as a result. The control file is required to download the data, then the datafile, log file, and bad file are generated as the results.

Control File

The control file is a file for operating gloder and it includes the following information. (Refer to **Control File Syntax**.)

- Table name
- Schema name
- The delimiter between columns in a row
- The qualifier notifying the start and end of the data
- The delimiter between rows
- Character set
- Whether to trim the whitespace character
- Where clause

DataFile

The datafile should be prepared when gloder uploads the data, and it is created when gloder downloads the data.

The datafile supports text format and binary format.

- The datafile in text format has an advantage of which the file contents can be checked and directly updated.
- The datafile in binary format can be performed faster comparing to the datafile in text format.



gloder uses direct I/O for the data file by default. gloder arbitrarily adjusts the file size if the file size is not an array appropriate for direct I/O when uploading the data file by using direct I/O.

Log File

Log file is a file which stores the following errors and results which occur while operating gloder.

- The row number and cause of the error
- The operating results of gloder

Bad File

Bad file is a file which stores the rows in which an error occurred while gloder uploads the data. The delimiter between columns and rows, and the qualifier which are used to store the bad file should be user-defined.

Example

The following is an example of downloading and uploading data by using gloder.

A table is created by using the SQL statement as follows.

```
$ cat test.sql
CREATE TABLE TEST
(
TEST_NAME VARCHAR(60),
TEST_NUM INTEGER,
TEST_TIME TIMESTAMP(0) WITH TIME ZONE
);
INSERT INTO TEST VALUES
( 'NAME', 1, '1999-01-08 04:05:06.789 -8:00' );
INSERT INTO TEST VALUES
( 'NAME', 2, '1999-01-08 04:05:06.789 -8:00' );
INSERT INTO TEST VALUES
( 'NAME', 3, '1999-01-08 04:05:06.789 -8:00' );
COMMIT;
```

The control file is used as follows.

```
$ cat testctl
TABLE TEST
FIELDS TERMINATED BY ','
OPTIONALLY ENCLOSED BY '"'
LINES TERMINATED BY '\n'
```

- Export: It downloads the data.

```
$ gloder test test --export --control testctl --data test.dat --no-prompt
COMPLETED IN EXPORTING TABLE: PUBLIC.TEST, 3 RECORDS
$ cat test.dat
"NAME","1","1999-01-08 04:05:07. -08:00"
"NAME","2","1999-01-08 04:05:07. -08:00"
"NAME","3","1999-01-08 04:05:07. -08:00"
$ cat test.log
cat test.log
COMPLETED IN EXPORTING TABLE: PUBLIC.TEST, 3 RECORDS [ Start Time: 2010-1-1 01:01:01 End Time:
2010-1-1 01:01:01 Taken Time: 56496 micro-sec ]
```

- Import: It uploads the data.

```
$ cat import.dat
"NAME","1","1999-01-08 04:05:07. -08:00"
"NAME","2","1999-01-08 04:05:07. -08:00"
"NAME","3","1999-01-08 04:05:07. -08:00"
"FAIL","FAIL","FAIL"
$ gloder test test --import --control test.ctl --data import.dat --no-prompt
COMPLETED IN IMPORTING TABLE: PUBLIC.TEST, TOTAL 4 RECORDS, SUCCEEDED 3 RECORDS
$ gsql test test
gSQL> select * from test;
TEST_NAME TEST_NUM TEST_TIME
-----
NAME          1 1999-01-08 04:05:07.000000 -08:00
NAME          2 1999-01-08 04:05:07.000000 -08:00
NAME          3 1999-01-08 04:05:07.000000 -08:00
NAME          1 1999-01-08 04:05:07.000000 -08:00
NAME          2 1999-01-08 04:05:07.000000 -08:00
NAME          3 1999-01-08 04:05:07.000000 -08:00
6 rows selected.
$ cat import.log
Err Rec(4) Col(2): 22018(12006): data value is not a numeric literal
COMPLETED IN IMPORTING TABLE: PUBLIC.TEST, TOTAL 4 RECORDS, SUCCEEDED 3 RECORDS [ Start Time:
2010-1-1 01:01:01 End Time: 2010-1-1 01:01:01 Taken Time: 56496 micro-sec ]
$ cat import.bad
"FAIL","FAIL","FAIL"
```

35.2 Using gloder

Datafile Type

Text Datafile

It is represented with a string which can be checked and edited by the user. A user can directly create, edit the file, or can download the data from the existing tables in the database. A user also can use the data in a text format downloaded from another DBMS products.

The description for the representation of the text type datafile is recorded in the control file.

Binary Datafile

The file consists of binary data. A user can not directly create or edit the binary datafile. The file is generated when downloading the data from the existing tables in the database.

The binary type file is uploaded faster than the text type because the data is written to the file appropriate to the data structure type defined in GOLDILOCKS.



When GOLDILOCKS databases' versions are different one another, then it is not recommended to upload/ download by using a binary datafile. Also, it may be required to change a column size when uploading/ downloading data between databases whose string sets are different.

Downloading Data

Downloading in Text File

Simple Download

The following is the structure and data of the table to be downloaded.

```
$ cat test.sql
CREATE TABLE TEST ( I1 INTEGER PRIMARY KEY, I2 VARCHAR(10), I3 VARBINARY(10) );
INSERT INTO TEST VALUES( 1, 'LKH', X'10' );
INSERT INTO TEST VALUES( 2, 'KMM', X'A0' );
INSERT INTO TEST VALUES( 3, 'ksj', X'CD' );
COMMIT;
```



```
$ gsql test test
gSQL> SELECT * FROM TEST;
I1 I2 I3
-- --- --
 1 LKH 10
 2 KMM A0
 3 ksj CD
3 rows selected.
```

The following is the contents of the control file which is created to download the table data.

```
$ cat test.ct1
TABLE PUBLIC.test
FIELDS TERMINATED BY ','
```

The data in the table T1 is downloaded through gloder as follows.

```
$ gloder test test --export --control test.ct1 --data test.dat
COMPLETED IN EXPORTING TABLE: PUBLIC.test, 3 RECORDS
```

The data in the table TEST is downloaded to the datafile as follows.

```
$ ls
test.ct1 test.dat test.log
$ cat test.dat
1,LKH,10
2,KMM,A0
3,ksj,CD
```

Whitespace Character

The following is the structure and data of the table to be downloaded.

```
$ cat test.sql
CREATE TABLE TEST ( I1 INTEGER PRIMARY KEY, I2 VARCHAR(10), I3 VARBINARY(10) );
INSERT INTO TEST VALUES( 1, ' L K H ', X'10' );
INSERT INTO TEST VALUES( 2, 'KIM
MM', X'A0' );
INSERT INTO TEST VALUES( 3, ' KIM S
J ', X'CD' );
COMMIT;
$ gsql test test
```

```
gSQL> SELECT * FROM TEST;
I1 I2      I3
-- ----- --
 1  L K H  10
 2 KIM     A0
   MM
 3  KIM S  CD
   J
3 rows selected.
```

- The control file without using OPTIONALLY ENCLOSED BY statement
 - The following is the contents of the control file which is created to download the table data.

```
$ cat test.ctl
TABLE PUBLIC.test
FIELDS TERMINATED BY ','
LINES TERMINATED BY '\n'
```

- The data in the table TEST is downloaded to the datafile as follows.

```
$ ls
test.ctl test.dat test.log
$ cat test.dat
1, L K H ,10
2,KIM
MM,A0
3, KIM S
J ,CD
```



The control file should be used with the OPTIONALLY ENCLOSED BY statement for the data including the white space to maintain the downloaded data and the uploaded data as same.

- The control file using OPTIONALLY ENCLOSED BY statement
 - The following is the contents of the control file which is created to download the table data.

```
$ cat test.ctl
TABLE PUBLIC.test
FIELDS TERMINATED BY ','
OPTIONALLY ENCLOSED BY ''''
```

```
LINES TERMINATED BY '\n'
```

- The data in the table TEST is downloaded to the datafile as follows.

```
$ ls
test.ctl test.dat test.log
$ cat test.dat
"1"," L K H ","10"
"2","KIM
MM","A0"
"3"," KIM S
J ","CD"
```

Time Related Data Type

DATE, TIME, TIME WITH TIME ZONE, TIMESTAMP, TIMESTAMP WITH TIME ZONE are output in the property default format when downloaded.

The following is each data type of DATE, TIME WITH TIME ZONE, TIMESTAMP WITH TIME ZONE.

```
$ gsql test test
gSQL> SELECT PROPERTY_VALUE, INIT_VALUE FROM V$PROPERTY WHERE PROPERTY_NAME LIKE
'NLS_DATE_FORMAT';
PROPERTY_VALUE                INIT_VALUE
-----
YYYY-MM-DD                    YYYY-MM-DD
1 row selected.
gSQL> SELECT PROPERTY_VALUE, INIT_VALUE FROM V$PROPERTY WHERE PROPERTY_NAME LIKE
'NLS_TIME_WITH_TIME_ZONE_FORMAT';
PROPERTY_VALUE                INIT_VALUE
-----
HH24:MI:SS.FF6 TZH:TZM       HH24:MI:SS.FF6 TZH:TZM
1 row selected.
gSQL> SELECT PROPERTY_VALUE, INIT_VALUE FROM V$PROPERTY WHERE PROPERTY_NAME LIKE
'NLS_TIMESTAMP_WITH_TIME_ZONE_FORMAT';
PROPERTY_VALUE                INIT_VALUE
-----
YYYY-MM-DD HH24:MI:SS.FF6 TZH:TZM YYYY-MM-DD HH24:MI:SS.FF6 TZH:TZM
1 row selected.
```

The following is the structure and data of the table to be downloaded.

```

$ cat test.sql
CREATE TABLE TEST ( I1 INTEGER, I2 DATE, I3 TIME WITH TIME ZONE, I4 TIMESTAMP WITH TIME ZONE
);
INSERT INTO TEST VALUES ( 1, '1999-12-31', '01:01:01', '1999-12-31 01:01:01.789 -8:00' );
INSERT INTO TEST VALUES ( 2, '2000-01-01', '23:12:12', '2000-01-01 23:12:06.0 +8:00' );
INSERT INTO TEST VALUES ( 3, '2000-12-31', '23:12:12', '2000-12-31 23:12:12.0 -8:00' );
COMMIT;
$ gsql test test
gSQL> SELECT * FROM T1;
I1 I2          I3                      I4
-----
 1 1999-12-31 01:01:01.000000 +09:00 1999-12-31 01:01:01.789000 -08:00
 2 2000-01-01 23:12:12.000000 +09:00 2000-01-01 23:12:06.000000 +08:00
 3 2000-12-31 23:12:12.000000 +09:00 2000-12-31 23:12:12.000000 -08:00
3 rows selected.

```

The following is the contents of the control file which is created to download the table data.

```

$ cat test.ctl
TABLE PUBLIC.test
FIELDS TERMINATED BY ','
OPTIONALLY ENCLOSED BY '"'
LINES TERMINATED BY '\n'

```

The data in the table TEST is downloaded to the datafile as follows.

```

$ gloder test test -e -c test.ctl -d test.dat
COMPLETED IN EXPORTING TABLE: PUBLIC.TEST, 3 RECORDS
$ ls
test.ctl test.dat test.log
$ cat test.dat
"1","1999-12-31 00:00:00","01:01:01.000000 +09:00","1999-12-31 01:01:01.789000 -08:00"
"2","2000-01-01 00:00:00","23:12:12.000000 +09:00","2000-01-01 23:12:06.000000 +08:00"
"3","2000-12-31 00:00:00","23:12:12.000000 +09:00","2000-12-31 23:12:12.000000 -08:00"

```

Downloading in Binary File

Simple Download

The following is the structure and data of the table to be downloaded.

```

$ cat test.sql
CREATE TABLE TEST ( I1 INTEGER PRIMARY KEY, I2 VARCHAR(10), I3 VARBINARY(10) );
INSERT INTO TEST VALUES( 1, 'LKH', X'10' );
INSERT INTO TEST VALUES( 2, 'KMM', X'A0' );
INSERT INTO TEST VALUES( 3, 'ksj', X'CD' );
COMMIT;
$ gsql test test
gSQL> SELECT * FROM TEST;
I1 I2 I3
-- --- --
 1 LKH 10
 2 KMM A0
 3 ksj CD
3 rows selected.

```

The following is the contents of the control file which is created to download the table data.

```

$ cat test.ctl
TABLE PUBLIC.test
FIELDS TERMINATED BY ','

```

The data in the table TEST is downloaded through gloder as follows.

```

$ gloder test test --export --control test.ctl --data test.dat --format binary
COMPLETED IN EXPORTING TABLE: PUBLIC.test, 3 RECORDS

```

The following file is generated after executing gloder.

```

$ ls
test.ctl test.dat test.log

```



A user can not directly check or edit the binary file.

Complex Download

The following is the structure and data of the table to be downloaded.

```

$ gsql test test
gSQL>\desc TEST
COLUMN_NAME TYPE IS_NULLABLE
-----

```

```

I1          NUMBER(10,0)          TRUE
I2          DATE                  TRUE
I3          TIME(6) WITH TIME ZONE TRUE
I4          TIMESTAMP(6) WITH TIME TRUE
gSQL> SELECT COUNT(*) FROM TEST;
COUNT(*)
-----
1572864
1 row selected.

```

The following is the contents of the control file which is created to download the table data.

```

$ cat test.ctl
TABLE PUBLIC.test
FIELDS TERMINATED BY ','

```

- Downloading in a single file
 - The data in the table TEST is downloaded through gloder as follows.

```

$ gloder test test --export --control test.ctl --data test.dat --format binary
loaded 1000 records into PUBLIC.TEST
loaded 2000 records into PUBLIC.TEST
... Ellipsis ...
loaded 1571000 records into PUBLIC.TEST
loaded 1572000 records into PUBLIC.TEST
COMPLETED IN EXPORTING TABLE: PUBLIC.TEST, TOTAL 1572864 RECORDS

```

- The following file is generated after executing gloder.

```

$ ll test.*
-rw-r--r-- 1 test test      71 2014-08-28 12:13 t1.ctl
-rw-r--r-- 1 test test 59930624 2014-08-28 12:49 t1.dat
-rw-r--r-- 1 test test     159 2014-08-28 12:49 t1.log

```

- Downloading in multiple files
 - The data in the table TEST is downloaded through gloder as follows.

```

$ gloder test test --export --control test.ctl --data test.dat --format binary --filesize
31461376
loaded 1000 records into PUBLIC.TEST
loaded 2000 records into PUBLIC.TEST

```

```
... Ellipsis ...
```

```
loaded 1571000 records into PUBLIC.TEST
```

```
loaded 1572000 records into PUBLIC.TEST
```

```
COMPLETED IN EXPORTING TABLE: PUBLIC.TEST, TOTAL 1572864 RECORDS
```

- The following file is generated after executing glloader.

```
$ ll test.*
```

```
-rw-r--r-- 1 test test      71 2014-08-28 12:13 test.ct1
```

```
-rw-r--r-- 1 test test 31461376 2014-08-28 13:02 test.dat
```

```
-rw-r--r-- 1 test test 28474880 2014-08-28 13:02 test.dat.001
```

```
-rw-r--r-- 1 test test     159 2014-08-28 12:49 test.log
```

Uploading Data

Uploading Text File

Simple Upload

The following is the table to be uploaded.

```
gSQL> \DESC TEST
COLUMN_NAME TYPE IS_NULLABLE
-----
I1 NUMBER(10,0) TRUE
I2 DATE TRUE
I3 TIME(6) WITH TIME ZONE TRUE
I4 TIMESTAMP(6) WITH TIME ZONE TRUE
gSQL> SELECT * FROM TEST;
no rows selected.
```

The following is the datafile to be uploaded.

```
$ cat test.dat
1,1999-12-31 00:00:00,01:01:01.000000 +09:00,1999-12-31 01:01:01.789000 -08:00
2,2000-01-01 00:00:00,23:12:12.000000 +09:00,2000-01-01 23:12:06.000000 +08:00
3,2000-12-31 00:00:00,23:12:12.000000 +09:00,2000-12-31 23:12:12.000000 -08:00
```

The datafile is uploaded with gloder and the result is output as follows.

```
$ gloder test test --import --control test.ctl --data test.dat
COMPLETED IN IMPORTING TABLE: PUBLIC.TEST, TOTAL 3 RECORDS, SUCCEEDED 3 RECORDS
$ gsql test test
gSQL> select * from test;
I1 I2 I3 I4
-----
1 1999-12-31 01:01:01.000000 +09:00 1999-12-31 01:01:01.789000 -08:00
2 2000-01-01 23:12:12.000000 +09:00 2000-01-01 23:12:06.000000 +08:00
3 2000-12-31 23:12:12.000000 +09:00 2000-12-31 23:12:12.000000 -08:00
3 rows selected.
```

Whitespace Character

The following is the table to be uploaded.

```
gSQL> \DESC TEST
COLUMN_NAME TYPE IS_NULLABLE
-----
I1 NUMBER(10,0) TRUE
I2 CHARACTER VARYING(10) TRUE
I3 BINARY VARYING(10) TRUE
gSQL> SELECT * FROM TEST;
no rows selected.
```

- The datafile downloaded without using `OPTIONALLY ENCLOSED BY` statement in the control file
 - The datafile is downloaded without using `OPTIONALLY ENCLOSED BY` statement in the control file as follows. (Refer to **Downloading in Text File**.)

```
$ cat test.dat
1, L K H ,10
2,KIM
MM,A0
3, KIM S
J ,CD
```

- The datafile is uploaded with gloder and the result is output as follows. Even though New Line ('\n') exists in the data of the second and third records, but a qualifier notifying the start and end of the column data is not set, so it is recognized as a row identifier.

```
$ gloder test test --import --control test.ctl --data test.dat
COMPLETED IN IMPORTING TABLE: PUBLIC.TEST, TOTAL 5 RECORDS, SUCCEEDED 3 RECORDS
$ gsql test test
gSQL> select * from test;
I1 I2 I3
-- ----
1 L K H 10
2 KIM null
3 KIM S null
3 rows selected.
```

- The datafile downloaded using `OPTIONALLY ENCLOSED BY` statement in the control file
 - The datafile is downloaded by using the `OPTIONALLY ENCLOSED BY` statement of the control file

as follows. (Refer to **Downloading in Text File**.) Differently from the result above, New Line ('\n') is treated as a part of data in the result below.

```
$ cat test.dat
"1"," L K H ","10"
"2","KIM
MM","A0"
"3"," KIM S
J ","CD"
```

- The datafile is uploaded with gloder and the result is output as follows.

```
$ gloder test test --import --control test.ctl --data test.dat
COMPLETED IN IMPORTING TABLE: PUBLIC.TEST, TOTAL 5 RECORDS, SUCCEEDED 3 RECORDS
$ gsql test test
gSQL> select * from test;
I1 I2      I3
-- ----- --
 1  L K H  10
 2  KIM    A0
   MM
 3  KIM S  CD
   J
3 rows selected.
```

Uploading Binary File

Simple Upload

The following is the structure of the table to be uploaded.

```
gSQL> \DESC TEST
COLUMN_NAME TYPE                IS_NULLABLE
-----
I1          NUMBER(10,0)                TRUE
I2          CHARACTER VARYING(10)     TRUE
I3          BINARY VARYING(10)       TRUE
gSQL> SELECT * FROM TEST;
no rows selected.
```

The following is the content of the control file written to download the table data.

```
$ cat test.ctl
TABLE PUBLIC.test
FIELDS TERMINATED BY ','
```

The following is a file to be uploaded with glloader. *test.dat* was already downloaded when **Downloading in Binary File**.

```
$ ls
test.dat
```

The datafile is uploaded to the table TEST and the result is output as follows.

```
$ glloader test test --import --control test.ctl --data test.dat --format binary
COMPLETED IN IMPORTING TABLE: PUBLIC.TEST, TOTAL 3 RECORDS, SUCCEEDED 3 RECORDS
$ gsql test test
gSQL> SELECT * FROM TEST;
I1 I2 I3
-- --- --
 1 LKH 10
 2 KMM A0
 3 ksj CD
3 rows selected.
```

Complex Upload

The following is the structure of the table to be uploaded.

```
gSQL> \DESC TEST
COLUMN_NAME TYPE IS_NULLABLE
-----
I1 NUMBER(10,0) TRUE
I2 CHARACTER VARYING(10) TRUE
I3 BINARY VARYING(10) TRUE
gSQL> SELECT * FROM TEST;
no rows selected.
```

The following is the datafile to be uploaded.

```
$ ll test.*
-rw-r--r-- 1 test test 71 2014-08-28 12:13 test.ctl
-rw-r--r-- 1 test test 31461376 2014-08-28 13:02 test.dat
-rw-r--r-- 1 test test 28474880 2014-08-28 13:02 test.dat.001
```

```
-rw-r--r-- 1 test test      159 2014-08-28 12:49 test.log
```

When uploading multiple downloaded files with `--filesize`, gloder should be separately performed for each datafile.

```
$ gloder test test --import --control test.ctl --data test.dat --format binary
COMPLETED IN IMPORTING TABLE: PUBLIC.TEST, TOTAL 860728 RECORDS, SUCCEEDED 2285000 RECORDS,
ERRORED 0 RECORDS
$ gloder test test --import --control test.ctl --data test.dat.001 --format binary
COMPLETED IN IMPORTING TABLE: PUBLIC.TEST, TOTAL 860728 RECORDS, SUCCEEDED 860728 RECORDS,
ERRORED 0 RECORDS
```

The upload result is as follows.

```
gSQL> select count(*) from test;
COUNT(*)
-----
3145728
1 row selected.
```

Controlling Upload Unit

The data can be uploaded faster by using the options which is related to performance. For more information, refer to `--array`, `--commit`, `--atomic`.

The following is the datafile with approximately 380,000 records.

```
$ ll test.dat
-rw-r--r-- 1 test test 75092480 2014-08-28 15:59 test.dat
```

The following is the control file which is used for uploading.

```
$ cat test.ctl
TABLE PUBLIC.test
FIELDS TERMINATED BY ','
OPTIONALLY ENCLOSED BY ''
LINES TERMINATED BY '\n'
```

Array Binding and Commit Cycle

The following gloder command uploads records to be bound in 5,000 unit and uploads records to be committed in 20,000 unit.

```
$ gloder test test --import --control test.ctl --data test.dat --array 5000 --commit 20000
loaded 5000 records into PUBLIC.TEST
loaded 10000 records into PUBLIC.TEST
loaded 15000 records into PUBLIC.TEST
... Ellipsis ...
loaded 3810000 records into PUBLIC.TEST
loaded 3815000 records into PUBLIC.TEST
loaded 3818244 records into PUBLIC.TEST
COMPLETED IN IMPORTING TABLE: PUBLIC.TEST, TOTAL 3818243 RECORDS, SUCCEEDED 3818243 RECORDS
```

The following is the result of executing gloder.

```
gSQL> SELECT I1, I2, I3 FROM TEST FETCH 3;
I1 I2 I3
-- -----
1 L K H 10
2 KIM A0
3 KIM S CD
3 rows selected.
gSQL> SELECT COUNT(*) FROM TEST;
COUNT(*)
-----
3818246
1 row selected.
```

Array Binding and Atomic Option

The following gloder commands uploads records to be bound in 5000 unit with atomic INSERT, and 1,000 records are failed.

```
$ gloder test test --import --control test.ctl --data test.dat --array 5000 --atomic
loaded 5000 records into PUBLIC.TEST
loaded 10000 records into PUBLIC.TEST
loaded 15000 records into PUBLIC.TEST
... Ellipsis ...
loaded 38175000 records into PUBLIC.TEST
COMPLETED IN IMPORTING TABLE: PUBLIC.TEST, TOTAL 3818243 RECORDS, SUCCEEDED 3817243 RECORDS
```

The following is the result of executing gloder.

```
gSQL> SELECT I1, I2, I3 FROM TEST FETCH 3;
I1 I2 I3
```

```

-----
1 L K H 10
2 KIM A0
3 KIM S CD
3 rows selected.
gSQL> SELECT COUNT(*) FROM TEST;
COUNT(*)
-----
3817243
1 row selected.

```

The following is the result for the cause of the upload failure and they are recorded in the log file. The upload is failed because the non-numeric data is stored in the first column of the first record.

```

$ cat test.log
Err Rec(1) Col(1): 22018(12006): data value is not a numeric literal
Err Rec(1) Col(-1): HY000(19041): Failed to atomic execution
Err Rec(1001) Col(1): 22018(12006): data value is not a numeric literal
Err Rec(1001) Col(-1): HY000(19041): Failed to atomic execution
COMPLETED IN IMPORTING TABLE: PUBLIC.TEST, TOTAL 3818243 RECORDS, SUCCEEDED 3817243 RECORDS [
Start Time: 2014-8-28 16:46:42 End Time: 2014-8-28 16:46:52 Taken Time: 10084582 micro-sec ]

```

The following is the result of the records which failed to upload and they are recorded in the bad file. 1000 records were stored because it is uploaded in 500 array units.

```

"s1", " L K H ", "10"
"2", "KIM", "A0"
"3", " KIM S J ", "CD"
... Ellipsis ...

```



Array, commit options do not affect the execution result, but success or failure of INSERT in the atomic operation is treated in an array unit, so if a record is failed to upload, all records in a unit to which the records belong are treated as INSERT failure.

The cause of the first failed records of the array is recorded in the log file and the causes for failed record later is not recorded.

Parallel Upload

gloder improves the performance of GOLDLOCKS by dividing the operation into parts and uploading them in thread unit. (Refer to **--parallel**.)

The following is the datafile with approximately 380,000 records.

```
$ ll test.dat
-rw-r--r-- 1 test test 75092480 2014-08-28 15:59 test.dat
```

The following is the control file which is used for uploading.

```
$ cat test.ctl
TABLE PUBLIC.test
FIELDS TERMINATED BY ','
OPTIONALLY ENCLOSED BY ''
LINES TERMINATED BY '\n'
```

The following gloder commands uploads records which is bound to a thread performing four uploads. It is uploaded in 5000 unit with INSERT, and 100 records are failed.

```
$ gloder test test --import --control test.ctl --data test.dat --array 5000 --parallel 4
loaded 5000 records into PUBLIC.TEST
loaded 10000 records into PUBLIC.TEST
loaded 15000 records into PUBLIC.TEST
... Ellipsis ...
loaded 3810000 records into PUBLIC.TEST
loaded 3815000 records into PUBLIC.TEST
COMPLETED IN IMPORTING TABLE: PUBLIC.TEST, TOTAL 3818243 RECORDS, SUCCEEDED 3818143 RECORDS
```

The following is the result of executing gloder.

```
gSQL> SELECT I1, I2, I3 FROM TEST FETCH 3;
I1 I2 I3
-- ----- --
1 L K H 10
2 KIM A0
3 KIM S CD
3 rows selected.
gSQL> SELECT COUNT(*) FROM TEST;
COUNT(*)
-----
3818143
1 row selected.
```

The cause of failure during the upload is recorded in the log file as follows.

```
$ cat test.log
Err Rec(1) Col(1): 22018(12006): data value is not a numeric literal
Err Rec(3) Col(1): 22018(12006): data value is not a numeric literal
Err Rec(5) Col(1): 22018(12006): data value is not a numeric literal
... Ellipsis ...
Err Rec(1001) Col(1): 22018(12006): data value is not a numeric literal
... Ellipsis ...
COMPLETED IN IMPORTING TABLE: PUBLIC.TEST, TOTAL 3818243 RECORDS, SUCCEEDED 3818143 RECORDS [
Start Time: 2014-8-28 16:46:42 End Time: 2014-8-28 16:46:52 Taken Time: 10084582 micro-sec ]
```

The following is a result of failed records recorded on the bad file during the upload. 100 records are stored.

```
"s1", " L K H ", "10"
"s2", "KIM", "A0"
"s3", " KIM S J ", "CD"
... Ellipsis ...
```



When uploading the data with multiple threads, the records in which errors occur after INSERT are stored in the log file and bad file. In this case, the order of records may not be as same as the order in the data files.

Troubleshooting for Uploading

The record upload failure may occur by various causes. The failed record is stored in the bad file, and the information about the cause of failure is stored in the log file.

Failure due to Duplicate Constraint

The duplicate data is already in the constrained table to be uploaded. (primary key or unique index)

The following is the structure of the table to be uploaded.

```
gSQL>\desc T1
COLUMN_NAME  TYPE                IS_NULLABLE
-----
I1            NUMBER(10,0)        TRUE
I2            CHARACTER VARYING(10) TRUE
I3            BINARY VARYING(10)  TRUE
gSQL> SELECT * FROM T1;
I1 I2  I3
-- -- --
 1 LKH 10
 2 KMM A0
 3 ksj CD
3 rows selected.
```

The following is the datafile to be uploaded.

```
$ cat t1.dat
"1","LKH"
"4","SOS"
"5","OKO"
```

The followings are the upload result by using gloder, and the created log file and bad file. The upload is failed because the record violated a primary key constraint.

```
$ gloder test test -i -c t1.ct1 -d t1.dat
COMPLETED IN IMPORTING TABLE: PUBLIC.T1, TOTAL 3 RECORDS, SUCCEEDED 2 RECORDS
$
$ cat t1.log
```

```

Err Rec(1) Col(-1): 40002(16057): unique constraint (PUBLIC.T1_PRIMARY_KEY) violated
COMPLETED IN IMPORTING TABLE: PUBLIC.T1, TOTAL 3 RECORDS, SUCCEEDED 2 RECORDS [ Start Time:
2014-8-26 16:19:51 End Time: 2014-8-26 16:19:51 Taken Time: 15455 micro-sec ]
$
$ cat t1.bad
"1","LKH"

```

Failure due to Date/time Format

The format can be set for the data type such as DATE, TIME, TIME WITH TIME ZONE, TIMESTAMP, TIMESTAMP WITH TIME ZONE, and it may cause the failure of upload using gloder.

The following is the table to be uploaded.

```

gSQL> \DESC T1
COLUMN_NAME TYPE IS_NULLABLE
-----
I1 NUMBER(10,0) TRUE
I2 TIMESTAMP(6) WITH TIME ZONE TRUE
gSQL> SELECT * FROM T1;
no rows selected.

```

The format of the TIMESTAMP WITH TIME ZONE on the server is as follows.

```

gSQL> SELECT PROPERTY_VALUE, INIT_VALUE FROM V$PROPERTY WHERE PROPERTY_NAME LIKE
'NLS_TIMESTAMP_WITH_TIME_ZONE_FORMAT';
PROPERTY_VALUE          INIT_VALUE
-----
YYYY-MM-DD HH24:MI:SS.FF6 TZH:TZM YYYY-MM-DD HH24:MI:SS.FF6 TZH:TZM

```

The following is the datafile to be uploaded.

```

$ cat t1.dat
"4","20000108 00:00:00"
"5","20000108 04:05:06"
"6","20000108 04:05:06"

```

The following is the result of executing upload by using gloder.

```

$ gloder test test -i -c t1ctl -d t1.dat

COMPLETED IN IMPORTING TABLE: PUBLIC.T1, TOTAL 3 RECORDS, SUCCEEDED 0 RECORDS

```

The cause and records of upload failure are stored in the log file and the bad file as follows.

```
$ cat t1.log
Err Rec(1) Col(2): HY000(12136): literal does not match format string
Err Rec(2) Col(2): HY000(12136): literal does not match format string
Err Rec(3) Col(2): HY000(12136): literal does not match format string
COMPLETED IN IMPORTING TABLE: PUBLIC.T1, TOTAL 3 RECORDS, SUCCEEDED 0 RECORDS [ Start Time:
2014-8-27 13:56:29 End Time: 2014-8-27 13:56:29 Taken Time: 20670 micro-sec ]
$ cat t1.bad
"4","20000108 00:00:00"
"5","20000108 04:05:06"
"6","20000108 04:05:06"
```

Troubleshooting

The problem occurs when the data type format of the datafile and that of the data used on the server are different. The data type format of the datafile should be set to solve the problem. In this case, `.odbc.ini` is used.

The data type format is set in `.odbc.ini` file as follows.

```
$ cat .odbc.ini
[GOLDILOCKS]
HOST = 127.0.0.1
PORT = 21123
DATE_FORMAT = SYYYYMMDD
TIME_FORMAT = HH24MISS
TIME_WITH_TIME_ZONE_FORMAT = HH24MISS TZHTZM
TIMESTAMP_FORMAT = SYYYYMMDD HHMISS
TIMESTAMP_WITH_TIME_ZONE_FORMAT = SYYYYMMDD HH:MI:SS
```

The following is the result of setting `.odbc.ini` and performing gloder again.

```
$ gloder test test -i -c t1ctl -d t1.dat
COMPLETED IN IMPORTING TABLE: PUBLIC.T1, TOTAL 3 RECORDS, SUCCEEDED 3 RECORDS
```



- The data type format set in `.odbc.ini` is applied to the entire column, and it can not be separately set.
- If the data type format is set in `.odbc.ini`, it is also applied when downloading to gloder.

Failure Due to Lack of Capacity

gloder is performed and failed as follows.

```
$ gloder test test -i -c t1ctl -d t2.dat
loaded 4000 records into PUBLIC.T1
COMPLETED IN IMPORTING TABLE: PUBLIC.T1, TOTAL 4200 RECORDS, SUCCEEDED 0 RECORDS
```

It is failed due to lack of the space for datafile in the tablespace.

```
$ cat t1.log
Err Rec(1) Col(-1): HY000(14015): there is no extendible datafile in tablespace 'MEM_DATA_TBS'
Err Rec(2) Col(-1): HY000(14015): there is no extendible datafile in tablespace 'MEM_DATA_TBS'
... Ellipsis ...
COMPLETED IN IMPORTING TABLE: PUBLIC.T1, TOTAL 4200 RECORDS, SUCCEEDED 0 RECORDS [ Start Time:
2014-8-27 15:7:28 End Time: 2014-8-27 15:7:29 Taken Time: 317885 micro-sec ]
```

Troubleshooting

The datafile of a tablespace should be extended or added to solve the problem.

For more information, refer to **ALTER TABLESPACE**.

Datafile Analysis Failure

The field terminator, the qualifier, and the line terminator described in the control file may be different in the text datafile because of misuse.

The following is the structure of the table object to be uploaded.

```
gSQL>\desc T1
COLUMN_NAME TYPE IS_NULLABLE
-----
I1 NUMBER(10,0) TRUE
I2 CHARACTER VARYING(10) TRUE
I3 BINARY VARYING(10) TRUE
```

The following is the control file to be uploaded.

```
$ cat t1ctl
TABLE T1
FIELDS TERMINATED BY ','
OPTIONALLY ENCLOSED BY ''
LINES TERMINATED BY '\n'
```

The following is the datafile to be uploaded.

```
$ cat t1.dat
'1',"LKH","aa"
"2","SOS","aa"
"5","OKO","00"
```

The following is the result of executing upload by using gloder.

```
$ gloder test test --import --control t1.ct1 --data t1.dat
COMPLETED IN IMPORTING TABLE: PUBLIC.T1, TOTAL 3 RECORDS, SUCCEEDED 1 RECORDS
```

The cause and records of upload failure are as follows.

```
$ cat t1.log
Err Rec(1) Col(1): 22018(12006): data value is not a numeric literal
COMPLETED IN IMPORTING TABLE: PUBLIC.TEST, TOTAL 3 RECORDS, SUCCEEDED 1 RECORDS [ Start Time:
2014-8-28 18:6:13 End Time: 2014-8-28 18:6:13 Taken Time: 18679 micro-sec ]
$
$ cat t1.bad
"2","SOS","aa"
'1',"LKH","aa"
```

Troubleshooting

The records fail to analyze the data due to qualifier or delimiter which are used improperly. Therefore, to solve this problem, the field terminator, the qualifier and the delimiter in the control file and the datafile should be checked, then the datafile should be edited based on the records of the bad file.



The records which are failed to parse in the data analysis process are stored in the bad file, not in the log file.

Uploading to Another Database Whose Character Set Is Different

Adjusting the column size may be required when downloading/ uploading data in binary type between databases whose character sets are different one another.

The following is the structure of the table object to be uploaded.

```
gSQL>\desc T1
COLUMN_NAME TYPE IS_NULLABLE
-----
```

```
I1          NUMBER(10,0)          TRUE
I2          CHARACTER VARYING(36) TRUE
```

The following is the table data, and it is a VARCHAR type, its size is 36 and is completely filled.

```
SELECT * FROM T1;
I1    I2
-----
1    1 일이삼사오육칠팔구십일이삼사오육칠팔
```

The following error occurs when downloading data above from UHC database then uploading to UTF8 database which has the same schema.

```
$ gloder test test -i -f binary -T T1 -d t1.dup
ERR-HY000(42023): byte length of data greater than column length.
ERROR: FAILED TO IMPORT TABLE PUBLIC.T1
```

Troubleshooting

The data upload succeeds when adjusting the length of column I2 as follows. Declare I2 as VARCHAR(18 CHAR), or declare I2 as VARCHAR(54) size.

```
gSQL>\desc T1
COLUMN_NAME TYPE                                IS_NULLABLE
-----
I1          NUMBER(10,0)                                TRUE
I2          CHARACTER VARYING(18 CHAR) TRUE
```

```
gSQL>\desc T1
COLUMN_NAME TYPE                                IS_NULLABLE
-----
I1          NUMBER(10,0)                                TRUE
I2          CHARACTER VARYING(54) TRUE
```

35.3 Control File Syntax

```
TABLE [schema_name.]table_name[domain_name.]
FIELDS TERMINATED BY 'Field Terminator'
[OPTIONALLY ENCLOSED BY 'Open Qualifier' [AND 'Close Qualifier']]
[LINES TERMINATED BY 'Line Terminator']
[Character set character set_name]
[RTRIM [ON|OFF]]
[LTRIM [ON|OFF]]
[WHERE="conditional statement"]
```



A control file describes only one table. Therefore, each item above should be described in the control file only once, and if it is described duplicately, then the control parsing error occurs.

CHARACTERSET

Syntax

```
CHARACTERSET character set_name
```

Description

It refers to the character set of the datafile to be downloaded or uploaded.

If the character set is not specified, the UTF8 which is the default character set of CHARACTER_SET in GO LDILOCKS property is used.

Example

The following is an example of which the character set of the datafile to be uploaded or downloaded is the ASCII code.

```
% cat sample.ctl
CHARACTERSET ASCII
```

TABLE

Syntax

```
TABLE table_name
TABLE schema_name.table_name
TABLE table_name@domain_name
TABLE schema_name.table_name@domain_name
```

Description

It specifies the name of table to which upload or download the data, or specifies the schema name to which the table belongs, or the domain name.

The domain name can be used only for data download, and it downloads only the data of the corresponding member.

The string or double-quoted (") string is used in the table name.

If the table name is given as the command row argument in gloder as well, then the value of the command row argument takes precedence over the value in the control file.

Examples

The following is an example of specifying only the table name.

```
% cat sample.ctl
TABLE lineitem
```

The following is an example of specifying the schema PUBLIC and the table name. It has the same meaning as the example above.

```
% cat sample.ctl
TABLE PUBLIC.lineitem
```

The following is an example of specifying the schema PUBLIC and the table name of G1N1 member. It has the same meaning as the example above.

```
% cat sample.ctl
TABLE PUBLIC.lineitem@G1N1
```

The following is an example of specifying the table name created by the delimited identifier.

```
gSQL> CREATE TABLE "Tab*&^" ( id INTEGER );
```

```
% cat sample.ctl  
TABLE "Tab*&^"
```

FIELDS TERMINATED BY

Syntax

```
FIELDS TERMINATED BY 'Field Terminator'
```

Description

The field terminator is used as a delimiter between columns in the record data of the data file. Setting the field terminator in the control file can not be omitted.

The field terminator can be set with one or more strings, and should not be duplicate with a qualifier or line terminator, and it should not use the subset string.

There is not any constraint for the string to be set as a field terminator. However, \ or % should be added to in front of each n, t, r when setting NEW LINE or TAB, CARRIAGE RETURN character.

If the field terminator is given as the command row argument in gloder as well, then the value of the command row argument takes precedence over the value in the control file.

Example

The following is an example of setting the field terminator as COMMA and NEW LINE.

```
% cat sample.ctl  
FIELDS TERMINATED BY ',\n'
```

```
% cat sample.ctl  
FIELDS TERMINATED BY ',%n'
```

OPTIONALLY ENCLOSED BY

Syntax

OPTIONALLY ENCLOSED BY 'Open Qualifier' [AND 'Close Qualifier']

Description

Qualifier is used as a delimiter to represent the start and end of the column.

Qualifier is a single character, and the first qualifier is an open qualifier, the last qualifier is a close qualifier. The same characters can be used to set a open qualifier and a close qualifier, or the different characters can be used to represent the start and end of the column.

Characters set as a qualifier can not be used in a field terminator nor in a line terminator.

If a close qualifier literally belongs to a column data, two close qualifiers are used to represent a single valid data.

If an open qualifier is set omitting a close qualifier, then characters as same as those in an open qualifier is set in a close qualifier.

If OPTIONALLY ENCLOSED BY statement does not exist, the column data is distinguished by the field terminator.

If the qualifier is given as the command row argument in gloder as well, then the value of the command row argument takes precedence over the value in the control file.



If OPTIONALLY ENCLOSED BY statement does not exist, the results of the uploading and downloading data may be different. (Refer to **Troubleshooting Uploading.**)

Example

The following is an example of using double quotes (") and a single quote (') as a open qualifier and a close qualifier each.

```
% cat samplectl  
OPTIONALLY ENCLOSED BY ''' AND '''
```

LINES TERMINATED BY

Syntax

LINES TERMINATED BY 'Line Terminator'

The line terminator is used as a delimiter between records in the data file.

The line terminator can be set with one or more strings, and should not be duplicate with a qualifier or a field terminator, and it should not use the subset string.

When omitting the line terminator setting, then NEW LINE ('\n' or '%n') is used by default.

If the line terminator is given as the command row argument in gloder as well, then the value of the command row argument takes precedence over the value in the control file.

Description



- Differently from Unix, CARRIAGE RETURN and NEW LINE are written together instead of a single NEW LINE in the data file exported from Windows OS. When importing data by using this data file, LINES TERMINATED BY in the control file should be explicitly set like as '\r\n' so that the data is normally imported.
- It is recommended to set a field terminator and a line terminator with a different string each. The more mutual string including the first character exist the poorer the import performance due to the internal comparing. In other words, when a field terminator and a line terminator are set with different strings each, then the shorter the string the better the performance.

Example

The following is an example of using '^t\r\n' as a line terminator

```
% cat sample.ctl
LINES TERMINATED BY '^t\r\n'
```

LTRIM

Syntax

```
LTRIM ON|OFF
```

Description

It determines a left trim.

The default value is OFF, and when it is set to OFF, then the left WHITESPACE is considered data.

When it is set to ON, then the left WHITESPACE is ignored.



OPTIONALLY ENCLOSED BY is applied only when the syntax does not exist.

If OPTIONALLY ENCLOSED BY is used and the column is enclosed with delimiters in the data file, then RTRIM and LTRIM is OFF.

Example

The following is an example of setting LTRIM to ON.

```
% cat sample.txt  
LTRIM ON
```

RTRIM

Syntax

```
RTRIM ON|OFF
```

Description

It determines a right trim.

The default value is OFF, and when it is set to OFF, then the right WHITESPACE is considered data.

When it is set to ON, then the right WHITESPACE is ignored.



OPTIONALLY ENCLOSED BY is applied only when the syntax does not exist.

If OPTIONALLY ENCLOSED BY is used and the column is enclosed with delimiters in the data file, then RTRIM and LTRIM is OFF.

Example

The following is an example of setting RTRIM to ON.

```
% cat sample.ctl  
RTRIM ON
```

WHERE

Syntax

```
WHERE="conditional_statement"
```

Description

It uses a conditional clause when downloading data.

Example

The following is an example of using WHERE.

```
% cat sample.ctl  
WHERE="I2 > 3"
```

35.4 gloder Argument References

Usage

```
$ gloder --help
```

Usage

```
gloder user password mode data [control] [format] [options]
```

```
user          user name
```

```
password      password
```

mode: gloder's mode.

```
--export      export data
```

```
--import      import data
```

data:

```
--data        data file
```

options:

```
--control     control file
```

```
--format      file format(text|binary, Default text)
```

```
--log         log file
```

```
--bad         bad file
```

```
--dsn        dsn string
```

```
--array       number of rows in bind array(Default 1000)
```

```
--filesize    max file size
```

```
--commit     number of commit unit(Default 5000)
```

```
--comment    commenting on commit
```

```
--atomic     use atomic function
```

```
--parallel   use parallel in import
```

```
--propagation enabling or disabling a redo log propagation(ON|OFF)
```

```
--errors     number of error count to allow(Default 100)
```

```
--AsTIMESTAMP bind DATE as TIMESTAMP
```

```
--buffered   buffered disk io(Default direct io)
```

```
--tablename  [schema_name.]table_name[@domain_name]
```

```
--fieldterm  field terminator
```

```
--lineterm   line terminator
```

```
--qualifier  qualifier(column data encloser)
```

```
--where      export only rows selected by given WHERE condition
```

```
--group-id   importing distributed data by group id using global connections in a
```

clustered environment

```
--directio-size direct io size(Default 512)
```

<code>--no-copyright</code>	suppresses the display of the banner
<code>--silent</code>	suppresses the display of the result message
<code>--help</code>	print help message

Mandatory Argument

The arguments are entered in an order of username and password to connect to the database. gloader operation mode, control file, datafile are entered as arguments.

Argument	Description
user_name	It is the user name. The maximum length of user name is 128.
password	It is password. The maximum length of password is 128.

--export

Description

It specifies for gloader to download the data in the database.

Example

```
$ gloader test test --export -c sample.ctl -d sample.dat
```

--import

Description

It specifies for gloader to upload the data in the database.

Example

```
$ gloader test test --import -c sample.ctl -d sample.dat
```

--control

Description

It specifies the control file path.

If `--tablename` is given as an argument, the control file can be omitted. The table name is mandatory to e

execute gloder, so the table name should be given via a control file or an argument. If the table name is not given as an argument, TABLE item should be set via a control file.

When a control file is omitted, a field terminator, a qualifier, a line terminator can be given as an argument. If these delimiters are not given as an argument, then delimiters in CSV form is used by default.

Example

The following is an example of using a control file whose name is sample.ctl.

```
$ gloder test test -i --control sample.ctl -d sample.dat
```

--data

Description

It specifies the data file path to download or upload.

Example

The following is an example of uploading a control file whose name is sample.dat.

```
$ gloder test test -i -c sample.ctl --data sample.dat
```

Optional Argument

--tablename

Description

It specifies the table name in [Schemaname.]Tablename[@domain_name] form.

The table name should be given via setting TABLE of an argument or a control file. In other words, if a control file is omitted, the table name argument is mandatory.

If a tablename argument is given when TABLE item of a control file is set, then argument value takes precedence over the value in the control file.

Example

The following is an example of uploading data in CSV form by giving a tablename argument because the control file argument is omitted

```
$ gloader test test -i --tablename PUBLIC.T1 --data sample.dat
```

The following is an argument of omitting a tablename argument because TABLE item is omitted in the control file.

```
$ cat sample.ctl | grep TABLE
TABLE T1
$ gloader test test -i -c sample.ctl --data sample.dat
```

--format

Description

It specifies the datafile format.

The datafile format may be text or binary, and the default value is text when the format is not set.

Example

The following is an example of downloading the data to sample.dat in binary form.

```
$ gloader test test --export --control sample.ctl --data sample.dat --format binary
```

The followings are sample.dat and sample.log which are created after executing gloader as above.

```
$ ls
sample.ctl sample.dat sample.log
```

--log

Description

It specifies the logfile path.

gloader records the error and results occurred during the execution.

If the file name is not specified, the name is created as same as the datafile by changing its extension to log.

Example

The following is an example of when the name of the log file is specified by using --log option.

```
$ gloder test test --export --control sample.ct1 --data sample.dat --log SAMPLE.log
```

The followings are sample.dat, SAMPLE.log which are created after executing gloder as above.

```
$ ls  
sample.ct1 sample.dat SAMPLE.log
```

The following is an example of when the name of the log file is not specified by using --log option.

```
$ gloder test test --export --control sample.ct1 --data sample.dat
```

The followings are sample.dat, sample.log which are created after executing gloder as above.

```
$ ls  
sample.ct1 sample.dat sample.log
```

--bad

Description

It specifies the bad file path.

It is valid only when gloder performs the import operation. Rows which can not be uploaded due to an error are stored in the bad file.

If the file name is not specified, the name is created as same as the datafile by changing its extension to bad.

Example

The following is an example of when the name of the bad file is specified by using --bad option.

```
$ gloder test test --import --control sample.ct1 --data sample.dat --bad SAMPLE.bad
```

The followings are sample.dat, sample.log, SAMPLE.bad which are created after executing gloder as above.

```
$ ls  
SAMPLE.bad sample.ct1 sample.dat sample.log
```

The following is an example of when the name of the bad file is not specified by using --bad option.

```
$ gloder test test --export --control sample.ct1 --data sample.dat
```

The followings are sample.dat, sample.log, sample.bad which are created after executing gloder as above.

e.

```
$ ls
sample.bad sample.ctl sample.dat sample.log
```

--dsn

Description

It is the dsn string. The maximum length is 128.

It is used to specify the format of the time-related data type represented in the data file to be downloaded or uploaded.

It is used to specify the server when using gloadernet in the Client/ Server (C/S) environment.

For more information, refer to **odbc.ini File**.

Example

The following is an example of .odbc.ini described to use --dsn option.

```
$ cat .odbc.ini
[GOLDILOCKS]
HOST = 127.0.0.1
PORT = 21123
DATE_FORMAT = SYYYYMMDD
TIME_FORMAT = HH24MISS
TIME_WITH_TIME_ZONE_FORMAT = HH24MISS TZHTZM
TIMESTAMP_FORMAT = SYYYYMMDD HHMISS
TIMESTAMP_WITH_TIME_ZONE_FORMAT = SYYYYMMDD HH:MI:SS
```

The following is an example of uploading the data to the goldilocks server by using --dsn option.

```
$ gloadernet test test --dsn goldilocks --import --control sample.ctl --data sample.dat
```

The following is an example of defining the format of time-related data type of the data file by using --dsn option, and then downloading data.

```
$ gloader test test --dsn goldilocks --export --control sample.ctl --data sample.dat
```

For more information, refer to **Failure due to date/time format**.

--array

Description

It specifies the number of rows to be bound when importing the data.

The amount of memory is required in proportion to the number of array. If not specified, 1,000 rows are used.

The option is applied only when uploading the data.

Example

The following is an example of uploading the data file in 2,000 records unit.

```
$ gloder test test --import --control sample.ctl --data sample.dat --array 2000
```

--filesize

Description

The maximum size of the file can be set when gloder downloads the data. If the amount of data exceeds the maximum size, the file is generated by adding the permutation number to the file extension.

If not specified, the maximum file size is unlimited, and the minimum is 31,461,376 (30 Mbytes).

The option is valid only for the binary type data file.

Example

The following is an example of executing the commands, then the file size exceeds the specified maximum, so new files are generated as results.

```
$ gloder test test --export --control sample.ctl --data sample.dat --filesize 31461376
```

```
$ls -al  
-rw-r--r-- 1 test test 31461376 sample.dat  
-rw-r--r-- 1 test test 31461376 sample.dat.001  
-rw-r--r-- 1 test test 6715392 sample.dat.002
```

--commit

Description

While gloader uploads the data, the transaction is in the no commit state. The commit cycle may be set by using `--commit` option.

If not set, the default value is 5,000 (rows).

Example

The following is an example of using `--commit` option.

```
$ gloader test test --import --control sample.ctl --data sample.dat --commit 10000
```

--comment

Description

When gloader commits the transaction, it specifies the comment on the transaction.

Example

The following is an example of using `--comment` option.

```
$ gloader test test --import --control sample.ctl --data sample.dat --comment import_sample
```

--atomic

Description

It is the option for performing array INSERT, and it is useful when uploading the data.

The performance is faster than the existing array insert, because atomic array INSERT processes the insert statements as many as the size of array in a single transaction.

Example

The following is an example of using `--atomic` option.

```
$ gloader test test --import --control sample.ctl --data sample.dat --array 1000 --atomic
```

--parallel

Description

It specifies the number of threads for parallel processing.

It is useful only when gloader uploads the data, and the performance gets faster when the number of thr

eads is increased by adjusting `--parallel` option.

The performance gets faster by increasing the number of threads, but it is recommended to set the number of threads according to the operational environment.

The default value is 1, and the maximum value is 32.

Example

The following is an example of using eight threads when uploading data. Ten threads are operated together including threads analyzing the data files and read only threads, besides the eight uploading threads.

```
$ gloder test test --import --control sample.ctl --data sample.dat --parallel 8
```

--propagation

Description

It determines whether to propagate the upload transaction log to another replicated server. It can be set to ON or OFF.

Example

The following is an example of which the upload transaction log is not propagated to another replicated server.

```
$ gloder test test --import --control sample.ctl --data sample.dat --propagation off
```

--errors

Description

It sets the number of errors permitted when gloder uploads the data.

If not set, 100 (rows) are used. If it is set to 0, the `--errors` option is ignored.

If it is smaller than the size of `--array` option, the number of permitted error is the number of array.

Example

The following is an example of using `--errors` option.

```
$ gloder test test --import --control sample.ctl --data sample.dat --errors 10000
```

--AsTIMESTAMP

Description

It sets the DATE type data stored in TIMESTAMP format to be operated in TIMESTAMP format for backward compatibility.

TIMESTAMP_FORMAT is also applied to the DATE type data when using the --AsTIMESTAMP option.

Example

The following is an example of using --AsTIMESTAMP option.

```
$ gloader test test --import --control sample.ctl --data sample.dat --AsTIMESTAMP
```

--buffered

Description

Only the datafile uses the buffered IO instead of the direct IO.

The log file and bad file use the buffered IO.

Example

The following is an example of using --buffered option.

```
$ gloader test test --import --control sample.ctl --data sample.dat --buffered
```

--fieldterm

Description

It provides a field terminator.

If it is set in a control file as well, then the fieldterm argument value is preferentially used.

% is added in front of n, r, t each for NEW LINE, CARRIAGE RETURN, TAB.

Characters which is used as a shell meta character such as ', ", \$, & is not recommended to use.

Example

The following is an example of using --fieldterm option.

```
$ gloader test test --i -c sample.ctl -d sample.dat --fieldterm " , , "
$ gloader test test --i -c sample.ctl -d sample.dat --fieldterm , ,
```

```
$ gloder test test --i -c sample.ctl -d sample.dat --fieldterm ',,,'
```

--lineterm

Description

It provides a line terminator.

If it is set in a control file as well, then the lineterm argument value is preferentially used.

The detailed usage is as same as that of the fieldterm argument.

Example

The following is an example of using --lineterm option.

```
$ gloder test test --i -T PUBLIC.test -d sample.dat --lineterm ",,, "  
$ gloder test test --i -T PUBLIC.test -d sample.dat --lineterm ,,,  
$ gloder test test --i -T PUBLIC.test -d sample.dat --lineterm ',,,'
```

--qualifier

Description

It provides a qualifier which is to be added to the start and the end of the column data. Only a single character can be set as a qualifier.

If it is set in a control file as well, then the qualifier argument value is preferentially used.

The detailed usage is as same as that of the fieldterm argument.

Example

The following is an example of using --qualifier option.

```
$ gloder test test --i -T PUBLIC.test -d sample.dat --qualifier "|"  
$ gloder test test --i -T PUBLIC.test -d sample.dat --qualifier ''
```

--where

Description

It downloads the data by setting a conditional clause for export operation.

If the where clause is also set in a control file, then the where argument value is preferentially used.

Example

The following is an example of using `--where` option.

```
$ gloader test test --i -T PUBLIC.test -d sample.dat --where "I2 > 4"
```

--group-id

Description

It uploads the data in the sharded table only by group in the cluster environment.

If this option is used when uploading the data to the non-sharded table, the option is not valid.

This option is operated only in C/S environment, so it is valid only in gloadernet and it can be used only when uploading text files.

`--group-id` option uses **GLOBAL CONNECTION** of ODBC, so properties related to the **Data Source Configuration** should be set.

Example

The following is odbc.ini configuration file to use the global connection.

```
$cat .odbc.ini
[GOLDILOCKS]
HOST=127.0.0.1
PORT = 22581
LOCALITY_AWARE_TRANSACTION=1
LOCATOR_DSN = LOCATOR
[LOCATOR]
LOCATOR_FILE=.locator.ini
```

The following is an example of using `--group-id` option in gloadernet.

```
$ gloadernet test test --i -T PUBLIC.test -d sample.dat --group-id
COMPLETED IN IMPORTING TABLE: PUBLIC.TEST, TOTAL 20 RECORDS, SUCCEEDED 20 RECORDS
```

The following is an example of an error which occurred due to using `--group-id` option in gloader.

```
$ gloader test test --i -T PUBLIC.test -d sample.dat --group-id
ERR-HY010(19009): Function sequence error : The function should be called only when the
SQL_ATTR_LOCALITY_AWARE_TRANSACTION connection attribute is set.
```

--directio-size

Description

gloder uses direct IO by default. The default value of direct IO is 512, but this size can be modified by using `--directio-size`. The value for the size should be the value of 2 powers of 512.

Example

The following is an example of modifying the direct IO size in gloder.

```
$ gloder test test --i -T PUBLIC.test -d sample.dat --directio-size 1024
```

--no-copyright

Description

It does not output the copyright and version.

Example

The following is the result of executing gloder with `--no-copyright` option.

```
$ gloder test test --import --control sample.ctl --data sample.dat --no-copyright  
COMPLETED IN EXPORTING TABLE: PUBLIC.t1, 3 RECORDS  
$
```

--silent

Description

It does not output the results of executing gloder.

Example

The following is the result of executing gloder with `--silent` option.

```
$ gloder test test --import --control sample.ctl --data sample.dat --silent  
$
```

--help

Description

It displays the help messages.

For more information, refer to **Usage**.

36.

gdump

36.1 Overview of gdump

Definition

gdump is a utility provided by GOLDILOCKS, and it dumps the following binary files managed by the data base in text form.

- Control file
- Datafile
- Log file
- Incremental backup file
- Property file
- Commit log file
- Log buffer file
- Pending log buffer file

Argument

gdump usage is divided into the mandatory argument and the optional argument, and the optional arguments are used differently according to the file types to be dumped.

```
gdump file_type file_name [options]
```

Mandatory Argument

The mandatory argument is used in an order of the file type and and the file path.

```
file_type: CONTROL | LOG | DATA | PROPERTY | BACKUP | COMMIT_LOG | LOG_BUFFER | PEND_BUFFER  
file_name: file name to dump
```

file_type Argument

- CONTROL: It is a control file. It is located in $\langle \text{GOLDILOCKS_DATA} \rangle / wal$, and its file extension is *.ctl*.
- Log: It is a log file(Online/Archived redo log file). It is located in $\langle \text{GOLDILOCKS_DATA} \rangle / wal$ or in $\langle \text{GOLDILOCKS_DATA} \rangle / archive_log$, and its file extension is *.log*.
- DATA: It is a datafile. It is located in $\langle \text{GOLDILOCKS_DATA} \rangle / db$, and its file extension is *.dbf*.
- PROPERTY: It is a binary property file. It is located in $\langle \text{GOLDILOCKS_DATA} \rangle / conf$, and the default file name is *goldilocks.properties.binary*.

- **BACKUP:** It is an incremental backup file. It is located in `<GOLDILOCKS_DATA>/backup`, and its file extension is `.inc`.
- **COMMIT_LOG:** It is a `commit.log` file located in `<GOLDILOCKS_DATA>/wal`.
- **LOG_BUFFER:** It is a file of which a log buffer located in the memory is stored. The log buffer is stored in a file by executing `gsyncher`.
- **PEND_BUFFER:** It is a file of which a pending log buffer located in the memory is stored. The pending log buffer is stored in a file by executing `gsyncher`.



An attempt to the dump of broken control file fails.

Optional Argument

```

-S --silent                                silent
file_type = CONTROL
  -s, --section sys | log | db | backup | all  dump controlfile section(default all)
file_type = DATA
  -h, --header                                dump datafile header
  -n, --number INTEGER ( >= 0 )              (log or page) sequence number
  -f, --fetch  INTEGER ( >= 1 )              dump as much as count
file_type = LOG
  -h, --header                                dump datafile header
  -n, --number INTEGER ( >= 0 )              (log or page) sequence number
  -o, --offset INTEGER                        offset of lsn(usable if set lsn)
  -f, --fetch  INTEGER ( >= 1 )              dump as much as count
  -a, --all
file_type = BACKUP
  -b, --body  header | all                    dump incremental body(default all)
  -t, --tbs   dump specific tablespace body(usage if set body)
  -n, --number INTEGER ( >= 0 )              (log or page) sequence number
  -f, --fetch  INTEGER ( >= 1 )              dump as much as count

```

Description

Name	Available file type	Description
<code>--silent</code>	All	It does not output copyright, version, the execution time.
<code>--section</code>	Control file	It refers to the section of control file to be dumped. <ul style="list-style-type: none"> • <code>sys</code>: System section • <code>log</code>: Log section • <code>db</code>: Database section

Name	Available file type	Description
		<ul style="list-style-type: none"> • backup: Incremental backup section • all: All sections (The default value)
--header	Datafile	It dumps only the header of the datafile. If not set, it does not display the header.
	Log file	It dumps only the header of the log file.
--number	Datafile	It is a page number to be dumped. (The default value is 0.)
	Log file	It is a log number to be dumped. (The default value is 0, and it dumps the log bigger than the specified number.)
	Incremental backup file	It is a page number to be dumped. (The default value is 0, and it dumps the page bigger than the specified number.)
--fetch	Datafile	It is a number of pages to be dumped. (The default value is 1.)
	Log file	It is a number of logs to be dumped. (The default value is the whole logs.)
	Incremental backup file	It is a number of pages to be dumped. (The default value is the whole pages.)
--offset	Log file	It is valid only when --number option argument is set, and it refers to the position apart as far as offset from the value set in number. (The default value is 0.)
--body	Incremental backup file	It displays the header of page (header) or the header and page (all). If not set, it does not display anything. (The default value is none).
--tbs	Incremental backup file	It is valid only when --body option is set. It specifies the certain tablespace number in the incremental backup file. If not set, it refers to all tablespace.
--all	Log file	It dumps all including invalid logs.



An option is not used when dumping the property file.

36.2 Examples of Using gdump

Control File

- Dumping system section

```
$ gdump control control_0.ctl --section sys --silent
[SYSTEM SECTION]
```

```
-----
SERVER STATE           : SERVICE
DATA STORE MODE       : TDS
LAST CHECKPOINT LSN   : 136976
INCREMENTAL BACKUP CHUNK COUNT : 1
INCREMENTAL BACKUP SECTION OFFSET : 512
LOG SECTION OFFSET    : 8704
DB SECTION OFFSET     : 13312
```

- Dumping log section

```
$ gdump control control_0.ctl --section log --silent
[LOG SECTION]
```

```
-----
DATABASE CREATION TIME : 2014-08-25 18:37:11.299610
[CHECKPOINT]
LID                     : 0,54834,13
LSN                     : 136976
RECOVERY LSN           : 136976
ARCHIVELOG MODE        : ARCHIVELOG
LAST INACTIVATED LOGFILE SEQUENCE : -1
[LOG STREAM]
STATE                   : ACTIVE
GROUP COUNT            : 4
BLOCK SIZE             : 512
FILE SEQUENCE         : 0
[LOG GROUP #0]
STATE                   : CURRENT
SIZE                   : 104857600
MEMBER COUNT          : 1
FILE SEQUENCE         : 0
```

```
PREV LAST LSN : -1
MEMBER #0      : "/home/lkh/work/product/Gliese/home/wal/redo_0_0.log"
```

- Dumping database section

```
$ gdump control control_0.ctl --section db --silent
[DB SECTION]
-----
[DATABASE]
TRANSACTION_TABLE_SIZE : 1024
UNDO_RELATION_COUNT    : 128
TABLESPACE COUNT       : 4
NEW TABLESPACE ID     : 4
[TABLESPACE #0]
NAME                    : DICTIONARY_TBS
ATTRIBUTES              : MEMORY | PERSISTENT | DICT
STATE                   : CREATED
LOGGING STATE           : LOGGING
ONLINE STATE            : ONLINE
EXTENT_SIZE             : 8
RELATION_ID             : 0
[DATAFILE #0]
SIZE                   : 134209536
STATE                  : CREATED
NAME                   : "/home/lkh/work/product/Gliese/home/db/system_dict.dbf"
```

- Dumping incremental backup section

```
$ gdump control control_0.ctl --section backup --silent
[INCREMENTAL BACKUP SECTION]
-----
[ BACKUP #0 ]
FILE PATH : /home/lkh/work/product/Gliese/home/backup/databaseD20140825T183902L0S0.inc
BACKUP LSN : 136976
BACKUP LEVEL : 0
BACKUP OBJECT : database
[ BACKUP #1 ]
FILE PATH : /home/lkh/work/product/Gliese/home/backup/controlD20140825T183904L0S0.inc
BACKUP LSN : 136976
BACKUP LEVEL : 0
BACKUP OBJECT : control
```

Datafile

- Dumping the first page of datafile *system_dict.dbf*

```
$ gdump data system_dict.dbf --silent
TABLESPACE ID : 0
DATAFILE ID : 0
PAGE SEQUENCE ID : 0
-----
[PHYSICAL HEADER] TYPE(EXT_BLOCK_MAP), FREENESS(FREE), LSN(107938),
TIMESTAMP(1408959438472006), PARENT RID(0,-1,0), SEGMENT ID(0), MAX VIEW SCN(0), AGABLE
SCN(0), SELF ID(0,0)
-----
0000    0200000004000000 A2A5010000000000 4643D5EE70010500 0000FFFF00000000
0020    0000000000000000 0000000000000000 0000000000000000 0300000000000000
0040    0000000000000000 0000000000000000 0000000000000000 0200000001000000
0060    0200000001000000 03200000001000000 0000000000000000 0000000000000000
0080    0000000000000000 0000000000000000 0000000000000000 0000000000000000
00A0    0000000000000000 0000000000000000 0000000000000000 0000000000000000
00C0    0000000000000000 0000000000000000 0000000000000000 0000000000000000
....
```

- Dumping three pages from the 100th page of datafile *system_dict.dbf*

```
$ gdump data system_dict.dbf --number 100 --fetch 3 --silent
TABLESPACE ID : 0
DATAFILE ID : 0
PAGE SEQUENCE ID : 100
-----
[PHYSICAL HEADER] TYPE(BITMAP_HEADER), FREENESS(INSERTABLE), LSN(348),
TIMESTAMP(1408959438472006), PARENT RID(0,57,4), SEGMENT ID(4294967296), MAX VIEW SCN(0),
AGABLE SCN(0), SELF ID(0,1
00)
-----
0000    0400000003000000 5C01000000000000 4643D5EE70010500 0000390004000000
0020    0000000001000000 0000000000000000 0000000000000000 80C0317800000000
0040    0000000000000000 0000000000000000 0000000064000000 0100000001000002
0060    FFFFFFFFFFFFFFFF 0100000000000000 0000000000000000 0000000000000000
0080    0000000000000000 0200000001000000 7303000072030000 6E00010000000000
00A0    3700000000000000 0000000000000000 0000000000000000 0000000000000000
```

```
00C0 0000000000000000 0000000000000000 0000000000000000 0000000000000000
....
1FC0 0000000000000000 0000000000000000 0000000000000000 0000000000000000
1FE0 0000000000000000 0000000000000000 0000000000000000 5C01000000000000
TABLESPACE ID : 0
DATAFILE ID : 0
PAGE SEQUENCE ID : 101
```

[PHYSICAL HEADER] TYPE(BITMAP_HEADER), FREENESS(INSERTABLE), LSN(353),
TIMESTAMP(1408959438472006), PARENT RID(0,58,4), SEGMENT ID(4294967296), MAX VIEW SCN(0),
AGABLE SCN(0), SELF ID(0,1
01)

```
0000 0400000003000000 6101000000000000 4643D5EE70010500 00003A0004000000
0020 0000000001000000 0000000000000000 0000000000000000 00BF317800000000
0040 0000000000000000 0000000000000000 0000000065000000 0100000001000002
0060 FFFFFFFFFFFFFFFF 0100000000000000 0000000000000000 0000000000000000
0080 0000000000000000 0200000001000000 8303000082030000 7000010000000000
00A0 3800000000000000 0000000000000000 0000000000000000 0000000000000000
00C0 0000000000000000 0000000000000000 0000000000000000 0000000000000000
....
1FC0 0000000000000000 0000000000000000 0000000000000000 0000000000000000
1FE0 0000000000000000 0000000000000000 0000000000000000 6101000000000000
TABLESPACE ID : 0
DATAFILE ID : 0
PAGE SEQUENCE ID : 102
```

[PHYSICAL HEADER] TYPE(BITMAP_HEADER), FREENESS(INSERTABLE), LSN(358),
TIMESTAMP(1408959438472006), PARENT RID(0,59,4), SEGMENT ID(4294967296), MAX VIEW SCN(0),
AGABLE SCN(0), SELF ID(0,1
02)

```
0000 0400000003000000 6601000000000000 4643D5EE70010500 00003B0004000000
0020 0000000001000000 0000000000000000 0000000000000000 C0BD317800000000
0040 0000000000000000 0000000000000000 0000000066000000 0100000001000002
0060 FFFFFFFFFFFFFFFF 0100000000000000 0000000000000000 0000000000000000
0080 0000000000000000 0200000001000000 9303000092030000 7200010000000000
00A0 3900000000000000 0000000000000000 0000000000000000 0000000000000000
00C0 0000000000000000 0000000000000000 0000000000000000 0000000000000000
....
```

- Dumping the header of datafile *system_dict.dbf*

```
$ gdump data system_dict.dbf --header --silent
FILE                : system_dict.dbf
Tablespace Physical Id : 0
Datafile Id         : 0
Last Checkpoint Lsn  : 136976
Creation TIME       : 2014-08-25 18:37:18.472006
```

Log File

- It dumps all of online redo log file *redo_0_0.log*.

```
$ gdump log redo_0_0.log --silent
=====
[LOG FILE HEADER]
-----
LOG_GROUP_ID       : 0
BLOCK_SIZE         : 512
FILE_SIZE          : 104857600
FILE_SEQUENCE      : 0
PREV_LAST_LSN     : -1
CREATION TIME      : 2014-08-25 18:37:13.315283
=====
[LOG #0] : BLOCK(0), LSN(0), SIZE(1132), PIECE_COUNT(1), TRANS_ID(FFFFFFFFFFFF0001),
RID(0,-1,0)
[PIECE #0] : TYPE(MEMORY_FILE_CREATE), SIZE(1116), CLASS(DATAFILE), REDO_TYPE(CONTROL_FILE),
PROPAGATE_LOG(YES), RID(0,0,0)
  FFFFFFFF2F686F6D 652F6C6B682F776F 726B2F70726F6475 63742F476C696573    ..../home/llkh/work/produ ct/Glies
  652F686F6D652F64 622F73797374656D 5F646963742E6462 6600000000000000    e/home/db/system
  _dict.db f.....
  0000000000000000 0000000000000000 0000000000000000 0000000000000000    .....
  .....
[LOG #1] : BLOCK(3), LSN(1), SIZE(232), PIECE_COUNT(1), TRANS_ID(FFFFFFFFFFFF0001), RID(0,0,0)
[PIECE #0] : TYPE(MEMORY_TBS_CREATE), SIZE(216), CLASS(DATAFILE), REDO_TYPE(CONTROL_FILE),
PROPAGATE_LOG(YES), RID(0,0,0)
... Ellipsis ...
```

- It dumps three logs from a log which is away as far as five offsets from log sequence number 100 in *r*

```

000000000000000000 000000000000000000 000000000000000000 000000000000000000 .....
.....
000000000000000000 000000000000000000 01000000B2000000 .....
.....

```

Incremental Backup File

- It dumps incremental backup information.
 - Only header and tail of file in *databaseD20140825T183902L0S0.inc* are dumped as follows.

```

$ gdump backup databaseD20140825T183902L0S0.inc --silent
INCREMENTAL FILE HEADER
-----
OBJECT TYPE(DATABASE), TBS COUNT(3), BODY SIZE(62742528)
LSN: PREV(0), MAX (136976), CHKPT(136976)
CHKPT LID: File Seq No(0), Block Info1(877344), Block Info2(13)
-----
INCREMENTAL FILE TAIL
-----
TABLESPACE ID(000), BACKUP PAGE COUNT(05372), TABLESPACE OFFSET(8192)
TABLESPACE ID(001), BACKUP PAGE COUNT(02090), TABLESPACE OFFSET(44015616)
TABLESPACE ID(002), BACKUP PAGE COUNT(00197), TABLESPACE OFFSET(61136896)

```

- It dumps header and body of page for the entire page of incremental backup.
 - The entire page of all tablespaces in *databaseD20140825T183902L0S0.inc* is dumped as follows.

```

$ gdump backup databaseD20140724T123414L0S0.inc --body all
INCREMENTAL FILE HEADER
-----
OBJECT TYPE(DATABASE), TBS COUNT(3), BODY SIZE(62742528)
LSN: PREV(0), MAX (136976), CHKPT(136976)
CHKPT LID: File Seq No(0), Block Info1(877344), Block Info2(13)
-----
INCREMENTAL FILE TAIL
-----
TABLESPACE ID(000), BACKUP PAGE COUNT(05372), TABLESPACE OFFSET(8192)
TABLESPACE ID(001), BACKUP PAGE COUNT(02090), TABLESPACE OFFSET(44015616)
TABLESPACE ID(002), BACKUP PAGE COUNT(00197), TABLESPACE OFFSET(61136896)
TABLESPACE ID : 0
DATAFILE ID : 0

```

PAGE SEQUENCE ID : 0

 [PHYSICAL HEADER] TYPE(EXT_BLOCK_MAP), FREENESS(FREE), LSN(107938),
 TIMESTAMP(1408959438472006), PARENT RID(0,-1,0), SEGMENT ID(0), MAX VIEW SCN(0), AGABLE
 SCN(0), SELF ID(0,0)

 0000 0200000004000000 A2A5010000000000 4643D5EE70010500 0000FFFF00000000
 0020 0000000000000000 0000000000000000 0000000000000000 0000000000000000
 0040 0000000000000000 0000000000000000 0000000000000000 0200000001000000
 0060 0200000001000000 0320000001000000 0000000000000000 0000000000000000
 0080 0000000000000000 0000000000000000 0000000000000000 0000000000000000

... Ellipsis ...

TABLESPACE ID : 0

DATAFILE ID : 0

PAGE SEQUENCE ID : 1

 [PHYSICAL HEADER] TYPE(BITMAP_HEADER), FREENESS(FREE), LSN(100016),
 TIMESTAMP(1408959438472006), PARENT RID(0,-1,0), SEGMENT ID(4294967296), MAX VIEW SCN(0),
 AGABLE SCN(0), SELF ID(0,1)

 0000 0400000004000000 B086010000000000 4643D5EE70010500 0000FFFF00000000
 0020 0000000001000000 0000000000000000 0000000000000000 802A327800000000
 0040

... Ellipsis ...

TABLESPACE ID : 2

DATAFILE ID : 0

PAGE SEQUENCE ID : 24580

 [PHYSICAL HEADER] TYPE(EXT_MAP), FREENESS(FREE), LSN(24), TIMESTAMP(1408959441642963),
 PARENT RID(0,-1,0), SEGMENT ID(0), MAX VIEW SCN(0), AGABLE SCN(0), SELF ID(2,24580)

 0000 0300000004000000 1800000000000000 D3A505EF70010500 0000FFFF00000000
 0020 0000000000000000 0000000000000000 0000000000000000 0000000000000000
 0040 0000000000000000 0000000000000000 0200000004600000 1E001E0000001E00

... Ellipsis ...

- It dumps header and body of page whose page number is bigger than the specified number in incremental backup.
 - The pages whose page number is bigger than 1,000 of all tablespaces in *databaseD20140825T183902L050.inc* are dumped as follows.

```
$ gdump backup databaseD20140724T123414L0S0.inc --number 10000 --body all
```

```
INCREMENTAL FILE HEADER
```

```
-----
OBJECT TYPE(DATABASE), TBS COUNT(3), BODY SIZE(62742528)
LSN: PREV(0), MAX (136976), CHKPT(136976)
CHKPT LID: File Seq No(0), Block Info1(877344), Block Info2(13)
-----
```

```
INCREMENTAL FILE TAIL
```

```
-----
TABLESPACE ID(000), BACKUP PAGE COUNT(05372), TABLESPACE OFFSET(8192)
TABLESPACE ID(001), BACKUP PAGE COUNT(02090), TABLESPACE OFFSET(44015616)
TABLESPACE ID(002), BACKUP PAGE COUNT(00197), TABLESPACE OFFSET(61136896)
TABLESPACE ID : 2
DATAFILE ID : 0
PAGE SEQUENCE ID : 16387
-----
```

```
[PHYSICAL HEADER] TYPE(EXT_MAP), FREENESS(FREE), LSN(22), TIMESTAMP(1408959441642963),
PARENT RID(0,-1,0), SEGMENT ID(0), MAX VIEW SCN(0), AGABLE SCN(0), SELF ID(2,16387)
```

```
-----
0000 0300000004000000 1600000000000000 D3A505EF70010500 0000FFFF00000000
0020 0000000000000000 0000000000000000 0000000000000000 0000000000000000
0040 0000000000000000 0000000000000000 0200000003400000 0001000100000001
0060 0000000000000000 0000000000000000 0000000000000000 0000000000000000
0080 0000000000000000 0000000000000000 0000000000000000 0000000000000000
```

```
... Ellipsis ...
```

```
TABLESPACE ID : 2
DATAFILE ID : 0
PAGE SEQUENCE ID : 24580
-----
```

```
[PHYSICAL HEADER] TYPE(EXT_MAP), FREENESS(FREE), LSN(24), TIMESTAMP(1408959441642963),
PARENT RID(0,-1,0), SEGMENT ID(0), MAX VIEW SCN(0), AGABLE SCN(0), SELF ID(2,24580)
```

```
-----
0000 0300000004000000 1800000000000000 D3A505EF70010500 0000FFFF00000000
0020 0000000000000000 0000000000000000 0000000000000000 0000000000000000
0040 0000000000000000 0000000000000000 0200000004600000 1E001E0000001E00
0060 0000000000000000 0000000000000000 0000000000000000 0000000000000000
0080 0000000000000000 0000000000000000 0000000000000000 0000000000000000
```

```
... The rest is omitted ...
```

- It dumps header and body of page for the specified number of the specified tablespace in incremental backup.

- The page of number 1,000 in the tablespace of number 0 in *database D20140825T183902L0S0.inc* is dumped as follows.

```
gdump backup databaseD20140825T183902L0S0.inc --tbs 0 --number 1000 --body all --fetch 1
--silent | more
```

```
INCREMENTAL FILE HEADER
```

```
-----
OBJECT TYPE(DATABASE), TBS COUNT(3), BODY SIZE(62742528)
LSN: PREV(0), MAX (136976), CHKPT(136976)
CHKPT LID: File Seq No(0), Block Info1(877344), Block Info2(13)
-----
```

```
INCREMENTAL FILE TAIL
```

```
-----
TABLESPACE ID(000), BACKUP PAGE COUNT(05372), TABLESPACE OFFSET(8192)
TABLESPACE ID(001), BACKUP PAGE COUNT(02090), TABLESPACE OFFSET(44015616)
TABLESPACE ID(002), BACKUP PAGE COUNT(00197), TABLESPACE OFFSET(61136896)
TABLESPACE ID : 0
DATAFILE ID : 0
PAGE SEQUENCE ID : 1000
-----
```

```
[PHYSICAL HEADER] TYPE(UNFORMAT), FREENESS(FREE), LSN(6307), TIMESTAMP(1408959438472006),
PARENT RID(0,-1,0), SEGMENT ID(0), MAX VIEW SCN(0), AGABLE SCN(0), SELF ID(0,1000)
-----
```

```
0000  0100000004000000 A318000000000000 4643D5EE70010500 0000FFFF00000000
0020  0000000000000000 0000000000000000 0000000000000000 0000000000000000
0040  0000000000000000 0000000000000000 00000000E8030000 0000000000000000
0060  0000000000000000 0000000000000000 0000000000000000 0000000000000000
```

... The rest is omitted ...

Property File

- PAGE_CHECKSUM_TYPE which is the one of the property is set by using gsql as follows.

```
gSQL> ALTER SYSTEM SET PAGE_CHECKSUM_TYPE = 1 SCOPE = BOTH;
System altered.
```

- The binary property file of GOLDILOCKS is dumped as follows.

```
$ gdump property goldilocks.properties.binary
```

```
=====
FILE: goldilocks.properties.binary
```

```
TYPE: PROPERTY-BINARY
```

```
TIME: 2014-08-29 12:45:13.853448
```

```
=====
PAGE_CHECKSUM_TYPE = 1
```

```
=====
TIME: 2014-08-29 12:45:13.853627
=====
```

Commit Log

The commit log file is dumped as follows.

```
$ gdump commit_log commit.log
```

```
=====
FILE: commit.log
```

```
TYPE: COMMIT LOG FILE
```

```
TIME: 2017-03-23 11:47:42.555368
```

```
=====
[COMMIT LOG FILE HEADER]
```

```
-----
FILE_SEQUENCE   : 0
```

```
FILE_SIZE       : 104857600
```

```
MAX_BLOCK_COUNT : 204800
```

```
SIGNATURE       : 5DAABFECBDCD11E68785A3701A679D47
```

```
=====
[BLOCK(0), LOG_COUNT(1)]
```

```
TRANS_ID(1.0.59899956), COMMIT_SCN(16603.645.17371), INDOUBT_BEHAVIOR(FORGET),
```

```
SYNC_GLOBAL_TABLE_SCN(TRUE), PREV_LOG_FILE_SEQ(-1), PREV_LOG_BLOCK_SEQ(-1),
```

```
PREV_LOG_SLOT_SEQ(-1)
```

Log Buffer File

The log buffer file created after executing gsyncher is dumped as follows.
For more information, refer to **gsyncher**.

```
$ gdump log_buffer logbuffer.log
=====
FILE: logbuffer.log
TYPE: LOG BUFFER FILE
TIME: 2017-03-23 11:10:12.787400
=====
[LOG BUFFER FILE HEADER]
-----
REAR_FILE_BLOCK_SEQ_NO   : 203410
FRONT_FILE_BLOCK_SEQ_NO  : 203410
REAR_SBSN                : 797213
REAR_LSN                 : 375933
REAR_LID                 : (3, 3254496, 161)
FRONT_SBSN               : 797212
FRONT_LSN                : 375933
FILE_SEQ_NO              : 3
BUFFER_SIZE              : 10485760
BUFFER_BLOCK_COUNT      : 20480
BLOCK_OFFSET             : 13
GROUP_COMMIT_LSN        : 336688
LOG_SWITCHING_SBSN      : -1
=====
```

Pending Log Buffer File

The pending log buffer file created after executing gsyncher is dumped as follows.
For more information, refer to **gsyncher**.

```
$ gdump pend_buffer pendbuffer.log
=====
FILE: pendbuffer.log
TYPE: PEND BUFFER FILE
TIME: 2017-03-23 11:10:29.603646
```

```
=====  
=====  
[PEND LOG BUFFER FILE HEADER]
```

```
PEND_LOG_BUFFER COUNT : 4
```

```
-----  
PEND_LOG_BUFFER NO. : 0
```

```
PEND_BUFFER_SIZE : 1048576
```

```
BUFFER_BLOCK_COUNT : 16384
```

```
FRONT_PBSN : 102
```

```
REAR_PBSN : 102
```

```
FRONT_LSN : -1
```

```
REAR_LSN : 327055
```

```
-----  
PEND_LOG_BUFFER NO. : 1
```

```
PEND_BUFFER_SIZE : 1048576
```

```
BUFFER_BLOCK_COUNT : 16384
```

```
FRONT_PBSN : 0
```

```
REAR_PBSN : 0
```

```
FRONT_LSN : -1
```

```
REAR_LSN : -1
```

```
-----  
PEND_LOG_BUFFER NO. : 2
```

```
PEND_BUFFER_SIZE : 1048576
```

```
BUFFER_BLOCK_COUNT : 16384
```

```
FRONT_PBSN : 0
```

```
REAR_PBSN : 0
```

```
FRONT_LSN : -1
```

```
REAR_LSN : -1
```

```
-----  
PEND_LOG_BUFFER NO. : 3
```

```
PEND_BUFFER_SIZE : 1048576
```

```
BUFFER_BLOCK_COUNT : 16384
```

```
FRONT_PBSN : 0
```

```
REAR_PBSN : 0
```

```
FRONT_LSN : -1
```

```
REAR_LSN : -1
```

```
-----  
=====
```

37.

tablediff

37.1 Overview of tablediff

Background

The GOLDILOCKS system operator should prepare for the unexpected failure of GOLDILOCKS synchronization of two tables using the tools such as cyclone or LogMirror. An unexpected failure of synchronization refers that a particular row exists only in one table or the column values of rows to be synchronized are different from each other. Cyclone and LogMirror do not notify a user whether synchronization is failed. It is required to verify the synchronization of the table and to perform synchronization, if necessary, at non-operation time.

Features

tablediff is a tool comparing two tables of GOLDILOCKS which was synchronized by using CDC in a row unit. It reports when a particular row exists only in a table or values are different each other, then performs synchronization. The configuration file for controlling various operations is input, and the log files to report the unsynchronized rows and the synchronization results are output.

The constraints are that the schemas of two tables should be same and each of them should have the primary key. It is not recommended to perform the tool for table of the currently executing transaction because the table can be updated in real time. However, it does not matter for the currently executing query in g (SELECT statement). This tool is available only for the GOLDILOCKS tables.

This tool has two executing commands, which are TableDiff and TableSync.

TableDiff

```
java sunje.goldilocks.tool.diff.TableDiff [configure file]
```

TableDiff program verifies whether two tables are unsynchronized, and it may output the information(binary file) to perform synchronization for unsynchronized rows immediately or at a later time according to a n option. The immediate synchronization can be operated for multiple threads.

TableSync

```
java sunje.goldilocks.tool.diff.TableSync [configure file]
```

Tablesync program performs synchronization by using the sync information which was previously left by TableDiff. (Row comparison is not performed.) A simultaneous execution can be performed by driving multi threads.



Unsynchronized rows of two tables to which the configure file is not applied are stored in a bin file left by TableDiff. TableSync uses this bin file to forcibly synchronize two tables.

Characteristics

This tool is a java application and it is provided in a jar file form, so Java(1.6) is required to execute the tool. Also, goldilocks6.jar is required because GOLDDILOCKS JDBC driver is used. It can be remotely performed because it is connected to GOLDDILOCKS by using TCP/ IP, and it is performed at much faster rate than using JDBC, ODBC with the proprietary protocol.

The row comparison and synchronization can be simultaneously performed with multi threads. For multithreading of the row comparison, equal dividing of the range of the key in the table should be manually performed. When the user splits the key range into ten ranges (The user can specify it in the configuration file), then ten threads compare the tables. On the other hand, the synchronization operation is performed by threads of as many as it is specified.

File Configuration

tablediff program consists of a single file called as `$GOLDDILOCKS_HOME/bin/tablediff.jar`. `$GOLDDILOCKS_HOME/lib/goldilocks6.jar` file is also required for execution. Also, the configuration file is required as an input argument, and refer to the sample file, `$GOLDDILOCKS_HOME/conf/tablediff.conf`.

37.2 Usage

Command Usage

Java (JRE 1.6 or JDK1.6) is required because tablediff is a java program. For this, tablediff.jar and goldilocks6.jar files should be included in CLASSPATH, or they should be specified with -classpath option of java. tablediff is executed as follows.

```
export
CLASSPATH=$CLASSPATH:$GOLDILOCKS_HOME/bin/tablediff.jar:$GOLDILOCKS_HOME/lib/goldilocks6.jar
java sunje.goldilocks.tool.diff.TableDiff [configure file]
```

Or

```
java -classpath $GOLDILOCKS_HOME/bin/tablediff.jar:$GOLDILOCKS_HOME/lib/goldilocks6.jar
sunje.goldilocks.tool.diff.TableDiff [configure file]
```

The result of executing TableDiff for the simple sample table is as follows.

```
gSQL> create table tab1 ( c1 integer primary key, c2 char(10) );
gSQL> create table tab2 ( c1 integer primary key, c2 char(10) );
gSQL> insert into tab1 values ( 1, 'HELLO');
gSQL> insert into tab2 values ( 1, 'HELLO');
gSQL> insert into tab1 values ( 2, 'WORLD');
gSQL> insert into tab2 values ( 2, 'world');
gSQL> insert into tab1 values ( 3, 'good');
gSQL> insert into tab2 values ( 4, 'good');
gSQL> commit;
shell> java sunje.goldilocks.tool.diff.TableDiff tablediff.conf
Total 4 rows processed
> row diff          : 1, update target(success/failure): 1/0
> key diff source only: 1, insert into target(success/failure): 1/0
> key diff target only: 1, delete from target(success/failure): 1/0
TableDiff completed
elapsed time = 0.229 sec
```

- The contents of tablediff.conf

```
SOURCE_URL      = jdbc:goldilocks://127.0.0.1:22581/test
SOURCE_USER     = TEST
SOURCE_PASSWORD = test
SOURCE_SCHEMA   = PUBLIC
SOURCE_TABLE    = TAB1
TARGET_URL      = jdbc:goldilocks://127.0.0.1:22581/test
TARGET_USER     = TEST
TARGET_PASSWORD = test
TARGET_SCHEMA   = PUBLIC
TARGET_TABLE    = TAB2
OPERATION       = SYNC
TARGET_INSERT   = ON
TARGET_UPDATE   = ON
TARGET_DELETE   = ON
SOURCE_INSERT   = OFF
```

Property Option

This chapter describes the available property options in the configuration file of tablediff.

Property Options for SOURCE, TARGET Tables

These property options should necessarily be specified and they define the source and target tables. The source and target refer to table to be compared each.

- SOURCE_URL: It is JDBC connection URL of GOLDILOCKS in which the source table exists.
- SOURCE_USER: It is the user account of GOLDILOCKS in which the source table exists.
- SOURCE_PASSWORD: It is the password of GOLDILOCKS in which the source table exists.
- SOURCE_SCHEMA: It is the schema of source table.
- SOURCE_TABLE: It is the name of source table.
- TARGET_URL: It is JDBC connection URL of GOLDILOCKS in which the target table exists.
- TARGET_USER: It is the user account of GOLDILOCKS in which the target table exists.
- TARGET_PASSWORD: It is the password of GOLDILOCKS in which the target table exists.
- TARGET_SCHEMA: It is the schema of target table.
- TARGET_TABLE: It is the name of target table.

The following is an example.

```
SOURCE_URL      = jdbc:goldilocks://192.168.0.100:22581/test
SOURCE_USER     = TEST
SOURCE_PASSWORD = test
SOURCE_SCHEMA   = PUBLIC
SOURCE_TABLE    = T1
TARGET_URL      = jdbc:goldilocks://192.168.0.101:22581/test
TARGET_USER     = TEST
TARGET_PASSWORD = test
TARGET_SCHEMA   = PUBLIC
TARGET_TABLE    = T2
```

Operation

It determines the operations of TableDiff. The DIFF property verifies only the synchronization integrity and reports it, but the SYNC property verifies the integrity and simultaneously performs synchronization.

The integrity result file(whose file name is specified as DIFF_BIN_FILE property) is generated when operating with DIFF and it is used to execute TableSync.

Synchronization Policy

Four properties are used for controlling the synchronization policy and all of them have the value of either ON or OFF.

- TARGET_INSERT: If the key in the source does not exist in the target, it inserts the key into the target.
- TARGET_UPDATE: If the value of the column which is not a key is different, it updates the target row.
- TARGET_DELETE: If the key does not exist in the source but exists in the target, it deletes the target row.
- SOURCE_INSERT: If the key does not exist in the source but exists in the target, it inserts that row into the source.



Both TARGET_DELETE and SOURCE_INSERT are not allowed to be ON together.

EXCLUDED_COLUMNS

It specifies the columns to be excluded from the comparison. The comma (,) is used as a delimiter and the column name should be specified. The key columns can not be excluded.

WHERE_CLAUSE

It sets the conditions for comparing rows in the table. For example, the condition, `WHERE_CLAUSE = SALARY >= 1000000`, refers that the integrity is verified only for the rows having the values of their column salary equal to or bigger than 1,000,000.

DISPLAY_ROW_UNIT

TableDiff program displays the progress status of table comparison, and it outputs to the console the number of rows processed each time whenever it processes a certain number of rows. The property sets the number of rows to be output. the default value is 100,000, and it can be omitted.

SYNC_OUT_FILE

It specifies the name of the file in which the synchronization result is to be recorded. If not specified, the result is recorded in `tablesnc.log`. If multiple synchronized threads exist, a number is added at the end of the file name.

DIFF_OUT_FILE

It specifies the name of the file in which the row mismatch result is to be recorded. If not specified, the result is recorded in `tablesnc.log`. This file is in a text form which is human-readable.

DIFF_BIN_FILE

If the operation property is set to DIFF, TableDiff records the synchronization information in a file with a name specified by this property. This file is used as an input argument by TableSync.

PROPAGATE_REDO_LOG

It determines whether to propagate the row synchronization log to another replicated server. The default value is OFF.

LOGGING_ON_SUCCESS

It sets whether to record logs even when DML (INSERT, UPDATE, DELETE) used for the row synchronization is successful. The default value is OFF. If it is OFF, then the synchronization performance becomes poor. If DML is failed, the logging information is recorded regardless of this property.

LOGGING_ON_DIFF

It sets whether to record logs when the mismatch occurs during comparing the row integrity. The default value is OFF.

JOB_QUEUE_SIZE

The row synchronization is performed by the operating thread. The threads perform the synchronization by getting the operation from the JOB QUEUE one by one. The main thread of TableDiff or TableSync inserts the operation to JOB QUEUE. JOB QUEUE becomes full if the thread slowly performs synchronization. JOB_QUEUE_SIZE property sets the size of JOB QUEUE. If this value is big, JOB QUEUE never becomes full but it wastes a lot of memory. The default value is 100, and 100 is big enough to use without filling of the queue.

The property is recommended not to change unless it is needed.

JOB_THREAD

It sets the number of threads for synchronization. If not set, the default value is 1. If there are multiple rows to be synchronized, the value should be set considering the number of CPU. The bigger the value, the faster the synchronization is performed.

JOB_UNIT_SIZE

The synchronization is performed in batch as much as the size specified by the property. The default value is 100.

DISPLAY_CALL_STACK

It sets whether to display call stack when an error occurs. The default value is OFF.

Replication Settings for Table Comparison

The row comparison of TableDiff is performed by a single thread by default. But multiple threads can perform comparisons by specifying the condition clause. The property name is PARTITION_RANGE[n], and if the range for N properties is set such as the WHERE clause, n threads perform the comparison each.

For example, the following properties are specified for each of 12 threads to perform the comparison when the table includes the monthly data.

```
PARTITION_RANGE1 = MONTH=1
```

```
PARTITION_RANGE2 = MONTH=2
```

```
PARTITION_RANGE3 = MONTH=3  
PARTITION_RANGE4 = MONTH=4  
PARTITION_RANGE5 = MONTH=5  
PARTITION_RANGE6 = MONTH=6  
PARTITION_RANGE7 = MONTH=7  
PARTITION_RANGE8 = MONTH=8  
PARTITION_RANGE9 = MONTH=9  
PARTITION_RANGE10 = MONTH=10  
PARTITION_RANGE11 = MONTH=11  
PARTITION_RANGE12 = MONTH=12
```

All conditions should be disjointed, and the union of all conditions should be as same as the total set. Also, the column used in the condition should be the front part of the primary key. (It means that the specified condition should be able to use the primary index.)

This property is applied only to TableDiff, and TableSync ignores this property.

38.

gsyncher

38.1 Overview of gsyncher

Definition

gsyncher is a utility provided by GOLDILOCKS, and which synchronizes the log of shared memory and the logfile of disk.

When the server is abnormally terminated, gsyncher synchronizes the latest log of shared memory and the logfile, then records it.

Features

- gsyncher can not be executed during the server operation.
- The STARTUP stage of the server in which gsyncher can be executed is OPEN phase.
- When executing gsyncher, all other applications of the shared memory should be terminated.
- During gsyncher execution, the logfile can be switched and in this case, the controlfile is generated.
- gsyncher backups the controlfile and logfile in which the logs are reflected, in advance.
- gsyncher can be executed after restoring the damaged controlfile.

Usage

```
gsyncher [options]
```

Options

-l --log	Log trace msg
-s --silent	Do not print message
-f --home	home directory
-c --copy-right	Do not print copy right
-b --backup-path	Backup directory
-h --help	Print help message

38.2 Examples

- Example 1: gsyncher is executed during the server is normally operating.

```
$ gsyncher -l
[SHARED MEM] Attached to shm - Name(_STATIC), Key(21128)
[SHARED MEM] Detached from shm.
ERR-HY000(53002): gmaster is active
```

- Example 2: The server is not on the STARTUP stage on which gsyncher can be executed.

```
$ gsyncher -l
[SHARED MEM] Attached to shm - Name(_STATIC), Key(21128)
[SHARED MEM] Detached from shm.
ERR-HY000(53000): invalid phase(MOUNT): executable phase is OPEN
```

- Example 3: When executing gsyncher, the progress is displayed. The execution result is total buffer (0) bytes, and all logs are flushed to the logfile, so there is not a log to be synchronized.

```
$ gsyncher --log
[SHARED MEM] Attached to shm - Name(_STATIC), Key(21128)
[CLEAR PROCESS] Process 'gbalancer' is cleared.
[CLEAR PROCESS] Process 'gdispatcher' is cleared.
[CLEAR PROCESS] Process 'gdispatcher' is cleared.
[CLEAR PROCESS] Process 'gserver' is cleared.
[CLEAR PROCESS] Process 'gserver' is cleared.
[CLEAR PROCESS] Process 'gserver' is cleared.
[CLEAR PROCESS] Process 'gserver' is cleared.
[CLEAR PROCESS] Process 'gserver' is cleared.
[CLEAR PROCESS] Process 'gserver' is cleared.
[CLEAR PROCESS] Process 'gserver' is cleared.
[CLEAR PROCESS] Process 'gserver' is cleared.
[CLEAR PROCESS] Process 'gserver' is cleared.
[CLEAR PROCESS] Process 'gserver' is cleared.
[FLUSH] Log buffer flushed - Log group from id (0) to (0), lsn from (130784) to (130784),
total buffer (0) bytes
[SHARED MEM] Detached from shm.
[FINI] Log sync complete.
```

- gsyncher operations are recorded in logfile by using --log option.

```

$ cat $GOLDILOCKS_DATA/trc/gsyncher.trc
=====
gsyncher start
TIME      : 2015-08-05 16:12:15.776633
=====
[2015-08-05 16:12:15.776763 THREAD(29199,139846497756928)]
[INIT] Log started.
[2015-08-05 16:12:15.777113 THREAD(29199,139846497756928)]
[SHARED MEM] Attached to shm - Name(_STATIC), Key(21128)
[2015-08-05 16:12:15.777208 THREAD(29199,139846497756928)]
[CLEAR PROCESS] Process 'gbalancer' is cleared.
[2015-08-05 16:12:15.777297 THREAD(29199,139846497756928)]
[CLEAR PROCESS] Process 'gdispatcher' is cleared.
[2015-08-05 16:12:15.777358 THREAD(29199,139846497756928)]
[CLEAR PROCESS] Process 'gdispatcher' is cleared.
[2015-08-05 16:12:15.777416 THREAD(29199,139846497756928)]
[CLEAR PROCESS] Process 'gserver' is cleared.
[2015-08-05 16:12:15.777917 THREAD(29199,139846497756928)]
[CLEAR PROCESS] Process 'gserver' is cleared.
[2015-08-05 16:12:15.777993 THREAD(29199,139846497756928)]
[CLEAR PROCESS] Process 'gserver' is cleared.
[2015-08-05 16:12:15.778051 THREAD(29199,139846497756928)]
[CLEAR PROCESS] Process 'gserver' is cleared.
[2015-08-05 16:12:15.778107 THREAD(29199,139846497756928)]
[CLEAR PROCESS] Process 'gserver' is cleared.
[2015-08-05 16:12:15.778577 THREAD(29199,139846497756928)]
[CLEAR PROCESS] Process 'gserver' is cleared.
[2015-08-05 16:12:15.778652 THREAD(29199,139846497756928)]
[CLEAR PROCESS] Process 'gserver' is cleared.
[2015-08-05 16:12:15.778710 THREAD(29199,139846497756928)]
[CLEAR PROCESS] Process 'gserver' is cleared.
[2015-08-05 16:12:15.778766 THREAD(29199,139846497756928)]
[CLEAR PROCESS] Process 'gserver' is cleared.
[2015-08-05 16:12:15.778822 THREAD(29199,139846497756928)]
[CLEAR PROCESS] Process 'gserver' is cleared.
[2015-08-05 16:12:15.818007 THREAD(29199,139846497756928)]
[SHARED MEM] Detached from shm.
[2015-08-05 16:12:15.818100 THREAD(29199,139846497756928)]
[FINI] Log sync complete.

```

- Example 4: The logs from lsn 130786 to lsn 131012 are flushed to the log group 1.

[FLUSH] Log buffer flushed - Log group from id (2) to (3), lsn from (156412) to (178129), total buffer (16644096) bytes

[CONTROLFILE] Saving controlfile caused by logfile switching.

[CONTROLFILE] '/media/solid/ssd_home/work/product/Gliese/home/wal/control_0.ctl' control file is saved.

[CONTROLFILE] '/media/solid/ssd_home/work/product/Gliese/home/wal/control_1.ctl' control file is saved.

[SHARED MEM] Detached from shm.

[FINI] Log sync complete.

39.

gmon

39.1 Overview of gmon

Definition

gmon is a database (gmaster) process monitoring utility provided by GOLDILOCKS.

Features

gmon monitors whether database process (gmaster) is operated, and when the process is abnormally terminated, not by user's SHUTDOWN, then it executes **gsyncher** and terminates the process. It intends to reduce the loss of logs by executing gsyncher.

gmon can be set to be automatically operated by setting the server property GMON_AUTOSTART to 1, or a user can directly executes gmon.



A single gmaster process can monitor only one gmon process.

Usage

```
gmon [options]
```

Options

```
-s --start      Start gmon
-t --stop      Stop gmon
-u --status    Get gmon status
-o --home      gmaster home path
-l --silent    Suppress display message
-r --no-copyright Suppress display copy right and version
-h --help      Print help messages
```

39.2 Examples

- Example 1: Execute gmon by using the default path (\$GOLDILOCKS_DATA).

```
$ gmon --start  
gmon is started.
```

- Example 2: Execute gmon by specifying home path. When a relative path is used, home path is specified based on \$GOLDILOCKS_DATA.

```
$ gmon --start --home g1n1_home  
gmon is started.
```

- Example 3: Execute gmon by specifying home path as an absolute path. When an absolute path is used, the specified path is specified as a home path.

```
$ gmon --start --home /g1n1_home  
gmon is started.
```

- Example 4: Check the status of gmon process.

```
$ gmon --status --home /g1n1_home  
gmon is running(19119).
```

- Example 5: Terminate the gmon process.

```
$ gmon --stop --home /g1n1_home  
gmon is stopped.
```

40.

gtrclogger

40.1 Overview of gtrclogger

Definition

gtrclogger is a utility remotely collecting logs of GOLDILOCKS.

GOLDILOCKS basically records events and trace logs which occur in a server, in system.trc file of the specified directory of SYSTEM_LOGGER_DIR of property. (The default value is \$GOLDILOCKS_DATA/trc)

If multiple different instances are being operated, trace logs occur in each server should be separately monitored. For that, gtrclogger makes trace logs of each different GOLDILOCKS instances to be collected in a single spot. gtrclogger receives trace logs of various GOLDILOCKS being operated in a different device with udp, and stores them in a file.

gtrclogger receives trace logs from the remote GOLDILOCKS and records them in a file. For that, the remote GOLDILOCKS should have the following transfer properties.

- TRACE_LOGGER
- TRACE_LOGGER_REMOTE_HOST
- TRACE_LOGGER_REMOTE_PORT

Features

- gtrclogger can be operated regardless of server operation.
- Even when it receives trace logs from various servers, it sequentially stores them in a file.
- A trace log is basically stored as \$(GOLDILOCKS_DATA)/trc/system.rmt.trc.
- If system.rmt.trc is bigger than 10M bytes , it is backedup as system.rmt.trc_date_Index.

Usage

```
| gtrclogger [options]
```

Options

```
-s --start      start gtrclogger
-q --stop      stop gtrclogger
-p --port      udp port for receive log (1024 ~ 49151): default 21470
-d --dir       write file directory: default $(GOLDILOCKS_DATA)/system.rmt.trc
-h --help      show gtrclogger help messages
```

40.2 Examples

- Example 1: Execute gtrclogger by using the default port (21470) and the default directory(\$GOLDILOCKS_DATA/trc).

```
$ gtrclogger --start  
gtrclogger is started successfully.
```

- Example 2: Receive a trace log with two ports (21471, 21472) and set the directory as \$GOLDILOCKS_DATA/rmt_trc, then execute gtrclogger.

```
$ gtrclogger -s -p 21471 -p 21472 -d $GOLDILOCKS_HOME/rmt_trc  
ERR-HY000(11040): No such object  
(/home/lym1/workspace/product/Gliese/home/rmt_trc/system.rmt.trc)  
$ mkdir $GOLDILOCKS_HOME/rmt_trc  
$ gtrclogger -s -p 21471 -p 21472 -d $GOLDILOCKS_HOME/rmt_trc  
gtrclogger is started successfully.
```

- Example 3: Terminate gtrclogger.

```
$ gtrclogger -q  
Stop Done.
```

41.

glocator

41.1 Overview of glocator

Definition

glocator is a utility which provides locations to a client and manages them in GOLDILOCKS cluster system. The location information of cluster member nodes is provided to the glocator program through **gloctl** and **gagent**.

glocator communicates with client and inner process by using a User Datagram Protocol (UDP).



The location information used by glocator is different from the location used by a cluster member node. glocator requires a host, a listener port, a db home path, an agent port of a member node.

glocator should be executed ahead of gagent to receive these location information from gagent, or glocator should receive it through gloctl.

Usage

```
glocator [options]
```

Options

help

Description

It outputs a help message.

Example

```
$ glocator --help
Usage:
  glocator [options]
Options:
  -c --create      Create glocator environment
  -s --start       Start glocator
```



```
-t --stop          Stop glocator
-f --conf         Set configure file
-u --status       Get glocator status
-l --silent       Suppress display message
-r --no-copyright Suppress display copy right and version
-h --help         Print help message
```

create

Description

It creates the data file of glocator.

Example

```
$ glocator --create
glocator is created.
```



The data file of glocator is created in <GOLDILOCKS_DATA>/db directory.

```
$ ls
README glocator.dat system_data.dbf system_dict.dbf system_undo.dbf
```

start

Description

It starts glocator. If glocator having the same port already has started, then an error occurs.

Example

```
$ glocator --start
glocator is started.
```

stop

Description

It stops glocator which is in operation. The same port should be set to stop glocator in operation.

Example

```
$ glocator --stop  
glocator is stopped.
```

conf

Description

It sets the configure file when starting glocator.

Example

```
$ glocator --start --conf goldilocks.glocator.conf  
glocator is started.
```

status

Description

It outputs the status message of glocator which is in operation. The same port should be set to check the status of glocator in operation.

Example

```
$ glocator --status  
Process ID: 26058  
Configuration file: goldilocks.glocator.conf  
Unix domain path: /tmp/unix-glocator.42581  
Udp listen host: 0.0.0.0, Port: 42581  
glocator is running.
```

sync

Description

It synchronizes the data of glocator set in ALTERNATE_LOCATORS before driving glocator.

There are two methods for the data synchronization, which are SOURCE and BOTH. SOURCE method brings data from ALTERNATE_LOCATORS, and BOTH method merges two glocators.

Example

The following is an example of success of a sync option.

```
$ glocator --start --sync  
glocator is started.
```

The following is an example of failure of a sync option. The value is not set in ALTERNATE_LOCATORS property.

```
$ glocator --start --sync  
ERR-HY000(60016): Need more alternate locator host information.
```

The following is an example of failure of a sync option. glocator set in ALTERNATE_LOCATORS property does not response.

```
$ glocator --start --sync  
ERR-HY000(60016): Need more alternate locator host information.
```

silent

Description

It does not output the message of glocator about the execution.

Example

```
$ glocator --start --silent
```

no-copyright

Description

It does not output the message of glocator's copyright and version about the execution.

Example

```
$ glocator --start --no-copyright  
glocator is started.
```

41.2 Using glocator

Data File

glocator data file should be created before starting glocator.

```
$ glocator --create  
glocator is created.
```

The directory in which glocator data file is stored can be altered by editing configuration `LOCATION_FILE_DIR`. The default value is created in `<GOLDILOCKS_DATA>/db`. The data file can be altered by editing `LOCATION_FILE_NAME`. The default value is `glocator.dat`.

The maximum size and initial size of glocator data file can be altered by editing configuration `LOCATION_FILE_MAX_SIZE` and `LOCATION_FILE_SIZE`.

CSTARTUP and CSHUTDOWN

glocator can be used to CSTARTUP and CSHUTDOWN the GOLDILOCKS server.

For that, glocator should be in operation, and CSTARTUP or CSHUTDOWN should be executed through `gsqlnet`.

However, `LOCATOR_DSN` and the property should be set in `odbc.ini` of the device which executes `gsqlnet`. For more information, refer to **GOLDILOCKS UNIX ODBC driver libraries**.

The following contents is set in `odbc.ini` to use glocator.

```
[GOLDILOCKS]  
HOST=127.0.0.1  
PORT=20101  
UID=sys  
PWD=gliese  
LOCATOR_DSN=GLOCATOR  
[GLOCATOR]  
HOST=127.0.0.1  
PORT=42581
```



If FILE property exists in DSN [GLOCATOR], then the file specified in FILE property takes precedence instead of using glocator. Therefore, FILE property should be excluded.

glocator should know the location information of member nodes to execute CSTARTUP and CSHUTDOWN.

Replication

Overview

glocator replication keeps data consistent, so it enables the stable service through the remote glocator when an error occurs.

Configuration

Each glocator should set ALTERNATE_LOCATORS property in a configure file to use the replication feature. Locator_name should be set in ALTERNATE_LOCATORS property and the specified Locator_name should be set in a configure file together with HOST, PORT properties.

The following is how to set ALTERNATE_LOCATORS property.

```
[LOCATOR]
ALTERNATE_LOCATORS = (locator_name1,locator_name2)
[locator_name1]
HOST= ip_address
PORT = port_num
[locator_name2]
HOST= ip_address
PORT = port_num
```

The following is an example of a configure file which sets ALTERNATE_LOCATORS property.

```
[LOCATOR]
PORT=42581
SYNC_RESPONSE_TIMEOUT = 2
SYNC_RETRY_COUNT = 2
LOCATION_FILE_NAME='glocator_1.dat'
ALTERNATE_LOCATORS=(LOCATOR_2,LOCATOR_3)
[LOCATOR_2]
```

```
HOST=127.0.0.1
PORT=42582
[LOCATOR_3]
HOST=127.0.0.1
PORT=42583
```



- [LOCATOR] is DSN which is read as default by glocator.
- For more information glocator-related ODBC and how to set gagent, refer to **odbc.ini File, ALTERNATE_LOCATORS**.

Synchronizing Data

The data should be consistent when the replicated glocator is in service. If glocator in operation does not exist, then all glocator can perform the normal start. If glocator in operation exists, an alternate glocator can be started by synchronizing the data using a **sync** option.

sync option has BOTH and SOURCE. BOTH merges glocator's own data and alternate glocator's data. SOURCE brings the data from the counterpart glocator. The sync operation of glocator is 1 : 1 correspondence task between a glocator and an alternate glocator. Therefore, if A and B are already being operated, and C is operated after syncing by using BOTH for the replication of three (A, B, C) glocators, then the data of A and B glocators may be different.

glocator in service synchronizes only the updated content. If the data synchronization fails due to the packet loss or other reasons, then the data may be different. In this case, update the data within that glocator by using **gloctl** program, or restart glocator with sync option.

41.3 Features of glocator

Connection Service

It provides a service feature which enables arbitrarily access any node among user-defined nodes even though the location information of a specific node in a cluster environment is unknown.

The service feature is that a user specifies nodes managed by glocator an arbitrary group. This service can be registered by using gloctl program. Service lists managed by glocator can also be viewed by using gloctl program.

An application should be accessed by using ODBC driver, and LOCATOR_DSN and LOCATOR_SERVICE pr operty should be specified in `odbc.ini` file.

Figure 1 locator_service

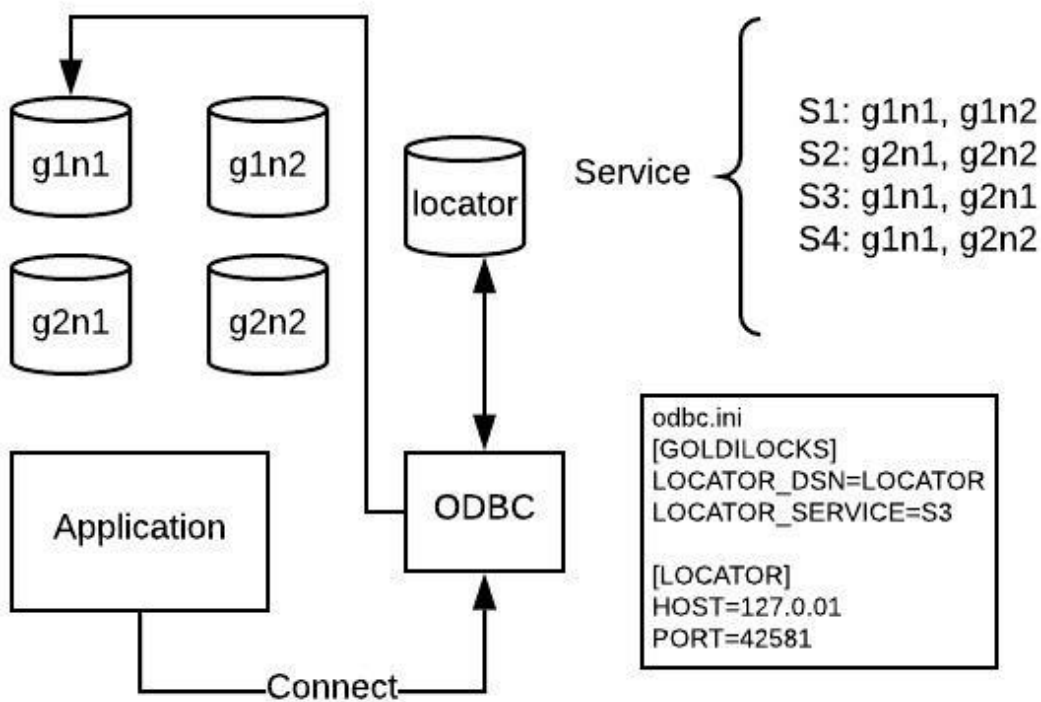

The figure above describes that an application accesses to g1n1 belonging to service s3. The connecting sequence of ODBC driver by using the service is as same as the sequence of node registered in the service. If ODBC driver fails to connect to g1n1 in the example above, it will try to connect to the next node g2n1.



To use the service feature, the valid location information of a node should be input in glocator in advance.

Cluster Failover

glocator is helpful when a server proceeds the failover.

When the value of server property **CLUSTER_SPLIT_BRAIN_RESOLUTION_POLICY** is set to 1 or 2, and connection between nodes is disconnected in a cluster environment, a failover occurs, then each node proceeds the cluster failover and queries its viability to glocator through gagent.

The glocator which received a query decides the viability between two nodes which were disconnected, and transfer the result to each node through gagent.

Nodes received the viability results are terminated or proceeds the failover.

41.4 glocator Configuration

Configuration File and Environment Variable

glocator can use a file or environment variable to set the configuration.

An environment variable can be set by using the name of which 'LOCATOR_' is added as a prefix to a configuration property name. For example, setting HOST in the configuration file has the same effect as specifying \$LOCATOR_HOST.

The contents of a configuration file takes precedence over the environment variable setting values.

glocator reads the configuration file by reading DSN as the default value of [LOCATOR].

glocator has \$GOLDILOCKS_DATA/conf/goldilocks.glocator.conf file as its environment file. To alter the driving environment of glocator, the file contents should be altered, or glocator should start after setting the environment variables.

Configuration Properties

HOST

Item	Description
Name	HOST
Description	It is an IP address of which glocator binds.
Data type	ip address (ip v4)
Default value/ range	0.0.0.0

It is an IP address of which glocator binds for UDP communication.

It uses an IP address in IP v4 form.

PORT

Item	Description
Name	PORT
Description	It is a port of which glocator waits for Recv.
Data type	INT
Default value/ range	42581 / 1024~49151

It is a port of which glocator receives a packet through UDP communication.
The port from 1024 to 49151 can be used.

WORKER_COUNT

Item	Description
Name	WORKER_COUNT
Description	It is the number of threads processing a job.
Data type	INT
Default value/ range	1 / 1~8

It is the number of threads processing packets of which glocator received from a client or an internal process.

SESSION_QUEUE_SIZE

Item	Description
Name	SESSION_QUEUE_SIZE
Description	It is the queue size in which received packets are stored before processing them.
Data type	INT
Default value/ range	33554432 / 10485760~2147483648

It is the size of queue of which glocator stores packets received from a client or or an internal process before processing them.

Packets are stored as an item of a session unit in a queue.

SESSION_ALLOCATOR_SIZE

Item	Description
Name	SESSION_ALLOCATOR_SIZE
Description	It is the size of an allocator which allocates an item to be stored in a session queue.
Data type	INT
Default value/ range	33554432 / 10485760~2147483648

It is the size of an allocator which is used to allocate an item (session) to be stored in a session queue.

PACKET_ALLOCATOR_SIZE

Item	Description
Name	PACKET_ALLOCATOR_SIZE
Description	It is the size of an allocator which allocates a packet when receiving packets through UDP communication.
Data type	INT
Default value/ range	33554432 / 10485760~2147483648

It is the size of an allocator for a buffer which is allocated for glocator to receive packets.

SYSTEM_LOGGER_DIR

Item	Description
Name	SYSTEM_LOGGER_DIR
Description	It is the directory path of glocator trace log file.
Data type	String
Default value/ range	'<GOLDILOCKS_DATA>/trc'

It is the directory path in which system trace log file of glocator is stored. <GOLDILOCKS_DATA> of the default value is replaced with the environment variable value of \$GOLDILOCKS_DATA.

SYSTEM_UDS_DIR

Item	Description
Name	SYSTEM_UDS_DIR
Description	It is the directory path in which unix domain socket file used in glocator is stored.
Data type	String
Default value/ range	'/tmp' / maximum 60 byte

It sets the directory path in which the unix domain socket file used in glocator is stored. The maximum length of the directory should be set within 60 bytes.

LOCATION_FILE_DIR

Item	Description
Name	LOCATION_FILE_DIR
Description	It is the directory path in which the location file used in glocator is stored.
Data type	String

Item	Description
Default value/ range	'<GOLDILOCKS_DATA>/db'

It sets the directory path in which the location file used in glocator is stored.

LOCATION_FILE_NAME

Item	Description
Name	LOCATION_FILE_NAME
Description	It is the name of a location file which is used in glocator.
Data type	String
Default value/ range	'glocator.dat'

It sets the name of a location file which is used in glocator.

The default value is glocator.dat.

LOCATION_FILE_SIZE

Item	Description
Name	LOCATION_FILE_SIZE
Description	It is the initial size of a location file.
Data type	Int
Default value/ range	1048576 / 104576~2147483648

It sets the initial size of a location file used in glocator.

LOCATION_FILE_MAX_SIZE

Item	Description
Name	LOCATION_FILE_MAX_SIZE
Description	It is the maximum size of a location file.
Data type	Int
Default value/ range	10485760 / 104576~2147483648

It sets the maximum size of a location file used in glocator.

SESSION_TIMEOUT

Item	Description
Name	SESSION_TIMEOUT
Description	It sets the maximum time for glocator to wait to receive packets.
Data type	Int
Default value/ range	100 / 0 ~ 2147483648(단위 Second)

It sets the maximum time (seconds) for glocator to wait to receive packets. Packets exceeds the maximum time without being processed, are dumped.

FAILOVER_TIMEOUT

Item	Description
Name	FAILOVER_TIMEOUT
Description	It sets the maximum time for glocator to process the failover request.
Data type	Int
Default value/ range	18 / 0 ~ 2147483648

It sets the maximum time for glocator to wait for packets while processing the failover request. If the time is over, then it returns an error to gagent which requested.

ALTERNATE_LOCATORS

Item	Description
Name	ALTERNATE_LOCATORS
Description	It sets an alternate locator and replication of glocator.
Data type	String
Default value/ range	empty / 0 ~ 1024 bytes

It sets **Replication** of glocator.

SYNC_RETRY_COUNT

Item	Description
Name	SYNC_RETRY_COUNT
Description	It sets the number of retry when glocator fails to synchronize with an alternate locator.
Data type	Int

Item	Description
Default value/ range	1 / 0 ~ 5

It sets the number of redelivery of glocator synchronization.

glocator transfers the altered data to alternate locator when the data is altered, and it transfers the data again when it could not get any response.

SYNC_RESPONSE_TIMEOUT

Item	Description
Name	SYNC_RESPONSE_TIMEOUT
Description	It sets the time waits for the response for the synchronization of glocator.
Data type	Int
Default value/ range	5 / 1 ~ 20

It sets the time waits for the response for the synchronization data transferred from glocator.

42.

gagent

42.1 Overview of gagent

Definition

gagent is a utility communicating with **glocator** by being executed with each member node in GOLDILO CKS cluster system.



gagent can provide location information of a local node to glocator. For the consistency of location information, glocator should be executed ahead of gagent.

Usage

```
gagent [options]
```

Options

help

Description

It outputs the help message.

Example

```
$ gagent --help
Usage:
  gagent [options]
Options:
  -s --start           Start gagent
  -t --stop           Stop gagent
  -u --status         Get gagent status
  -f --conf           Set configure file
  -o --home           gmaster home path
  -l --silent         Suppress display message
  -r --no-copyright  Suppress display copy right and version
```



```
-h --help          Print help message
```

start

Description

It starts gagent. If gagent having the same home directory already has been started, then an error occurs.

Example

```
$ gagent --start  
gagent is started.
```

stop

Description

It stops gagent which is in operation. The same home directory should be set to stop gagent in operation.

Example

```
$ gagent --stop  
gagent is stopped.
```

status

Description

It outputs the status message of gagent which is in operation. The same home directory should be set to check the status of gagent in operation.

Example

```
$ gagent --status  
gagent(31938) is running.
```

conf

Description

It sets the configure file when starting gagent.

Example

```
$ gagent --start --conf goldilocks.gagent.conf  
gagent is started.
```

home

Description

It sets the server home directory of GOLDILOCKS when starting gagent.

When a relative path is used, it searches for the home directory based on <GOLDILOCKS_DATA>. <GOLDILOCKS_DATA> is replaced with the environment variable value of \$GOLDILOCKS_DATA.

Example

```
$ gagent --start --home g1n1_home --conf goldilocks.gagent.conf  
gagent is started.
```

In the example above, gagent is started by setting <GOLDILOCKS_DATA>/g1n1_home to home.

silent

Description

It does not output the message of gagent about the execution.

Example

```
$ gagent --start --silent
```

no-copyright

Description

It does not output the message of gagent's copyright and version about the execution.

Example

```
$ gagent --start --no-copyright  
gagent is started.
```

42.2 gagent Configuration

Configuration File and Environment Variable

gagent can use a file or environment variable to set the configuration.

An environment variable can be set by using the name of which 'AGENT_' is added as a prefix to a configuration property name. For example, setting HOST in the configuration file has the same effect as specifying \$AGENT_HOST.

The contents of a configuration file takes precedence over the environment variable setting values.

gagent has \$GOLDILOCKS_DATA/conf/goldilocks.gagent.conf file as its environment file. To alter the driving environment of gagent, the file contents should be altered, or gagent should start after setting the environment variables.

Configuration Properties

HOST

Item	Description
Name	HOST
Description	It is an IP address of which gagent binds.
Data type	ip address (ip v4)
Default value/ range	0.0.0.0

It is an IP address of which gagent binds for UDP communication.

It uses an IP address in IP v4 form.

PORT

Item	Description
Name	PORT
Description	It is a port of which gagent waits for Recv.
Data type	INT
Default value/ range	43581 / 1024~49151

It is a port of which gagent receives a packet through UDP communication.
The port from 1024 to 49151 can be used.

LOCATOR_HOST

Item	Description
Name	LOCATOR_HOST
Description	It is an IP address of glocator.
Data type	ip address(ip v4)
Default value/ range	0.0.0.0

It is an IP address of glocator.

LOCATOR_PORT

Item	Description
Name	LOCATOR_PORT
Description	It is a port of which glocator waits for Recv.
Data type	INT
Default value/ range	42581 / 1024~49151

It is the port of glocator of when gagent sends packets to glocator.
The port from 1024 to 49151 can be used.

COMMAND_QUEUE_SIZE

Item	Description
Name	COMMAND_QUEUE_SIZE
Description	It is the queue size in which received packets are stored before processing them.
Data type	INT
Default value/ range	1048576 / 1048576~2147483648

It is the size of queue of which gagent stores packets received from glocator before processing them.
Packets are stored as an item of a command unit in a queue.

COMMAND_ALLOCATOR_SIZE

Item	Description
Name	COMMAND_ALLOCATOR+SIZE
Description	It is the size of an allocator which allocates an item to be stored in a command queue.
Data type	INT
Default value/ range	1048576 / 1048576~2147483648

It is the size of an allocator which is used to allocate an item (command) to be stored in a command queue.

PACKET_ALLOCATOR_SIZE

Item	Description
Name	PACKET_ALLOCATOR+SIZE
Description	It is the size of an allocator which allocates a packet when receiving packets through UDP communication.
Data type	INT
Default value/ range	1048576 / 1048576~2147483648

It is the size of an allocator for a buffer which is allocated for gagent to receive packets.

SYSTEM_LOGGER_DIR

Item	Description
Name	SYSTEM_LOGGER_DIR
Description	It is the directory path of gagent trace log file.
Data type	String
Default value/ range	'<GOLDILOCKS_DATA>/trc'

It is the directory path in which system trace log file of gagent is stored. <GOLDILOCKS_DATA> of the default value is replaced with the environment variable value of \$GOLDILOCKS_DATA.

UPDATE_LOCATION_TIME

Item	Description
Name	UPDATE_LOCATION_TIME
Description	It sets the cycle for gagent to update its location information to glocator.
Data type	Int

Item	Description
Default value/ range	120 / 30~2147483648 (second unit)

It sets the cycle for gagent to update its node location information to glocator.

SESSION_TIMEOUT

Item	Description
Name	SESSION_TIMEOUT
Description	It sets the maximum time for gagent to wait to receive packets.
Data type	Int
Default value/ range	60 / 0 ~2147483648 (second unit)

It sets the maximum time (seconds) for gagent to wait to receive packets. Packets exceeds the maximum time without being processed, are dumped.

ALTERNATE_LOCATORS

Item	Description
Name	ALTERNATE_LOCATORS
Description	It sets the alternate locators.
Data Type	String
Default value/ range	empty / 0 ~ 1024

If glocator set in gagent does not respond, then it proceeds to process the operation by replacing with an alternate locator.

The following is an example of a configure file which used ALTERNATE_LOCATOR.

```
[AGENT]
PORT=43581
LOCATOR_HOST=127.0.0.1
LOCATOR_PORT=42581
ALTERNATE_LOCATORS='LOCATOR1,LOCATOR2'
[LOCATOR1]
HOST=127.0.0.1
PORT=42582
[LOCATOR2]
HOST=127.0.0.1
PORT=42583
```

43.

gloctl

43.1 Overview of gloctl

Definition

gloctl is an interactive utility provided by GOLDILOCKS, which provides location to **glocator** and edits it. gloctl communicates with glocator by using User Datagram Protocol (UDP) communication protocol.

Usage

```
gloctl [options]
```

Options

help

Description

It outputs the help message.

Example

```
$ gloctl --help
Usage:
  gloctl [options]
Options:
  -c --conf          User configure file
  -i --ip            Locator host ip
  -p --port          Locator port number
  -o --import        Import control FILE
  -l --silent        Suppress the display of result message and echoing commands
  -r --no-copyright Suppress display copy right and version
  -h --help          Print help message
```

conf

Description

It sets a **Configuration** file to communicate with glocator.
If it is not set, \$GOLDILOCKS_DATA/conf/goldilocks.gloctl.conf is used.

Example

```
$ gloctl --conf gloctl.conf  
gLoctl>
```

- The contents of gloctl.conf file above is as follows.

```
[GLOCTL]  
# Port number (1024 ~ 49151)  
PORT = 44581  
# Locator address  
LOCATOR_HOST = 127.0.0.1  
# Locator port number (1024 ~ 49151)  
LOCATOR_PORT = 42581  
# Time out to receive message from glocator (second)  
# second ( 0 ~ 2147483647 )  
MESSAGE_TIMEOUT = 10
```

ip

Description

It sets IP address of glocator when starting gloctl. IP set value takes precedence when it is used together with DSN.

Example

```
$ gloctl --ip 127.0.0.1  
gLoctl>
```

The port of glocator in the example above is obtained by using DSN default LOCATOR in odbc.ini.

port

Description

It sets the port of glocator when starting gloctl. The port set value takes precedence when it is used together with DSN.

Example

```
$ gloctl --port 42581
gLoctl>
```

IP of glocator in the example above is obtained by using DSN default LOCATOR in odbc.ini.

import

Description

It performs gloctl commands in batch within a file, not an interactive mode.

Example

```
$ gloctl --import import.txt
HELP
QUIT
IMPORT      {'FILE'}           Upload FILE to locations
EXPORT      {'FILE'}           Download locations to FILE
ADD MEMBER  {DSN}{member_name {'host; port; db_home; agent_port;'}} Add member location
DROP MEMBER {member_name}     Drop member location
SET TIMEOUT {second}          Set time for session timeout
Add member succeeded.
```

- The contents of import.txt above is as follows.

```
HELP
ADD MEMBER G1N3 'HOST=127.0.0.1;PORT=24581;DB_HOME=g1n3_home;AGENT_PORT= 44581;'
```

silent

Description

It does not output the message of gloctl about the execution.

Example

```
$ gloctl --silent --import import.txt
```

no-copyright

Description

It does not output the message of gloctl's copyright and version about the execution.

Example

```
$ gloctl --no-copyright  
gLoctl>
```

43.2 Interactive Command References

ADD MEMBER

Syntax

```
ADD MEMBER {DSN | member_name {'host; port; db_home; agent_port;'}}
```

Description

It adds a member to glocator. DSN existing in odbc.ini, a member name, and the required location information should be input.



- The port is that of glsr.
- ADD MEMBER is used to update the information of an existing member. In this case, if the member is in the process of the failover, then the update fails.

Example

ADD MEMBER by using DSN of odbc.ini.

```
gLoctl> ADD MEMBER G1N1
Add member succeeded.
gLoctl>
```

- The contents of odbc.ini is as follows.

```
[G1N1]
HOST=127.0.0.1
PORT=20101
DB_HOME= g1n1_home
AGENT_PORT=43581
LOCATOR_DSN=LOCATOR
```

- Describe the location of a member, and add it.

```
gLoct1> ADD MEMBER G1N2 'HOST=127.0.0.1; PORT=20201; DB_HOME=g1n2_home; AGENT_PORT= 43581'  
Add member succeeded.  
gLoct1>
```

ADD SERVICE

Syntax

```
ADD SERVICE service_name {'member_name; ... '}
```

Description

It adds a service to glocator. The node belonging to the service should be managed in **glocator**, and it is ignored when the same node does not exist in glocator.

Example

Add the service *s1* by using ADD SERVICE.

```
gLoct1> ADD SERVICE S1 'G1N1;G1N2;G2N1'  
Add service succeeded.  
gLoct1>
```

- The contents of `odbc.ini` is as follows.

```
[GOLDILOCKS]  
HOST=127.0.0.1  
PORT=22581  
LOCATOR_DSN=LOCATOR  
LOCATOR_SERVICE=S1  
[LOCATOR]  
HOST=127.0.0.1  
PORT=42581
```



When describing glocator properties in **odbcinst.ini file** and using **glocator**, then `gsqlnet` and other applications can access one of a server from the service list.

DROP MEMBER

Syntax

```
DROP MEMBER member_name
```

Description

It drops a member corresponding to member_name from glocator.



If a member is in the process of the failover, then the member can not be dropped.

Example

```
gLoctl> DROP MEMBER G1N2  
Drop member succeeded.  
gLoctl>
```

DROP SERVICE

Syntax

```
DROP MEMBER service_name
```

Description

It drops a service corresponding to service_name from glocator.

Example

```
gLoctl> DROP SERVICE S1  
Drop service succeeded.  
gLoctl>
```

EXPORT

Syntax

```
EXPORT {'FILE'}
```

Description

It receives the location information from glocator and stores it in a file.

Example

Download the location information in Location.txt file.

```
gLoct1> EXPORT 'Location.txt'  
Export file succeeded.  
gLoct1>
```

- The contents of Location.txt above is as follows.

```
[G1N1]  
PORT = 20101  
AGENT_PORT = 0  
HOST = 127.0.0.1  
DB_HOME = g1n1_home  
[G1N3]  
PORT = 24581  
AGENT_PORT = 44581  
HOST = 127.0.0.1  
DB_HOME = g1n3_home
```

HELP

Syntax

```
HELP
```

Description

It displays the commands list in an interactive mode of gloctl.

Example

```
gLoctl> HELP
HELP
QUIT
IMPORT {'FILE'} Upload FILE to locations
EXPORT {'FILE'} Download locations to FILE
ADD MEMBER {DSN|{member_name {'host; port; db_home; agent_port;'}}} Add member location
DROP MEMBER {member_name} Drop member location
SET TIMEOUT {second} Set time for session timeout
ADD SERVICE {service_name {'member_name; ... '}} Add service
DROP SERVICE {service_name} Drop service
gLoctl>
```

IMPORT

Syntax

```
IMPORT {'FILE'}
```

Description

It transfers the location to glocator by using a file in ini form.

Example

It transfers the contents in Location.txt to glocator.

```
gLoctl> IMPORT 'Location.txt'
Import file succeeded.
gLoctl>
```

- The contents of Location.txt above is as follows.

```
[G1N1]
PORT = 20101
AGENT_PORT = 0
HOST = 127.0.0.1
DB_HOME = g1n1_home
[G1N3]
PORT = 24581
AGENT_PORT = 44581
HOST = 127.0.0.1
DB_HOME = g1n3_home
```

QUIT

Description

It quits gloctl.

Syntax

```
QUIT
```

SET TIMEOUT

Description

It sets TIMEOUT of glocator.

Syntax

```
SET TIMEOUT {second}
```

Example

```
gLoctl> set timeout 120
Set timeout.
gLoctl>
```

43.3 Location File

Location file uploads or downloads the location information of a node from gloctl to glocator.

Description

Location file format is similar to that of **Data Source Specification** file.

```
[node_name]
HOST = host_address
PORT = port_no
DB_HOME = db_home_path
AGENT_PORT = agent_port_no
[SERVICE]
service_name = node_name {, node_name}*
```

Location keywords of Location file are as follows.

Table 43-1 Location information

Keyword	Description
node_name	It is the name of a node.
HOST	It is the IP address of a node.
PORT	It is the port number of glsnr which was executed in a node.
DB_HOME	It sets the home directory of a node.
AGENT_PORT	It is the port number of gagent which was executed in a node.

[SERVICE] is a fixed keyword which lists the service hints. Service hints which are registered or to be registered in glocator are listed below SERVICE keyword.

HOST and PORT keywords should be input, and an error occurs if they are omitted.

The following is an example of configuring a location file.

```
[G1N1]
HOST = 192.168.0.101
PORT = 20101
DB_HOME = g1n1_home
AGENT_PORT = 40101
[G1N2]
```

```
HOST = 192.168.0.102
PORT = 20102
DB_HOME = g1n2_home
AGENT_PORT = 40102
[G2N1]
HOST = 192.168.0.201
PORT = 20201
DB_HOME = g2n1_home
AGENT_PORT = 40201
[G1N2]
HOST = 192.168.0.202
PORT = 20202
DB_HOME = g2n1_home
AGENT_PORT = 40202
[SERVICE]
service_1 = G1N1,G2N1
service_2 = G1N1,G1N2
```

43.4 Configuration

The environment file of gloctl is `$GOLDILOCKS_DATA/conf/goldilocks.gloctl.conf`. The environment file should be altered or the environment file should be set with `conf` option and restart gloctl, to alter the driving environment for gloctl.

Stop gloctl and alter the driving environment, then restart it to alter the environment of gloctl and to apply it, while gloctl is being executed.

PORT

Item	Description
Name	PORT
Description	It is a port which is used by gloctl.
Data type	INT
Default value/ range	44581 / 1024 ~ 49151

It sets the port of a socket which is used by gloctl.

LOCATOR_HOST

Item	Description
Name	PORT
Description	It is the host address of glocator with which gloctl communicates.
Data type	STRING
Default value/ range	127.0.0.1

It sets the host address of glocator.

LOCATOR_PORT

Item	Description
Name	PORT
Description	It is the port of glocator with which gloctl communicates.

Item	Description
Data type	INT
Default value/ range	42581 / 1024 ~ 49151

It sets the port of glocator.

MESSAGE_TIMEOUT

Item	Description
Name	MESSAGE_TIMEOUT
Description	It sets the time of which gloctl waits for the response from glocator. (second)
Data type	INT
Default value/ range	10 / 0 ~ 2147483647

It sets the time of which gloctl waits for the response after transferring a packet to glocator.

Part VII.

Replication

44. Overview	3,557
44.1 Overview of GOLDILOCKS Replication	3,558
44.2 Characteristics	3,559
CYCLONE	3,559
LOGMIRROR	3,559
45. CYCLONE	3,561
45.1 CYCLONE	3,562
Overview	3,562
Operational Features	3,562
Operational Restrictions	3,563
DDL Processing during Replication	3,564
Datatype Compatibility When Interworking with Other DBMS	3,565
Others	3,567
45.2 Requirements	3,568
GOLDILOCKS Requirements	3,568
Registering User and Setting Privileges	3,570
45.3 Configuration	3,573
Configuration File	3,573
Configuration Option	3,575
45.4 Operating	3,591
GOLDILOCKS Connection Policy	3,591
Executing Option	3,593
45.5 Operating Examples	3,597
Operating Order	3,597
Original GOLDILOCKS Configuration	3,598
Remote GOLDILOCKS Configuration	3,598
CYCLONE MASTER Configuration	3,598
CYCLONE SLAVE Configuration	3,599
Executing and Operating	3,599
Synchronizing Data	3,600
Initializing Replication Information	3,601
Recovery	3,602
45.6 Operating CYCLONE in Cluster	3,603
Requirements	3,603
Operating	3,603
Executing	3,604
SYNC Method	3,607
Others	3,607
45.7 Monitoring (CYMON)	3,608

Configuration File	3,608
Monitoring Contents	3,608
Executing and Monitoring	3,609
46. LOGMIRROR	3,613
46.1 LOGMIRROR	3,614
Overview	3,614
Operational Features	3,614
Performance Degradation Factors of GOLDILOCKS When Operating LOGMIRROR	3,614
46.2 Requirements	3,616
GOLDILOCKS Requirement	3,616
46.3 Configuration	3,618
Configuration File	3,618
Configuration Options	3,618
46.4 Operating	3,622
Operating LOGMIRROR	3,622
Executing Option	3,623
46.5 Examples of Interworking with CYCLONE	3,624
Operating Order	3,625

44.

Overview

44.1 Overview of GOLDILOCKS Replication

Database replication efficiently and consistently distributes data for data recovery when an error occurs in the original database by using the remote database, so that it enables sustained service. It is also used to build multiple database with same data.

GOLDILOCKS replication supports CYCLONE, which is a tool using Change Data Capture (CDC) method.



Change Data Capture (CDC)

This method captures and analyzes the redo log generated during the database operation, and performs the replication.

Only the asynchronous mode is supported because CYCLONE is available after the changes of the database are stored in the redo log file.

The interval may occur between the original database and the remote database of the replication because the CDC method supports only the asynchronous mode. When the failure of original database or equipment occurs in the state of which the replication to the remote database is not completed, the remote database is in the state of which the interval is not reflected.

LOGMIRROR can be used to complement the data not reflected due to the interval of the asynchronous mode.



LOGMIRROR is a tool which replicates the redo log files. It sends and stores the redo logs generated from the original database to the remote equipment without any loss of data. Therefore, using LOGMIRROR can prevent loss of data.

44.2 Characteristics

CYCLONE

The followings are the characteristics of CYCLONE.

- It is a replication tool which uses Change Data Capture (CDC) method.
- It recognizes, analyzes and applies the changes in redo log files of the original database.
- It is operated being divided into master and slave.
- It supports active-active, active-standby.
- Replication is available in table unit.
- Several options can be set to improve the performance.
- It does not affect GOLDILOCKS in case of failure because it is operated as an independent process.
- Adding or changing the H/W is not required for operation.
- It allows various replication topology
- The operation between master and slave in standalone environment supports the relationship of 1 : 1 or N : N.
- The operation between master and slave in cluster environment supports the relationship of N : 1.

LOGMIRROR

The followings are the characteristics of LOGMIRROR.

- It transfers and stores the redo logs of the original database to the remote machine without any loss.
- It interworks with CYCLONE and replicates without any loss of data.
- Only one LOGMIRROR can be operated in a database.
- It is operated being divided into master and slave.

45.

CYCLONE

45.1 CYCLONE

CYCLONE is a replication tool which uses the Change Data Capture (CDC) method.

Overview

Database records the data changes which occur during the operation in the redo log file for the recovery. CDC performs the replication by analyzing the information of the recorded redo log file.

CYCLONE is driven being divided into master and slave. Master recognizes the changes of the redo log file in the original database and analyzes it, then transfers it to the slave. Slave analyzes the received data and performs the replication by using ODBC.

Operational Features

- It is divided into master and slave and is operated as master/slave in group unit.
- Master and slave of CYCLONE uses TCP/ IP communication.
- It can be executed/ terminated in group unit.
- The replication is executed in table unit, and a group may include one or more tables.
- A single table may be operated being included in several groups.
- The original database should have the redo log files, so DATA_STORE_MODE should be operated in TDS.
- The original database should have SUPPLEMENTAL LOGGING.
 - SUPPLEMENTAL LOGGING adds an additional information to the redo log files for the replication of CYCLONE.
- The original database should be operated in ARCHIVE LOG mode.
 - GOLDILOCKS recursively reuses the redo log files. When the redo log files are reused before the replication is completed, the replication becomes aborted and the existing replication from the current point is canceled then restarted. Therefore, the redo log files should be operated in ARCHIVE LOG mode to be archived.
- It does not affect GOLDILOCKS even when it fails to replicate because it is operated as an independent process.

Operational Restrictions

- The table participated in the replication should have a PRIMARY KEY.
- Only the committed transaction is allowed to be replicated. Therefore, the content is unknown to the slave before committing the transaction.
- The primary key update is not supported.
 - When the primary key is updated, the table is given up and it is not replicated any more.
- The table participated in the replication can not use the column which has Generated Always As Identity property.
- When Data Definition Language (DDL) is performed on the table in which the replication is being operated, it could be given up.
 - For more information, refer to **The occurrence of give up and whether to allow DDL statement according to DDL category** in table1.
 - If it does not comply with the processing procedure of table DDL of CYCLONE, then even the allowable DDL is given up.
 - It does not affect the replication of other tables.
 - It is same in case of the truncated table.
- The given-up table can be reset only when it was given up with --reset TABLE_NAME
- The columns configuring the table participating in the replication should have the same structure.(data type, order)
- The database performing the replication should have the same character encoding.

Table 45-1 The occurrence of give up and whether to allow DDL statement according to DDL category

DDL category	Occurrence of give up	Whether to allow DDL statement	DDL statement
Table DDL	X	-	CREATE TABLE
	O	X	DROP TABLE
	O	X	TRUNCATE TABLE
	O	X	ALTER TABLE .. RENAME
	X	-	ALTER TABLE .. STORAGE
	X	-	ALTER TABLE .. ADD SUPPLEMENTAL LOG
	O	X	ALTER TABLE .. DROP SUPPLEMENTAL LOG
	X	-	ALTER TABLE .. READ { ONLY WRITE }
Column DDL	O	O	ALTER TABLE .. ADD COLUMN
	O	X	ALTER TABLE .. SET UNUSED COLUMN
	X	-	ALTER TABLE .. RENAME COLUMN
	X	-	ALTER TABLE .. ALTER COLUMN .. SET DEFAULT
	X	-	ALTER TABLE .. ALTER COLUMN .. DROP DEFAULT
	O	X	ALTER TABLE .. ALTER COLUMN .. SET NOT NULL
	O	X	ALTER TABLE .. ALTER COLUMN .. DROP NOT NULL

DDL category	Occurrence of give up	Whether to allow DDL statement	DDL statement
	O	X	ALTER TABLE .. ALTER COLUMN .. ALTER IDENTITY
	O	X	ALTER TABLE .. ALTER COLUMN .. DROP IDENTITY
	O	O	ALTER TABLE .. ALTER COLUMN .. SET DATATYPE
Constraint DDL	O	X	ALTER TABLE .. ADD CONSTRAINT
	O	X	ALTER TABLE .. DROP CONSTRAINT
	O	X	ALTER TABLE .. ALTER CONSTRAINT
	X	-	ALTER TABLE .. RENAME CONSTRAINT
Index DDL	O	X	CREATE UNIQUE INDEX
	X	-	CREATE INDEX
	O	X	DROP INDEX unique_index
	X	-	DROP INDEX non_unique_index
	X	-	ALTER INDEX .. STORAGE
	X	-	ALTER INDEX .. RENAME
Superordinate object of table	O	X	DROP USER
	O	X	DROP SCHEMA
	O	X	DROP TABLESPACE



The server property **DISABLE_DDL_CDC_GIVEUP** can disable the DDL statement which causes the replication give up to avoid user created errors.

DDL Processing during Replication

It should comply with the following procedure when the allowable DDL is performed for the table in which the replication is being performed.

1. Terminate all operating CYCLONE in master and slave before executing DDL in master.
 - The process in progress does not need to be terminated.
 - e.g. cyclone --master --stop / cyclone --slave --stop
2. Execute DDL in both master and slave. (It should be the allowable DDL.)
 - For more information, refer to **Table 45-1 The occurrence of give up and whether to allow DDL statement according to DDL category**.
3. Restart CYCLONE of master and slave.
 - cyclone --master --start ... / cyclone --slave --start ...
 - It does not require --reset option.
 - It performs the recovery from the termination of the first stage and process DDL when restarting.

(Refer to trace log)

Table 45-2 DDL application procedure

Item	MASTER CYCLONE	MASTER DB	SLAVE CYCLONE	SLAVE DB
1	CYCLONE STOP	-	-	-
2	-	-	CYCLONE STOP	-
3	-	Executing DDL	-	-
4	-	-	-	Executing DDL
5	CYCLONE START	-	-	-
6	-	-	CYCLONE START	-



If the table which executed DDL in CYCLONE master is given up after DDL application procedure is normally performed, then the following two should be checked.

1. Check if DDL performed in the master DB and in the slave DB is same, and check if the table structure is same after performing the DDL. (The order of performing DDL does not matter.)
2. Check if the performed DDL is allowable.

If the table is given up due to the reasons above, the given-up table should be replicated again from the current point by using reset in table unit and restarting it. (e.g. cyclone --start --master -reset TABLE_NAME).

Datatype Compatibility When Interworking with Other DBMS

- When target database of CYCLONE slave interworks with other DBMS instead of GOLDILOCKS, the column datatype of GOLDILOCKS table, source database, should be compatible with that of other DBMS table so that it can prevent the data loss or an error.
- Currently, it can interwork with ORACLE.

Oracle

Table 45-3 Datatype compatible with Oracle

GOLDILOCKS	Oracle	Remarks
Boolean	X	The corresponding datatype does not exist.

GOLDILOCKS	Oracle	Remarks
NATIVE_SMALLINT	NUMBER(5)	-
NATIVE_INTEGER	NUMBER(10)	-
NATIVE_BIGINT	NUMBER(19)	-
NATIVE_REAL	BINARY_FLOAT	-
NATIVE_DOUBLE	BINARY_DOUBLE	-
FLOAT	FLOAT	-
SMALLINT	NUMBER(5,0)	-
INTEGER	NUMBER(10,0)	-
BIGINT	NUMBER(19,0)	-
INT2	NUMBER(5,0)	-
INT4	NUMBER(10,0)	-
INT8	NUMBER(19,0)	-
REAL	FLOAT(24)	-
DOUBLE	FLOAT(53)	-
DOUBLE PRECISION	FLOAT(53)	-
FLOAT4	FLOAT(24)	-
FLOAT8	FLOAT(53)	-
DECIMAL	NUMERIC	-
NUMBER	NUMBER	-
NUMERIC	NUMERIC	-
CHAR	CHAR	-
VARCHAR	VARCHAR, VARCHAR2	-
BINARY	RAW	-
VARBINARY	RAW	-
DATE	DATE	-
TIME	X	The corresponding datatype does not exist.
TIMESTAMP	TIMESTAMP	-
TIMESTAMP WITH TIMEZONE	X	It does not support ODBC driver.
INTERVAL	X	It does not support ODBC driver.
LONG VARCHAR	LONG VARCHAR	-
LONG VARBINARY	LONG RAW	-

- The following four datatypes can not be replicated as described in a table above.
 - BOOLEAN
 - TIME
 - TIMESTAMP WITH TIMEZONE
 - INTERVAL

Others

The replication moments are as follows.

- At the first run, the replication starts after master and slave are performed and the initialization is terminated.
- Even if it is restarted after terminated during the replication, the replication is continuously performed from the termination point. (Recovery feature)
- It should be restarted by using --reset option when giving up the existing replication and restarting from the current point.

45.2 Requirements

Original GOLDILOCKS: It is required to perform GOLDILOCKS preparations, user registration and privilege setting all.

Remote GOLDILOCKS: It is required to perform user registration and privilege setting only.

GOLDILOCKS Requirements

The followings should be set in GOLDILOCKS before starting the replication using CYCLONE.

SUPPLEMENTAL LOGGING

SUPPLEMENTAL LOGGING stores additional information in the redo log file for the replication of CYCLONE. The database restart is required to change the settings of the database in operation, but the database restart is not required to set SUPPLEMENTAL LOGGING for a particular table.

Setting SUPPLEMENTAL LOGGING in Database

- If the GOLDILOCKS property is set as SUPPLEMENTAL LOGGING, SUPPLEMENTAL LOGGING is recorded for every table.
- GOLDILOCKS restart is required.
- The appropriate information is added or updated in the property file.
 - Property file: goldilocks.properties.conf
 - Property setting: SUPPLEMENTAL LOG_DATA_PRIMARY_KEY = YES

Setting SUPPLEMENTAL LOGGING in the Specific Table Participating in Replication

```
<add table supplemental log statement> ::=
ALTER TABLE table_name
    ADD SUPPLEMENTAL LOG DATA ( PRIMARY KEY ) COLUMNS
;
```

ARCHIVE LOG

GOLDILOCKS reuses the redo log files recursively. When GOLDILOCKS reuses the redo log file being processed by CYCLONE, then CYCLONE does not proceed and is terminated. GOLDILOCKS should be operated in ARCHIVE LOG mode to ensure the continuous replication operation.

Changing Database in Operation to ARCHIVE LOG Mode

- Restart GOLDILOCKS.
- After database is shutdown, connect with sysdba and change it to ARCHIVE LOG mode in MOUNT phase.

```
gSQL> \startup mount
Startup success
gSQL> alter database archivelog;
Database altered.
```

Setting ARCHIVE LOG Mode when Creating Database

- Update the property file before creating the database.
 - Property file: goldilocks.properties.conf
 - Property setting: ARCHIVELOG_MODE = 1



The path in which ARCHIVE LOG file is stored can be viewed and updated with 'ARCHIVELOG_DIR'.

Settings in Cluster Environment

When GOLDILOCKS in which slave is operated is operated in cluster, then either TRANSACTION_COMMIT_WRITE_MODE is '1' (Wait), or CLUSTER_ASYNC_COMMIT is 'NO'. Either of them should be set.

This prevents data confliction due to cluster's transaction policy and Cyclone's distributor policy.

Altering TRANSACTION_COMMIT_WRITE_MODE

- GOLDILOCKS should be restarted.
- Add or alter the content to the property file.
 - Property file: goldilocks.properties.conf
 - Property setting: TRANSACTION_COMMIT_WRITE_MODE = 1



If the value of TRANSACTION_COMMIT_WRITE_MODE is '0', then it is NO-WAIT, and if it is '1', then it is WAIT.

Altering CLUSTER_ASYNC_COMMIT

- Add or alter the content to the property file.
 - Property file: goldilocks.properties.conf
 - Property setting: CLUSTER_ASYNC_COMMIT = NO
- Alter property of GOLDILOCKS in operation by executing the following SQL statement.

```
gSQL> alter system set CLUSTER_ASYNC_COMMIT=NO;
System altered.
```

DATA_STORE_MODE

CYCLONE performs the replication by reading the redo log files of GOLDILOCKS. Therefore, GOLDILOCKS should be operated in Transactional Data Store (TDS) mode.

Changing DATA_STORE_MODE

- Restart the database.
- Add or update the corresponding information in the property file.
 - Property file: goldilocks.properties.conf
 - Property setting: DATA_STORE_MODE = 2



If the value of DATA_STORE_MODE is 1, it indicates Concurrent Data Store (CDS), and if it is 2, it indicates Transactional Data Store (TDS).

Registering User and Setting Privileges

CYCLONE retrieves and manipulates the required information during the operation. The user operating CYCLONE and the proper privileges for the user are required.

Creating Database User

A specific user should be added to operate CYCLONE, and the corresponding user should be added for all GOLDILOCKS of which CYCLONE is operated in master, slave mode.

```
<user definition> ::=
CREATE USER user_identifier IDENTIFIED BY password
[ DEFAULT TABLESPACE tablespace_name ]
```

```

[ TEMPORARY TABLESPACE tablespace_name ]
[ INDEX TABLESPACE {tablespace_name|NULL} ]
[ <schema clause> ]
;
<schema clause> ::=
    WITH SCHEMA [schema_name]
    | WITHOUT SCHEMA

```

The following is an example of creating the user `cdc_user` with the password `cdc_password`.

```
gSQL> CREATE USER cdc_user IDENTIFIED BY cdc_password;
```

Database Privileges

Granting the User's Access Privilege

The following is an example for granting the access privilege to `cdc_user`. It should be set on all GOLDILOCKS which is operated in both master/ slave mode.

```
gSQL> GRANT CREATE SESSION ON DATABASE TO cdc_user;
```

Granting the Privilege for Altering Table

The following is an example of granting the table updating privilege to `cdc_user`. It is set on GOLDILOCKS which is operated in slave mode.

```
gSQL> GRANT INSERT ANY TABLE, DELETE ANY TABLE, UPDATE ANY TABLE ON
DATABASE TO cdc_user;
```

Tablespace Privileges

The privileges on the data tablespace and temporary tablespace should be set. The following is an example of granting the privilege for using the default tablespace to `cdc_user`. It is set on GOLDILOCKS which is operated in slave mode.

```
gSQL> GRANT CREATE OBJECT ON TABLESPACE mem_data_tbs TO cdc_user;
gSQL> GRANT CREATE OBJECT ON TABLESPACE mem_temp_tbs TO cdc_user;
```

Schema Privileges

The schema privileges for creating and managing meta managed in CYCLONE should be set. The following is an example granting the schema privilege to `cdc_user`. It is set on GOLDILOCKS which is operated in slave mode.

```
gSQL> GRANT CREATE TABLE, CREATE INDEX, CREATE SEQUENCE, CREATE VIEW,  
ADD CONSTRAINT ON SCHEMA cdc_user TO cdc_user;
```

45.3 Configuration

Configuration File

When performing CYCLONE, the information and options required for operating are set by using the configuration file.

- When a specific configuration file is not set by using the --conf option, a specific file in the \$GOLDILOCKS_DATA/conf directory is read. cyclone.master.conf file is read when it is operated in master mode and cyclone.slave.conf file is read when it is operated in slave mode.

Table 45-4 Configuration file options

Name	Description	Coverage
COMM_CHUNK_COUNT	It sets the size of BUFFER for communication.	Master/ slave
DSN	It sets Data Source Name.	Master/ slave
GROUP_NAME	It sets the group name.	Master/ slave
HOST_IP	It sets the host IP address of which GOLDILOCKS operates.	Master/ slave
HOST_EXTERNAL_IP	It is used when slave GOLDILOCKS IP to which the cyclone master is to be connected is different from HOST_IP. (When master and slave are on wan section.)	Slave
HOST_PORT	It sets the host port of which GOLDILOCKS operates.	Master/ slave
PORT	It sets the port for master/ slave communication.	Master/ slave
USER_ID	It sets the user name.	Master/ slave
USER_PW	It sets the user password.	Master/ slave
USER_ENCRYPT_PW	It sets the encrypted password for DB user.	Master/ slave
CAPTURE_TABLE	It sets the table to be replicated.	Master
LOG_PATH	It is used when interworking with LOGMIRROR and it sets the location of the redo log file.	Master
PROTOCOL	It sets the connection type which is to be connected to GOLDILOCKS. (DA or TCP)	Master/ slave
READ_LOG_BLOCK_COUNT	It sets the amount of data to be read at a time when operating CAPTURE.	Master
TRANS_SORT_AREA_SIZE	It sets the size of the BUFFER to be allocated to CAPTURE.	Master
TRANS_FILE_PATH	It sets the location in which the temporarily generated file is to be stored when operating CAPTURE.	Master
SYNCHER_COUNT	It is applied when using SYNC feature, and it sets the number of SYNCHERs simultaneously performing the data insertion.	Master

Name	Description	Coverage
SYNC_ARRAY_SIZE	It is applied when using SYNC feature, and it sets the array size which insert data at a time.	Master
GIVEUP_INTERVAL	If the replication performance speed is lower than GOLDILOCKS performance, it is set to stop the replication.	Master
APPLIER_COUNT	It sets the number of APPLIER simultaneously performed during the replication.	Slave
APPLY_COMMIT_SIZE	It sets the maximum size for COMMIT during the replication.	Slave
APPLY_TABLE	It sets the table to which the replicated table is to be applied.	Slave
MASTER_IP	It sets the IP address of the equipment of which CYCLONE master is operated.	Slave
PROPAGATE_MODE	It sets whether to propagate the data applied by CYCLONE.	Slave
UPDATE_APPLY_MODE	It distinguishes the operation when updating. (The default value is 0.) <ul style="list-style-type: none"> 0: It is updated only when the primary keys are same. 1: It is updated only when the primary key and the value before the update are same. 2: It is updated only when the primary keys are same. It compares the value before and after the update, then leaves a log if the values are different. 	Slave
TCP_NODELAY	It sets TCP_NODELAY option of a socket. (The default value is 1.) <ul style="list-style-type: none"> 0: TCP_NODELAY off 1: TCP_NODELAY on 	Master
HEARTBEAT_TIMEOUT	It sets the maximum time (second) maintaining connection if the connection is not smooth due to network disconnection or system error after replication connection.	Master/ slave
LOG_CAPTURE_INTERVAL_1	It sets the execution cycle of capture. If the value is not changed after executing 10 times with that value, then it is converted to the value of LOG_CAPTURE_INTERVAL_2 and performs capture. (The default value is 0.2 seconds.)	Master
LOG_CAPTURE_INTERVAL_2	It sets the execution cycle of capture. If the value is not changed after executing with the value of LOG_CAPTURE_INTERVAL_1, then it sets the execution cycle of capture. (The default value is 1 second.)	Master
CLUSTER	It specifies the connection information of a master when the master is in cluster environment. A master consists of the following three information. <ul style="list-style-type: none"> ID: It is a delimiter and sets to 1 or more value. MASTER_IP PORT 	Slave
ORACLE_DRIVER	It specifies the file location of the oracle driver provided by Oracle.	Slave
PACKET_COMPRESSION_MODE	It sets whether to compress the data of communication of master and slave. (1: Enable, 0: Disable, Default: Enable)	Master

Configuration Option

COMM_CHUNK_COUNT

- It sets the number of buffers(chunk) used in data communication between master and slave of CYCL ONE.
- It allocates the resource with $16M * N$ (the set value).
- The default value is 32, and the actual size is $16M * 32 = 512 M$.
- The minimum value is 10.
- It can be set in master and slave.
 - If too small value is set so the buffer is not enough, the performance becomes poor.
- Settings applied to all groups

```
COMM_CHUNK_COUNT = 10
```

- Settings applied to a specific group

```
GROUP_NAME = testGROUP
{
    COMM_CHUNK_COUNT=20
    ....
    ....
}
```

DSN

- It sets the data source name which is required when connecting to GOLDILOCKS.
- It can be set in master and slave.
- The default value is GOLDILOCKS.
- Settings applied to all groups

```
DSN=GOLDILOCKS
```

- Settings applied to a specific group

```
GROUP_NAME = testGROUP
{
    DSN=GOLDILOCKS
    ....
}
```

```

}
    ....
}

```

GROUP_NAME

- It is necessary for distinguishing the CYCLONE operation within the equipment and it is a unit of generating the operation process.
- It is the delimiter of when starting or terminating CYCLONE in group unit.
- After it is set, it should not be changed. If changed, it is regarded as a new group.
- It can be set in master and slave.
 - The connection between master and slave is separated not by GROUP_NAME but by PORT.
 - GROUP_NAME should be unique in the same equipment.
- The braces { } should be used.

```

GROUP_NAME = testGROUP
{
    ....
    ....
}

```

HOST_IP

- It sets the IP address of GOLDILOCKS to be connected by CYCLONE.
- It can be set in master and slave.
 - It is valid only when PROTOCOL is set to TCP.
- Settings applied to all groups

```

HOST_IP = 127.0.0.1

```

- Settings applied to a specific group

```

GROUP_NAME = testGROUP
{
    HOST_IP = 127.0.0.1
    ....
    ....
}

```

HOST_EXTERNAL_IP

- It can be set in slave.
- CYCLONE master access GOLDDILOCKS of the slave's side when it is operated in sync, and it is used if slave GOLDDILOCKS IP to which the cyclone master is to be connected is different from HOST_IP.
 - It is used when IP on lan and IP on wan is different because master and slave are on wan section.
 - CYCLONE slave transfers this value to CYCLONE master, and it is used in CYCLONE master.
- Settings applied to all groups

```
HOST_EXTERNAL_IP = 192.168.0.120
```

- Settings applied to a specific group

```
GROUP_NAME = testGROUP
{
    HOST_EXTERNAL_IP = 192.168.0.120
    ....
    ....
}
```

HOST_PORT

- It sets the port of GOLDDILOCKS to be connected by CYCLONE.
- It should be set together with HOST_IP.
- It can be set in master and slave.
- Settings applied to all groups

```
HOST_PORT = 22531
```

- Settings applied to a specific group

```
GROUP_NAME = testGROUP
{
    HOST_PORT = 22531
    ....
    ....
}
```

PORT

- It sets the PORT used in the communication between master and slave.
- The duplicated PORT should not be set between the groups, and the unique value should be used for each GROUP.
- It is mandatory be set and it can be set only within GROUP_NAME.
- It can be set only within a group.

```
GROUP_NAME = testGROUP
{
    PORT = 21102
    ....
    ....
}
```

USER_ID

- It sets the user ID required to access GOLDILOCKS.
- It can be set in master and slave.
- Settings applied to all groups

```
USER_ID = testID
```

- Settings applied to a specific group

```
GROUP_NAME = testGROUP
{
    USER_ID = testID
    ....
    ....
}
```

USER_PW

- It sets the user password required to access GOLDILOCKS.
- It can be set in master and slave.
- Settings applied to all groups

```
USER_PW = testPW
```

- Settings applied to a specific group

```
GROUP_NAME = testGROUP
{
    USER_PW = testPW
    ....
    ....
}
```

USER_ENCRYPT_PW

- It sets the user password which is required for the access to GOLDDILOCKS by encrypting.
- It is used instead of USER_PW.
- Encrypted user password is created by [cyclone --encrypt *user password* --key *the key to be encrypted*].
- If this value is used, then --key option should be used when executing cyclone. (In this case, the key value as same as that created with --encrypt should be used.
- Settings applied to all groups

```
USER_ENCRYPT_PW = 't33KImiqvhqNyfN+uZmFrw=='
```

- Settings applied to a specific group

```
GROUP_NAME = testGROUP
{
    USER_ENCRYPT_PW = 't33KImiqvhqNyfN+uZmFrw=='
    ....
    ....
}
```

CAPTURE_TABLE

- It sets the table to be replicated.
 - It is set in *schema_name.table_name* format.
- It can set only in master.
- It can be set only within a group.
- When specifying several tables, the parentheses () should be used.

```
GROUP_NAME = testGROUP
{
  CAPTURE_TABLE =
  (
    testSchema1.testTable1,
    testSchema1.testTable2,
    testSchema2.testTable1
  )
}
```

LOG_PATH

- It is used when interworking with LOG MIRROR.
- It sets the path of the redo log files stored by LOGMIRROR.
 - The absolute path should be used.
 - The path should be specified by using single quote (').
- Settings applied to all groups

```
LOG_PATH = '/data/wal/'
```

- Settings applied to a specific group

```
GROUP_NAME = testGROUP
{
  LOG_PATH = '/data/wal/'
  ....
  ....
}
```

PROTOCOL

- It sets the type to connect to GOLDDLOCKS in operation.
- It can be set to DA or TCP.
- If PROTOCOL is set to DA, neither HOST_IP nor is HOST_PORT used when accessing to GOLDDLOCKS.
 - However, in a slave, HOST_IP and HOST_PORT can be used for SYNC even when PROTOCOL is DA.
- The default value is DA.
- Settings applied to all groups

```
PROTOCOL = DA
```

- Settings applied to a specific group

```
GROUP_NAME = testGROUP
{
    PROTOCOL = DA
    ....
    ....
}
```

READ_LOG_BLOCK_COUNT

- It sets the number of the log blocks to be read at a time when capturing redo log file.
- It can be set only in master.
- The size of a log block is 512 bytes.
- The default value is 40960, and the actual read size is 20 MBytes.
 - The minimum value is 100.
- Settings applied to all groups

```
READ_LOG_BLOCK_COUNT = 1024
```

- Settings applied to a specific group

```
GROUP_NAME = testGROUP
{
    READ_LOG_BLOCK_COUNT = 1024
    ....
    ....
}
```

TRANS_SORT_AREA_SIZE

- It sets the memory space required for capturing the redo log files.
- It can be set only in master.
- The unit is MB (megabytes).
- The default value is 500 MB.
 - The minimum value is 10 MB.
- If the value is set too small, the performance becomes poor.

- Settings applied to all groups

```
TRANS_SORT_AREA_SIZE = 300
```

- Settings applied to a specific group

```
GROUP_NAME = testGROUP
{
    TRANS_SORT_AREA_SIZE = 300
    ....
    ....
}
```

TRANS_FILE_PATH

- If a space bigger than TRANS_SORT_AREA_SIZE is required, the temporary file is created. It sets the path in which the temporary file is to be stored.
 - The absolute path should be used.
 - The path should be specified by using single quote (').
- It can be set only in master.
- Settings applied to all groups

```
TRANS_FILE_PATH = '/data/TmpTrans'
```

- Settings applied to a specific group

```
GROUP_NAME = testGROUP
{
    TRANS_FILE_PATH = '/data/TmpTrans'
    ....
    ....
}
```

SYNCHER_COUNT

- It is used for synchronization.
 - It sets the number of SYNCHERs participating in synchronization.
 - It is input in the number unit.
- It is set only in master.

- Settings applied to all groups

```
SYNCHER_COUNT = 8
```

- Settings applied to a specific group

```
GROUP_NAME = testGROUP
{
    SYNCHER_COUNT = 8
    ....
    ....
}
```

SYNC_ARRAY_SIZE

- It is used for synchronization.
 - It sets the unit of record to be inserted at a time when performing synchronization.
 - It is input in the number unit.
- It can be set only in master.
- Settings applied to all groups

```
SYNC_ARRAY_SIZE = 1000
```

- Settings applied to a specific group

```
GROUP_NAME = testGROUP
{
    SYNC_ARRAY_SIZE = 1000
    ....
    ....
}
```

GIVEUP_INTERVAL

- It gives up the replication and terminates CYCLONE if the INTERVAL between GOLDLOCKS and CYCLONE is bigger than the set value.
 - It is input in the number of REDO LOG BLOCK unit.
- It can be set only in master.
- Settings applied to all groups

```
GIVEUP_INTERVAL = 10000
```

- Settings applied to a specific group

```
GROUP_NAME = testGROUP
{
    GIVEUP_INTERVAL = 10000
    ....
    ....
}
```

APPLIER_COUNT

- It sets the number of APPLIER executing replication.
 - It indicates a parallel factor.
- The default value is 6, and 6 sessions are created.
 - The maximum value is not limited, but too high value can cause the contention between APPLIERS.
 - The set value significantly affects on performance.
 - The session is created according to the set value and the replication is simultaneously performed.
- It can be set only in slave.
- Settings applied to all groups

```
APPLIER_COUNT = 16
```

- Settings applied to a specific group

```
GROUP_NAME = testGROUP
{
    APPLIER_COUNT = 16
    ....
    ....
}
```

APPLY_COMMIT_COUNT

- It sets the number of transaction executing COMMIT when the replication is performed.
 - It executes COMMIT after performing the transaction once when replicating transactions committed in the original database to the remote database.
 - The set value indicates the maximum value.

- The set value affects on performance.
- It can be set only in slave.
- Settings applied to all groups

```
APPLY_COMMIT_COUNT = 1000
```

- Settings applied to a specific group

```
GROUP_NAME = testGROUP
{
    APPLY_COMMIT_COUNT = 1000
    ....
    ....
}
```

APPLY_TABLE

- It sets the table to which the replicated table is to be applied.
 - It is set in *replicating table name TO table name to which the replicated table is applied* format.
 - The table names are not necessary to be same.
- It can be set only in slave.
- It can be set only within a group.
- The parentheses () should be used when specifying several tables.

```
GROUP_NAME = testGROUP
{
    APPLY_TABLE =
    (
        testSchema1.testTable1 TO testSchema1.testTable1,
        testSchema1.testTable2 TO testSchema2.testTable3,
        testSchema2.testTable3 TO testSchema2.testTable4
    )
}
```

MASTER_IP

- It sets the IP address of the device which CYCLONE master operates.
- It can be set only in slave.
- Settings applied to all groups

```
MASTER_IP = 192.168.0.100
```

- Settings applied to a specific group

```
GROUP_NAME = testGROUP
{
    MASTER_IP = 192.168.0.100
    ....
    ....
}
```

PROPAGATE_MODE

- If CYCLONE is circularly configured, it sets whether or not another CYCLONE applies the transactions of which a CYCLONE applied.
- It can be set only in slave.
 - The default value is '0' and it does not PROPAGATE.
 - If it is set to 1, it is PROPAGATED. If it is set to 0, it is not PROPAGATED.
- Settings applied to all groups

```
PROPAGATE_MODE = 1
```

- Settings applied to a specific group

```
GROUP_NAME = testGROUP
{
    PROPAGATE_MODE = 1
    ....
    ....
}
```

UPDATE_APPLY_MODE

- It is used for the update operation in slave.
 - 0: If only the primary keys are same, the update operation is performed. (The default value)
 - 1: If the primary key is same with the value of before updating, the update operation is performed.
 - 2: If only the primary keys are same, the update operation is performed. The values before and after updating are compared and if they are different, then it leaves the logs.
- If it is set to 0, the previous value is not checked and the update is performed.

- If it is set to 1 and the previous value is different, the update is failed and leaves the conflict log.
- If it is set to 2 and the previous value is different, the update is succeeded and leaves the conflict log.
- Settings applied to all groups

```
UPDATE_APPLY_MODE = 1
```

- Settings applied to a specific group

```
GROUP_NAME = testGROUP
{
    UPDATE_APPLY_MODE = 1
    ....
    ....
}
```



For a column whose data type is long varchar or long varbinary, then only the lengths are compared for the performance reason.

TCP_NODELAY

- It is used only in master.
- It sets TCP_NODELAY option for the CDC transfer socket. (This option does not affect the sync. It is fixed to TCP_NODELAY on.)
 - 0: It offs the socket TCP_NODELAY option.
 - 1: It ons the socket TCP_NODELAY option. (Default)
- Settings applied to all groups

```
TCP_NODELAY = 1
```

- Settings applied to a specific group

```
GROUP_NAME = testGROUP
{
    TCP_NODELAY = 1
    ....
    ....
}
```

HEARTBEAT_TIMEOUT

- It can be set in master and slave.
- It sets the maximum time (second) maintaining connection if the connection is not smooth due to network disconnection or system error after replication connection between master and slave.
- The default value is 30 (seconds).
 - The minimum value is 10 (seconds).
- Settings applied to all groups

```
HEARTBEAT_TIMEOUT = 40
```

- Settings applied to a specific group

```
GROUP_NAME = testGROUP
{
    HEARTBEAT_TIMEOUT = 40
    ....
    ....
}
```

LOG_CAPTURE_INTERVAL_1

- It can be set in master.
- It sets the execution cycle of capture operated in master. The execution cycle is set in millisecond.
- It is used to quickly detect the changes of the redo log file.
- If the value of redo log file is not changed after executing 10 times with that value, then it is converted to the value of LOG_CAPTURE_INTERVAL_2 and performs capture.
- The default value is 200 (0.2 seconds), and the unit is millisecond.
- Settings applied to all groups

```
LOG_CAPTURE_INTERVAL_1 = 200
```

- Settings applied to a specific group

```
GROUP_NAME = testGROUP
{
    LOG_CAPTURE_INTERVAL_1 = 200
    ....
    ....
}
```

LOG_CAPTURE_INTERVAL_2

- It can be set in master.
 - It sets the execution cycle of capture operated in master. The execution cycle is set in millisecond.
 - It is used to quickly detect the changes of the redo log file.
 - If the value of redo log file is not changed after executing 10 times with the value of LOG_CAPTURE_INTERVAL_1, then it is converted to the corresponding value and performs capture.
 - The default value is 1000(1 second), and the unit is millisecond.
- Settings applied to all groups

```
LOG_CAPTURE_INTERVAL_2 = 1000
```

- Settings applied to a specific group

```
GROUP_NAME = testGROUP
{
    LOG_CAPTURE_INTERVAL_2 = 1000
    ....
    ....
}
```

CLUSTER

- It can be set in slave.
 - It sets the connection information of N masters which is operated in cluster environment. (It consists of ID, MASTER_IP and PORT information.)
 - ID: It is an identifier of master in slave, and only number can be input. Once the value is set, it should not be altered.
 - MASTER_IP: It sets IP in which master is being operated.
 - PORT: It sets port in which master is being operated.
- Cluster can be set only within a group.

```
GROUP_NAME = testGROUP
{
    CLUSTER = (ID=1, MASTER_IP=192.0.0.100, PORT=21102),
              (ID=2, MASTER_IP=192.0.0.101, PORT=21103)
    ....
    ....
}
```

ORACLE_DRIVER

- It can be set in slave.
- It specifies the location and name of ODBC driver file provided by Oracle.
 - Currently it supports Oracle 11g only.
- It can be set in any group.

```
ORACLE_DRIVER = '/app/oracle/product/11.2.0/db_1/lib/libsqora.so.11.1'  
GROUP_NAME = testGROUP  
{  
    ....  
    ....  
}
```

PACKET_COMPRESSION_MODE

- It can be set in master.
- It sets whether to compress the data which is transferred from master to slave.
 - 1: Enable (Default)
 - 0: Disable
- It can be set in a specific group.

```
GROUP_NAME = testGROUP  
{  
    PACKET_COMPRESSION_MODE = 1  
    ....  
    ....  
}
```

45.4 Operating

CYCLONE can be operated in D/A or C/S environment of GOLDDILOCKS.

CONFIG file or PROTOCOL configuration of ODBC.INI should be used according to the environments as follows. CONFIG configuration takes precedence over ODBC.INI configuration.

Table 45-5 CONFIG, ODBC.INI

Configuration	Description
PROTOCOL=DA	It is used in D/A environment. (Default)
PROTOCOL=TCP	It is used in C/S environment.

The running contents during the operation can be viewed through trace log.

Item	File
Cyclone master	\$GOLDDILOCKS_DATA/trc/cyclone_master.trc
Cyclone slave	\$GOLDDILOCKS_DATA/trc/cyclone_slave.trc



For more information about error message and its handling method stored in trace log, refer to **Troubleshooting of CYCLONE**.

GOLDDILOCKS Connection Policy

It is the policy for CYCLONE to connect to GOLDDILOCKS.

There are two ways to connect to GOLDDILOCKS. One is that CYCLONE connects to local GOLDDILOCKS, and the other is that CYCLONE master remotely connects to slave side GOLDDILOCKS on the slave's side when performing SYNC. Both use CYCLONE config value is preferentially used, then use odbc.ini. However, when performing SYNC, PROTOCOL value is ignored and it is set to TCP no matter what.

The config properties relating to GOLDDILOCKS connection are DSN, PROTOCOL, HOST_IP, HOST_EXTERNAL_IP, HOST_PORT, USER_ID, USER_PW.

(USER_ENCRYPT_PW is listed as USER_PW because it replaces USER_PW.)

Correct Examples

- It is available just with USER_ID and USER_PW because it is connected as D/A.

Item	File
CONFIG	USER_ID=test, USER_PW=test
GOLDILOCKS configuration of odbc.ini	-

- The information should exist either in CONFIG or in odbc.ini. HOST_IP and HOST_PORT are ignored because it is operated in D/A.

Item	File
CONFIG	HOST_IP=127.0.0.1, HOST_PORT=22581, USER_ID=test
GOLDILOCKS configuration of odbc.ini	USER_PW=test

- USER_ID is operated with the test account because it is connected with TCP and CONFIG takes precedence.

Item	File
CONFIG	PROTOCOL=TCP, USER_ID=test, USER_PW=test
GOLDILOCKS configuration of odbc.ini	HOST_IP=127.0.0.1, HOST_PORT=22581, USER_ID=test2, USER_PW=test2

- HOST_EXTERANL_IP can not be set in slave even though it is connected as D/A.

Item	File
CONFIG	PROTOCOL=DA, HOST_EXTERNAL_IP=192.168.0.10, USER_ID=test
GOLDILOCKS configuration of odbc.ini	HOST_IP=127.0.0.1, HOST_PORT=22581, USER_PW=test

Wrong Examples

- It is connected as D/A, but USER_PW does not exist.

Item	File
CONFIG	HOST_EXTERNAL_IP=192.168.0.10
GOLDILOCKS configuration of odbc.ini	PROTOCOL=DA, USER_ID=test

- It is connected as TCP, but HOST_IP does not exist.

Item	File
CONFIG	HOST_EXTERNAL_IP=192.168.0.10, USER_ID=test
GOLDILOCKS configuration of odbc.ini	PROTOCOL=TCP, HOST_PORT=22581,USER_PW=test

Executing Option

CYCLONE should be used with the following options at run-time.

Table 45-6 Executing options

Option	Description	Remarks
--start -s	It starts CYCLONE.	It should be used together with --master --slave.
--stop -t	It terminates CYCLONE.	It should be used together with --master --slave.
--master -m	It is performed in master mode.	It should be used together with --start --stop.
--slave -l	It is performed in slave mode.	It should be used together with --start --stop.
--status -u	It displays the operating status of CYCLONE.	It should be used together with --master --slave.
--conf -c	It sets the path of configuration file which is required when executing CYCLONE.	It is input in --conf CONFIG_FILE format. It should be used together with --start. If it is not explicitly set, master uses \$GOLDILOCKS_DATA/cyclone.master.conf, and slave uses \$GOLDILOCKS_DATA/cyclone.slave.conf.
--silent -i	It sets not to output messages.	-
--reset -r	It resets operational information of the replication.	It is input in --reset TABLE_NAME or --reset all format. It should be described within a single quote (') when resetting multiple tables.
--group -g	It sets a specific group.	It is input in --group GROUP_NAME format.
--help -h	It outputs the help message.	
--sync -n	It performs data synchronization.	It should be used together with --master --slave.
--encrypt -e	It encrypts the user password with the given key.	-
--key -k	It sets the encryption key when performing the --encrypt option. If USER_ENCRYPT_PW is used in the config, it sets the decryption key.	-
--info -o	It displays the status of the table which is currently being replicated.	It should be used together with --master, --group.
--recovery -v	It is used when passing the replication being performed in a standalone mode of cluster environment to another cluster member.	It is used in --recovery GROUP_NAME form, and GROUP_NAME describes CYCLONE GROUP_NAME of a slave which was previously performed.

Option	Description	Remarks
<code>--stand-alone -S</code>	It is operated in a standalone mode of cluster environment. (It is operated in a cluster mode in cluster environment.)	It is valid only in master. (It is set in the configuration file in slave.)
<code>--local -a</code>	It is used when synchronizing the table sharded in cluster environment. It synchronizes only the data in the corresponding cluster group.	It should be used together with <code>--sync</code> .

- It executes all groups in master mode by using the default environment file.

```
prompt> cyclone --master --start
```

- It terminates all groups in master mode.

```
prompt> cyclone --master --stop
```

- It executes all groups in slave mode by using the default environment file.

```
prompt> cyclone --slave --start
```

- It terminates all groups in slave mode.

```
prompt> cyclone --slave --stop
```

- It executes only the TEST_GROUP group in master mode.

```
prompt> cyclone --master --start --group TEST_GROUP
```

- It terminates only TEST_GROUP group among the groups operated in master mode.

```
prompt> cyclone --master --stop --group TEST_GROUP
```

- It sets the TEST_CONFIG file in slave mode and executes it.

```
prompt> cyclone --slave --start --conf TEST_CONFIG
```

- It encrypts GOLDBLOCKS user password.

```
prompt> cyclone --encrypt test --key 1234
Cyclone Encrypted Passwd : 'YFH+bpBNvk='
```

- USER_ENCRYPT_PW is set in the config.

```
prompt> cyclone --master --start --key 1234
```

- It deletes the existing replications of master and slave, and newly starts it.

```
prompt> cyclone --master --start --reset all
```

```
prompt> cyclone --slave --start --reset all
```

- It deletes the existing replications of only the tables T1, T2 in master, and starts it newly from the current point.

```
prompt> cyclone --master --start --reset 'T1, T2'
```

```
prompt> cyclone --slave --start
```

- It displays the current replication status per each table on master side.

```
prompt> cyclone --master --info --group GROUP1
```

```
=====
GROUP NAME = GROUP1
=====
SCHEMA NAME      : PUBLIC
TABLE NAME       : T1 (GIVE-UP (DDL-LSN:129541))
PHYSICAL ID      : 5299989643264
=====
SCHEMA NAME      : PUBLIC
TABLE NAME       : T2 (ACTIVE (CAPTURE-START-LSN:128922))
PHYSICAL ID      : 35549444308992
=====
SCHEMA NAME      : PUBLIC
TABLE NAME       : T3 (ACTIVE (CAPTURE-START-LSN:128922))
PHYSICAL ID      : 35558034243584
=====
SCHEMA NAME      : PUBLIC
TABLE NAME       : T4 (ACTIVE (CAPTURE-START-LSN:128922))
PHYSICAL ID      : 35566624178176
=====
TOTAL   COUNT : 4
GIVE-UP COUNT : 1
=====
```



For more information about examples of adding/deleting node or group, refer to **Adding and Deleting Nodes**.

For more information about examples of initializing replication, refer to **Initializing Replication**.

45.5 Operating Examples

The structure of operating CYCLONE is as follows.

Figure 1 The structure of operating CYCLONE

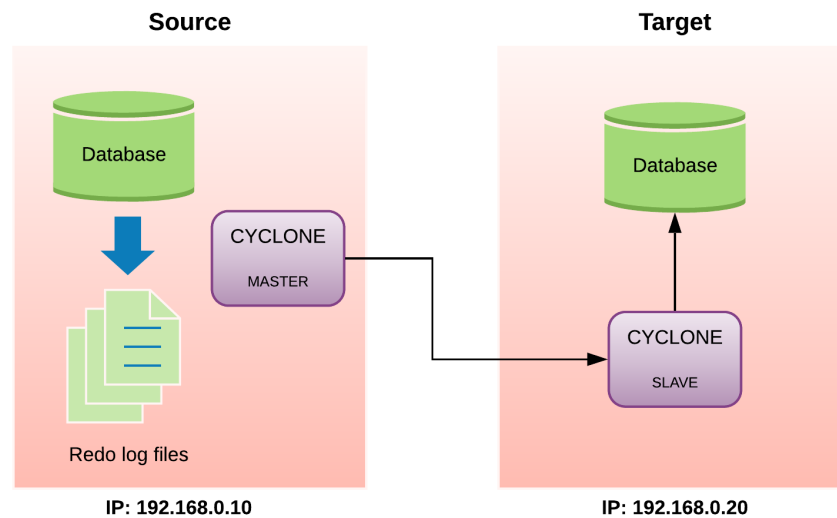

- Device structure
 - The source device which is the original data
 - GOLDBLOCKS IP : 192.168.0.10
 - GOLDBLOCKS port : 22581
 - The table to be replicated: T1, T2
 - The remote target device for replication
 - GOLDBLOCKS IP: 192.168.0.20
 - GOLDBLOCKS port: 22581

Operating Order

1. Set the original GOLDBLOCKS environment.
2. Set the remote GOLDBLOCKS environment.
3. Set the CYCLONE MASTER environment.
4. Set the CYCLONE SLAVE environment.
5. Execute and operate it.

Original GOLDILOCKS Configuration

Execute all described **Requirements**.

Create tables T1, T2 for testing.

```
gSQL > CREATE TABLE T1( COL1 INTEGER PRIMARY KEY, COL2 VARCHAR(20) );
gSQL > CREATE TABLE T2( COL1 INTEGER PRIMARY KEY, COL2 VARCHAR(20) );
gSQL > COMMIT;
```

Remote GOLDILOCKS Configuration

Execute **Registering User and Setting Privileges**.

CYCLONE MASTER Configuration

- CYCLONE MASTER configuration file
 - Storing path: \$GOLDILOCKS_DATA/conf/cyclone.master.conf
 - It is the source device.
- It is connected with D/A of the same device, so HOST information does not exist.

```
USER_ID = cdc_user
USER_PW = cdc_password
GROUP_NAME = GROUP1
{
    PORT = 21102
    CAPTURE_TABLE =
    (
        T1,
        T2
    )
}
```

CYCLONE SLAVE Configuration

- CYCLONE SLAVE configuration file
 - Storing path: `$GOLDILOCKS_DATA/conf/cyclone.slave.conf`
 - It is the target device.
- It is connected with D/A of the same device, but `HOST_IP` and `HOST_PORT` are used for SYNC.

```
USER_ID = cdc_user
USER_PW = cdc_password
HOST_IP = 192.168.0.20
HOST_PORT = 22581
GROUP_NAME = GROUP1
{
    PORT = 21102
    APPLY_TABLE =
    (
        T1 TO T1,
        T2 TO T2
    )
}
```

Executing and Operating

- Execute CYCLONE master.
 - It should be executed in the source device.

```
cyclone --master --start --conf $GOLDILOCKS_DATA/conf/cyclone.master.conf
```

- Execute CYCLONE SLAVE.
 - It should be executed in the target device.

```
cyclone --slave --start --conf $GOLDILOCKS_DATA/conf/cyclone.slave.conf
```

Synchronizing Data

- Synchronizing data
 - It copies all data from the master to the slave, and it performs the replication.
 - It copies the table data in the master to be replicated to the table in the slave when performing data synchronization.
- It should be performed after giving --sync option to both master and slave when starting the operation.
 - --sync all is used to sync all tables, and --sync TABLE_NAME is used to sync a specific table.
 - The table name of master is described in TABLE_NAME. (The table name of master should be described in TABLE_NAME even when it is operated in slave.)
- HOST_IP (or HOST_EXTERNAL_IP) and HOST_PORT should be set in CONFIG or odbc.ini of slave though it is D/A.



- If there is data in the slave table participating in the replication, data synchronization may not be properly performed due to duplicated PK. Therefore, the user should manually delete the data from the slave table before data synchronization.
- When data synchronization is performed by using the --sync option, the previous information of replication is deleted. In other words, the --reset option is internally forced to be set when using the --sync option.
- Cyclone which is operated as master directly connects to GOLDILOCKS which is operated as slave and it performs the data synchronization.

- Execute CYCLONE master
 - It should be executed in the source device.

```
cyclone --master --start --conf $GOLDILOCKS_DATA/conf/cyclone.master.conf --sync all
```

- Execute CYCLONE SLAVE
 - It should be executed in the target device.

```
cyclone --slave --start --conf $GOLDILOCKS_DATA/conf/cyclone.slave.conf --sync --all
```

- The following is an example of a sync error.
 - It is recommended to delete the data from tables of slave to prevent an error.
 - Execute MASTER.

```
gSQL> CREATE TABLE T1( COL1 INTEGER PRIMARY KEY, COL2 VARCHAR(20) );
gSQL> INSERT INTO T1 VALUES( 1, 'HELLO' );
```

- Execute SLAVE.

```
gSQL> CREATE TABLE T1( COL1 INTEGER PRIMARY KEY, COL2 VARCHAR(20) );
gSQL> INSERT INTO T1 VALUES( 1, 'BYE' );
```

- Execute MASTER.

```
cyclone --master --start --sync all
```

- Execute SLAVE.

```
cyclone --slave --start --sync all
SLAVE cyclone log
[RECEIVER] start the data synchronization.
[RECEIVER] Error Occurred.
STOP Done.
```

An error occurs and the sync does not operate due to an attempt to using the same value in the primary key.

Initializing Replication Information

- Initializing replication information
 - It restarts the replication from current point for the entire table or a specific table participating in the replication.
 - It is performed by using the `--reset TABLE_NAME` option or the `--reset ALL` option.
- Differences of between master and slave when performing the `--reset` option
 - Master stores table information and column information participating in the replication as meta. If RESET is performed in master by using the `--Reset ALL` option or the `Reset Table_name` option, it removes the meta in the table and configures meta again by using the information at the current point.
 - The `--reset` option should be performed in master to replicate again the table which is given up during the replication performing DDL.
 - The slave stores the information for recovery when restating the replication. `--reset All` or `--reset TABLE_NAME` should be described when executing slave as same as when executing master.



- Add the `--reset ALL` option to initialize all tables participating in the replication when performing master/ slave.

```
prompt> cyclone --master --start --reset ALL
prompt> cyclone --slave --start --reset ALL
```

- Add the `--reset TABLE_NAME` option when performing master to initialize the replication in formation of a specific table.
 - The table name of when performing slave should be as same as that of when performin g master.

```
prompt> cyclone --master --start --reset T1
```

```
prompt> cyclone --slave --start
```

- A single quote (') should be used to initialize two or more tables.

```
prompt> cyclone --master --start --reset 'T1 T2'
```

```
prompt> cyclone --master --start --reset 'T1, T2'
```

Recovery

- When using recovery,
 - It is used when handing over the replication to another cluster member in the same group and pr oceeding it, due to an error of master while the replication is being processed by using a standalo ne option in cluster environment.
 - It is performed with `--recovery GROUP_NAME` in master, and `GROUP_NAME` describes the group name of slave which previously performed the replication.



The process of resetting the replication information

1. Replicate with G1N1 member (standalone) in cluster environment.

```
prompt> cyclone --master --start --reset ALL --group g1n1_master --stand-alone
```

```
prompt> cyclone --slave --start --reset ALL --group g1n1_slave
```

2. Stop operating the existing cyclone to stop the cluster member or to hand over the service.

```
prompt> cyclone --master --stop
```

```
prompt> cyclone --slave --stop
```

3. Service the new replication (G1N2) by using the information of the existing replication. (G1N 1)

```
prompt> cyclone --master --start --reset all --group g1n2_master --stand-alone --recovery g1n1_
slave
```

```
prompt> cyclone --master --start --reset all --group g1n2_slave
```

45.6 Operating CYCLONE in Cluster

Requirements

- It provides a method to replicate members in the same cluster group in cluster environment.
 - Master and slave are operated in a relationship of 1 : 1 in standalone environment.
 - Master and slave are operated in a relationship of N: 1 in cluster environment.
- Available environment
 - Master should be cluster environment. (It is automatically detected.)
 - Slave can be either standalone or cluster environment.
- The status of master connected to slave is called as a node.



1. Master connecting to a slave should be a member in the same cluster group.
 - If it is a member of another cluster group, it should be operated in another slave.
2. If master is cluster environment, CYCLONE is basically operated in cluster mode, and --stand-alone option should be used to operate CYCLONE in standalone mode.
 - --stand-alone option is used only when performing master.
 - If the cluster information of master is described by adding CLUSTER option to configuration file, then slave is operated in cluster mode.

Operating

Starting and Terminating

- The time of terminating master and slave are different each in standalone environment and in cluster environment.
 - Standalone environment
 - If master is terminated, then slave is automatically terminated.
 - If slave is terminated, master is switched to an idle state but it is not terminated.
 - Cluster environment
 - Even when master is terminated, slave is not terminated. If another master is already connected, then the replication proceeds. If any master is not connected, slave is switched to an idle state.
 - If slave is terminated, all connected masters are automatically terminated.

Node Type

In cluster environment, CYCLONE classifies master connecting to slave into a trust node and a non-trust node.

Table 45-7 Node in cluster environment

Node	Description	Replication
Trust node	It is a node all of whose tables participating in replication are online.	O
Non-trust node	It is a node one or more of whose tables participating in replication are offline.	X

Operation According to Node Status

- Switching from a non-trust node to a trust node
 - It is executed when all tables are switched to online by rebalancing the cluster member while an offline table exists.
 - The node is automatically switched from a non-trust node to a trust node, and participates in replication.
- Switching from a trust node to a non-trust node
 - It is executed when a table being replicated in another cluster member in operation is altered while the cluster member is terminated and is not operated.
 - A non-trust node is automatically altered when a cluster member joins, and it is excluded from replication.



- The replication is maintained when one or more trust nodes exist among masters participating in the replication.
- A trust node is not restricted to a specific node, and any node is allowed regardless of node types.
- If all masters participating in replication becomes non-trust nodes, the replication does not proceed any more, and the replication does not start again even when they become trust nodes.
- At least one or more trust nodes are required to proceed the replication in cluster environment.

Executing

Configuration File

The configuration file of master is as same as that of standalone.

The following is an example of configuring G1N1 master environment, and IP of that device is assumed as 192.168.0.10.

- There is nothing to alter for master even in cluster environment.

```
USER_ID = cdc_user
USER_PW = cdc_password
GROUP_NAME = G1N1_Master
{
    PORT = 21011
    CAPTURE_TABLE =
    (
        T1,
        T2
    )
}
```

The following is an example of configuring G1N2 master environment, and IP of that device is assumed as 192.168.0.20.

- There is nothing to alter for master even in cluster environment.

```
USER_ID = cdc_user
USER_PW = cdc_password
GROUP_NAME = G1N2_Master
{
    PORT = 21012
    CAPTURE_TABLE =
    (
        T1,
        T2
    )
}
```

CLUSTER is added to the configuration file of slave to describe the information of master.

- CLUSTER consists of ID, MASTER_IP, and PORT. (The sequence does not matter.)
 - ID is input in numbers, and it is used as an internal delimiter to distinguish master in slave. Once it is set, it can not be altered. (If it is altered, it is recognized as a different master.)

- MASTER_IP is IP in which CYCLONE MASTER is operated in CLUSTER member.
- PORT is a PORT in which CYCLONE MASTER is operated in CLUSTER member.
- The information of a CLUSTER is described in parentheses, and it is distinguished by a comma (,) between parentheses.

MASTER_IP, PORT which are the master information of CLUSTER are described in CLUSTER configuration.

```

USER_ID = cdc_user
USER_PW = cdc_password
GROUP_NAME = G1_Slave
{
    CLUSTER = ( ID = 1, MASTER_IP = 192.168.0.10, PORT = 21011 ),
              ( ID = 2, MASTER_IP = 192.168.0.20, PORT = 21012 )
    APPLY_TABLE =
    (
        T1 TO T1,
        T2 TO T2
    )
}

```

Executing Method

Executing in Master

- It is executed in G1N1.

```
cyclone --master --start --conf $GOLDILOCKS_DATA/conf/cyclone.master.conf --group G1N1_Master
```

- It is executed in G1N2.

```
cyclone --master --start --conf $GOLDILOCKS_DATA/conf/cyclone.master.conf --group G1N2_Master
```

Executing in Slave

```
cyclone --slave --start --conf $GOLDILOCKS_DATA/conf/cyclone.slave.conf --group G1_Slave
```

SYNC Method

Executing Master

It is executed in G1N1. (It is master of which SYNC is to be executed, and it uses --sync option.)

```
cyclone --master --start --conf $GOLDILOCKS_DATA/conf/cyclone.master.conf --sync all
```

Executing Slave

```
cyclone --slave --start --conf $GOLDILOCKS_DATA/conf/cyclone.slave.conf --sync all
```



--local option should be used when syncing if a sharded table participates in the replication. It is because the data of a sharded table exists only in each cluster group, and data in other cluster groups are synchronized when executing sync without --local option. However, if all tables participating in the replication in cluster environment are cloned tables, then --local option does not need to be used.

Others

--reset option can be used as same as it is used in standalone environment.

45.7 Monitoring (CYMON)

CYMON (CYclone MONitor) is a tool for monitoring CYCLONE which is a CDC replication tool. It periodically updates the monitoring information of CYCLONE to GOLDDILOCKS operated as master.

Table 45-8 Execution files

File name	Description
cymon	Monitoring cyclone

Configuration File

The configuration file of cymon uses the configuration file used when running cyclone as master. If a specific configuration file is not set by using the `--conf` option, the `$GOLDDILOCKS_DATA/conf/cyclone.master.conf` file is read as the default when cyclone is run as master.



CYMON should be run on the device which is as same as the device of which CYCLONE runs as master.

Monitoring Contents

CYMON

CYMON periodically updates the operating information of CYCLONE to the `CYCLONE_MONITOR_INFO` table of GOLDDILOCKS. The monitoring information is as follows.

Table 45-9 CYCLONE_MONITOR_INFO

Column	Description
GROUP_NAME	It is the name of a group in which CYCLONE was executed.
TIME	It is the information of time at which the information was updated. (YYYY-MM-DD H H24:MI:SS)
MASTER_STATE	It is the state of CYCLONE which is operated as MASTER. <ul style="list-style-type: none"> N/A: The state is unknown. READY: It is waiting for connection of SLAVE RUNNING: SLAVE is connected and the replication is running.
SLAVE_STATE	It is the state of CYCLONE which is operated as SLAVE.

Column	Description
	<ul style="list-style-type: none"> N/A: The state is unknown. RUNNING: The replication is running.
MASTER_PORT	It is the information of PORT on which CYCLONE operated in MASTER is waiting for slave.
SLAVE_IP	It is an IP address of the device connected with CYCLONE SLAVE.
REDO_LOG_FILESEQ	It is the sequence number of the redo log file of the running GOLDBLOCKS.
REDO_LOG_BLOCKSEQ	It is the block sequence number of the redo log file of the running GOLDBLOCKS.
CAPTURE_FILESEQ	It is the sequence number of the redo log file captured by CYCLONE master.
CAPTURE_BLOCKSEQ	It is the block sequence number of the redo log file captured by CYCLONE master.
CAPTURE_INTERVAL	It is the number of the remaining redo log blocks to be processed by CYCLONE master <ul style="list-style-type: none"> 1 block = 512 bytes (Redo log block size = 512 bytes)
CAPTURE_INTERVAL_SIZE	It is the size of the remaining redo log files to be processed by CYCLONE master.
TOTAL_TX_COUNT	It is the number of all transactions captured by CYCLONE master.
CAPTURE_TX_COUNT	It is the number of all transactions in which the replication targets are included among the transactions captured by CYCLONE master.
CAPTURE_COMMIT_LSN	It is the commit log number of the last transaction which was captured in CYCLONE master. It is not updated if there is not a transaction to be captured any more.



INTERVAL information is the CAPTURE information for analyzing the redo log file of CYCLONE operated as master, and it is not the information reflected by APPLIER in CYCLONE SLAVE.

Executing and Monitoring

Executing Option

Table 45-10 Executing option

Option	Description	Remarks
--conf -c	It sets the configuration file path.	It is input in --conf CONFIG FILE format. <ul style="list-style-type: none"> It should set the file as same as the configuration file used when running CYCLONE as master.
--start -s	It executes CYMON.	-
--stop -t	It terminates CYMON.	-
--status -u	It displays the operating status of CYMON.	-
--cycle -y	It sets the update cycle of monitoring information.	It is input in --cycle X format. <ul style="list-style-type: none"> It should be entered in seconds.

Option	Description	Remarks
--key -k	It sets the decryption key when USER_ENCRYPT_PW is used in config.	-
--trace -r	It simultaneously records the monitoring information of capture on the trace log.	The trace log is recorded in \$GOLDLOCKS_DATA/trc/cymon.trc.
--silent -i	It sets not to output the message.	-
--help -h	It outputs the help message.	-

Examples

- Execute CYMON (Update the monitoring information of cyclone_monitor_info table.)
 - Executes CYMON to update the monitoring information per second. It continuously updates the information until terminating CYMON.

```
cymon --start --cycle 1
```

- View the monitoring information

```
gSQL> \set vertical on
gSQL> select * from cyclone_monitor_info;
      GROUP_NAME # GROUP1
           TIME # 2015-01-13 17:34:53
MASTER_STATE # READY
SLAVE_STATE # N/A
MASTER_PORT # 21102
      SLAVE_IP # null
REDO_LOG_FILESEQ # 0
REDO_LOG_BLOCKSEQ # 52392
CAPTURE_FILESEQ # 0
CAPTURE_BLOCKSEQ # 0
CAPTURE_INTERVAL # 0
CAPTURE_INTERVAL_SIZE # 0
```

- The information above describes that only CYCLONE MASTER is being operated and SLAVE is waiting.

```
gSQL> \set vertical on
gSQL> select * from cyclone_monitor_info;
      GROUP_NAME # GROUP1
           TIME # 2015-01-13 17:36:17
```

```

MASTER_STATE # RUNNING
SLAVE_STATE # RUNNING
MASTER_PORT # 21102
  SLAVE_IP # 127.0.0.1
REDO_LOG_FILESEQ # 0
REDO_LOG_BLOCKSEQ # 52811
  CAPTURE_FILESEQ # 0
  CAPTURE_BLOCKSEQ # 52811
  CAPTURE_INTERVAL # 0
CAPTURE_INTERVAL_SIZE # 0

```

- The information above describes that CYCLONE MASTER and SLAVE are being operated.
- Execute CYMON (Store the monitoring information in trace log)
 - The monitoring information is stored not only in a monitoring table but also in a trace log since when CYMON is normally executed with master.
 - Generally, it is used when unable to view cyclone_monitor_info table due to an error of the master DB. In this case, the information of master DB such as information of REDO_LOG_FILESEQ and REDO_LOG_BLOCKSEQ are not included.
 - Trace log is in \$GOLDILOCKS_DATA/trc/cymon.trc.

```
cymon --start --trace
```

- View the monitoring information (When using --trace option)
 - It stores the monitoring information since when the cyclone master is normally executed.

GROUP_NAME	TIME	MASTER_STATE	SLAVE_STATE	MASTER_PORT	SLAVE_IP
CAPTURE_FILESEQ	CAPTURE_BLOCKSEQ	TOTAL_TX_COUNT	CAPTURE_TX_COUNT	CAPTURE_COMMIT_LSN	
GROUP1	2016-11-02 15:43:03	READY	N/A	21102	null
0	0	0	0	0	
GROUP2	2016-11-02 15:43:03	READY	N/A	21103	null
0	0	0	0	0	

- The information above describes that only CYCLONE MASTER is being operated and SLAVE is waiting.

GROUP_NAME	TIME	MASTER_STATE	SLAVE_STATE	MASTER_PORT	SLAVE_IP
CAPTURE_FILESEQ	CAPTURE_BLOCKSEQ	TOTAL_TX_COUNT	CAPTURE_TX_COUNT	CAPTURE_COMMIT_LSN	
GROUP1	2016-11-02 15:43:11	RUNNING	RUNNING	21102	192.168.0.206

```

7          52779          0          0          15346
GROUP2      2016-11-02 15:43:11 READY      N/A          21103 null
0          0          0          0          0

```

- The information above describes that CYCLONE MASTER (group1) and SLAVE are being operated.

- View the operating status of CYMON

```

$ cymon --status
=====
|          CYMON STATUS          |
=====
|      Service is running...      |
-----

```

- Terminate CYMON

```

$ cymon --stop
stop done.

```

46.

LOGMIRROR

46.1 LOGMIRROR

LOGMIRROR is a replication tool which copies the redo logs generated by GOLDILOCKS to the remote location for the configuration of the same redo log file.

Overview

CYCLONE, using the CDC method, analyzes and replicates the redo log file generated during the operation of GOLDILOCKS. Therefore, if the operating server is failed when analysis of the redo log file is not completed, then unanalyzed redo log file is not replicated and the data is lost.

However, if the redo logs are sent to a remote location without data loss and the redo log file is configured by using LOGMIRROR, then this problem of CYCLONE can be solved.

LOGMIRROR is a tool for eliminating the data loss which is caused because CYCLONE uses the ASYNC method, and it should work together with CYCLONE.

Operational Features

- It is performed being divided into master and slave. Only one LOGMIRROR per GOLDILOCKS is allowed to be operated.
- Master and slave can use the TCP/IP and infiniband communication.
 - Network speed significantly affects the GOLDILOCKS operation speed.
- The replication target is the redo log file of GOLDILOCKS.
- The original database should be operated in Transactional Data Store (TDS) mode.
 - LOGMIRROR has the same operational characteristics of CYCLONE because it should be operated together with CYCLONE.

Performance Degradation Factors of GOLDILOCKS When Operating LOGMIRROR

LOGMIRROR sends the redo logs generated by GOLDILOCKS to the remote location before storing them in the file, then processes the next after it is normally processed. Therefore, the network speed between the replication devices is an important factor of the performance, and it can cause performance degradation than GOLDILOCKS operated without LOGMIRROR. However, the high speed infiniband is supported t

o minimize the performance degradation.

46.2 Requirements

GOLDILOCKS Requirement

The followings should be set in GOLDILOCKS before performing LOG MIRROR.

LOG_MIRROR_MODE

The LOG_MIRROR_MODE property is set to use LOGMIRROR in GOLDILOCKS. When it is activated, the resources which temporarily store the redo logs generated by GOLDILOCKS before LOGMIRROR sends them to a remote location are allocated.

- If the LOG_MIRROR_MODE property is changed, it is applied after restarting GOLDILOCKS.
- The changes are added or reflected in the property file.
 - Property file: goldilocks.properties.conf
 - Property setting: LOG_MIRROR_MODE = 1

Or, the following statement is executed in gSQL.

```
gSQL> ALTER SYSTEM SET LOG_MIRROR_MODE=1 SCOPE=FILE;  
System altered.
```

LOG_MIRROR_SHARED_MEMORY_STATIC_SIZE

LOG_MIRROR_SHARED_MEMORY_STATIC_SIZE sets the temporary storage space used by LOGMIRROR.

- It is a temporary storage space used before storing redo log file from redo log buffer.
 - The set value is related to MAXIMUM_FLUSH_LOG_BLOCK_COUNT used when storing the redo log file.
- The default value is 100 M.
 - The minimum value is 10 M, and the maximum value is 1 G.
 - Too small set value can affect the performance.
- If LOG_MIRROR_SHARED_MEMORY_STATIC_SIZE property is changed, then it is applied after the GOLDILOCKS is restarted.
- The changes are added or reflected in the property file.
 - Property file: goldilocks.properties.conf
 - Property setting: LOG_MIRROR_SHARED_MEMORY_STATIC_SIZE = the set value

Or, the following statement is executed in gSQL.

```
gSQL> ALTER SYSTEM SET LOG_MIRROR_SHARED_MEMORY_STATIC_SIZE = 200M SCOPE=FILE;  
System altered.
```

LOG_MIRROR_TIMEOUT

When interworking with LOGMIRROR, GOLDLOCKS includes the step of waiting for the response from LOG MIRROR. Too slow response causes the degradation of GOLDLOCKS performance. LOG_MIRROR_TIMEOUT sets the response time so when there is not any response after the time is over, LOGMIRROR stops the service, but only the GOLDLOCKS continues the service.

When restarting LOGMIRROR to perform LOGMIRROR again, it is normally operated after the recovery process.

- The default value is '0'.
 - 0 refers to an infinite waiting.
 - It can be set in seconds.
- If LOG_MIRROR_TIMEOUT property is changed, it is immediately reflected.
- The changes are added or reflected in the property file.
 - Property file: goldilocks.properties.conf
 - Property setting: LOG_MIRROR_TIMEOUT = the set value

Or, the following statement is executed in gSQL.

```
gSQL> ALTER SYSTEM SET LOG_MIRROR_TIMEOUT = 20;  
System altered.
```



The GOLDLOCKS requirements for operating CYCLONE should also be applied.

46.3 Configuration

Configuration File

The information and options required for the operation can be set by using the configuration file when executing LOGMIRROR.

- If a specific configuration file is not set by using the --conf option, a specific file is read at \$ GOLDILOCKS_DATA / conf directory. The logmirror.master.conf file is read when operating as master and the logmirror.slave.conf file is read when operating as slave.

Table 46-1 Configuration contents

Name	Description	Coverage
PORT	It sets the port to be used for the communication between master and slave.	Master/ slave
DSN	It sets Data Source Name.	Master
HOST_IP	It sets the host IP address which is operated by GOLDILOCKS.	Master
HOST_PORT	It sets the host port which is operated by GOLDILOCKS.	Master
USER_ID	It sets the user name.	Master
USER_PW	It sets the user password.	Master
USER_ENCRYPT_PW	It sets encrypted user password.	Master/ slave
LOG_PATH	It sets the path in which the replicated redo log file is to be stored.	Slave
MASTER_IP	It sets the IP address of the device which is being operated by the log mirror master.	Slave
HEARTBEAT_TIMEOUT	It sets the maximum time (second) maintaining connection if the connection is not smooth due to network disconnection or system error after replication connection.	Master/ slave
TCP_NODELAY	It sets TCP_NODELAY option of a socket. (The default value is 1.) <ul style="list-style-type: none"> • 0: TCP_NODELAY off • 1: TCP_NODELAY on 	Master

Configuration Options

PORT

- It sets the port used for the communication between master and slave.
- It can be set in master and slave.

PORT=21106

DSN

- It sets the data source name required for the access to GOLDILOCKS.
- It can be set in master.

DSN = GOLDILOCKS

HOST_IP

- It sets the IP address of GOLDILOCKS in which LOGMIRROR is to be operated.
- It should be set together with HOST_PORT.
- It can be set in master.

HOST_IP = 127.0.0.1

HOST_PORT

- It sets the port of GOLDILOCKS on which LOGMIRROR is to be operated.
- It should be set together with HOST_IP.
- It can be set in master.

HOST_PORT = 22531

USER_ID

- It sets the user ID required for the access to GOLDILOCKS.
- It can be set in master.

USER_ID = testID

USER_PW

- It sets the user password required for the access to GOLDILOCKS.
- It can be set in master.

```
USER_PW = testPW
```

USER_ENCRYPT_PW

- It sets the user password which is required for the access to GOLDILOCKS by encrypting.
- It is used instead of USER_PW.
- Encrypted user password is created by `[logmirror --encrypt user password --key the key to be encrypted]`.
- If this value is used, then `--key` option should be used when executing logmirror. (In this case, the key value as same as that created with `--encrypt` should be used.

```
USER_ENCRYPT_PW = 't33KImiqvhqNyfN+uZmFrw=='
```

LOG_PATH

- It sets the path in which the replicated redo log file is to be stored.
 - The set path should be an absolute path.
 - The path is set by using a single quote (').
- It can be set in slave.

```
LOG_PATH = '/data/wal'
```

MASTER_IP

- It sets the IP address of the device of which LOGMIRROR master is operating.
- It can be set in slave.

```
MASTER_IP = 192.168.0.100
```

HEARTBEAT_TIMEOUT

- It can be set in master and slave.
- It sets the maximum time (second) maintaining connection if the connection is not smooth due to network disconnection or system error after replication connection between master and slave.
- The default value is 30 (seconds).
 - The minimum value is 10 (seconds).

```
HEARTBEAT_TIMEOUT = 40
```

TCP_NODELAY

- It is used only in master.
- It sets TCP_NODELAY option for the LogMirror transfer socket.
 - 0: It offs the socket TCP_NODELAY option.
 - 1: It ons the socket TCP_NODELAY option. (Default)

■ TCP_NODELAY = 1

46.4 Operating

The executing environment of master/ slave of LOGMIRROR is as follows.

Table 46-2 Executing environment

Item	Whether to operate GOLDILOCKS	Description
Master	O	When operating as master, LOGMIRROR should be operated at the device in which GOLDILOCKS is operated.
Slave	X	When operating as slave, GOLDILOCKS is not required to be operated and the storage space in the disk is required to store the redo log file.

The operating contents during the execution can be viewed through a trace log.

Item	File
Master	\$GOLDILOCKS_DATA/trc/LogMirror_master.trc
Slave	\$GOLDILOCKS_DATA/trc/LogMirror_slave.trc



For more information about the error messages and handlings stored in the trace log, refer to **Troubleshooting of LOGMIRROR**.

Operating LOGMIRROR

LOGMIRROR can normally replicates the redo log file only when the following procedures should be completed even after the GOLDILOCKS configuration, initializing and operating master/ slave.



SWITCH of the redo log file should occur to start the replication. LOGMIRROR starts the normal operation after generating the new log file. Therefore, the following step should be performed.

```
gSQL> ALTER SYSTEM SWITCH LOGFILE;
System altered.
```



The redo log file replicated by LOGMIRROR is continuously stored, and it is not automatically deleted. Therefore, the file management such as deleting or moving is regularly required according to the environment of the operating device.

Executing Option

Table 46-3 Execution options

Option	Description	Remarks
--start -s	It executes LOGMIRROR.	It should be used together with --master --slave.
--stop -t	It terminates LOGMIRROR.	It should be used together with --master --slave.
--master -m	It is performed in master mode.	It should be used together with --start --stop.
--slave -l	It is performed in slave mode.	It should be used together with --start --stop.
--conf -c	It sets the configuration file path.	It is input in --conf CONFIG_FILE format.
--infiniband -f	It uses infiniband network environment.	It is not input when using TCP/IP environment.
--silent -i	It sets not to output the message.	-
--help -h	It sets to output the help message.	-

- Execute it in master mode by using the default configuration file.

```
prompt> logmirror --master --start
```

- Terminate the LOGMIRROR which is being operated in master mode.

```
prompt> logmirror --master --stop
```

- Execute it in slave mode by using the default configuration file.

```
prompt> logmirror --slave --start
```

- Terminate the LOGMIRROR which is being operated in slave mode.

```
prompt> logmirror --slave --stop
```

- Execute it in master mode by using TEST_CONFIG file and infiniband network.

```
prompt> logmirror --master --start --conf TEST_CONFIG --infiniband
```

- Execute it in slave mode by using TEST_CONFIG file and infiniband network.

```
prompt> logmirror --slave --start --conf TEST_CONFIG --infiniband
```



For examples of initializing LOGMIRROR, refer to **LOGMIRROR**.

46.5 Examples of Interworking with CYCLONE

Interworking of CYCLONE, the CDC replication tool, with LOGMIRROR, the replication tool of the redo log file, eliminates the risk of data loss.

Tool	Function	Interworking
CYCLONE	Replication of CDC	If it is independently operated it may cause the data loss.
LOGMIRROR	Replication of REDO LOG FILE	If it is operated together it does not cause the data loss.

The following describes the examples of interworked operation, and its structure.

Figure 1 Example of operating structure

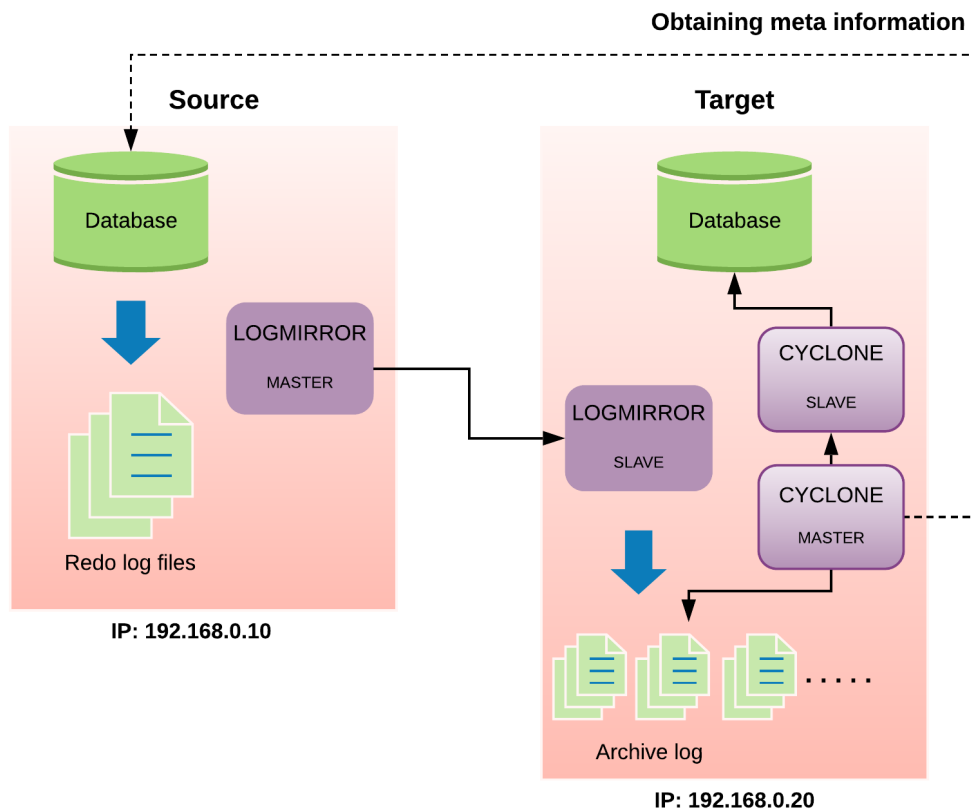

- Device structure
 - The source device which is the original data
 - IP: 192.168.0.10
 - GOLDILOCKS listen port: 22581
 - The table to be replicated: T1, T2
- The remote target device for replication
 - IP: 192.168.0.20
- Two devices executes interworking between LOGMIRROR and CYCLONE for the replication without

data loss.

- Source device: LOGMIRROR (master)
- Target device: LOGMIRROR (slave) + CYCLONE (master, slave)

Operating Order

1. Set the configuration of CYCLONE and LOGMIRROR in the original GOLDILOCKS.
2. Set the configuration of LOGMIRROR MASTER/SLAVE.
3. Execute LOGMIRROR MASTER/SLAVE.
4. Perform LOG FILE SWITCH of the original GOLDILOCKS for the normal operation of LOGMIRROR.
5. Set the remote GOLDILOCKS configuration.
6. Set the CYCLONE MASTER/SLAVE configuration.
7. Execute CYCLONE MASTER/SLAVE.

Configuring CYCLONE and LOGMIRROR in Original GOLDILOCKS

Refer to the followings.

- CYCLONE configuration: **Requirements**
- LOGMIRROR configuration: **Requirements**

Create the tables T1, T2 for a test after the configuration.

```
gSQL > CREATE TABLE T1( COL1 INTEGER PRIMARY KEY, COL2 VARCHAR(20) );
gSQL > CREATE TABLE T2( COL1 INTEGER PRIMARY KEY, COL2 VARCHAR(20) );
gSQL > COMMIT;
```

Configuring LOGMIRROR MASTER/SLAVE

- LOGMIRROR MASTER configuration file
 - Storage location: \$GOLDILOCKS_DATA/conf/logmirror.master.conf
 - It is the source device.



LOG MIRROR MASTER should be operated on the device in which the original GOLDILOCKS is operated.

- Enter DSN or HOST information. HOST information is entered in the following example.

```
HOST_IP = 192.168.0.10
```

```
HOST_PORT = 22581
```

- Use CYCLONE USER created in the previous step.

```
USER_ID = cdc_user
```

```
USER_PW = cdc_password
```

- Set the PORT to be used for LOGMIRROR communication.

```
PORT = 21106
```

- LOGMIRROR SLAVE configuration file
 - Storage path: \$GOLDILOCKS_DATA/conf/logmirror.slave.conf
 - It is the target device.
- Enter the IP address of the device in which LOG MIRROR MASTER is being operated.

```
MASTER_IP = 192.168.0.10
```

- The PORT which is as same as LOGMIRROR MASTER should be entered.

```
PORT = 21106
```

- Enter the absolute path in which the replicated redo log file is to be stored.

```
LOG_PATH = '/data/LogMirrorWAL'
```

Executing LOGMIRROR MASTER/ SLAVE

- Execute LOGMIRROR MASTER.
 - It should be executed in the source device.

```
logmirror --master --start --conf $GOLDILOCKS_DATA/conf/logmirror.master.conf
```

- Execute LOGMIRROR SLAVE.
 - It should be executed in the target device.

```
logmirror --slave --start --conf $GOLDILOCKS_DATA/conf/logmirror.slave.conf
```

Executing LOGFILE SWITCH of Original GOLDILOCKS for Normal Operation of LOGMIRROR

- LOGFILE SWITCH for starting to record LOGMIRROR file.
 - It should be executed in the source device.

```
gSQL> ALTER SYSTEM SWITCH LOGFILE;
```



When it is executed as above, the redo log file is generated in the path set in the SLAVE device. If the redo log file is not generated, a user should check the directory privilege or check whether the directory is created.

Configuring Remote GOLDILOCKS

It is required to check the table configuration for the normal operation and replication of GOLDILOCKS operated on the target device, and check the schema information.

The tables T1, T2 are created for test as follows.

```
gSQL > CREATE TABLE T1( COL1 INTEGER PRIMARY KEY, COL2 VARCHAR(20) );
gSQL > CREATE TABLE T2( COL1 INTEGER PRIMARY KEY, COL2 VARCHAR(20) );
gSQL > COMMIT;
```

Configuring CYCLONE MASTER/ SLAVE

- CYCLONE MASTER configuration file
 - Storage path: \$GOLDILOCKS_DATA/conf/cyclone.master.conf
 - It is the target device.
- Enter DSN or HOST information of the source device. HOST information is entered in the following example.

```
HOST_IP    = 192.168.0.10
HOST_PORT  = 22581
```

- Use CYCLONE USER

```
USER_ID = cdc_user
USER_PW = cdc_password
GROUP_NAME = GROUP1
```

```
{
  PORT = 21102
  CAPTURE_TABLE =
  (
    T1,
    T2
  )
}
```

- CYCLONE SLAVE configuration file
 - Storage path: \$GOLDILOCKS_DATA/conf/cyclone.slave.conf
 - It is the target device.
- Connect to GOLDILOCKS which is operated in the target device with D/A. (Therefore, DSN and HOST information does not exist.)

```
USER_ID = cdc_user
USER_PW = cdc_password
```

- CYCLONE master is being operated on the same device.

```
MASTER_IP = 192.168.0.20
GROUP_NAME = GROUP1
{
```

- Enter the path set by LogMirror slave.

```
LOG_PATH = '/data/LogMirrorWAL'
PORT = 21102
APPLY_TABLE =
(
  T1 TO T1,
  T2 TO T2
)
}
```

Executing CYCLONE MASTER/ SLAVE

- Execute CYCLONE MASTER.
 - It should be executed in the target device when it is connected with D/A.

```
| cyclonet --master --start --conf $GOLDILOCKS_DATA/conf/cyclone.master.conf
```

- Execute CYCLONE SLAVE.
 - It should be executed in the target device when it is connected with D/A.

```
| cyclone --slave --start --conf $GOLDILOCKS_DATA/conf/cyclone.slave.conf
```

Appendix A.

Error Codes

GOLDILOCKS provides user error codes as follows. The error messages can be viewed with `V$ERROR_CODE`.

A.1 OS Related Error

- Error code: GOLDILOCKS-specific error code
- SQLSTATE: SQL standard state code
- Message: Error message

Table A-1 OS related error

Error code	SQLSTATE	Message
11000	HY000	Invalid argument
11001	HY000	The operation was incomplete although some processing was performed and the results are partially valid
11002	HY000	Permission denied '%s'
11003	HY000	Standard Layer has encountered the end of the file
11004	HY000	Unable to duplicate a file
11005	HY000	File Lock Error
11006	HY000	File Unlock Error
11007	HY000	Unable to open the file '%s'
11008	HY000	Unable to close the file
11009	HY000	Unable to remove the file
11010	HY000	Unable to link the file
11011	HY000	Unable to read the file
11012	HY000	Unable to write the file
11013	HY000	Unable to sync the file
11014	HY000	Unable to seek the file
11015	HY000	Unable to truncate the file
11016	HY000	Unable to get the status of the file
11017	HY000	Unable to create a pipe
11018	HY000	Unable to wait for the given process
11019	HY000	Insufficient resource
11020	HY000	Unable to send signal to given process
11021	HY000	Unable to set a signal handler
11022	HY000	Unable to block a signal
11023	HY000	Unable to set thread attribute
11024	HY000	Unable to create a thread
11025	HY000	Unable to join with a terminated thread
11026	HY000	Unable to set thread once code
11027	HY000	Truncation occurred on I/O operation
11028	HY000	The given name(%s) is too long
11029	HY000	shared memory segment exists
11030	HY000	Unable to allocate a shared memory segment

Error code	SQLSTATE	Message
11031	HY000	Unable to attach the shared memory segment
11032	HY000	Unable to detach the shared memory segment
11033	HY000	Unable to destroy the shared memory segment
11034	HY000	Unable to create a semaphore
11035	HY000	Unable to acquire the given semaphore
11036	HY000	Unable to release the given semaphore
11037	HY000	Unable to destroy the given semaphore
11038	HY000	The given object was busy
11039	HY000	Operation timed out
11040	HY000	No such object (%s)
11041	HY000	Two objects do not match
11042	HY000	Not enough memory
11043	HY000	File system is full
11044	HY000	Unable to execute the program
11045	HY000	not supported function
11046	HY000	given buffer does not have enough space
11047	HY000	invalid network address
11048	HY000	sendto() system call returned failure
11049	HY000	recvfrom() system call returned failure
11050	HY000	fail to get address from socket with getsockname()
11051	HY000	fail to get peer address from socket with getpeername()
11052	HY000	fail to manipulate file descriptor with fcntl()
11053	HY000	fail to manipulate socket descriptor with setsockopt()
11054	HY000	not implemented feature
11055	HY000	fail to manipulate device parameters of special file with ioctl()
11056	HY000	fail to get hostname
11057	HY000	fail to close a socket
11058	HY000	fail to shutdown a socket
11059	HY000	fail to create a socket
11060	HY000	fail to get property of a file descriptor
11061	HY000	fail to set property of a file descriptor
11062	HY000	fail to bind a socket to address
11063	HY000	fail to listen on a socket
11064	HY000	fail to accept a connection request with a socket
11065	HY000	system call was interrupted by a signal
11066	HY000	fail to get options of a socket
11067	HY000	fail to connect to an host with a socket
11068	HY000	fail to wait for some file descriptors with poll()
11069	HY000	internal error
11070	HY000	sendmsg() system call returned failure

Error code	SQLSTATE	Message
11071	HY000	recvmsg() system call returned failure
11072	HY000	socketpair() system call returned failure
11073	HY000	converted value is out of range (overflow or underflow)
11074	HY000	given string is not number
11075	HY000	not a valid file descriptor
11076	HY000	resource temporarily unavailable
11077	HY000	given address is already in use
11078	HY000	fail to initialize communication context
11079	HY000	fail to finalize communication context
11080	HY000	fail to connect communication context
11081	HY000	fail to poll communication context
11082	HY000	fail to write packet through communication context
11083	HY000	fail to read packet through communication context
11084	HY000	fail to send descriptor through communication context
11085	HY000	fail to receive descriptor through communication context
11086	HY000	fail to get current file path
11087	HY000	fail to open library (%s)
11088	HY000	fail to close library
11089	HY000	fail to get symbol address (%s)
11090	HY000	not supported query
11091	HY000	fail to check file (%s)
11092	HY000	input is too long
11093	HY000	system call error (function : %s, error no : %d)
11094	HY000	divide zero
11095	HY000	Unable to open a semaphore
11096	HY000	Unable to close the given semaphore
11097	HY000	Unable to unlink the given semaphore
11098	HY000	permission denied - '%s'
11099	HY000	not supported os
11100	HY000	Environment Variable "%s" is not defined.
11101	HY000	License file(%s) is not exist
11102	HY000	License is out of date. License is valid after %4d-%02d-%02d
11103	HY000	License date is expired. License is expired in %4d-%02d-%02d
11104	HY000	License core count mismatch.
11105	HY000	License key is corrupted.
11106	HY000	License host name mismatch.
11107	HY000	failed to set thread affinity.
11108	HY000	failed to create timer.
11109	HY000	failed to set timer.
11110	HY000	failed to destroy timer.

Error code	SQLSTATE	Message
11111	HY000	address is not given.
11112	HY000	Unable to access the message queue.
11113	HY000	A message queue exists.
11114	HY000	Unable to create a message queue.
11115	HY000	The message queue was removed.
11116	HY000	Unable to destroy the message queue.
11117	HY000	Unable to send message.
11118	HY000	Unable to receive message.
11119	HY000	No message was available in the message queue.
11120	HY000	fail to get property of a file status
11121	HY000	fail to set property of a file status
11122	HY000	infiniband ibv/rdma interface returned error
11123	HY000	no infiniband device was found
11124	HY000	cannot find specified infiniband device
11125	HY000	cannot find suitable Memory Region for specified ptr and size
11126	HY000	fail to get semaphore value
11127	HY000	fail to control pollset
11128	HY000	fail to create pollset
11129	HY000	overflow fd
11130	HY000	invalid INI file format
11131	HY000	path '%s' does not exist
11132	HY000	Unable to get maximum undo semaphores per array
11133	HY000	Unable to create a undo semaphore
11134	HY000	Unable to bind the given undo semaphore
11135	HY000	Unable to unbind the given undo semaphore
11136	HY000	Unable to get the given undo semaphore state
11137	HY000	Unable to destroy the given undo semaphore
11138	HY000	Unable to suspend asynchronous io
11139	HY000	Unable to control the shared memory segment
11140	HY000	Unable to detach a thread
11141	08S01	Communication link failure
11142	HY000	No such process

A.2 Datatype and Operation Related Error

- Error code: GOLDILOCKS-specific error code
- SQLSTATE: SQL standard state code
- Message: Error message

Table A-2 Datatype and operation related error

Error code	SQLSTATE	Message
12000	HY000	failed to initialize datatype layer
12001	HYC00	not implemented feature, in a function %s
12002	22001	byte length of data greater than column length
12003	22001	character length of data greater than column length
12004	22001	data converted with truncation of fractional digits
12005	22001	conversion of data would result in loss of whole digits
12006	22018	data value is not a numeric literal
12007	22003	data is outside the range of the data type to which the number is being converted
12008	22001	data is greater than 0, less than 2, and not equal to 1
12009	22003	data is less than 0 or greater than or equal to 2
12010	22001	(byte length of data)/2 is greater than column byte length
12011	22003	data value is not a hexadecimal value
12012	22008	data value is a valid timestamp literal; time portion is nonzero
12013	22018	data value is not a valid date literal or timestamp literal
12014	22008	data value is a valid timestamp literal; fractional seconds portion is nonzero
12015	22018	data value is not a valid time literal or timestamp literal
12016	22008	data value is a valid timestamp literal; fractional seconds portion truncated
12017	22018	data value is not a valid date literal or time literal or timestamp literal
12018	22015	data value is a valid interval value; the value in one of the fields is truncated
12019	22018	data value is not a valid interval literal
12020	22001	number of digits greater than column byte length
12021	22001	number of characters greater than column byte length
12022	22003	data converted with truncation of whole digits
12023	22003	data is outside the range of the data type to which the number is being converted
12024	22001	data is greater than 0, less than 2, and not equal to 1
12025	22003	data is less than 0 or greater than or equal to 2
12026	22015	interval data truncated
12027	22001	byte length of data greater than column length
12028	22001	character length of data greater than column length
12029	22003	byte length of data not equal to SQL data length

Error code	SQLSTATE	Message
12030	22001	column byte length is less than %d
12031	22008	data value is not a valid date
12032	22007	data value is not a valid date format
12033	22001	column byte length is less than %d
12034	22018	data value is not a valid GUID
12035	22001	column byte length is less than %d
12036	22001	data value is not a valid time
12037	22007	data value is not a valid time format
12038	22001	column byte length is between %d and character byte length
12039	22001	column byte length is less than %d
12040	22008	data value is not a valid timestamp
12041	22008	time fields are nonzero
12042	22007	data value does not contain a valid date
12043	22008	fractional seconds fields are nonzero
12044	22007	data value does not contain a valid time
12045	22008	fractional seconds fields are truncated
12046	22007	data value does not contain a valid timestamp
12047	22001	column byte length is less than character byte length
12048	22015	data value is not a valid interval literal
12049	22003	conversion resulted in truncation of whole digits
12050	22015	one or more fields of data value were truncated during conversion
12051	22001	column byte length is less than character byte length
12052	22015	data value is not a valid interval literal
12053	22003	conversion resulted in truncation of whole digits
12054	22015	one or more fields of data value were truncated during conversion
12055	01004	byte length of data greater equal than buffer length
12056	01004	character length of data greater equal than buffer length
12057	01S07	data converted with truncation of fractional digits
12058	22003	conversion of data would result in loss of whole digits
12059	22018	data is not numeric literal
12060	22003	data is outside the range of the data type to which the number is being converted
12061	01S07	data is greater than 0, less than 2, and not equal to 1
12062	22003	data is less than 0 or greater than or equal to 2
12063	01S07	data value is a valid timestamp-value; time portion is nonzero
12064	22018	data value is not a valid date-value or timestamp-value
12065	01S07	data value is a valid timestamp-value; fractional seconds portion is nonzero
12066	22018	data value is not a valid time-value or timestamp-value
12067	22018	data value is not a valid date-value or time-value or timestamp-value
12068	01S07	data value is a valid interval value;truncation of one or more trailing fields

Error code	SQLSTATE	Message
12069	22015	data value is a valid interval; leading field significant precision is lost
12070	22018	data value is not a valid interval value
12071	01004	number of whole digits is less than buffer length
12072	22003	number of whole digits is greater than buffer length
12073	01S07	data converted with truncation of fractional digits
12074	22003	conversion of data would result in loss of whole digits
12075	22003	data is outside the range of the data type to which the number is being converted
12076	01S07	data is greater than 0, less than 2, and not equal to 1
12077	22003	data is less than 0 or greater than or equal to 2
12078	22003	byte length of data is greater than buffer length
12079	01S07	fractional seconds portion truncated
12080	22015	whole part of number truncated
12081	22003	buffer length is less equal than 1
12082	22003	buffer length is less than 1
12083	01004	(byte length of data)/2 is greater equal than buffer length
12084	01004	(character length of data)/2 is greater equal than buffer length
12085	01004	byte length of data is greater than buffer length
12086	01004	buffer length is between %d and character byte length
12087	22003	buffer length is less than %d
12088	22003	byte length of data is greater than buffer length
12089	22003	buffer length is less than %d
12090	22003	byte length of data is greater than buffer length
12091	01004	buffer length is between %d and character byte length
12092	22003	buffer length is less than %d
12093	22003	byte length of data is greater than buffer length
12094	01004	buffer length is between %d and character byte length
12095	22003	buffer length is less than %d
12096	01004	buffer length is between %d and character length
12097	22003	byte length of data is greater than buffer length
12098	01S07	time portion of timestamp is nonzero
12099	01S07	fractional seconds portion of timestamp is nonzero
12100	01S07	fractional seconds portion of timestamp is truncated
12101	01S07	trailing fields portion truncated
12102	22015	leading precision of target is not big enough to hold data from source
12103	22003	interval precision was a single field and truncated whole
12104	22015	interval precision was not a single field
12105	22003	byte length of data is greater than buffer length
12106	01004	number of whole digits is less than buffer length
12107	22003	number of whole digits is greater equal than buffer length

Error code	SQLSTATE	Message
12108	01S07	trailing fields portion truncated
12109	22015	leading precision of target is not big enough to hold data from source
12110	01S07	interval precision was a single field and truncated fractional
12111	22003	interval precision was a single field and truncated whole
12112	07006	interval precision was not a single field
12113	22003	byte length of data is greater than buffer length
12114	01004	number of whole digits is less than buffer length
12115	22003	number of whole digits is greater equal than buffer length
12116	22009	invalid time zone displacement value
12117	42000	invalid number of arguments
12118	42000	inconsistent datatype of function parameters: %s
12119	42000	comparison is not applicable: %s and %s
12120	42000	conversion is not applicable: from %s to %s
12121	22021	invalid character value in character set repertoire
12122	22012	divisor is equal to zero
12123	22018	data is not boolean literal
12124	HY000	invalid argument for factorial function
12125	22027	trim set should have only one character
12126	22008	datetime field overflow
12127	HY000	invalid ROWID
12128	22019	invalid escape character
12129	HY000	invalid character set identifier
12130	HY000	invalid extract field for extract source
12131	42000	inconsistent datatypes: argument[%d] expected %s
12132	HY000	date format value exceeds maximum length (%d)
12133	HY000	date format not recognized
12134	HY000	format code appears twice
12135	HY000	%s conflicts with %s
12136	HY000	literal does not match format string
12137	HY000	input value not long enough for date format
12138	HY000	date format picture ends before converting entire input string
12139	HY000	year must be between %s and %s, and not be 0
12140	2200C	missing or illegal character following the escape character
12141	HY000	not a valid month
12142	HY000	a non-numeric character was found where a numeric was expected
12143	HY000	day of month must be between 1 and last day of month
12144	HY000	not a valid day of the week
12145	HY000	day of year must be between 1 and 365 (366 for leap year)
12146	HY000	format code cannot appear in date input format
12147	HY000	BC/B.C. or AD/A.D. required

Error code	SQLSTATE	Message
12148	HY000	julian date must be between 0 and 5373484
12149	HY000	%s may only be specified once
12150	HY000	Julian date precludes use of day of year
12151	HY000	Not enough format info buffer
12152	HY000	hour must be between %d and %d
12153	HY000	minute must be between 0 and 59
12154	HY000	second must be between 0 and 59
12155	HY000	the fractional seconds must be between 0 and 999999
12156	HY000	time zone hour must be between -14 and 14
12157	HY000	time zone minute must be between 0 and 59
12158	HY000	seconds in day must be between 0 and 86399
12159	HY000	AM/A.M. or PM/P.M. required
12160	HY000	HH24 precludes use of meridian indicator
12161	HY000	%s conflicts with use of %s
12162	HY000	invalid XID string
12163	HY000	date not valid for month specified
12164	HY000	signed year precludes use of BC/AD
12165	HY000	number format value exceeds maximum length (%d)
12166	HY000	invalid number format model
12167	HY000	cannot use %s twice
12168	HY000	cannot use %s and %s together
12169	22001	string data, right truncation
12170	HY000	argument '%d' is out of range
12171	HY000	invalid datepart for data type %s
12172	42000	maximum number of arguments exceeded
12173	42000	invalid char length units(%s): use OCTETS or CHARACTERS
12174	22023	The argument of %s function is invalid
12175	22023	The argument [%d] of %s function is invalid
12176	HY000	internal error, in a function %s
12177	HY000	not supported data type (%s)
12178	HY000	data type specifier is out of range (type : %d, range : %d to %d)
12179	HY000	precision specifier is out of range(type : %s, precision : %d, range : %d to %d)
12180	HY000	leading precision specifier is out of range(type : %s, precision : %d, range : %d to %d)
12181	HY000	scale specifier is out of range(type : %s, scale : %d, range : %d to %d)
12182	HY000	fractional second precision specifier is out of range(type : %s, precision : %d, range : %d to %d)
12183	HY000	character length unit specifier is out of range(type : %s, character length unit : %d, range : %d to %d)

Error code	SQLSTATE	Message
12184	HY000	interval indicator specifier is out of range(type : %s, indicator : %d, range : %d to %d)
12185	42000	%s and %s cannot be matched
12186	0A000	not supported function %s

A.3 Resource Management Related Error

- Error code: GOLDILOCKS-specific error code
- SQLSTATE: SQL standard state code
- Message: Error message

Table A-3 Resource management related error

Error code	SQLSTATE	Message
13000	HY000	Failed to initialize kernel layer
13001	HY000	kernel layer is not initialized yet
13002	HY000	Invalid argument
13003	HY000	Invalid shared memory segment type
13004	HY000	static shared memory segment is corrupted
13005	HY000	maximum number of shared memory segment num exceeded
13006	HY000	kernel layer internal error - %s
13007	42000	identifier is too long
13008	HY000	comment is too long
13009	42S02	fixed table does not exist
13010	HY000	Insufficient static area
13011	HY000	Unable to extend memory: [MAX: %ld, TOTAL: %ld, ALLOC: %ld] DESC: %s
13012	HY000	too many files are opened
13013	HY000	Property(%s) does not exist
13014	HY000	Unable to change property at this startup phase.(%s)
13015	0U000	Unable to change read-only property.(%s)
13016	22000	Invalid property value.(%s)
13017	0U000	Specified property cannot be modified.(%s)
13018	22000	Specified property cannot be modified with this SCOPE option.(%s)
13019	22000	Specified property cannot be modified.(%s)
13020	22000	Invalid GOLDILOCKS_DATA Directory
13021	22000	Invalid SID
13022	HY004	Invalid property data type
13023	22000	Invalid Property ID
13024	HY000	exceeded maximum number of processes
13025	HY000	File does not exist (%s)
13026	HY000	File exist (%s)
13027	HY000	File Process Error
13028	HY000	Property is not ReadOnly
13029	HY000	ReadOnly Property Already Setted
13030	HY000	Property File Parsing Error Line (%d)
13031	0A000	Unsupported return type is used

Error code	SQLSTATE	Message
13032	0A000	Function does not exist
13033	HY000	It can not make range
13034	RD000	Service is not available
13035	HY000	Specified Breakpoint name is not registered yet
13036	HY000	General abort error of Breakpoint
13037	HY000	Invalid Session Name
13038	HYT00	Exceeded maximum idle time
13039	HYT00	Exceeded maximum query time
13040	08S01	Communication link failure
13041	RD000	User session ID does not exist
13042	08004	Server rejected the connection
13043	HY008	operation canceled
13044	RD000	invalid process identifier
13045	08004	mismatched binary version - server(%s.%d.%d.%d), client(%s.%d.%d.%d.%d)
13046	HY000	session cannot be killed now
13047	22003	data is outside the range of the data type to which the number is being converted
13048	22015	one or more fields of data value were truncated during conversion
13049	HYC00	not implemented feature, in a function
13050	HY000	insufficient plan cache memory
13051	HY000	Unable to attach the shared memory segment. File does not exist(%s)
13052	42000	invalid dump option string: %s
13053	42000	dump object modified by concurrent statement
13054	42000	invalid numa map (%s)
13055	HY000	AS ADMIN must be executed in dedicated session
13056	HY000	unable to create file '%s' - already in use
13057	HY000	Property(%s) is desupported
13058	HY000	memory alloc size is too large: [MAX: %ld, ALLOC: %ld] DESC: (%d)%s
13059	HYT00	Exceeded maximum packet allocation time

A.4 Storage Management Related Error

- Error code: GOLDILOCKS-specific error code
- SQLSTATE: SQL standard state code
- Message: Error message

Table A-4 Storage management related error

Error code	SQLSTATE	Message
14000	HY000	Failed to initialize storage manager layer
14001	HY000	storage manager layer is not initialized yet
14002	HY000	Tablespace(%d) exceed datafile limit
14003	HY000	Tablespace(%d) is full
14004	HY000	Tablespace(%d) is already dropped
14005	HY000	System Tablespace is exists
14006	42000	Table is mutating, trigger/function may not see it
14007	RD000	deadlock detected
14008	24000	fetch out of sequence
14009	2200H	sequence generator limit exceeded
14010	22023	MAXVALUE cannot be made to be less than the current value
14011	22023	MINVALUE cannot be made to exceed the current value
14012	22023	cannot be made to be less than the current value
14013	22023	cannot be made to exceed the current value
14014	HY000	Fail to extend datafile(%u) of tablespace(%u) in Transaction(%ld)
14015	HY000	there is no extendible datafile in tablespace '%s'
14016	23001	some rows of base table violate uniqueness of index
14017	42000	invalid operation on fixed table or dump table
14018	42000	the operation is disallowed before %s startup phase
14019	HY000	log stream number string is invalid
14020	HY000	log stream %d already exists
14021	HY000	log group number string is invalid
14022	HY000	log group state must be INACTIVE or UNUSED
14023	HY000	log group %d already exists
14024	HY000	log member %s already exists
14025	42000	invalid dump option string: %s
14026	HYT00	resource busy or timeout expired
14027	HY000	datafile(%d,%d) is already dropped
14028	HY000	file '%s' is already exist
14029	HY000	sequence is not yet defined
14030	RD000	maximum index depth(%d) exceeded
14031	HY000	maximum key length(%d) exceeds

Error code	SQLSTATE	Message
14032	42000	can't serialize access for this transaction
14033	42000	unable to checkpoint in cds mode
14034	42000	unable to recover database in cds mode
14035	42000	some rows of base table violate not null constraint
14036	42000	invalid ROWID
14037	42000	Database is READ ONLY
14038	42000	unable to recover database in READ ONLY mode
14039	HY000	exceed segment MAXSIZE(%ld)
14040	HY000	Target object of dump table is mutating
14041	42000	cannot access the OFFLINE tablespace '%s'
14042	42000	cannot find the row (%ld)
14043	42000	file is already used in database '%s'
14044	42000	datafile not empty
14045	42000	cannot drop datafile of OFFLINE tablespace '%s'
14046	42000	file does not exist - '%s'
14047	42000	file is READ ONLY - '%s'
14048	42000	file is invalid or old version - '%s'
14049	42000	tablespace is not online - '%s'
14050	42000	tablespace is not offline - '%s'
14051	42000	media recovery required - '%s'
14052	42000	segment is unusable (physical id : %ld)
14053	RD000	insufficient resource for sort
14054	HY000	internal error (%s, %d)
14055	HY000	segment is corrupted (physical id : %ld)
14056	HY000	failed to apply redo log (lsn : %ld, lpsn : %d, physical id : %ld)
14057	HY000	dropping log group makes total log group count less than minimum log group count(%d)
14058	42000	log member is not exist - '%s'
14059	42000	log member is already used - '%s'
14060	HY000	CURRENT logfile is empty - '%s'
14061	HY000	next logfile to switch should be INACTIVE or UNUSED - '%s'
14062	42000	INITRANS must be less equal than MAXTRANS
14063	42000	cannot be added log member to exceed maximum log member count(%d)
14064	42000	the operation is disallowed at %s phase
14065	RD000	the instant table row length is too large
14066	RD000	the sort instant table key row length is too large
14067	HY000	cannot media recover; archive log mode not enabled
14068	HY000	logfile does not exist - '%s'
14069	HY000	cannot support ARCHIVELOG in cds mode
		control file is not recent; do media recovery with USING BACKUP CONTROLFILE

Error code	SQLSTATE	Message
14070	HY000	option
14071	HY000	cannot BACKUP; tablespace(%s) is offline
14072	HY000	cannot BACKUP; tablespace(%s) is temporary
14073	HY000	cannot BACKUP; tablespace is dropped
14074	HY000	cannot BACKUP; tablespace(%s) is already in backup
14075	HY000	cannot execute; tablespace(%s) is proceeding backup
14076	HY000	cannot END BACKUP; tablespace(%s) is not in backup
14077	HY000	cannot END BACKUP; none of the tablespaces are in backup
14078	HY000	cannot BACKUP; tablespace(%s) is proceeding other operation
14079	HY000	cannot BACKUP; database is already in backup
14080	HY000	cannot END BACKUP; database is not in backup
14081	HY000	cannot BACKUP; database is going shutdown
14082	HY000	(%s) is not an appropriate logfile to recover
14083	HY000	must use RESETLOGS option for database open
14084	HY000	must use NORESETLOGS option for database open
14085	HY000	(%s) was not a sufficiently old backup
14086	HY000	media recovery canceled
14087	HY000	cannot SHUTDOWN; backup in progress
14088	HY000	control file is corrupted
14089	HY000	LEVEL 0 INCREMENTAL BACKUP does not exist
14090	HY000	cannot flush logs; disabled log flushing
14091	HY000	(%s) is not valid logfile
14092	HY000	not exist incremental backup
14093	HY000	not exist valid incremental backup for tablespace(%s)
14094	HY000	datafile recovery required - datafile(%s) of tablespace(%s) corrupted
14095	HY000	backup file(%s) is corrupted
14096	23001	fail to build index (%ld)
14097	HY000	control file is corrupted - '%s'
14098	HY000	maximum record length(%d) exceeds
14099	HY000	log member state must be UNUSED or INACTIVE
14100	HY000	dropping log member makes log member count of group(%d) less than minimum log member count(%d)
14101	HY000	log group id does not exist - '%d'
14102	HY000	cannot execute; recovery is in progress
14103	01000	Warning: media recovery needs a logfile including log (Lsn %ld)
14104	01000	Warning: suggestion '%s'
14105	HY000	control file '%s' is inconsistent with primary
14106	HY000	tablespace (%s) is taken offline as the result of a write error
14107	HY000	given LOG_BLOCK_SIZE(%d) is not a suitable value for a size of log block; LOG_BLOCK_SIZE should be one of 512, 1024, 2048 or 4096.

Error code	SQLSTATE	Message
14108	HY000	cannot disable archivelog - exist tablespace needed media recovery.
14109	HY000	OFFLINE NORMAL disallowed; cannot be taken offline consistently.
14110	HY000	OFFLINE IMMEDIATE disallowed; noarchivelog mode
14111	HY000	cannot create COLUMNAR TABLE; given MIN ROW COUNT is too big to put into one page
14112	HY000	record size is too large for columnar table
14113	HY000	datafile '%s' is corrupted
14114	HY000	datafile '%s' is more recent than redo logfile
14115	HY000	transaction undo limit exceeded
14116	HY000	failed to journal log
14117	HY000	cannot end incomplete recovery; incomplete recovery never been begun
14118	HY000	property TRANSACTION_TABLE_SIZE value must be equal to or greater than '%d'
14119	HY000	property UNDO_RELATION_COUNT value must be equal to or greater than '%ld'
14120	HY000	sequence is dropped
14121	HY000	file '%s' does not match with database - file signature '%s', database signature '%s'
14122	HY000	there is a possibility that a deadlock occurs
14123	22023	INCREMENTBY sign cannot be changed in the cluster system
14124	HY000	RESTORE in progress
14125	HY000	exceed maximum journal file size
14126	HY000	there must be at least one recoverable member in the group
14127	HY000	object no longer exists
14128	HY000	invalid remote view scn
14129	HYT00	transaction allocation time exceeded
14130	HYT00	undo relation allocation time exceeded

A.5 Dictionary Cash Related Error

- Error code: GOLDILOCKS-specific error code
- SQLSTATE: SQL standard state code
- Message: Error message

Table A-5 Dictionary cash related error

Error code	SQLSTATE	Message
15000	HY000	failed to initialize execution library layer
15001	HY000	execution library layer is not initialized yet
15002	42000	%s: schema does not exist
15003	42000	%s: table or view does not exist
15004	42000	%s: index does not exist
15005	42000	%s: column does not exist
15006	23000	%s: dictionary integrity constraint violation by concurrent DDL execution
15007	HY090	not enough stack space to add entries
15008	HY000	table related objects are modified while validation
15009	HY000	Invalid argument
15010	42000	object modified by concurrent DDL execution
15011	HYC00	not implemented feature, in a function %s
15012	42000	user dropped by other session
15013	42000	user default schema dropped
15014	42000	user default data tablespace dropped
15015	42000	user default temporary tablespace dropped
15016	0Y002	limit(%d) on the number of named cursor exceeded
15017	42000	DDL not allowed for supplemental log table
15018	42000	cluster member '%s' has already joined in an other cluster system
15019	42000	the %s of cluster member '%s' is not compatible with the cluster system
15020	42000	tablespace '%s' of the cluster system does not exist at cluster member '%s'
15021	42000	tablespace '%s' of the cluster member '%s' does not exist at the cluster system
15022	42000	the %s of the tablespace '%s' at cluster member '%s' is not compatible with the cluster system
15023	HY000	limit(%d) on the number of named instant table exceeded
15024	42000	the cluster member '%s' does not join in a cluster system
15025	42000	startup phase of new cluster member should be OPEN
15026	HY000	internal error, in a function %s
15027	42000	attempt to create, alter or drop an index on temporary table already in use
15028	42000	user default index tablespace dropped

A.6 SQL Handling Related Error

- Error code: GOLDILOCKS-specific error code
- SQLSTATE: SQL standard state code
- Message: Error message

Table A-6 SQL handling related error (16000~16099)

Error code	SQLSTATE	Message
16000	HY000	failed to initialize sql processor layer
16001	HYC00	not implemented feature, in a function %s
16002	HY000	invalid function sequence of sql processor layer
16003	42000	identifier is too long
16004	28000	invalid username/password; logon denied
16005	42000	name '%s.%s' is already used by an existing object
16006	42000	schema '%s' does not exist
16007	42000	schema '%s' is not writable
16008	42000	tablespace '%s' does not exist
16009	42000	tablespace '%s' is not writable
16010	42000	invalid value for PCTFREE or PCTUSED
16011	42000	invalid INITRANS option value
16012	42000	duplicate column name
16013	HY000	invalid value is prevented in validation step
16014	22023	INCREMENT must be a non-zero integer
16015	22023	START WITH cannot be less than MINVALUE
16016	22023	START WITH cannot be more than MAXVALUE
16017	22023	the number of values to CACHE must be greater than 1
16018	22023	number to CACHE must be less than one cycle
16019	22023	MINVALUE must be less than MAXVALUE
16020	22023	INCREMENT must be less than MAXVALUE minus MINVALUE
16021	22023	descending sequences that CYCLE must specify MINVALUE
16022	22023	ascending sequences that CYCLE must specify MAXVALUE
16023	22023	duplicate or conflicting CACHE/NO CACHE specifications
16024	42000	numeric precision specifier is out of range(%d to %d)
16025	42000	numeric scale specifier is out of range(%d to %d)
16026	42000	character length specifier is out of range(1 to %d)
16027	42000	character varying length specifier is out of range(1 to %d)
16028	42000	binary length specifier is out of range(1 to %d)
16029	42000	binary varying length specifier is out of range(1 to %d)
16030	42000	name already used by an existing constraint
		auto-generated name already used by an existing constraint, specify unique con...

Error code	SQLSTATE	Message
16031	42000	straint name
16032	42000	table can have only one primary key
16033	42000	such unique or primary key already exists in the table
16034	42000	name already used by an existing index
16035	42000	auto-generated name already used by an existing index, specify non-duplicate index name
16036	42000	'%s': invalid identifier
16037	42000	maximum number of key columns exceeded
16038	23000	integrity constraint violation
16039	3B000	savepoint '%s' never established in this session or is invalid
16040	42000	table or view does not exist
16041	42000	table '%s' is not writable
16042	42000	unique/primary keys in table referenced by foreign keys
16043	42000	table referenced by views
16044	42000	sequence does not exist
16045	42000	duplicate options
16046	42000	such column list already indexed
16047	22003	numeric value out of range
16048	42000	specified index does not exist
16049	42000	index '%s' is not writable
16050	42000	cannot modify index used for enforcement of unique/primary/foreign key
16051	HY000	not applicable
16052	42000	column not allowed here
16053	42000	not enough values
16054	42000	too many values
16055	22004	NULL value not allowed
16056	22004	cannot insert NULL into "%s"."%s"."%s"
16057	23000	unique constraint (%s.%s) violated
16058	42000	not applicable hint
16059	42000	not applicable datatype
16060	07002	bind variable does not exist
16061	22004	cannot update ("%s"."%s"."%s") to NULL
16062	42000	syntax error
16063	42000	fractional seconds precision specifier is out of range(%d to %d)
16064	42000	invalid interval indicator
16065	42000	interval leading precision specifier is out of range(%d to %d)
16066	42000	interval fractional seconds precision specifier is out of range(%d to %d)
16067	42000	invalid INITIAL storage option value
16068	42000	invalid NEXT storage option value
16069	42000	invalid MINSIZE storage option value

Error code	SQLSTATE	Message
16070	42000	invalid MAXSIZE storage option value
16071	42000	storage option MAXSIZE is less than MINSIZE
16072	42000	duplicate or conflicting NULL and/or NOT NULL specifications
16073	42000	duplicate UNIQUE/PRIMARY KEY specifications
16074	42000	sequence number not allowed here
16075	42000	inconsistent datatypes : expected %s
16076	42000	invalid DATAFILE clause for alter of %s %s TABLESPACE
16077	42000	invalid DATAFILE clause for alter of %s %s TABLESPACE
16078	42000	invalid TEMPFILE clause for alter of %s %s TABLESPACE
16079	42000	file path is too long (< %d)
16080	RD000	file size is out of range(%ld to %ld)
16081	42000	failed to open database : system threads are already exist.
16082	42000	invalid MAXTRANS option value
16083	42000	INITRANS must be less equal than MAXTRANS
16084	42000	result OFFSET must be 0 or positive numeric value
16085	42000	result LIMIT/FETCH must be positive numeric value
16086	42000	related objects are modified by concurrent DDL execution
16087	42000	boolean expression expected on where clause
16088	HY000	session cannot be killed now
16089	28000	built-in authorization(user or role) '%s' is not modifiable
16090	42000	built-in tablespace '%s' is not modifiable
16091	42000	built-in schema '%s' is not modifiable
16092	42000	built-in table or view '%s' is not modifiable
16093	42000	built-in index '%s' is not modifiable
16094	42000	built-in constraint '%s' is not modifiable
16095	42000	built-in sequence '%s' is not modifiable
16096	28000	authorization(user or role) '%s' does not exist
16097	42000	constraint '%s' does not exist
16098	07006	bind type mismatch of parameter number (%d)
16099	42000	the number of elements in the INTO list is mismatch

Table A-7 SQL handling related error (16100~16199)

Error code	SQLSTATE	Message
16100	HY000	single-row subquery returns more than one row
16101	42000	parallel factor is out of range(0 to %d)
16102	42000	invalid MEMORY clause for alter of %s %s TABLESPACE
16103	3C000	cursor '%s' is already declared
16104	42000	invalid cursor query: '%s'
16105	42000	invalid cursor property

Error code	SQLSTATE	Message
16106	34000	cursor '%s' does not exist
16107	34000	cursor '%s' is already open
16108	34000	cursor '%s' is not open
16109	42000	invalid use: cursor '%s' is not a declared cursor
16110	42000	invalid use: cursor '%s' is not an ODBC/JDBC cursor
16111	42000	cursor '%s' is not scrollable
16112	42000	query expression is not updatable
16113	42000	invalid phase(%s): executable phase of '%s' is between %s and %s
16114	42000	database is already mounted
16115	42000	database is already open
16116	42000	transaction is READ ONLY
16117	42000	database not mounted
16118	42000	supplemental logging attribute primary key exists
16119	42000	cannot drop nonexistent primary key supplemental logging
16120	42000	column referenced by views
16121	42000	column has a check constraint defined
16122	42000	pseudo column not allowed here
16123	42000	cannot select ROWID from not writable table
16124	42000	table can have only one identity column
16125	42000	column being added already exists in table
16126	42000	table must be empty to add mandatory (%s) column ('%s')
16127	42000	cannot modify INITIAL storage option
16128	42000	name '%s' is already used by an existing tablespace
16129	42000	duplicate datafile name
16130	42000	file is already exist - '%s'
16131	42000	cannot rename the built-in tablespace
16132	42000	cannot rename the OFFLINE tablespace
16133	42000	cannot drop the built-in tablespace
16134	42000	cannot drop constraint - nonexistent constraint
16135	42000	cannot drop constraint - nonexistent primary key
16136	42000	cannot drop constraint - nonexistent unique key
16137	42000	the CDS database cannot be closed with ABORT option
16138	42000	the DS database can be closed with NORMAL option - deprecated
16139	42000	multiple ORDER BY clauses not allowed
16140	42000	multiple OFFSET clauses not allowed
16141	42000	multiple LIMIT clauses not allowed
16142	42000	column ambiguously defined
16143	42000	column part of USING clause cannot have qualifier
16144	42000	invalid OFFSET option value
16145	42000	invalid LIMIT option value

Error code	SQLSTATE	Message
16146	42000	common column name '%s' appears more than once in %s table
16147	42000	file is already used in database
16148	42000	tablespace not empty, use INCLUDING CONTENTS option
16149	42000	datafile does not exist in tablespace
16150	42000	cannot drop datafile of OFFLINE tablespace
16151	42000	cannot drop first datafile of tablespace
16152	42000	memory is already used in database
16153	42000	memory does not exist in tablespace
16154	42000	cannot drop first memory of tablespace
16155	42000	tablespace '%s' is not writable for logging index
16156	42000	tablespace '%s' is not writable for nologging index
16157	42000	ORDER BY item must be the number of a SELECT-list expression
16158	42000	group function is not allowed here
16159	42000	invalid number of arguments
16160	42000	group function is nested too deeply
16161	42000	not a single-group group function
16162	42000	mismatched datafile pairs
16163	42000	cannot rename datafile of ONLINE tablespace
16164	42000	file does not exist
16165	42000	tablespace is not online
16166	42000	tablespace is not offline
16167	42000	cannot offline temporary tablespace
16168	42000	cannot offline dictionary tablespace
16169	42000	cannot offline undo tablespace
16170	42000	invalid WAIT interval
16171	42000	column is not updatable
16172	22003	data is outside the range of the data type to which the number is being converted
16173	22015	one or more fields of data value were truncated during conversion
16174	42000	system session cannot be killed
16175	42000	hint not allowed in positioned DELETE
16176	42000	hint not allowed in positioned UPDATE
16177	34000	cursor '%s' is not updatable
16178	34000	cursor cannot identify the underlying table
16179	HY109	cursor was not positioned on a certain row
16180	HY109	cursor was positioned on a row that had been deleted
16181	42000	the CDS database cannot be closed with OPERATIONAL option
16182	42000	invalid segment identifier
16183	42000	FETCH position must be numeric value
16184	42000	cannot drop all columns in a table

Error code	SQLSTATE	Message
16185	42000	column already has a NOT NULL constraint
16186	42000	column does not have a NOT NULL constraint
16187	42000	null values found
16188	HY000	result set does not exist
16189	42000	column is not an identity column
16190	42000	column cannot be cast to incompatible type
16191	42000	column cannot be cast to decrease precision or scale
16192	42000	column cannot be cast to decrease string length
16193	42000	column cannot be cast to incompatible char length unit
16194	42000	column cannot be cast to incompatible interval indicator
16195	42000	float precision specifier is out of range(%d to %d)
16196	42000	file is already used in log stream - '%s'
16197	42000	duplicate logfile name
16198	42000	size of log file is smaller than minimum size of log file(%ld bytes).
16199	42000	can not find specified log member.

Table A-8 SQL handling related error (16200~16299)

Error code	SQLSTATE	Message
16200	42000	the number of source logfiles is different from the number of targets
16201	42000	can not find specified log file.
16202	42000	name '%s' is already used by an existing schema
16203	42000	schema not empty, use CASCADE option
16204	RD000	another checkpoint is in progress
16205	42000	boolean expression expected
16206	RD000	maximum number of arguments exceeded
16207	42000	%s and %s cannot be matched
16208	42000	insufficient privileges
16209	42000	user %s lacks CREATE SESSION privilege; logon denied
16210	42000	lacks privilege (%s ON DATABASE)
16211	42000	lacks privilege (%s ON TABLESPACE "%s")
16212	42000	lacks privilege (%s ON SCHEMA "%s")
16213	42000	user name '%s' conflicts with another user or role name
16214	42000	tablespace '%s' is not data tablespace
16215	42000	tablespace '%s' is not temporary tablespace
16216	28000	user '%s' does not exist
16217	42000	user has own schema: DROP SCHEMA first
16218	42000	CASCADE must be specified to drop user '%s'
16219	42000	you may not GRANT/REVOKE privileges to/from yourself
16220	42000	duplicate authorization name in grantee/revoker list

Error code	SQLSTATE	Message
16221	42000	user default schema dropped
16222	42000	user default data tablespace dropped
16223	42000	user default temporary tablespace dropped
16224	42000	no privileges to GRANT ALL PRIVILEGES
16225	42000	insufficient privilege to GRANT
16226	42000	duplicate privilege listed
16227	42000	cannot drop a user that is currently connected
16228	42000	fixed table not grantable/revokable
16229	42000	invalid old password
16230	42000	schema element does not match schema identifier
16231	28000	cannot GRANT/REVOKE privileges to/from built-in authorization
16232	28000	cannot REVOKE privileges you did not grant to '%s'
16233	HY000	OFFLINE IMMEDIATE disallowed; noarchivelog mode
16234	HY000	OFFLINE IMMEDIATE disallowed; no logging tablespace
16235	2B000	dependent privilege descriptors still exist
16236	0A000	not supported query%s
16237	42000	a subquery block has incorrect number of result columns
16238	42000	ORDER BY item must be the number of a SELECT-list expression
16239	42000	expression must have same datatype as corresponding expression
16240	42000	subquery expressions not allowed here
16241	42000	invalid number of column names specified
16242	42000	must name this expression with a column alias
16243	01000	Warning: View definition has compilation errors
16244	42000	bind variables not allowed for data definition operations
16245	42000	view "%s.%s" has errors
16246	42000	illegal use of %s data type
16247	HY000	cannot BACKUP; noarchivelog mode
16248	HY000	cannot RECOVER TABLESPACE; tablespace is in use
16249	HY000	cannot SHUTDOWN; backup in progress
16250	HY000	RECOVER UNTIL CANCEL can be issued by directly attached session only - deprecated
16251	42000	single-row subquery returns more than one row
16252	42000	circular view definition encountered
16253	42000	only base table columns are allowed to GRANT/REVOKE
16254	42000	lacks privilege (%s ON TABLE "%s"."%s")
16255	42000	lacks privilege (USAGE ON SEQUENCE "%s"."%s")
16256	07001	wrong number of parameters
16257	HY000	argument of CASE/WHEN must be type boolean
16258	HY000	the XID does not exist
16259	HY000	the XID string is not valid

Error code	SQLSTATE	Message
16260	HY000	the global transaction is in progress
16261	42000	invalid INCREMENTAL BACKUP LEVEL specified : %d
16262	42000	INCREMENTAL BACKUP LEVEL 0 cannot have any BACKUP options
16263	HY000	cannot RESTORE TABLESPACE; tablespace is in use
16264	HY000	transaction is in progress
16265	42000	outer join operator (+) cannot be used with ANSI joins
16266	42000	outer join operator (+) not allowed in %s
16267	42000	an outer join cannot be specified on a correlation column
16268	42000	a predicate may reference only one outer-joined table
16269	42000	a table may be outer joined to at most one other table
16270	42000	two tables cannot be outer-joined to each other
16271	42000	RESTART value cannot be made to be less than the MINVALUE
16272	42000	RESTART value cannot be made to exceed the MAXVALUE
16273	42000	MINVALUE cannot be made to exceed the current value
16274	42000	MAXVALUE cannot be made to be less than the current value
16275	42000	MINVALUE cannot be made to exceed the START WITH value
16276	42000	MAXVALUE cannot be made to be less than START WITH value
16277	42000	log group id is already used
16278	42000	identity column cannot have a default value
16279	42000	DEFAULT expression has errors
16280	42000	the statement is disallowed
16281	42000	resource manager doing work outside transaction
16282	42000	MEMORY tablespace does not support an AUTOEXTEND option
16283	HY000	invalid ROWID
16284	42000	unable to execute in CDS mode
16285	RP000	failed to create system threads
16286	HY000	valid incremental backup does not exist
16287	42000	log group id does not exist
16288	42000	invalid string value specified
16289	42000	into clause can have only one row
16290	42000	SHUTDOWN must be executed in dedicated session
16291	40002	transaction rollback: integrity constraint violation
16292	42000	column length specifier is out of range(1 to %d) for columnar table
16293	42000	columnar table does not support LONG VARCHAR and LONG VARBINARY
16294	42000	cannot defer a constraint that is not deferrable
16295	42000	invalid NOT NULL constraint specified on an identity column
16296	42000	constraint '%s' is not deferrable
16297	42000	duplicate constraint name specified
16298	42000	cannot make primary key supplemental log data with primary key constraint violation

Error code	SQLSTATE	Message
16299	42000	datafile does not exist in database

Table A-9 SQL handling related error (16300 ~ 16399)

Error code	SQLSTATE	Message
16300	42000	too many SQL resource
16301	42000	name '%s' is already used by an existing public synonym
16302	42000	private synonym '%s' to be dropped does not exist
16303	42000	public synonym '%s' to be dropped does not exist
16304	42000	looping chain of synonyms
16305	42000	synonym translation is no longer valid
16306	42000	expression is out of iteration time scope
16307	42000	constant value expression expected
16308	42000	invalid or redundant resource
16309	42000	the account is locked
16310	42000	the password will expire in %ld days
16311	42000	the password will expire soon
16312	42000	the password has expired
16313	42000	the password cannot be reused
16314	42000	cannot lock "SYS" account
16315	42000	profile '%s' already exists
16316	42000	function '%s' not found
16317	42000	profile '%s' has users assigned, cannot drop without CASCADE
16318	42000	profile '%s' does not exist
16319	42000	cannot assign PROFILE to "SYS" account
16320	42000	cannot assign DEFAULT parameter value to "DEFAULT" profile
16321	42000	password length less than '%d'
16322	42000	password must contain at least '%d' letter(s)
16323	42000	password must contain at least uppercase '%d' character(s)
16324	42000	password must contain at least lowercase '%d' character(s)
16325	42000	password must contain at least '%d' digit(s)
16326	42000	password must contain at least '%d' special character(s)
16327	42000	password same as or similar to user name
16328	42000	password contains the user name reversed
16329	42000	password same as or similar to database name
16330	42000	password too simple
16331	42000	Password should differ from the old password by at least '%d' characters
16332	42000	constant value does not support LONG VARCHAR and LONG VARBINARY
16333	42000	value of parameter number (%d) must be consistent datatype
16334	42000	invalid value is prevented in parameter number (%d)

Error code	SQLSTATE	Message
16335	42000	UPDATE primary key not allowed for supplemental log table
16336	42000	cluster group '%s' does not exist
16337	42000	duplicate cluster object listed
16338	42000	cluster domain '%s' does not exist
16339	42000	invalid hash shard count (must between %d and %d)
16340	42000	not found available sharding key column
16341	42000	cannot specify sharding strategy and placement for a table on dictionary schema '%s'
16342	HYC00	not implemented feature for cluster system, in a function %s
16343	42000	invalid syntax for a stand-alone system
16344	42000	database is not local opened
16345	42000	database is already opened
16346	42000	name '%s' is already used by an existing cluster object
16347	42000	cluster port is out of range(%d to %d)
16348	42000	duplicate cluster connection listed
16349	42000	the first cluster group does not contain local cluster member '%s'
16350	42000	maximum number of cluster members exceeded
16351	08000	failed to connect to the cluster member '%s'
16352	42000	mismatch local cluster member with location file
16353	42000	conflict between new cluster member and location file
16354	HY000	connection of member '%s' is broken
16355	42000	non-deterministic function not allowed here
16356	42000	version conflict
16357	42000	must be accessible to at least one member of group '%s'
16358	42000	accessible member does not exist
16359	42000	no inactive members
16360	42000	cloned table "%s"."%s" must be accessible to at least one member
16361	42000	sharded table "%s"."%s" must be accessible to at least one member of group '%s'
16362	42000	NODE SHARDED table cannot be rebalanced
16363	42000	the cluster member '%s' does not join in a cluster system
16364	42000	cluster group has sharded data
16365	42000	schema name of instant table must be SESSION_SCHEMA
16366	42000	hash shard count smaller than AT CLUSTER GROUP list
16367	42000	cannot drop sharding key column
16368	42000	not a fixed table
16369	42000	not a statistics table
16370	42000	have to create one or more datafiles to each member
16371	42000	conversion is not applicable
16372	42000	duplicate shard name

Error code	SQLSTATE	Message
16373	42000	the number of elements in shard bound mismatch the sharding key columns
16374	42000	range shard bound value must be one of: valid constant or MAXVALUE
16375	42000	only MAXVALUE allowed after MAXVALUE
16376	42000	multiple MAX shard defined
16377	42000	MAX shard not defined
16378	42000	duplicate shard bound value
16379	42000	failed to rebalance some tables
16380	HYC00	UNIQUE or PRIMARY KEY must include all sharding key columns for cluster system
16381	42000	invalid shard count (must between %d and %d)
16382	42000	cluster member '%s' does not exist
16383	42000	domain '%s' is unknown
16384	42000	multiple DEFAULT shard defined
16385	42000	DEFAULT shard not defined
16386	42000	DEFAULT cannot be specified with other values
16387	42000	list shard bound value must be one of: valid constant or NULL or DEFAULT
16388	HYC00	does not support deferrable constraints in the cluster system
16389	42000	domain names of the datafile for renaming don't mismatch
16390	42000	invalid table for sharding strategy and placement specified
16391	42000	the number of sharding key in function is mismatch
16392	HYC00	does not support ROWID in the cluster system
16393	01000	Warning: accessible member does not exist
16394	01000	Warning: connection of member '%s' is broken
16395	01000	Warning: must be accessible to at least one member of group '%s'
16396	42000	exceeds the maximum number of nodes
16397	42000	exceeds the maximum number of groups
16398	42000	the domain of property does not match with domain '%s'
16399	42000	cannot insert or update a generated always identity column, value shall be a DEFAULT

Table A-10 SQL handling related error (16400 ~ 16499)

Error code	SQLSTATE	Message
16400	HY000	cannot RECOVER UNTIL CHANGE SCN; invalid SCN format
16401	42000	invalid SAMPLE size specified
16402	42000	duplicate index name
16403	42000	failed to join some of nodes to the global database
16404	42000	cannot execute the statement with OS user permissions
16405	42000	some tables in the database need to be rebalanced
16406	42000	invalid routine name
16407	42000	procedure or function does not exist

Error code	SQLSTATE	Message
16408	42000	bind variables not allowed for procedures or functions
16409	01000	Warning: Routine definition has compilation errors
16410	42000	Startup driver node must have the latest data - a suitable startup driver node is '%s' member
16411	42000	maximum number of recursive SQL levels (%d) exceeded.
16412	42000	all of shards in a table must be online.
16413	42000	LOCAL_OFFLINE domain must be specified to base table
16414	42000	domain option not allowed here
16415	42000	LOCAL_OFFLINE domain cannot be used with other domains
16416	42000	lacks privilege (EXECUTE ON PROCEDURE "%s"."%s")
16417	42000	active member '%s' cannot be offlined
16418	42000	cluster member '%s' does not exist in cluster group '%s'
16419	42000	object identifier not allowed here
16420	0A000	does not support adding identity column in the cluster system
16421	0A000	does not support deferred unique integrity in the cluster system
16422	0A000	does not support SERIALIZABLE in the cluster system
16423	42000	does not support non-deterministic DML in the cluster system : global secondary index expected
16424	42000	function generating different values is not allowed here
16425	42000	procedure, function, package, or type is not allowed here
16426	42000	does not support ADD COLUMN DEFAULT generating different values in the cluster system
16427	42000	invalid events (%s)
16428	42000	cluster system is modified by concurrent cluster DDL execution
16429	42000	does not support cursor in the cluster system : global secondary index expected
16430	42000	the cluster database can be closed only with ABORT or NORMAL option
16431	42000	non-deterministic expression not allowed here : may lead to a replica synchronization failure
16432	42000	global secondary index already exists in table
16433	42000	global secondary index does not exist in table
16434	HY000	invalid grid is prevented in cluster operation, in a function %s
16435	HY000	duplicate source datafile name
16436	HY000	duplicate target datafile name
16437	HY000	cannot execute on cloned tables
16438	HY000	invalid shard name - '%s'
16439	HY000	cannot move shard to the same group
16440	HY000	cannot execute on cluster wide sharded tables
16441	42000	not analyzed table
16442	42000	invalid analyzed file format (%s)
16443	42000	old plan

Error code	SQLSTATE	Message
16444	42000	invalid cluster group name
16445	42000	REBALANCE EXCLUDE can be executed only on cluster wide sharded tables
16446	42000	REBALANCE EXCLUDE target group is empty
16447	HY000	internal error (%s, %d)
16448	42000	of the total '%d' tables, '%d' tables failed to move shard
16449	42000	cluster group does not have sharded data
16450	42000	exceeded global property lock timeout
16451	42000	rownum not allowed here
16452	42000	rownum not allowed in sensitive cursor
16453	42000	rownum not allowed in positioned UPDATE
16454	42000	function '%s' not allowed here
16455	42000	routine "%s.%s" has errors
16456	42000	the startup phase '%s' of cluster member '%s' is mismatch with the required startup phase '%s'
16457	42000	the connection map of cluster member '%s' is mismatch with local connection map
16458	42000	reserved domain cannot be used with other domains
16459	42000	cannot execute on hash sharded tables
16460	42000	cannot execute on range sharded tables
16461	42000	invalid shard values
16462	42000	cannot split shard - source shard cannot be empty
16463	42000	first CREATE CLUSTER GROUP must include only one cluster member
16464	HY000	unsupported feature with temporary table
16465	42000	cannot drop local cluster group
16466	42000	cannot execute with SERIALIZABLE
16467	42000	table '%s' is READ ONLY
16468	HY000	cannot create TEMPORARY object in a NON-TEMPORARY tablespace
16469	42000	cannot execute on global connection
16470	42000	datafile size specified is smaller than minimum required '%ld'
16471	42000	audit policy '%s' does not exist
16472	42000	audit policy cannot be dropped as it is currently enabled
16473	42000	audit policy '%s' already exists
16474	42000	not auditable option
16475	42000	audit policy already applied with the BY clause
16476	42000	audit policy already applied with the EXCEPT clause
16477	42000	not auditable object
16478	42000	tablespace '%s' is not temporary tablespace or data tablespace
16479	42000	failed to update system version - %s
16480	42000	cannot set irrecoverable on the local cluster member
16481	42000	global temporary table segment no longer exists

Error code	SQLSTATE	Message
16482	42000	database is not accessible; '%s' has detached from the cluster

A.7 PSM Related Error

- Error code: GOLDILOCKS-specific error code
- SQLSTATE: SQL standard state code
- Message: Error message

Table A-11 PSM related error

Error code	SQLSTATE	Message
17000	2F000	failed to initialize PSM processor layer
17001	2F000	not implemented feature (%s)
17002	2F000	duplicated label name
17003	2F000	duplicated exception name
17004	2F000	duplicated variable name
17005	2F000	not applicable expression type
17006	2F000	unknown variable or column name (%s)
17007	2F000	invalid expression
17008	2F000	wrong number of parameters
17009	2F000	NOT NULL constraint violation
17010	2F000	can not find label name
17011	2F000	duplicated field name
17012	2F000	unknown type name
17013	2F000	the type of record field should be scalar
17014	2F000	target host parameter of assignment is not bound in OUT mode
17015	2F000	cannot set constraint or initial value on non-scalar-type variable
17016	2F000	variables which have NOT NULL constraint should have initial values
17017	2F000	unhandled user exception
17018	2F000	pre-defined exception name not allowed in declare section
17019	2F000	OTHERS exception must be last among the exceptions of a block
17020	2F000	unknown exception
17021	2F000	Invalid error number for PRAGMA EXCEPTION_INIT
17022	2F000	A CASE statement must either list all possible cases or have an else clause
17023	2F000	duplicated error-code in same exception handler
17024	2F000	(%s) cannot be used as assignment target
17025	2F000	The command cannot be executed when global transaction is in the ACTIVE state
17026	2F000	Transaction is READ ONLY
17027	2F000	duplicated identifier
17028	2F000	out of scope
17029	2F000	too many depths of scope (limit=%d)
17030	2F000	invalid reference field (%s)

Error code	SQLSTATE	Message
17031	2F000	mismatch identifier type
17032	2F000	PSM compilation error
17033	2F000	duplicated cursor name
17034	2F000	return type of cursor is invalid
17035	2F000	invalid expression type
17036	2F000	cursor is not defined
17037	2F000	cursor is already open
17038	2F000	cursor is not open
17039	2F000	unknown cursor
17040	2F000	fetch target count mismatch
17041	2F000	execution fail
17042	2F000	bind variables not allowed for data definition operations
17043	2F000	no target-list for into clause
17044	2F000	returning-into need to bind variable with returning-into or using OUT clause
17045	2F000	no data found
17046	2F000	variables of record type can not be mixed with other variable
17047	2F000	only record-type variable allowed
17048	2F000	can not be used with INTO-clause and USING clause having OUT-modes
17049	2F000	can not use a expression in USING OUT binding
17050	2F000	query need to bind with INTO-clause for targets
17051	2F000	invalid statement-type
17052	2F000	Alias required in list of cursor to avoid duplicated target names
17053	2F000	schema or table object does not exist
17054	2F000	only record-type variable allowed
17055	2F000	this cursor must be declared with FOR-UPDATE to use with CURRENT OF
17056	2F000	invalid syntax error
17057	2F000	only select-into statement allowed
17058	2F000	source-name of return-type is not record-type or record-type variable
17059	2F000	source-name of rowtype must be a table, view, cursor, cursor-variable
17060	2F000	a cursor-variable with having return-type cannot be used in OPEN FOR dynamic-sql
17061	2F000	it can be allowed with only IN-Binding type
17062	2F000	duplicated routine name
17063	2F000	unknown routine name
17064	2F000	invalid routine name
17065	2F000	invalid routine object status
17066	2F000	a RAISE statement with no exception name must be inside an exception handler
17067	2F000	return types of Result Set variables or query do not match
17068	2F000	wrong number or types of arguments
17069	2F000	invalid variable usage

Error code	SQLSTATE	Message
17070	2F000	return statement in procedures or anonymous blocks cannot have <value> clause
17071	2F000	return statement in functions should have <value> clause
17072	2F000	existing state of routine has been discarded
17073	2F003	DDLs or DCLs cannot be invoked during DMLs or SELECT statements are executing in W"%sW".W"%sW"
17074	2F003	cannot begin transaction inside a query in W"%sW".W"%sW"
17075	2F003	cannot commit or rollback transaction inside a query or DML in W"%sW".W"%sW"
17076	2F000	application error W"%sW"
17077	2F000	the argument of collection type variable is not a constant expression
17078	2F000	a function with OUT-Parameter not allowed in expression
17079	2F000	a nested function not allowed in executing SQL
17080	2F002	cannot execute DML jobs inside a query
17081	2F000	program body of the routine is not defined
17082	HY000	bind parameter in target or return clause is not allowed
17083	2F000	Function "%s" returned without value

A.8 Session Related Error

- Error code: GOLDILOCKS-specific error code
- SQLSTATE: SQL standard state code
- Message: Error message

Table A-12 Session related error

Error code	SQLSTATE	Message
18000	HY000	Invalid Statement
18001	HY024	Invalid attribute value
18002	HY092	Invalid attribute/option identifier
18003	42000	Transaction is READ ONLY
18004	42000	Statement cannot execute as atomic action
18005	42000	Preparable phase is open phase
18006	08S01	Communication link failure
18007	HYC00	not implemented feature, in a function %s
18008	HY014	Limit on the number of SQL statement exceeded
18009	42000	The command cannot be executed when global transaction is in the ACTIVE state
18010	07009	Invalid descriptor index
18011	HY000	Character set not equal(%s and %s)
18012	HY010	fetch out of sequence
18013	HYC00	Optional feature not implemented
18014	07001	Wrong number of parameters
18015	24000	Invalid cursor state

A.9 ODBC Related Error

- Error code: GOLDILOCKS-specific error code
- SQLSTATE: SQL standard state code
- Message: Error message

Table A-13 ODBC related error

Error code	SQLSTATE	Message
19000	HY009	Invalid use of null pointer
19001	HY092	Invalid attribute/option identifier
19002	08003	Connection not open
19003	IM001	Driver does not support this function
19004	IM004	Driver's SQLAllocHandle on SQL_HANDLE_ENV failed
19005	IM005	Driver's SQLAllocHandle on SQL_HANDLE_DBC failed
19006	08002	Connection name in use
19007	HY090	Invalid string or buffer length
19008	28000	Invalid authorization specification
19009	HY010	Function sequence error
19010	24000	Invalid cursor state
19011	HY012	Invalid transaction operation code
19012	HYC00	Optional feature not implemented
19013	HY003	Invalid application buffer type
19014	07009	Invalid descriptor index
19015	HY004	Invalid SQL data type
19016	HY105	Invalid parameter type
19017	HY009	Invalid argument value
19018	HY011	Attribute cannot be set now
19019	HY024	Invalid attribute value
19020	25000	Invalid transaction state
19021	HY000	General error
19022	07005	Prepared statement not a cursor-specification
19023	22001	String data, right truncated
19024	HY007	Associated statement is not prepared
19025	HY092	Option type out of range
19026	22002	Indicator variable required but not supplied
19027	01S01	Error in row
19028	HY016	Cannot modify an implementation row descriptor
19029	HY091	Invalid descriptor field identifier
19030	07006	Restricted parameter value violation
19031	22015	Interval field overflow

Error code	SQLSTATE	Message
19032	22003	Numeric value out of range
19033	01004	String data, right truncated
19034	22018	Invalid character value for cast specification
19035	01S07	Fractional truncation
19036	22008	Datetime field overflow
19037	22007	Invalid datetime format
19038	08S01	Communication link failure
19039	HY000	An invalid SQL type has occurred
19040	34000	Invalid cursor name
19041	HY000	Failed to atomic execution
19042	HY110	Invalid driver completion
19043	IM012	DRIVER keyword syntax error
19044	08001	Client unable to establish connection
19045	HY096	Information type out of range
19046	IM002	Data source not found and no default driver specified
19047	HY106	Fetch type out of range
19048	HY100	Uniqueness option type out of range
19049	HY101	Accuracy option type out of range
19050	HY097	Column type out of range
19051	HY098	Scope type out of range
19052	HY099	Nullable type out of range
19053	HY021	Inconsistent descriptor information
19054	01S02	Option value changed
19055	HY109	Invalid cursor position
19056	HY107	Row value out of range
19057	HYT00	Timeout expired
19058	2C000	Invalid or unknown NLS parameter value specified
19059	HY020	Attempt to concatenate a null value
19060	HY019	Non-character and non-binary data sent in pieces
19061	HY000	Invalid 'odbc.ini' specification. property : [%s]
19062	IM008	Dialog failed
19063	40001	Transaction rollback
19064	40003	Statement completion unknown
19065	08S01	Communication link failure
19066	01000	General warning
19067	HY104	Invalid precision or scale value
19068	40003	Retry the transactional operations
19069	08S01	Failed to communicate with locator

A.10 JDBC Related Error

- Error code: GOLDILOCKS-specific error code
- SQLSTATE: SQL standard state code
- Message: Error message

Table A-14 JDBC related error

Error code	SQLSTATE	Message
21000	HV000	Not used error
21001	46001	Invalid connection url[%s]: [%s]
21002	46110	Unsupported feature: [%s]
21003	08S01	Invalid protocol: [%s]
21004	HV000	Invalid method call for read-only ResultSet
21005	08003	The Connection is already closed
21006	08003	The Statement is already closed
21007	08003	The ResultSet is already closed
21008	HV000	Invalid method call for forward-only ResultSet
21009	HV000	Invalid Wrapper type: [%s]
21010	HV000	Invalid argument: [%s]
21011	08000	Cannot connect to the server: %s
21012	08S01	Communication link failure: %s
21013	HV000	A mandatory property is omitted: [%s]
21014	HV000	Not a select query for executeQuery method
21015	HV000	The statement has produced a ResultSet
21016	HV000	This method cannot be called for a PreparedStatement
21017	HV000	Parameter type[%s] is mismatch with previous type[%s] during batch
21018	HV000	Lack of parameter: [%s]'th parameter
21019	HV000	No batch job added
21020	HV000	Batch job added
21021	22003	The value[%s] is out of range of [%s] type
21022	22026	The value length is mismatch[%s != %s]
21023	HV000	The value([%s] type) cannot be converted to [%s] type
21024	08000	The connection timeout expired: [%s millis]
21025	HV000	The column is not found: [%s]
21026	3B000	Savepoint error: %s
21027	HV000	Cannot execute the query in auto-commit mode
21028	24000	Invalid cursor position
21029	HV000	No column has been read
21030	HV000	Encoding error: [%s]
21031	HV000	Decoding error: [%s]

Error code	SQLSTATE	Message
21032	HV000	Stream error: [%s]
21033	HV000	Trying to read the deleted row
21034	HV000	Invalid interval format string: [%s]
21035	HV000	The Statement has an opened ResultSet
21036	HV000	The RowId object is unknown
21037	08000	The failover failed
21038	07009	The parameterIndex is not valid: [%s]
21039	HY000	No data read
21040	HY000	Invalid locator protocol version
21041	HY000	not matched locator protocol command sequence number
21042	HY000	Unable to open the file '%s'
21043	HY000	Unable to read the file '%s'
21044	HY000	Unable to close the file '%s'
21045	HY000	invalid INI file format
21046	HY000	Parameter[%s]'s input data type is mismatched with output data type

A.11 Embedded SQL Related Error

- Error code: GOLDILOCKS-specific error code
- SQLSTATE: SQL standard state code
- Message: Error message

Table A-15 Embedded SQL run-time library related error

Error code	SQLSTATE	Message
23000	42000	syntax error
23001	0A000	feature not supported
23002	HY000	Bind variable "%s" was not declared
23003	HY000	Application can't be initialized
23004	HY000	Application can't be finalized
23005	RD000	Service is not available
23006	RD000	Statement did not prepared
23007	08001	Client can't establish SQL-connection
23008	HY000	cursor "%s" is not open
23009	HY000	Application can't create semaphore
23010	HY000	Application can't destroy semaphore
23011	HY000	Application can't create allocator
23012	HY000	Application can't destroy allocator
23013	HY000	Application can't create symbol table
23014	HY000	Application can't destroy symbol table
23015	IM004	Driver's SQLAllocHandle on SQL_HANDLE_ENV failed
23016	IM001	Driver does not support ODBC 3.0
23017	HY000	Application can't allocate memory
23018	42000	Statement "%s" was not prepared
23019	42000	Descriptor name is too long
23020	HYC00	Not implemented feature, in a function %s
23021	07004	USING clause required for dynamic parameters
23022	07001	USING clause: illegal variable name/number
23023	07001	USING clause: not all variables bound
23024	07007	INTO clause required for result fields
23025	07001	INTO clause: illegal variable name/number
23026	07001	INTO clause: not all variables bound
23027	22002	null value, no indicator parameter
23028	07005	cursor "%s" statement is not a query
23029	08003	connection not open
23030	34000	cursor "%s" is not updatable
23031	08002	connection name "%s" in use

Error code	SQLSTATE	Message
23032	08002	duplicate connection context

Table A-16 Embedded SQL precompile related error

Error code	SQLSTATE	Message
41000	42000	syntax error
41001	0A000	feature not supported
41002	42000	Host variable "%s" not declared
41003	42000	Cursor "%s" not declared
41004	42000	"%s": file not exist
41005	42000	expression type does not match usage
41006	42000	Fatal error while doing embedded SQL preprocessing
41007	HY000	Precompiler can't create symbol table
41008	HY000	Precompiler can't destroy symbol table
41009	42000	identifier is too long
41010	42000	token "%s" is not valid in preprocessor expressions
41011	42000	multi-character character constant
41012	42000	floating constant in preprocessor expression
41013	42000	invalid suffix "%s" on integer constant
41014	42000	cursor name "%s" already declared
41015	07004	cursor "%s" is not a dynamic cursor
41016	42000	"%s" has no member named "%s"
41017	42000	storage size of "%s" isn't known
41018	42000	variable "%s" must be integer type
41019	42000	variable "%s" must be string type
41020	42000	invalid indicator variable type: indicator variable "%s" must have numeric type(char/short/int/long)
41021	42000	duplicate "%s"
41022	42000	both "%s" and "%s" in declaration specifiers
41023	42000	two or more data types in declaration specifiers
41024	42000	C++ punctuation sequences are not permitted
41025	42000	host variable expression has invalid type
41026	42000	typedef "%s" has invalid
41027	42000	too many 'define' macro (%d)
41028	42000	'%s' macro is already defined at line %d, in file %s
41029	42000	missing host variable
41030	42000	invalid getting groupid variable type: variable "%s" must have signed numeric type
41031	42000	invalid sql statement: getting groupid is available with select/update/delete/insert statement

A.12 Communication Related Error

- Error code: GOLDILOCKS-specific error code
- SQLSTATE: SQL standard state code
- Message: Error message

Table A-17 Communication related error

Error code	SQLSTATE	Message
24000	08S01	Communication link failure
24001	08S01	Invalid communication protocol
24002	22000	Invalid GOLDILOCKS_DATA Directory
24003	22000	not supported function
24004	22000	Invalid interprocess protocol
24005	22000	Unable to attach the shared memory segment. unable to access the file '%s'
24006	HV090	Invalid string length or buffer length
24007	22000	not matched command sequence number

Table A-18 Server communication related error

Error code	SQLSTATE	Message
52000	08S01	Communication link failure
52001	08000	Invalid communication protocol
52002	HY000	Not enough cm unit memory
52003	HY000	exceeded maximum packet allocation timeout

A.13 ServerLibrary Related Error

- Error code: GOLDILOCKS-specific error code
- SQLSTATE: SQL standard state code
- Message: Error message

Table A-19 ServerLibrary related error

Error code	SQLSTATE	Message
25000	0A000	feature not supported
25001	HY000	Server is not running
25002	HY000	Environment Variable "%s" is not defined
25003	08000	Invalid protocol
25004	HY000	STARTUP must be executed in dedicated session
25005	HY000	session killed
25006	HY000	remote session is not opened
25007	42000	the property '%s' of cluster member '%s' is not compatible with the cluster system
25008	42000	the scn '%s' of cluster member '%s' is mismatch
25009	HY000	number of shared servers must be greater than or equal to number of request queues
25010	42000	invalid startup phase

A.14 gsql/ gsqlnet Related Error

- Error code: GOLDILOCKS-specific error code
- SQLSTATE: SQL standard state code
- Message: Error message

Table A-20 gsql/ gsqlnet related error

Error code	SQLSTATE	Message
40000	42000	syntax error
40001	0A000	feature not supported
40002	HY000	Bind variable "%s" not declared
40003	42000	"%s": table or view does not exist.
40004	42000	"%s": index does not exist.
40005	RD000	Service is not available
40006	RD000	Statement did not prepared
40007	42000	'%s': duplicate statement
40008	42000	'%s': statement does not exist
40009	42000	'%s': statement is not prepared
40010	42000	insufficient privileges
40011	42000	driver does not support %s function
40012	42000	invalid object for describe
40013	42000	driver does not support the requested connection mode(%s)
40014	HY000	the rollback was caused by an unspecified reason
40015	HY000	the rollback was caused by a communication failure
40016	HY000	a deadlock was detected
40017	HY000	a condition that violates the integrity of the resources was detected
40018	HY000	the resource manager rolled back the transaction branch for a reason not on this list
40019	HY000	a protocol error occurred in the resource manager
40020	HY000	a transaction branch took too long
40021	HY000	may retry the transaction branch
40022	HY000	the inclusive upper bound of the rollback codes
40023	HY000	resumption must occur where suspension occurred
40024	HY000	the transaction branch may have been heuristically completed
40025	HY000	the transaction branch has been heuristically committed
40026	HY000	the transaction branch has been heuristically rolled back
40027	HY000	the transaction branch has been heuristically committed and rolled back
40028	HY000	routine returned with no effect and may be re-issued
40029	HY000	the transaction branch was read-only and has been committed
40030	HY000	asynchronous operation already outstanding

Error code	SQLSTATE	Message
40031	HY000	a resource manager error occurred in the transaction branch
40032	HY000	the XID is not valid
40033	HY000	invalid arguments were given
40034	HY000	routine invoked in an improper context
40035	HY000	resource manager unavailable
40036	HY000	the XID already exists
40037	HY000	resource manager doing work outside transaction
40038	HY000	unknown xa error
40039	HY000	marked the transaction branch rollback-only for unspecified reason
40040	HY000	cannot open the resource
40041	HY000	cannot close the resource
40042	HY000	the sql is empty
40043	HY000	invalid host variable type
40044	08003	connection does not exist
40045	HY000	invalid NUMSIZE value: NUMSIZE must be between %d and %d
40046	HY000	invalid PAGESIZE value: PAGESIZE must be between %d and %d
40047	HY000	invalid LINESIZE value: LINESIZE must be between %d and %d
40048	HY000	invalid COLSIZE value: COLSIZE must be between %d and %d
40049	HY000	invalid HISTORY value: HISTORY must be less equal than %d
40050	HY000	invalid DDLSIZE value: DDLSIZE must be between %d and %d
40051	HY000	invalid object identifier
40052	HY000	not enough DDLSIZE. use command: Wset ddlsiz {n}
40053	HY000	confirmation password mismatch
40054	HY000	invalid locator ini property - '%s'
40055	HY000	not exist member '%s' in file - '%s'
40056	HY000	some of nodes were failed to startup
40057	HY000	not specified valid location information
40058	HY000	some of nodes were failed to shutdown
40059	HY000	failed to connect to original driver node '%s' after startup
40060	HY000	cannot execute 'cstartup' or 'cshutdown' command in DA mode
40061	HY000	currently connected node is inactive

A.15 gloader/ gloadernet Related Error

- Error code: GOLDILOCKS-specific error code
- SQLSTATE: SQL standard state code
- Message: Error message

Table A-21 gloader/ gloadernet related error

Error code	SQLSTATE	Message
42000	RD000	Service is not available
42001	HY000	invalid control file format
42002	HY000	buffer exceeded overflow area
42003	HY000	open same file(%s)
42004	HY000	occur invalid handle error
42005	HY000	occur error while operating SQLGetDiagRec/SQLGetDiagField
42006	HY000	using same character for delimiter and qualifier
42007	HY000	invalid thread unit count.(1~32)
42008	HY000	invalid array size.(1~65535)
42009	HY000	unavailable multithreading in export mode.
42010	08S01	Communication link failure
42011	HY000	invalid file size (minimum size : %d)
42012	HY000	unavailable file size in text mode.
42013	HY000	invalid column type.
42014	HY000	invalid column count.
42015	HY000	invalid data size.
42016	HY000	invalid header of binary file.
42017	HY000	file is empty.
42018	HY000	Qualifier must be 1 length character.
42019	HY000	LF and CR can not be used for delimiter or qualifier.
42020	HY000	qualifiers and terminators must not be subsets of each other
42021	HY000	table name must be given in case of absence of control file.
42022	HY000	can not fetch schema name.
42023	22001	byte length of data greater than column length.
42024	HY000	invalid direct io size

A.16 gmaster Related Error

- Error code: GOLDILOCKS-specific error code
- SQLSTATE: SQL standard state code
- Message: Error message

Table A-22 gmaster related error

Error code	SQLSTATE	Message
44000	HY000	database is already mounted
44001	HY000	database is already local opened
44002	HY000	database is already opened
44003	HY000	system thread is already created
44004	HY000	failed to create system threads (%s)
44005	HY000	member '%s' does not exist
44006	HY000	fail to send packet through communication context
44007	HY000	failed to start up a process '%s'

A.17 glsnr Related Error

- Error code: GOLDILOCKS-specific error code
- SQLSTATE: SQL standard state code
- Message: Error message

Table A-23 glsnr related error

Error code	SQLSTATE	Message
45000	HY000	Listener configuration file "%s" doesn't exist.
45001	HY000	Environment Variable "%s" is not defined.
45002	HY000	Listener is already started.
45003	HY000	overflow fd
45004	08000	Invalid communication protocol
45005	08004	access denied
45006	HY000	Operation timed out
45007	HY000	shared mode inactive
45008	HY000	Invalid property value [DEDICATED SHARED] : %s
45009	HY000	Invalid property value [NO INVITED EXCLUDED] : %s
45010	HY000	Invalid property value [YES NO 1 0]: %s
45011	HY000	Invalid property value [%ld ~ %ld]: %s
45012	HY000	Invalid property value [%ld ~ %ld]: %s
45013	HY000	buffer over flow %s

A.18 cyclone Related Error

- Error code: GOLDILOCKS-specific error code
- SQLSTATE: SQL standard state code
- Message: Error message

Table A-24 cyclone related error

Error code	SQLSTATE	Message
46000	RD000	Service is not available
46001	HY000	"%s": file does not exist
46002	HY000	configure file processing error
46003	HY000	"%s": table does not exist
46004	HY000	"%s": schema does not exist
46005	HY000	"%s.%s": previously Added. Maybe duplicated
46006	HY000	"%s%s": table must have a primary key
46007	HY000	internal error occurred (%s)
46008	HY000	invalid Datatype(%d)
46009	HY000	"%s.%s" table must set supplemental log or primary key.
46010	HY000	group [%s] is already running
46011	HY000	cyclone is not running
46012	HY000	GOLDILOCKS_DATA system environment is invalid
46013	HY000	"%s" log file reused or invalid. restart cyclone with '--reset' option
46014	HY000	fail to analyze flow[%s]
46015	HY000	Invalid Port Number (1024 ~ 49151) [%s]
46016	HY000	Communication link failure
46017	HY000	Invalid Protocol value (%s)
46018	HY000	Master disconnect abnormally
46019	HY000	Protocol Error Occurred (%s)
46020	HY000	Already Slave Connected
46021	HY000	Invalid Transaction Slot Id
46022	HY000	Invalid Supplemental Log (%d)
46023	HY000	Invalid operation for DDL
46024	HY000	Invalid value to analyze
46025	HY000	Invalid group name
46026	HY000	Not set master ip
46027	HY000	Invalid capture information
46028	HY000	There is no group in configure
46029	HY000	Duplicate group name (%s)
46030	HY000	Invalid Value : %s(%ld)
46031	HY000	Too low value : %s(%ld)

Error code	SQLSTATE	Message
46032	HY000	Invalid Host Port(%d)
46033	HY000	Redo Log file Read Timeout (%s)
46034	HY000	Invalid Archive Log File (%s)
46035	HY000	Invalid Temporary File (%s)
46036	HY000	Fail to write file (%s)
46037	HY000	Fail to Update State (%s)
46038	HY000	Fail to set Propagate mode at Session
46039	HY000	There is no active redo log file.
46040	HY000	There is no restart information. Master Database must be started first.
46041	HY000	Can Not Add New Table. Master Database must be started first.(%s.%s)
46042	HY000	Master Database must be started for the first time.
46043	HY000	Invalid Meta File(%s).
46044	HY000	Redo Log File does not exist(%s).
46045	HY000	USER_ID or USER_PW does not exist.
46046	HY000	Slave is not running with --sync option.
46047	HY000	Invalid Connect Information for sync (%s)
46048	HY000	(%s) value is too long
46049	HY000	Invalid encrypt/decrypt key
46050	HY000	no '--key' option
46051	HY000	password already exists (use one of USER_PW or USER_ENCRYPT_PW)
46052	HY000	reset or sync table (%s.%s) has never participated in replication
46053	HY000	reset or sync argument is invalid (%s)
46054	HY000	Table meta file has broken. please restart with '--reset all'
46055	HY000	protocol timeout
46056	HY000	Slave stopped normally
46057	HY000	Cannot use reset and sync option at the same time.
46058	HY000	There is no (%s.%s) table to sync (--sync option)
46059	HY000	(%s.%s) table (%s) column is not acceptable(GENERATED ALWAYS AS IDENTITY)
46060	HY000	driver does not support %s function
46061	HY000	data type is not supported.
46062	HY000	Cluster information does not matched(before groupid(%d), memberid(%d)/current groupid(%d), memberid(%d))
46063	HY000	Invalid cluster information at configure file(%s)
46064	HY000	Fail to rollback transaction

A.19 LogMirror Related Error

- Error code: GOLDILOCKS-specific error code
- SQLSTATE: SQL standard state code
- Message: Error message

Table A-25 LogMirror related error

Error code	SQLSTATE	Message
47000	RD000	Service is not available
47001	HY000	Invalid Protocol value (%s)
47002	HY000	"%s": file does not exist
47003	HY000	configure file processing error
47004	HY000	invalid Control file
47005	HY000	Communication link failure
47006	HY000	LogMirror is already running
47007	HY000	GOLDILOCKS_DATA system environment is invalid
47008	HY000	There is no Shared Memory Area for LogMirror
47009	HY000	Invalid Value : %s(%s)
47010	HY000	Invalid port : (%d)
47011	HY000	Master disconnect abnormally
47012	HY000	Invalid Log File(%s)
47013	HY000	Archive Log File does not exist
47014	HY000	Archive Log file Read Timeout (%s)
47015	HY000	LogMirror is not running
47016	HY000	Connection Information does not exist
47017	HY000	Infiniband Receive Fail. (%ld)
47018	HY000	GOLDILOCKS Shutdown or Give-up LogMirror Service.
47019	HY000	Invalid encrypt/decrypt key
47020	HY000	no '--key' option
47021	HY000	password already exists(use one of USER_PW or USER_ENCRYPT_PW)
47022	HY000	protocol heartbeat timeout

A.20 cymon Related Error

- Error code: GOLDILOCKS-specific error code
- SQLSTATE: SQL standard state code
- Message: Error message

Table A-26 cymon related error

Error code	SQLSTATE	Message
48000	HY000	GOLDILOCKS_DATA system environment is invalid
48001	HY000	"%s": file does not exist
48002	RD000	Service is not available
48003	HY000	configure file processing error
48004	HY000	Duplicate group name (%s)
48005	HY000	Invalid Value : %s(%ld)
48006	HY000	Invalid group name
48007	HY000	Invalid Port Number (1 ~ 65535)
48008	HY000	There is no group in configure
48009	HY000	cymon is already running
48010	HY000	Communication link failure
48011	HY000	Protocol Error Occurred (%s)
48012	HY000	Already Monitor Connected
48013	HY000	cymon is not running
48014	HY000	internal error occurred (%s)
48015	HY000	Fail to update monitoring info
48016	HY000	USER_ID or USER_PW does not exist.
48017	HY000	Invalid encrypt/decrypt key
48018	HY000	no '--key' option
48019	HY000	password already exists(use one of USER_PW or USER_ENCRYPT_PW)

A.21 gdispatcher Related Error

- Error code: GOLDILOCKS-specific error code
- SQLSTATE: SQL standard state code
- Message: Error message

Table A-27 gdispatcher related error

Error code	SQLSTATE	Message
50000	HY000	Dispatcher is already started
50001	HY000	overflow fd

A.22 gbalancer Related Error

- Error code: GOLDILOCKS-specific error code
- SQLSTATE: SQL standard state code
- Message: Error message

Table A-28 gbalancer related error

Error code	SQLSTATE	Message
51000	HY000	overflow fd

A.23 gsyncher Related Error

- Error code: GOLDILOCKS-specific error code
- SQLSTATE: SQL standard state code
- Message: Error message

Table A-29 gsyncher related error

Error code	SQLSTATE	Message
53000	HY000	invalid phase(%s): executable phase is %s
53001	HY000	GOLDILOCKS_DATA system environment is invalid
53002	HY000	gmaster is active
53003	HY000	gsyncher is already running
53004	HY000	Shared memory is cleared

A.24 Cluster Related Error

- Error code: GOLDILOCKS-specific error code
- SQLSTATE: SQL standard state code
- Message: Error message

Table A-30 Cluster related error

Error code	SQLSTATE	Message
56000	HY000	location information of member '%s' already exists
56001	HY000	location information of member '%s' does not exist
56002	HY000	location information of member '%s' is modified by concurrent execution
56003	HY000	has inactive member (%s)
56004	HY000	location file is corrupted - '%s'
56005	HY000	connections of some cluster members are broken
56006	40000	transaction rollback: failed to prepare global transaction
56007	HY000	must be accessible to at least one of replicas
56008	40000	transaction rollback: failed to synchronize replicas
56009	HY000	remote server (member ID: %ld) is abnormally terminated
56010	40000	transaction rollback: remote session is abnormally terminated
56011	HY000	a shared session cannot modify NUMA property
56012	HY000	no connection was established to recover in-doubt transactions
56013	HY000	cannot resolve in-doubt transaction
56014	HY000	MAX_NODE_COUNT property value '%d' must be equal to or less than '%d'
56015	HY000	'%s' property value must be greater than or equal to '%s' property value '%d'
56016	HY000	all members affected by the transaction are inactive - cannot guarantee durability of the transaction
56017	40000	transaction rollback: failed to open remote session
56018	HY000	protocol payload size(%ld) exceed maximum packet size(%ld)
56019	HY000	failover busy
56020	HY000	internal error (%s, %d)
56021	HY000	exceeded maximum response timeout
56022	HY000	failed to connect to an host

A.25 cserver Related Error

- Error code: GOLDILOCKS-specific error code
- SQLSTATE: SQL standard state code
- Message: Error message

Table A-31 cserver related error

Error code	SQLSTATE	Message
57000	HY000	sample error

A.26 cdispatcher Related Error

- Error code: GOLDILOCKS-specific error code
- SQLSTATE: SQL standard state code
- Message: Error message

Table A-32 cdispatcher related error

Error code	SQLSTATE	Message
58000	HY000	the sender failed to connect to the member(%d)
58001	HY000	the socket of target member '%s' is already disconnected
58002	HY000	the location information for member '%s' is not found
58003	HY000	the connection information is invalid; %s %d is either equal to or greater than %d
58004	HY000	the connection timeout from remote(%d)
58005	HY000	the disconnection timeout from remote(%d)
58006	HY000	invalid connection state transition
58007	HY000	dispatcher thread counts of two hosts do not match
58008	HY000	failed to start '%s' thread of cluster dispatcher
58009	HY000	internal error (%s, %d)
58010	HY000	broken socket
58011	HY000	old cluster connection is still alive
58012	HY000	failover event is in progress
58013	HY000	the connection can be established at LOCAL OPEN or OPEN phase

A.27 gtrclogger Related Error

- Error code: GOLDILOCKS-specific error code
- SQLSTATE: SQL standard state code
- Message: Error message

Table A-33 gtrclogger related error

Error code	SQLSTATE	Message
59000	HY000	exceeded port cnt
59001	HY000	gtrclogger is already running
59002	HY000	gtrclogger is not running
59003	HY000	Operation timed out
59004	22000	Invalid GOLDILOCKS_DATA directory

A.28 glocator Related Error

- Error code: GOLDILOCKS-specific error code
- SQLSTATE: SQL standard state code
- Message: Error message

Table A-34 glocator related error

Error code	SQLSTATE	Message
60000	HY000	syntax error
60001	HY000	file does not exist - '%s'
60002	HY000	GOLDILOCKS_DATA system environment is invalid
60003	HY000	Invalid value - %s(%s)
60004	HY000	file name is too long - '%s'
60005	HY000	glocator is already started.
60006	HY000	Location file is corrupted - '%s'
60007	HY000	Property value is out of length - '%s'
60008	HY000	Invalid property value [YES NO 1 0] - '%s'
60009	HY000	Invalid property value [%ld ~ %ld] - '%s'
60010	HY000	Invalid property value [%ld ~ %ld] - '%s'
60011	HY000	File is already exist - '%s'
60012	HY000	Location file exceeded max size(%ld) - over size(%ld)
60013	HY000	Not exist node information - '%s'
60014	HY000	Exceeded response time for failover.
60015	HY000	Node is on failover - '%s'
60016	HY000	Need more alternate locator host information.
60017	HY000	Invalid configure file specification - property:[%s]
60018	HY000	Failed to propagate - '%s:%d'

A.29 gloctl Related Error

- Error code: GOLDILOCKS-specific error code
- SQLSTATE: SQL standard state code
- Message: Error message

Table A-35 gloctl related error

Error code	SQLSTATE	Message
61000	HY000	Syntax error
61001	HY000	File is not exist - '%s'
61002	HY000	Can not find any ini object in file - '%s'
61003	HY000	Dsn is not exist - '%s'
61004	HY000	ADD MEMBER keyword syntax is error - '%s'
61005	HY000	ADD SERVICE keyword syntax is error - '%s'
61006	HY000	Invalid property value [YES NO 1 0] - '%s'
61007	HY000	Invalid property value [%ld ~ %ld] - '%s'
61008	HY000	Invalid property value [%ld ~ %ld] - '%s'
61009	HY000	STL_ENV_DB_DATA system environment is invalid
61010	HY000	Keyword syntax is invalid - '%s'
61011	HY000	Data value is invalid - '%s'

A.30 gmon Related Error

- Error code: GOLDILOCKS-specific error code
- SQLSTATE: SQL standard state code
- Message: Error message

Table A-36 gmon related error

Error code	SQLSTATE	Message
62000	HY000	gmon is already running
62001	HY000	process(%ld) did not respond signal
62002	HY000	GOLDILOCKS_DATA system environment is invalid

A.31 gagent Related Error

- Error code: GOLDILOCKS-specific error code
- SQLSTATE: SQL standard state code
- Message: Error message

Table A-37 gagent related error

Error code	SQLSTATE	Message
63000	HY000	GOLDILOCKS_DATA system environment is invalid
63001	HY000	Property value is out of length - '%s'
63002	HY000	Invalid property value [YES NO 1 0] - '%s'
63003	HY000	Invalid property value [%ld ~ %ld] - '%s'
63004	HY000	Invalid property value [%ld ~ %ld] - '%s'
63005	HY000	gagent is already started.
63006	HY000	file name is too long - '%s'
63007	HY000	file does not exist - '%s'
63008	HY000	Database is not cluster.
63009	HY000	Invalid configure file specification - property:[%s]
63010	HY000	Invalid phase(%s): executable phase is between %s and %s
63011	HY000	Property PORT of dsn(%s) is not set in file 'odbc.ini'

Appendix B.

Wait Event

B.1 Wait Event

Performance views which is related to the wait event is as follows.

- v\$system_event **V\$SYSTEM_EVENT**
- v\$session_event **V\$SESSION_EVENT**
- v\$session_wait **V\$SESSION_WAIT**
- v\$wait_event_name **V\$WAIT_EVENT_NAME**
- v\$wait_event_class_name **V\$WAIT_EVENT_CLASS_NAME**

B.2 Class of Wait Event

- Administrative: Waits resulting from DBA commands that cause users to wait (for example, an index rebuild)
- Application: Waits resulting from user application code (for example, lock waits caused by row level locking or explicit lock commands)
- Cluster: Waits related to cluster resources (for example, global cache resources)
- Commit: This wait class only comprises one wait event - wait for redo log write confirmation after a commit (that is, 'log file sync')
- Concurrency: Waits for internal database resources (for example, latches)
- Configuration: Waits caused by inadequate configuration of database or instance resources (for example, undersized log file sizes, shared pool size)
- Idle: Waits that signify the session is inactive, waiting for work (for example, 'gsql message from client')
- Network: Waits related to network messaging
- Other: Waits which should not typically occur on a system
- Scheduler: Resource manager related waits
- System IO: Waits for background process IO
- User IO: Waits for user IO

B.3 Item of Wait Event

ENQUEUE: GDISPATCHER REQUEST

It is the time of which GDISPATCHER enqueues a request in a shared mode.

Parameter: None

ENQUEUE: SHARED-SERVER RESPONSE

It is the time of which a shared server enqueues a response in a shared mode.

Parameter: None

DEQUEUE: SHARED-SERVER REQUEST

It is the time of which a shared server dequeues a request in a shared mode.

Parameter: None

DEQUEUE: GDISPATCHER RESPONSE

It is the time of which GDISPATCHER dequeues a response in a shared mode.

Parameter: None

SEND: DEDICATE-SERVER SPOOLED RESPONSE

It is the time of which a dedicate server sends the spooled response to the client in a dedicate mode.

Parameter	Description
send data size	Bytes of the data to be sent

SEND: DEDICATE-SERVER RESPONSE

It is the time of which a dedicate server sends a response to the client in a dedicate mode.

Parameter	Description
send data size	Bytes of the data to be sent

RECV: DEDICATE-SERVER REQUEST

It is the time of which a dedicate server receives a request from the client in a dedicate mode.

Parameter: None

SEND: GDISPATCHER RESPONSE

It is the time of which GDISPATCHER sends a response to a client in a shared mode.

Parameter	Description
send data size	Bytes of the data to be sent

RECV: GDISPATCHER REQUEST

It is the time of which GDISPATCHER receives a request from a client in a shared mode.

Parameter: None

ENQUEUE: CLUSTER REQUEST

It is the time of enqueueing a request of cluster.

Parameter: None

ENQUEUE: CLUSTER BROADCAST REQUEST

It is the time of enqueueing a broadcast request of cluster.

Parameter: None

DEQUEUE: CLUSTER RESPONSE

It is the time of dequeuing a response of cluster.

Parameter: None

SEND: CDISPATCHER

It is the time of sending in cluster CDISPATCHER.

Parameter: None

RECV: CDISPATCHER

It is the time of receiving in cluster CDISPATCHER.

Parameter: None

GMASTER: ARCHIVE LOG

It is the time of processing archive logs in gmaster.

Parameter: None

GMASTER: CHECKPOINT

It is the time of processing checkpoints in gmaster.

Parameter: None

GMASTER: IO SLAVE

It is the time of processing IO slave in gmaster.

Parameter: None

GMASTER: LOG FLUSH

It is the time of processing archive logs in gmaster.

Parameter: None

GMASTER: PAGE FLUSH

It is the time of processing page flush in gmaster.

Parameter: None

WRITE: TRACE LOG

It is the time of writing trace logs.

Parameter: None

WRITE: COPY ARCHIVING LOG

It is the time of copying archiving logs.

Parameter: None

WRITE: BACKUP CTRL FILE

It is the time of backing up control files.

Parameter: None

WRITE: RESTORE CTRL FILE

It is the time of restoring the control file.

Parameter: None

READ: ARCHIVE LOG

It is the time of reading archive log files.

Parameter: None

READ: CTRL FILE

It is the time of reading the control file.

Parameter: None

WRITE: LOG FILE

It is the time of writing log files.

Parameter: None

WRITE: PAGE FILE

It is the time of writing page files.

Parameter: None

WRITE: CTRL FILE

It is the time of writing the control file.

Parameter: None

WRITE: REMOVE DATA FILE

It is the time of removing the data file.

Parameter: None

WRITE: JOURNAL BUFFER

It is the time of writing journal buffers.

Parameter: None

READ: JOURNAL BUFFER

It is the time of reading journal buffers.

Parameter: None

WAIT TRANSACTION

It is the time of waiting for transactions.

Parameter	Description
wait transaction id	Transaction id for which to wait

WAIT OTHER TRANSACTION

It is the time of waiting for other transactions to be terminated.

Parameter	Description
wait transaction id	ID of the waiting transaction
target transaction id	ID of the transaction to be terminated

WAIT ENABLE LOGGING

It is the time of waiting until when the logging is available.

Parameter: None

WAIT LOG FLUSHER

It is the time of waiting for the log flusher.

Parameter	Description
send data size	Bytes of the data to be sent

WAIT PAGE FLUSHER

It is the time of waiting for the page flusher.

Parameter	Description
send data size	Bytes of the data to be sent

WAIT XA CONTEXT

It is the time of waiting for the XA context.

Parameter: None

LATCH: LOG BUFFER

It is the time of waiting for the log buffer latch.

Parameter	Description
address	The address of the latch for which the process is waiting
tries	A count of the number of times the process tried to get the latch

LATCH: PROCESS MANAGER

It is the time of waiting for the process manager latch.

Parameter	Description
address	The address of the latch for which the process is waiting
tries	A count of the number of times the process tried to get the latch

LATCH: ENV MGR

It is the time of waiting for the env manager latch.

Parameter	Description
address	The address of the latch for which the process is waiting
tries	A count of the number of times the process tried to get the latch

LATCH: SESSION ENV MGR

It is the time of waiting for the session env manager latch.

Parameter	Description
address	The address of the latch for which the process is waiting
tries	A count of the number of times the process tried to get the latch

LATCH: PCH

It is the time of waiting for the Page Control Header (PCH) latch.

Parameter	Description
address	The address of the latch for which the process is waiting
tries	A count of the number of times the process tried to get the latch

LATCH: PAGE

It is the time of waiting for the page latch.

Parameter	Description
address	The address of the latch for which the process is waiting
tries	A count of the number of times the process tried to get the latch

LATCH: PENDING LOG

It is the time of waiting for the pending log latch.

Parameter	Description
address	The address of the latch for which the process is waiting
tries	A count of the number of times the process tried to get the latch

LATCH: ALLOC TRANS

It is the time of waiting for the allocate transaction latch.

Parameter	Description
address	The address of the latch for which the process is waiting
tries	A count of the number of times the process tried to get the latch

LATCH: UNDO SEGMENT

It is the time of waiting for the undo segment latch.

Parameter	Description
address	The address of the latch for which the process is waiting
tries	A count of the number of times the process tried to get the latch

LATCH: CLUSTER LOCATION

It is the time of waiting for the cluster location latch.

Parameter	Description
address	The address of the latch for which the process is waiting
tries	A count of the number of times the process tried to get the latch

LATCH: DICT HASH ELEMENT AGING

It is the time of waiting for the dict hash element aging latch.

Parameter	Description
address	The address of the latch for which the process is waiting
tries	A count of the number of times the process tried to get the latch

LATCH: DICT HASH RELATED AGING

It is the time of waiting for the dict hash related aging latch.

Parameter	Description
address	The address of the latch for which the process is waiting
tries	A count of the number of times the process tried to get the latch

LATCH: FILE MANAGER

It is the time of waiting for the file manager latch.

Parameter	Description
address	The address of the latch for which the process is waiting
tries	A count of the number of times the process tried to get the latch

LATCH: TRACE LOG

It is the time of waiting for the trace log latch.

Parameter	Description
address	The address of the latch for which the process is waiting
tries	A count of the number of times the process tried to get the latch

LATCH: STATIC HASH

It is the time of waiting for the static hash latch.

Parameter	Description
address	The address of the latch for which the process is waiting
tries	A count of the number of times the process tried to get the latch

LATCH: STATIC HASH BUCKET

It is the time of waiting for the static hash bucket latch.

Parameter	Description
address	The address of the latch for which the process is waiting
tries	A count of the number of times the process tried to get the latch

LATCH: SQL HANDLE

It is the time of waiting for SQL handle latch.

Parameter	Description
address	The address of the latch for which the process is waiting
tries	A count of the number of times the process tried to get the latch

LATCH: XA CONTEXT HASH

It is the time of waiting for XA context hash latch.

Parameter	Description
address	The address of the latch for which the process is waiting
tries	A count of the number of times the process tried to get the latch

LATCH: PLAN CLOCK

It is the time of waiting for the plan clock latch.

Parameter	Description
address	The address of the latch for which the process is waiting
tries	A count of the number of times the process tried to get the latch

LATCH: XA CONTEXT

It is the time of waiting for XA context latch.

Parameter	Description
address	The address of the latch for which the process is waiting
tries	A count of the number of times the process tried to get the latch

LATCH: MEM CONTROLLER

It is the time of waiting for the memory controller latch.

Parameter	Description
address	The address of the latch for which the process is waiting
tries	A count of the number of times the process tried to get the latch

LATCH: DYNAMIC MEM

It is the time of waiting for the dynamic memory latch.

Parameter	Description
address	The address of the latch for which the process is waiting
tries	A count of the number of times the process tried to get the latch

LATCH: PROPERTY

It is the time of waiting for the property latch.

Parameter	Description
address	The address of the latch for which the process is waiting
tries	A count of the number of times the process tried to get the latch

LATCH: ATTACH SHM

It is the time of waiting for the attack shared memory latch.

Parameter	Description
address	The address of the latch for which the process is waiting
tries	A count of the number of times the process tried to get the latch

LATCH: BACKUP TBS

It is the time of waiting for the backup tablespace latch.

Parameter	Description
address	The address of the latch for which the process is waiting
tries	A count of the number of times the process tried to get the latch

LATCH: DATABASE COMPONENT

It is the time of waiting for the database component latch.

Parameter	Description
address	The address of the latch for which the process is waiting
tries	A count of the number of times the process tried to get the latch

LATCH: TABLESPACE

It is the time of waiting for the tablespace latch.

Parameter	Description
address	The address of the latch for which the process is waiting
tries	A count of the number of times the process tried to get the latch

LATCH: BACKUP DATABASE

It is the time of waiting for the backup database latch.

Parameter	Description
address	The address of the latch for which the process is waiting
tries	A count of the number of times the process tried to get the latch

LATCH: JOURNAL BUFFER

It is the time of waiting for the journal buffer latch.

Parameter	Description
address	The address of the latch for which the process is waiting
tries	A count of the number of times the process tried to get the latch

LATCH: JOURNAL BUFFER ENTRY

It is the time of waiting for the journal buffer entry latch.

Parameter	Description
address	The address of the latch for which the process is waiting
tries	A count of the number of times the process tried to get the latch

LATCH: JOURNAL WRITE BUFFER

It is the time of waiting for the journal write buffer latch.

Parameter	Description
address	The address of the latch for which the process is waiting
tries	A count of the number of times the process tried to get the latch

LATCH: LOCK ITEM

It is the time of waiting for the lock item latch.

Parameter	Description
address	The address of the latch for which the process is waiting
tries	A count of the number of times the process tried to get the latch

LATCH: RECORD HASH

It is the time of waiting for the record hash latch.

Parameter	Description
address	The address of the latch for which the process is waiting
tries	A count of the number of times the process tried to get the latch

LATCH: DEADLOCK

It is the time of waiting for the deadlock latch.

Parameter	Description
address	The address of the latch for which the process is waiting
tries	A count of the number of times the process tried to get the latch

LATCH: SEQUENCE

It is the time of waiting for the sequence latch.

Parameter	Description
address	The address of the latch for which the process is waiting
tries	A count of the number of times the process tried to get the latch

LATCH: LOG STREAM

It is the time of waiting for the log stream latch.

Parameter	Description
address	The address of the latch for which the process is waiting
tries	A count of the number of times the process tried to get the latch

LATCH: BUILD AGABLE SCN

It is the time of waiting for the build agable SCN latch.

Parameter	Description
address	The address of the latch for which the process is waiting
tries	A count of the number of times the process tried to get the latch

LATCH: TRANSACTION TABLE

It is the time of waiting for the transaction table latch.

Parameter	Description
address	The address of the latch for which the process is waiting
tries	A count of the number of times the process tried to get the latch

LATCH: SESSION LINK HASH

It is the time of waiting for the session link hash latch.

Parameter	Description
address	The address of the latch for which the process is waiting
tries	A count of the number of times the process tried to get the latch

LATCH: ALLOC XA CONTEXT

It is the time of waiting for the allocate XA context latch.

Parameter	Description
address	The address of the latch for which the process is waiting
tries	A count of the number of times the process tried to get the latch

LATCH: SEQUENCE GLOBALX

It is the time of waiting for the sequence global latch X.

Parameter	Description
address	The address of the latch for which the process is waiting
tries	A count of the number of times the process tried to get the latch

LATCH: SEQUENCE GLOBALY

It is the time of waiting for the sequence global latch Y.

Parameter	Description
address	The address of the latch for which the process is waiting
tries	A count of the number of times the process tried to get the latch

LATCH: TRANSACTION LOG FILE

It is the time of waiting for the transaction logfile latch.

Parameter	Description
address	The address of the latch for which the process is waiting
tries	A count of the number of times the process tried to get the latch

Appendix C.

Open Source License

Apache License, Version 2.0

Apache License

Version 2.0, January 2004

<http://www.apache.org/licenses/>

TERMS AND CONDITIONS FOR USE, REPRODUCTION, AND DISTRIBUTION

1. Definitions.

"License" shall mean the terms and conditions for use, reproduction, and distribution as defined by Sections 1 through 9 of this document.

"Licensor" shall mean the copyright owner or entity authorized by the copyright owner that is granting the License.

"Legal Entity" shall mean the union of the acting entity and all other entities that control, are controlled by, or are under common control with that entity. For the purposes of this definition, "control" means (i) the power, direct or indirect, to cause the direction or management of such entity, whether by contract or otherwise, or (ii) ownership of fifty percent (50%) or more of the outstanding shares, or (iii) beneficial ownership of such entity.

"You" (or "Your") shall mean an individual or Legal Entity exercising permissions granted by this License.

"Source" form shall mean the preferred form for making modifications, including but not limited to software source code, documentation source, and configuration files.

"Object" form shall mean any form resulting from mechanical transformation or translation of a Source form, including but not limited to compiled object code, generated documentation, and conversions to other media types.

"Work" shall mean the work of authorship, whether in Source or Object form, made available under the License, as indicated by a copyright notice that is included in or attached to the work (an example is provided in the Appendix below).

"Derivative Works" shall mean any work, whether in Source or Object form, that is based on (or derived from) the Work and for which the editorial revisions, annotations, elaborations, or other modifications represent, as a whole, an original work of authorship. For the purposes of this License, Derivative Works shall not include works that remain separable from, or merely link (or bind by name) to the interfaces of, the Work and Derivative Works thereof.

"Contribution" shall mean any work of authorship, including the original version of the Work and any modifications or additions to that Work or Derivative Works thereof, that is intentionally submitted to Licensor or for inclusion in the Work by the copyright owner or by an individual or Legal Entity authorized to submit on behalf of the copyright owner. For the purposes of this definition, "submitted" means any form of electronic, verbal, or written communication sent to the Licensor or its representatives, including but not li

mitted to communication on electronic mailing lists, source code control systems, and issue tracking systems that are managed by, or on behalf of, the Licensor for the purpose of discussing and improving the Work, but excluding communication that is conspicuously marked or otherwise designated in writing by the copyright owner as "Not a Contribution."

"Contributor" shall mean Licensor and any individual or Legal Entity on behalf of whom a Contribution has been received by Licensor and subsequently incorporated within the Work.

2. Grant of Copyright License.

Subject to the terms and conditions of this License, each Contributor hereby grants to You a perpetual, worldwide, non-exclusive, no-charge, royalty-free, irrevocable copyright license to reproduce, prepare Derivative Works of, publicly display, publicly perform, sublicense, and distribute the Work and such Derivative Works in Source or Object form.

3. Grant of Patent License.

Subject to the terms and conditions of this License, each Contributor hereby grants to You a perpetual, worldwide, non-exclusive, no-charge, royalty-free, irrevocable (except as stated in this section) patent license to make, have made, use, offer to sell, sell, import, and otherwise transfer the Work, where such license applies only to those patent claims licensable by such Contributor that are necessarily infringed by their Contribution(s) alone or by combination of their Contribution(s) with the Work to which such Contribution(s) was submitted. If You institute patent litigation against any entity (including a cross-claim or counter claim in a lawsuit) alleging that the Work or a Contribution incorporated within the Work constitutes direct or contributory patent infringement, then any patent licenses granted to You under this License for that Work shall terminate as of the date such litigation is filed.

4. Redistribution.

You may reproduce and distribute copies of the Work or Derivative Works thereof in any medium, with or without modifications, and in Source or Object form, provided that You meet the following conditions:

1. You must give any other recipients of the Work or Derivative Works a copy of this License; and
2. You must cause any modified files to carry prominent notices stating that You changed the files; and
3. You must retain, in the Source form of any Derivative Works that You distribute, all copyright, patent, trademark, and attribution notices from the Source form of the Work, excluding those notices that do not pertain to any part of the Derivative Works; and
4. If the Work includes a "NOTICE" text file as part of its distribution, then any Derivative Works that You distribute must include a readable copy of the attribution notices contained within such NOTICE file, excluding those notices that do not pertain to any part of the Derivative Works, in at least one of the following places: within a NOTICE text file distributed as part of the Derivative Works; within the Source form or documentation, if provided along with the Derivative Works; or, within a display gen

erated by the Derivative Works, if and wherever such third-party notices normally appear. The contents of the NOTICE file are for informational purposes only and do not modify the License. You may add Your own attribution notices within Derivative Works that You distribute, alongside or as an addendum to the NOTICE text from the Work, provided that such additional attribution notices cannot be construed as modifying the License.

You may add Your own copyright statement to Your modifications and may provide additional or different license terms and conditions for use, reproduction, or distribution of Your modifications, or for any such Derivative Works as a whole, provided Your use, reproduction, and distribution of the Work otherwise complies with the conditions stated in this License.

5. Submission of Contributions.

Unless You explicitly state otherwise, any Contribution intentionally submitted for inclusion in the Work by You to the Licensor shall be under the terms and conditions of this License, without any additional terms or conditions. Notwithstanding the above, nothing herein shall supersede or modify the terms of any separate license agreement you may have executed with Licensor regarding such Contributions.

6. Trademarks.

This License does not grant permission to use the trade names, trademarks, service marks, or product names of the Licensor, except as required for reasonable and customary use in describing the origin of the Work and reproducing the content of the NOTICE file.

7. Disclaimer of Warranty.

Unless required by applicable law or agreed to in writing, Licensor provides the Work (and each Contributor or provides its Contributions) on an "AS IS" BASIS, WITHOUT WARRANTIES OR CONDITIONS OF ANY KIND, either express or implied, including, without limitation, any warranties or conditions of TITLE, NON-INFRINGEMENT, MERCHANTABILITY, or FITNESS FOR A PARTICULAR PURPOSE. You are solely responsible for determining the appropriateness of using or redistributing the Work and assume any risks associated with Your exercise of permissions under this License.

8. Limitation of Liability.

In no event and under no legal theory, whether in tort (including negligence), contract, or otherwise, unless required by applicable law (such as deliberate and grossly negligent acts) or agreed to in writing, shall any Contributor be liable to You for damages, including any direct, indirect, special, incidental, or consequential damages of any character arising as a result of this License or out of the use or inability to use the Work (including but not limited to damages for loss of goodwill, work stoppage, computer failure or malfunction, or any and all other commercial damages or losses), even if such Contributor has been advised of the possibility of such damages.

9. Accepting Warranty or Additional Liability.

While redistributing the Work or Derivative Works thereof, You may choose to offer, and charge a fee for, acceptance of support, warranty, indemnity, or other liability obligations and/or rights consistent with this License. However, in accepting such obligations, You may act only on Your own behalf and on Your sole responsibility, not on behalf of any other Contributor, and only if You agree to indemnify, defend, and hold each Contributor harmless for any liability incurred by, or claims asserted against, such Contributor by reason of your accepting any such warranty or additional liability.

Copyright 2019-2022 SUNJESoft Inc.

Licensed under the Apache License, Version 2.0 (the "License");

you may not use this file except in compliance with the License. You may obtain a copy of the License at <http://www.apache.org/licenses/LICENSE-2.0>

Unless required by applicable law or agreed to in writing, software distributed under the License is distributed on an "AS IS" BASIS, WITHOUT WARRANTIES OR CONDITIONS OF ANY KIND, either express or implied. See the License for the specific language governing permissions and limitations under the License.

